Installation Guide

HP Debug User Interface

Notice

Hewlett-Packard makes no warranty of any kind with regard to this material, including, but not limited to, the implied warranties of merchantability and fitness for a particular purpose. Hewlett-Packard shall not be liable for errors contained herein or for incidental or consequential damages in connection with the furnishing, performance, or use of this material.

Hewlett-Packard assumes no responsibility for the use or reliability of its software on equipment that is not furnished by Hewlett-Packard.

© Copyright 1996, Hewlett-Packard Company.

This document contains proprietary information, which is protected by copyright. All rights are reserved. No part of this document may be photocopied, reproduced, or translated to another language without the prior written consent of Hewlett-Packard Company. The information contained in this document is subject to change without notice.

MS-DOS is a U.S. registered trademark of Microsoft Corp.

UNIX is a registered trademark in the United States and other countries, licensed exclusively through X/Open Company Limited.

Windows and MS Windows are U.S. registered trademarks of Microsoft Corp.

Hewlett-Packard
P.O. Box 2197
1900 Garden of the Gods Road
Colorado Springs, CO 80901-2197, U.S.A.

RESTRICTED RIGHTS LEGEND Use, duplication, or disclosure by the U.S. Government is subject to restrictions as set forth in subparagraph (c) (1)(ii) of the Rights in Technical Data and Computer Software Clause at DFARS 252.227-7013. Hewlett-Packard Company, 3000 Hanover Street, Palo Alto, CA 94304 U.S.A. Rights for non-DOD U.S. Government departments and agencies are as set forth in FAR 52.227-19(c)(1,2).

Printing History

New editions are complete revisions of the manual. The date on the title page changes only when a new edition is published.

A software code may be printed before the date; this indicates the version level of the software product at the time the manual was issued. Many product updates and fixes do not require manual changes, and manual corrections may be done without accompanying product changes. Therefore, do not expect a one-to-one correspondence between product updates and manual revisions.

Edition 1 B3750-97001, June 1996

Certification and Warranty

Certification and warranty information can be found at the end of this manual on the pages before the back cover.

Contents

1 Introduction

Installation Overview	9
Platform Requirements	10
Requirements for Windows 95	10
Requirements for HP-UX	10
Requirements for SunOS	11
Requirements for Solaris	11
Before Installing the Debugger	12
For Windows 95	12
For HP-UX	12

2 Connecting the Emulator via LAN

Connecting the Emulator via LAN	14
Setting up the Emulator	15
If you cannot verify RS-232 communication	21
If you cannot verify LAN communication	22

3 Installing the Debugger Software

Installation on the Windows 95 PC	25
Installation on the HP 9000/700 Workstation	28
Installation for HP-UX version 9.x	28
Installation for HP-UX version 10.x	30
Installation on Other Workstations	31
Installation for SunOS	31
Installation for Solaris	33

Contents

1

Introduction

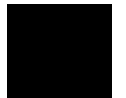

Introduction

This book describes how to install the Debug User Interface:

- Installation overview.
- Platform requirements.
- Before installing the debugger.
- Setting up the emulator.
- Installing the debugger software.
- Verifying installation.

Installation Overview

The installation procedure consists of the following steps:

- Preparing for installation.
Check that your computer meets the requirements for using the Debug User Interface. See "Platform Requirements" for details.

Then, set up the environment for using the Debug User Interface. See "Before Installing the Debugger" for details.

- Setting up the emulator.
If you are using the emulator for the first time, you must first set network parameters for connection to the LAN, then connect the emulator and the PC via an RS-232 serial port. If the emulator is already on the LAN, you may skip this step.
- Installing the Debug User Interface software.
- Verifying installation.

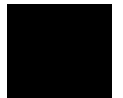

Platform Requirements

Requirements for Windows 95

- IBM-PC compatible with a 33-MHz or faster 486 microprocessor (Pentium processors recommended).
 - 16 MB of memory (over 32 MB recommended).
 - 10 MB of available disk space.
 - Windows 95.
 - LAN card supported by Windows 95 (supporting NDIS 3.0).
 - Display with VGA or higher resolution.
-

Requirements for HP-UX

- HP-UX version 9.0 or greater.
- 32 MB of memory (over 64 MB recommended).
- 20 MB of available disk space.
- X11R5 X window system.

Requirements for SunOS

- SunOS version 4.14 or greater.
- OpenWindows version 3.0 or greater.
- 32 MB of memory (over 64 MB recommended).
- 20 MB of available disk space.

Requirements for Solaris

- Solaris version 2.3 or greater.
- OpenWindows version 3.0 or greater.
- 32 MB of memory (over 64 MB recommended).
- 20 MB of available disk space.

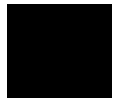

Before Installing the Debugger

For Windows 95

- Install Windows 95 according to its installation documentation.
 - Connect the emulator to the PC via LAN:
- 1** Install the LAN card supporting NDIS 3.0 in the PC.
 - 2** Choose the Control Panel in the Windows 95 My Computer group and double-click the Network icon to open the Network dialog box.
 - 3** Configure the network using Configuration in the Network dialog box.

See your Windows 95 documentation for details.

For HP-UX

- Check the version number of your HP-UX.
Installation procedures differ depending on your version of HP-UX.
Check your version by executing the following command:

```
$ uname -a
```

2

Connecting the Emulator via LAN

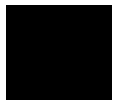

Connecting the Emulator via LAN

You must connect the emulator used for the Debug User Interface via a LAN. This chapter describes how to set network parameters for the emulator through Windows 95.

Note

If you want to set the HP 64700's network parameters using your workstation, see the *HP 64700B Card Cage Installation Service Guide*.

Setting Up the Emulator

If you are using the emulator for the first time, you must set network parameters for connection to the LAN; this section describes how to set these parameters through Windows 95. Then you must connect the emulator and the PC via an RS-232 serial port. If the emulator is already on the LAN, you may skip this step.

1 Set the HP 64700 configuration switches for RS-232C communication.

Locate the DIP switches on the HP 64700 rear panel, and set them as shown below.

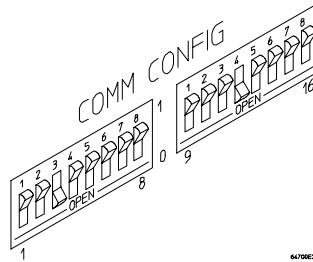

Note that switches 1 through 3 are set to 001, respectively. This sets the baud rate to 19200.

Note also that switches 12 and 13 are set to 1 and 0, respectively. This sets the RTS/CTS hardware handshake needed to verify that all characters are processed.

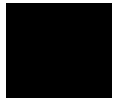

Chapter 2: Connecting the Emulator via LAN
Setting Up the Emulator

- 2 Connect the PC to the HP 64700 using the HP 24542M RS-232C modem cable.

The following figure shows the pin-outs of the HP 24542M modem cable:

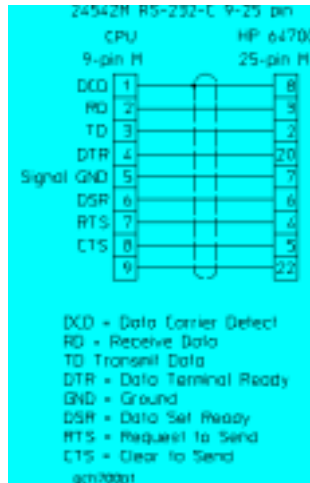

- 3 Turn on power to the HP 64700.

The power switch is located on the lower left-hand corner of the front panel. The power light on the lower right-hand corner of the front panel will be on.

- 4 Start Windows 95.
- 5 Verify RS-232 communication by using the Hyper Terminal program, found in the Windows 95 Accessories group.

Double-click on the Hyper Terminal icon to open the Hyper Terminal window. First, the Connection Description dialog box appears. Enter any string you want in the Name: text box and click the OK button. Next, the Phone Number dialog box appears. Click the button located to the right of the Connection using: field and select the com port for the RS-232 interface connector. Clicking the OK button displays the dialog box to set properties for the selected com port. Specify the items in the dialog box as follows:

Bits per second: 19200
Data bits: 8
Parity: None
Stop bits: 1
Flow control: Hardware

Choose the OK button.

You should now be able to press the Return key in the Hyper Terminal window to see the HP 64700's Terminal Interface prompt (such as R>, M>, or U>). If you see the prompt, you have verified RS-232 communication. If you do not see the prompt, refer to "If you cannot verify RS-232 communication."

6 Set the HP 64700 network parameters.

Display the current network parameters by entering the "lan" command:

```
R>lan  
lan -i 15.6.25.117  
lan -g 15.6.24.1  
lan -s 255.255.248.0  
lan -p 6470  
Ethernet Address : 08000909BBC1
```

The "lan -i" line shows the IP address, which must be obtained from your network administrator. The value is entered in integer dot notation, for example, 192.35.12.6. You can change the IP address with the "lan -i <new IP>" command.

The "lan -g" line shows the gateway address, which is also an IP address and is entered in integer dot notation. This entry is optional and the default value is 0.0.0.0, meaning all connections are to be made on the local network or subnet. If connections are to be made to workstations on other networks or subnets, this entry must be set to the address of the gateway machine, which must be obtained from your network administrator. You can change the gateway address with the "lan -g <new gateway address>" command.

The "lan -s" line shows the subnet mask in integer dot notation. This entry is optional and the default value is 0.0.0.0. The default is valid only on networks that are not subnetted. (A network is subnetted if the host portion

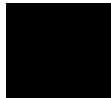

Chapter 2: Connecting the Emulator via LAN

Setting Up the Emulator

of the IP address is further partitioned into a subnet portion and a host portion.) If the network is subnetted, a subnet mask is required for the emulator to work correctly. The subnet mask should be set to all "1"s in the bits that correspond to the network and subnet portions of the IP address, and all "0"s for the host portion. The subnet mask must be obtained from your network administrator. You can change the subnet mask with the "lan -s <new subnet mask>" command.

This setting is required only when you use the HP 64700A.

Note

If you use the HP 64700B, no subnet mask value is displayed. It is automatically set to the network subnet mask value.

The "lan -p" line shows the base TCP service port number. The host computer interfaces communicate with the HP 64700 through two TCP service ports. The default base port number is 6470. The second port has the next higher number (default 6471). If the service port is not 6470, you must change it with the "lan -p 6470" command.

The IP address and any other network parameters you change are stored in nonvolatile memory and will take effect the next time the HP 64700 is switched off and then back on.

- 7 Exit the Terminal program.**
- 8 Turn off power to the HP 64700.**
- 9 Connect the HP 64700 to the LAN.**

This connection can be made using either the 15-pin AUI connector or the BNC connector. DO NOT use both connectors. The LAN interface will not work with both connected at the same time.

10 Set the HP 64700 configuration switches for LAN communication.

Switch 16 must be set to 1, indicating that a LAN connection is being made. Switch 15 should be set to 0 if you are connecting to the BNC connector, or to 1 if you are using a 15-pin AUI connection.

Switch 14 should be 0.

Set all other switches to 0.

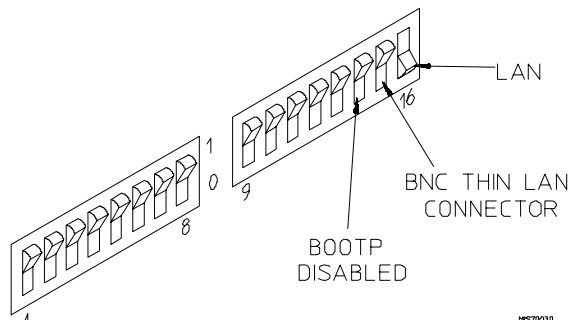

Settings for Connection via BNC

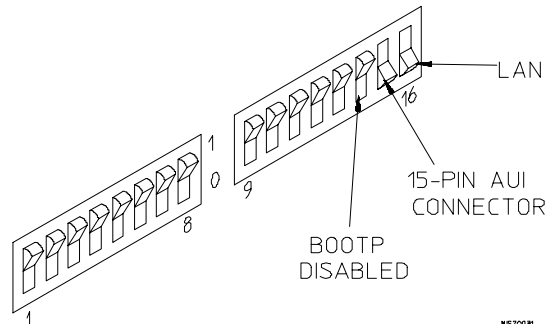

Settings for Connection via AUI

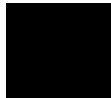

11 Turn on power to the HP 64700.

12 Verify LAN communication by using a telnet application.

This connection will give you access to the HP 64700 Terminal Interface. When the communication is successfully made, the HP 64700's Terminal Interface prompt (such as R>, M>, or U>) appears. If you see the prompt, you have verified LAN communication. If you cannot connect to the HP 64700, see "If you cannot verify LAN communication."

Note

To use telnet commands, you must install the TCP/IP protocol in Windows 95. See the Windows 95 documentation for details.

If you cannot verify RS-232 communication

If the HP 64700 Terminal Interface prompt does not appear in the Hyper Terminal window:

- Make sure that you have connected the emulator to the proper power source and that the power light is on.

- Make sure that you have connected the emulator to the proper RS-232 modem cable.

- Make sure that you have properly configured the data communications switches on the emulator and the data communications parameters on your controlling device. You should also verify that you are using the correct cable.

The most common data communications configuration problems are mis-configuration of the HP 64700 and selection of the wrong RS-232 modem cable. If you are using the wrong cable, no prompt will be displayed. Make sure that you use the right cable (HP 24542M) and set the DIP switch correctly.

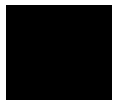

If you cannot verify LAN communication

Use the "telnet" command on the host computer to verify LAN communication. After you switch on the HP 64700, it takes a minute for the HP 64700 to be recognized on the network. After a minute, try the telnet application from the host computer.

If "telnet" does not make the connection:

- Make sure that you have connected the emulator to the proper power source and that the power light is on.

- Make sure that the LAN cable is connected. Refer to your LAN documentation for details on how to test connectivity.

- Make sure that the HP 64700 rear-panel communications configuration switches are set correctly. Switch settings are used to set communications parameters in the HP 64700 only when power is turned off and then on.

- Make sure that the HP 64700's IP address is set correctly. You must verify this setting using the RS-232 port. While accessing the emulator via the RS-232 port, run performance verification on the HP 64700's LAN interface with the "lanpv" command.

If "telnet" makes the connection but no Terminal Interface prompt (such as R>, M>, or U>) appears:

- The HP 64700 software may be running a command (for example, a repetitive command initiated from "telnet" in another window). Press CTRL+c to interrupt the repetitive command and get the Terminal Interface prompt.

- You may have a problem with the HP 64700 firmware while the LAN interface is still up and running. In this case, you must turn off power to the HP 64700 and turn it on again.

3

Installing the Debugger Software



Installing the Debugger Software

This chapter shows you how to install the debugger software:

- Installation on the Windows 95 PC.
- Installation on the HP 9000/700 workstation.
- Installation on other workstations.

Installation on the Windows 95 PC

This section describes how to install the Debug User Interface on the IBM-PC compatible running under Microsoft Windows 95.

- 1 Start Windows 95.
- 2 Insert the first disk into a floppy disk drive.
- 3 Choose the Run... (ALT, S, R) command in the Windows 95 Start menu. Enter "a:\setup" in the text box.

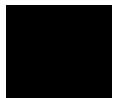
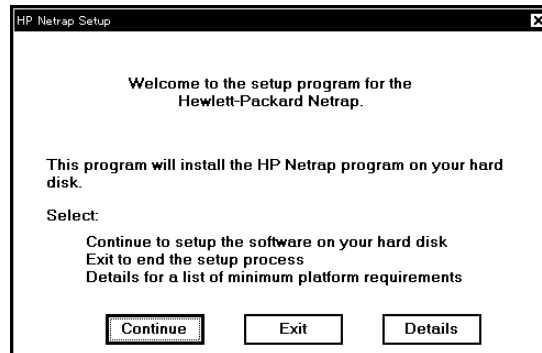

Chapter 3: Installing the Debugger Software
Installation on the Windows 95 PC

- 4 Click the Continue button to continue the installation and follow the instructions on your screen. If you decide to cancel the installation, press the Exit button.

Clicking the Details button shows the minimum platform requirements for the Debug User Interface.

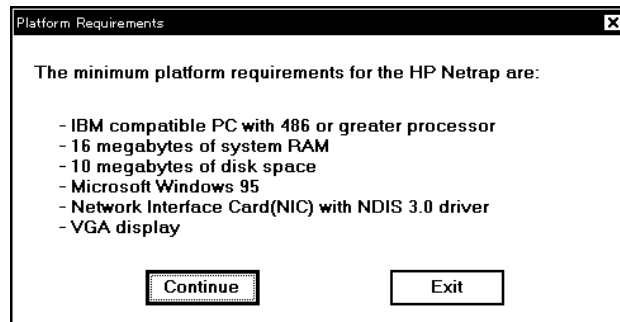

Click the Continue button to return to the previous screen and continue the installation. If you decide to cancel the installation, click the Exit button.

A dialog box prompting you to enter the installation path appears. The default installation path is C:\hpnttr\b37xxa. This path is shown wherever files are discussed in this manual.

Enter the installation path and click the Continue button. Files will be copied to your hard disk.

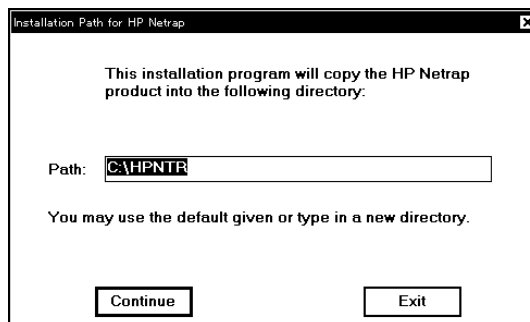

Chapter 3: Installing the Debugger Software Installation on the Windows 95 PC

Insert the remaining floppy disks, following the instructions on your screen.

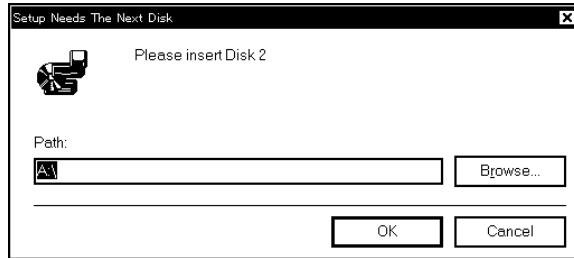

Enter the LAN address for the emulator you will use with the software. Setting this address enables you to connect the debugger to the emulator as soon as you start the software.

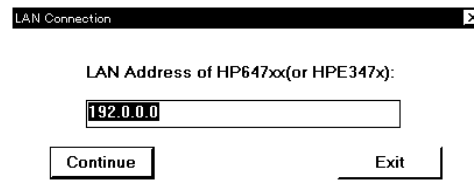

When the installation has been completed successfully, the following dialog box appears. Click the View README button to view the README file.

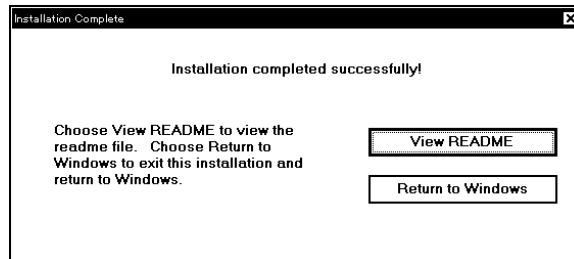

- 5 Choose the HP DEBUG from the Windows 95 Start menu to verify the installation.

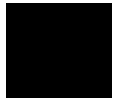

Installation on the HP 9000/700 Workstation

This section describes how to install the debugger software on the HP 9000 Series 700 computer running under the HP-UX operating system.

- Installation for HP-UX version 9.x.
 - Installation for HP-UX version 10.x.
-

Installation for HP-UX version 9.x

This section describes how to install the debugger software on the HP 9000 Series 700 computer running under the HP-UX operating system version 9.x. See the information on updating in your HP-UX documentation for detailed software installation procedures.

- 1** Log in to the system you want to install as root.
- 2** Make sure the tape's write-protect tab is set to **SAFE**.
- 3** Put the tape into the tape drive that will be the *source device* for the install process.
- 4** Start the update program by entering the following command at the HP-UX prompt:

```
/etc/update
```

- 5** When the HP-UX update utility main screen appears, confirm that the source and destination devices are correct for your system.

Refer to the information on updating in your HP-UX documentation if you need to modify these values.

- 6 Choose "Select All Filesets on the Source Media" when your source and destination directories are correct.
- 7 To begin the update, choose <Select Item>. At the next menu, choose <Select Item> again. Answer the last prompt with *yes*:

y

It takes several minutes to read the tape.
- 8 When the installation is complete, read /tmp/update.log to see the results of the update.
- 9 Add "/usr/hpntx/hp700_9/bin" to your PATH environment variable.

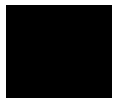

Installation for HP-UX version 10.x

- 1 Log in to the system you want to install as root.
- 2 Make sure the tape's write-protect tab is set to SAFE.
- 3 Put the tape into the tape drive that will be the *source device* for the update process.
- 4 Start the installation from the tape drive by entering the following command at the HP-UX prompt:

```
cd /  
tar xvf <device>
```

<device> is the name of your tape device.

- 5 Add "/usr/hpnr/hp700_9/bin" to your PATH environment variable.

Installation on Other Workstations

This section describes how to install the debugger software on your workstation running under one of the following operating systems:

- Installation for SunOS.
- Installation for Solaris.

Installation for SunOS

- 1 Log in as root.
- 2 Make sure the tape's write-protect tab is set to SAFE.
- 3 Put the tape into the tape drive that will be the *source device* for the install process.
- 4 If the tape drive is on your local system, enter the following commands:

```
umask 0
cd /
tar xvfbp <device> 20
```

If you are installing the software from a tape drive on a remote system, enter the following commands:

```
cd /
rsh -n W0I<hostname>"dd if=W0I<device> bs=20b" |
tar xvfbp - 20
```

<device> is the name of your tape device. <hostname> is the name of the system with the tape drive.

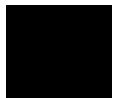

5 Run the configure script.

To run the configure script, you must change to the `/usr/hpnr/sunos_4` directory:

```
cd /usr/hpnr/sunos_4
./configure
```

The stand-alone configure script should be run on the workstation where you originally installed the Debug User Interface, and again on each workstation that NFS mounts the `/usr/hpnr` install tree (and that has a local file system). The configure script may be run as root at any time to verify that all files required by the Debug User Interface are linked to the correct locations on the local file system.

The configure script installs the XKeysymDB file if the required OSF keymappings do not exist in `$OPENWINHOME/lib/XKeysymDB`.

`$OPENWINHOME` is `/usr/openwin` by default.

Example

Assume the software product was installed on the file server *snow_white* in the directory `/home/snow_white`.

Seven workstations want to share *snow_white*'s software install directory. To share this directory, you must complete the following steps for each dwarf workstation:

- Log in to the dwarf's system as root.
- Mount *snow_white*'s software install directory:

```
mount snow_white:/home/snow_white/usr/hpnr /usr/hpnr
```
- Change directories to `/usr/hpnr/sunos_4`, and run the configure script to link the necessary software files onto your local file system.

The configure script is verbose and will tell you which files failed to link. Follow the instructions given by the configure script, and keep re-running it until it succeeds.

```
cd /usr/hpnr/sunos_4
./configure
```

6 Set the PATH environment variable.

Set the PATH environment variable to include the /usr/hpnttr/sunos_4/bin directory.

Installation for Solaris

1 Log in as root.

2 Make sure the tape's write-protect tab is set to SAFE.

3 Put the tape into the tape drive that will be the *source device* for the update process.

4 If the tape drive is on your local system, enter the following commands:

```
cd /
umask 0
tar xvfbp <device> 20
```

If you are installing the software from a tape drive on a remote system, enter the following commands:

```
cd /
rsh -n <hostname>"dd if=<device> bs=20b" |
tar xvfbp - 20
```

<device> is the name of your tape device. <hostname> is the name of the system with the tape drive.

5 Run the configure script.

To run the configure script, you must change to the /opt/hpnttr/solar_2 directory:

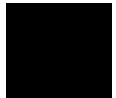

```
cd /opt/hpntr/solar_2
./configure
```

- 6** For the environmental variable HOME, specify the directory where your Motif package software resides.

Example

Set the environmental variable \$MOTIFHOME as follows:

```
setenv MOTIFHOME /opt/SUNWmotif
      (SunSoft OSF/Motif 1.2.2)
setenv MOTIFHOME /usr/dt
      (SunSoft OSF/Motif 1.2.3)
setenv MOTIFHOME /Motif1.2.2/usr
      (IXI Motif 1.2.2)
```

The stand-alone configure script should be run on the workstation where you originally installed the Debug User Interface, and again on each workstation that NFS mounts the /opt/hpntr install tree (and that has a local file system). The configure script may be run as root at any time to verify that all files required by the software are linked to the correct locations on the local file system.

The configure script checks for the existence of the SunSoft OSF/Motif 1.2.2 or greater, or the IXI Motif 1.2.2 or greater, under \$MOTIFHOME. If \$MOTIFHOME has not been defined, the script looks under /opt/SUNWmotif (for Motif 1.2.2) or /usr/dt (for Motif 1.2.3).

For SunSoft OSF/Motif 1.2.3 only, the configure script creates symbolic links between versions 2 and 3 of the Motif shared libraries.

Example

Assume the software product was installed on the file server *snow_white* in the directory */home/snow_white*.

Seven workstations want to share *snow_white*'s software install directory. To share this directory, you must complete the following steps for each dwarf workstation:

- Log in to the dwarf's system as root.
- Mount *snow_white*'s software install directory:

```
mount snow_white:/home/snow_white/opt/hpntr /opt/hpntr
```

- Change directories to */opt/hpntr/solar_2*, and run the configure script to link the necessary software files onto your local file system.

The configure script is verbose and will tell you which files failed to link. Follow the instructions given by the configure script, and keep re-running it until it succeeds.

```
cd /opt/hpntr/solar_2  
./configure
```

7 Set the PATH environment variable.

Set the PATH environment variable to include the */opt/hpntr/solar_2/bin* directory.

Set the *\$MOTIFHOME* environment variable. See the above step describing how to run the configure script.

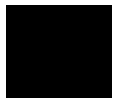

Chapter 3: Installing the Debugger Software
Installation on Other Workstations

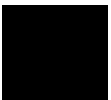

Index

- D** debugger, installing software, 24
- E** ethernet address, 15-22
- G** gateway address, 15-22
- H** hardware requirements, 10-11
 - HP 64700, connecting via LAN, 15-22
 - HP 64700, connecting via RS-232, 15-22
- I** Installation overview, 9
 - installation path, 24
 - internet address, 15-22
- L** LAN cards, 12
 - LAN, connecting HP 64700, 15-22
 - link level address, 15-22
- P** PATH environment variable, 29-30
- R** requirements, platform, 10-11
 - RS-232 cable, 21
 - RS-232, connecting the HP 64700, 15-22
- S** service ports, TCP, 15-22
 - software, installing the debugger, 24
 - subnet mask, 15-22
 - system setup, 12
- T** TCP service ports, 15-22
 - telnet, 15-22
- U** user ID, 24

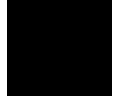

Index



Certification and Warranty

Certification

Hewlett-Packard Company certifies that this product met its published specifications at the time of shipment from the factory. Hewlett-Packard further certifies that its calibration measurements are traceable to the United States National Bureau of Standards, to the extent allowed by the Bureau's calibration facility, and to the calibration facilities of other International Standards Organization members.

Warranty

This Hewlett-Packard system product is warranted against defects in materials and workmanship for a period of 90 days from date of installation. During the warranty period, HP will, at its option, either repair or replace products which prove to be defective.

Warranty service of this product will be performed at Buyer's facility at no charge within HP service travel areas. Outside HP service travel areas, warranty service will be performed at Buyer's facility only upon HP's prior agreement and Buyer shall pay HP's round-trip travel expenses. In all other cases, products must be returned to a service facility designated by HP.

For products returned to HP for warranty service, Buyer shall prepay shipping charges to HP and HP shall pay shipping charges to return the product to Buyer. However, Buyer shall pay all shipping charges, duties, and taxes for products returned to HP from another country. HP warrants that its software and firmware designated by HP for use with an instrument will execute its programming instructions when properly installed on that instrument. HP does not warrant that the operation of the instrument, or software, or firmware will be uninterrupted or error free.

Limitation of Warranty

The foregoing warranty shall not apply to defects resulting from improper or inadequate maintenance by Buyer, Buyer-supplied software or interfacing, unauthorized modification or misuse, operation outside of the environment specifications for the product, or improper site preparation or maintenance.

No other warranty is expressed or implied. HP specifically disclaims the implied warranties of merchantability and fitness for a particular purpose.

Exclusive Remedies

The remedies provided herein are buyer's sole and exclusive remedies. HP shall not be liable for any direct, indirect, special, incidental, or consequential damages, whether based on contract, tort, or any other legal theory.

Product maintenance agreements and other customer assistance agreements are available for Hewlett-Packard products.

For any assistance, contact your nearest Hewlett-Packard Sales and Service Office.