

VERSATEC  
VERSATEC  
VERSATEC  
VERSATEC  
VERSATEC  
VERSATEC  
VERSATEC



**C2700 Series  
Thermal Transfer  
Color Plotter  
Operator Guide**

**Publication No. 5990-01**

VERSATEC  
VERSATEC  
VERSATEC  
VERSATEC  
VERSATEC  
VERSATEC  
VERSATEC  
VERSATEC

A XEROX COMPANY



**C2700 Series  
Thermal Transfer  
Color Plotter  
Operator Guide**

**Publication No. 5990-01**

**October 1986**

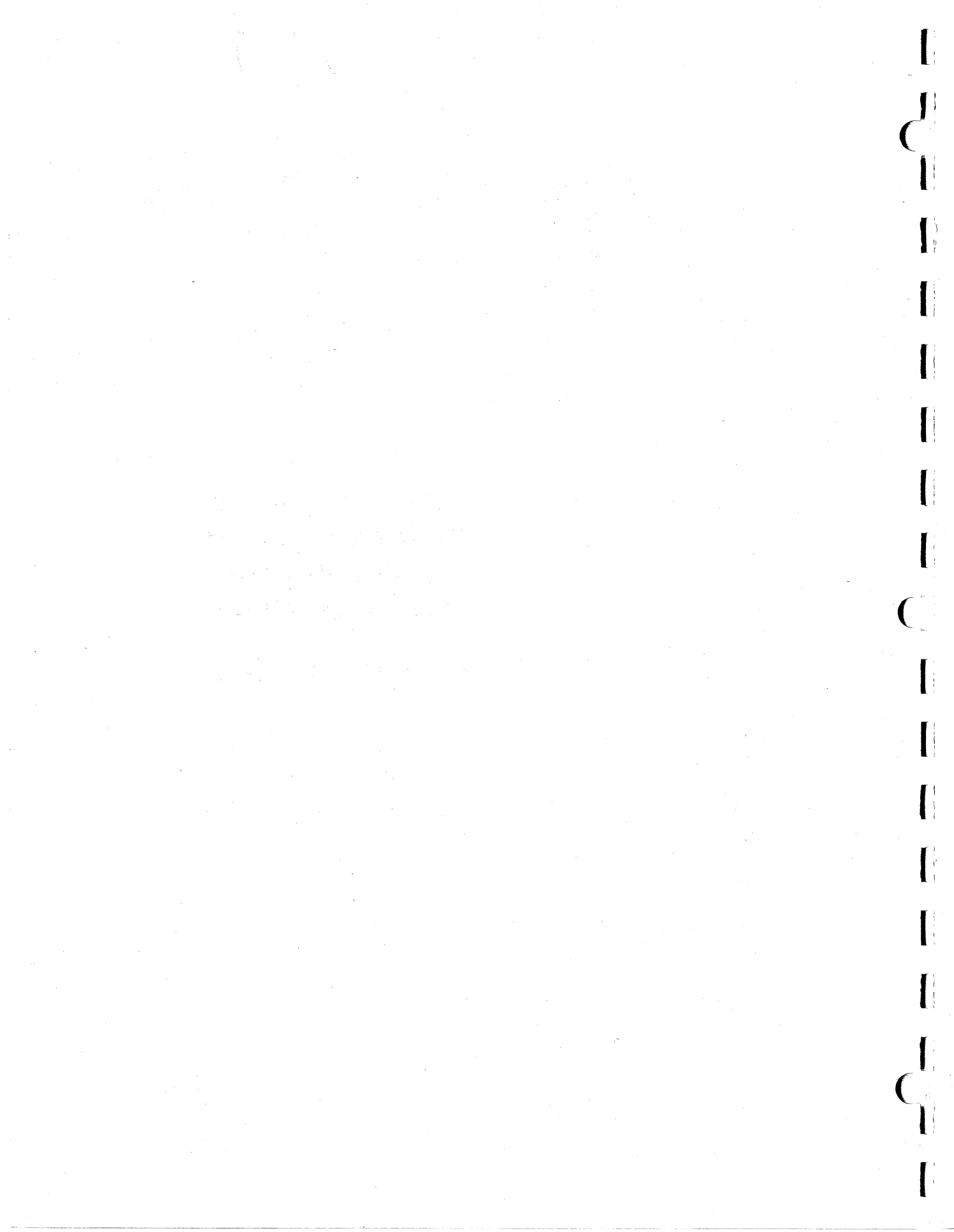

Publication No. 5990

Edition: 01

October 1986

### NOTICE

Versatec reserves the right to make changes without notice to information contained in this document. Versatec assumes no responsibility for any errors or consequential damages that may result from use or misinterpretation of any information contained herein.

No part of this manual may be copied or reproduced without prior written permission of Versatec, Inc.



2710 Walsh Avenue, Santa Clara, CA. 95051

Phone: (408) 988-2800

Copyright © 1986 All Rights Reserved



**WARNING** (*USA only*)

This equipment generates, uses, and can radiate radio frequency energy and if not installed and used in accordance with the instruction manual, may cause interference to radio communications. It has been tested and found to comply with the limits for a CLASS A computing device pursuant to Docket 20780, SUBPART J of Part 15 of FCC Rules, which are designed to provide reasonable protection against such interference when operated in a commercial environment. Operation of this equipment in a residential area is likely to cause interference in which case the user at his own expense will be required to take whatever measures may be required to correct the interference.

1  
2  
3  
4  
5  
6  
7  
8  
9  
10  
11  
12  
13  
14  
15  
16  
17  
18  
19  
20  
21  
22  
23  
24  
25

# PREFACE

This guide provides the information necessary to operate and maintain the Versatec C2700 Series Thermal Transfer Color Plotter. The Model C2700 is the newest addition to Versatec's family of color plotters and the first to employ thermal transfer technology.

The material herein has been written for the first-time plotter operator, understanding only basic concepts used in the document production (reprographic) environment. This *operator* should not be responsible for plotter service or repair beyond what is recommended in this guide.

If you are having trouble finding the information you are looking for, read this preface and follow the instructions on the following page, *Getting Started* . . . To simplify text references, the Versatec Model C2700 Thermal Transfer Color Plotter will frequently be referred to by its model number or simply as *the plotter*.

## THE FORMAT

This guide has been organized according to the way a first-time user might learn to use the C2700 plotter to produce a plot of graphic information. As a reference aid, a condensed table of contents appears on the face of each section/appendix tab. Sections are arranged in the order the section tasks would initially be performed. The guide's six sections and three appendices are listed below:

Section 1	General Information
Section 2	Installation
Section 3	Loading the Ink Donor Roll and Media
Section 4	Operating Instructions
Section 5	Periodic Maintenance
Section 6	In Case of Difficulty
Appendix A	C2700 Models and Options
Appendix B	Plotter Control Functions
Appendix C	Glossary



## GETTING STARTED ...

The procedures below are aimed at a first-time user understanding only the basic concepts used in a document production environment.

1. Read Section 1, *General Information*, to familiarize yourself with the thermal plotter and its operating environment.
2. Follow the procedures in Section 2, *Installation*, to ensure all necessary materials are supplied and to prepare the plotter for operation.
3. Follow the procedures in Section 3, *Loading the Ink Donor Roll and Media*, to install the plotter supplies required prior to operation.
4. Follow the instructions in Section 4, *Operating Instructions*, to begin generating a monochrome or color hard copy of graphic data sent from your host computer.

*Note: If there is a need to modify plot defaults in order to generate a particular output, the parameters which may be changed (on a plot-by-plot basis) and the procedure to change them is described in the Versaplot software manual for your host operating system.*

5. Familiarize yourself with Section 5, *Periodic Maintenance*. This section describes all the necessary inspection and cleaning procedures to be performed on a regular basis, or as needed.
6. If the plotter is not operating properly, try to resolve the problem using the troubleshooting guides and diagnostic procedures in Section 6, *In Case of Difficulty*, before contacting your Versatec Service Representative.

# CONTENTS

## SECTION 1 GENERAL INFORMATION

WHAT IS A THERMAL TRANSFER COLOR PLOTTER?	1-1
FEATURES	1-1
THERMAL TRANSFER PLOTTING	1-2
HOW DOES THE PLOTTER FIT IN MY SYSTEM?	1-3
Plotter Interface	1-3
AC Power	1-3
HOW DO I OPERATE THE PLOTTER?	1-4
Plotter Control Command Functions	1-4
FUNCTIONAL DESCRIPTION	1-5
Interface/Control and Plotter Electronics	1-5
Media Transport Assemblies	1-5
Thermal Printhead	1-5
Ink Donor Roll	1-5
Media Stacker	1-5
PRODUCT COMPATIBILITY	1-7
PRODUCT SPECIFICATIONS	1-7
REFERENCE PUBLICATIONS	1-11

## SECTION 2 INSTALLATION

UNPACKING	2-1
INSPECTION	2-4
If You Require the International Configuration	2-5
SHIPPING CHECKLIST	2-6
Plotter Carton	2-6
Accessory Kit	2-6
REPORTING DAMAGED OR MISSING EQUIPMENT	2-7
PREPARING FOR STORAGE (OR RESHIPMENT)	2-7
SITE REQUIREMENTS	2-8
Electrical Requirements and Power Ratings	2-8
Ambient Temperature and Humidity Requirements	2-9
Space Requirements	2-9
Conditions and Locations to Avoid	2-10

# CONTENTS

PLOTTER CONNECTIONS	2-10
AC Power	2-10

## SECTION 3 LOADING THE INK DONOR ROLL & MEDIA

INSTALLING THE INK DONOR ROLL	3-2
-------------------------------	-----

LOADING MEDIA (PAPER or FILM)	3-7
-------------------------------	-----

## SECTION 4 OPERATING INSTRUCTIONS

CONTROLS AND INDICATORS	4-1
-------------------------	-----

OPERATING INSTRUCTIONS	4-3
------------------------	-----

MONOCHROME PLOTTING	4-4
Monochrome Black Donor Roll	4-4
3- and 4-Color Rolls	4-4

SETTING THE PLOT MARGINS	4-5
--------------------------	-----

TEST PLOT	4-6
-----------	-----

OPERATIONAL CHECKOUT	4-7
----------------------	-----

WHAT TO DO IF THERE IS NO PLOTTER OUTPUT	4-8
--	-----

## SECTION 5 PERIODIC MAINTENANCE

SAFETY PRECAUTIONS	5-1
--------------------	-----

PERIODIC PLOTTER MAINTENANCE	5-2
------------------------------	-----

CLEANING SUPPLIES	5-3
-------------------	-----

CLEANING PROCEDURES	5-3
---------------------	-----

Getting Ready	5-3
---------------	-----

Cleaning the Separator Turnbar	5-4
--------------------------------	-----

Cleaning the Thermal Printhead	5-4
--------------------------------	-----

Cleaning the Platen Roller	5-6
----------------------------	-----

Cleaning the Pinch Rollers	5-7
----------------------------	-----

Cleaning the Donor Roll Winding Roller	5-7
--	-----

# CONTENTS

CLEANING THE PLOTTER EXTERIOR	5-8
CLEANING DUST FROM PLOTTER INTERIOR	5-8
REPLACING THE INK DONOR ROLL AND MEDIA	5-9
SERVICE FACILITIES	5-9
STANDARD WARRANTY	5-10

## SECTION 6 IN CASE OF DIFFICULTY

COLOR TAILING	6-1
DONOR ROLL WRINKLE	6-2
PLOT SCRATCHES	6-3
PLOT HOLES	6-4
MISSING BLOCK(S)	6-5
UNEVEN INK DISTRIBUTION	6-6
STRIPES IN SOLID BLACK AREAS	6-7
PLOT MISREGISTRATION	6-8
LIGHT PLOT OUTPUT	6-9
CONTROL PANEL DIFFICULTY	6-9
DONOR ROLL AND PAPER JAMS	6-9
Recovering From a Donor Roll Jam	6-9
Recovering From a Paper Jam	6-10
GENERAL TROUBLESHOOTING	6-12

# CONTENTS

## APPENDIX A C2700 MODELS AND OPTIONS

MODELS	A-1
SUPPLIES AND ACCESSORIES	A-2
Media	A-2
Ink Donor Rolls	A-2
Media Cassettes	A-3
Media Stacker	A-3
Thermal Head Cleaner	A-3
Power Cables	A-3
Donor Roll Tray	A-3
Manuals	A-3

## APPENDIX B PLOTTER CONTROL FUNCTIONS

OPERATION AND CONTROL	B-1
REMOTE FUNCTIONS	B-1
Parallel Interface Signal Lines	B-2
ASCII CONTROL COMMANDS	B-4
Carriage Control Commands	B-4
Escape Sequence Commands	B-5
PLOT OPERATION	B-8
Plot Line Termination	B-9
SIMULTANEOUS FUNCTIONS	B-9
ON-LINE/OFF-LINE/REMOTE OPERATIONS	B-10
RASTER OUTPUT	B-10
VERSATEC DATA STANDARDS	B-10
MAG TAPE OUTPUT	B-10

## APPENDIX C GLOSSARY

## LIST OF FIGURES

Thermal Transfer Plotting Principles of Operation	1-2
System Data Flow	1-3
Plotter Functional Areas	1-6
C2700 Series Thermal Plotter (Cover Open)	2-2
Unlocking the Printhead	2-2
Unpacking the Ink Donor Roll Tray	2-3
Unpacking the Media Cassette	2-3
Freeing the Media Sensor Lever	2-4
C2700 Plotter Rear Panel (Plastic Cover Removed)	2-5
Plotter Dimensions and Space Requirements	2-9
Power Entry Panel	2-11
Ink and Media Supplies (3-color, A3 size shown)	3-1
C2700 Thermal Plotter (Cover open)	3-2
Accessing the Donor Roll Tray	3-3
Mounting the Ink Donor Roll	3-4
Aligning the Donor Roll (Supply Side)	3-5
Tightening the Donor Roll (Take-up Side)	3-5
Seating the Tray and Tray Guide	3-6
Media Cassette	3-7
Orienting Film in the Media Cassette (A3 size)	3-8
Loading Media (Paper)	3-9
Media Stacker	3-9
C2700 Control Panel	4-1
Power Entry Panel (Rear Cover Removed)	4-4
Rotary Switch Settings	4-5
Thermal Head Cleaner	5-3
Cleaning the Thermal Printhead	5-5
Platen Roller, Pinch Rollers and Donor Roll Winding Roller	5-6
Color Tailing	6-1
Donor Roll Wrinkle	6-2

## LIST OF FIGURES

Plot Scratches	6-3
Plot Holes	6-4
Missing Blocks	6-5
Uneven Ink Distribution	6-6
Stripes in Solid Black Areas	6-7
Plot Misregistration	6-8
Opening the Pinch Rollers	6-10
Removing Jammed Paper	6-11

## LIST OF TABLES

C2700 Series Thermal Plotter Specifications	1-8
Reference Publications	1-11
Ink Donor Roll Specifications	3-1
Control Panel Description	4-2
Periodic Maintenance Schedule	5-2
General Troubleshooting Guide	6-12
Guide to Error Indicators	6-14
Image Magnification Values	B-6
Control Byte [B] Configuration	B-7
Acceptable Line Sizes	B-8





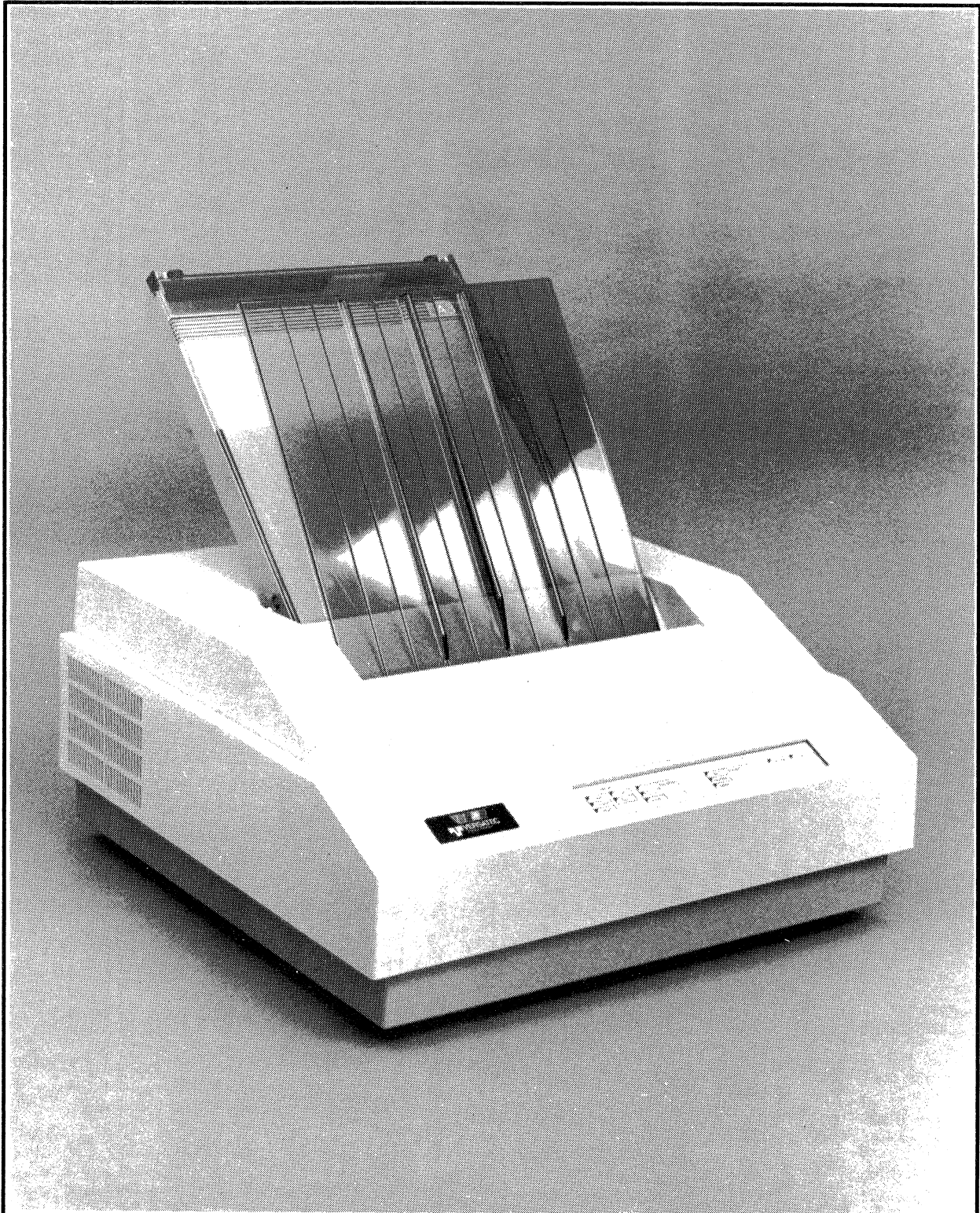

**VERSATEC'S C2700 SERIES THERMAL PLOTTER**

# SECTION 1

## GENERAL INFORMATION

This section provides a product description of Versatec's C2700 Series Thermal Transfer Color Plotter, an overview of its operating environment, a brief functional description, product compatibility information, and in a tabular format, model specifications and supplementary reference material.

### WHAT IS A THERMAL TRANSFER PLOTTER ?

The C2700 Series Thermal Transfer Plotter is a narrow format plotter that produces color and monochrome (single color) plots on cut paper or transparency film. Graphic data in Versatec Data Standard (VDS) format is converted to *raster* data and arranged in an order acceptable to the plotter by the host computer or a controller/interface. It is this raster data the C2700 plotter uses to generate the plot. *Thermal transfer plotting*, described on the next page, is a plotting technology that uses individually heated elements (nibs) in the plotter's thermal printhead to melt a wax-based ink coating from a donor roll onto the media to produce a plot image.

### FEATURES

- Color and monochrome output are available on standard A, B, A3 and A4 size paper and transparency film, allowing the user to choose the plot size and media best suited to his/her needs
- Pre-cut media eliminates waste between single plots
- Film plotting capability enables using a single C2700 plotter for check plots on paper and final plots on transparency film
- Three choices of image enlargement (magnification) offer a variety of viewing options
- Selectable color intensity allows the user to compensate for extreme temperature conditions or adjust color brightness to meet his/her output requirements
- Easy-to-use control/indicator panel and internal self-test enable the user to isolate plotting problems quickly
- Supports Versatec's 37-pin parallel interface\*
- Small size makes the plotter easy to move around

\* Each unit is also equipped with a Centronics® Parallel interface port, a feature not presently supported by Versatec software. Customers desiring the Centronics interface must provide their own device driver.

**THERMAL TRANSFER PLOTTING**

Figure 1-1 illustrates the basic principle of operation used in thermal transfer plotting. A sheet of media and a color panel from the donor roll pass simultaneously between the platen roller and thermal printhead. In response to a digital signal from a host processor, individual elements (nibs) in the head are selectively turned on. The energized nibs heat up, melting the wax-based ink from the donor roll onto the media. Through this process, separate color images are transferred to the media with each pass.

Monochrome plots can be produced in a single pass using a monochrome donor roll (refer to *Monochrome Plotting*, Section 4). To produce multicolor plots, a multiple pass technique is used. The first pass transfers an image from the yellow panel. The printhead lowers automatically and the media retracts at approximately 1.7 in/sec to the plot starting position as the next color panel (magenta) is set in place. If a 3-color donor roll is used, the plotter makes a final pass in cyan which, combined with yellow and magenta, produces a 3-color black. A 4-color donor roll is available, enabling the user to transfer a separate image in process black.

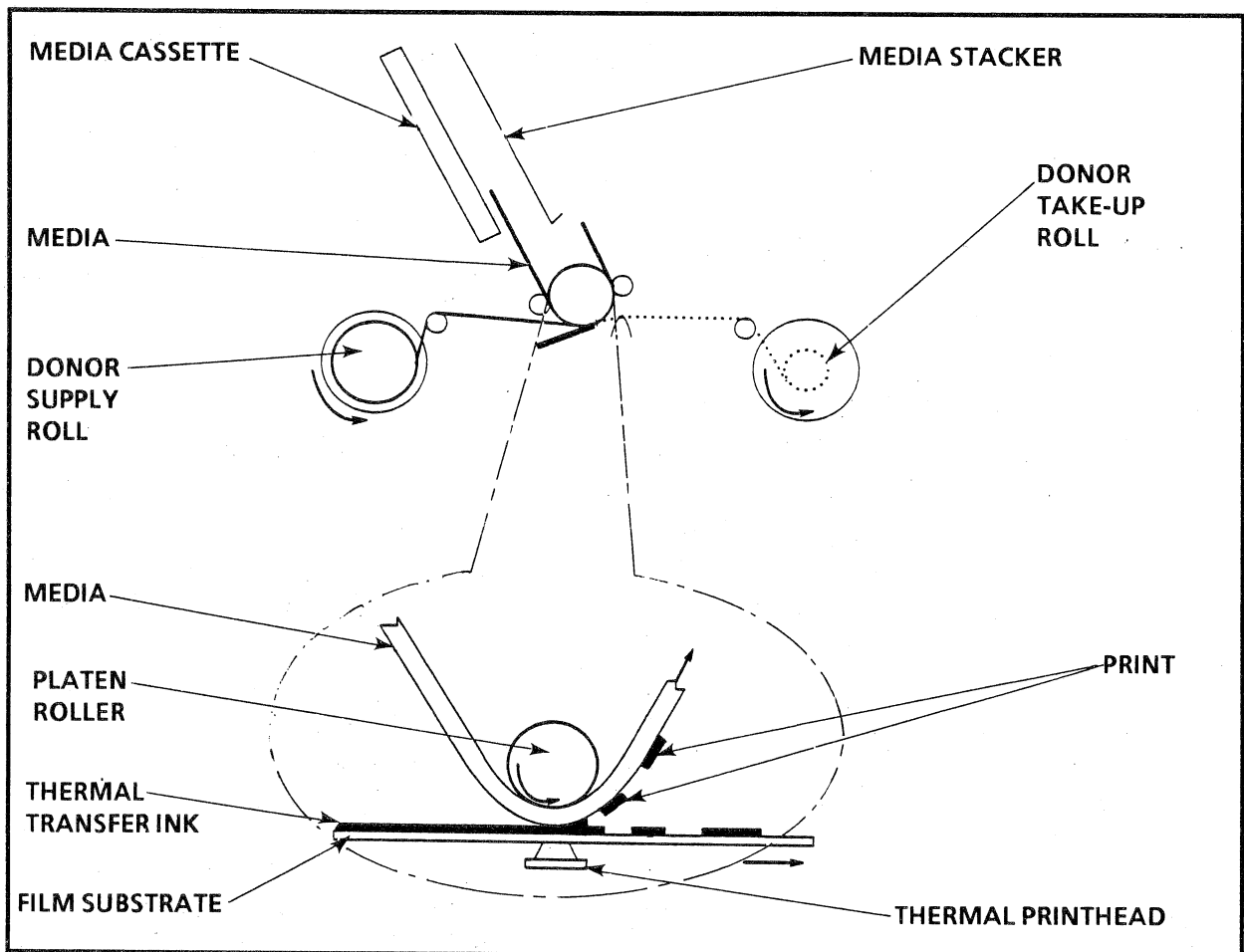

Figure 1-1. Thermal Transfer Plotting Principles of Operation

## HOW DOES THE PLOTTER FIT IN MY SYSTEM?

The C2700 Series Plotter is connected to a controller providing a Versatec Parallel (also known as *Greensheet*) input interface between the host computer and the plotter. This controller can be Versatec's RPM (Raster Processing Machine) or an interface PCB residing in the host computer that outputs raster data in Versatec byte-parallel protocol.

### Plotter Interfaces

The plotter may be connected to a host input device or controller/interface via a 37-pin (Versatec Parallel) or 36-pin (Centronics Parallel) interface connector located at the rear of the unit. The plotter may be located up to 15 feet (4.57 meters) away from the host or controller/interface if supporting a TTL input (Centronics) or 1000 feet (304.8 meters) if a differential interface (Versatec Parallel) is used.

### AC Power

The length of the power cord allows the plotter to be placed up to 10 feet (3 meters) from a facility ac power receptacle (115 Vac or 230 Vac nominal).

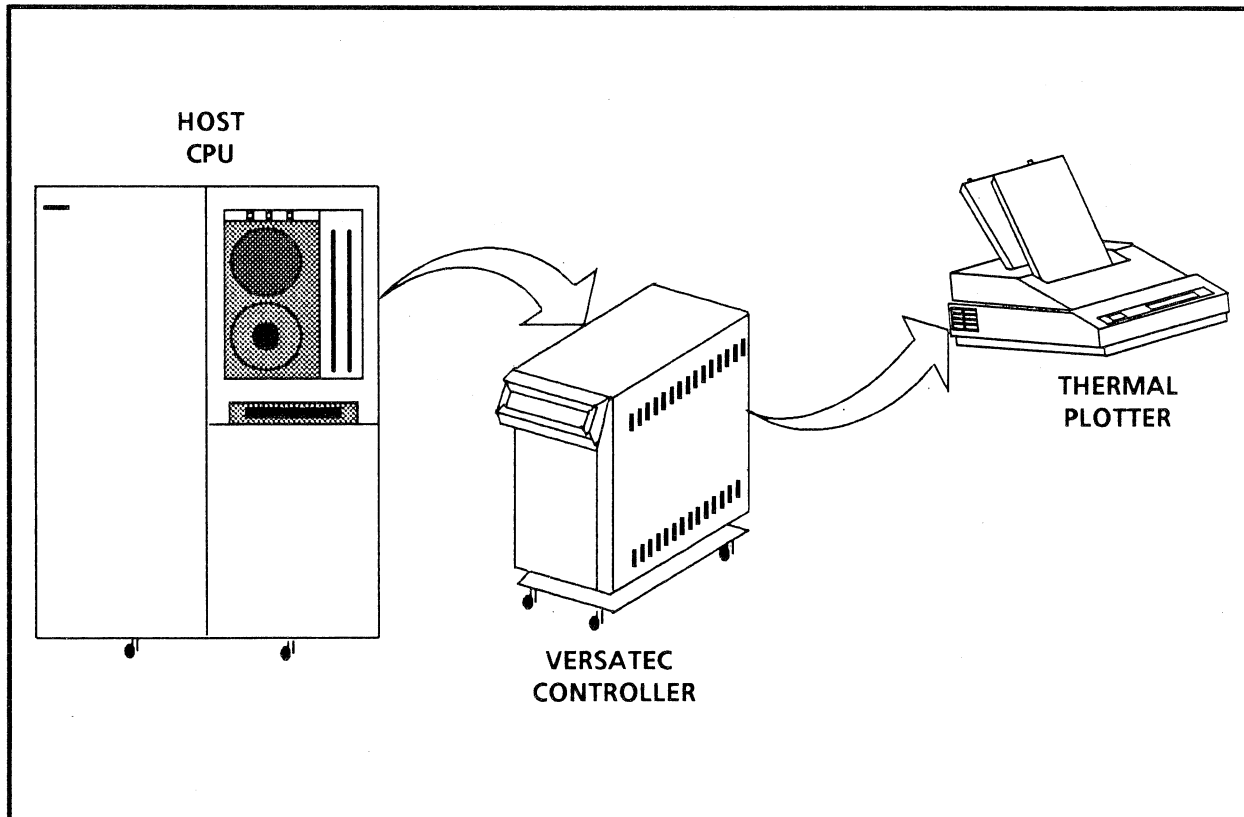

Figure 1-2. System Data Flow

## HOW DO I OPERATE THE PLOTTER ?

The operator is provided with plotter control and status-checking capabilities via the indicators and switches on the plotter's easy-to-use control panel, described in Section 4, *Operating Instructions*. The rear of the plotter provides the connectors to attach the ac power and system interface cables.

### Plotter Control Command Functions

Via the host software, the experienced user can manipulate the way data will be plotted (on a plot-by-plot basis). The plotter is controlled through a combination of *escape sequence* commands and *remote* Versatec Parallel functions sent to the plotter through the host software. The C2700 Series Plotter responds to the plotter control commands and remote functions listed below. Each is described in detail in Appendix B.

- Mirror Image
- Inverse Image
- Rewind
- Image Magnification
- Color Header Preamble
- Form Feed
- End-of-Transmission
- Clear
- Remote Form Feed
- Remote End-of-Transmission
- Remote Reset
- Remote Line Terminate

**Note:** *Versatec's Color Random software package enables the software programmer, analyst, or system manager to select plot control parameters via on-line menus. Integrated host software packages may require the user to enter an escape sequence command string to enable a specific plotter function. Escape sequence commands are listed in Appendix B, Plotter Control Functions.*

## FUNCTIONAL DESCRIPTION

There are five major functional areas in the plotter. Each is described below and identified in Figure 1-3.

### Interface/Control and Power Electronics

Inside the plotter's rear panel are the *Parallel Interface* and *System Control Electronics* PCBs, the power supply and the parallel bus structure (*motherboard*) used to route all plotter commands and plot data.

### Media Transport Assemblies

The media transport assemblies enable the mechanical movement of the media between the thermal printhead and platen roller for monochrome or color plotting. They include the media cassette, pick roller and the front and back pinch rollers.

### Thermal Printhead

The thermal printhead contains an array of heating elements (nibs) that responds to digital pulses from a host processor by heating selected nibs that melt (transfer) ink onto the media.

### Ink Donor Roll

The ink donor roll contains the panels of wax-based color inks that are transferred to the media through contact with the energized (heated) elements in the printhead. Movement of the color panels is controlled by the donor roll drive motor.

### Media Stacker

The media stacker/ejector mechanism is a continuation of the media transport assemblies. When a plot is complete, the eject rollers engage the media, moving it out of the imaging area and onto the stacker.

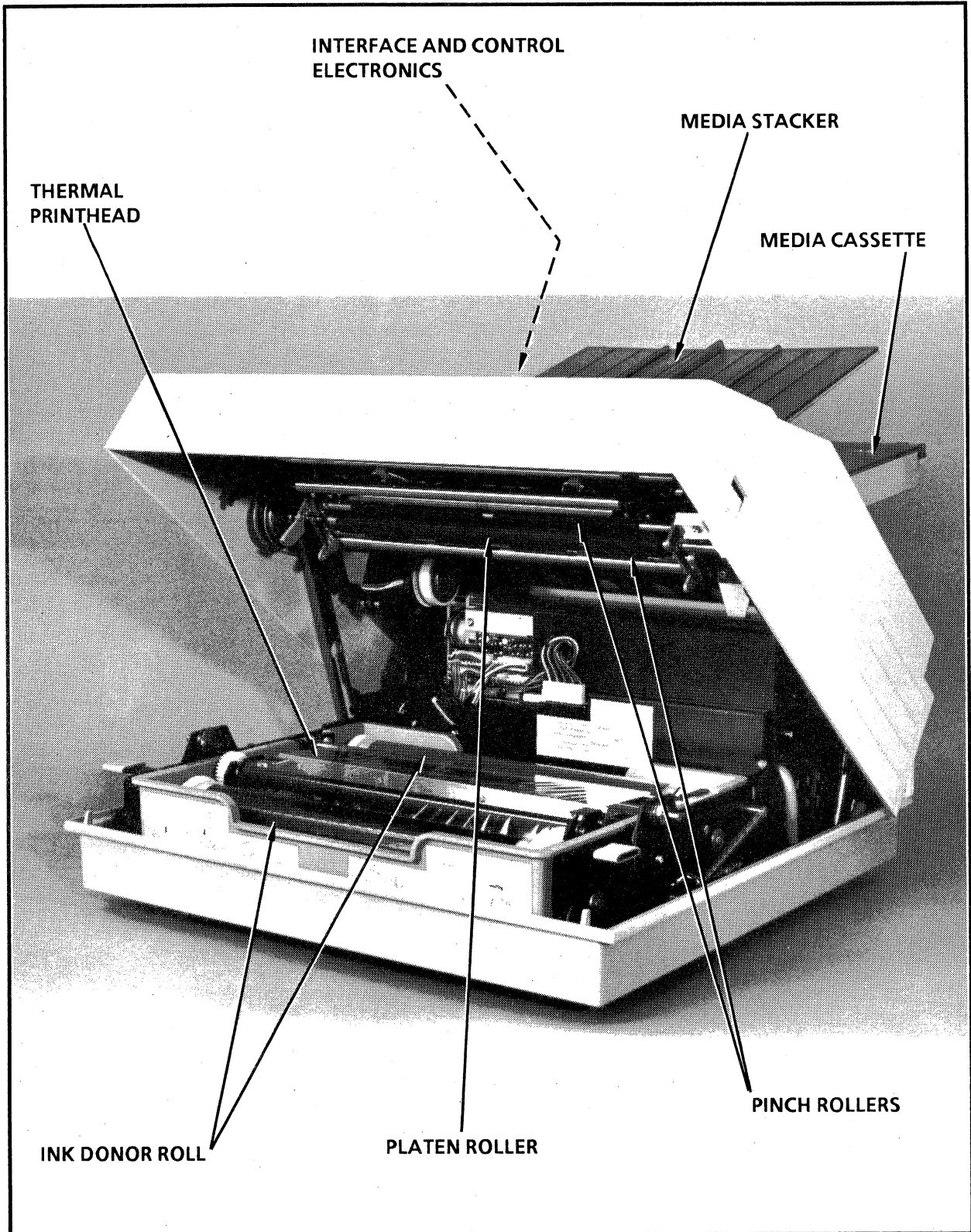

Figure 1-3. Plotter Functional Areas

## PRODUCT COMPATIBILITY

The C2700 Series Plotter is designed to be compatible with the Versatec Parallel interface. This means the plotter is plug-to-plug compatible with Versatec computer interfaces and controllers. The C2700 supports a Centronics Parallel or Versatec Parallel input interface.

**Note:** *The Versatec Parallel interface is compatible only with Versatec's Color Random software package. Users desiring the Centronics Parallel interface must provide their own device driver.*

The following is a list of Versatec products compatible at this time with your C2700 Series Thermal Transfer Plotter.

- Model 110 IBM PC/AT Interface
- Model 250 RGB Video Controller
- Model 800 Series Raster Processing Machine

## PRODUCT SPECIFICATIONS

Table 1-1 lists the mechanical, electrical and environmental specifications for the C2700 Series Plotter.



Table 1-1. C2700 Series Thermal Plotter Specifications

<b>GENERAL</b>	
Model Numbers	C2756-VV, C2766-VV (Versatec Parallel interface) C2756-CM, C2766-CM (Centronics Parallel interface)
Writing Method	Thermal Transfer
Dot Density	300 ppi ( <i>points-per-inch</i> ), Single Array
Media and Dimensions	<p><u>Cut Paper (75 g/m<sup>2</sup>):</u></p> <p>A3 size 297 × 420 mm A4 size 210 × 297 mm B size 11 × 17 in A size 8.5 × 11 in</p> <p><u>Transparency Film:</u></p> <p>A3 size 297 × 420 mm A4 size 210 × 297 mm B size 11 × 17 in A size 8.5 × 11 in</p>
Media Feed System	Automatic feed from media cassette; holds up to 150 sheets of paper. For transparency film, no more than one sheet at a time is recommended
Media Output System	Automatic stacking onto receiver tray; stacks up to 30 sheets of paper or <u>one sheet</u> of transparency film at a time
Color Ink Application	Thermally transferred to media from ink donor roll containing heat-fusible ink film
Ink Colors (primaries)	3-color roll: Yellow, Magenta, Cyan 4-color roll: Yellow, Magenta, Cyan, Black Monochrome roll: Process black
Basic Printing Colors	Seven basic dot colors: Black, Cyan, Magenta, Yellow, Red, Green, Blue
<b>PLOTTER OPERATOR CONTROLS</b>	<p><u>Media Control:</u></p> <p>FEED</p> <p><u>Plot Options</u></p> <p>INTENSITY</p> <ul style="list-style-type: none"> <li>• LIGHT</li> <li>• NORMAL</li> <li>• DARK</li> <li>• LINE INTENSITY (<i>no lamps lit</i>)</li> </ul> <p>ENLARGE</p> <ul style="list-style-type: none"> <li>• 1 × 1 (<i>default</i>)</li> <li>• 2 × 2</li> <li>• 3 × 3</li> <li>• 2 × 4</li> </ul>

Table 1-1. C2700 Series Thermal Plotter Specifications

<b>FRONT PANEL INDICATORS</b>	<u>Operational Status:</u> POWER (ON/OFF) ON LINE <u>Error Status:</u> ERROR <ul style="list-style-type: none"> <li>• JAM</li> <li>• COVER</li> <li>• HEAT</li> <li>• EOP (<i>end of paper</i>)</li> <li>• EOI (<i>end of ink</i>)</li> </ul>																								
<b>PLOTTING</b>																									
Resolution Dot Size  Dots Per Unit Area	300 points-per-inch (11.81 points-per-mm) 0.0027 inch × 0.0043 inch, average (plot density dependent)  90,000 Dots Per Square Inch																								
Total Writing Nibs per Media Size (= writing width × nibs/inch)	A: 2433 B: 3183 A4: 2362 A3: 3392																								
Maximum Plotting Area	A size: 8.11 in × 8.91 in A4 size: 200 mm × 244 mm B size: 10.61 in × 14.91 in A3 size: 287 mm × 367 mm																								
Image Magnification	1 × 1 dot (default) 2 × 2 dots 3 × 3 dots 2 × 4 dots																								
Ink Donor Roll Characteristics	Heat-fusible ink coating on a polyester film substrate Three or four colors or monochrome black 12.4 inches wide, 11 inches or 17 inches long for each color panel																								
Data Bytes Per Scan	296-424; dependent on media size. Refer to Appendix B, <i>Plotter Control Functions</i> , for a table of exact values.																								
Plot Time (seconds)	<table border="1" style="width: 100%; border-collapse: collapse;"> <thead> <tr> <th style="text-align: left;"><u>Donor Roll:</u></th> <th style="text-align: center;">Monochrome</th> <th style="text-align: center;">3-Color</th> <th style="text-align: center;">4-Color</th> </tr> </thead> <tbody> <tr> <td colspan="4"><u>Media Size</u></td> </tr> <tr> <td style="text-align: left;">A</td> <td style="text-align: center;">15</td> <td style="text-align: center;">45</td> <td style="text-align: center;">60</td> </tr> <tr> <td style="text-align: left;">A4</td> <td style="text-align: center;">15</td> <td style="text-align: center;">45</td> <td style="text-align: center;">60</td> </tr> <tr> <td style="text-align: left;">B</td> <td style="text-align: center;">20</td> <td style="text-align: center;">60</td> <td style="text-align: center;">80</td> </tr> <tr> <td style="text-align: left;">A3</td> <td style="text-align: center;">20</td> <td style="text-align: center;">60</td> <td style="text-align: center;">80</td> </tr> </tbody> </table>	<u>Donor Roll:</u>	Monochrome	3-Color	4-Color	<u>Media Size</u>				A	15	45	60	A4	15	45	60	B	20	60	80	A3	20	60	80
<u>Donor Roll:</u>	Monochrome	3-Color	4-Color																						
<u>Media Size</u>																									
A	15	45	60																						
A4	15	45	60																						
B	20	60	80																						
A3	20	60	80																						
Maximum Plot Speed (in/sec)	Approximately 1.16 in/sec																								
Data Rate at Maximum Speed	190.8 kbytes/sec																								

Table 1-1. C2700 Series Thermal Plotter Specifications

Registration Error	Mean Value: $x, y \leq 0.1$ mm (0.004 in) Maximum value: $x_{\max}, y_{\max} \leq 0.2$ mm (0.008 in)
<b>PHYSICAL DIMENSIONS</b>	
Height	9.6 inches (245 mm)
Width	20.9 inches (530 mm)
Depth	19.7 inches (500 mm)
Weight	81.4 lbs (37 kg) <i>without</i> supplies
Recommended clearance	Two inches (5.1 cm) recommended on sides for adequate cooling; 12 inches (30.5 cm) at the rear for servicing
<b>INTERFACE</b>	Versatec Parallel 37-pin differential input Centronics 36-pin, Byte-Parallel Interface (TTL) (not supported by Versatec)
<b>ELECTRICAL</b>	
Voltage Requirement	115 Vac (90-130 Vac) or 230 Vac (180-260 Vac), Switch Selectable 50-60 Hz, $\pm 3$ Hz
Maximum Operating Power	585 W
Nominal Operating Power (while plotting)	400 W
Operating Power, idle (powered ON, not plotting)	70 W
Wall Outlet Requirement	115V @ 6A 230V @ 3A
<b>ENVIRONMENTAL</b>	
EMI/RFI Standards	UL, CSA, VDE listed FCC Class A, VDE Class A ratings
Maximum Heat Dissipation	1995 BTUs/Hour
Nominal Heat Dissipation (while plotting)	1364 BTUs/Hour
Heat Dissipation, when idle	239 BTUs/Hour
Normal Operating Temperature	41-95°F (5-35°C)
Storage Temperature	-4-131°F (-20-55°C)
Normal Operating Humidity	30-80% RH, Non-condensing
Storage Relative Humidity	30-90% RH, Non-condensing
Audible Noise Level	Powered ON, not plotting: 45 dBA @ 1 m.

## REFERENCE PUBLICATIONS

The publications listed below supplement data contained in this guide and provide additional information concerning the operation of the Versatec C2700 Series Thermal Transfer Plotter. It is recommended that users of this manual be familiar with the documentation describing their host operating system.

**Table 1-2. Reference Publications**

TITLE	PUBLICATION NUMBER
C2700 Series Thermal Transfer Plotter Service Manual	5991
Versaplot Color Random 2.1 Software Operating Manual . . . <i>for your host operating system</i>	57xx
Versaplot Color Graphics Programming Manual: Provides functional descriptions of the program calls for your application program	5759
Versatec Data Standards Manual	5956*
Versaplot Programmer's Reference Card	5749
Universal Versaplot Color Random 2.1 Integration Manual	5751

\* Verification of a signed software license agreement is required to obtain this document.

I  
C  
I  
I  
I  
I  
I  
I  
I  
C  
I  
I  
I  
I  
I  
I  
I  
I  
C  
I  
I

## SECTION 2

# INSTALLATION

This section outlines the procedures to be followed upon receiving your Versatec C2700 Series Thermal Transfer Color Plotter, from equipment unpacking and inspection to connecting the power cable. In addition, it provides the user with the site requirements for safe and correct performance in the operating environment.

### UNPACKING

The Versatec C2700 Series Thermal Plotter is shipped as an assembled unit inside a reinforced cardboard box. The plotter is covered in clear polyethylene and surrounded on all sides by packing foam. An accessory kit shipped with the plotter contains the items listed in the shipping checklist on page 2-6. The unpacking procedure is described below.

*Note: Prior to opening the shipping boxes, visually inspect them for evidence of physical damage. If damage to the contents is suspected, the box(es) should remain UNOPENED and the problem immediately reported to your Versatec Representative. He/she will assist you in filing a damage claim with the freight shipper and replacing the equipment.*

1. Set the box right-side-up and slit the packing tape with a utility knife. Open the lid and remove the top layer of packing foam.

*Caution: Without accessories, the plotter weighs approximately 81.4 lbs (37 kg). Two people are required to lift the plotter out of its packing box to avoid injury to personnel or damage to the equipment.*

2. Remove the plotter from the packing box and gently set it on a flat, clean surface able to support at least 82 pounds. Retain all packaging for possible future transport.
3. Remove the clear polyethylene cover and protective foam from the plotter exterior. If your facility power is 230 Vac, note the warning regarding the plotter input voltage setting.
4. Pull the cover latch on the right side of the plotter chassis *up* and lift the top cover to access the interior of the plotter. Ensure the cover support is locked in place (Figure 2-1).
5. Carefully remove the protective foam sheet from the thermal printhead (Figure 2-1).
6. Cut and remove the two tie-wraps securing the head position mechanism, as shown in Figure 2-2.

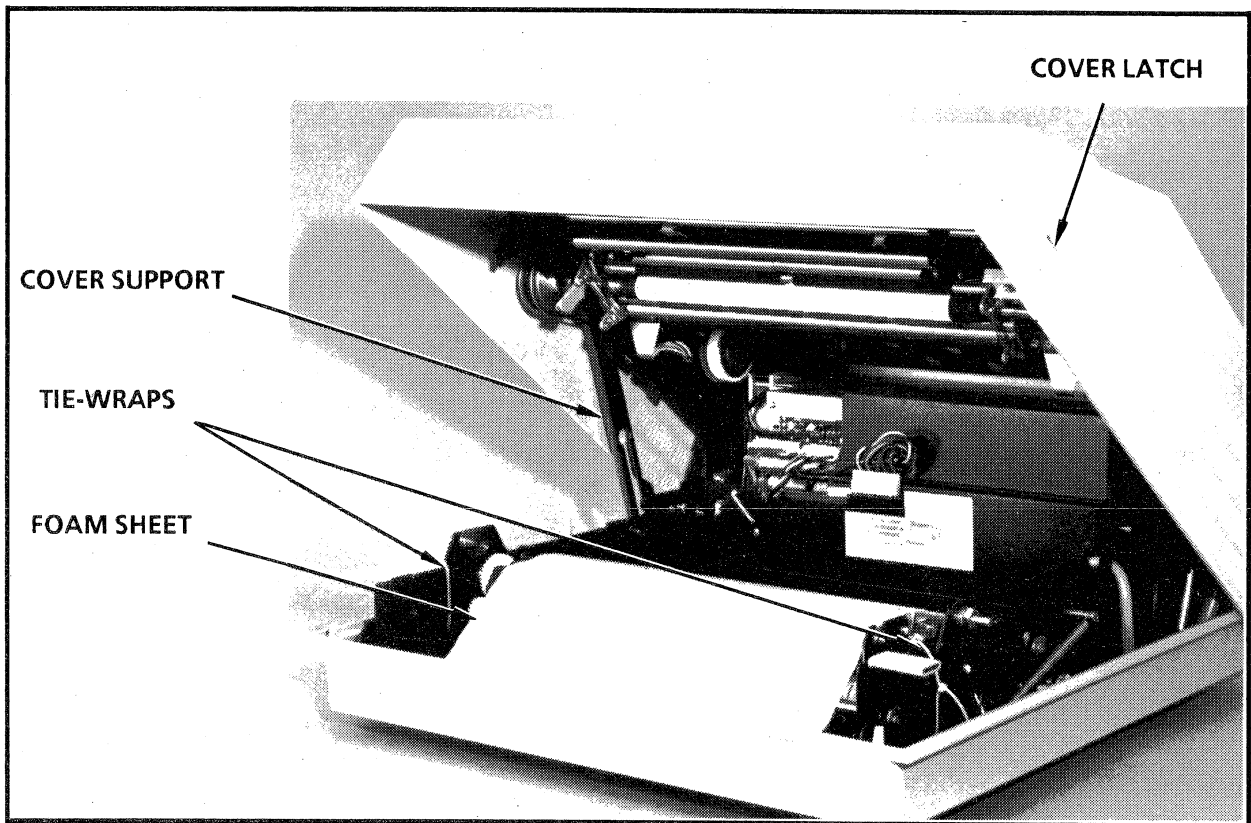

Figure 2-1. C2700 Series Thermal Plotter (cover open)

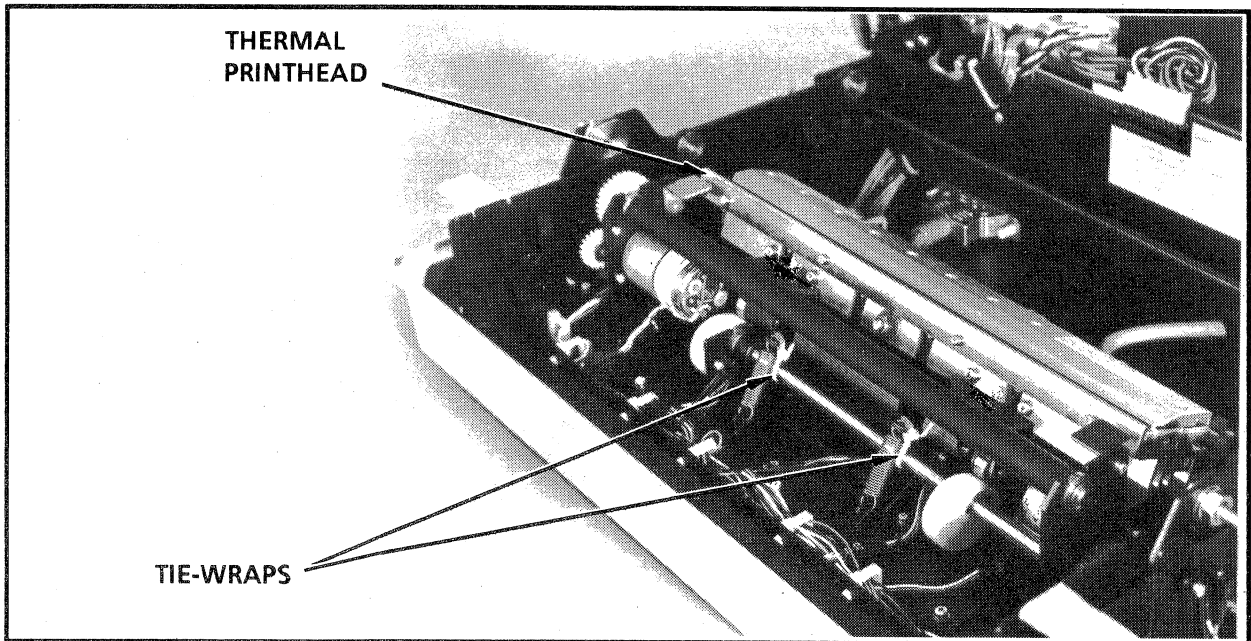
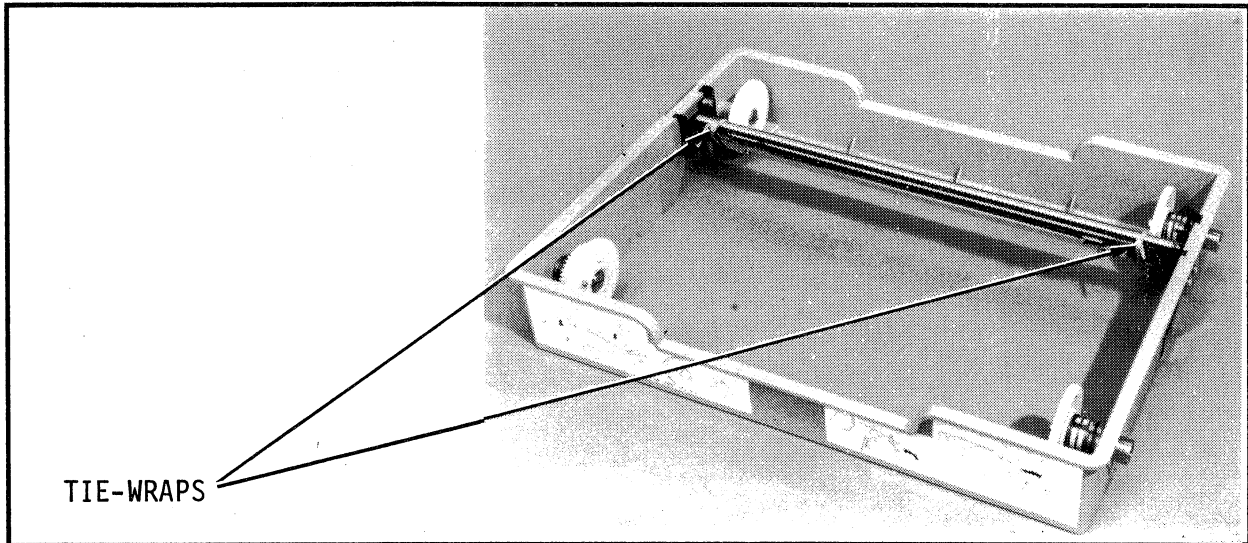

Figure 2-2. Unlocking the Printhead

7. Cut and remove the two tie-wraps securing the ink donor roll tray guide, as shown in Figure 2-1.
8. Open the second box and unpack the accessories (power cable, manual, supplies, etc.). Check the contents against the enclosed packing slip and the shipping checklist in this section.
9. Locate the ink donor roll tray. Cut and remove the two tie-wraps as shown in Figure 2-3.



**Figure 2-3. Unpacking the Ink Donor Roll Tray**

10. Locate the media cassette. Remove the foam cushion and protective foam sheet from the top of the media cassette as shown in Figure 2-4.

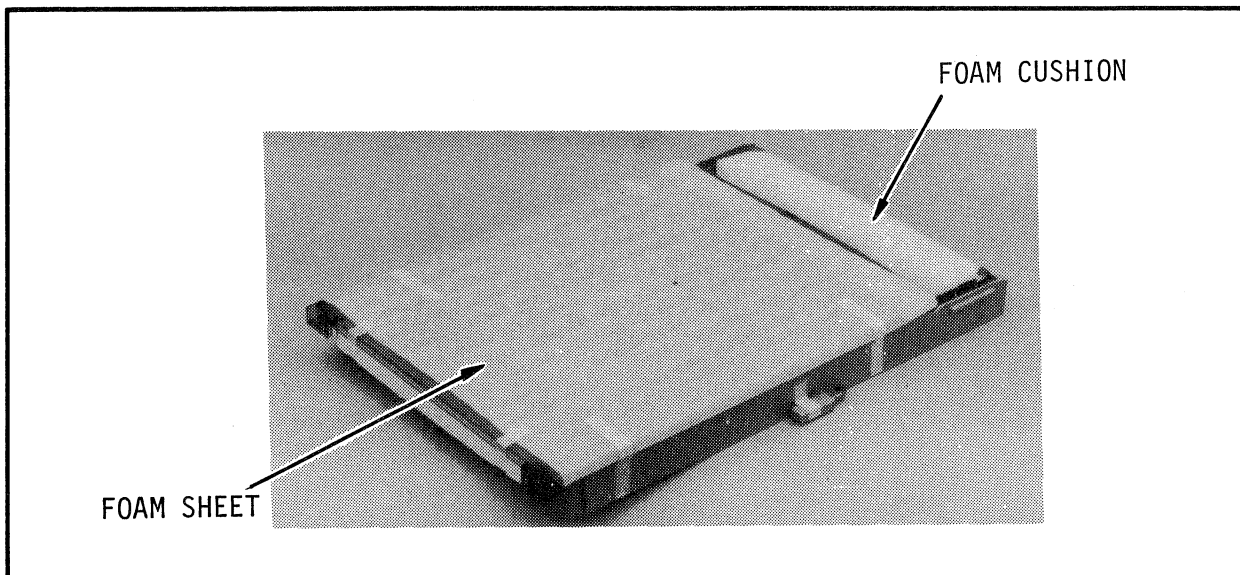

**Figure 2-4. Unpacking the Media Cassette**



11. Close the plotter cover securely.
12. Slide out the foam cushion from beneath the media sensor lever, located inside the media cassette slot at the top of the plotter as shown in Figure 2-5.

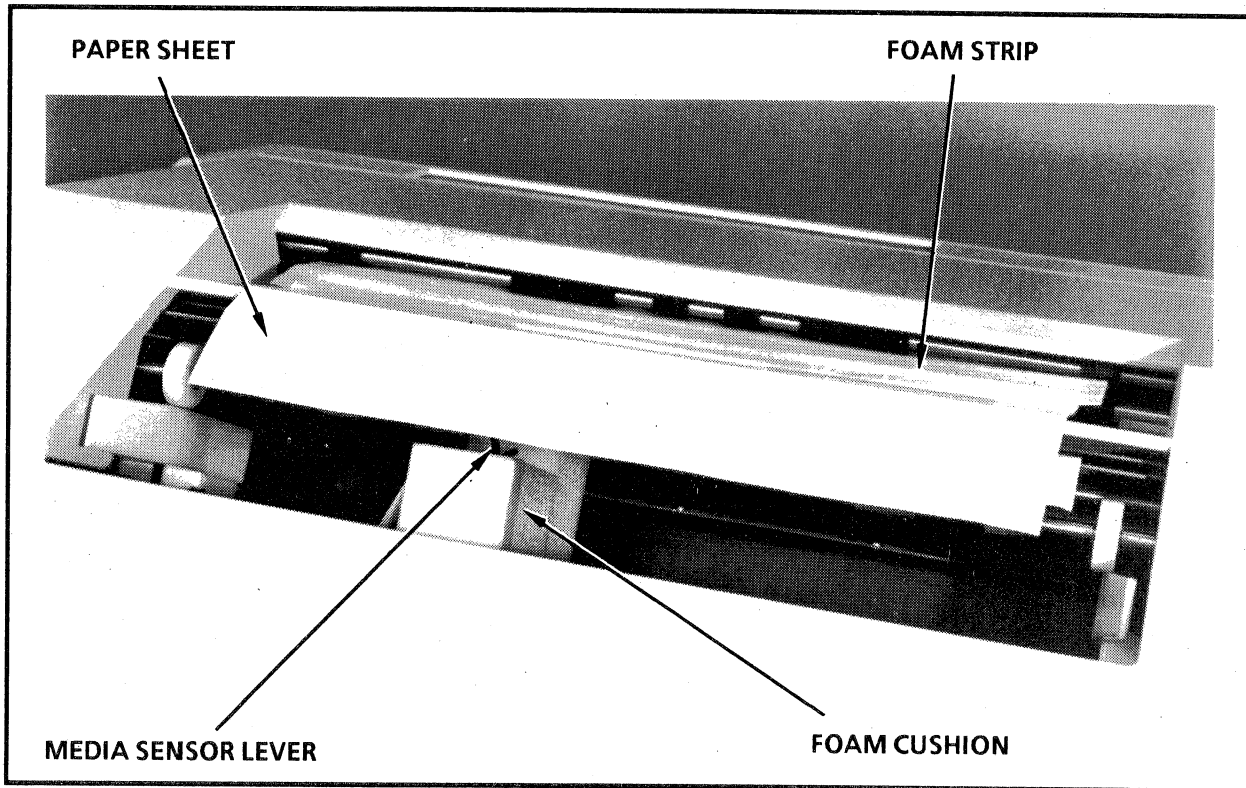

Figure 2-5. Freeing the Media Sensor Lever

13. Slowly pull the paper sheet and foam strip through the eject rollers at the top of the plotter (Figure 2-5).

## INSPECTION

Once the C2700 plotter is unpacked, carefully inspect the plotter and accessory kit for possible damage sustained during shipment using the steps below as a guide. If the plotter and/or the accessory kit are damaged or missing, **DO NOT** attempt to repair or alter them in any way; follow the instructions in *Reporting Damaged or Missing Equipment* on page 2-7.

**Warning:** *Ensure that power is not applied to the plotter prior to inspection of the unit.*

1. Verify the equipment supplied in the accessory kit matches the shipping checklist.
2. Verify the plotter cabinet does not have any cracks and is not seriously damaged in any way.

**Caution:** All units are shipped configured for 115 Vac operation. If your power source is 230 Vac, you must configure the plotter to accept 230 Vac input as described below. Failure to do so will seriously damage the plotter.

### If You Require the International\* Configuration . . .

1. Using a Phillips head screwdriver, loosen the four screws securing the rear plastic cover to the plotter. Remove the cover and set it aside (Figure 2-6).
2. On the ac power entry panel, push the input voltage selector switch down to the 230 Vac position. Refer to Figure 2-6.
3. Locate the BT8 DIP switch on the rear panel and put the last switch on the right (#8) to the down (ON) position (Figure 2-6). This enables the plotter to accept international media sizes (A3 or A4). Ensure the remaining switches are in the up (OFF) position.
4. Replace the rear plastic cover and secure with the attaching hardware.

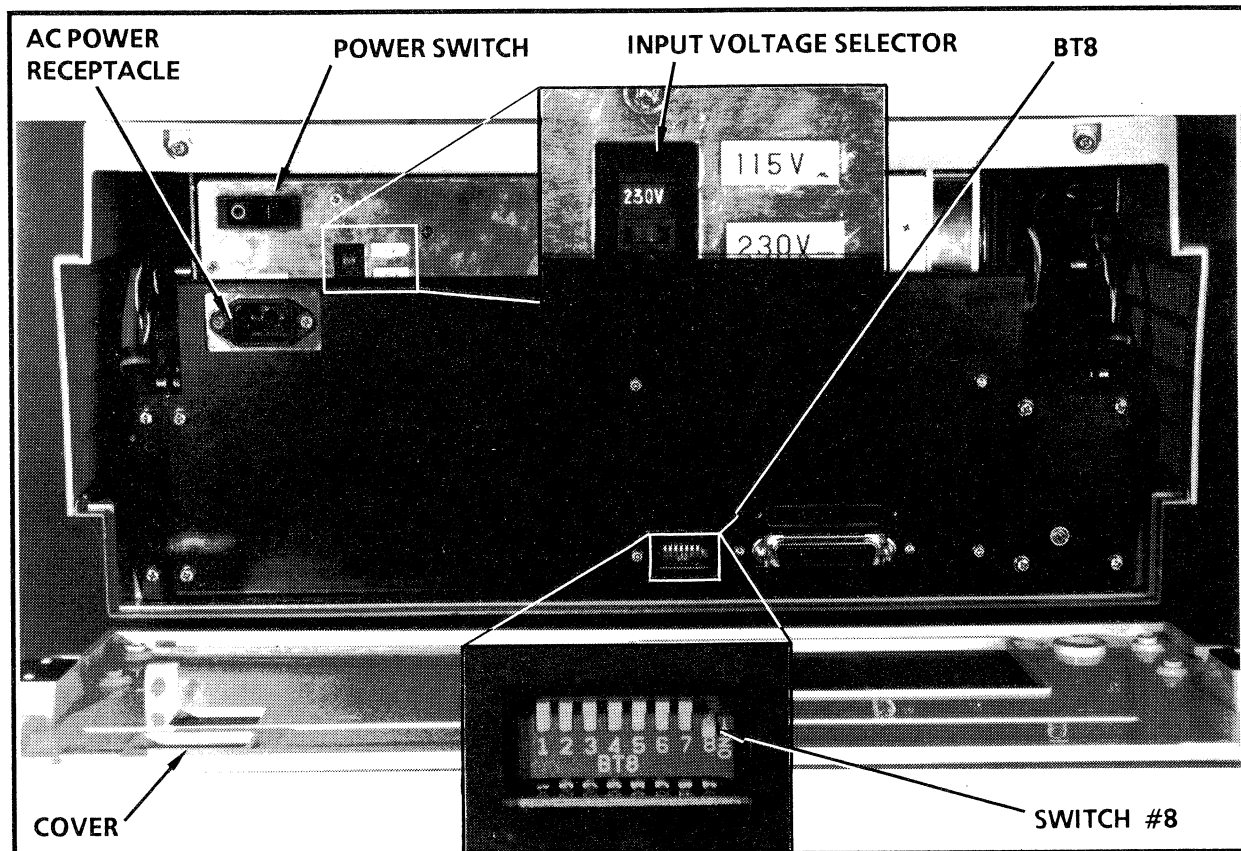

Figure 2-6. C2700 Plotter Rear Panel (Plastic Cover Removed)

\*configured to accept 230 Vac input and A3/A4 size media

## SHIPPING CHECKLIST

In addition to the C2700 plotter itself and this Operator Guide, the materials listed below are supplied in the accessory kit.

**Note:** *The interface cable, linking the plotter with the host or controller/interface, is supplied with all Versatec controllers or Versatec Parallel interfaces. It is not usually included in the plotter shipping package.*

### Plotter Carton

- C2700 Series Thermal Transfer Color Plotter

Stand-alone cabinet enclosure, tabletop unit.

**Note:** *Two accessory kits are available--domestic (U.S. and Canada) and international. The domestic kit contains a 115 Vac power cord and includes A and B size media, media cassettes and ink donor rolls. The international kit contains a 230 Vac power cord and includes A4 and A3 size media with the corresponding media cassettes and donor rolls.*

### Accessory Kit

- Power Cable:

Connects the plotter with facility ac power.

- C2700 Series Thermal Transfer Plotter Operator Guide (Publication No. 5990)
- Media Cassettes, accommodating A and B or A4 and A3 size media
- Media Stacker, 12.4 in × 14 in (314 mm × 355 mm)
- Ink Donor Roll Tray
- Ink Donor Rolls: 3-color, 30 plot capacity:  
11-inch; used with A (A4) size media  
17-inch; used with B (A3) size media
- Media: A (8.5 in × 11 in) and B size (11 in × 17 in) paper, 30 sheets each  
or  
A4 (210 mm × 297 mm) and A3 size (297 mm × 420 mm) paper, 30 sheets each
- Thermal Head Cleaner

## REPORTING DAMAGED OR MISSING EQUIPMENT

If the plotter, its assemblies and/or their accessories are damaged or missing, contact your Versatec Service Representative immediately. The problem must be reported and any damaged parts returned to the Versatec district office. The district office will then obtain a "Returned Goods Authorization Number" from Versatec's Returned Goods Department and return the equipment to the factory using the established procedure. Equipment returned should be in the original packaging material or prepared for reshipment as indicated below.

## PREPARING FOR STORAGE (OR RESHIPMENT)

Use the following procedure as a guide in preparing the C2700 Series Plotter for storage or reshipment.

1. Power OFF the plotter and disconnect the ac power cord from both facility power and the plotter ac power receptacle.
2. Remove the media cassette and media stacker.
3. Open the plotter lid and remove the ink donor roll and donor roll tray, if installed. Refer to Section 3, *Loading the Ink Donor Roll and Media*.
4. Fasten or cushion any moveable items in the plotter using the procedure in *Unpacking* as a guide. You must:
  - Secure the head position mechanism with tie wraps as shown in Figure 2-2.
  - Cover the thermal printhead with a protective foam sheet.
  - Secure the ink donor roll tray guide with tie-wraps. Refer to step 10, *Unpacking*, and Figure 2-1.
  - Secure the media sensor lever with packing foam or a similar material. Refer to Figure 2-5.
5. Close the plotter lid securely.
6. Cover the plotter with a polyethylene bag or similar protective covering.

**Caution:** *Without accessories, the plotter weighs approximately 81.4 lbs (37 kg). Two people are required to lift the plotter into its packing box to avoid injury to personnel or damage to the equipment.*

## INSTALLATION

7. Place the plotter in its original box or a similar packing container. Surround the unit with sufficient packing material.
8. Seal the box with packing tape.
9. The following conditions apply only when preparing the plotter and/or its supplies for storage:
  - Temperature:  $-20^{\circ}\text{C}$  to  $55^{\circ}\text{C}$  ( $-4^{\circ}\text{F}$  to  $131^{\circ}\text{F}$ )
  - Humidity: 30% to 90%, non-condensing  
(Media must be stored between 30% and 80% relative humidity)

**Note:** Donor rolls must be stored between  $32^{\circ}$  and  $86^{\circ}\text{F}$  ( $0-30^{\circ}\text{C}$ ) at 30-85% relative humidity. When stored under these conditions, the rolls have a shelf life of one year.

## SITE REQUIREMENTS

Requirements for the plotter operating environment are described below:

### Electrical Requirements and Power Ratings

The standard C2700 Series Plotter is configured to accept 115 Vac as an input power source. A selector switch inside the rear panel allows the plotter to operate at line voltages of 90 to 130 Vac (115 Vac nominal) or 180 to 260 Vac (230 Vac nominal). Plotter power requirements are listed below:

- Maximum Operating Power: 585 W
- Nominal Operating Power (while plotting): 400 W
- Operating Power, idle (powered ON, not plotting): 70 W
- Frequency Range:  $50/60\text{ Hz} \pm 3\text{ Hz}$ , single phase

#### Additionally,

- Use an ac receptacle separate from other electrical equipment that may generate noise
- Do not use a workbench outlet or branched circuit as your main power connection

### Ambient Temperature and Humidity Requirements

- Operating Temperature: 41° to 95°F (5° to 35°C)
- Nominal Heat Dissipation: 1364 BTUs/Hour
- Relative Humidity: 30% to 80%, non-condensing

### Space Requirements

Plotter cabinet dimensions and space requirements are shown in Figure 2-7. To provide adequate ventilation during plotter operation, allow a *minimum* of two inches (50.8 mm) of clearance at the sides of the plotter. For unit servicing and maintenance, you must provide at least 12 inches (304.8 mm) of clearance at the rear to allow room for the media cassette when the top cover is opened. The installation site should also meet the following requirements:

- Support at least 81.4 (37 kg) pounds plus weight of accessories
- Be reasonably smooth, level and clean

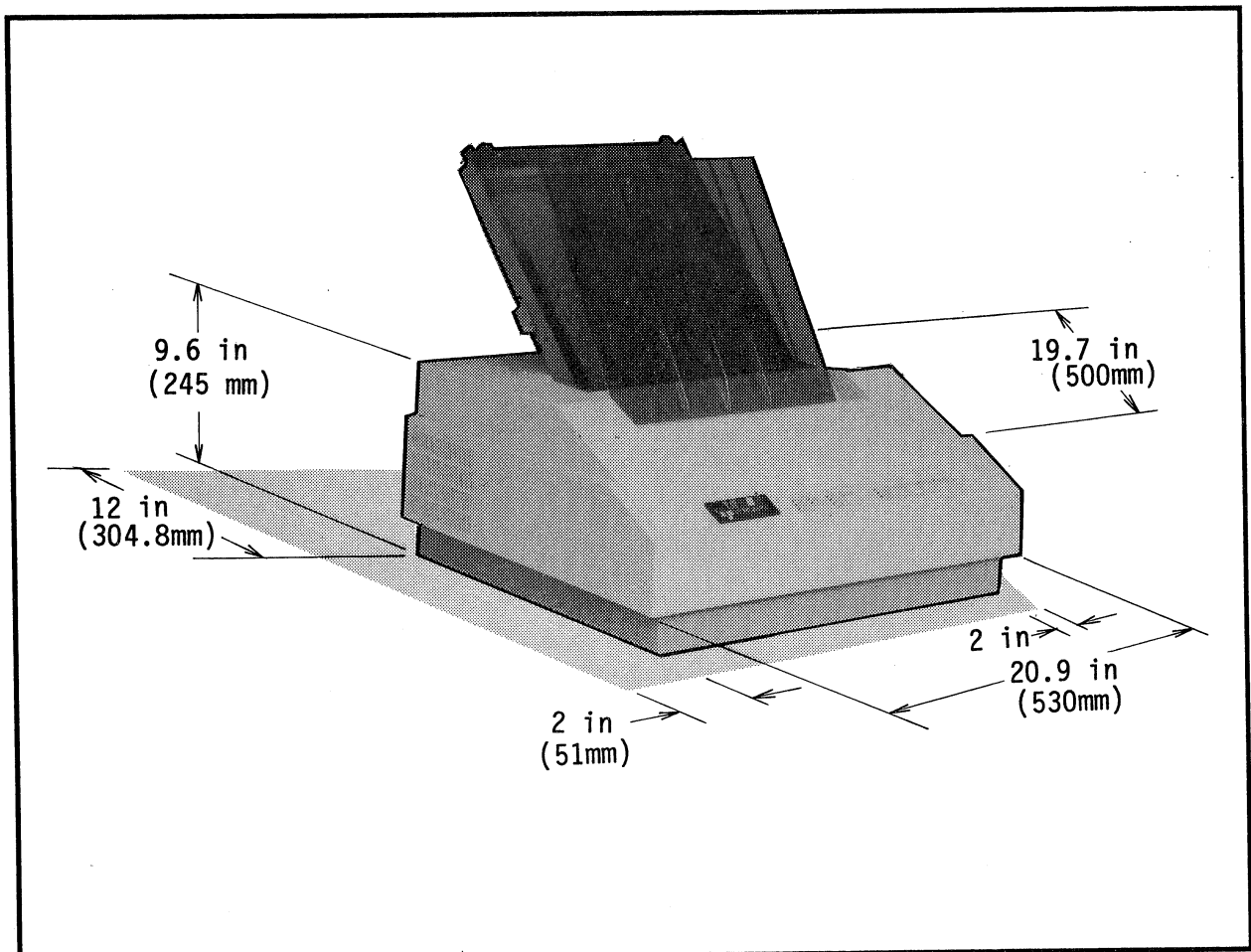

Figure 2-7. Plotter Dimensions and Space Requirements

### Conditions and Locations to Avoid . . .

- Under direct sunlight
- Near a heat-generating unit such as a stove or heater
- Direct exposure to an airstream from an air conditioner, heater or vent
- Places subject to sudden changes in temperature (when a cold room is suddenly warmed, moisture will condense on internal parts of the machine and cause defects in the output quality)
- Areas without sufficient space for adequate cooling (see *Space Requirements*)
- Areas subject to heavy dust or persistent vibrations

### PLOTTER CONNECTIONS

#### AC Power

**Caution:** *Prior to connecting ac power, verify that your plotter is configured for the correct input voltage, as described on page 2-5. Serious damage to the plotter will result if the input voltage selector is improperly set.*

1. Remove the warning sticker from the ac receptacle at the rear of the unit.
2. Verify that the power cord is plugged into the plotter's ac receptacle, shown in Figure 2-8, and the facility ac power receptacle.

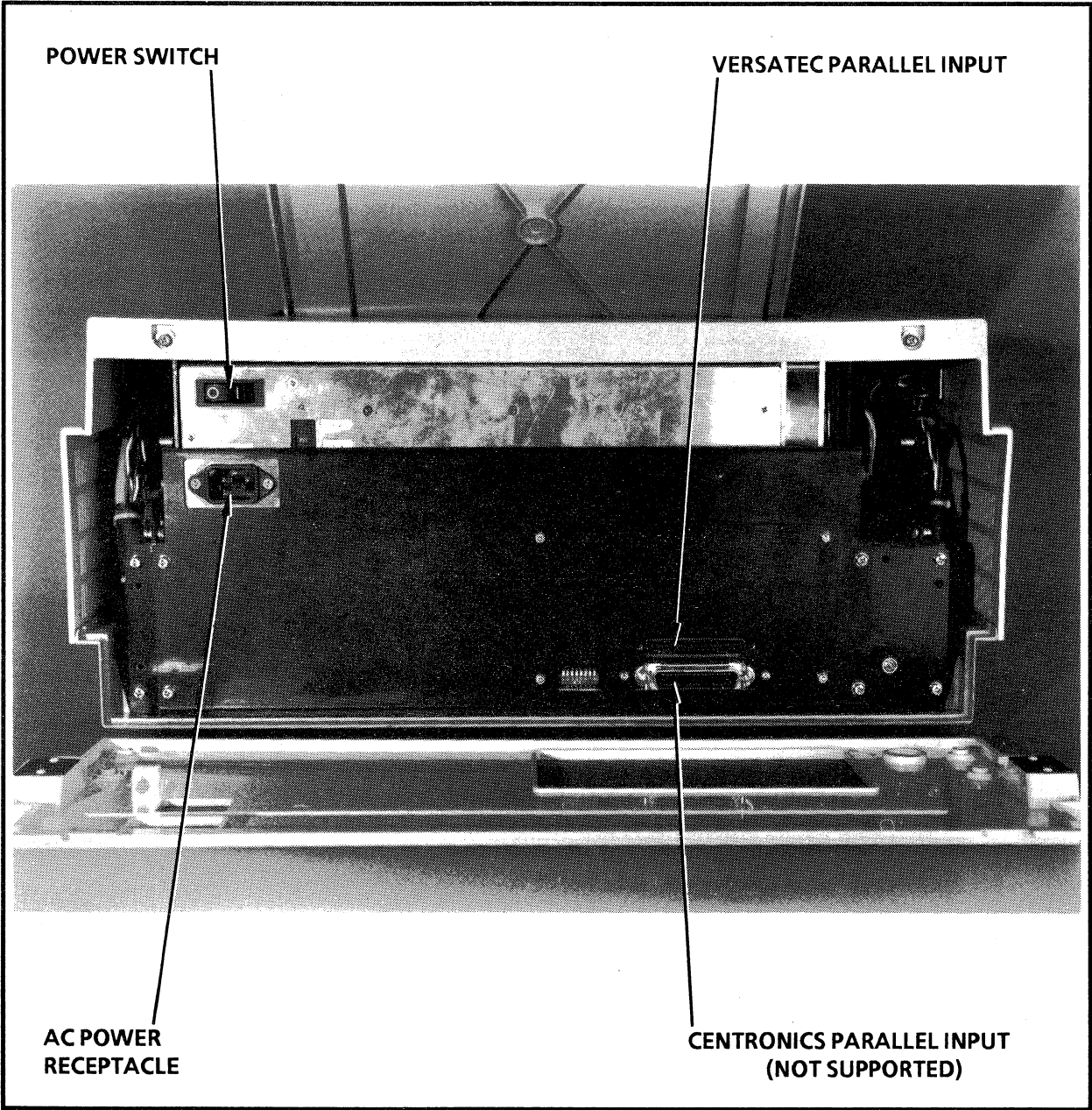

Figure 2-8. Power Entry Panel





## SECTION 3

# LOADING THE INK DONOR ROLL & MEDIA

This section provides the procedures to install or replace the ink donor roll and load media, either transparency film or paper, in your C2700 Series Thermal Transfer Color Plotter. The correct size and type of media and donor roll must be installed prior to plotter operation. Figure 3-1 shows the ink and media supplies necessary for plotting.

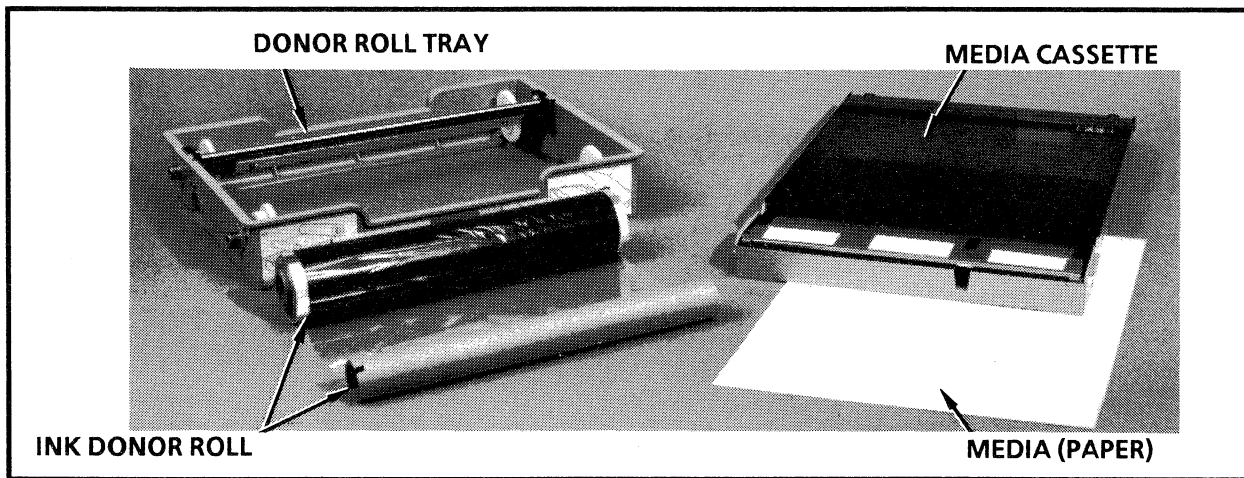

**Figure 3-1. Ink and Media Supplies (3-color, A3 size shown)**

Table 3-1 lists the plotting capacity and media size applications for the donor rolls available. Note that a 17-inch donor roll will accommodate A and A4 size media but an 11-inch roll cannot be used for the longer B and A3 sizes. See Appendix A, *C2700 Models and Options*, for donor roll part numbers.

**Table 3-1. Ink Donor Roll Specifications**

GENERAL SPECIFICATIONS	PLOTTING CAPACITY (Sheets)	APPLICABLE MEDIA SIZES
4-color (Y, M, C and B), 17-inch	125	A, B, A4, A3
4-color (Y, M, C and B), 11-inch	180	A, A4
3-color (Y, M and C), 17-inch	150	A, B, A4, A3
3-color (Y, M and C), 11-inch	210	A, A4
Monochrome black*	450 (17-inch) 630 (11-inch)	A, B, A4, A3 A, A4

\* (The same roll is used for 11- and 17-inch media.)

## INSTALLING THE INK DONOR ROLL

The following procedure covers first-time installation and subsequent replacements of the donor roll. The ink donor roll must be replaced whenever the color panels have been depleted (EOI indicator lamp lights and the black color panel appears at the end of the roll).

**Caution:** *This procedure must be performed in an area free of dust and dirt.*

1. Ensure the plotter is powered OFF (the control panel POWER lamp is not lit).
2. Pull the cover latch on the right side of the plotter chassis *up* and lift the top cover to access the interior of the plotter. Ensure the cover support is locked in place (Figure 3-2).
3. Standing at the front of the plotter, pull the donor roll tray guide up and then toward you using the guide lifters on each side of the tray guide (Figure 3-3).

**Note:** *If you are installing a donor roll for the first time, proceed to step 6.*

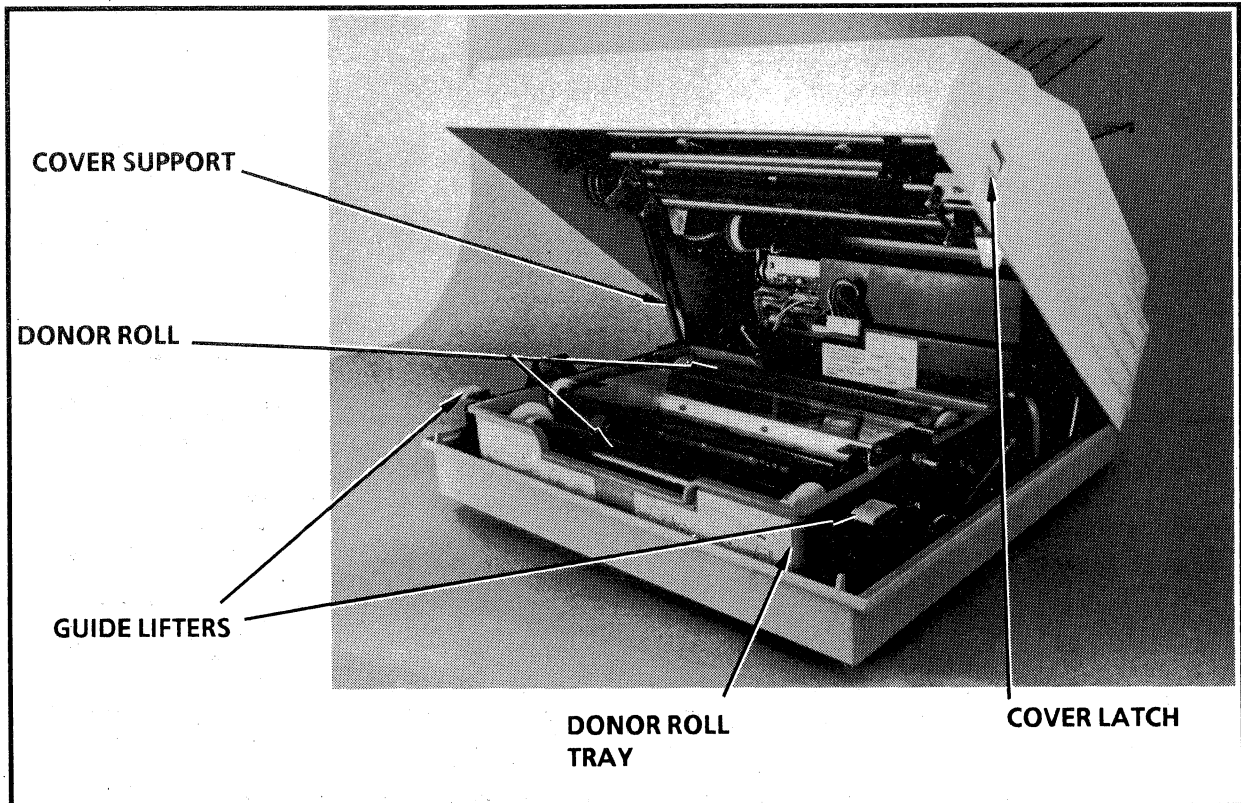

**Figure 3-2.** C2700 Thermal Plotter (Cover open)

4. Slide out the donor roll tray and set it on a flat, clean surface.
5. Remove the old donor roll by pushing the supply roll to the right and lifting it up and off of the spring-loaded roll hub. Remove the take-up roll in the same manner. Discard the used rolls.

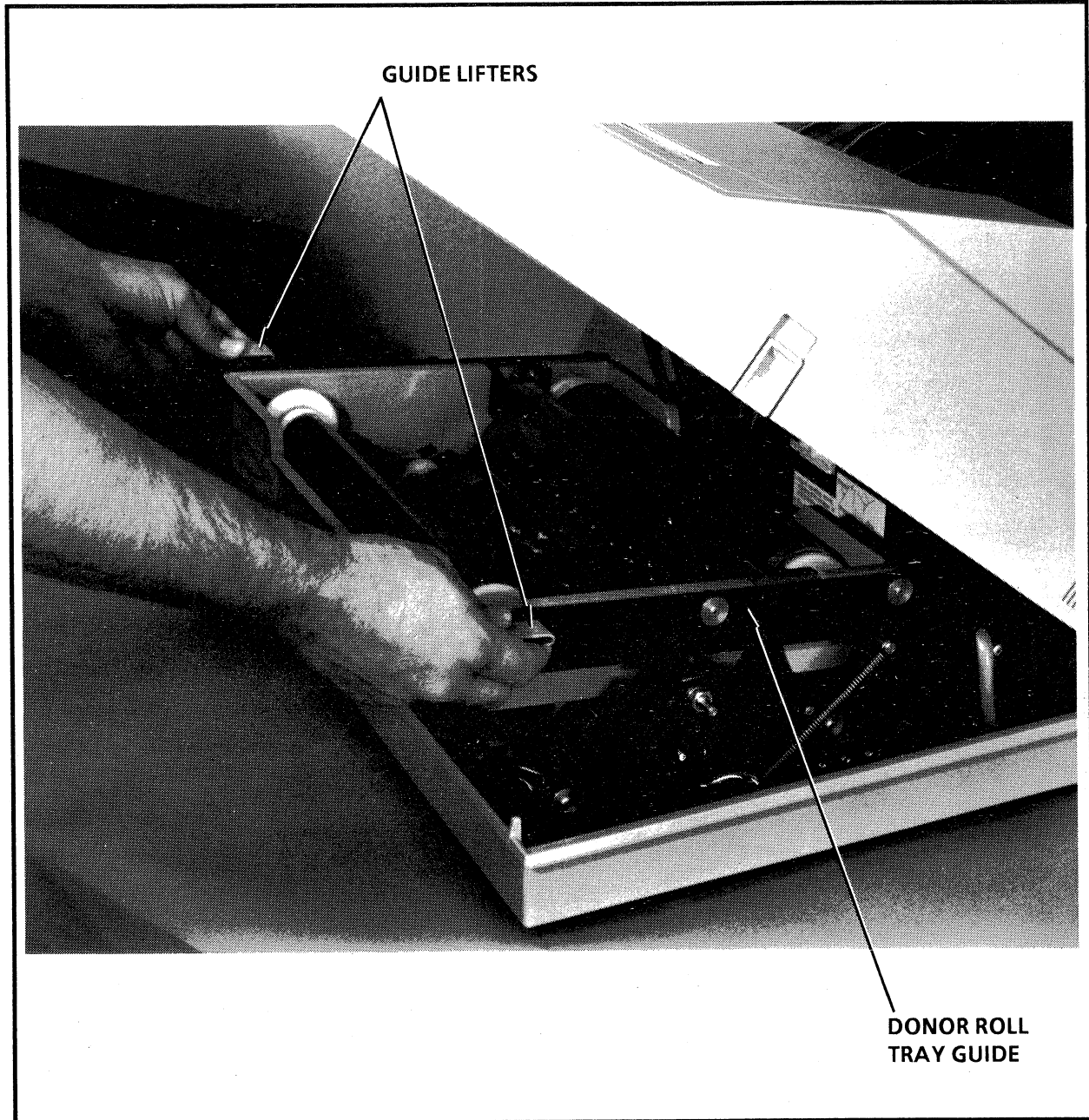

**Figure 3-3. Accessing the Donor Roll Tray**

6. Positioning the new ink donor roll as shown in Figure 3-4, press the right end of the supply roll onto the spring-loaded hub and slip the left end over the roll holder, ensuring the drive pin on the holder is aligned with one of the notches on the donor roll core (Figure 3-5).

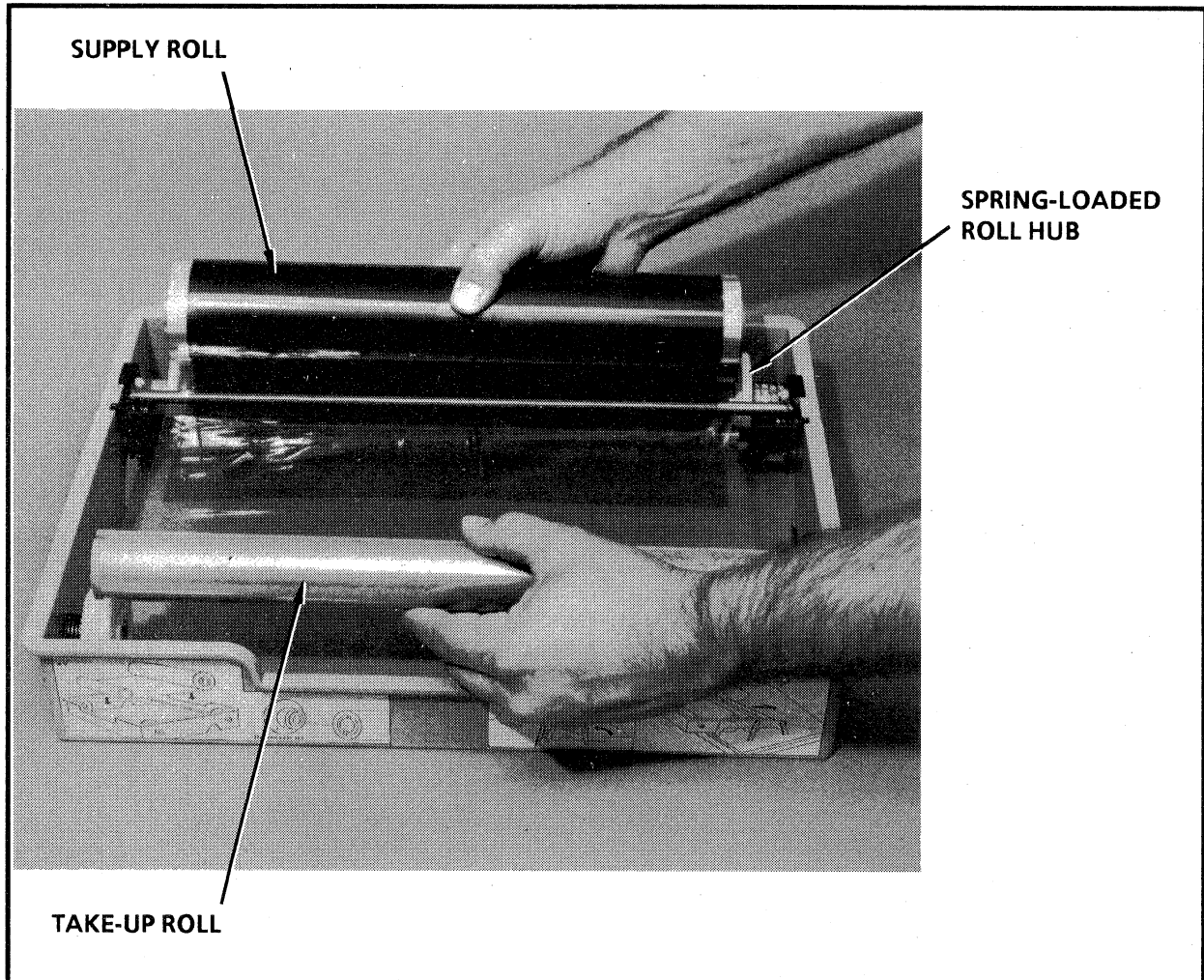

**Figure 3-4. Mounting the Ink Donor Roll**

7. Pull the take-up roll across the tray to the side labeled FRONT SIDE OF PRINTER and mount the take-up roll on the hub and roll holder as in step 6 above. Standing at the front of the tray, roll the top of the take-up roll *away* from you (clockwise as viewed from the right) to eliminate any slack in the sheet. See Figure 3-6.
8. Replace the loaded tray in the tray guide and, using both hands, lower the guide back into place using the guide lifters. The transparent leader should be stretched across the thermal printhead.

**Note:** *If installed properly, the donor roll should unwind from the bottom of the supply roll and wind onto the bottom of the take-up roll.*

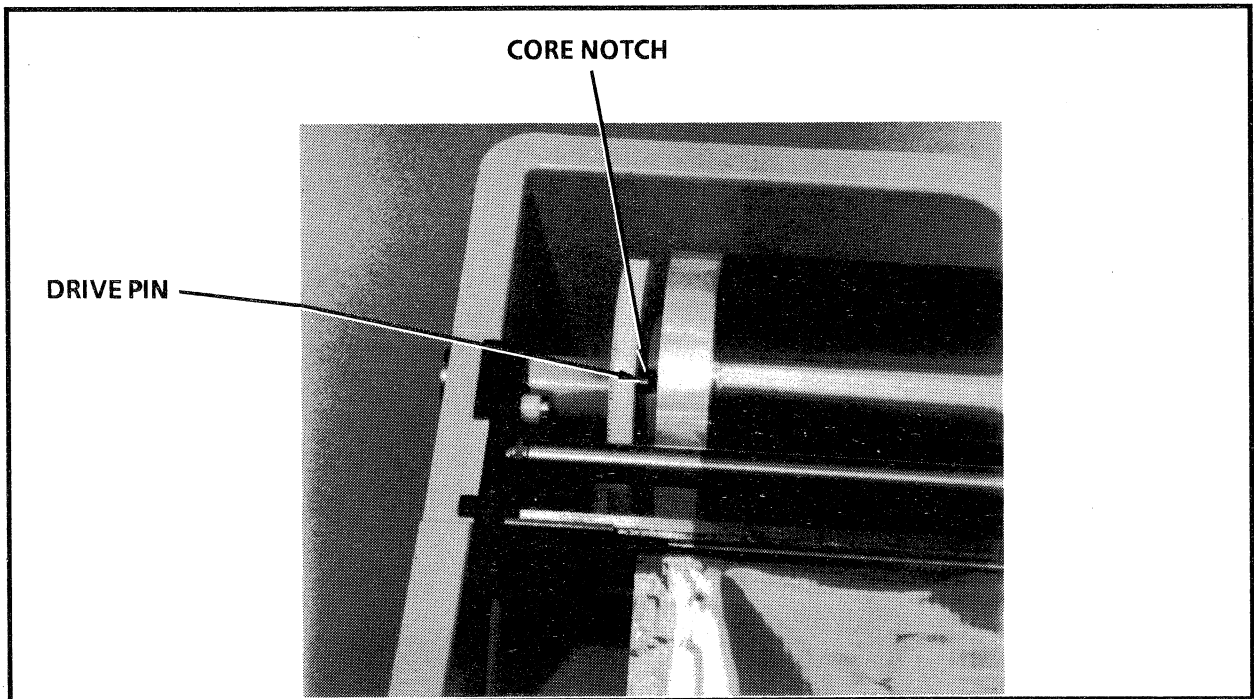

**Figure 3-5.** *Aligning the Donor Roll (Supply Side)*

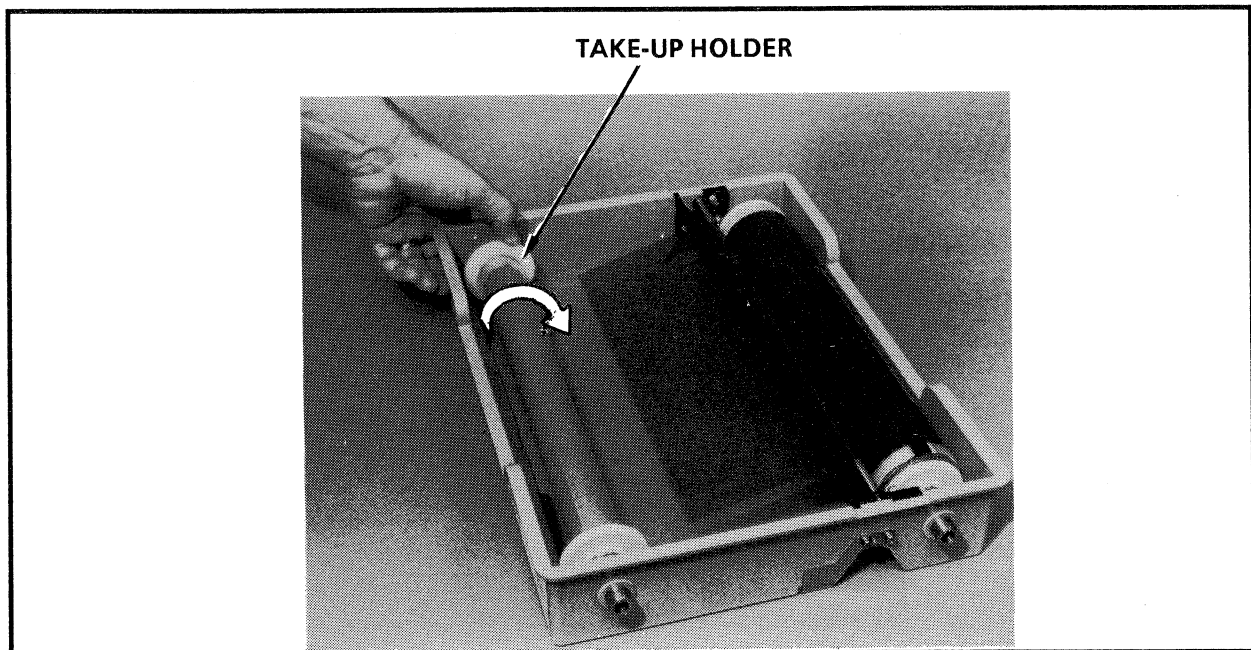

**Figure 3-6.** *Tightening the Donor Roll (Take-up Side)*

9. Ensure the donor roll tray and tray guide are properly seated by gently pushing down on them (Figure 3-7). The winding gear adjacent to the take-up holder should fully engage the smaller drive gear directly beneath it.

**Caution:** Do not pull the cover down abruptly or forcibly. Damage to the plotter may result.

10. Release the cover support and close the top cover securely. If the cover does not close easily (it should *click*), check that the donor roll tray is properly mounted in the tray guide.
11. Power ON the plotter. The plotter should automatically go ON LINE. If the EOI lamp still lights, check that the donor roll and donor roll tray are installed properly. If the lamp still does not extinguish, contact your local Versatec Service Representative for assistance.

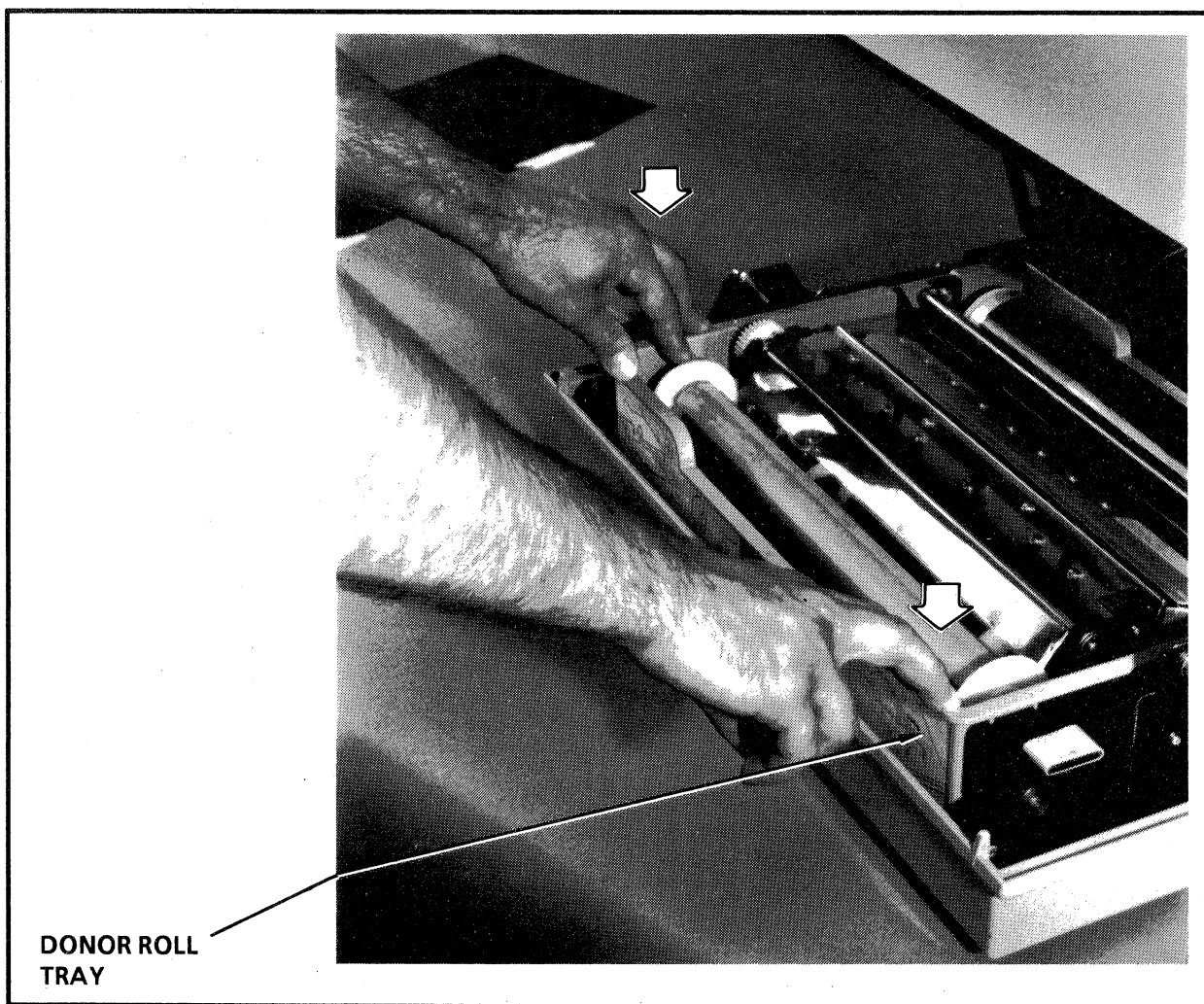

Figure 3-7. Seating the Tray and Tray Guide

## LOADING MEDIA (PAPER)

Media must be added whenever the media cassette is emptied of its paper or film. When the plotter is out of media the EOP lamp lights, indicating an out-of-media condition. If the media cassette is removed while the plotter is powered ON, the EOP lamp lights and the plotter automatically goes OFF LINE.

*Note: Use only Versatec-approved media in this plotter. Other media may yield inferior output quality or cause jamming.*

1. Lift the media cassette from its mounting slot and set it on a flat, clean surface. Refer to Figure 3-8.
2. Open and remove the cassette cover (Figure 3-8).

*Note: Do not put more than 150 sheets (approximately 0.44 in/11.2 mm thick) of paper in the media cassette at one time. A line indicating the maximum allowable paper level is located inside the cassette (Figure 3-8).*

If you need to exchange media (from paper to film or vice versa), simply remove any media remaining in the cassette and continue with this procedure.

3. Before loading paper, fan the edges of the pad to prevent the sheets from sticking together.

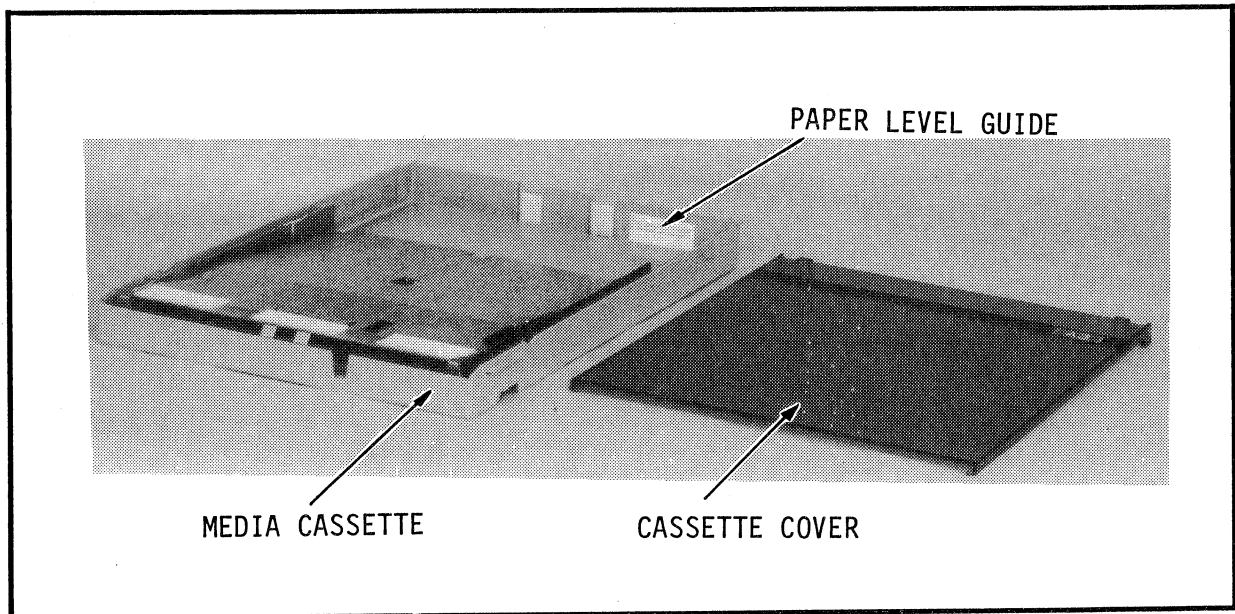

Figure 3-8. Media Cassette



## LOADING THE INK DONOR ROLL AND MEDIA

**Note:** *If you are using paper, either side is suitable for plotting.*

4. Install the paper in the media cassette. Make sure the media retainers are both sitting on top of the paper stack (Figure 3-9).

**Note:** *When installing the paper, it is not necessary to use the lever.*

5. Attach the cover to the media cassette and close.
6. Insert the media cassette into the media cassette mounting slot in the plotter chassis. Make sure it locks into place.
7. Check that the media stacker is mounted in place. Refer to Figure 3-10.
8. Press ON LINE. If the EOP lamp is still lighted, verify that the media cassette is installed correctly. If the lamp still does not extinguish, contact your local Versatec Service Representative for assistance.

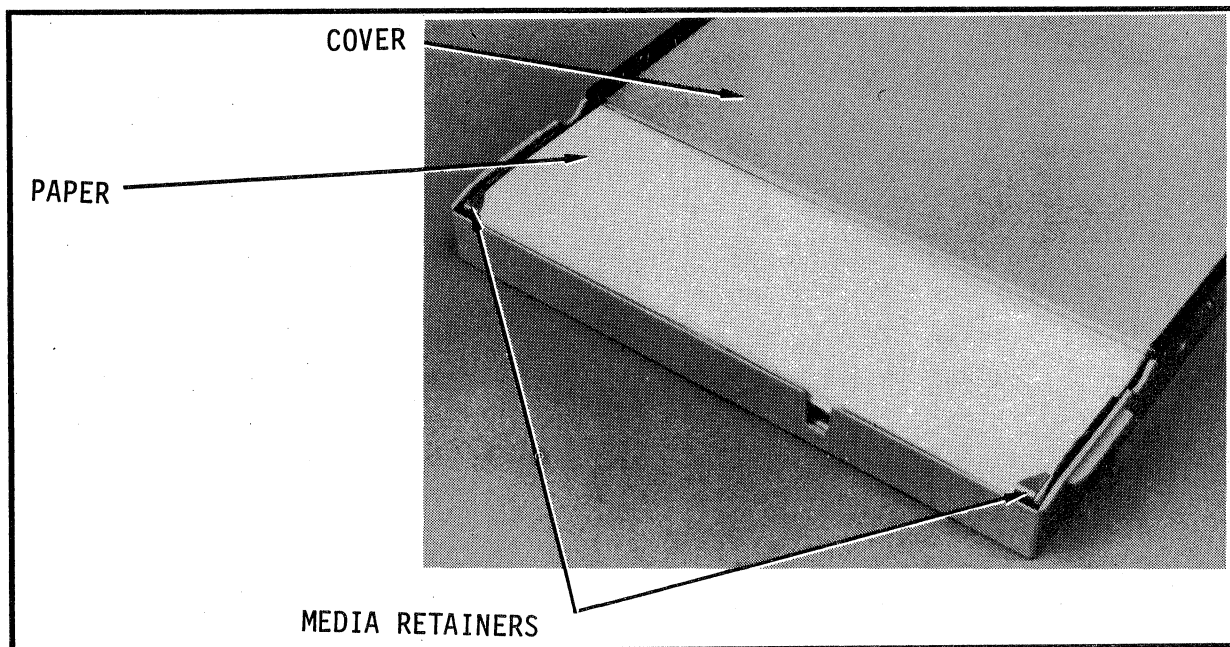

**Figure 3-9. Loading Paper**

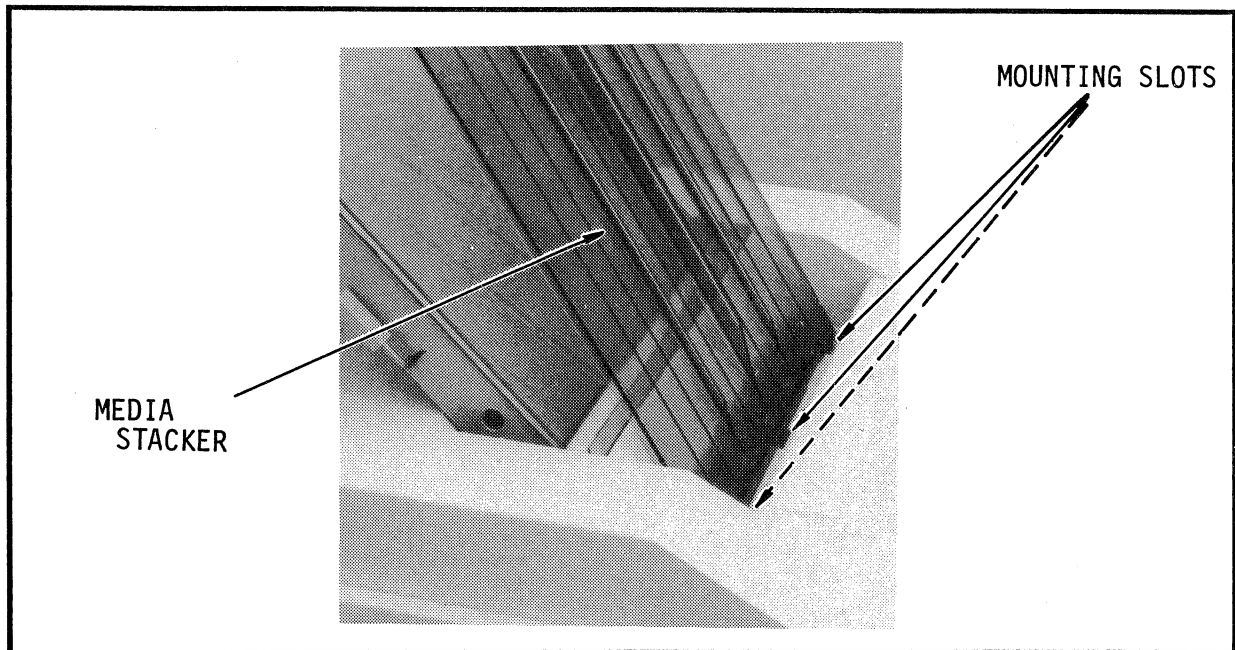

**Figure 3-10. Media Stacker**

Once the ink donor roll and media have been correctly installed, the plotter should be ready for operation. It is suggested that you familiarize yourself with the operator controls and indicators described at the beginning of Section 4, *Operating Instructions*, and perform the operational checkout.

## LOADING THE INK DONOR ROLL AND MEDIA

### LOADING MEDIA (TRANSPARENCY FILM)

1. Prepare the media cassette with the lever (Figure 3-11).

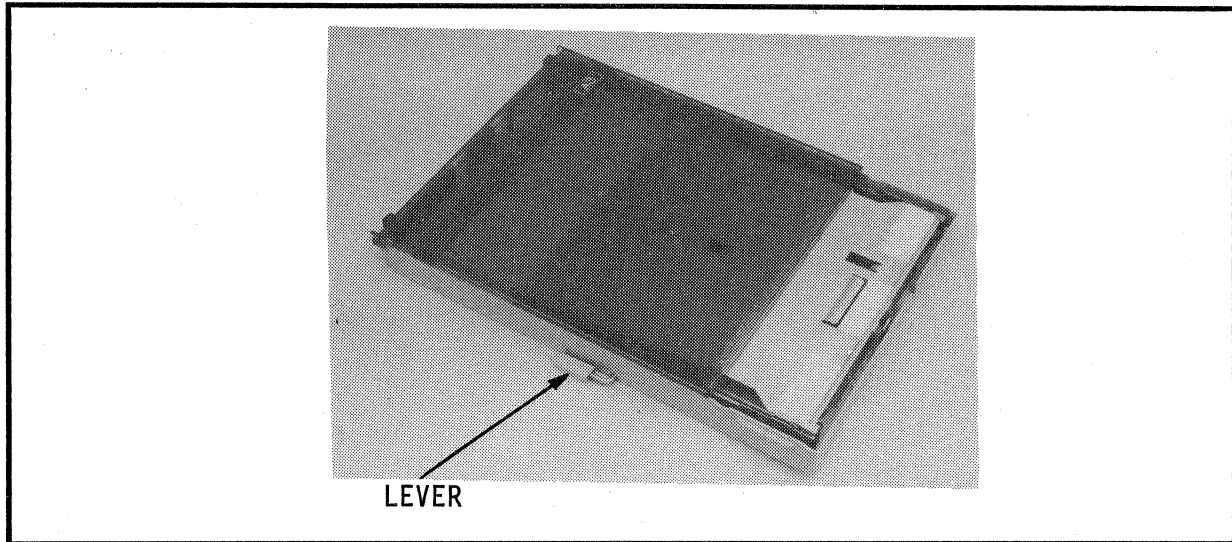

**Figure 3-11. Media Cassette**

2. Remove the cassette cover.
3. Insert the media cassette into the media cassette mounting slot in the plotter chassis. Make sure it locks into place.

**Note:** *Do not attach the cover to the media cassette.*

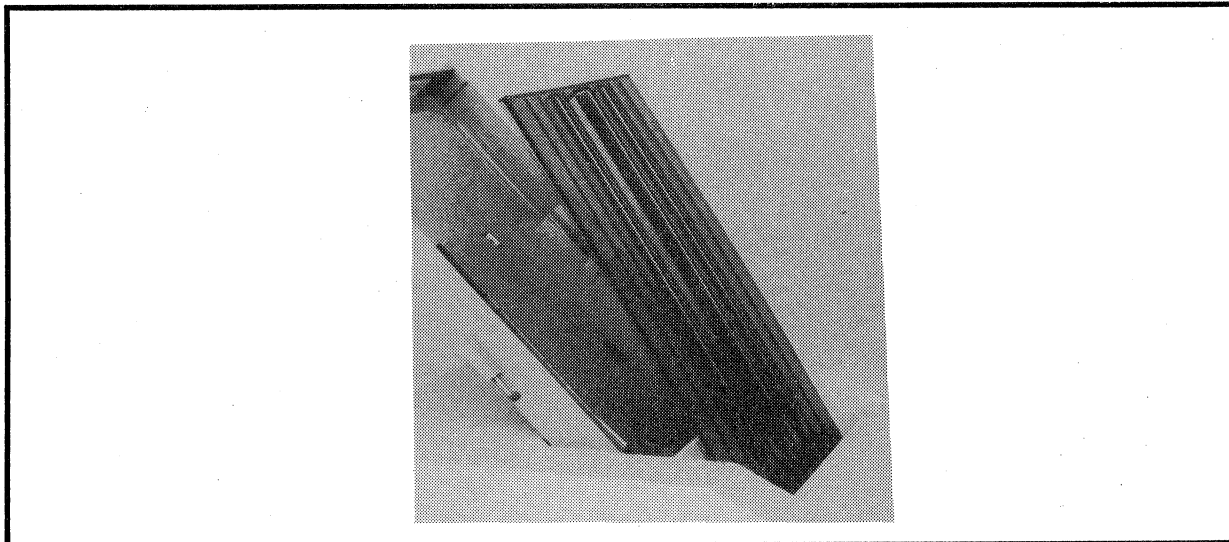

**Figure 3-12. Inserting the media cassette**

*LOADING THE INK DONOR ROLL AND MEDIA*

4. Before loading transparency film, remove the protective tissue from each sheet.
5. Lift up the lever of the media cassette and a metal plate in the paper cassette goes down. Refer to Figure 3-13.

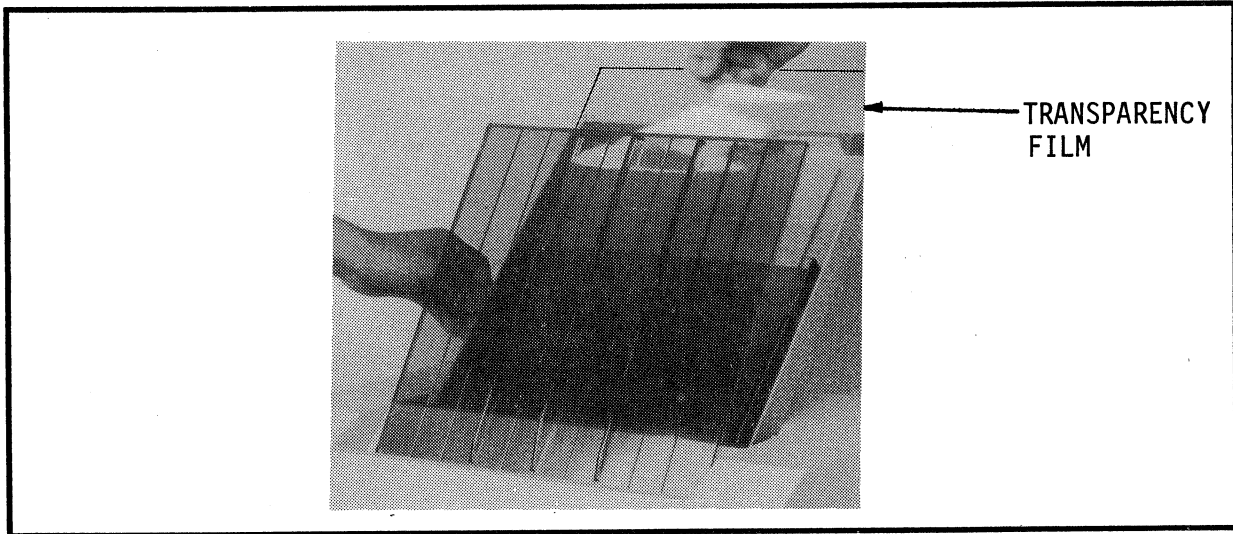

**Figure 3-13.**

6. The film must be oriented such that the size label (i.e., A3) at the top of the sheet is at the bottom left-hand corner of the media cassette (i.e., upside down and backwards). Refer to Figure 3-14.

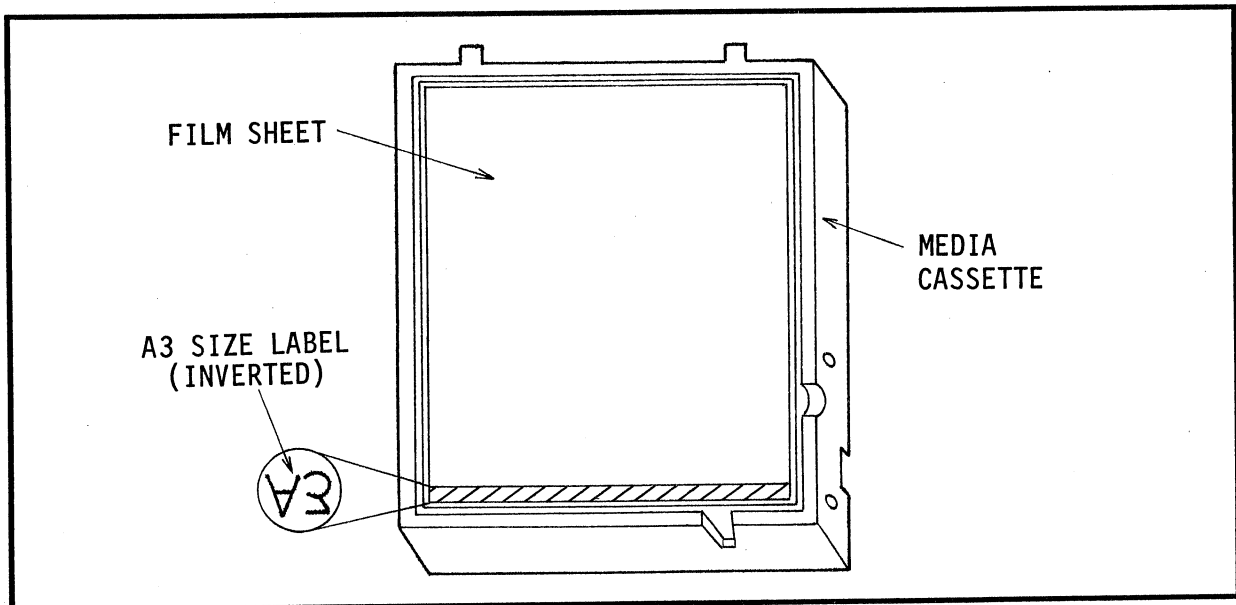

**Figure 3-14. Orienting Film in the Media Cassette (A3 size)**

*LOADING THE INK DONOR ROLL AND MEDIA*

7. Install the transparency film in the media cassette. Make sure the media retainers are both sitting on top of the transparency film. Release the lever of the media cassette, and the metal plate in the paper cassette lifts up.

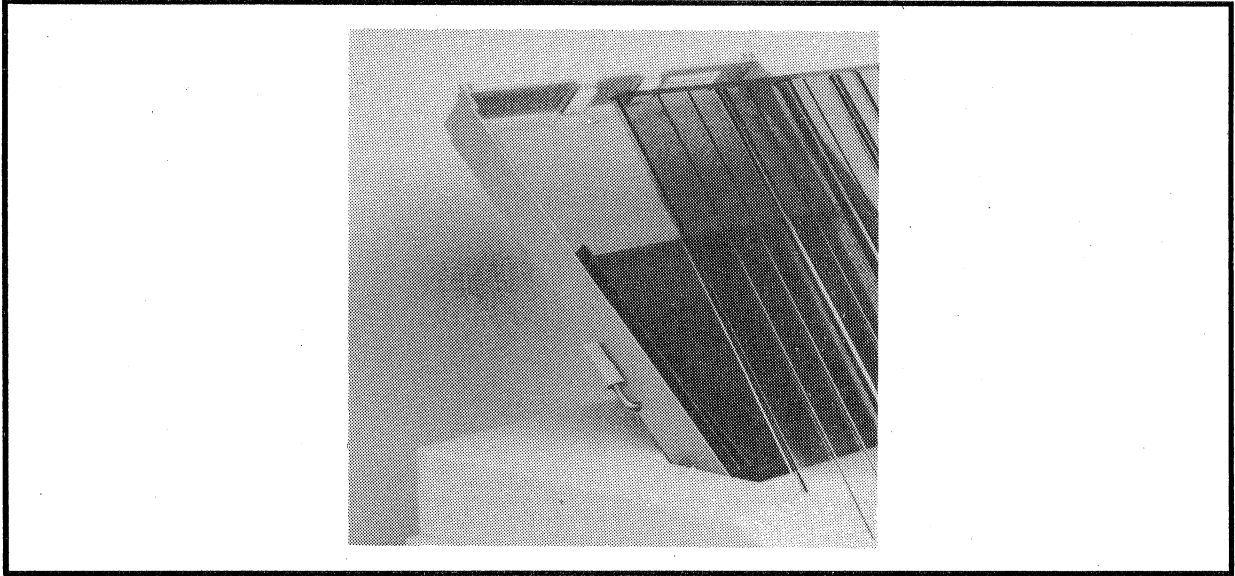

**Figure 3-15. Loading Transparency Film**

8. Be sure to remove each sheet as it is ejected onto the media stacker. Otherwise, static attraction will cause subsequent sheets to adhere and possibly result in a jam.

# SECTION 4 OPERATING INSTRUCTIONS

This section contains the information and instructions needed to produce a hard copy (or *plot*) of graphic data using your C2700 Series Thermal Transfer Plotter.

## CONTROLS AND INDICATORS

The plotter control panel is shown in Figure 4-1. Table 4-1 provides a functional description of the control switches and plotter status indicators.

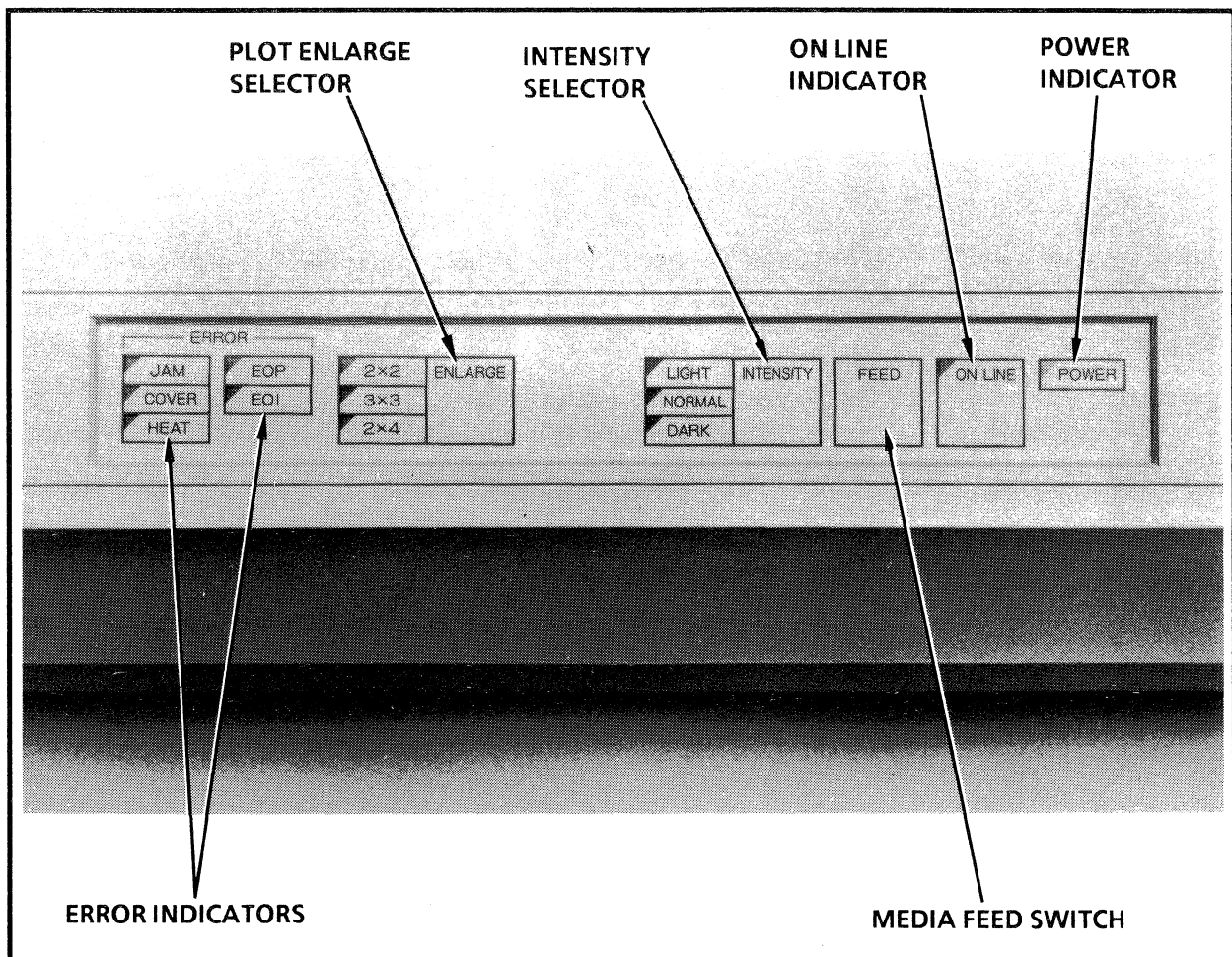

Figure 4-1. C2700 Control Panel

Table 4-1. Control Panel Description

SWITCH / INDICATOR	FUNCTION(S)
<b>POWER</b>	Lights when the plotter is connected to facility power and the power switch on the plotter's rear panel is set to ON.
<b>ON LINE</b>	The plotter assumes ON LINE status when this switch is pressed (lamp lights). When the plotter is ON LINE it is connected to and communicating with a host computer. If pressed again, the plotter goes OFF LINE ( lamp extinguishes).
<b>FEED</b>	When this switch is pressed, the plot is moved out to the media stacker (operational only in OFF LINE mode).
<b>INTENSITY</b>  <b>LIGHT</b>  <b>NORMAL</b>  <b>DARK</b>  <b>LINE INTENSITY</b>	<p>The plot density may be changed when this switch is pressed. It is switchable only when the plotter is OFF LINE.</p> <p>For lighter density output</p> <p>Normal density; the power-on default setting</p> <p>For denser, more color-intense output</p> <p>When <i>no</i> lamps are lit, LINE INTENSITY mode is enabled. This mode is recommended only for plots primarily consisting of lines or cross-hatching.</p>
<b>ENLARGE</b>   <b>2 × 2</b>  <b>3 × 3</b>  <b>2 × 4</b>	<p>Image enlargement; switchable only when the plotter is OFF LINE. When <i>no</i> lamps are lighted, the default setting of 1 × 1 (no magnification) is enabled.</p> <p>× 2 magnification in x- and y-directions</p> <p>× 3 magnification in x- and y-directions</p> <p>× 4 magnification in the x-direction (direction of paper travel) and × 2 magnification in the y-direction.</p>
<b>ERROR</b>  <b>EOP</b>   <b>EOI</b>  <b>JAM</b>  <b>COVER</b>      <b>HEAT</b>	<p>Lamp lights when the media cassette runs out of paper or film. If the media cassette is removed when the plotter is powered ON, the plotter automatically goes OFF LINE.</p> <p>Lamp lights when the ink donor roll is depleted</p> <p>Lamp lights when the media or donor roll has jammed</p> <p>Lamp lights when the plotter cover is opened.</p> <p><i>Note: Do not open the cover during operation. When the cover is opened during plotter operation, the plotter automatically goes OFF LINE. When it is closed again, the plotter remains OFF LINE and reverts to its power-on defaults.</i></p> <p>Lamp lights when the head temperature becomes abnormally high or low.</p>

## OPERATING INSTRUCTIONS

**Note:** *The POWER switch at the rear of the plotter is used to power the plotter ON and OFF. Pressing the switch to the '1' position powers ON the plotter. Pressing it to the '0' position powers it OFF. When the power is ON the POWER indicator (green lamp) on the front panel is lit.*

1. Ensure the power cord is connected at the rear of the plotter (Figure 4-2) and to a *live* facility ac power outlet.
2. Press the POWER switch (shown in Figure 4-2) to power ON the plotter. When the plotter is powered ON, the POWER and NORMAL (INTENSITY) indicators on the control panel light. The ON LINE indicator lights approximately two seconds after power-up, letting you know the plotter is ready to accept host commands and plot data.
3. If none of the indicators light as described above, perform steps (a) through (c) below:
  - a) Power OFF the plotter.
  - b) Verify the plotter is properly connected to facility ac power and that there is power supplied to that outlet.
  - c) Power ON the plotter again. If the indicators still do not light properly, power OFF the plotter and report the problem to your Versatec Service Representative.

**Note:** *To run the diagnostic self test, refer to Test Plot on page 4-6 of this section.*

4. Once the ON LINE indicator is lit, the plotter is ready for operation. While a plot is being run, the ON LINE indicator remains lit. When running a plot, the plotter cannot be switched OFF LINE, indicating *the plotter is busy*.

**Note:** *The INTENSITY switch (shown in Figure 4-1) on the control panel is typically set to NORMAL. Once a plot has been run, you may wish to adjust plot color intensity using this control. The plotter must be switched OFF LINE to accomplish this.*



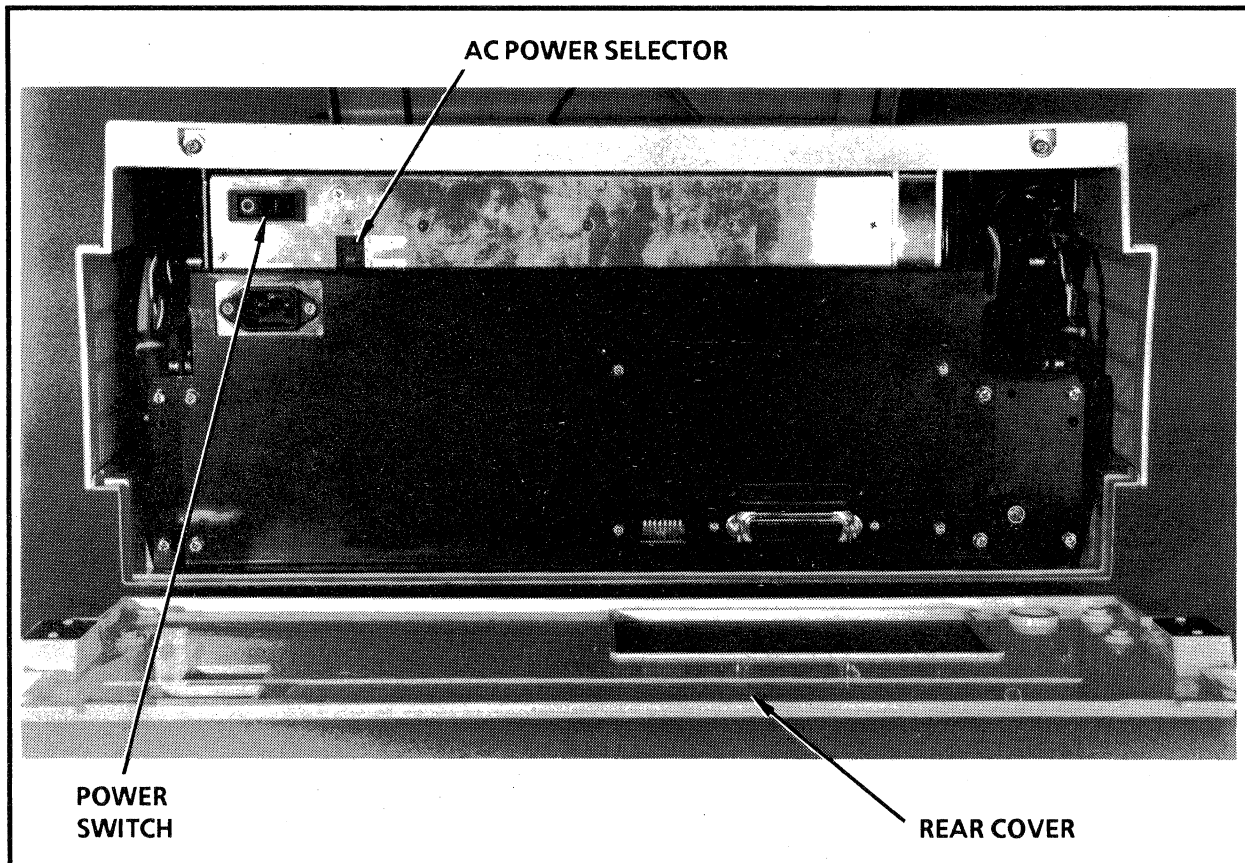

Figure 4-2. Power Entry Panel (*Rear Cover Removed*)

## MONOCHROME PLOTTING

To produce monochrome plots, you may use any of the three donor rolls available (monochrome black, 3-color or 4-color).

### Monochrome Black Donor Roll

If you wish to plot in monochrome black, simply follow the installation instructions in Section 3, *Loading the Ink Donor Roll and Media*, to load the monochrome black donor roll.

### 3- and 4-Color Rolls

To use the multicolor donor rolls for monochrome plotting, it is necessary to configure the Color Header Preamble *escape sequence* to select the desired plot color. Escape sequences and their functions are described in Appendix B, *Plotter Control Functions*, of this guide.

## SETTING THE PLOT MARGINS

The top and left margins may be manually adjusted by setting two rotary switches located at the front of the plotter inside the top cover. A small blade screwdriver is necessary to make these adjustments.

1. Pull the cover latch on the right side of the plotter chassis *up* and lift the top cover. Ensure the cover support is locked in place.
2. Facing the front of the plotter, locate the two rightmost rotary switches in the top cover as shown in Figure 4-3. The two leftmost switches are not used.

**Note:** Both margin switches are normally set to zero. This corresponds to a 7/8-inch (22.2 mm) top margin and a 3/16-inch (4.8 mm) left margin.

3. To set the top margin, select one of the ten positions (0 to 9) on the rightmost rotary switch as shown in Figure 4-3. Each division corresponds to approximately 0.5 inch (12.7 mm).
4. To set the left margin, select one of the ten positions (0 to 9) on the second rotary switch from the right as shown in Figure 4-3. Each division corresponds to approximately 0.5 inch (12.7 mm).

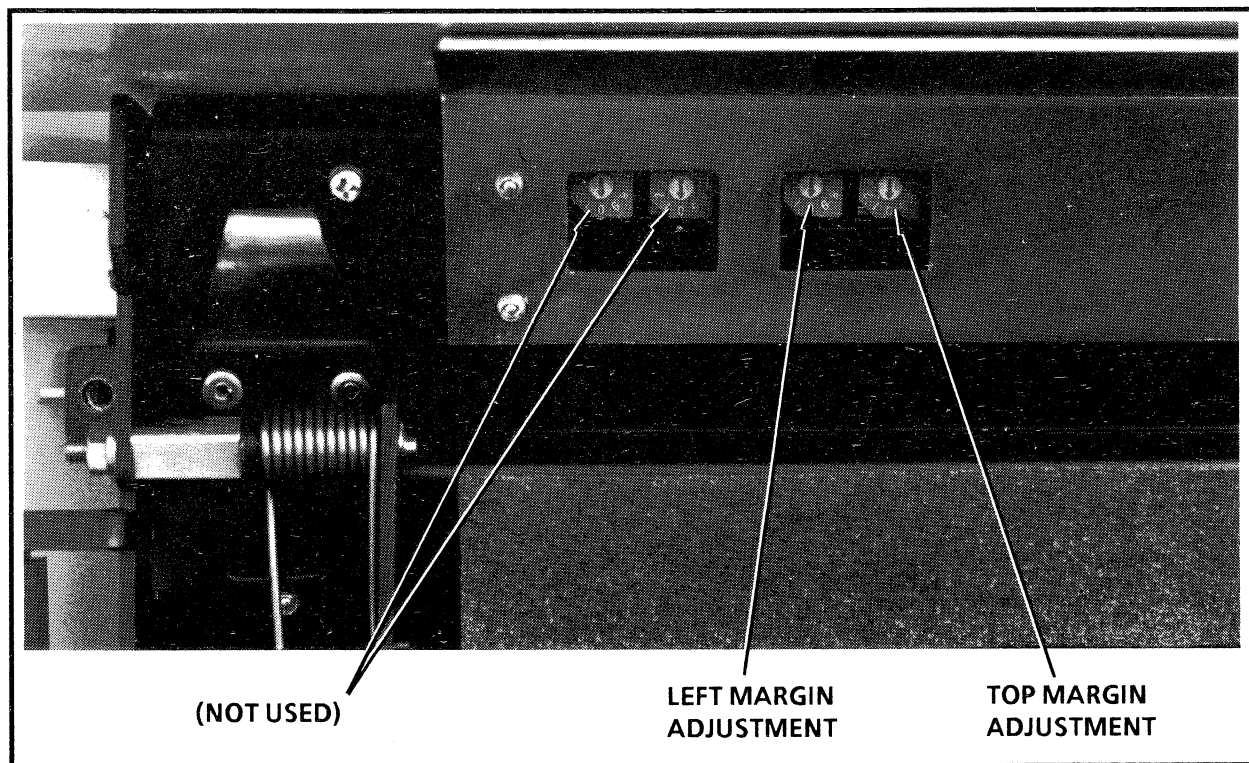

Figure 4-3. Rotary Switch Settings

## TEST PLOT

The C2700 test plot is a diagnostic self-test that helps the user or service person verify proper plotter performance, or identify problems such as misregistration or dirt on the thermal printhead. An A size copy of the test plot bearing the plotter serial number is included with your unit for reference. The following describes how to generate a test plot:

**Note:** *The INTENSITY and ENLARGE functions cannot be adjusted for the test plot. The test plot is always generated at NORMAL intensity and without magnification.*

1. Power the plotter OFF.

**Note:** *The C2700 plotter runs the test plot in OFF LINE mode.*

2. While depressing the FEED switch on the front panel, power the plotter ON and release the switch after about three seconds. The plotter will produce the standard test plot and continue to generate plots until the INTENSITY switch is pressed, at which time the plotter will complete the plot in progress and stop.
3. Compare the output with the test plot included with your unit.

If the ENLARGE switch is pressed while a test plot is in progress, the plotter immediately stops plotting. When ENLARGE is pressed again, the plotter automatically resumes plotting.

**OPERATIONAL CHECKOUT**

Step-by-step instructions are given below to verify proper operation of the plotter with the donor roll and media installed.

1. Ensure the plotter system connections have been made (plotter-controller-host computer).
2. Ensure the media has been loaded as described in Section 3, *Loading the Ink Donor Roll and Media*.
3. Open the top cover of the plotter and ensure the ink donor roll has been installed as described in Section 3, *Loading the Ink Donor Roll and Media*. Close the cover securely.
4. Initiate the test plot by depressing the FEED switch on the front panel, holding it down while powering the plotter ON. Release after about 3 seconds. Press INTENSITY to terminate test plot mode. Compare the plot output with the color example provided with your unit.
5. Verify all plotter switch/indicators show normal *power on* plotter status.

## WHAT TO DO IF THERE IS NO PLOTTER OUTPUT

If a file sent from the host is not successfully output to the plotter, check the following:

**Note:** *Only the Versaplot Color Random host software supports the C2700 thermal plotter at this time through Versatec's Parallel interface.*

- All external cable interconnections are properly keyed and secure.
- Power has been supplied to all hardware: host CPU, controller (if present) and the plotter.
- The top access cover is fully closed.
- Plotter is ON LINE and ready to receive plot data.
- Plotter is not out of media (EOP lamp lights) or the donor roll is not depleted (EOI lamp lights).
- The media or ink donor roll has not jammed (JAM lamp lights).
- If you are using the Versatec Parallel interface\*, check that Versaplot Color Random software has been installed in the host system.

After verifying the above requirements, try to output a VDS/plot file to the plotter again.

If you are still unable to successfully output a plot, try to identify and correct the problem using the troubleshooting guide in Section 6, *In Case of Difficulty*, before contacting your Versatec Service Representative for assistance.

\*As opposed to the Centronics Parallel interface

## SECTION 5

# PERIODIC MAINTENANCE

This section provides the operator with the preventive maintenance procedures helpful in assuring trouble-free performance from C2700 Series Thermal Plotters. As a plotter operator, it is your responsibility to ensure the plotter is kept full of media and equipped with a donor roll and to thoroughly clean the thermal printhead and roller surfaces on a regular basis. The procedures to install/replace the ink donor roll and load media are described in Section 3, *Loading the Ink Donor Roll and Media*. Information regarding Versatec's equipment warranty is also included at the end of this section.

### SAFETY PRECAUTIONS

High voltages are used in the operation of this equipment. If the following safety precautions are not observed while working with the plotter, personal injury and/or damage to the equipment may result.

**Warning:** *The thermal printhead is a high temperature area. Even though the plotter is designed to turn off the voltage to this component and disable the media feed any time the plotter lid is raised, ensure the plotter is powered OFF prior to cleaning or touching this area or removing any external cables leading to the unit.*

**Caution:** *Do not permit jewelry, ties, scarfs, or other objects to be caught or dropped into the machinery while working around the plotter. Long hair should be tied back when performing plotter maintenance.*

**Caution:** *Never attempt to repair the plotter yourself. High temperatures are present inside the unit enclosure. If repair is required, notify your local Versatec service office and a trained technician will be sent to determine the cause of any problem(s) you are experiencing in using the equipment.*

**PERIODIC PLOTTER MAINTENANCE**

The frequency of performing plotter maintenance is determined by actual plotter use; however, to ensure optimum plot output, follow the recommended maintenance schedule in Table 5-1.

**Table 5-1. Periodic Maintenance Schedule**

MAINTENANCE TASK	FREQUENCY	PROCEDURE
Replace Ink Donor Roll	As Needed	Section 3, Page 3-2
Load Media	As Needed	Section 3, Page 3-7
Check and clean (if necessary) Separator Turnbar	As Needed	Page 5-4
Clean Thermal Printhead	Each time the donor roll is changed	Page 5-4
Check and Clean (if necessary) Platen Roller	As Needed	Page 5-6
Check and Clean (if necessary) Pinch Rollers	As Needed	Page 5-7
Check and Clean (if necessary) Donor Roll Winding Roller	As Needed	Page 5-7
Clean Plotter Exterior	As Needed	Page 5-8
Clean Dust From Inside of Plotter	Once per week	Page 5-8

## CLEANING SUPPLIES

The accessory kit contains a thermal head cleaner to be used for cleaning the surface of the thermal printhead. The head cleaner is shown in Figure 5-1.

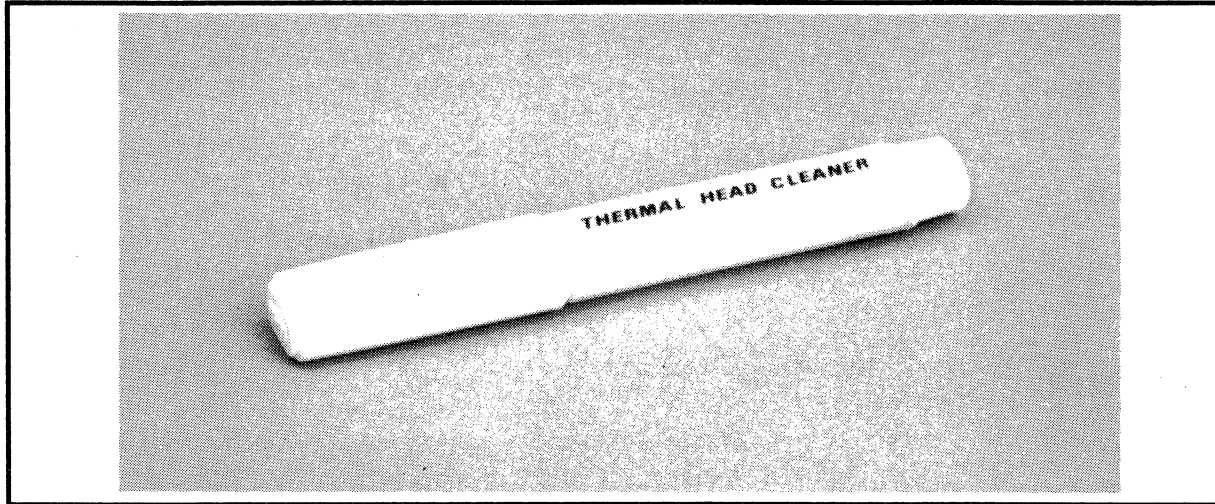

**Figure 5-1. Thermal Head Cleaner**

A supply of alcohol and lint-free wipes or cloth are necessary to properly clean the rubber rollers inside the plotter.

## CLEANING PROCEDURES

**Caution:** *After cleaning, allow all components to dry thoroughly before plotting is resumed.*

### Getting Ready

1. Ensure the plotter is powered OFF (control panel POWER indicator is not lighted).
2. Remove the media cassette and media stacker.
3. Pull the cover latch on the right side of the plotter chassis *up* and, using both hands, lift the top cover to access the interior of the plotter. Ensure the cover support is locked in place.
4. Standing at the front of the plotter, pull the donor roll tray guide up and then toward you, using the lifters at the front of the guide.
5. Lift out the donor roll tray and set it aside.
6. Lower the donor roll tray guide back into place.



### **Cleaning the Separator Turnbar** (shown in Figure 5-2)

**Note:** You should perform steps 1 through 6 under Getting Ready (on page 5-4) prior to cleaning the separator turnbar.

1. Locate the separator turnbar (Figure 5-2).
2. Moisten a clean cloth or lint-free paper wipe with alcohol.
3. Wipe the turnbar along its full length to remove any accumulated dust or dirt residue.
4. Allow the turnbar to dry thoroughly.
5. Clean the thermal printhead as instructed below.

### **Cleaning the Thermal Printhead** (shown in Figure 5-2)

**Note:** You must perform steps 1 through 6 under Getting Ready to access the thermal printhead.

**Caution:** Use only the thermal head cleaner provided in the accessory kit to clean the thermal printhead. Alternate cleaning devices or supplies may damage the head. Also, do not use the head cleaner for parts other than the thermal printhead.

*Do not exert excessive pressure on the printhead while cleaning.*

1. Wipe the surface of the thermal head gently with the head cleaner using back and forth strokes along the full length of the head. Repeat until dust particles and ink residue have been removed.
2. Resume plotting only after the head surface has thoroughly dried.
3. Clean the platen roller as instructed in the next paragraph.

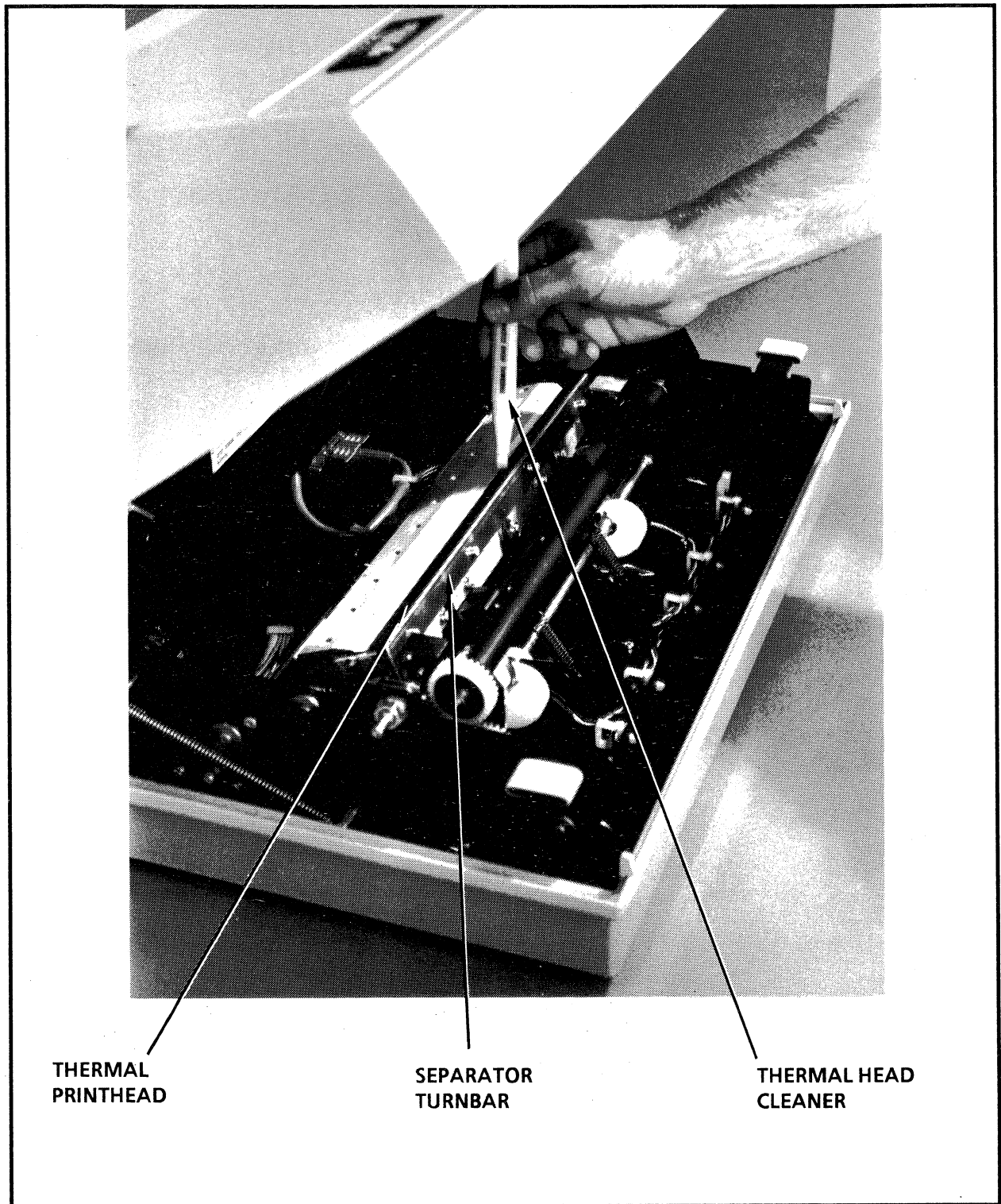

Figure 5-2. Cleaning the Thermal Printhead

### Cleaning the Platen Roller (shown in Figure 5-3)

**Note:** You should perform steps 1 through 6 under Getting Ready (on page 5-4) prior to cleaning the platen roller.

1. Locate the platen roller inside the plotter cover (Figure 5-3).
2. Moisten a clean cloth or lint-free paper wipe with alcohol.
3. Wipe the roller back and forth along its length, using the platen wheel to rotate the roller (Figure 5-3). Repeat this process until all residue has been removed.
4. Allow the roller to dry thoroughly.
5. Clean the pinch rollers as instructed in the next paragraph.

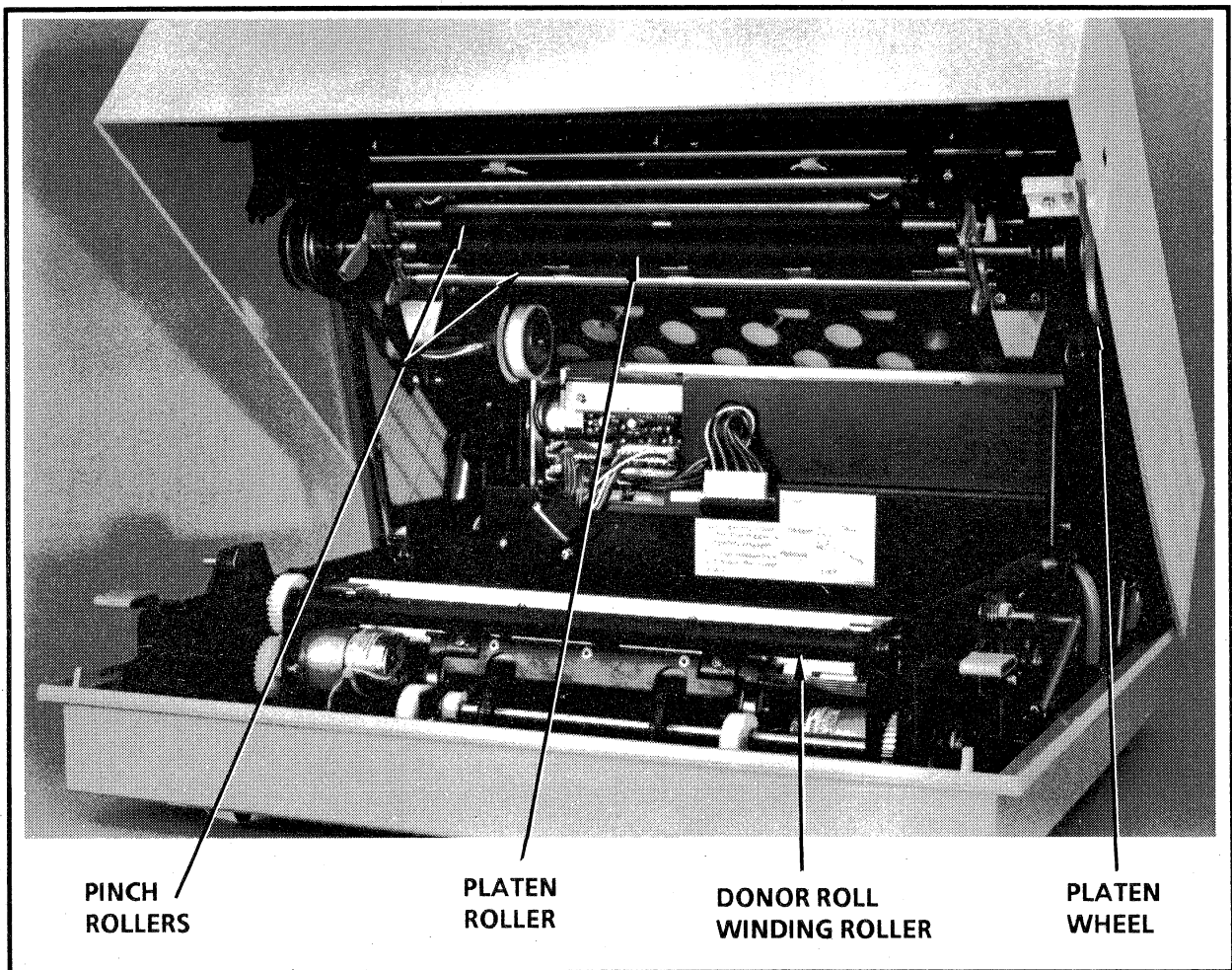

Figure 5-3. Platen Roller, Pinch Rollers and Donor Roll Winding Roller

**Cleaning the Pinch Rollers** (*shown in Figure 5-3*)

**Note:** *You should perform steps 1 through 6 under Getting Ready (on page 5-4) prior to cleaning the pinch rollers.*

1. Locate the pinch rollers (Figure 5-3).
2. Moisten a clean cloth or lint-free paper wipe with alcohol.
3. Using the platen wheel to rotate the pinch rollers, wipe each roller segment using a back-and-forth motion along its entire length.
4. Allow the rollers to dry thoroughly.
5. Clean the donor roll winding roller as instructed in the next paragraph.

**Cleaning the Donor Roll Winding Roller** (*shown in Figure 5-3*)

**Note:** *You should perform steps 1 through 6 under Getting Ready (on page 5-4) prior to cleaning the donor roll winding roller.*

1. Locate the donor roll winding roller (Figure 5-3).
2. Moisten a clean cloth or lint-free paper wipe with alcohol.
3. While turning the roller, wipe the roller back and forth along its length.
4. Allow the roller to dry thoroughly.

## CLEANING THE PLOTTER EXTERIOR

The exterior surfaces of the plotter should be cleaned periodically.

1. Ensure the plotter is powered OFF (control panel POWER switch/indicator is not lighted).
2. Disconnect the plotter power cord from the facility power receptacle.

**Caution:** *Do not allow water or cleanser to enter the media cassette and media stacker slots.*

3. Use a damp (not wet), soft cloth with a small amount of mild cleanser to clean plotter surfaces. Do not use abrasives or excessive amounts of water.
4. Dry the surface with a dry, soft cloth.
5. Plug the plotter power cord in the ac power receptacle.

## CLEANING DUST FROM PLOTTER INTERIOR

Over time, paper and other types of dust accumulate inside the plotter with normal use. Therefore, the interior should be cleaned periodically.

**Note:** *You must perform steps 1 through 6 under Getting Ready to prepare the plotter interior for general cleaning.*

1. Ensure the plotter is powered OFF (control panel POWER switch/indicator is not lighted).
2. Disconnect the plotter power cord from the facility power receptacle.
3. Pull the cover latch on the right side of the plotter chassis *up* and, using both hands, lift the top cover to access the interior of the plotter. Ensure the cover support is locked in place.
4. Moisten a clean cloth or lint-free paper towel with alcohol.
5. Wipe out the inside of the cover and around the donor roll tray guide.

## REPLACING THE INK DONOR ROLL AND MEDIA

If you need to install the donor roll and reload media after cleaning the plotter, follow the procedures outlined in Section 3, *Loading the Ink Donor Roll and Media*.

## SERVICE FACILITIES

Versatec maintains service offices worldwide to provide professional maintenance services for your equipment. Each office is staffed with highly trained service engineers. Information regarding office locations and available service agreements can be obtained from any of our sales offices. Always give the model and serial number of your equipment when service correspondence is required.

## STANDARD WARRANTY

Equipment manufactured by Versatec and delivered to the original purchaser is warranted for a period of ninety (90) days from the date of shipment to be free from defects in materials and workmanship and to operate under normal use within the product specifications. The warranty contained herein is for the benefit of and shall be enforceable by the original purchaser of Versatec equipment only and is not transferable. Expendable parts such as fuses, lamps, and operating supplies are excluded from the warranty. Liability under this warranty is limited to replacement of defective parts, repair and/or servicing the equipment to return it to normal operating condition.

If it is determined by Versatec that no failure exists or that damage was created by negligence, misuse, improper installation, alteration, accident or abnormal operating conditions, the user will be invoiced all charges associated with troubleshooting and repair.

This warranty applies only to Versatec equipment permanently installed within the contiguous forty-eight states.

*THIS LIMITED WARRANTY IS PROVIDED IN LIEU OF ALL OTHER WARRANTIES, EITHER EXPRESSED OR IMPLIED, INCLUDING THE WARRANTY FOR MERCHANTABILITY AND FITNESS FOR A PARTICULAR PURPOSE. VERSATEC WILL NOT BE LIABLE FOR DAMAGES, EITHER DIRECT, INCIDENTAL, OR CONSEQUENTIAL, OCCURRING OUT OF OR IN CONNECTION WITH THE USE OR PERFORMANCE OF THE EQUIPMENT OR SOFTWARE PROVIDED HEREUNDER.*



## SECTION 6 IN CASE OF DIFFICULTY

This section provides you with the techniques to identify and correct problems which may occur in plot output or plotter operation. Some of the problems you may encounter include scratches, plot holes, dropout, light plot output and difficulty with the control panel.

If the corrective procedures in this section do not resolve a plotter problem, contact your Versatec Service Representative for assistance.

### COLOR TAILING

Color tailing, shown in Figure 6-1, appears as a *run* or *streak* on the plot parallel to the direction of media travel. Color tailing is caused by excessive heating of the ceramic substrate in the thermal printhead. To correct the problem, reduce the INTENSITY setting. If the problem persists, refrain from plotting for a few minutes. If tailing still occurs, contact your Versatec Service Representative for assistance.

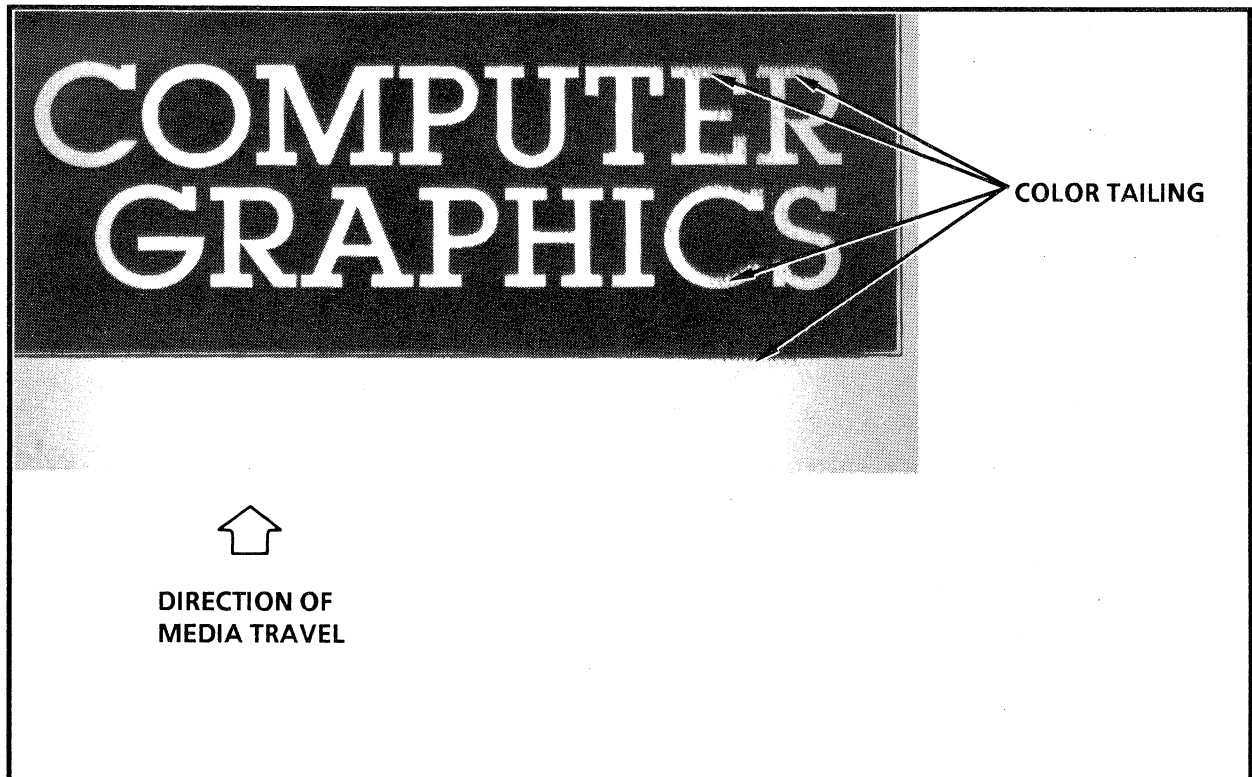

Figure 6-1. Color Tailing



## DONOR ROLL WRINKLE

The plot defects shown in Figure 6-2 are caused by wrinkles in one or more of the color panels on the ink donor roll. This type of dropout occurs randomly and is typically oblique to the direction of media travel. It may often precede or accompany a donor roll jam. If this occurs, refer to *Recovering From a Donor Roll Jam* in this section.

Lift the top cover to inspect the donor roll for more wrinkles. If the roll is still wrinkled, manually wind the affected area onto the take-up roll and resume plotting. If the problem persists, replace the donor roll as described in Section 3, *Loading the Ink Donor Roll and Media*. If you still experience difficulty, call your local Versatec Service Representative for assistance.

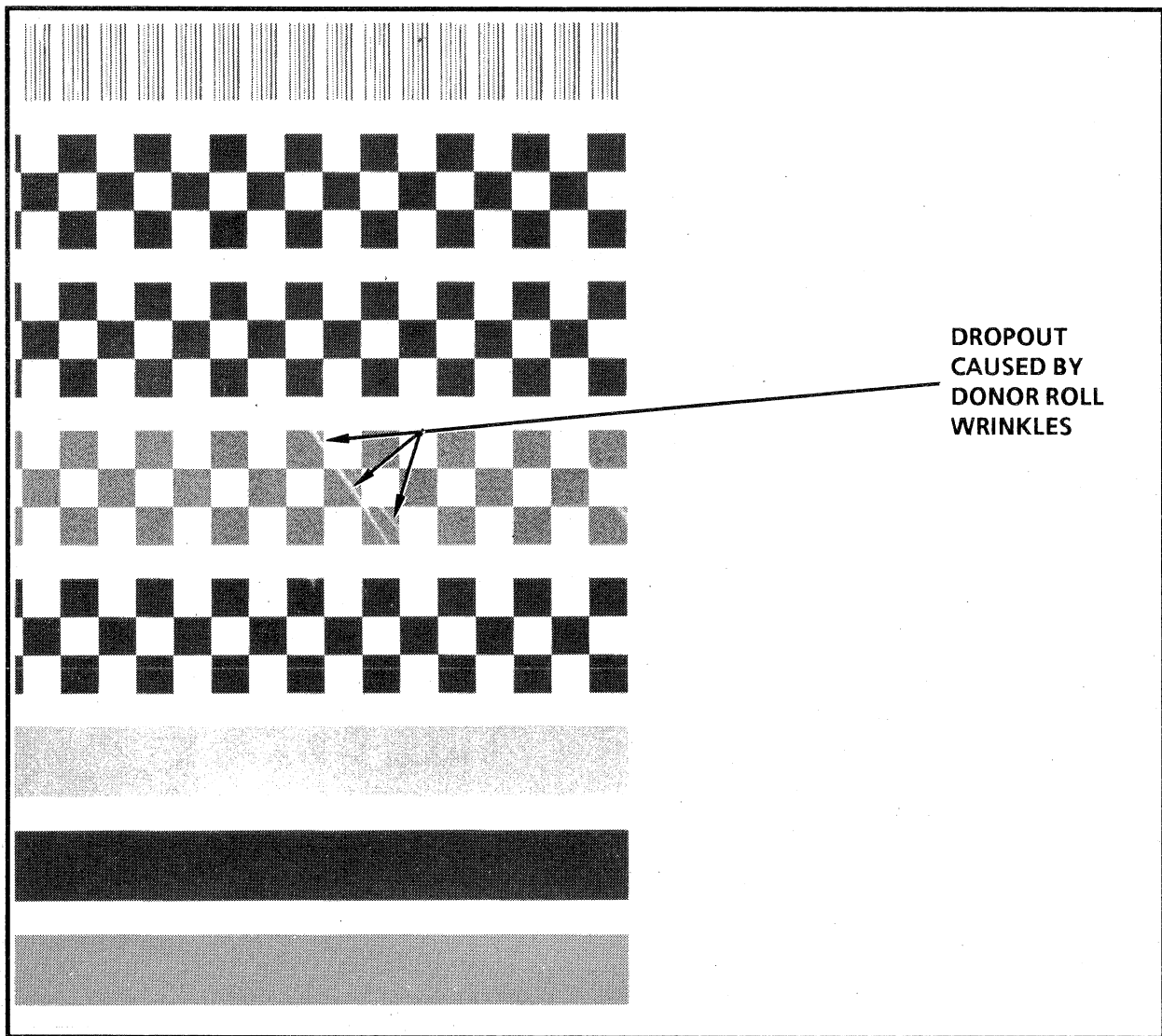
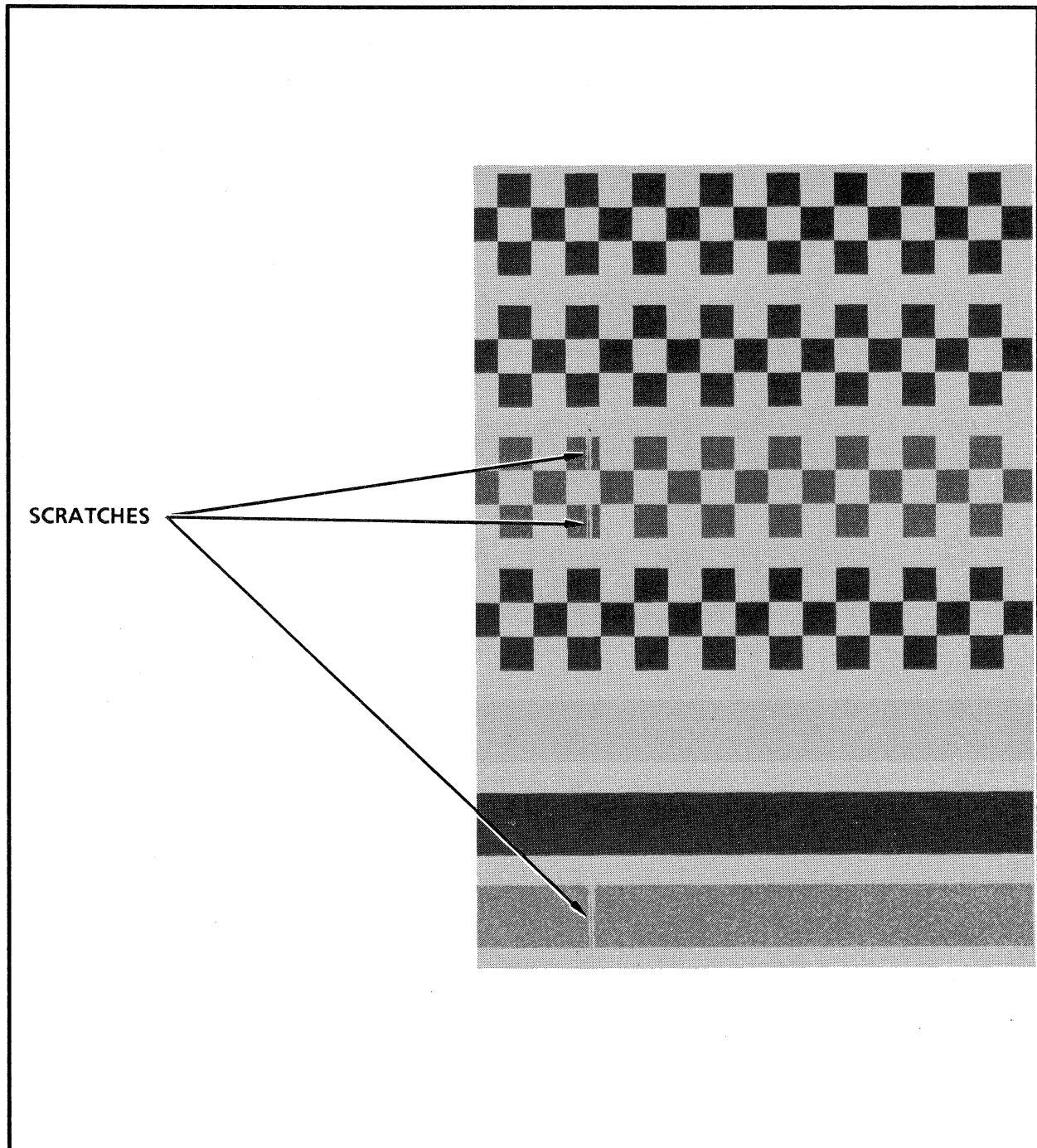

Figure 6-2. Donor Roll Wrinkle

## PLOT SCRATCHES

Plot scratches of the type shown in Figure 6-3 are typically due to dust on the thermal printhead. To remedy this, clean the thermal printhead as described in Section 5, *Periodic Maintenance*.



**Figure 6-3. Plot Scratches**

## PLOT HOLES

*Plot holes* are small white or incorrectly colored spots on the plot image, as shown in Figure 6-4. This problem may be caused by dust particles trapped between the printhead and the donor roll sheet. To remedy, clean the printhead as described in Section 5, *Periodic Maintenance*. Then, inspect the donor roll and media for dust contamination and clean, if necessary. If the problem persists, replace the ink donor roll as described in Section 3, *Loading the Ink Donor Roll and Media*.

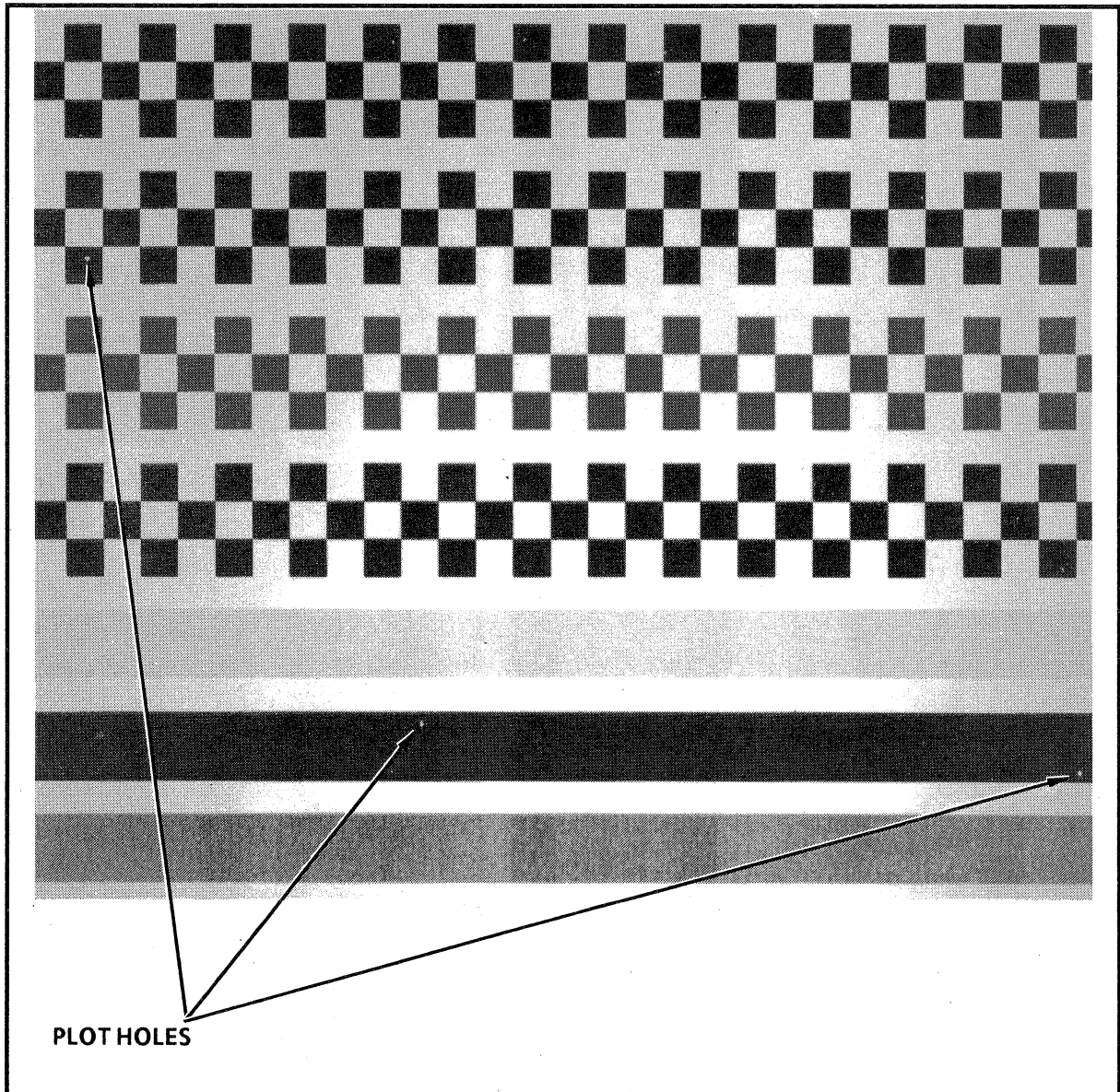

Figure 6-4. Plot Holes

## MISSING BLOCK(S)

One or more missing blocks of plot data that run the length of the plot (Figure 6-5) is evidence of a defective thermal printhead. This problem requires the attention of a Versatec Service Representative.

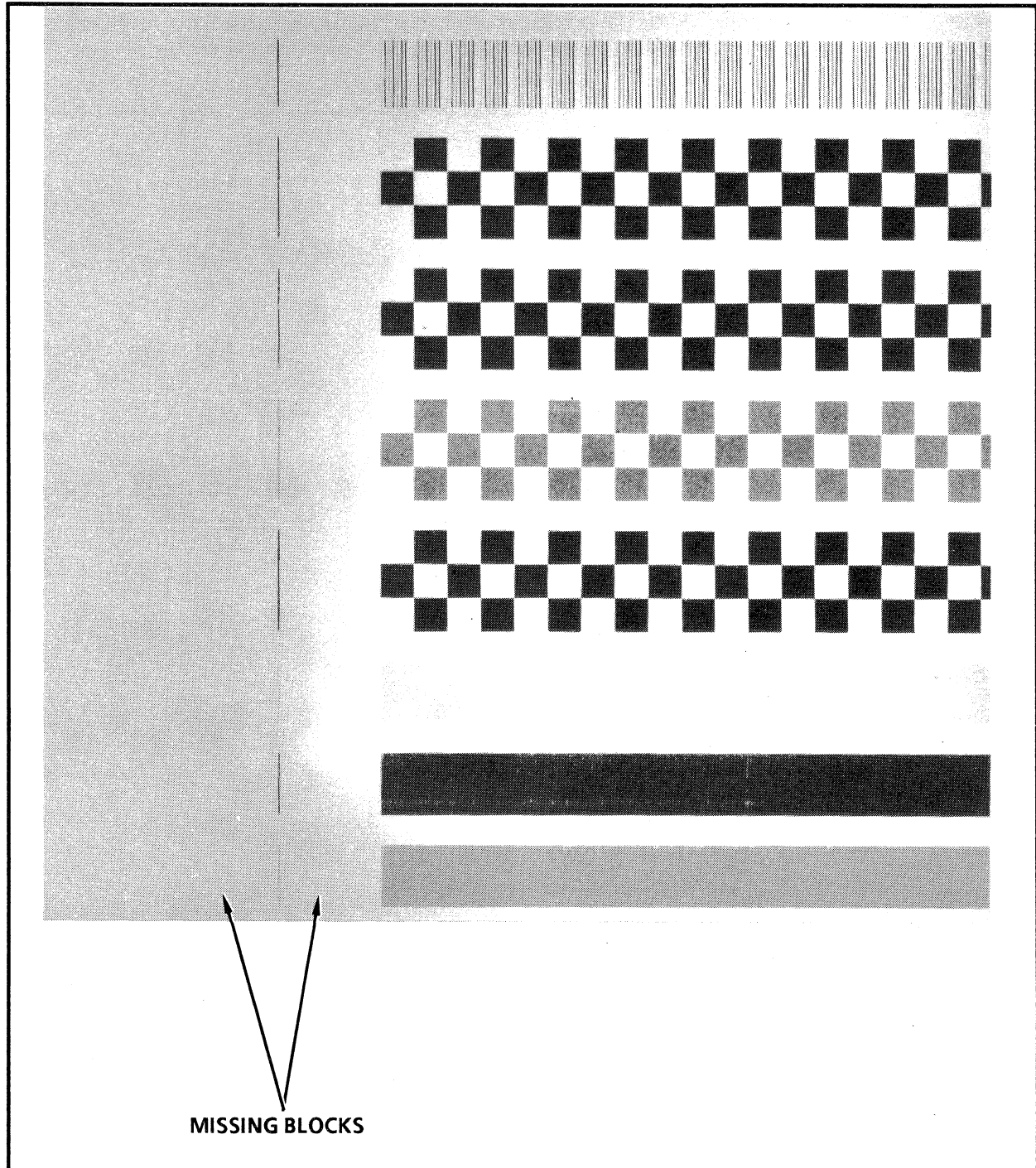

Figure 6-5. Missing Blocks

## UNEVEN INK DISTRIBUTION

Random dropout of the type shown in Figure 6-6 is a result of incomplete ink transfer to the media. This could be caused by defects in one or more color panels on the donor roll. To remedy, run another plot or change the ink donor roll as described in Section 3, *Loading the Ink Donor Roll and Media*. If the symptom persists, it is indicative of a thermal printhead misalignment, a condition requiring the attention of your Versatec Service Representative.

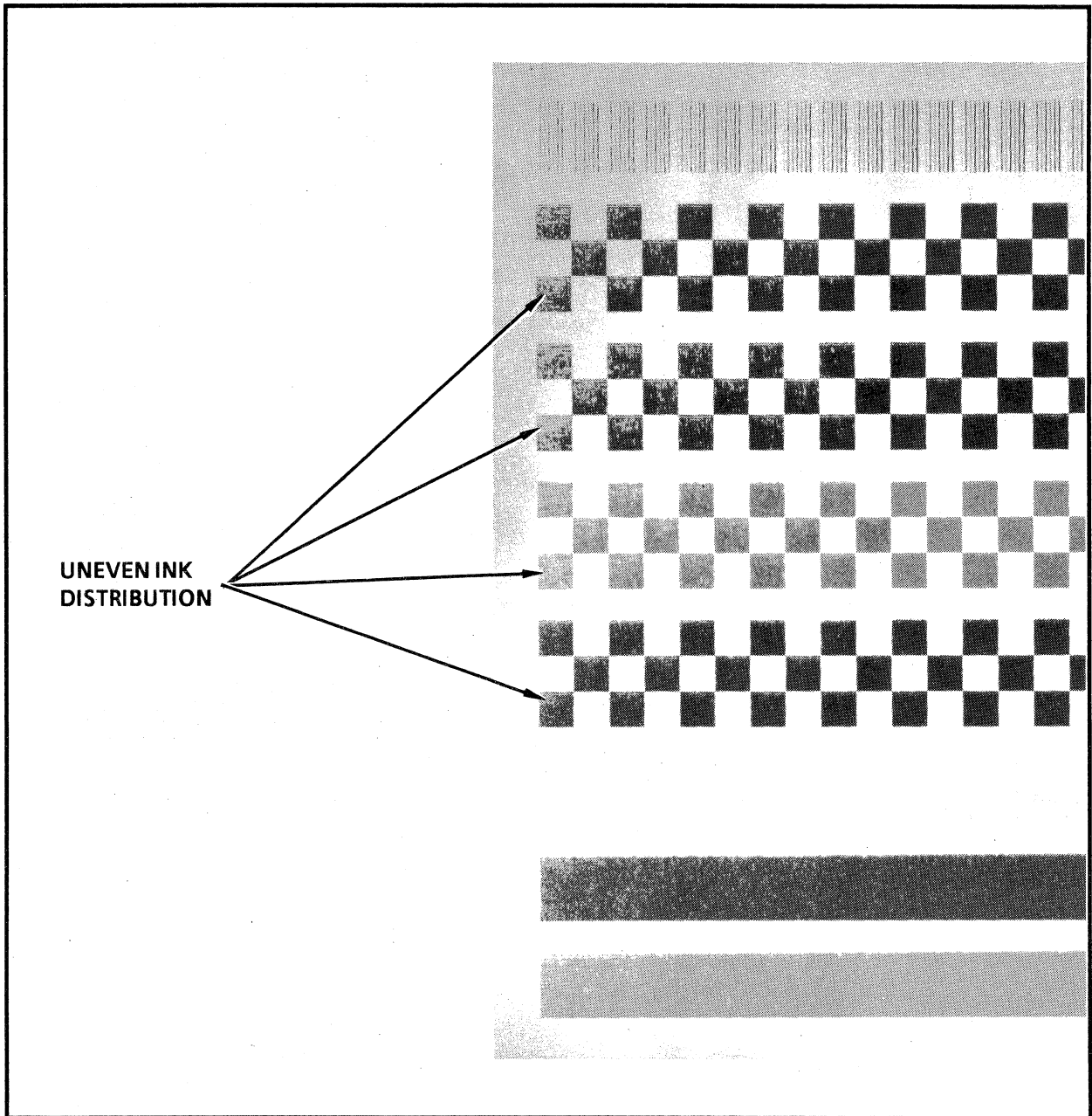
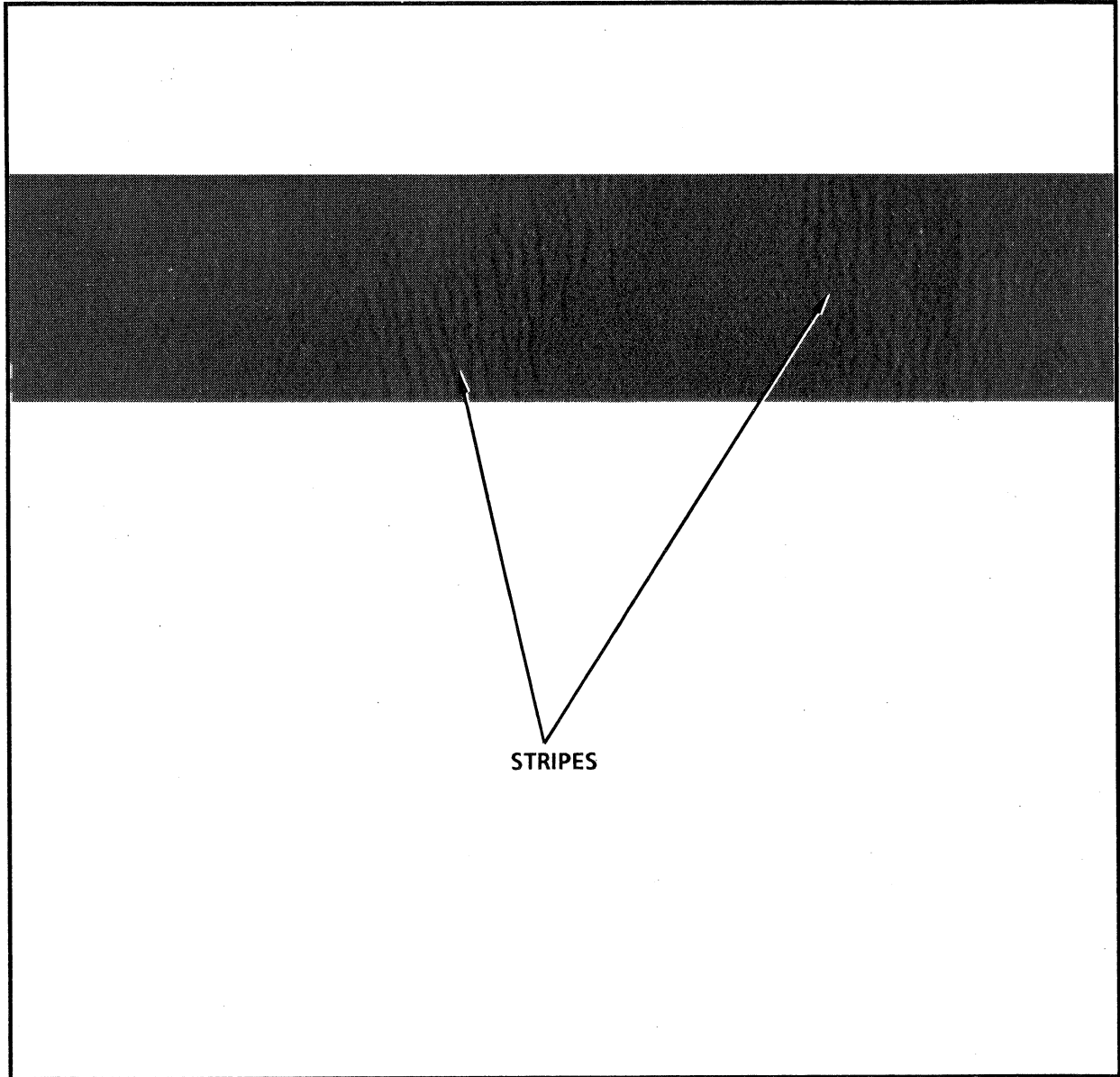

Figure 6-6. Uneven Ink Distribution

## STRIPES IN SOLID BLACK\* AREAS

'Wavy' stripes of the type shown in Figure 6-7 are evidence of a thermal printhead misalignment. This condition must be corrected by your Versatec Service Representative.



**Figure 6-7. Stripes in Solid Black Areas**

*\*Three-color black only.*

## PLOT MISREGISTRATION

Misregistration occurs in color (multipass) plotting when the images transferred during each pass do not align correctly with one another. Figure 6-8 gives an example of a misregistered test plot. This problem typically suggests uneven pinch roller pressure, a condition which must be corrected by your Versatec Service Representative.

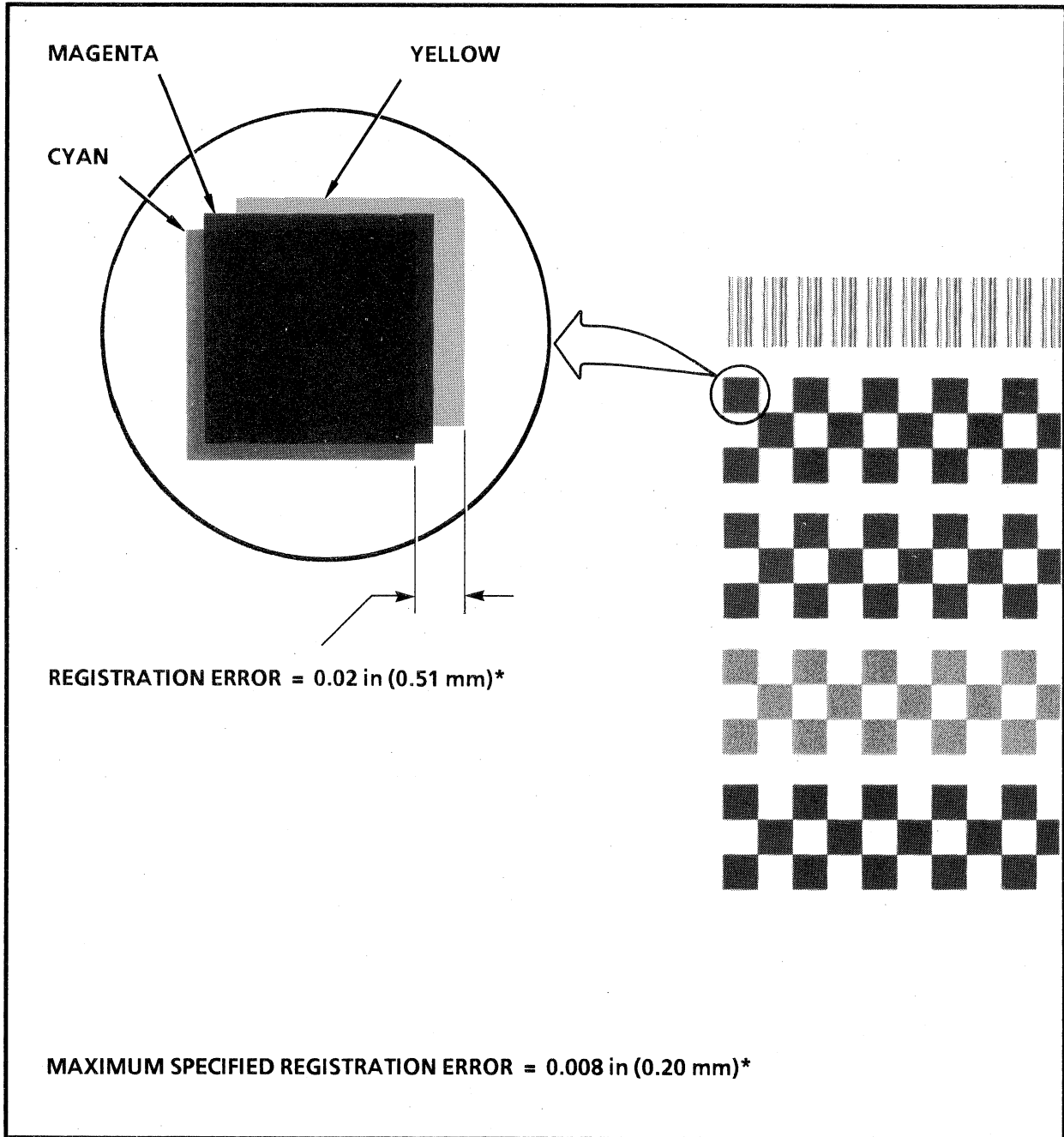

Figure 6-8. Plot Misregistration

## LIGHT PLOT OUTPUT

A plot that is *too light* may be corrected by adjusting the image intensity using the INTENSITY switch on the control panel (this switch is operational only in OFF LINE mode). Pressing the switch will cycle the plotter through four possible settings; LIGHT, NORMAL, DARK and LINE INTENSITY (no lamps lit; recommended for plots with lines and cross-hatching). Select the setting that provides the most acceptable output. If the problem persists, contact your Versatec Service Representative for assistance.

## CONTROL PANEL DIFFICULTY

If any control panel switch(es) should *lock up*, power the plotter OFF and then ON again. This resets the plotter firmware. If the problem persists, contact your Versatec Service Representative for assistance.

## DONOR ROLL AND PAPER JAMS

The following procedures describe how to remedy a donor roll jam or paper jam, should either occur during plotter operation.

### Recovering From a Donor Roll Jam

If a donor roll jam occurs during plotting, correct the condition using the following procedure.

*Note: Do not touch the surface of the rubber rollers with your fingers.*

1. Power OFF the plotter.
2. Open the top cover, ensuring the cover support is locked in place.
3. Spread the pinch rollers by pushing down the pinch roller release lever in the direction shown in Figure 6-9.
4. Remove the jammed color panel by pulling it slowly toward you, away from the platen roller, as shown in Figure 6-10.
5. Restore the pinch roller release lever to its original position. Wind all wrinkled color panels onto the take-up roll to prevent rejamming.
6. Close the cover securely.
7. Power ON the plotter to resume normal operation.



## Recovering From a Paper Jam

If a paper jam occurs during plotting, remove the jammed paper using the following procedure.

**Note:** *Do not touch the surface of the rubber rollers with your fingers.*

1. Power OFF the plotter.
2. Open the top cover, ensuring the cover support is fully engaged.
3. Press the pinch roller release lever in the direction shown in Figure 6-9 to open the pinch rollers.

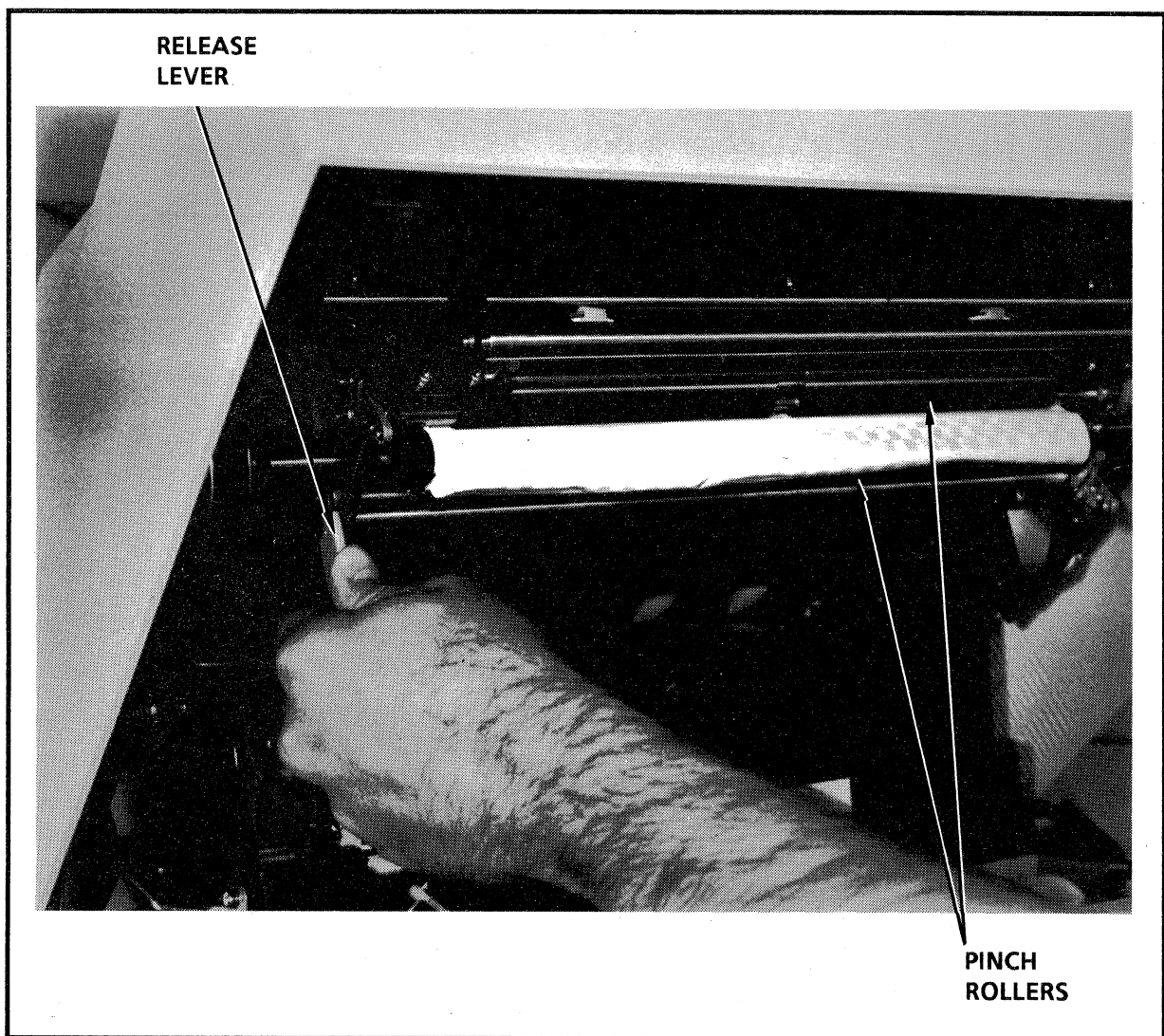
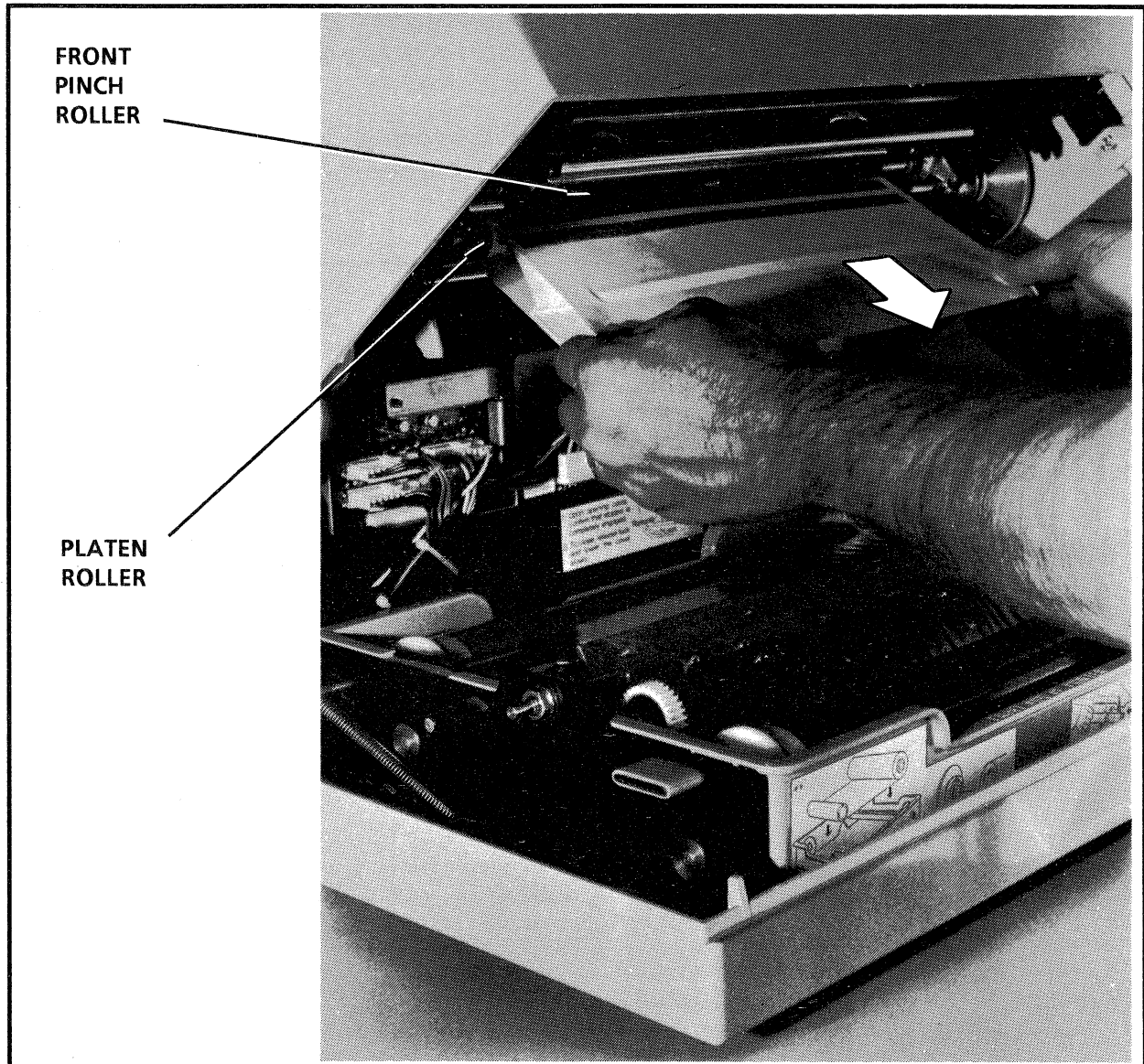

Figure 6-9. Opening the Pinch Rollers

4. Remove the jammed paper by pulling it slowly toward you, away from the platen roller. See Figure 6-10.



**Figure 6-10. Removing Jammed Paper**

5. Restore the pinch roller release lever to its original position. If a wrinkle is observed in the ink donor roll, turn the roll so that the wrinkle is wound onto the take-up roll.
6. Close the cover securely.
7. Power ON the plotter to resume operation.

**GENERAL TROUBLESHOOTING**

Table 6-1 identifies some possible operational malfunctions, a list of their probable causes and solutions to correct them. Table 6-2 is a guide to decode the error indicators on the front panel and includes an index of probable causes and corrective actions.

**Table 6-1. General Troubleshooting Guide**

PROBLEM DESCRIPTION	PROBABLE CAUSE	SOLUTION
POWER lamp does not light.	<ul style="list-style-type: none"> <li>a. Power connector is not inserted properly or connector is loose.</li> <li>b. The POWER switch is in the OFF ('0') position.</li> </ul>	<ul style="list-style-type: none"> <li>a. Correctly insert the connector. Ensure it is seated securely in the power receptacle.</li> <li>b. Set the POWER switch in the ON ('1') position.</li> </ul>
Plotting does not begin.	<ul style="list-style-type: none"> <li>a. Plotter is not ON LINE.</li> <li>b. Parallel Interface cable is disconnected.</li> <li>c. Donor roll is depleted or the donor roll tray is not installed.</li> <li>d. Plotter is out of media or the media cassette is not installed properly.</li> </ul>	<ul style="list-style-type: none"> <li>a. Put the plotter in ON LINE mode by pressing the ON LINE switch.</li> <li>b. Connect the Parallel Interface cable. Refer to Section 2.</li> <li>c. Replace the donor roll. Install the donor roll tray. Refer to Section 3.</li> <li>d. Load media or remount the media cassette. Refer to Section 3.</li> </ul>
Plotting blurs or dots are missing.	<ul style="list-style-type: none"> <li>a. Intensity setting is incorrect.</li> <li>b. The donor roll is wrinkled.</li> <li>c. Paper dust is adhering to the thermal printhead.</li> </ul>	<ul style="list-style-type: none"> <li>a. Change the intensity. Refer to Section 4.</li> <li>b. Wind the wrinkled area onto the take-up roll. If necessary, reinstall the donor roll as described in Section 3.</li> <li>c. Wipe off the dust/dirt with the head cleaner. Refer to <i>Cleaning the Thermal Printhead</i>, Section 5.</li> </ul>

**Table 6-1. General Troubleshooting Guide (continued)**

PROBLEM DESCRIPTION	PROBABLE CAUSE	SOLUTION
Irregular spacing between colors.	a. The paper is stained. b. Foreign matter is adhering to the platen roller.	a. Replace the paper. b. Clean the platen roller with alcohol. Refer to Section 5, <i>Periodic Maintenance</i> .
Plot data is lost at the right and left edges when using A3 size media.	Incorrect DIP switch setting.	Turn on switch #8 in the BT8 DIP switch. Refer to Section 2, <i>Installation</i> .
Plot data is lost at the right and left edges when using A size media.	Incorrect DIP switch setting.	Turn off switch #8 in the BT8 DIP switch. Refer to Section 2, <i>Installation</i> .
Plot data exceeds the right and left edges when using A4 size media.	Incorrect DIP switch setting.	Turn on switch #8 in the BT8 DIP switch. Refer to Section 2, <i>Installation</i> . Then, clean the thermal printhead as described in Section 5, <i>Periodic Maintenance</i> .
Plot data is lost at the right and left edges when using B size media.	Incorrect DIP switch setting.	Turn off switch #8 in the BT8 DIP switch. Refer to Section 2, <i>Installation</i> . Then, clean the thermal printhead as described in Section 5, <i>Periodic Maintenance</i> .
Plot data 'wraps.'  <i>Wrapping</i> is the term used to describe a malfunction where the last <i>n</i> bytes of a given scan line are plotted on the following line. This continues over the length of the plot and yields garbled or 'confused' graphic information.	Incorrect DIP switch setting and/or the number of bytes per scan line sent from the host computer does not match the number of bytes the plotter expects to receive.	Check the plotter's DIP switch setting (refer to Section 2, <i>Installation</i> ). Verify that the number of bytes per scan line sent from your computer agrees with the number for which the plotter is configured. Refer to Table B-3 in Appendix B, <i>Plotter Control Functions</i> , for a list of acceptable line sizes.
Plot data is lost at the top and/or left margin(s) of media, any size.	Margin setting(s) is (are) incorrect.	Adjust the margin setting(s). Refer to <i>Setting the Plot Margins</i> , Section 4.

Table 6-2. Guide to Error Indicators

INDICATOR	PROBABLE CAUSE	SOLUTION
EOI ( <i>End of Ink</i> ) lamp lights	The donor roll is used up (black panel at end of roll appears).	Install a new donor roll. Refer to <i>Installing the Ink Donor Roll</i> , Section 3.
EOP ( <i>End of Paper</i> ) lamp lights	a. Media has run out. b. Media cassette is not installed or is installed incorrectly.	a. Install new media in the media cassette. b. Correctly install the media cassette. Refer to Section 3.
JAM lamp lights	a. Media or donor roll jam has occurred. b. Correct size media is not in the media cassette. c. The media cassette is too full.	a. Remove the jammed media. Refer to <i>Recovering From a Paper Jam</i> in this section. If the donor roll has caused the jam condition, refer to <i>Recovering From a Donor Roll Jam</i> , this section, to correct the problem. b. Install the correct size media. Refer to Section 3. c. Reduce the amount of media in the media cassette.
COVER lamp lights	Plotter cover is not fully closed.	Close the cover securely (it should <i>click</i> ).
HEAT lamp lights	The thermal printhead temperature is abnormally high (or low).	Wait until the head cools. Printing ceases when the head temperature exceeds 50°C (122°F). When the head cools, the plotter will come ON LINE automatically. If the head temperature is abnormally low ( $\leq 7^{\circ}\text{C}$ , or 45°F), wait until the head warms up. When it warms, manually set the plotter ON LINE.
ALL ERROR lamps are lighted	Thermal head position error.	Power the plotter OFF, then ON again. If lamps continue to flash, contact your Versatec Service Representative for assistance.
ALL ERROR lamps are <i>flashing</i>	RAM abnormality.	Power the plotter OFF, then ON again. If lamps continue to flash, contact your Versatec Service Representative for assistance.

# APPENDIX A

## C2700 MODELS AND OPTIONS

This appendix provides model descriptions and lists available supplies and accessories for the C2700 Series Thermal Transfer Color Plotter.

### MODELS

- C2756-VV: Thermal Transfer Color Plotter
- Versatec Parallel Interface
  - Versatec Communications Protocol
  - Domestic (U.S. and Canada) media sizes

- C2766-VV: Thermal Transfer Color Plotter
- Versatec Parallel Interface
  - Versatec Communications Protocol
  - International (metric) media sizes

*Note: The following models are configured to accept a Centronics Parallel interface, a feature not presently supported by Versatec software. Customers desiring the Centronics interface must provide their own device driver.*

- C2756-CM: Thermal Transfer Color Plotter
- Centronics Parallel Interface
  - CM Type I Communications Protocol
  - Domestic (U.S. and Canada) media sizes

- C2766-CM: Thermal Transfer Color Plotter
- Centronics Parallel Interface
  - CM Type I Communications Protocol
  - International (metric) media sizes

## SUPPLIES AND ACCESSORIES

Versatec media and ink supplies are specially made for use with Versatec plotters. Order these supplies and accessories through your Versatec Representative using the reorder codes provided below:

### Media

#### Paper:

- TT49A3-CS: 500 sheets × 4 reams of A3 size (297×420 mm) paper
- TT49A4-CS: 500 sheets × 4 reams of A4 size (210×297 mm) paper
- TT4911-CS: 500 sheets × 4 reams of B size (11×17 in) paper
- TT4908-CS: 500 sheets × 4 reams of A size (8.5×11 in) paper

#### Film:

- TT49A3-CC: 200 sheets of A3 size (297×420 mm) transparency film
- TT49A4-CC: 200 sheets of A4 size (210×297 mm) transparency film
- TT4911-CC: 200 sheets of B size (11×17 in) transparency film
- TT4908-CC: 200 sheets of A size (8.5×11 in) transparency film

### Ink Donor Rolls

- TT4997-3I: One carton (4 rolls) of 3-color, 17-inch (B/A3 size) ink donor rolls (150 sheets per roll)
- TT4908-3I: One carton (4 rolls) of 3-color, 11-inch (A/A4 size) ink donor rolls (210 sheets per roll)
- TT4997-4I: One carton (4 rolls) of 4-color, 17-inch (B/A3 size) ink donor rolls (125 sheets per roll)
- TT4908-4I: One carton (4 rolls) of 4-color, 11-inch (A/A4 size) ink donor rolls (180 sheets per roll)
- TT4097-IR: One carton (4 rolls) of monochrome (black) ink donor rolls; used with B/A3 size media (450 sheets per roll) or A/A4 size media (630 sheets per roll)

**Media Cassettes**

TT-MCA3:	Media cassette for A3 size (297 × 420 mm) media
TT-MCA4:	Media cassette for A4 size (210 × 297 mm) media
TT-MCB:	Media cassette for B size (11 × 17 in) media
TT-MCA:	Media cassette for A size (8.5 × 11 in) media

**Media Stacker**

TT-PS:	Media Stacker, accommodates all media sizes
--------	---

**Thermal Head Cleaner**

TT-HC:	Thermal Head Cleaner
--------	----------------------

**Power Cables**

TT-PC56:	Power Cable, 115 V
TT-PC66:	Power Cable, 230 V

**Donor Roll Tray**

TT-ISC:	Donor Roll Tray, accommodates both donor roll sizes (11- and 17-inch)
---------	---

**Manuals**

5990-01:	C2700 Series Thermal Plotter Operator Guide
5991-01:	C2700 Series Thermal Plotter Service Manual



I  
C  
I  
I  
I  
I  
I  
C  
I  
I  
I  
I  
I  
I  
I  
C  
I

# APPENDIX B

## PLOTTER CONTROL FUNCTIONS

This appendix describes the actions of the C2700 Series Thermal Plotter remote functions and ASCII control commands and their expected use by software programs and controllers operating with the Versatec Parallel interface.

### OPERATION AND CONTROL

The C2700 Series Plotter is a sequential thermal transfer plotter, capable of producing both monochrome and color plots. It is controlled through a combination of ASCII *escape sequence* commands and remote Versatec Parallel command functions. In the color mode, the media will make three or four passes through the plotter. The color sequence is fixed. The data input format conforms to the standard Versatec Parallel interface.

*Note: Highest quality output is realized when plots are generated at a constant speed.*

### REMOTE FUNCTIONS

Remote commands may be transmitted from the host to the plotter using the Versatec Parallel interface signal lines or by transmitting the appropriate ASCII control code (i.e., escape sequence). Both are described in Appendix A of the *C2700 Series Thermal Plotter Service Manual*, Versatec Publication 5991.

- If a remote function is issued while the plotter is busy, the function will be lost, with the exception of REMOTE RESET, which can be issued at any time. Data and/or control functions (FF or EOT) may be lost when a REMOTE RESET is received.
- Remote signal lines are recognized whenever they occur, provided the interface is not busy.
- A mode change (PRINT\*/PLOT), accompanied by the PICK signal, and all remote commands will cause the interface to be *busy* (for several microseconds) while the action(s) specified by the signal are performed.

\* PRINT mode is used only to transmit escape sequences. Since the C2700 Plotter is not equipped with a character generator, PRINT mode is not used for writing text.

## Parallel Interface Signal Lines

The remote commands discussed here are assigned separate signal lines in the parallel interface cable. Versatec's parallel interface consists of the parallel inputs described in Versatec's *Parallel Interface Specification* and the PICLK (parallel input clock) signal.

### Clear (CLEAR)

This command causes the plotter to clear image data not yet terminated in the current buffer but does not change the current status of the plotter.

### Remote Form Feed/Remote End-of-Transmission (RFFED/REOTR)

Both of these commands perform the same functions. Upon receipt of RFFED or REOTR the following events occur:

- The plotter is *set busy*
- If there is no media in the imaging area, these commands are ignored
- If the data buffer is partially filled, it is completed
- The plotter plots all data in the (full) buffer
- The plot is moved out to the media stacker
- The ink donor roll is advanced to the start of the next yellow color panel

When using special functions, these commands cause them to be reset. The plotter returns to a ready state, if possible, once it completes the media and donor roll movements described above.

## Remote Reset (RESET)

Will cause the plotter to reset back to a power-up state. This command is accepted whether the plotter is ready or not. Upon receipt of this command the following events occur:

- The power supplied to the drive motor, solenoid and printhead is turned off
- The plotter is *set busy*
- If there is no media in the imaging area, this command is ignored
- All internal circuitry is initialized
- All data in the buffer not yet plotted is erased
- PRINT mode is enabled
- If media is in the imaging area, the media drive motor and solenoid are activated and move the media out to the stacker
- The ink donor roll is advanced to the start of the next yellow color panel

When using special functions, RESET causes these functions to be reset. If no errors occur in the RESET procedure the plotter returns to a ready state. If an error does occur, the *busy* status remains and the INOP status line goes to OFF LINE status.

## Remote Line Terminate (RLTER)

RLTER is used to terminate a partially filled input buffer. When the plotter is in PRINT mode or *busy*, this command is ignored. When a remote line terminate immediately follows a full buffer, it does not cause generation of a blank scan line (a full buffer automatically generates an internal line termination). Upon receipt of RLTER, the plotter will:

- *set busy*
- complete a partially filled data buffer (the remainder of the scan line is filled with zeros)
- cause the contents of the buffer to be plotted on the media

All subsequent RLTER commands generate blank lines, one per RLTER. After processing, the plotter goes *ready*, if possible.

## ASCII CONTROL COMMANDS

A special hexadecimal character (CC) in Versatec's Color Random software package allows commands to be sent to the plotter in PRINT mode as ASCII character strings. These character strings are the *carriage control* commands and *escape sequence* commands. Via the host software, plotter control functions can be selected remotely through Versatec's Model 800 Series RPM controllers supporting the VDS (Versatec Data Standard) PASS ALL PRINT (CC) command. Commands are required to be an even number of bytes with some command strings containing an extra byte to pad for an even byte alignment.

Other ASCII codes with the exception of FF, EOT or ESC will be ignored.

The Inverse Image and Mirror Image commands are reset after a FORM FEED, END-OF-TRANSMISSION or a remote RESET is sent. If the user wishes to override the resetting of Inverse Image and Mirror Image, two special escape sequences are provided for this purpose:

- 9B 5E (disables the FF and EOT resetting operation)
- 9B 5C (enables the FF and EOT resetting operation)

The remote RESET command is not affected by these escape sequences.

### Carriage Control Commands

Form Feed (FF) : 0C (Hex ASCII code)

This command functions the same as the Remote Form Feed (RFFED) command. Refer to *Remote Functions* in this Appendix.

End-Of-Transmission (EOT) : 04 (Hex ASCII code)

This command functions the same as the FF command.

## Escape Sequence Commands

The plotter will look at the characters or data bytes after the escape character as a command. The byte following the escape character will be the command byte. This byte will indicate what operation is to be performed. The next two bytes following the command byte will be used as a byte count. This is needed to allow the plotter to bypass commands that are not functional for the plotter. When a remote reset is issued to the plotter, the plotter will be reset to its normal default (power-up) state.

The general format is:

[ESC] [M] [N1] [N2] [DATA]

where

ESC	is the escape character with the upper bit set (9B Hex),
M	is the command byte,
N1 and N2	represent the byte count
and	
DATA	is the plot data following the command function.

The command byte [M] is ignored if it is not defined in one of the escape sequences described below. When this occurs, the next [N1] byte is accepted as an ASCII control command.

### Inverse Image Plotting [ESC] [I] [0] [0]

This command causes an 'inverse image' of the data to be plotted. That is, every bit normally set to a '1' is set to a '0' and every bit normally a '0' is set to a '1'. This function will only be active for the plot following the command and is reset by Form Feed, End-Of-Transmission and Reset commands (ASCII and Remote).

### Mirror Image Plotting [ESC] [M] [0] [0]

Will cause a mirror image of a plot to be produced. This function is only active for the plot that follows the command. A form feed (FF), EOT or remote reset will cause the function to be disabled.

Image Magnification [ESC] [R] [0] [N]

This command allows the user to enlarge the upper left-hand portion of a plot by a scaling factor of 2×2, 3×3 or 4×2 in the x- and y-directions, respectively (1×1 is the default setting). The byte [N] is defined only for hexadecimal values between 01 and 04 as shown in Table B-1.

Table B-1. Image Magnification Values

N	MAGNIFICATION (x × y)
01	1×1
02	2×2
03	3×3
04	4×2

This function is also selectable through the ENLARGE switch on the plotter's control panel. If the selection is made through the control panel, all succeeding plots will be generated at the selected ENLARGE setting. If ENLARGE is chosen via the software as an escape sequence, only the plot immediately following the command will be made at that setting. All subsequent plots will be generated at the ENLARGE setting selected through the control panel switch.

Image Magnification is reset by the RFFED, REOTR, ASCII EOT and RESET commands.

Rewind [ESC] [W] [0] [0]

This command causes the plotter to terminate the data transmission of a color, plot all data remaining in the buffer and to move the media back to the top of sheet. The ink donor roll will advance to the start of the next color panel.

## Color Header Preamble [ESC] [P] [00] [04] [AABC]

Allows the user to select one of the three (yellow, magenta or cyan) or four (yellow, magenta, cyan or black) primary colors with which to plot. The multi-pass color sequence must be in the order yellow, magenta, cyan and black (4-color donor roll only).

[AA] is ignored.

[B] represents the color plot control byte. The lower two bits (0 and 1) are used to select plot colors as shown in Table B-2. The upper two bits (2 and 3) are ignored.

**Table B-2. Control Byte [B] Configuration**

SELECTED COLOR	Bit 1	Bit 0
Black	0	0
Cyan	0	1
Magenta	1	0
Yellow	1	1

[C] is ignored.



## PLOT OPERATION

With the plotter set to PLOT mode, data is accepted in the form of 8-bit bytes of raster data. A plot scan line sent from the host may contain a maximum of 424 bytes of graphic information, as shown in Table B-3. When the last byte of plot data is received, the interface is *set busy* until the line is transferred from the internal (input) buffer to the thermal line buffer. The size of the internal buffer is determined by the media size selected (Table B-3). The thermal buffer accepts the scan line from the internal buffer and, if Image Magnification (ENLARGE) is invoked, adjusts it to the required line size by deleting the appropriate number of bytes from the end of the line.

**Caution:** *It is necessary that the host send the exact number of bytes for which the plotter is configured. If the bytes sent from the host system exceed the number expected for a single scan line, the excess data will 'wrap'. If fewer bytes are sent unaccompanied by a Remote Line Terminate (RLTER), the data intended for the succeeding line will fill the remaining space in the first line and wrap onto the next line. If more bytes are received once the internal buffer is filled, they will form one or more additional scan lines.*

Table B-3. Acceptable Line Sizes

MEDIA SIZE	BYTES PER SCAN LINE
A3	424
A4	296
B	398
A	304

A scan line of plot data can be terminated at any time by one of several methods discussed under *Plot Line Termination* below. If the termination immediately follows a full scan line, it will be ignored\* since the filling of the input buffer automatically generates an internal line terminate. A termination with only a partial scan line will cause the remainder of that line to be filled with zero bytes. Successive terminations without intervening data will cause blank scan lines to be generated, one per termination.

Receipt of any termination will require microprocessor intervention and will thus require several microseconds to process, during which time the interface will be *set busy*. The same is true for any remote commands received during plotting operations.

\*RLTER only

## Plot Line Termination

There are several ways in which a plot scan can be terminated. These are listed below. The remote RESET command will erase any plot scan in the input buffer.

### Plot scans can be terminated by:

- RLTER (remote line terminate)
- RFFED (remote form feed)
- REOTR (remote end-of-transmission)
- A change from PLOT to PRINT mode

One of the following commands is necessary to reinitiate plot operation:

- RFFED
- REOTR
- REWIND
- FF
- EOT

When these commands are accepted, the plotter begins to plot all data in the buffer. Once the plot is complete, the media is ejected or rewound (for another pass) and the plotter looks for the start of the next color panel.

## SIMULTANEOUS FUNCTIONS

If several remote commands occur simultaneously, they are processed as follows:

- If the RESET command is part of the sequence, it overrides all other remote commands. When RESET is processed all other remote commands are cleared.
- If CLEAR, RLTER, RFFED and REOTR occur simultaneously, the input buffer is cleared, RLTER is ignored and RFFED and REOTR are processed.
- If RLTER, RFFED and REOTR occur simultaneously, the input buffer is completed (if data is present) and RLTER, RFFED and REOTR are processed.
- If RFFED and REOTR occur simultaneously, both commands are processed. If several of these commands occur simultaneously REOTR is the last to be processed.

## ON-LINE/OFF-LINE/REMOTE OPERATIONS

There are two formats for the thermal plotter, straight raster (i.e., plot image) and VDS (Versatec Data Standard). The VDS format requires the support of additional hardware other than the thermal plotter (i.e., a Versatec controller or parallel interface emulator). The thermal transfer plotter interface is the standard Versatec Parallel interface used on all Versatec products.

## RASTER OUTPUT

Using raster format, the user must first send the color header preamble escape sequence to the plotter in PRINT mode. The user will then send the raster data for the particular color pass to the plotter. A scan line sent from the host may contain a maximum of 424 bytes of graphic information (Table B-3). If a single-pass color plot was selected, the user must issue a remote form feed (RFFED) to cause the plot to move out of the imaging area to the stacker. If a multi-pass color plot is being generated and data for another color is sent, the REWIND escape sequence must be sent to the plotter. This will cause the plot to be rewound for the next color pass. The last color pass must be terminated by a remote form feed. This will cause the plot to exit the plotter. The length of each record can be any size the on-line system can handle. However, it is recommended that the record size be a multiple of a single scan.

## VERSATEC DATA STANDARDS

To setup the data for Versatec Data Standards output, a Versatec controller or parallel interface emulator must be used as the interface between the host computer and the plotter. Any of the formats can be used. The user must split the plot into three or four color secondaries (yellow, magenta, cyan and sometimes black), then send each pass to the controller, one at a time.

## MAG TAPE OUTPUT

Mag tape operations are the same as for Versatec Data Standards. The only difference is that the blocking on tape may be different than for on-line operations. Each plot (color pass) should be separated by a file mark for ease of usage.

# APPENDIX C

## GLOSSARY

Brief definitions of conventions and terminology used in discussing Versatec products and their performance are given below:

**Address** - The location of data or instructions in memory. Computer ROM and RAM work like an enormous collection of numbered pigeonholes. The addresses are the number on the pigeonholes.

**Annotation Angle** - The character text annotation angle defines the vector direction for a line of alphanumeric text measured in degrees counterclockwise from the X-axis.

**ANSI (American National Standards Institute)** - The principal standards development body in the USA. ANSI is a non-profit, non-governmental body supported by over 1000 trade organizations, professional societies and companies. USA's member body to ISO (International Standards Organization).

**ASCII (American Standard Code for Information Interchange)** - Pronounced 'asky'. This is a seven-bit-plus-parity code established by ANSI to achieve compatibility between data services.

**Asynchronous Transmission** - Transmission in which time intervals between transmitted characters may be of unequal length. Transmission is controlled by start and stop bits at the beginning and end of each character.

**Band** - A number of scan lines of raster data. For efficient operation when processing raster data types, host software generates several scan lines of data at a time from the vectors. The number of raster scan lines in a band is determined by the size of the raster data storage buffer located in the graphics controller and the number of nibs per scan line (each nib requires one bit) of the plotter in use.

**Baud** - Unit of signaling speed. The speed in baud is the number of discrete conditions or signal events per second. If each signal event represents only one bit condition, baud rate equals bits per second (bps). When each signal event represents other than one bit, e.g., dibit, baud rate does not equal bps.

**Bisynchronous Transmission (BSC)** - An IBM communications protocol which uses a defined set of control characters for synchronized transmission of binary coded data between stations in a data communications system.

**Bit (Binary Digit)** - Contraction of "binary digit", the smallest unit of information in a binary system. A bit represents the choice between a one or zero condition.

**Block** - Units making up a plot frame. A block is a logical record having an even number of bytes and is made up of a four-byte header optionally followed by data.

**Buffer** - A storage device used to compensate for a difference in rate of data flow or event timing when transmitting data from one device to another.

**Byte** - A binary element string operated upon as a unit and usually shorter than a computer "word." Eight-bit bytes are most common. Also called a "character."

**Cartesian Coordinate System** - A coordinate system defined by two perpendicular number lines (the X- and Y-coordinate axes) intersecting at a point designated as the origin (0,0). Any point (x,y) in the Cartesian plane is located by the distance x and the distance y from the Y- and X-axes, respectively, measured along lines parallel to these axes. Also called the *Rectangular* coordinate system.

**Centronics Parallel Interface** - A 36-pin, byte-wide interface used for computer-plotter communications. It employs eight separate lines that transmit their respective binary bits in parallel. All Centronics® Parallel logic levels are TTL.

**Clipping** - The process of limiting plot data to only those visible within the defined window. See **Window**.

**Color Panel** - One of the discrete color ink sheets on the ink donor roll.

## GLOSSARY

**Composite Video** - The signal which results from combining a blanked picture signal with the sync signal.

**Console** - The part of a computer used for communication between the operator or maintenance engineer and the computer.

**Convex Polygon** - A polygon having all internal angles less than 180 degrees.

**Coordinate** - A point location (X,Y) on a coordinate plane referenced as a directed distance from a specific origin position (i.e., (0,0)).

**Coordinate System** - A system by which points are located in a plane or in space relative to a specified origin. Each point is unique and is characterized as an ordered pair (X,Y) or triple (X,Y,Z). Versaplot software operates under the basic concept of the two-dimensional (X,Y) Cartesian coordinate system.

**CPU (Central Processing Unit)** - The portion of a computer which directs the sequence of operations and initiates the proper commands to the computer for execution.

**DCE (Data Communications Equipment)** - The equipment that provides the functions required to establish, maintain and terminate a data transmission connection; e.g., a modem.

**DIP (Dual In-line Package)** - The most common kind of package for integrated circuits. Those things that look like little plastic-and-metal centipedes that populate a printed circuit board. Usually identified by the number of pins on the package.

**DMA (Direct Memory Access)** - A technique that allows some peripherals to work with the computer's memory without having to go through the microprocessor. Usually requires a tri-state bus structure.

**Drawing Factor** - The ratio of the desired plot size to the normal plot size. For example, drawing factor = 2.0 enlarges the final plot to twice its normal size; drawing factor = 0.5 reduces the final plot to half its normal size. Drawing factor = 1.0, the plot is the normal plotting size.

**Electrostatic** - Versatec plotters operate on a principle of depositing a point of static electric charge on a sheet of specially coated paper wherever a mark is desired. The paper is then passed over a bath of toner, a liquid that contains a pigment, that is deposited on the charged areas of the paper but does not adhere to the uncharged areas.

**Emulate** - To imitate a computer system by a combination of hardware and software that allows programs written for one computer to run on another.

**EOT (End of Transmission)** - A transmission control character used to indicate the conclusion of the transmission of one or more texts.

**ESC (Escape)** - A control character which is used to provide additional control functions. It alters the meaning of a limited number of continuously following bit combinations.

**FF (Form Feed)** - A format effector which advances the active position to the same character position on a predetermined line on the next form or page.

**Frame** - A collection of blocks of data representing one plot. A frame may contain only one plot (Level I Initialize command). Each frame begins with a sequence of synchronization (sync) bytes providing a recognizable synchronization header and ends with an end-of-frame sequence of bytes.

**Full Duplex** - Simultaneous, two-way, independent transmission in both directions.

**Half Duplex** - Transmission in either direction, but not both directions simultaneously.

**Hardware Origin** - The absolute origin of the coordinate system inherent in the hardware design.

**Hertz (Hz)** - A measure of frequency or bandwidth. The same as cycles per second.

**Hexadecimal Number System** - The number system with the base of sixteen. In hexadecimal, the first nine digits are 0-9 and the last six digits are represented by the letters A-F.

**Indeterminate Output** - A plotted output that is not definitely or precisely determined or predicted.

**Ink Donor Roll** - A continuous roll of single or sequential color panels (Yellow, Magenta, Cyan and sometimes Black) that supplies the wax-based inks used in *thermal transfer* plotting.

**Ink Donor Roll Tray** - The frame that holds the ink donor roll. It couples with the donor roll feed motor which controls movement of the donor roll during plotting.

**ISO** - International Standards Organization.

**LED (Light Emitting Diode)** - A semiconductor light source that emits visible light or invisible infrared radiation.

**Leased Line** - A telephone line reserved for the exclusive use of a leasing customer without interexchange switching arrangements. Also called a Private Line.

**LF (Line Feed)** - A format effector which advances the active position to the same character position of the next line.

**Line Mask** - A binary bit pattern used in constructing horizontal or vertical lines. All bits ON defines a standard solid line; variations of bits ON/OFF combinations draw broken, dashed or dotted lines.

**Line Width** - Thickness of lines drawn, in nibs.

**LSB** - The least significant bit. The rightmost bit.

**Media Cassette** - A removeable paper holder that stores several cut sheets of paper or transparency film and automatically feeds them, one sheet at a time, into the imaging area. Used in the C2700 Series Thermal Transfer Plotter.

**Media Stacker** - The part of the C2700 thermal plotter that accepts and stacks finished plots.

**Modem (MODulator-DEMulator)** - A device used to convert serial digital data from a transmitting terminal to a signal suitable for transmission over a telephone channel or to reconvert the transmitted signal to serial digital data for acceptance by a receiving terminal.

**Modem Eliminator** - A device which interfaces between a local terminal that normally requires a modem and the computer near it that also expects to connect to a modem. Functions as an imitation modem in both directions.

**MSB** - The most significant bit. The leftmost bit.

**Multiplexer** - A device used for division of a transmission facility into two or more subchannels either by splitting the frequency band into narrower bands (frequency division), or by allotting a common channel to several different transmitting devices, one at a time (time division).

**Nibs** - In electrostatic plotting, writing surface contact points housed in the electrostatic plotting head which deposit electrostatic dot charges on coated paper when ON. In thermal transfer plotting, these elements in the thermal printhead are heated to melt ink from a donor roll onto the media.

**Origin** - The (0,0) point of intersection of the coordinate axes from which point coordinates and measurements are referenced.

**Parallel Transmission** - Byte-wide data transmission that allocates a data line for each bit in a word. Transmission is usually unidirectional.

**Partition** - A controller-specific amount of VRF data. When the amount of data for a VRF plot exceeds the buffer capacity of the graphics controller, the host software breaks up the plot into sections at certain X-value intervals. These sections are called partitions.

**Parity Check** - Addition of non-information bits to data, making the number of ones in a byte (bit group) either always odd or always even. This permits detection of errors in blocks that have a single error.

**Pixel** - Short for picture element. A spatial resolution element, comprising the smallest distinguishable and resolvable area in an image. A horizontal line is made up of a fixed number of visible pixels.

**Plot** - The resulting image of the electrostatic or thermal transfer printer/plotter process.

**Plotting Surface** - The physical device on which one or more viewports may be plotted. The plotting surface is defined by the physical plotting limits.

**Polygon** - A closed plane figure bounded by three or more line segments.

**Port** - An interface on a computer configured as data terminal equipment and capable of attaching a modem for communication with a remote data terminal.

**PROM (Programmable Read Only Memory)** - Non-volatile memory chip that allows a program to reside permanently in a piece of hardware.

**Protocol** - A formal set of conventions governing the formatting and relative timing of message exchange between two communicating systems.

## GLOSSARY

**RAM (Random Access Memory)** - Semiconductor read-write volatile memory. Data stored is lost if power is turned off.

**Random Elements** - When Versaplot Color Random software is being used to output data to a Random Element Processor (REP), the VRF commands and associated data as output by the host computer are counted as random elements.

**Raster Scan Line** - An electrostatic charge is deposited on the plotter paper by a single row of wires called NIBS. The linear nib density of a plotter is defined by the number of nibs per inch across the width of the plotting surface. Typically, the linear nib density of a Versatec plotter is either 100, 200, 300 (thermal) or 400 nibs per inch. The data transferred to the paper (charged and uncharged spots) at one time by the row of nibs is called a raster or scan line. The same principle applies to thermal plotting, except the raster line is generated by an array of heated and unheated (as opposed to charged and uncharged) nibs that selectively melt ink onto the media.

**Redundancy Check** - A technique of error detection involving the transmission of additional data related to the basic data in such a way that the receiving terminal, by comparing the two sets of data, can determine to a certain degree of probability whether an error has occurred in transmission.

**Re-origin** - The procedure for relocating (moving) the software origin to a new position from which all coordinate plotting is then to be referenced.

**Reset** - An instruction that orders the processor back to a predetermined state. It usually involves clearing all registers, resetting all flags and clearing all the RAM. Useful when nothing else will break you out of a loop in a program, but it destroys whatever is in memory.

**ROM (Read Only Memory)** - Non-volatile semiconductor memory manufactured with predefined data content, permanently stored.

**RS-232C** - Interface between data terminal equipment and data communication equipment employing serial binary data interchange.

**Scale** - The procedure for applying a uniform drawing factor to all points in a plot.

**Scaling** - The procedure for computing factors by which non-scaled data may be transformed to plottable coordinates that match a particular coordinate axis.

**Serial Transmission** - A method of data transmission in which each bit of information is sent sequentially on a single data channel. Serial transmission is the normal transmission mode for data communications.

**Software Origin** - The programmable origin of the Cartesian coordinate system established by the software system to facilitate plotting. All user's plotting calls are referenced from this software origin which may or may not be coincident with the absolute hardware origin.

**Sync Signal** - The signal employed for the synchronization of scanning.

**Synchronous Transmission** - Transmission in which the data characters and bits are transmitted at a fixed rate with the transmitter and receiver synchronized. Synchronous transmission eliminates the need for start and stop bits.

**Text String** - A sequence of ASCII (not EBCDIC) characters. The leftmost ASCII character is in the most significant byte of the first word.

**Thermal Printhead** - The writing device used in *thermal transfer* plotting. It contains an array of nibs that receives digital pulses which turn on (heat) the nibs to melt ink onto the media.

**Thermal Transfer** - A plotting technology that uses selectively heated nibs in the thermal printhead to melt or *transfer* ink from a donor roll to a sheet of media to produce a plot image.

**Tone Pattern** - An integer array of binary bit patterns used by subroutine TONE when shading bounded areas.

**Toner** - The liquid that deposits pigment on the plotter paper. See **Electrostatic**.

**Unit** - The unit of linear measure used by the plotting software when producing coordinate references.

**Unplottable Elements** - Elements specified for plotting which are not within the allowable plotting window.

**User Coordinates** - Coordinates specified by the user in user's units.

**V.35** - CCITT standard governing data transmission at 48 kbps using 60-108 kHz group band circuits.

**Vector** - The ordered pair (X,Y) in the Cartesian coordinate system, where the printer/plotter paper defines the Cartesian plane. The (X,Y) pair defines a line segment between two points (IX1,IY1) and (IX2,IY2). The X-axis of the Cartesian plane is defined as the direction of paper motion through the printer/plotter, where the paper motion is unidirectional from low value of X to the higher value of X.

**Vector Interrupt** - In a microprocessor, an instruction that sends the machine on to another address. Many important instructions in a microprocessor start with a jump to a vector location in RAM. The address loaded into that location sends the program to the appropriate routine. That way, the designer has more flexibility over where to put the routine to be called as well as what that routine is to be.

**Versatec Parallel Interface** - Versatec's 37-pin, byte-parallel plotter interface. It employs eight data lines that transmit their respective binary bits in parallel at a 1 MB/second rate. Differential logic levels are supported.

**Video** - (Known as picture signal in the EIA Standards) - The picture portion of the signal.

**Viewport** - The rectangular area on the plotter paper where the contents of the window are plotted.

**Window** - If only part of a plot produced by the application is of interest, only that part need appear on the plot. A window (also called a clipping window), defined by the user, determines which application calls (such as DRAW, CIRCLE, POLYGON) get clipped and which do not because they are not visible through the window. The window is defined in user coordinates.

**Word** - A group of 32 adjacent bits treated and addressed as a unit. The word is broken into four 8-bit bytes, the most significant (leftmost) byte of which appears first in the file.



E  
C  
E  
E  
E  
E  
E  
C  
E  
E  
E  
E  
E  
E  
C  
E