

MAR 30 1985

TEAC[®]
5-1/4" FLOPPY
DISK DRIVES

FD-55 Series

- 6 models of 5-1/4" floppy disk drives
- 1/2 the height of conventional drives
- Choice of capacity from 125 KBytes to 1.6 MBytes
- New TEAC LSIs reduce power consumption, increase reliability
- Brushless DC direct drive motor
- High-speed data access

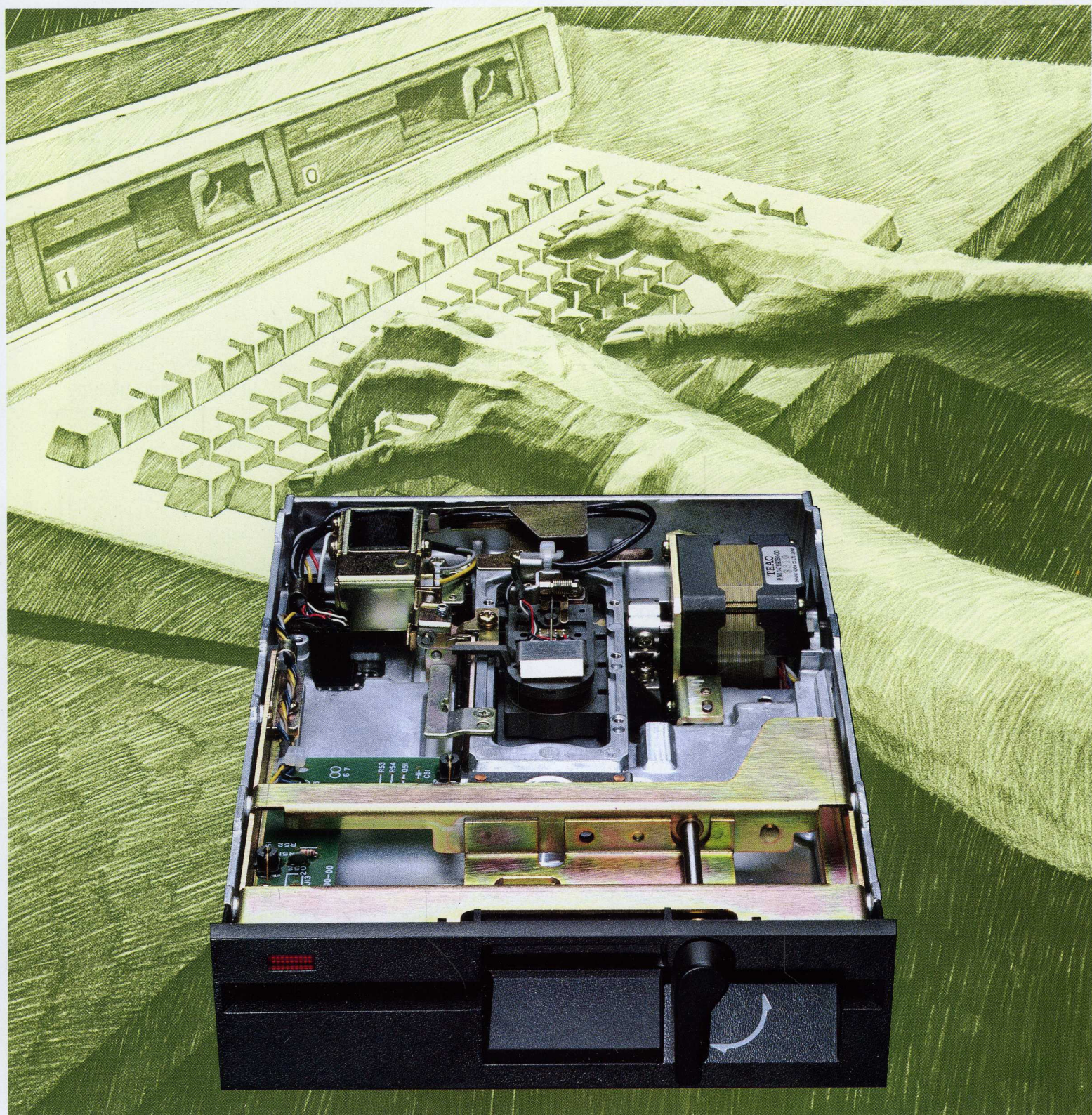

The FD-55 Series Gives You More Performance

1/2-Height Size

All models in the FD-55 Series are only 41 mm high—half the height of conventional drives. You can double your data storage capacity without doubling the space your equipment takes up.

New LSIs

Two new TEAC-developed LSIs handle the control and read/write functions, replacing two PCBs which ate up space in previous models. They provide increased reliability, reduced power consumption (4.9 W while operating), and more space for options.

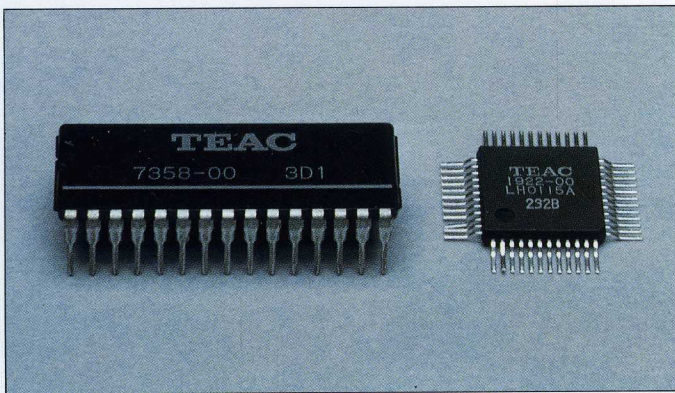

Perfect Disk Registration

The extra space afforded by the LSIs also let TEAC employ a new disk registration method. When the disk is inserted, the spindle motor starts automatically and runs for 10 seconds, ensuring that the disk is perfectly centered when it is clamped down.

Low Power, Heat Generation

TEAC floppy disk drives have always been low power consumers, and the FD-55 models are even more so, due to a new motor and circuitry. This low power consumption makes system planning a whole lot easier. Their low heat generation is important, too, since the compact size means two can be used where one was formerly.

Brushless DC Direct Drive Motor

This motor is so durable (lifetime over 10,000 hours) that it can be left running continuously, so there is no start-up time. And the electrical noise caused by brushes in conventional motors has been eliminated.

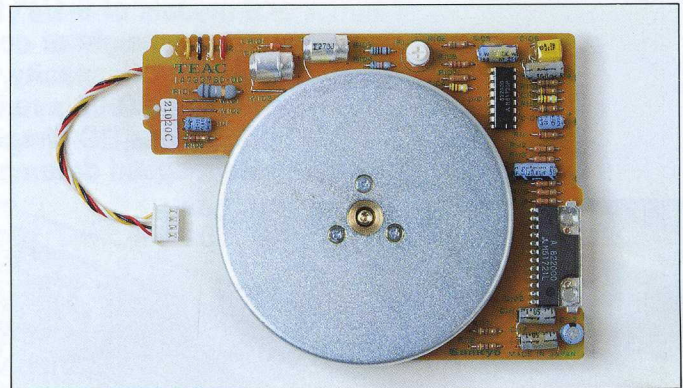

High Speed Access

Data access in the FD-55 series is super-fast. Track-to-track access time is 3 msec. in the E, F and G models, and 6 msec. in the A and B models.

LED/Photo Sensor System

Mechanical sensors have been eliminated in the FD-55 Series. Write protect, index, and track 00 sensing are all done by an LED and photo sensor system. Precision and reliability are both significantly higher.

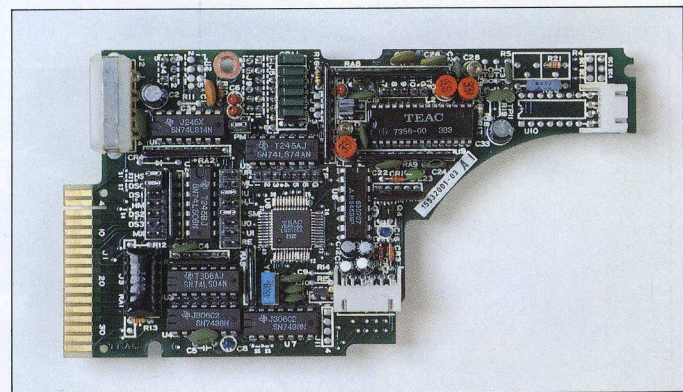

Other features

- Full compatibility with TEAC FD-50 Series
- High-accuracy band positioner
- FM and MFM recording methods
- Protection against accidental erasure
- Voltage-sensing circuit prevents spurious writes when power switched on and off
- Daisy-chain up to four drives
- Optional Head Load Solenoid

FD-55GF

The FD-55GF is the latest refinement in TEAC's outstanding FD-55 series floppy disk drives. What makes this disk drive totally unique is its dual density capability—it's actually two disk drives in one. It can read standard 5-1/4", 48 tpi, normal density, single/double sided disks, as well as read and write normal and high density, 96 tpi, single/double sided disks. These highly popular disk formats are used on many microcomputers which means that the FD-55GF will let you read a wide variety of disk formats. What's more, while the standard 48 tpi, single/double sided disk is limited in capacity, TEAC's FD-55GF floppy disk drive provides a roomy 1.6 MBytes in its high density mode for those jobs requiring large external memory storage. No longer will you be limited by lack of data capacity and the inability to read other disk formats. The FD-55GF—one disk drive that does the work of two.

Choice of 6 Models

- FD-55A**
- Single sided
 - Track density: 48 tpi
 - Tracks/disk: 40
 - Data capacity: 250 KBytes

- FD-55B**
- Double sided
 - Track density: 48 tpi
 - Tracks/disk: 80
 - Data capacity: 500 KBytes

- FD-55E**
- Single sided
 - Track density: 96 tpi
 - Tracks/disk: 80
 - Data capacity: 500 KBytes

- FD-55F**
- Double sided
 - Track density: 96 tpi
 - Tracks/disk: 160
 - Data capacity: 1 MByte

- FD-55G**
- Double sided
 - Track density: 96 tpi
 - Tracks/disk: 154
 - Data capacity: 1.6 MBytes

- FD-55GF**
- High Density
 - Double sided
 - Track density: 96 tpi
 - Tracks/disk: 154
 - Data capacity: 1.6 MBytes

- Normal Density
- Double sided
- Track density: 96 tpi
- Tracks/disk: 160
- Data capacity: 1 MByte

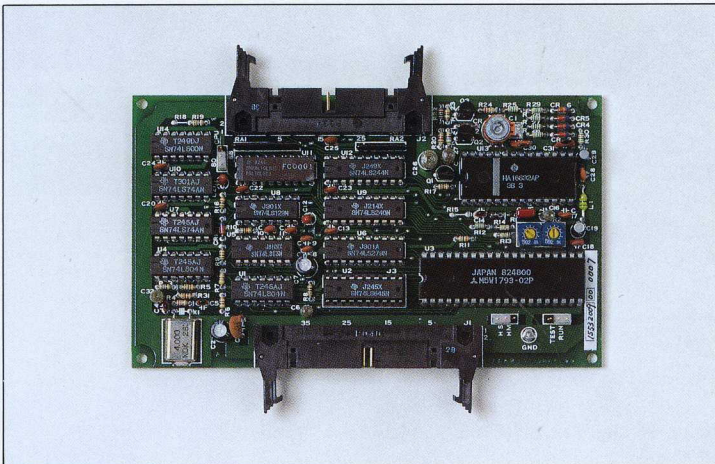

Floppy Disk Controller

The FC-55 5-1/4" Floppy Disk Controller makes interfacing FD-55 Series drives to microprocessors an easy matter. Two versions are available—one for the A, B, E and F models, and one for the G model. The FC-55 is even smaller and more reliable than previous TEAC controllers, thanks to incorporation of the VFO into an LSI.

Multiple Disk Drive Systems Made Easy

The FD-55G-51(L) and FD-55G-56(L)

In addition to the many features of TEAC's FD-55 series Floppy Disk Drives, TEAC offers two special versions of FD-55 series: the FD-55G-51(L) and the FD-55G-56(L). Both disk drives are double sided, 96 tpi, high density, 1.6 MBytes data capacity, 5-1/4" mini floppy disk drives that give you the reliability and performance of all our disk drive products. The special feature of these two drives is that they act in tandem to create a multiple drive system—doubling, tripling, or even quadrupling your external storage capabilities. The FD-55G-51(L) acts as a master FDD incor-

porating a PLO circuit for data acceptance and separation. Up to now, the incorporation of a PLO circuit has been an exclusive option of larger, bulkier 8" disk drives. This new option, along with the large data capacity of the FD-55G-51(L) and the 56(L), means that you can do away with your space-consuming 8" floppy once and for all. Only the master FD-55G-51(L) requires a PLO circuit and host connector/controller. As many as three slave FD-55G-56(L)'s can be "daisy chained" to the master FD-55G-51(L) without using a separate connector—saving you unnecessary connection cost.

Signal Connector Numbers

Connector No.		FD-55A/B/E/F/G		FD-55GF	
Signal	0 V	Signal	Direction	Signal	Direction
2	1	RESERVED		HIGH/NORMAL DENSITY	Input
4	3	IN USE/HEAD LOAD	Input	IN USE/HEAD LOAD	Input
6	5	DRIVE SELECT 3	Input	DRIVE SELECT 3	Input
8	7	INDEX/SECTOR	Output	INDEX	Output
10	9	DRIVE SELECT 0	Input	DRIVE SELECT 0	Input
12	11	DRIVE SELECT 1	Input	DRIVE SELECT 1	Input
14	13	DRIVE SELECT 2	Input	DRIVE SELECT 2	Input
16	15	MOTOR ON	Input	MOTOR ON	Input
18	17	DIRECTION SELECT	Input	DIRECTION SELECT	Input
20	19	STEP	Input	STEP	Input
22	21	WRITE DATA	Input	WRITE DATA	Input
24	23	WRITE GATE	Input	WRITE GATE	Input
26	25	TRACK 00	Output	TRACK 00	Output
28	27	WRITE PROTECT	Output	WRITE PROTECT	Output
30	29	READ DATA	Output	READ DATA	Output
32	31	SIDE ONE SELECT*	Input	SIDE ONE SELECT	Input
34	33	READY	Output	READY	Output

Connector No.		FD-55G-51(L)		FD-55G-56(L)	
Signal	0 V	Signal	Direction	Signal	Direction
2	1	WINDOW	Output	RESERVED	Output
4	3	FM	Input	RESERVED	Input
6	5	DRIVE SELECT 3	Input	DRIVE SELECT 3	Input
8	7	INDEX	Output	INDEX	Output
10	9	DRIVE SELECT 0	Input	DRIVE SELECT 0	Input
12	11	DRIVE SELECT 1	Input	DRIVE SELECT 1	Input
14	13	DRIVE SELECT 2	Input	DRIVE SELECT 2	Input
16	15	MOTOR ON	Input	MOTOR ON	Input
18	17	DIRECTION SELECT	Input	DIRECTION SELECT	Input
20	19	STEP	Input	STEP	Input
22	21	WRITE DATA	Input	WRITE DATA	Input
24	23	WRITE GATE	Input	WRITE GATE	Input
26	25	TRACK 00	Output	TRACK 00	Output
28	27	WRITE PROTECT	Output	WRITE PROTECT	Output
30	29	READ DATA	Output	READ DATA	Output
32	31	SIDE ONE SELECT	Input	SIDE ONE SELECT	Input
34	33	READY	Output	READY	Output

*Side one select signal is only used with double sided FDD.

THE BEST JUST GOT BETTER

The FD-55 series is the culmination of TEAC's long experience in producing 5-1/4" floppy disk drives. The six models in the series provide a wide selection of data storage capacity options: single-sided or double-sided, FM or MFM recording—so total capacity ranges from 125 KBytes to 1.6 MBytes. When first introduced, FD-55 series drives offered a number of distinct advan-

tages over other floppy disk drives, including 41-mm height and 3 msec. track access time. They have now been further improved with the use of two new TEAC LSIs that reduce power consumption, simplify internal layout, and increase reliability. For the finest performance and greatest flexibility in floppy disk drives—choose the TEAC FD-55 Series.

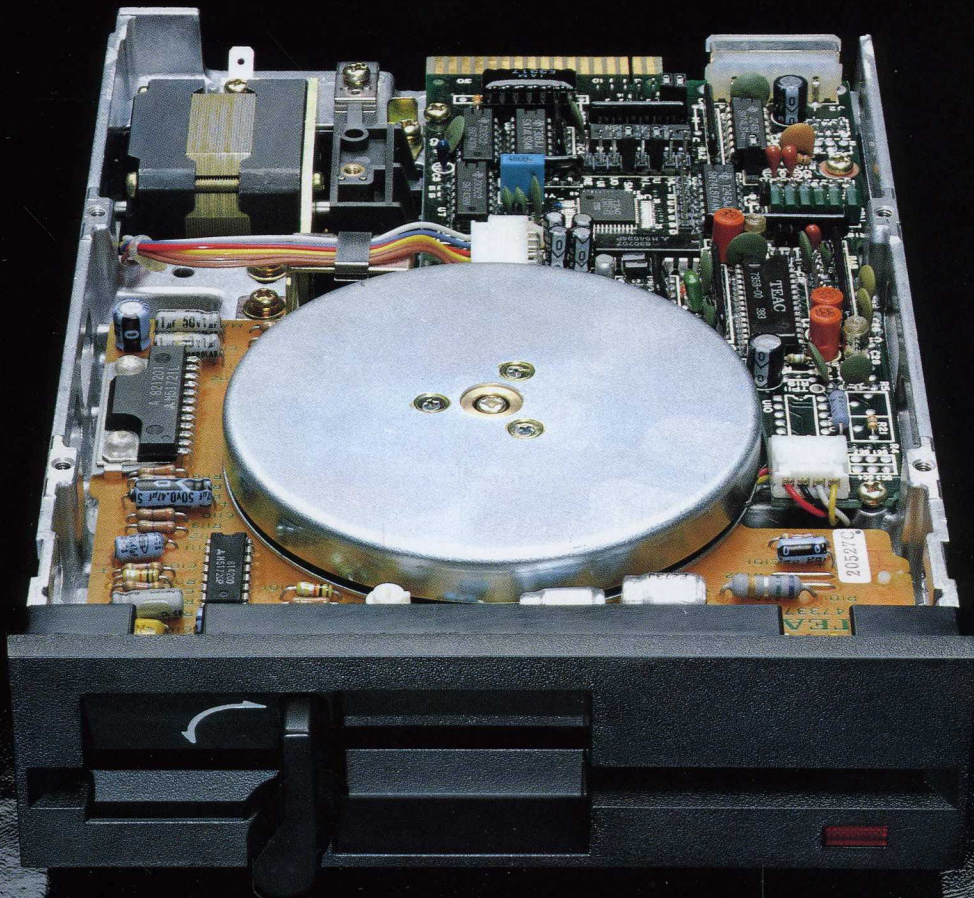

FD-55 rear view

SPECIFICATIONS

Recording Method:

FM (single density), MFM (double density)

Motor Starting Time: 400 ms [400 ms (Normal density) 500 ms (High density)]*

Index: 1

MTBF: more than 10,000 hours

Error Rates

Soft Errors: 1 per 10^9 bits (up to 2 retries)

Hard Errors: 1 per 10^{12} bits

Seek Errors: 1 per 10^6 seeks

Temperature

Operating: 4°—46°C

Transportation: -40°—65°C

Storage: -22°—60°C

Relative Humidity

Operating: 20—80% (noncondensing)

Max. Wet Bulb Temperature: 29°C

Transportation: 5—95% (noncondensing)

Max. Wet Bulb Temperature: 45°C

Storage: 10—90% (noncondensing)

Max. Wet Bulb Temperature: 40°C

Power Requirements

DC + 12 V \pm 5% 0.25 A typ., 0.9 A max.

DC + 5 V \pm 5% 0.38 A typ., 0.6 A max.

[0.45 A typ., 0.55 A max.]

Power Consumption

Operating: 4.9 W [5.25 W]

Non-Operating: 1.6 W [2.0 W]

Dimensions

(W x H x D): 146 x 41 x 203 mm

(5-3/4" x 1-5/8" x 8")

Weight: less than 1.5 kg (3 lbs. 5 oz.)

Component Life: 5 years

Safety Standard: UL and CSA

*[] is FD-55GF.

			FD-55A		FD-55B		FD-55E		FD-55F**		FD-55G***			
			FM	MFM	FM	MFM	FM	MFM	FM	MFM	FM	MFM		
Transfer Rate (K bits/sec)			125	250	125	250	125	250	125	250	250	500		
Capacity (K bytes)	Unformatted	Per Track	3.125	6.25	3.125	6.25	3.125	6.25	3.125	6.25	5.028	10.416		
		Per Disk	125	250	250	500	250	500	500	1,000	802	1,604		
	Formatted (16 sectors/track)*	Per Sector	0.128	0.256	0.128	0.256	0.128	0.256	0.128	0.256	0.256	0.512		
		Per Track	2.048	4.096	2.048	4.096	2.048	4.096	2.048	4.096	3.840	7.680		
			Per Disk	81.92	163.84	163.84	327.68	163.84	327.68	327.68	655.36	591	1,183	
Inside Track Recording Density (bpi)			2768	5536	2938	5876	2788	5578	2961	5922	4823	9646		
Inside Track Flux Density (frpi)			5536		5876		5576		5922		9646			
Tracks/Disk			40		80		80		160		154			
Track Density (tpi)			48				96							
Track Radius (mm)	Outside		57.150		side 0 : 57.150 1 : 55.033		57.150		side 0 : 57.150 1 : 55.033					
	Inside		36.513		side 0 : 36.513 1 : 34.396		36.248		side 0 : 36.248 1 : 34.131		side 0 : 37.042 1 : 34.925			
Average Access Time (ms)			93				94				91			
Track Access Time (ms)			6				3							
Setting Time (ms)							15							
Disk Rotational Speed (rpm)							300				360			

*FD-55G: 15 sectors/track

Also FD-55GF Normal Density *Also FD-55GF High Density
Features and specifications are subject to change without notice.

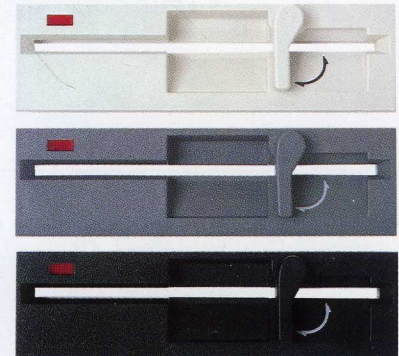
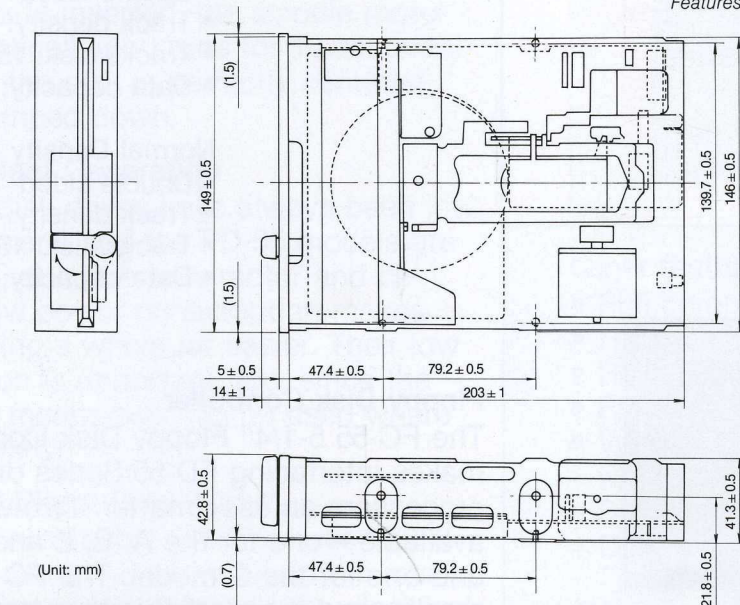

Front panel available in three colors