

**Rank Xerox**

**Cartridge Disk System**

**Models 7250/7251/7252**

**Reference Manual**

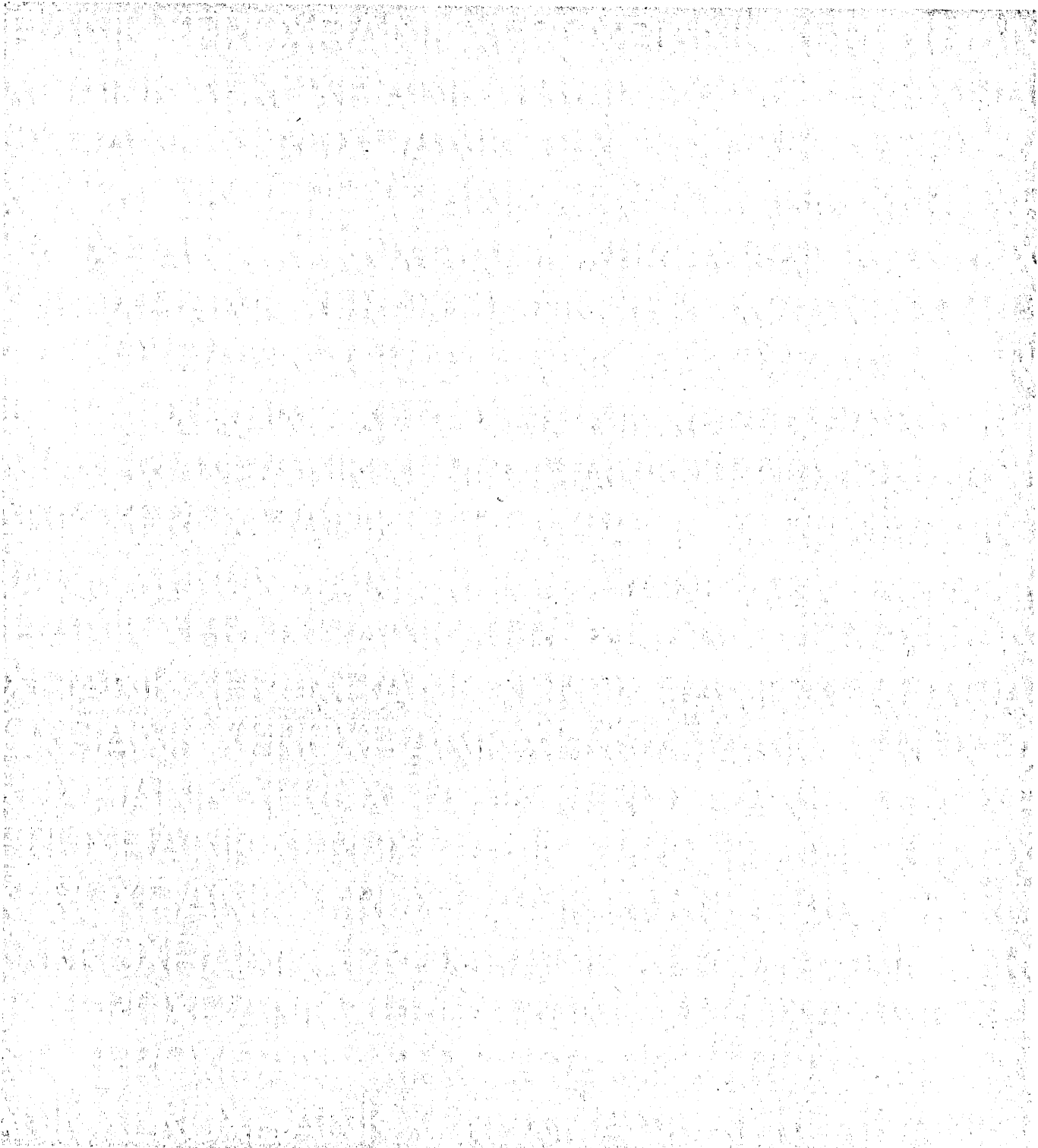

## CARTRIDGE DISK ORDER CODES

<u>Code</u> <u>(Hexadecimal)</u>	<u>Function</u>
01	Write.
02	Read (report any transmission error at count done).
03	Seek.
04	Sense.
05	Check-write.
12	Read (if an error is encountered, terminate the data transfer and report any transmission error at the end of the current sector).
13	Test (for diagnostic purposes only).

**Rank Xerox Xerox Cartridge Disk System**

**Models 7250/7251/7252**

**Reference Manual**

FIRST EDITION

90 30 24A

June 1973

Price: \$1.50

## RELATED PUBLICATIONS

<u>Title</u>	<u>Publication No.</u>
530 Computer/Reference Manual	90 19 60
Sigma 3 Computer/Reference Manual	90 15 92
Sigma 5 Computer/Reference Manual	90 09 59
Sigma 6 Computer/Reference Manual	90 17 13
Sigma 7 Computer/Reference Manual	90 09 50
Sigma 8 Computer/Reference Manual	90 17 49
Symbol/LN,OPS Reference Manual (Xerox 32-bit Computers)	90 17 90
Symbol/LN,OPS Reference Manual (Xerox 16-bit Computers)	90 10 51
Extended Symbol/LN,OPS Reference Manual (Xerox 16-bit Computers)	90 10 52
Meta-Symbol/LN,OPS Reference Manual	90 09 52
Macro-Symbol/LN,OPS Reference Manual	90 15 78

Manual Content Codes: BP - batch processing, LN - language, OPS - operations, RP - remote processing,  
RT - real-time, SM - system management, TS - time-sharing, UT - utilities.

ALL SPECIFICATIONS SUBJECT TO CHANGE WITHOUT NOTICE .

# CONTENTS

<p>1. GENERAL DESCRIPTION <span style="float: right;">1</span></p> <p style="padding-left: 20px;">Introduction _____ 1</p> <p style="padding-left: 40px;">Features _____ 2</p> <p style="padding-left: 40px;">System Components _____ 2</p> <p>2. FUNCTIONAL DESCRIPTION <span style="float: right;">4</span></p> <p style="padding-left: 20px;">Equipment _____ 4</p> <p style="padding-left: 40px;">Model 7250 Controller _____ 4</p> <p style="padding-left: 60px;">Status Response _____ 4</p> <p style="padding-left: 60px;">Cartridge Initialization _____ 4</p> <p style="padding-left: 60px;">Error Checking _____ 4</p> <p style="padding-left: 40px;">Model 7251/7252 Disk Drives _____ 4</p> <p style="padding-left: 60px;">Operator Control Panel _____ 4</p> <p style="padding-left: 60px;">Spindle Assembly _____ 5</p> <p style="padding-left: 60px;">Read/Write Heads _____ 5</p> <p style="padding-left: 60px;">Start-Up Cycle _____ 5</p> <p style="padding-left: 60px;">Write Protect Feature _____ 6</p> <p style="padding-left: 40px;">Model 7254 Disk Cartridge _____ 6</p> <p style="padding-left: 20px;">I/O Operational Flow _____ 6</p> <p style="padding-left: 40px;">Service Cycles _____ 9</p> <p style="padding-left: 60px;">Order Out _____ 9</p> <p style="padding-left: 60px;">Data Out _____ 9</p> <p style="padding-left: 60px;">Data In _____ 9</p> <p style="padding-left: 60px;">Order In _____ 9</p> <p style="padding-left: 60px;">Terminal Order _____ 9</p> <p style="padding-left: 20px;">Disk Organization _____ 9</p> <p style="padding-left: 40px;">Tracks _____ 9</p> <p style="padding-left: 40px;">Sectors _____ 11</p> <p style="padding-left: 40px;">Cylinders _____ 11</p> <p style="padding-left: 20px;">Data Organization _____ 11</p> <p style="padding-left: 40px;">Parity _____ 11</p> <p style="padding-left: 40px;">Cylinder Address _____ 11</p> <p style="padding-left: 20px;">Data Presentation _____ 11</p> <p style="padding-left: 20px;">Data Access _____ 11</p> <p style="padding-left: 40px;">Track and Sector Incrementing _____ 11</p> <p style="padding-left: 40px;">Examples of Automatic Incrementing _____ 12</p> <p style="padding-left: 40px;">Error Conditions _____ 12</p> <p style="padding-left: 20px;">System States _____ 12</p> <p style="padding-left: 40px;">Operational Devices _____ 12</p> <p style="padding-left: 40px;">Data Transfers _____ 13</p> <p style="padding-left: 20px;">Recommendations _____ 13</p> <p>3. PROGRAM INTERFACE <span style="float: right;">14</span></p> <p style="padding-left: 20px;">Device Orders _____ 14</p> <p style="padding-left: 40px;">Write (X'01') _____ 14</p> <p style="padding-left: 40px;">Read (X'02') _____ 14</p> <p style="padding-left: 40px;">Seek (X'03') _____ 14</p> <p style="padding-left: 40px;">Sense (X'04') _____ 15</p>	<p style="padding-left: 40px;">Check-write (X'05') _____ 15</p> <p style="padding-left: 40px;">Read (X'12') _____ 15</p> <p style="padding-left: 40px;">Test (X'13') _____ 15</p> <p style="padding-left: 60px;">Test Mode 1 _____ 15</p> <p style="padding-left: 60px;">Test Mode 2 (Check-write) _____ 15</p> <p style="padding-left: 60px;">Test Mode 2 (Read) _____ 16</p> <p style="padding-left: 20px;">Key Events _____ 16</p> <p style="padding-left: 40px;">Start Input/Output _____ 16</p> <p style="padding-left: 40px;">Unusual End Conditions _____ 16</p> <p style="padding-left: 40px;">Channel End Conditions _____ 16</p> <p style="padding-left: 40px;">Fault Conditions _____ 16</p> <p style="padding-left: 40px;">Transmission Error Conditions _____ 16</p> <p style="padding-left: 40px;">Incorrect Length Conditions _____ 16</p> <p style="padding-left: 20px;">Status Response _____ 17</p> <p style="padding-left: 40px;">Overflow and Carry Indicators _____ 17</p> <p style="padding-left: 40px;">Condition Codes _____ 17</p> <p style="padding-left: 40px;">Device Status Byte _____ 17</p> <p style="padding-left: 40px;">Operational Status Byte _____ 17</p> <p style="padding-left: 20px;">Additional Programming Considerations _____ 20</p> <p style="padding-left: 40px;">Information Protection _____ 20</p> <p style="padding-left: 40px;">Command Chaining and Data Chaining _____ 20</p> <p style="padding-left: 20px;">I/O Interrupt Environment _____ 20</p> <p style="padding-left: 40px;">IOCD Flag: Xerox 530 and Sigma 3 Computers _____ 20</p> <p style="padding-left: 40px;">IOCD Flags: Xerox Sigma 5/6/7/8 Computers _____ 20</p> <p style="padding-left: 40px;">Sequence of Activity _____ 20</p> <p>4. OPERATIONS <span style="float: right;">27</span></p> <p style="padding-left: 20px;">Control Panels _____ 27</p> <p style="padding-left: 40px;">Operator Control Panel _____ 27</p> <p style="padding-left: 60px;">LOAD/RUN Switch _____ 27</p> <p style="padding-left: 60px;">LOAD Indicator _____ 27</p> <p style="padding-left: 60px;">READY Indicator _____ 27</p> <p style="padding-left: 60px;">CHECK Indicator _____ 27</p> <p style="padding-left: 60px;">PROTECT Indicator _____ 27</p> <p style="padding-left: 40px;">Controller Maintenance Panel _____ 28</p> <p style="padding-left: 20px;">Operating Procedures _____ 29</p> <p style="padding-left: 40px;">General Operating Practices _____ 29</p> <p style="padding-left: 40px;">Disk Drive Interlocks _____ 29</p> <p style="padding-left: 40px;">System Power Turn On Procedure _____ 29</p> <p style="padding-left: 40px;">Disk Drive Start Up Procedure _____ 29</p> <p style="padding-left: 40px;">Cartridge Loading and Unloading Procedures _____ 31</p> <p style="padding-left: 40px;">Disk Drive Stopping Procedure _____ 31</p> <p style="padding-left: 40px;">System Power Turn Off Procedure _____ 31</p> <p style="padding-left: 20px;">Cartridge Procedures _____ 33</p> <p style="padding-left: 40px;">General Handling Procedures for Cartridges _____ 33</p> <p style="padding-left: 40px;">Labeling Cartridges _____ 33</p> <p style="padding-left: 40px;">Inspecting Cartridges _____ 33</p> <p style="padding-left: 40px;">Cleaning Procedures _____ 34</p> <p style="padding-left: 40px;">Storing Cartridges _____ 34</p> <p style="padding-left: 40px;">Usage Log _____ 34</p>
---	--

## FIGURES

1. Cartridge Disk System Configuration	1
2. Sketch of Model 7251/7252 Disk Drive	5
3. Read/Write Heads	6
4. Model 7254 Disk Cartridge	6
5. I/O Operational Flow – Xerox 530 and Sigma 3	7
6. I/O Operational Flow – Xerox Sigma 5/6/7/8	8
7. Disk Organization	10
8. Disk I/O Program/Cartridge Disk System Actions	21
9. Write Order	22
10. Read Order	23
11. Seek/Sense Order	24
12. Check-write Order	25
13. Test Order	26
14. Disk Drive Operator Control Panel	27
15. Controller and Maintenance Panel	28
16. Power Distribution Panel	30
17. PT20C Power Supply	30
18. Opening Cartridge Holding Clamps	32

19. Removing Bottom Cover from Disk	32
20. Loading and Unloading a Cartridge	32
21. Placing Bottom Cover over Cartridge	32

## TABLES

1. Cartridge Disk System Components	2
2. Characteristics	2
3. Conditions	12
4. State Transitions	12
5. Orders	14
6. Test Mode Selection	15
7. Overflow and Carry Indicators, and Condition Codes	17
8. Device Status Byte for SIO, TIO, and HIO Instructions	18
9. Device Status Byte for TDV and AIO Instructions	19
10. Device Status Byte for TDV in Test Mode Operation	19
11. Operational Status Byte	20
12. Operator Control Panel Summary	28

# 1. GENERAL DESCRIPTION

## INTRODUCTION

The Xerox Model 7250/7251/7252 Cartridge Disk System provides fast, auxiliary, random-access memory for Xerox computers. It is a moving-head, rotating disk system for use as secondary storage with Xerox 530 and Sigma 3 computers (16-bit words), as well as with Sigma 5/6/7/8 computers (32-bit words). Cartridge disks may be utilized for system, processor, and public library residence, for on-line permanent file storage, and for temporary file storage. By combining high performance with low cost, the Cartridge Disk System offers a flexible solution to the data handling problems encountered by system designers.

A Cartridge Disk System includes a Model 7250 Controller, which accommodates as many as four disk drives (see Figure 1). The drives, which may be any desired combination of Model 7251/7252 Disk Drives, employ the Model 7254 Disk Cartridge as a storage medium. Each controller accommodates a storage capacity of up to 18.4 million bytes. Each drive has a capacity of either 2.3 million bytes (7251 drive with one disk cartridge) or 4.6 million bytes (7252 drive with one disk cartridge and one fixed disk). The term disk as used in this manual implies a single circular plate with two recording surfaces.

In order to use this manual effectively, the reader must be familiar with the applicable Xerox computer reference

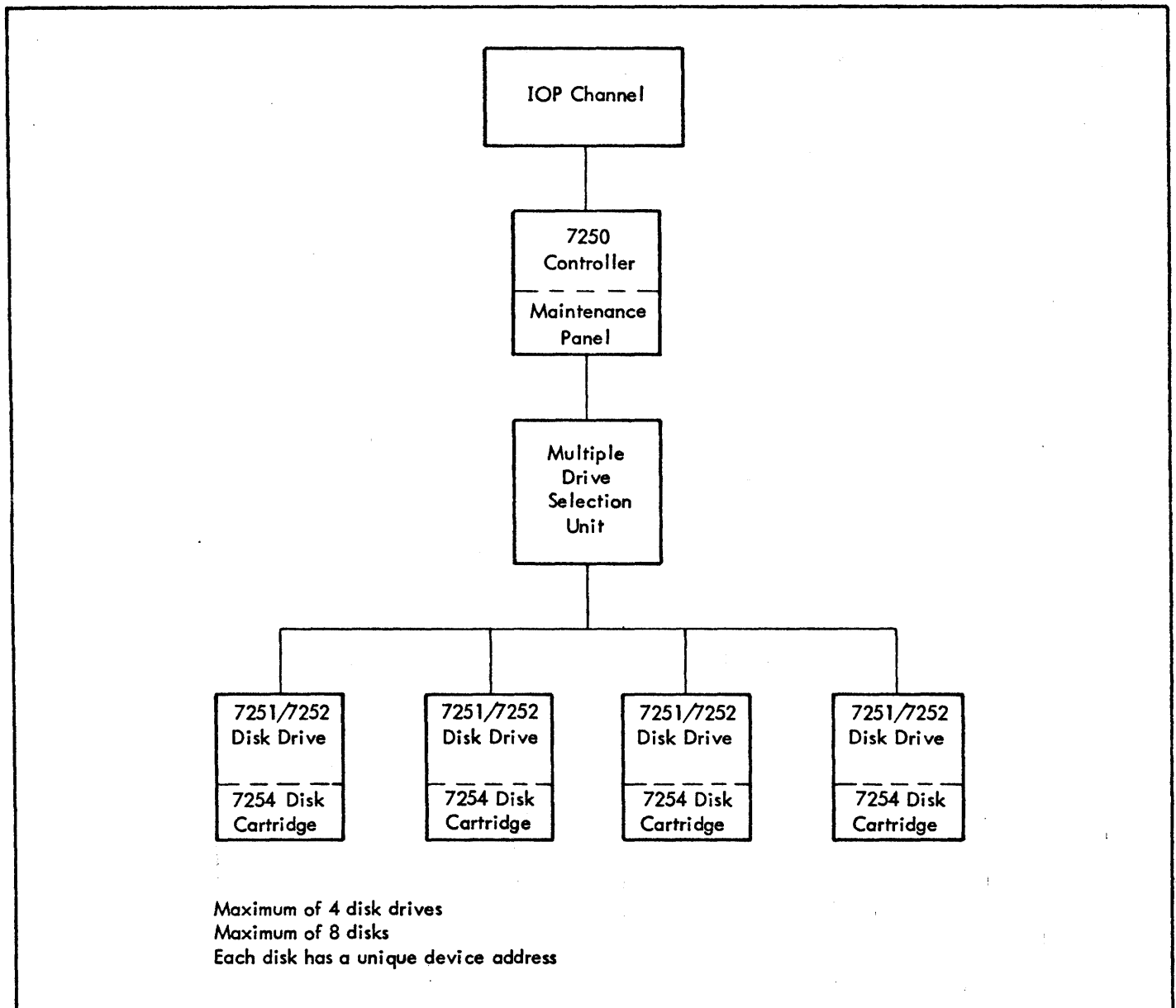

Figure 1. Cartridge Disk System Configuration

manual, particularly the chapters on input/output instructions and operations; see "Related Publications" at the front of this manual.

### FEATURES

Several significant equipment features affect system performance and the reliability of recorded data:

- A fully integrated spindle/blower assembly contributes to excellent device reliability.
- A noncontacting transducer ensures accurate and reliable control of the head positioner.
- The transfer rate of 312,000 bytes/second is normally available only on more expensive disk systems.
- An integrated controller maintenance panel facilitates off-line servicing of the equipment.
- Stray magnetic flux at the read/write heads is negligible, eliminating a common cause of disk errors.
- The disk contents are permanently protected against primary power failure.

Other features that have programming implications:

- Each disk contains 408 tracks and each track is divided into 16 sectors.
- Data are recorded on the disk surfaces in fixed-length sectors of 360 bytes. The controller zero-fills the sector for a record of less than 360 bytes.
- The controller automatically increments sector and track addresses, and hence a record can extend from sector to sector and from track to track.
- Access time is 12 msec, track to adjacent track, and 38 msec average.
- A write-protect feature ensures total file protection.
- The simplified system design makes I/O programming less complex than that required for conventional disk systems.

### SYSTEM COMPONENTS

Table 1 summarizes the system components described in this section, while Table 2 presents the operating, physical, and environmental characteristics.

Table 1. Cartridge Disk System Components

Model	Component	Prerequisite Component
7250	Controller that serves up to four Model 7251/7252 Disk Drives	IOP channel
7251	Disk Drive providing a storage capacity of 2.3 million bytes. Employs the Model 7254 Disk Cartridge.	7250
7252	Disk Drive providing a storage capacity of 4.6 million bytes. Employs the Model 7254 Disk Cartridge, as well as a fixed disk.	7250
7254	Disk Cartridge containing a single disk (one plate with two recording surfaces).	7250, and either a 7251 or a 7252

Table 2. Characteristics

Operating Characteristics	
Recording format	360 bytes/sector 16 sectors/track 2 tracks/cylinder 204 tracks/surface 1 head/surface 2 recording surfaces/disk
Density	
Lateral track	100 tracks/inch
Capacity (innermost track)	2200 bits/inch
Recording method	Track serial
Mode	Double frequency
Recording frequency	2.50 Mhz
Rotational speed	2400 rpm
Total time per revolution	25 msec
Intersector gap time	203 μsec
Sector-to-sector time	1.56 msec
Effective read/write bitrate	2,500,000 bits/second
On-line capacity (sectored)	2,350,000 bytes/disk



Table 2 Characteristics (cont.)

Operating Characteristics (cont.)	
Nominal access time (positioning)	
Seek	12 msec track to adjacent track 38 msec average (12-75 msec)
Rotational latency	12.5 msec (0-25 msec)
Transfer rates	
Instantaneous (per sector)	312,000 bytes/second
Average (multiple sector)	230,000 bytes/second
Physical Characteristics	
Standard equipment cabinet	
Height	63.5 in. <i>1620 mm</i>
Width	32 in. <i>814 mm</i>
Depth	35 in. <i>890 mm</i>
Model 7250 Controller	
Height	20 in.
Width	24 in.
Depth	10 in.
Weight	40 lb
Model 7251/7252 Disk Drive	
Height	10.3 in.
Width	17.5 in.
Depth	28.5 in.
Weight	150 lb
Environmental Characteristics	
Power requirements	
Service	120 vac, 60 Hz, single-phase
Start	1.8 kva
Run	Controller, 250 watts Drive, 800 watts
Operating temperature	50° to 104° F (10° to 40° C)
Operating humidity (relative)	25% to 80%
Thermal dissipation	
Model 7250	850 btu/hr
Model 7251/7252	160 btu/hr
Cable lengths (IOP to 7250)	40 ft maximum

Table 2. Characteristics (cont.)

Operating and Physical Characteristics of Model 7254 Disk Cartridge	
Recording surfaces/cartridge	2
Disk surface coating	Magnetic oxide
Disk cartridge	
Diameter	15.01 in. <i>382 mm</i>
Height	2.4 in. <i>61 mm</i>
Weight	5 lb <i>2,271g</i>

The minimum configuration (2.3 million bytes) is

- One 7250 controller
- One 7251 disk drive
- One 7254 disk cartridge

The maximum configuration (18.4 million bytes) is

- One 7250 controller
- Four 7252 disk drives
- Four 7254 disk cartridges

Auxiliary equipment includes a multiple-drive selection unit, a power distribution panel, a power filter, a PT20C power supply, and the required cables.

The controller permits the intermixing of 7251 and 7252 disk drives. Disk drives are the electro-mechanical devices containing the read, write, and control circuitry required to record data on disk surfaces. The controller and two drives share a standard Xerox cabinet; additional drives are housed in additional cabinets.

The 7251 disk drive provides a total storage capacity of 2.3 million bytes and is the drive mechanism for the disk cartridge. The drive is mounted in a drawer that slides out in order to load and unload cartridges and to service the equipment. The 7252 drive differs from the 7251 by providing an additional 2.3 million bytes of fixed disk storage - a second disk shares the head positioner and the spindle with the cartridge.

The 7254 contains a single disk enclosed in protective covers. After removing the bottom cartridge cover and pulling out the equipment drawer, the cartridge may be loaded onto the drive spindle from the top.

## 2. FUNCTIONAL DESCRIPTION

This chapter functionally describes the Cartridge Disk System. It begins with the principal system components and the flow of information between these components; continues with the organization of tracks and sectors on the disk surfaces and the organization of data within a sector; and concludes with the system states and a list of recommendations for system usage.

### EQUIPMENT

In addition to presenting the functional characteristics of the controller, disk drives, and disks, this section describes and illustrates some of the physical features of the equipment. The descriptions introduce the equipment terminology used throughout this manual and are intended as background information only. System designers, programmers, and operators who have previous experience with disk equipment may prefer to skip this section.

#### MODEL 7250 CONTROLLER

Physically, the controller is installed in the upper portion of a standard Xerox equipment cabinet, which it shares with one or two disk drives. Located adjacent to the controller is its maintenance panel used by customer service engineers for testing purposes and in order to perform individual operations. The controller consists of electronic circuitry that enables it to interact with the IOP and, via the multiple-drive selection unit, to direct each of its disk drives. (The multiple-drive selection unit allows the selection of any of four drives and of either the cartridge or the fixed disk.)

Functionally, the controller accepts and interprets I/O instructions; requests and interprets device orders, such as Seek, Read, and Write; and directs the disk drives in their execution of these instructions and orders. During an I/O operation, the controller transfers data between the IOP and one of the disk drives. In addition, the controller sets and returns the status response after each I/O instruction and device order has been executed; handles the initialization of new cartridges; and performs error checks as data are being transmitted.

#### STATUS RESPONSE

Following the acceptance (and possibly the execution) of an I/O instruction, the controller reports the device condition — ready, busy, or not operational. The controller also reports whether or not the device address was recognized and whether or not the I/O instruction was accepted. Similarly, after the execution of a device order, the controller reports the type of termination, e.g., channel end, unusual end, transmission error.

#### CARTRIDGE INITIALIZATION

New cartridges must be initialized before data can be recorded on them. The initialization process, which is performed by the controller, consists of writing the cylinder address in each sector of the disk and of writing the sector marks. Cylinders and sectors are defined under "Disk Organization."

#### ERROR CHECKING

In order to detect errors in data transmission, the controller computes the parity for each sector. During a write operation, the controller computes and writes a parity byte in each accessed sector. Subsequently, during a read operation, the controller recomputes the parity and compares it with the prestored parity. The controller also checks the cylinder address each time the read/write heads are moved. During a seek operation, the controller moves the heads to the requested track and sector and then checks the prestored cylinder address to ensure that the heads are correctly positioned.

#### MODEL 7251/7252 DISK DRIVES

A sketch of a disk drive — with the cartridge unloaded and the key assemblies annotated — appears in Figure 2. Together these assemblies rotate the disk, align the read/write heads over the disk cylinders, and perform data writing and reading functions. The drive is mounted in a standard Xerox cabinet and is supported on slide rails that attach the drive to the cabinet. The slide rails allow the drive to be pulled out in order to gain access to all assemblies for servicing. The slide rails and the drive assemblies are collectively referred to as the "equipment drawer". Several assemblies, such as the operator control panel, spindle assembly, and read/write heads, are described below; those that are omitted, such as the electronic card cage and the heat sink electronics, contain circuitry — the descriptions of which are beyond the scope of this manual.

#### OPERATOR CONTROL PANEL

The operator control panel, which appears at the front of the drive in Figure 2, has a LOAD/RUN switch and four indicator lamps. These are described briefly below and detailed in Chapter 4.

- LOAD/RUN is a two-position switch that starts and stops the disk drive. The LOAD position allows cartridges to be loaded and unloaded. The RUN position starts the disk drive and brings it up to operating speed in about 60 seconds.
- The LOAD indicator, when lighted, indicates that cartridges may be loaded and unloaded.

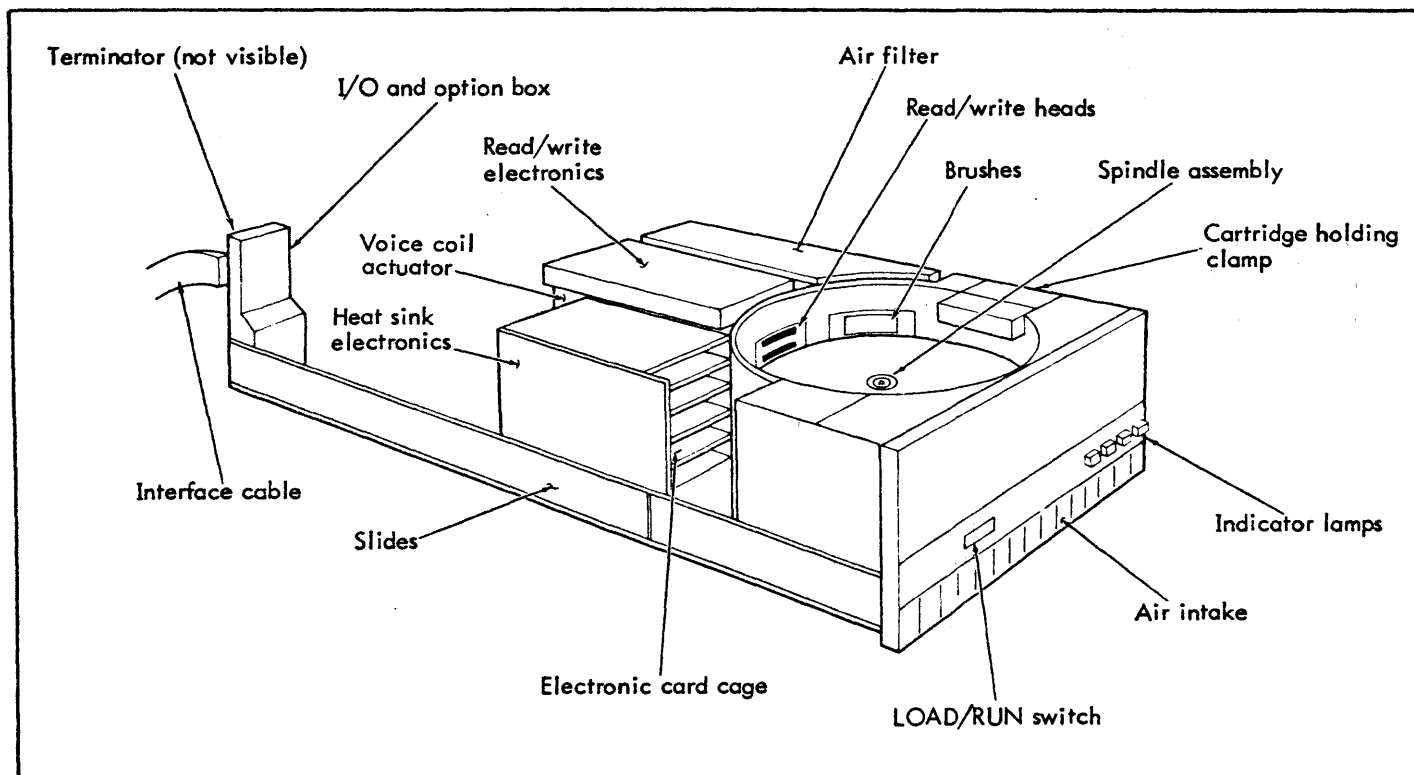

Figure 2. Sketch of Model 7251/7252 Disk Drive

- The READY indicator, when lighted, indicates that the disk drive has completed its start-up cycle and is ready to accept orders, such as Seek, Read, and Write, from the disk I/O program.
- The CHECK indicator, when lighted, indicates that because of a hardware fault the disk drive may be incapable of writing.
- The PROTECT indicator, when lighted, indicates that the disks are write-protected. To allow writing, the operator depresses PROTECT and the light will be extinguished.

#### SPINDLE ASSEMBLY

The spindle assembly rotates both the cartridge and the fixed disk (if any). On the 7252 disk drive, the fixed disk is an integral part of the spindle assembly and is attached just above the motor. The cartridge, which fits at the upper end of the motor drive shaft, is held to the spindle by a mechanical latch and a magnetic ring. The cylindrical depression into which the cartridge fits is referred to as the spindle bowl, and its center is the spindle hub. During the start-up cycle, described in a later section, the spindle begins rotating the disks, and the start-up logic monitors for an up-to-speed condition.

#### READ/WRITE HEADS

The read/write heads transmit data to or from the disk by means of standard electromagnetic recording techniques.

One head functions on each disk surface. In Figure 2, the heads are located toward the back of the spindle bowl and they appear physically as shown in Figure 3. Each read/write head consists of three separate head coils: one head coil reads or writes and the other two erase to limit the physical width of data tracks on the disk surface. The heads are mounted on arms that move from the periphery of the disk towards its center, locating the heads laterally along the disk surfaces in order to position them over any of the 204 cylinders.

#### START-UP CYCLE

The start-up cycle begins when the LOAD/RUN switch on the operator control panel is set to RUN. During this cycle, the spindle and the disks begin rotating, and cleaning brushes pass over each surface in order to remove contamination. When the disk is up to speed, the read/write heads move from their retracted position beyond the disk surfaces to cylinder 0 at the extreme outer edge of the disk. The heads are automatically lowered toward the disk surfaces and are maintained there by a compression spring. They are then in the loaded flying position and fly approximately 80 microinches off the disk surfaces.

In addition, the start-up logic turns on Write-protect, described next, and controls the interlocks and other safety devices that guard against accidental loss of data. The READY indicator on the operator control panel will light when the start-up cycle is completed.

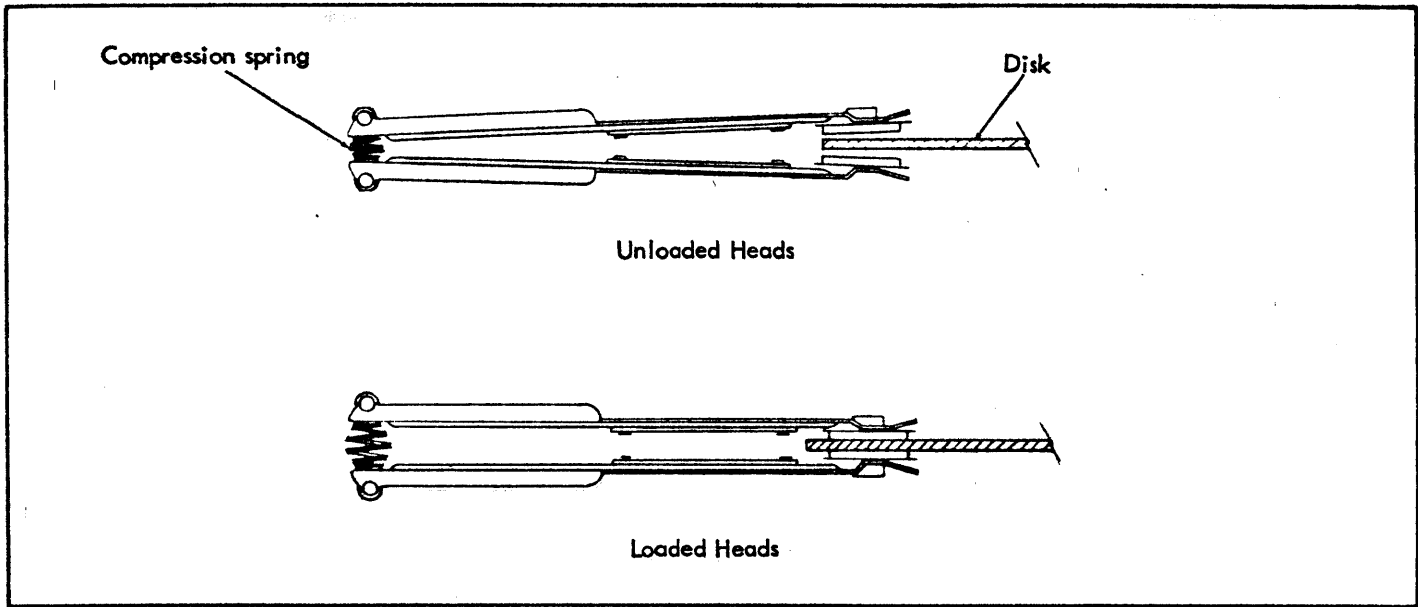

Figure 3. Read/Write Heads

### WRITE PROTECT FEATURE

The Write-protect feature guards against inadvertent writing. During the start-up cycle, the disk drive sets Write-protect on, which inhibits the write and erase circuits, and the PROTECT indicator on the operator control panel will light. However, when data are to be written on the disk, the operator must depress PROTECT to extinguish the light and to set an internal flip-flop that enables the writing process — the surfaces are no longer protected.

### MODEL 7254 DISK CARTRIDGE

A sketch of a disk cartridge appears in Figure 4. The disk, which is enclosed in protective covers, may be loaded onto the drive spindle whenever the LOAD indicator on the operator control panel is lighted. When loading a cartridge, the bottom cover must always be inverted and placed over the cartridge. The holding clamps (see Figure 2) maintain the cartridge in its correct operating position in the drive. These clamps cannot be operated while the read/write heads or the cleaning brushes are positioned over the disk surfaces, or when the equipment power is off. On the 7252 disk drive, the fixed disk is fitted beneath the spindle bowl and is magnetically and physically similar to the cartridge disk.

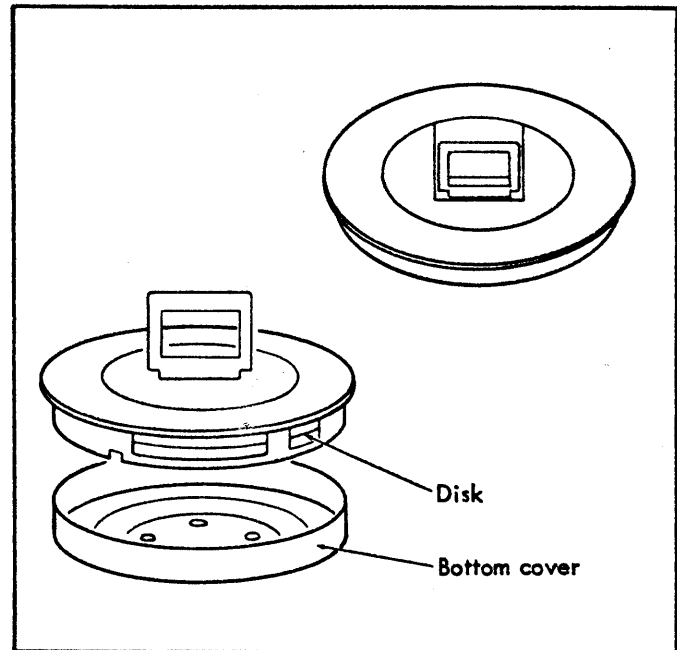

Figure 4. Model 7254 Disk Cartridge

the system. During and after an I/O operation, the controller transmits the status response to specific registers, whose contents then may be analyzed to determine the result of the operation. Significant registers and tables appear in the diagrams.

### I/O OPERATIONAL FLOW

Figure 5, which illustrates the flow of information between system components, applies to the Xerox 530 and Sigma 3 computers. Figure 6 is the corresponding diagram for the Sigma 5/6/7/8 computers. The purpose of these diagrams is to define the source and destination of critical items of information. Before an I/O operation can begin, specific registers must be set and tables must be made available to

Chapter 3 describes the device orders interpreted by the controller and the disk drives. It also defines the Overflow and Carry indicators, the Condition Codes, and the Device Status Byte for each I/O instruction, and defines the flags in the Operational Status Byte. The applicable Xerox computer reference manual, however, describes the I/O instructions, the types of acceptable tables, and the required register contents.

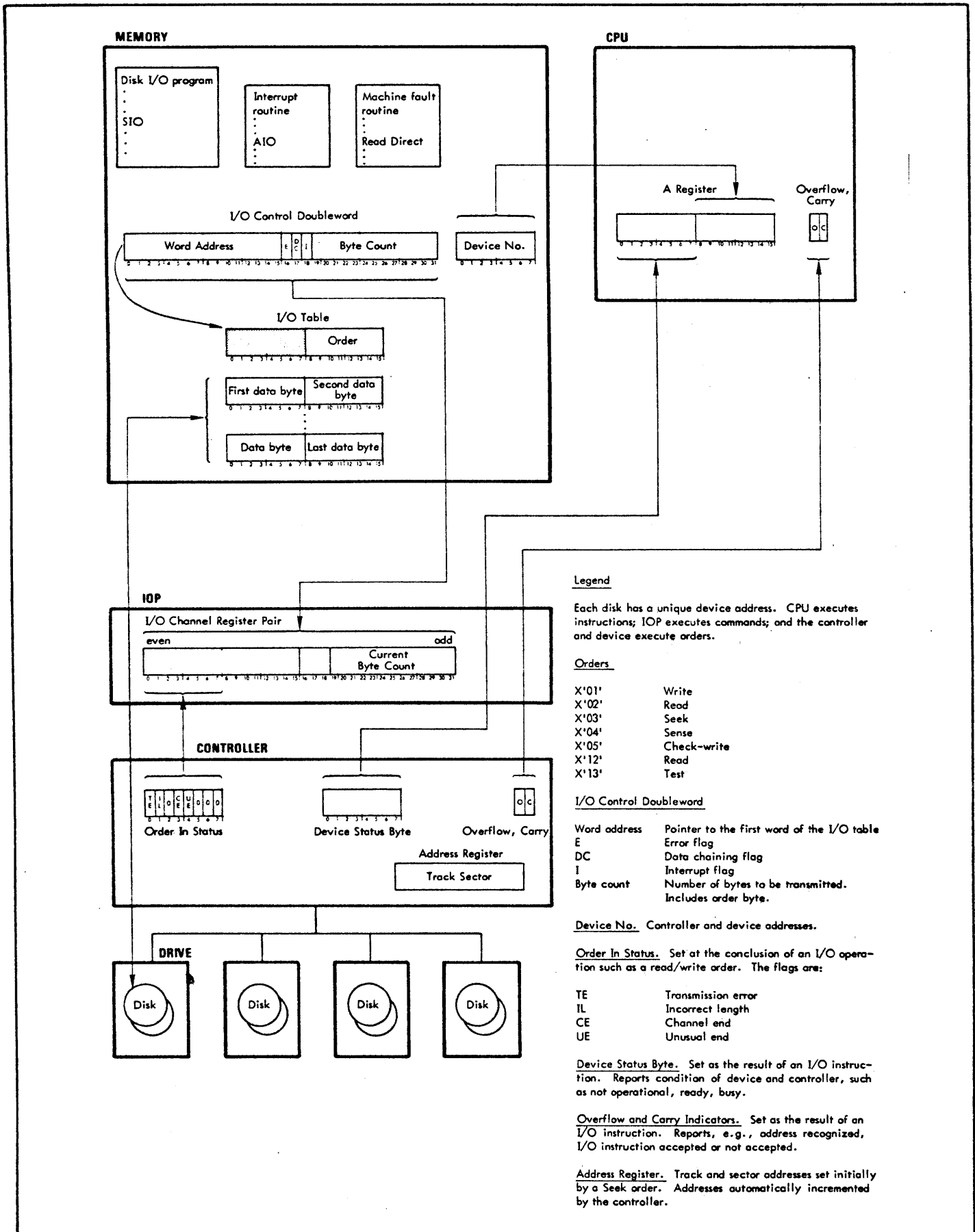
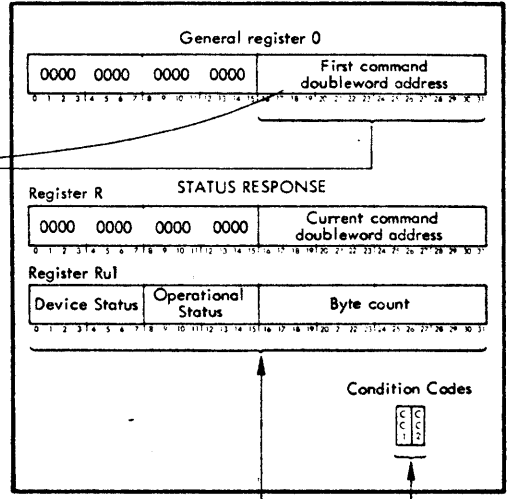
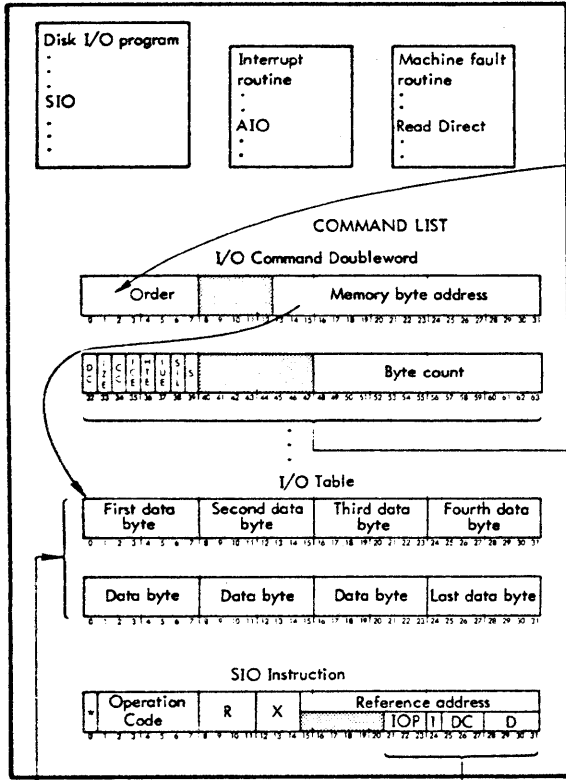

Figure 5. I/O Operational Flow - Xerox 530 and Sigma 3

**MEMORY**

**CPU**



**Legend**

Each disk has a unique device address. CPU executes instructions; IOP executes commands; and the controller and device execute orders.

Orders	
X'01'	Write
X'02'	Read
X'03'	Seek
X'04'	Sense
X'05'	Check-write
X'12'	Read
X'13'	Test

**I/O Command Doubleword**

Memory byte address	Pointer to the first byte
DC	Data chaining flag
IZE	Interrupt at zero byte count
CC	Command chaining flag
ICE	Interrupt at channel end
HTE	Halt on transmission error
IUE	Interrupt at unusual end
SIL	Suppress incorrect length
S	Skip
Byte count	Number of bytes to be transmitted

**SIO instruction**

R	General register that is to contain the first word of the status response
DC and D	Device controller and device addresses
Register 0	Pointer to the first command doubleword

**Status Response.** Program may request a 2-word or a 1-word status response, or none.

**Current command doubleword address:** pointer to the current doubleword in the command list.

**Device Status:** Reports condition of the device and controller such as not operational, ready, busy.

**Operational Status (Order In Status):** Reports transmission error, incorrect length, channel end, and unusual end.

**Byte count:** number of bytes yet to be transmitted.

**Condition Codes.** CC1 and CC2 report, e.g., address recognized, I/O instruction accepted or not accepted.

**Address Register.** Seek order initially sets track and sector addresses. Controller automatically increments.

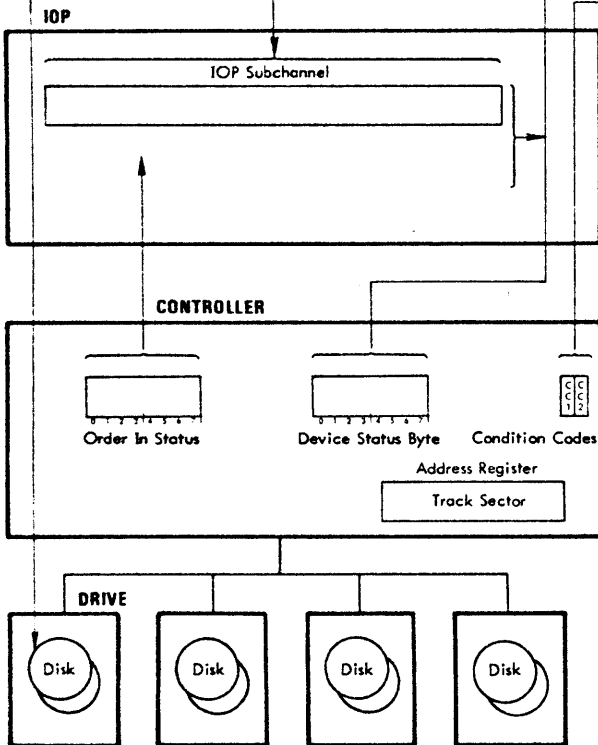

Figure 6. I/O Operational Flow - Xerox Sigma 5/6/7/8

## SERVICE CYCLES

Four service cycles take place during data transfers between memory and the disk. The IOP and the controller continually interact during these service cycles — reporting status, errors, and the successful conclusion of operations. The descriptions presented below do not include information on I/O instructions (or on Overflow and Carry indicators, Condition Codes, or the Device Status Byte) since the relevant I/O instruction has already been executed when these cycles occur.

The following service cycles occur:

- Order Out relates to an order, e.g., Seek or Write, sent to disk.
- Data Out relates to the writing of data on the disk.
- Data In relates to the reading of data from the disk.
- Order In relates to the Operational Status Byte.

### ORDER OUT

The Order Out service cycle specifies the operation to occur next. An Order Out cycle, for example, always occurs after a successful SIO instruction and is always initiated by the controller. In effect, the controller signals the IOP for an order, and the IOP fetches the order and sends it to the controller for execution. During this cycle, the IOP also stores the byte count, flags, and memory address in its internal registers.

### DATA OUT

The Data Out service cycle transfers data from memory to the disk. The IOP accesses the memory location pointed to by the address field of the IOCD, checks the flags, adjusts the byte count, sets operational flags or error indicators, and transfers the data to the controller. The controller in turn directs the disk drive to write the data on the disk. The IOP terminates this cycle with or without a Terminal Order, based on the channel condition.

### DATA IN

The Data In service cycle transfers data from the disk to memory. The IOP accepts the data from the controller, checks the flags, adjusts the byte count, sets any required operational flags or error indicators, and stores the data beginning at the memory location pointed to by the address field of the IOCD. The IOP terminates this cycle with or without a Terminal Order, based on the channel condition.

### ORDER IN

The Order In service cycle transfers the status from the controller to the IOP. The IOP always terminates this cycle

with a Terminal Order. The following flags will appear in the Operational Status Byte:

Transmission Error.	
Incorrect Length.	Byte count error.
Channel End.	The controller encountered a normal channel end.
Unusual End.	The controller encountered an unusual end condition.

## TERMINAL ORDER

For the Order Out or Order In service cycles, the IOP always sends a Terminal Order (one byte) to the controller before terminating the service cycle. For the Data Out or Data In service cycles, the IOP sends a Terminal Order only when an IOP halt is detected or a zero byte count exists; otherwise, the IOP signals the controller to disconnect without a Terminal Order.

The bits in the Terminal Order byte have the following significance:

Bit 0	Interrupt. A value of 1 triggers an interrupt signal.
Bit 1	Count Done. This bit is set to 1 if the byte count is reduced to zero and the data chaining flag is set to 1.
Bit 2	Command chain. This bit is set to 1 if the command chaining flag is set to 1.
Bit 3	IOP halt. This bit is set to 1 when the IOP halts as the result of an error.
Bit 4	Address error. This bit is set to 1 if the IOP sensed a parity error in the device address during the service cycle.
Bits 5-7	Reserved.

## DISK ORGANIZATION

The upper portion of Figure 7 illustrates the organization of tracks (concentric circles) and sectors (sector marks) on a disk, while the lower portion illustrates the sector format. Each disk has 408 tracks, 16 sectors on each surface, and 204 cylinders. The track, sector, and cylinder addresses given below are identical for all disks, irrespective of the total number in a system.

### TRACKS

The track addresses begin at the periphery of the disk and continue in ascending order toward the center. The

Top: sectors numbered 0, 1, ..., 15  
 Bottom: sectors numbered 0, 1, ..., 15

Top: even-numbered tracks 0, 2, ..., 406  
 Bottom: odd-numbered tracks 1, 3, ..., 407

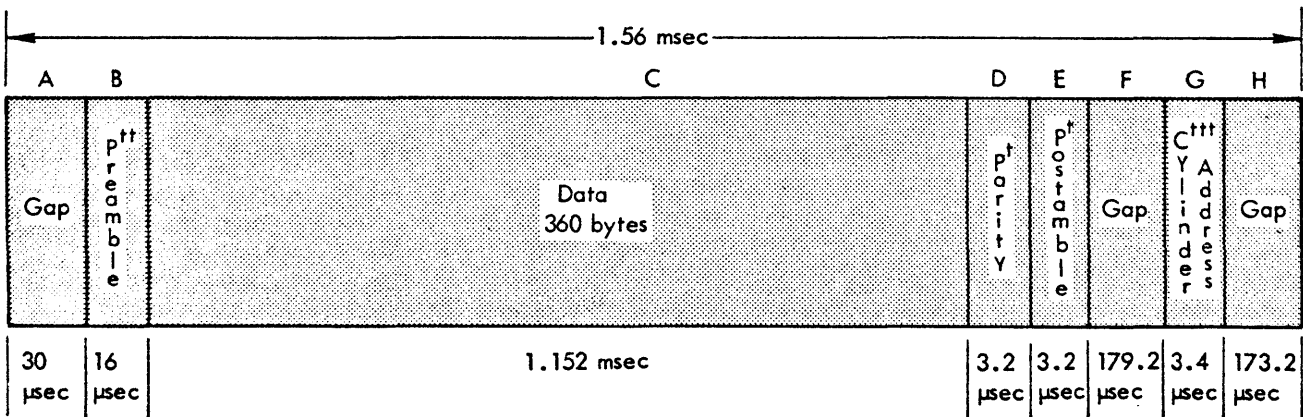
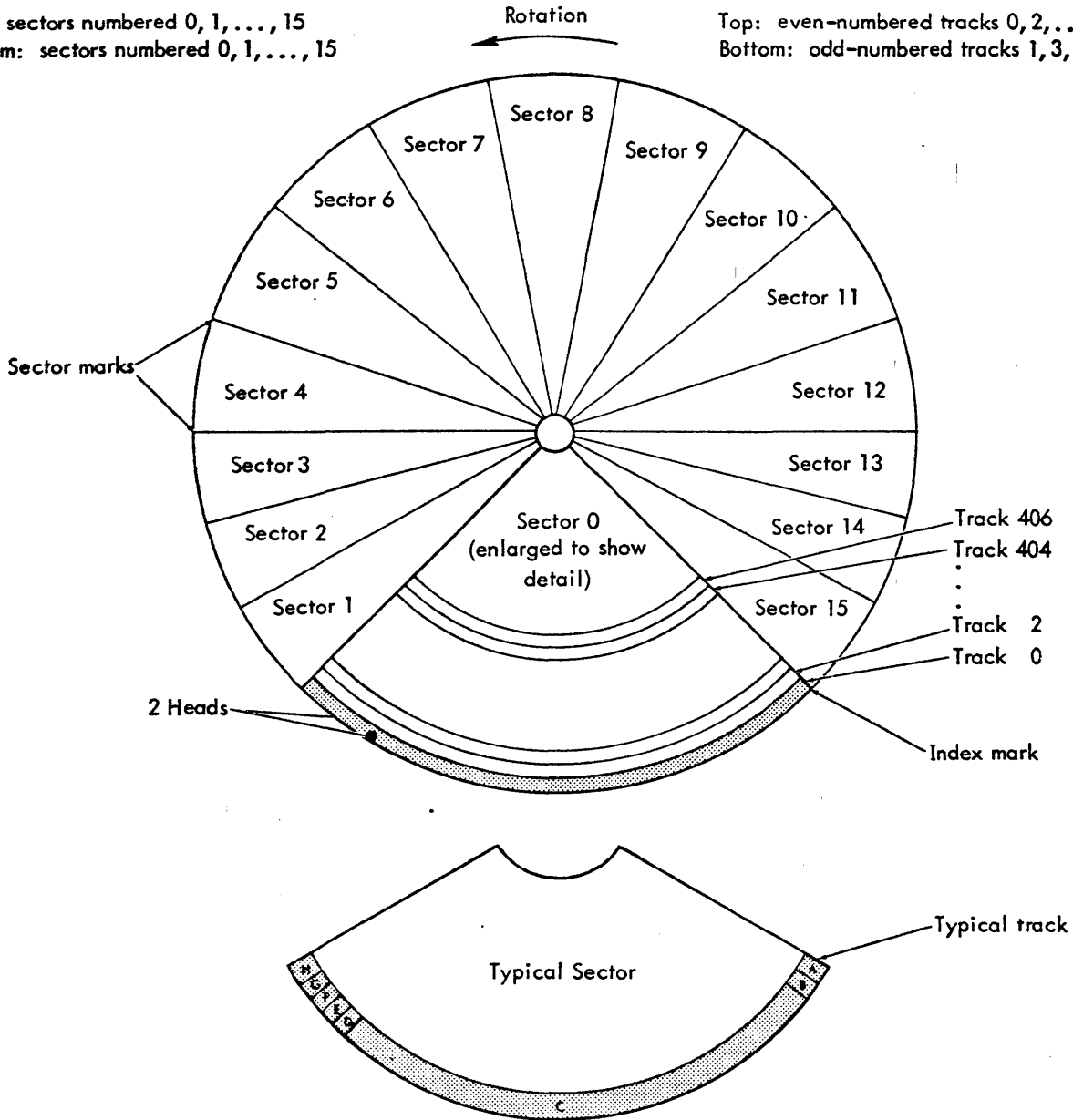

<sup>t</sup> 1 byte      <sup>tt</sup> 5 bytes      <sup>ttt</sup> 9 bits

Figure 7. Disk Organization



even-numbered tracks are on the top surface, and the odd-numbered tracks are on the bottom. Thus, address 0, 2, . . . , 406 are on the top while addresses 1, 3, . . . , 407 are on the bottom.

## SECTORS

Each track is divided into 16 sectors. The index and sector marks are physical slots on the disk surface. The index mark, which is often called the origin, is sensed by the index mark transducer; this same transducer senses the sector marks. The sector addresses are 0, 1, . . . , 15 and are identical on both surfaces.

## CYLINDERS

Each vertically aligned set of two tracks on the disk is referred to as a cylinder. Since a disk contains 408 tracks, and since each set of two tracks constitutes a cylinder, each disk has 204 cylinders. Tracks 0 and 1 are cylinder 0; tracks 2 and 3 are cylinder 1; . . . ; and tracks 406 and 407 are cylinder 203. When loaded, the two read/write heads are positioned at one of the cylinders.

## DATA ORGANIZATION

Data is stored in groups of 360 bytes (see Figure 7). Each data group is preceded by a header consisting of a gap and a five-byte preamble. Similarly, each data group is followed by a trailer consisting of a parity byte, a one-byte postamble, a gap, the cylinder address, and a final gap. During disk operations, the controller computes and checks the parity and checks the cylinder address as described below.

## PARITY

During a write operation, the controller sums each byte received to form a parity check byte. It always writes this byte in the trailer portion of the sector, even when less than 360 bytes are transmitted. During a subsequent read operation, the controller sums the data as it is read and compares the resulting sum with the prestored parity byte. Failure to compare results in an error condition.

## CYLINDER ADDRESS

When a new disk is initialized, the controller writes the sector marks and also writes the cylinder address in the trailer of each sector. Thereafter, the controller checks this cylinder address each time the read/write heads are moved. After modifying its address register to reflect the track and sector addresses from the Seek order, the controller moves the read/write heads accordingly. It then converts the track address from the Seek order and compares it with the prestored cylinder address to ensure that the heads are positioned correctly.

If the two addresses match, the controller permits an I/O operation on the next sector. However, if they do not match, the controller compares the converted track address with the cylinder address of the next sector. Should the comparison fail a second time, the controller restores the heads to cylinder 0 and reseeks the specified track, until stopped by a software timeout routine.

Whenever the second comparison is successful, the controller reseeks the originally specified address at the next sector mark. The controller always checks the cylinder address twice since the first error could have resulted from a head that had not yet settled completely.

## DATA PRESENTATION

The basic addressable unit of information is a sector of 360 bytes. Data are presented in eight-bit bytes to a disk by a disk I/O program, and each byte is written bit-serially on the selected sector. Similarly, data are read serially, one byte at a time, from the disk and assembled in buffer registers for presentation to the disk I/O program.

## DATA ACCESS

Each data group has a unique address consisting of the controller, device, track, and sector numbers. The track and sector numbers are those listed above under "Disk Organization"; the other numbers are defined here. Each of the eight possible disks accommodated by a controller is uniquely addressable because the two disks on the 7252 drive are considered to be two devices.

To select a disk for an operation, either the A register (16-bit-word computers) or the I/O instruction (32-bit-word computers) must contain the controller and device addresses. (For 32-bit-word computers, the I/O instruction also includes the IOP address.) Since the 7250 is a multidevice controller, the controller address lies in the range 8<sub>16</sub> through F<sub>16</sub>, and the device address in the range 0 through 7. The address for a cartridge is always an even number; the address for the fixed disk is always odd.

Access time is 12 msec, track to adjacent track, and 38 msec average. Optimum access times can be achieved when several consecutive sectors are read or written after a Seek order is issued. Rotational delay may also be reduced by first sensing the current position of the read/write heads and then transferring data beginning immediately at the next sector.

## TRACK AND SECTOR INCREMENTING

The controller includes an address register in order to maintain the current track and sector addresses. This register is initially loaded with a Seek order and the read/write heads are positioned at the specified track and sector. Thereafter the controller automatically increments the address

register until it is changed with another Seek order. Track and sector incrementing occurs as soon as an I/O operation begins. For instance, the controller would start a write operation at the current contents of the address register and, as soon as the operation begins, increment the address register. Identical incrementing occurs when data are read.

### EXAMPLES OF AUTOMATIC INCREMENTING

Assume that a Seek order specifies track 0, sector 0. The controller will load these in the address register and will position the read/write heads. Next, assume that a Write order specifies a byte count of 500. As soon as the controller begins writing in track 0, sector 0, it increments the address register. Since a sector contains a maximum of 360 bytes, the controller writes the remaining bytes in track 0, sector 1, and increments the address register as soon as it begins writing in sector 1. At the end of this operation, the address register contains track 0, sector 2.

Because the controller increments addresses, a data record may extend from sector to sector and from track to track. Now assume that a Seek order specifies track 0, sector 0 and that a subsequent Write order includes sufficient data for several tracks. The controller first writes sector 0 of track 0, then sector 1 of track 0, and so on, until data have been written on sector 15 of track 0. The current addresses are track 1, sector 0. The controller then writes all sectors of track 1, followed by all sectors of track 2, and so on, until all data have been written.

To summarize this example, the controller writes all sectors (0, 1, . . . , 15) of track 0 on the top surface, then writes all sectors of track 1 on the bottom surface, and could continue to alternate from the top surface (upper read/write head) to the bottom surface (lower read/write head) until all sectors of all tracks contain data.

### ERROR CONDITIONS

An error condition occurs if the disk drive attempts to seek an address  $\geq 408$ . An error condition also occurs if the disk I/O program issues a Seek order to load the address register with the address of a nonexistent sector.

## SYSTEM STATES

Three possible conditions – not operational, ready, or busy – may exist for the addressed controller and device (see Table 3). The controller may be not operational, ready, or busy and, similarly, a device may be not operational, ready, or busy. The controller is busy if one of its devices is busy; it is ready if all of its operational devices are ready.

The conditions discussed here are directly related to the section entitled "Status Response" in Chapter 3.

The possible state transitions, as well as the events causing these transitions, are summarized in Table 4. The initial

Table 3. Conditions

Condition	Interpretation
Not operational	The power is turned off, or the controller or device is not operational.
Ready	The controller can accept an SIO instruction if the addressed device is available and if the system is free of pending interrupts. To become ready, the device must be operational and the execution of an order must not be in progress or pending.
Busy	The controller has accepted an SIO instruction. It will not accept a new order until the current order is completed and no interrupt is pending.

Table 4. State Transitions

Next State \ Present State	Not Operational	Ready	Busy
	Not Operational		Power is turned on.
Ready	Power is turned off.		SIO instruction has been accepted.
Busy	Power is turned off.	HIO instruction received, I/O Reset signal received, or operation associated with the last order is completed.	

state of the system depends on the power. Absence of power removes the device from the system, and the address will not be recognized. If the power is turned on, the address will be recognized when an I/O instruction is issued.

### OPERATIONAL DEVICES

A device is operational when the READY indicator on the operator control panel is lighted. The yellow light indicates that

1. The cartridge is correctly loaded, the bottom cover is inverted and placed over the cartridge, and the holding clamps are closed.

2. The equipment drawer is closed.
3. All interlocks are closed.
4. The disk is rotating at 2400 rpm.
5. No other condition prevents normal operation of the disk.

The exact state is determined by examining the status response for the SIO, HIO, or TIO instructions. Other I/O instructions, TDV and AIO, provide additional status indications.

#### DATA TRANSFERS

A data transfer may be initiated with an SIO instruction when the following criteria are satisfied:

1. The I/O address is recognized.
2. The controller is in the ready condition.
3. An interrupt is not pending.

If these criteria are satisfied, the controller enters the busy condition and transfers data to or from the disk as specified by the order (e.g., Read or Write), until the required number of bytes have been transferred. When the operation terminates, the controller returns to the ready condition. The operation may also be terminated by

1. An IOP halt, generated by the IOP on some errors.
2. An HIO instruction.
3. An I/O Reset.

In the above cases, all data may not have been transferred when the halt occurs. Following an HIO instruction, an

I/O Reset, or an IOP halt, the controller is in the ready condition.

#### RECOMMENDATIONS

The following recommendations and suggested usage apply to the Cartridge Disk System:

1. The system is recommended for
  - a. System, processor, and public library residence.
  - b. Permanent storage of user-programs.
  - c. Temporary storage of data.
  - d. Permanent storage of data.
  - e. Booting the system.
2. In order to reboot the system, for example, cartridges may be loaded and unloaded while the system is stopped (the LOAD indicator on the operator control panel is lighted).
3. An operation cannot be initiated on a device when the controller is busy; therefore, operations cannot occur simultaneously on two devices. However, while one device is busy, a TIO or a TDV instruction may be issued to another device.
4. New cartridges should be inspected for defects before using, and existing cartridges must be handled carefully to prevent contamination, because an alternate track is not assigned if a defective track is encountered during I/O operations. (Inspection and handling procedures are detailed in Chapter 4.)
5. While cartridges are being loaded and unloaded, it is not possible for the disk I/O program to access the fixed disk on the same drive.

### 3. PROGRAM INTERFACE

This chapter contains information required to write disk I/O programs for the Cartridge Disk System. It includes descriptions of the device orders, summaries of the key events that may occur during I/O operations, and tables that define the status response for the I/O instructions. The section entitled "Additional Programming Considerations" contains information relating to the protection of recorded information, to command chaining and data chaining, and to the I/O interrupt environment. The chapter ends with a series of logic diagrams, one for each device order.

#### DEVICE ORDERS

When the controller successfully completes the execution of an SIO instruction or a command chain, it makes an order-out service call to the IOP to obtain the order for the next operation (see "Service Cycles" in Chapter 2). Table 5 lists the decoding of the orders. Any other code in the order byte is treated as an invalid order.

Table 5. Orders

Order	Binary Representation Bit Positions							Hexadecimal Code	
	0	1	2	3	4	5	6		7
Write	0	0	0	0	0	0	0	1	X'01'
Read	0	0	0	0	0	0	1	0	X'02'
Seek	0	0	0	0	0	0	1	1	X'03'
Sense	0	0	0	0	0	1	0	0	X'04'
Check-write	0	0	0	0	0	1	0	1	X'05'
Read	0	0	0	1	0	0	1	0	X'12'
Test	0	0	0	1	0	0	1	1	X'13'

#### WRITE (X'01')

The Write order writes on the disk the number of data bytes specified by the byte count field in the IOCD. The data to be recorded must be in the I/O Table in memory, starting at the address indicated in the IOCD. The data bytes will be written beginning at the track and sector addresses currently in the controller address register. These addresses are determined by the previous Seek order or by the last sector accessed, incremented by 1. Data transmission continues until the controller indicates to the disk drive that the entire record has been transmitted.

When a record requires more than one sector, the controller automatically increments the track and sector addresses and continues writing in the next sector (see "Data Access" in

Chapter 2). If the record does not require the entire last sector, the controller zero-fills the remainder of that sector. Whenever an operation is attempted to a write-protected disk, that operation is not performed and the condition is reported (see "Status Response" later in this chapter).

#### READ (X'02')

This Read order reads from the disk the number of data bytes specified by the byte count field in the IOCD. The data will be stored in the I/O Table in memory, starting at the address indicated in the IOCD. The data bytes will be read beginning at the track and sector addresses currently in the controller address register. These addresses are determined by the previous Seek order or by the last sector accessed, incremented by 1. Data transmission continues until the byte count is reduced to zero.

When the byte count in the IOCD is greater than 360, the controller will automatically increment the track and sector addresses, and continue reading the next sector (see "Data Access" in Chapter 2).

For this Read order, any transmission error encountered is reported at count done (see "Status Response" later in this chapter).

#### SEEK (X'03')

The Seek order sends two bytes to the controller where they are loaded into the address register. The two bytes must be in the I/O Table in memory, starting at the address specified in the IOCD. After a Seek order is issued, the controller directs any subsequent read/write operation to begin at the specified track and sector addresses.

The format of the two bytes sent to the controller by a Seek order must be

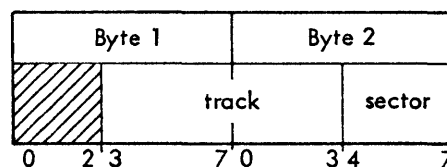

where

track specifies the desired track address and must be within the range  $0 - 407_{10}$ .

sector specifies the desired sector address and must be within the range  $0 - 15_{10}$ .



## TEST MODE 2 (Read)

The controller simulates a Read order by reading the contents of the byte register. If the modifier bit is set, the controller forces a parity error.

## KEY EVENTS

The following key events may occur during a disk I/O operation:

- Start of input/output.
- Unusual end error condition.
- Channel end condition.
- Fault condition.
- Transmission error condition.
- Incorrect length error condition.

Each key event is further described below. Do not assume a chronological order of occurrence from the order of presentation.

### START INPUT/OUTPUT

An operation is initiated with the execution of an SIO instruction in the disk I/O program. If the I/O address is recognized and the controller is in the ready condition with no interrupt pending, the controller sets its "I/O address recognition" and "SIO accepted" indicators. The controller then advances from the ready to the busy condition, requests an order byte from the IOP, and proceeds with the operation defined by that order.

### UNUSUAL END CONDITIONS

After receiving an order, the controller signals unusual end to the disk I/O program when any of the following occur:

1. An invalid order has been issued.
2. The controller or device is not operational.
3. The address register of the controller has been incremented beyond  $511_{10}$ .
4. The address specified in the Seek order is greater than  $511_{10}$ .
5. An attempt has been made to write on a write-protected disk.

6. A data transmission error has occurred.
7. The device attempted to seek a track address greater than 407.
8. The device could not complete the previous Seek order.
9. The INITIALIZE switch in the multiple-drive selection unit is incorrectly set.

### CHANNEL END CONDITIONS

After receiving an order, the controller signals channel end to the disk I/O program when all data have been transferred or when an unusual end condition occurs while a data transfer is in process.

### FAULT CONDITIONS

A fault is any occurrence that causes a device to become not operational. Absence or failure of a.c. or d.c. power causes the system to become not operational. A device also is not operational if it is off-line for testing purposes.

### TRANSMISSION ERROR CONDITIONS

The controller can detect and report transmission errors to the disk I/O program. The circumstances that cause this type of error are

1. The end-of-sector parity check fails during a read operation.
2. A data byte does not compare during a check-write operation. The parity byte is also automatically compared.
3. A data overrun has occurred. The system has failed to maintain the data transfer rate required during the execution of the previous Read, Write, or Check-write order.
4. The system failed to recognize a "sync" pattern on a Read or a Check-write order.

### INCORRECT LENGTH CONDITIONS

The controller can detect and report incorrect length errors to the disk I/O program. The circumstances causing this type of error are

1. A byte count of other than 2 has been specified in the IOCD associated with a Seek order.
2. A byte count of other than 3 has been specified in the IOCD associated with a Sense order.
3. The last Read, Write, or Check-write order did not specify a byte count that was an integral multiple of 360 bytes.

## STATUS RESPONSE

The controller reports the status in response to I/O instructions and device orders. The Overflow and Carry indicators, Condition Codes, and the Device Status Byte are set as the result of an I/O instruction. (Explanations of the I/O instructions appear in the applicable Xerox computer reference manual.) The Operational Status Byte, however, is set as the result of a device order.

### OVERFLOW AND CARRY INDICATORS

Overflow and Carry indicators apply to the Xerox 530 and Sigma 3 computers only. These indicators report the general status of the addressed controller and device. Table 7 lists the possible settings of the Overflow and Carry indicators for each I/O instruction and the significance of each setting.

### CONDITION CODES

Condition Codes apply to the Xerox Sigma 5/6/7/8 computers only. CC1 and CC2 report the general status of the

addressed controller and device. (CC3 may also be set by an I/O instruction. When set, it means either that the status returned in the registers is not reliable or that the status has not been returned. When reset (zero), it means that the status information is reliable. However, CC3 is set by the IOP, not by the controller.) Table 7 lists the possible settings for CC1 and CC2 for each I/O instruction and the significance of each setting.

### DEVICE STATUS BYTE

The Device Status Byte is returned in response to the execution of each I/O instruction. Tables 8, 9, and 10 list the possible settings of the Device Status Byte for each I/O instruction, and the significance of each setting.

### OPERATIONAL STATUS BYTE

The controller generates the order-in status (Operational Status Byte) at the conclusion of each I/O operation. The significance of the bits is presented in Table 11.

Table 7. Overflow and Carry Indicators and Condition Codes

I/O Instruction	Overflow <sup>†</sup> Indicator or CC1	Carry <sup>†</sup> Indicator or CC2	Significance
SIO <i>X'1041'</i>	0	0	I/O address recognized and SIO accepted (the controller has entered the busy condition).
	0	1	I/O address recognized but SIO not accepted (the controller was already busy or a device interrupt is pending).
	1	0	Selector IOP busy. <sup>††</sup>
	1	1	I/O address not recognized.
HIO <i>X'1048'</i>	0	0	I/O address recognized and the controller was not busy when the halt occurred.
	0	1	I/O address recognized and the controller was busy when the halt occurred.
	1	0	Invalid code.
	1	1	I/O address not recognized.
TIO <i>X'1042'</i>	0	0	I/O address recognized and SIO can currently be accepted (the controller is in the ready condition with no device interrupt pending).
	0	1	I/O address recognized but SIO cannot currently be accepted.
	1	0	Selector IOP busy. <sup>††</sup>
	1	1	I/O address not recognized.

Table 7. Overflow and Carry Indicators and Condition Codes (cont.)

I/O Instruction	Overflow <sup>†</sup> Indicator or CCI	Carry <sup>†</sup> Indicator or CC2	Significance
TDV <i>X'1044'</i>	0	0	I/O address recognized and previous operation was not terminated because of a fault.
	0	1	I/O address recognized but previous operation was terminated because of a fault.
	1	0	Selector IOP busy. <sup>††</sup>
	1	1	I/O address not recognized.
AIO <i>X'1050'</i>	0	0	Normal interrupt condition present (channel end or zero byte count).
	0	1	Unusual interrupt condition present (fault).
	1	0	Invalid code.
	1	1	No interrupt condition present.
<sup>†</sup> Overflow and Carry indicators apply to the Xerox 530 and Sigma 3 computers. Condition Codes (CC1 and CC2) apply to the Xerox Sigma 5/6/7/8 computers. <sup>††</sup> Does not apply to the Xerox 530 and Sigma 3 computers.			

Table 8. Device Status Byte for SIO, TIO, and HIO Instructions

Bit Position	Function	Value	Significance
0	Interrupt pending	1	Set if an interrupt is pending (issued but not yet acknowledged by an AIO instruction). The controller continues to transmit data, if specified, until the current operation is completed (all data are transferred or the operation is terminated due to an error condition), but the controller does not accept a new SIO instruction until this interrupt has been acknowledged. An interrupt is cleared by an AIO or HIO instruction, or manually by the RESET switch on the computer control panel.
1,2	Device condition	00 01 10 11	Indicates the current device condition:  Device ready.  Device not operational.  Does not apply.  Device busy.
3	Mode	1	This bit is always a 1, indicating automatic mode.
4	Unusual end	1	Set if the previous operation terminated due to any of the conditions listed under "Unusual End Conditions."



Table 8. Device Status Byte for SIO, TIO, and HIO Instructions (cont.)

Bit Position	Function	Value	Significance
5,6	Controller condition	00	Indicates the current controller condition: Controller ready.
		01	Controller not operational.
		10	Does not apply.
		11	Controller busy. One device is also busy.
7	Reserved	0	This bit is currently 0; however, it may be used in future enhancements.

Table 9. Device Status Byte for TDV and AIO Instructions

Bit Position	Function	Value	Significance
0	Data overrun	1	Data overrun has occurred during execution of the previous order.
1	Reserved	0	This bit is currently zero; however, it may be used in future enhancements.
2	Track not available	1	The track address is greater than 511.
3	Write-protect violation	1	Previous Write order attempted to write on a disk that is write-protected, a track address greater than 407 was specified, or the INITIALIZE switch on the multiple-drive selection unit is on.
4	Missed "sync" pattern	1	This bit is for diagnostic purposes only.
5,7	Reserved	000	These bits are currently zero; however, they may be used in future enhancements.

Table 10. Device Status Byte for TDV in Test Mode Operation

Bit Position	Function	Value	Significance
0,1,2	Test mode responses <sup>†</sup>	000	Normal TDV response (see Table 7).
		001	Parity register returned to the disk I/O program.
		010	Track register bits 0 through 4 returned to the disk I/O program.
		100	Track register bits 5 through 8, and sector register returned to the disk I/O program.
3-7	See Table 6.		

<sup>†</sup>TDV responses during test mode operations are determined by the above three bits of the first data byte following the execution of an X'13' order.

Table 11. Operational Status Byte†

Function	Value	Significance
Transmission error	1	One of the conditions listed under "Transmission Error Conditions" has occurred since the previous order was received.
incorrect length	1	An incorrect length condition has occurred since the previous order was received.
Channel end	1	The controller has terminated the operation for one of the reasons listed under "Channel End Conditions."
Unusual end	1	The controller has terminated the operation for one of the reasons listed under "Unusual End Conditions."

† For the bit positions of these functions in the Operational Status Byte, see the applicable Xerox computer reference manual.

## ADDITIONAL PROGRAMMING CONSIDERATIONS

### INFORMATION PROTECTION

The contents of a disk are protected in the event of primary power failure — the recorded information will not be lost or altered. In addition, the Write-protect feature prevents writing by disabling the write amplifier. Write-protect is set when the LOAD/RUN switch on the operator control panel is moved from LOAD to RUN. It is reset when the operator momentarily depresses the PROTECT switch.

A Write-protect violation will occur if the INITIALIZE switch on the multiple-drive selection unit is left on after initializing a new disk.

### COMMAND CHAINING AND DATA CHAINING

The Cartridge Disk System is designed to permit track switching and order modification (read to write and vice versa) during an intersector gap. The command chaining feature must be used. (Command chaining is not available on the Xerox 530 and Sigma 3 computers.)

Frequent data chaining (small byte counts), or frequent use of test instruction loops (TIOs and TDVs) reduces the transfer rate because of the additional communication required between the I/O system and the CPU, and because of the memory required for either task. This can reduce the transfer rate as much as 50 percent and can cause data overruns.

When "immediate" mode transfer techniques are used — data transmission at the next available sector — the program must add 1 to the sector address received from the Sense order. This ensures one sector time (1.56 msec) for the program to prepare the command list for the next data transfer. It is recommended that command chaining be used between the ensuing Seek order and the related operation — Read, Write, or Check-write. When command chaining is not used, 2 must be added to the sector address received from the Sense order or the time of one disk revolution will be lost before the data transfer is initiated.

## I/O INTERRUPT ENVIRONMENT

The I/O interrupt environment is established by setting flags in IOCDs and by using specified time-out delays in software time-out routines. The recommended software time-out delay for disk operations is a minimum of one second.

### IOCD FLAG: XEROX 530 AND SIGMA 3 COMPUTERS

Set the Interrupt flag to 1 in each IOCD unless data chaining is specified. This permits an I/O interrupt to be requested whenever a channel end or unusual end condition occurs. When data chaining is specified, set the Interrupt flag to 1 only in the last IOCD of the command list.

### IOCD FLAGS: XEROX SIGMA 5/6/7/8 COMPUTERS

For the Xerox Sigma 5/6/7/8 computers, the following flag: must be set:

- ICE Interrupt at Channel End. Set this flag to 1 only in the last IOCD of a command list.
- IUE Interrupt at Unusual End. Set this flag to 1 in all IOCDs.
- HTE Halt on Transmission Error. Set this flag to 1 in all IOCDs.
- SIL Suppress Incorrect Length. Set this flag to 1 whenever an incorrect length indication should inhibit an IOP Halt and the subsequent unusual end I/O interrupt.

See "Key Events" for definitions of the foregoing conditions.

## SEQUENCE OF ACTIVITY

Figures 8 through 13 illustrate the sequential relationship of the principal events that occur during disk operations.

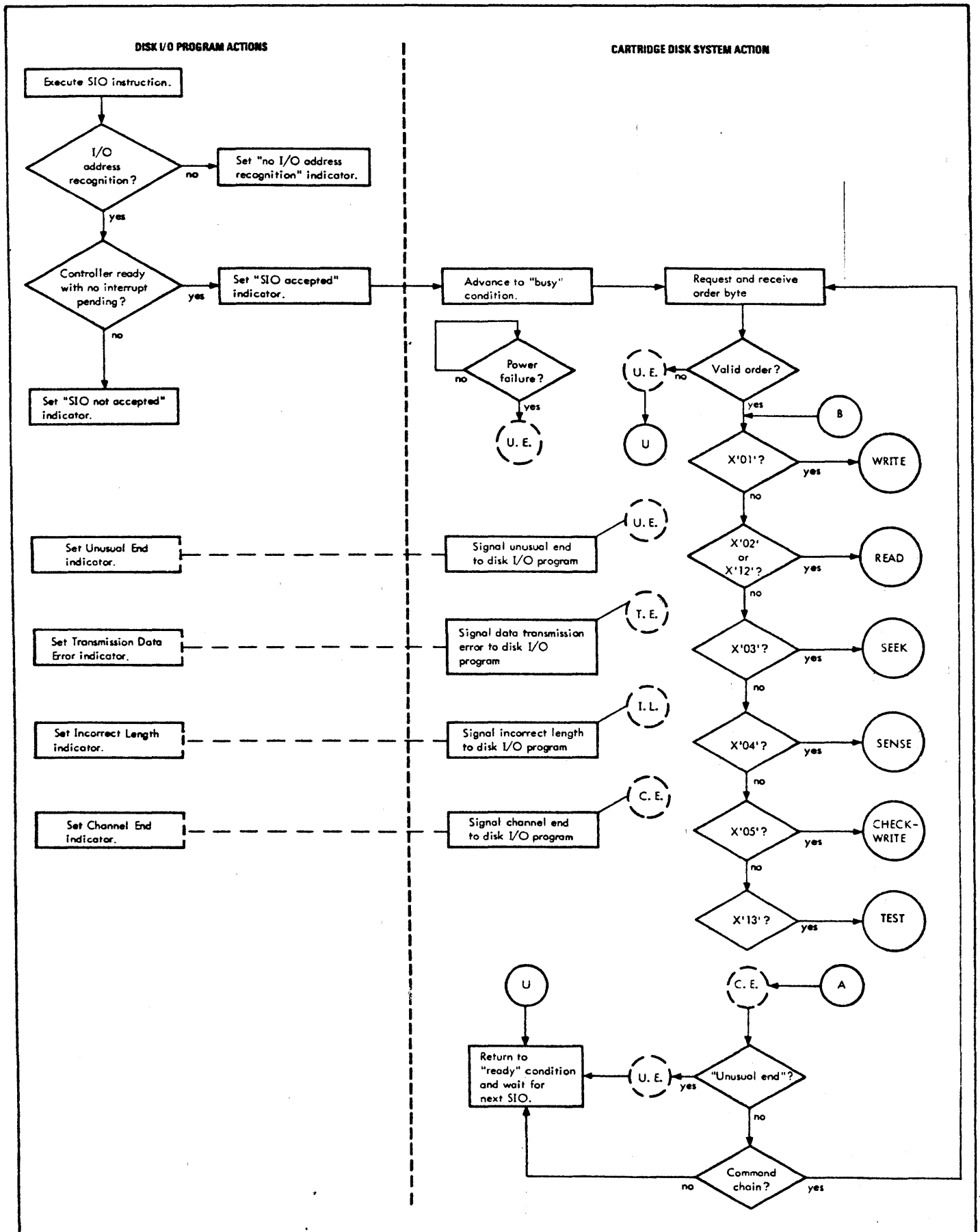

Figure 8. Disk I/O Program/Cartridge Disk System Actions

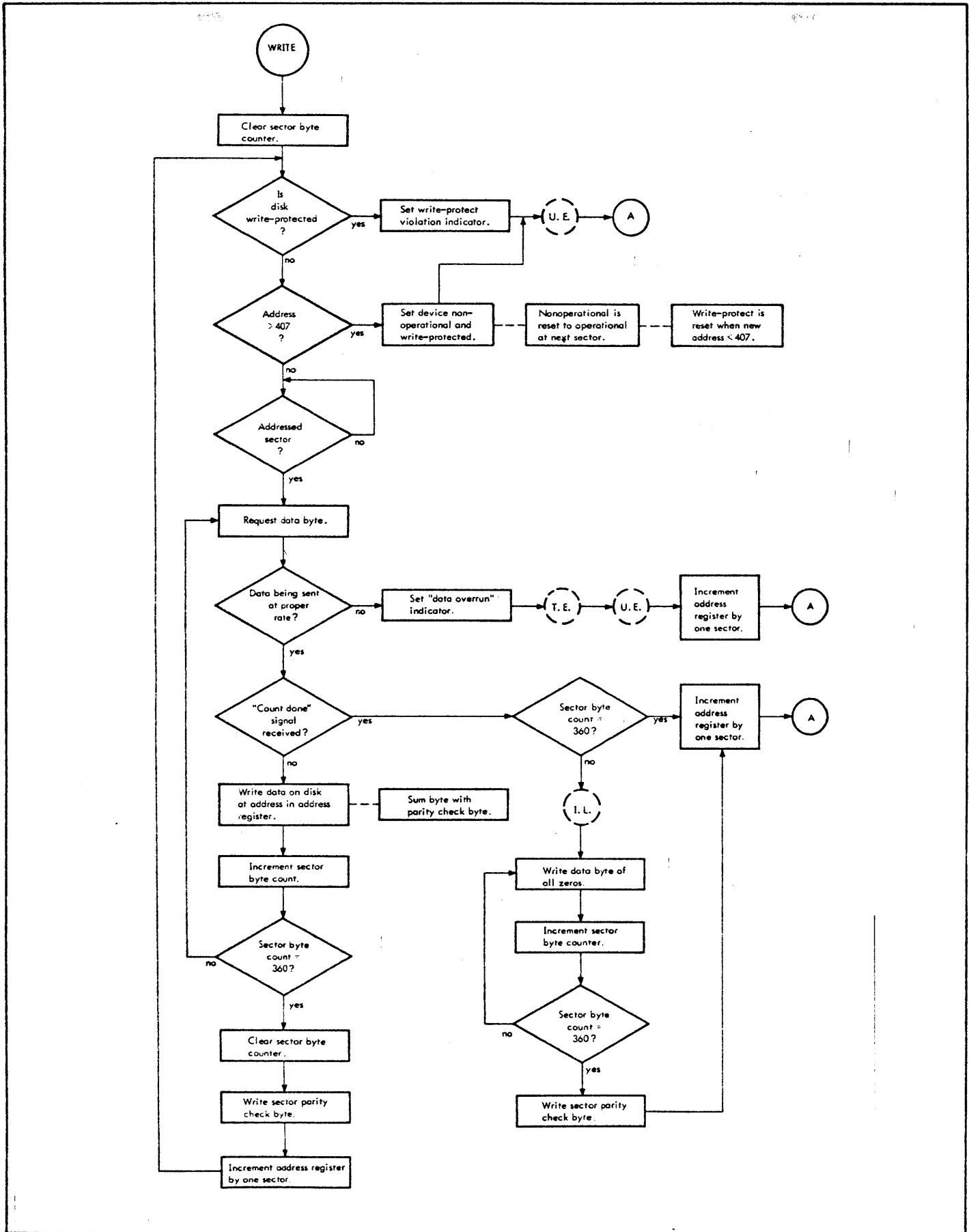

Figure 9. Write Order

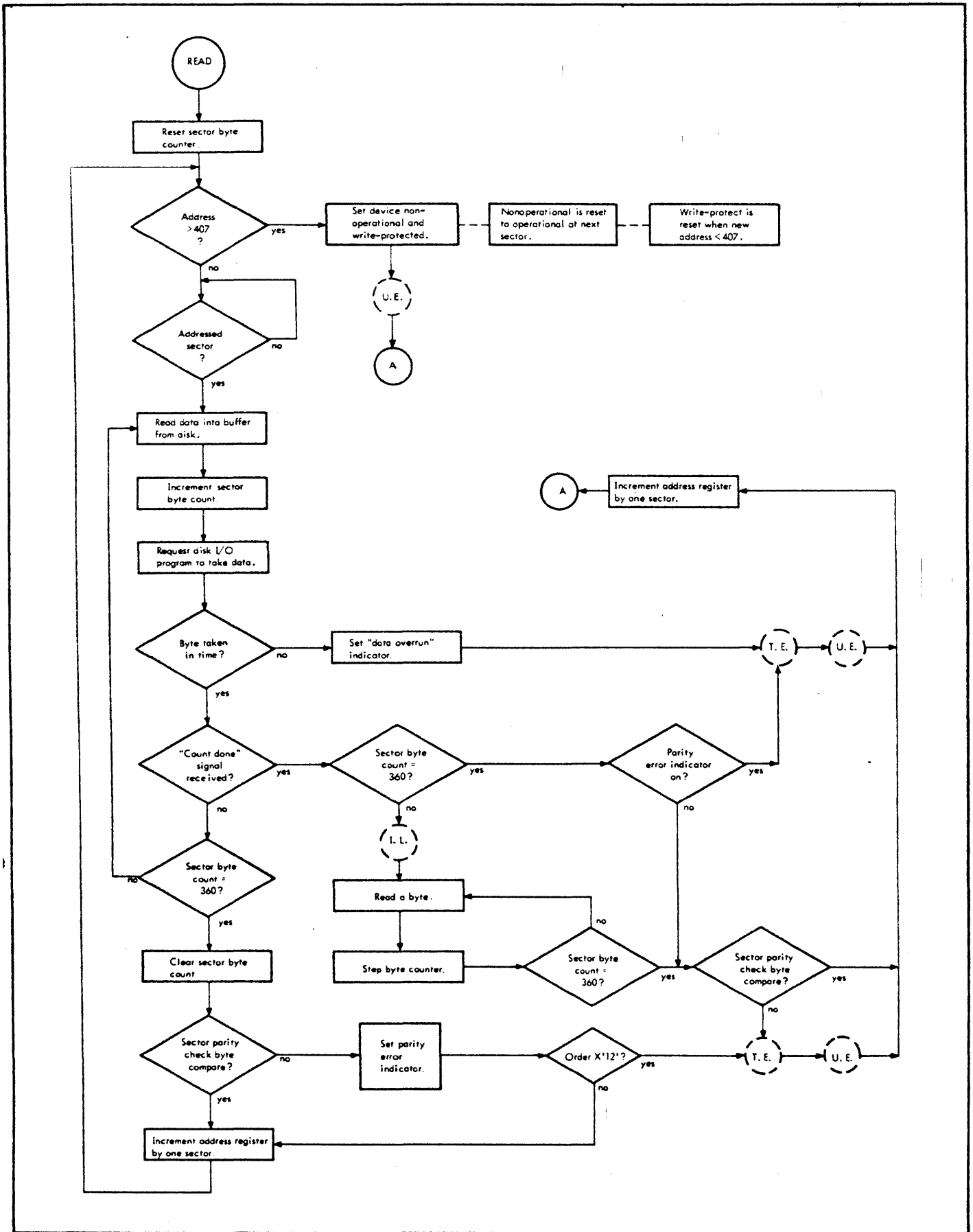

Figure 10. Read Order

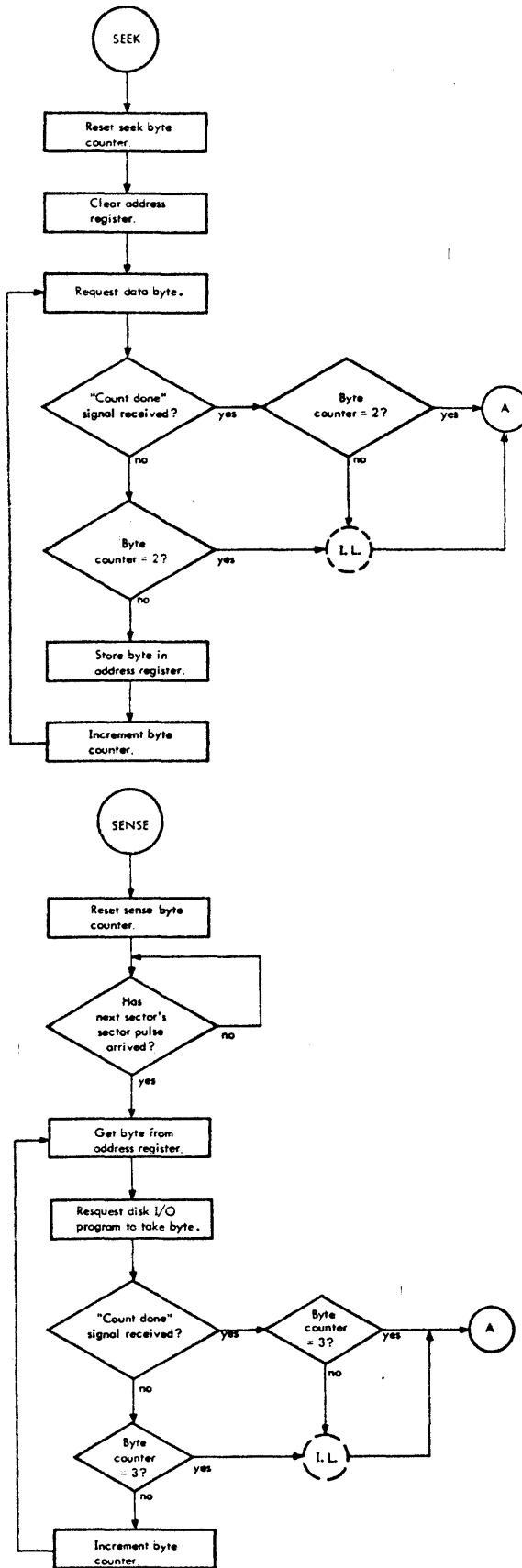

Figure 11. Seek/Sense Order

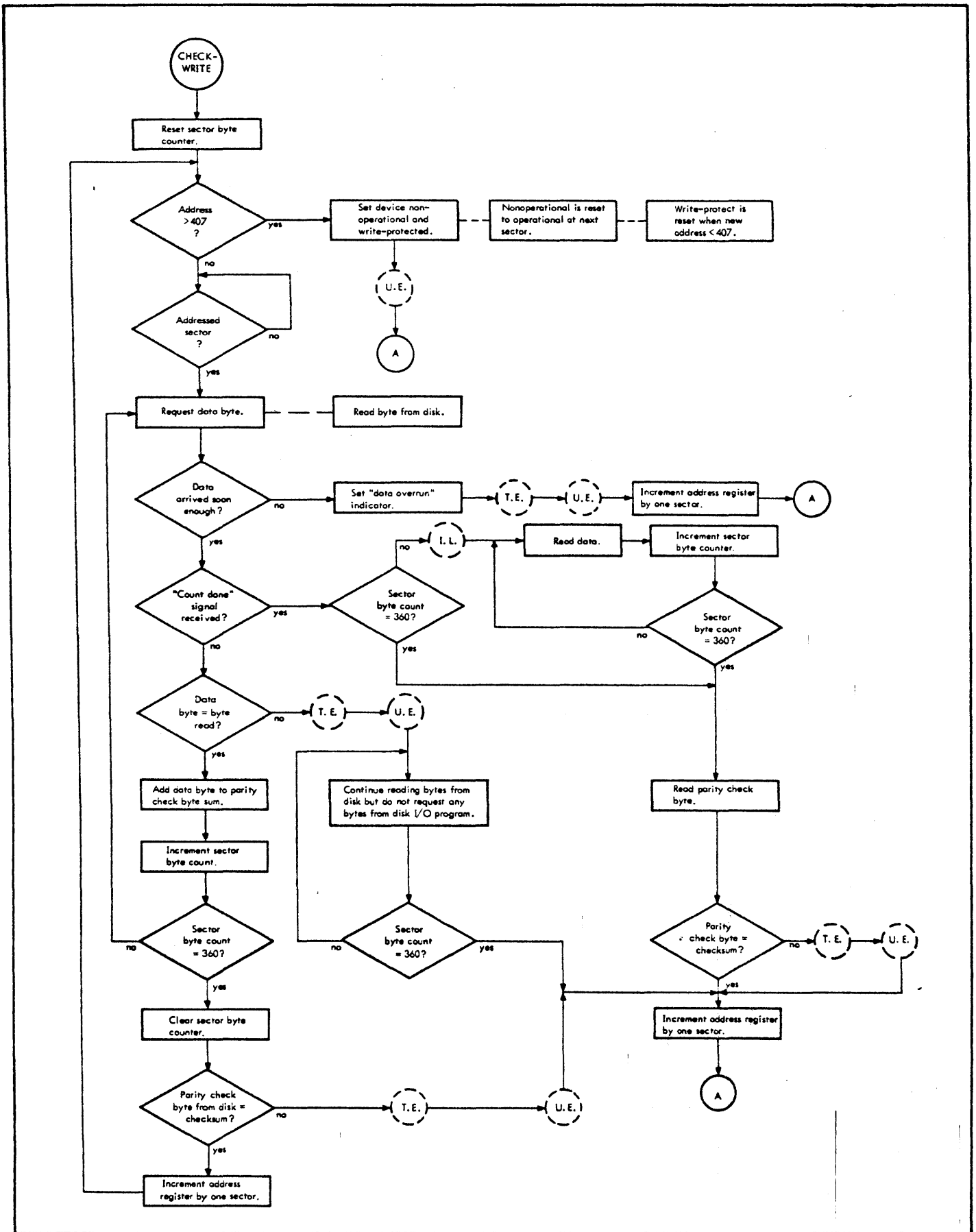

Figure 12. Check-write Order

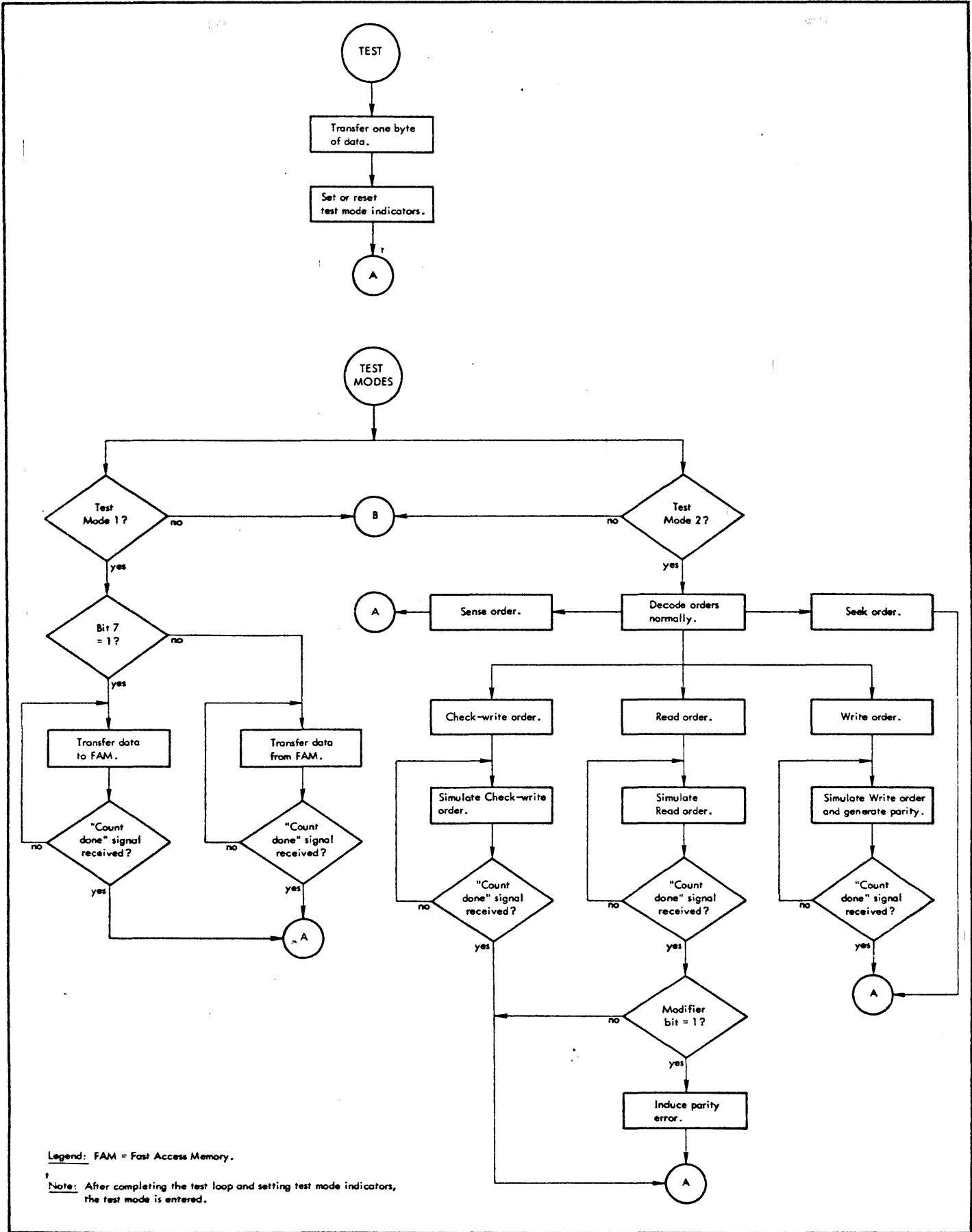

Figure 13. Test Order



## 4. OPERATIONS

This chapter, which describes the operating characteristics of the Cartridge Disk System, contains three main sections: the first illustrates and describes the control panels that appear on the equipment; another contains operating procedures that apply to the controller and the disk drives; and a third contains procedures for handling disk cartridges.

### CONTROL PANELS

A standard Xerox equipment cabinet, which houses the controller, disk drives, and power supplies, contains two principal control panels: an operator control panel, located on the front of each drive, and the controller maintenance panel, installed at the rear of the cabinet. The operator control panel is described first.

#### OPERATOR CONTROL PANEL

The Model 7251/7252 Disk Drives have one control switch and four indicator lights; see Figure 14. The switch and the indicators are described below and are summarized in Table 12 for quick reference.

##### LOAD/RUN SWITCH

The LOAD/RUN switch is a two-position, rocker-type switch that starts and stops the disk drive. Cartridges may be loaded and unloaded when this switch is in the LOAD position — and the LOAD indicator is lighted. After a cartridge is loaded and the equipment drawer closed, switching to RUN starts the drive and brings the disk up to its normal operating speed in about 60 seconds. During this time, the read/write heads are moved to cylinder 0 at the extreme outer edge of the disk and loaded. When the switch is moved back to LOAD, the disk decelerates to a stop in about 15 seconds and the LOAD indicator will light.

After the operator moves the switch to LOAD, the unload sequence is inhibited until the system detects an index mark on the disk surface. During a write operation, this could prevent garbling of data.

##### LOAD INDICATOR

The LOAD indicator is a white signal light indicating that cartridges can be loaded or unloaded. This light goes off whenever the LOAD/RUN switch is set to RUN, and remains off when the disk is rotating.

##### READY INDICATOR

The READY indicator is a yellow signal light indicating that the drive is ready to accept and execute orders from the disk I/O program. The light comes on when the disk is rotating at its nominal speed, the read/write heads are loaded, and no other conditions exist that prevent seeking, reading, and writing. The light remains on throughout I/O operations. It is extinguished when the LOAD/RUN switch is set to LOAD.

##### CHECK INDICATOR

The CHECK indicator is an orange signal light indicating that because of an abnormal condition, the disk drive may not be able to write. This condition may be reset by moving the LOAD/RUN switch to LOAD and then back to RUN.

##### PROTECT INDICATOR

The PROTECT indicator guards against inadvertent writing. The indicator glows and writing is inhibited whenever the LOAD/RUN switch is changed from the LOAD position to RUN. Write-protect is turned off to allow writing when the operator depresses the PROTECT indicator. The operator can set write-protect at any time by moving the LOAD/RUN switch to LOAD and then back to RUN.

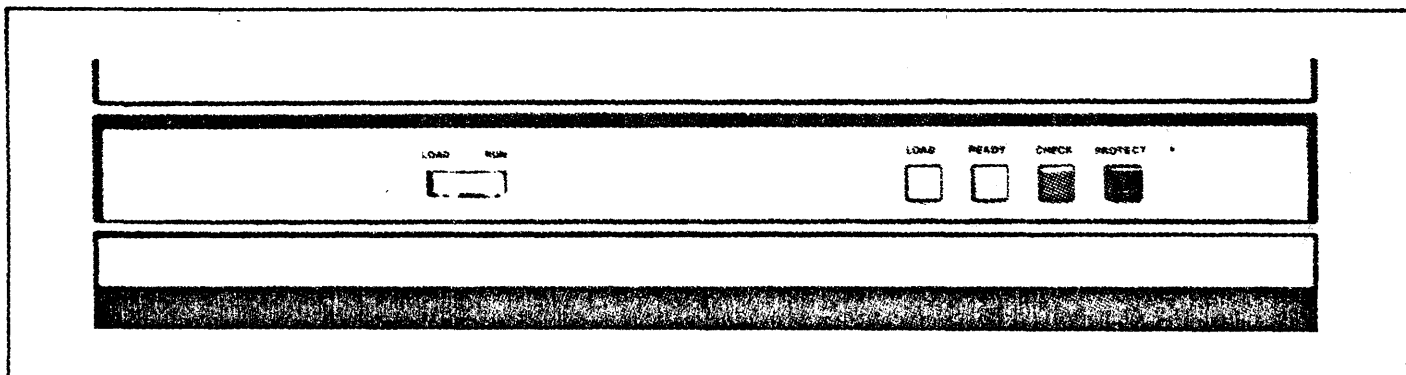

Figure 14. Disk Drive Operator Control Panel

Table 12. Operator Control Panel Summary

Switch or Indicator	Function
LOAD/RUN	RUN position starts the disk drive if a cartridge is loaded and the equipment drawer is closed.  LOAD position stops the disk drive. Cartridges may be loaded and unloaded when the LOAD indicator lights.
LOAD	Lighted when cartridges can be loaded and unloaded. Not lighted when the disk is rotating.
READY	Lighted when the disk is rotating at 2400 rpm, the read/write heads are loaded, and no condition prevents normal disk operations. Not lighted when the LOAD/RUN switch is set to LOAD.

Table 12. Operator Control Panel Summary (cont.)

Switch or Indicator	Function
CHECK	Lighted when the drive may not be able to write. Reset by moving the LOAD/RUN switch to LOAD and then back to RUN.
PROTECT	Lighted when writing is inhibited. Not lighted when writing is allowed.  To inhibit writing, move LOAD/RUN to LOAD and then back to RUN.  To allow writing, depress PROTECT.

**CONTROLLER MAINTENANCE PANEL**

Figure 15 illustrates the Model 7250 Controller and its maintenance panel. The controller, whose functions are described at the beginning of Chapter 2, is installed at the rear of the equipment cabinet. The maintenance panel is for the use of customer service engineers only.

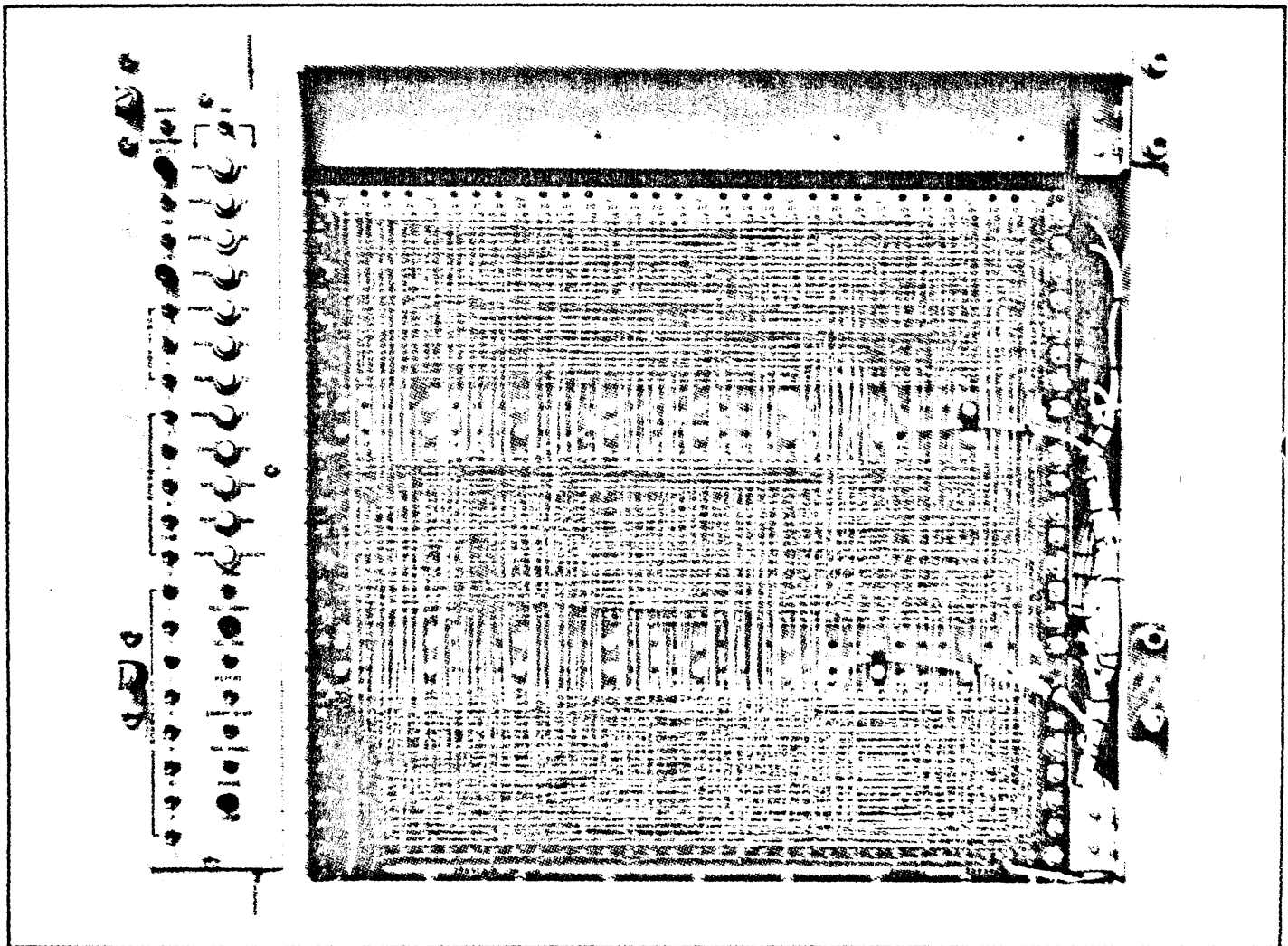

Figure 15. Controller and Maintenance Panel

## OPERATING PROCEDURES

The information in this section includes general practices for operating the disk drives, as well as individual procedures for turning the controller power on and off, for starting and stopping a disk drive, and for loading and unloading cartridges.

### GENERAL OPERATING PRACTICES

Follow these practices while operating the disk drives in order to obtain the best performance and reliability from the equipment:

1. Close the equipment drawer whenever cartridges are not being loaded or unloaded in order to keep the equipment free of dust.
2. A sustained tingling or scratching sound may be caused by head-to-disk contact. If this sound persists, stop the disk drive and investigate the cause (see "Disk Drive Stopping Procedure").
3. Do not force the equipment drawer open or try to override any interlock.

### DISK DRIVE INTERLOCKS

The disk drives contain interlocks – automatic internal switches – and other safety devices. Attempting to override any of the interlocks may severely damage the equipment. The following conditions are caused by interlocks:

- The equipment drawer is locked shut while the power is off or while the disk is rotating.
- The cartridge holding clamps cannot be operated while the read/write heads or the cleaning brushes are positioned over the disk surfaces, or whenever the power is off.
- The disk will not rotate when the equipment drawer is open, the bottom cover of the cartridge is not installed, or the cartridge holding clamps are open.
- Head loading is inhibited when the read/write heads are retracted outside the disk surface.

Initial power-on or a RUN-to-LOAD sequence conditions the interlock circuits to allow normal operation of a disk drive.

### SYSTEM POWER TURN ON PROCEDURE

The disk drives do not have power on/off switches. They have their own power supplies and require d. c. power only.

After initially turning on the power when a Cartridge Disk System is installed, it need not be turned on and off under normal operating conditions. If required, in some installations, the customer service engineer will turn on the power; in others, the operator may be required to turn on the system power. The procedure is

1. Set the REM/ON/OFF switch on the Power Distribution Panel to ON (see Figure 16) in order to turn on the a. c. power to the system. The Power Distribution Panel is inside the equipment cabinet, above the multiple-drive selection unit.
2. Check the switch on the PT20C Power Supply to ensure that it is up (see Figure 17). The PT20C Power Supply is at the rear of the cabinet. Moving the switch to the up position turns on the d. c. voltage to the controller and to the multiple-drive selection unit.

The switch on the PT20C Power Supply should remain in the up position, except possibly during preventive maintenance sessions. Whenever the system appears to be nonoperational, first check to ensure that the switch has not been moved down.

### DISK DRIVE START UP PROCEDURE

The following procedure starts a disk drive:

1. Set the LOAD/RUN switch on the operator control panel to LOAD.
2. When the LOAD indicator lights, load a cartridge in the disk drive (see "Cartridge Loading and Unloading Procedures").

After a cartridge is loaded, and the LOAD/RUN switch is set to RUN, the start-up cycle begins. During this cycle, the spindle and the disks begin rotating and cleaning brushes pass over each surface in order to remove contamination. When the disk is up to speed, the read/write heads move from their retracted position beyond the disk surfaces to cylinder 0 at the extreme outer edge of the disk, and are then loaded. In addition, Write-protect is turned on during the start-up cycle. This feature inhibits the write and erase circuits and causes the PROTECT indicator to light.

When the start-up cycle is completed, the READ indicator will light. The yellow light indicates that

- The cartridge is correctly loaded, the bottom cover is inverted and placed over the cartridge, and the holding clamps are closed.
- The equipment drawer is closed.
- All interlocks are closed.

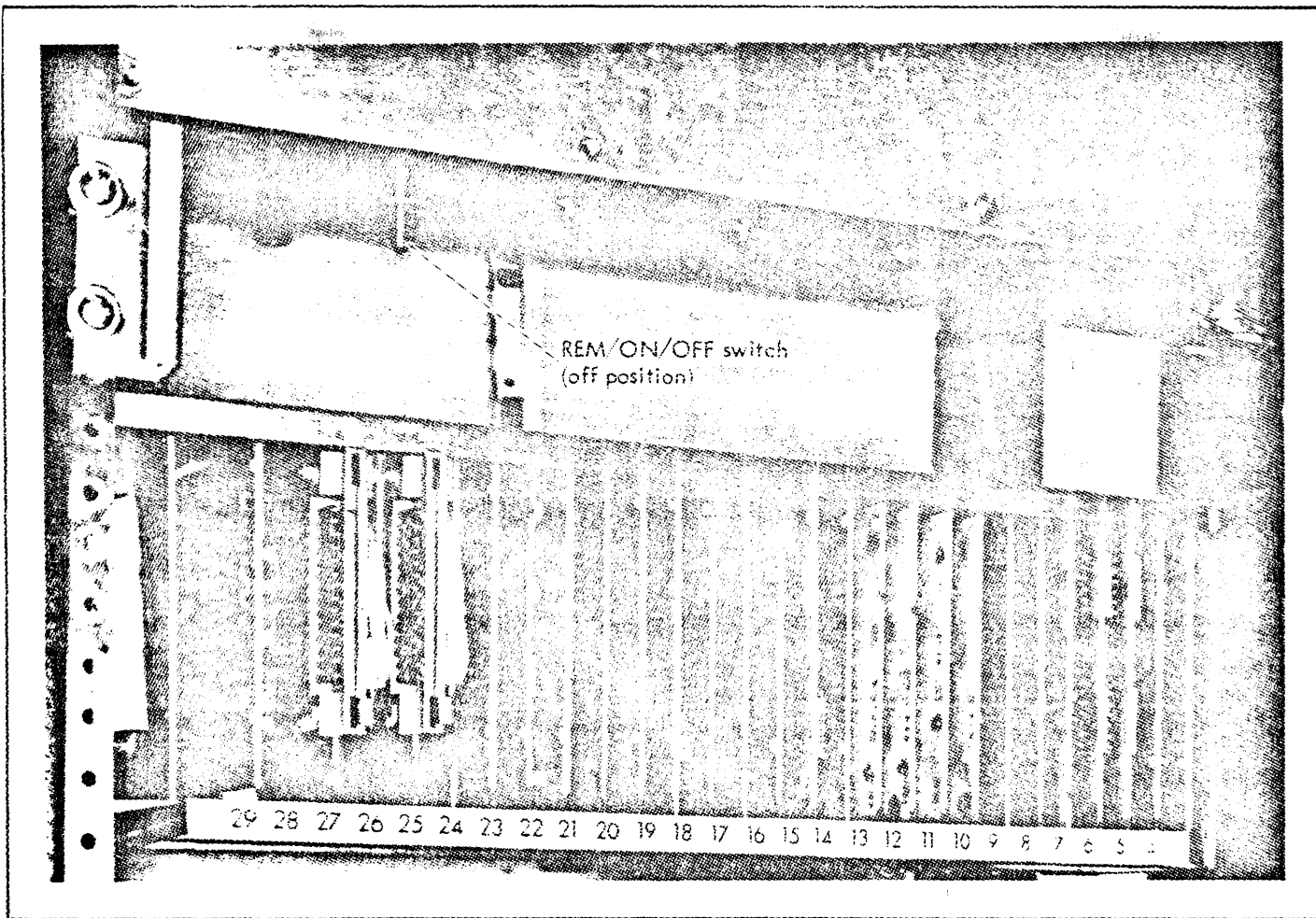

Figure 16. Power Distribution Panel

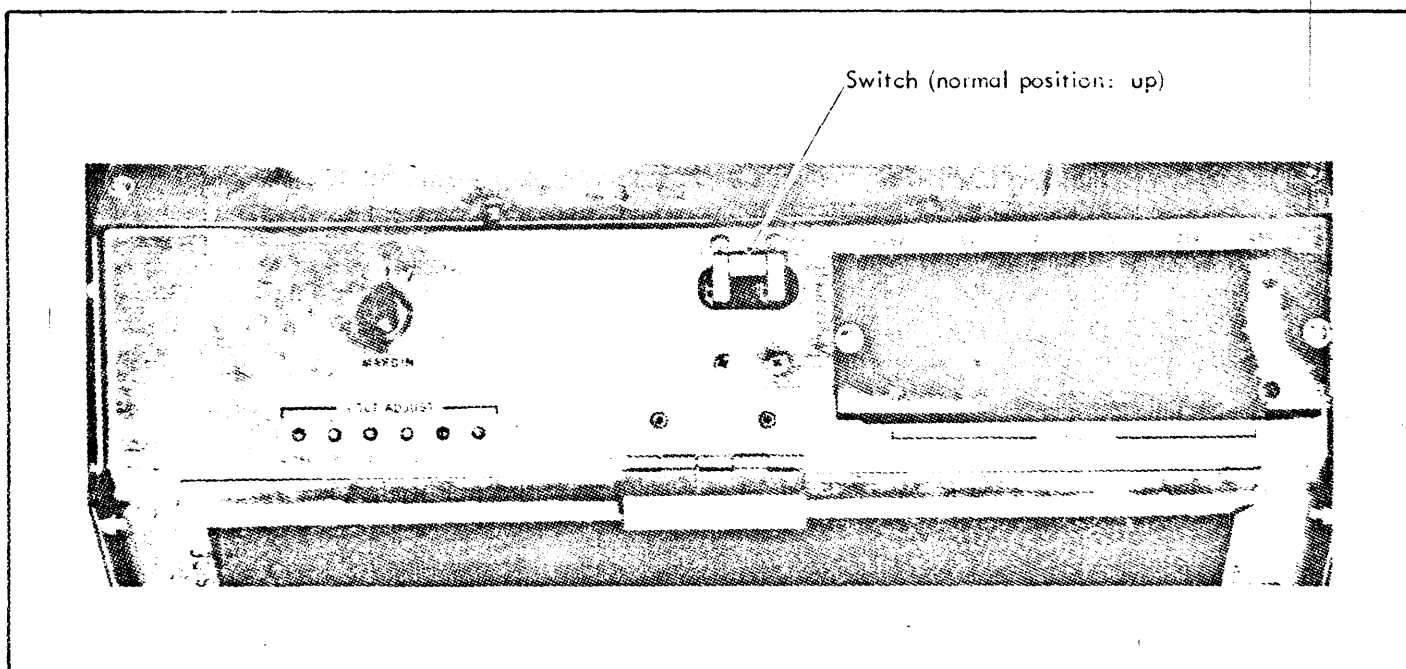

Figure 17. PT20C Power Supply

- The disk is rotating at 2400 rpm.
- The read/write heads are in the loaded flying position.
- No other condition prevents normal operation of the disk.

The READY indicator remains on during disk operations; it is extinguished when the LOAD/RUN switch is moved to LOAD.

### CARTRIDGE LOADING AND UNLOADING PROCEDURES

Use the following procedure to load and unload cartridges:

1. Observe the LOAD indicator on the operator control panel. The equipment drawer can be opened only when this indicator is lighted.
2. Pull the handle to open the equipment drawer. Access to the spindle assembly can be gained when the drawer is open.
3. Open the two cartridge holding clamps. One appears on each side of the spindle bowl (see Figure 18).
4. Skip to step 8 if a cartridge is not currently in the drive.
5. On the cartridge to be unloaded, remove the bottom cover that had been placed over the cartridge when it was loaded.
6. Press the tab on the cartridge handle to the left and raise the handle. This allows the cartridge to be lifted out of the drive.
7. Place the bottom cover on the cartridge and lower the handle. This attaches the cover to the cartridge.
8. On the cartridge to be loaded, first press the tab on the cartridge handle to the left, and then raise the handle. This separates the bottom cover from the disk (see Figure 19).
9. Place the disk cartridge over the spindle hub. Ensure that the cartridge opening for entry of the read/write heads is at the rear of the spindle bowl. Lower the cartridge handle to lock the cartridge to the spindle. When correctly loaded, the cartridge will not rotate (see Figure 20).
10. Invert the bottom cover of the cartridge and place it over the disk (see Figure 21).
11. Close the two cartridge holding clamps.
12. Close the equipment drawer by sliding the drive into the cabinet.

13. Set the LOAD/RUN switch to RUN.
14. Observe the light on the LOAD indicator go out. The disk is now rotating and the start-up cycle is taking place.
15. Allow the drive about 60 seconds to complete the start-up cycle. The READY indicator will then light, and the drive is ready to perform seek, read, and write operations. The READY indicator remains lighted during disk operations.
16. If the READY indicator does not light, or if the CHECK indicator glows, a problem exists. Notify the customer service engineer.

### DISK DRIVE STOPPING PROCEDURE

This procedure stops a disk drive:

1. Set the LOAD/RUN switch on the operator control panel to LOAD. In about 15 seconds the LOAD indicator will light.
2. The equipment drawer can now be opened and the cartridge unloaded (see "Cartridge Loading and Unloading Procedures").
3. If the LOAD indicator does not light, notify the customer service engineer, because a problem exists.

### SYSTEM POWER TURN-OFF PROCEDURE

The power to the Cartridge Disk System does not have to be turned off periodically. Exceptions to this rule would be any instructions for power turn-off at the installation itself, or any local laws or regulations. Another exception would be an emergency. In some installations, the customer service engineer will turn off the power if required. In others, the operator may have to turn off the power.

Note: In an emergency, immediately perform step 3.

1. Set the LOAD/RUN switch on the operator control panel to LOAD.
2. Wait for the LOAD indicator to light.
3. Set the REM/ON/OFF switch on the Power Distribution Panel to OFF (see Figure 16) in order to turn off the a.c. power to the system. The Power Distribution Panel is inside the equipment cabinet, above the multiple-drive selection unit.



Figure 18. Opening Cartridge Holding Clamps



Figure 19. Removing Bottom Cover from Disk



Figure 20. Loading and Unloading a Cartridge

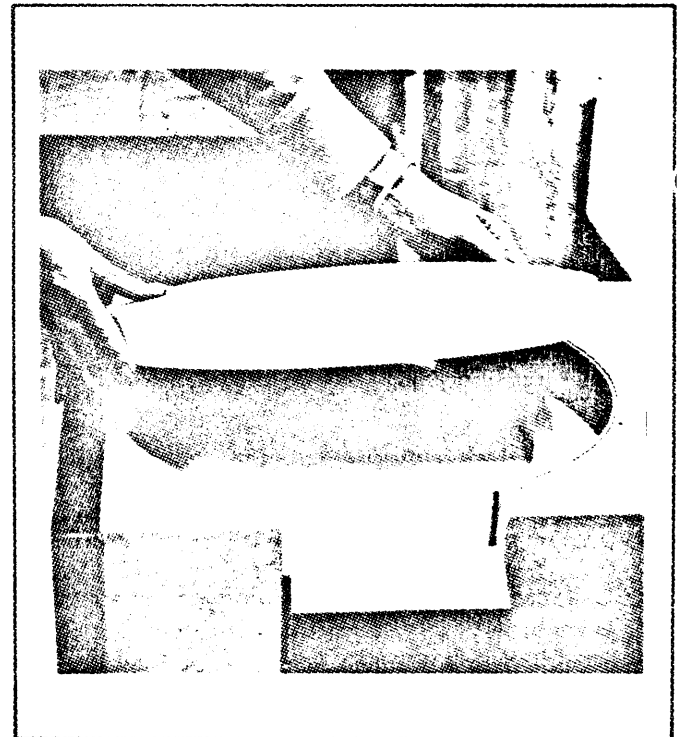

Figure 21. Placing Bottom Cover over Cartridge

## CARTRIDGE PROCEDURES

Cartridges are precision devices. They require careful handling, proper storage, and periodic cleaning in order to prolong their usefulness and to ensure the integrity of the recorded data. The procedures given below are designed to eliminate or to minimize damage to cartridges.

### GENERAL HANDLING PROCEDURES FOR CARTRIDGES

The following procedures generally apply to the handling of disk cartridges:

1. Keep the cartridge locked in its bottom cover whenever the cartridge is not in the disk drive. This practice ensures a positive dust seal and immobilizes the disk inside.
2. Do not place cartridges in direct sunlight.
3. Replace covers that are cracked or otherwise damaged.
4. Clean the covers periodically with a clean lint-free cloth (or Kimwipes<sup>®</sup>) to remove dust.
5. Keep hands, pencils, clothing, and other objects off the disk surfaces.
6. Keep ashes, tobacco, and coffee away from cartridges since ashes, tobacco, and sugar are prime sources of disk contamination.
7. To carry several cartridges at once, stack them on top of each other. Do not carry more than five cartridges at one time, however.
8. If a cartridge is dropped, have it inspected by the customer service engineer before loading it in a disk drive.
9. Do not expose the cartridge to intense magnetic fields. A field intensity of more than 50 gauss may cause information to be lost. Consult the customer service engineer if high-intensity fields are suspected.
10. Before using a cartridge, condition it to the temperature of the computer room for at least 2 hours. The conditioning time is required to ensure accurate track registration, data recording, and data retrieval. This is necessary only if the cartridge storage temperature is less than 60° F or greater than 90° F.

<sup>®</sup> Kimwipes is a registered trademark of the Kimberly-Clark Corporation.

## LABELING CARTRIDGES

Cartridges may be labeled for identification. It is recommended that the top surface of the cartridge be used for labeling, although the outside of the bottom cover may contain the same identification, if desired. Use the following procedures when labeling a cartridge:

1. Use a felt-tip pen, ball point pen, or an adhesive label. Do not use grease pencils, crayons, or pencils to write on labels.
2. If adhesive labels are to be used, obtain only those designed for use as disk labels. Other labels could loosen and damage the cartridge.
3. Mark the label before placing it on the cartridge.
4. Remove old labels. Do not apply a new label over an old one.
5. Remove any gummy residue left from an old label with 91 percent isopropyl alcohol and a lint-free cloth (or Kimwipes) before applying a new label.
6. Do not use an eraser to change the label. Rubber or pencil particles could damage the disk surfaces.
7. If the cartridge has been labeled with a felt-tip pen, use 91 percent isopropyl alcohol and a lint-free cloth (or Kimwipes) to change or to remove old markings.
8. Do not put notes, markers, or identification cards inside the bottom cover.

### INSPECTING CARTRIDGES

Note: Use only Model 7254 Disk Cartridges or cartridges that meet Xerox specifications.

When a new cartridge is received, and whenever a cartridge is to be loaded in a disk drive, inspect that cartridge for possible defects. A damaged cartridge can cause head-to-disk contact, and a single defective cartridge can extend a malfunction to other drives and cartridges. Use the following procedure to inspect a cartridge before loading it in a drive:

1. Remove the bottom cover from the cartridge (see Figure 19).
2. Turn the cartridge upside down and hold it level.
3. Locate the opening for entry of the read/write heads and look for a black rubber plug that may be loose or missing.

Caution: Never allow the read/write heads to load on a defective cartridge — the heads will be damaged.

4. If the cartridge passes visual inspection, it can be loaded in the disk drive (see "Cartridge Loading and Unloading Procedures").
5. Listen as the cleaning brushes sweep the disk surfaces. If a tingling or scratching sound can be heard, it indicates that a brush arm is contacting a disk surface. Unload the cartridge immediately and notify the customer service engineer or the installation supervisor.
6. If the cartridge passes the brush test, listen for any head-to-disk contact. If any unusual sound is heard, unload the cartridge immediately and notify the customer service engineer or the installation supervisor.
7. Begin disk operations if the cartridge passes inspection.

### CLEANING PROCEDURES

The spindle bowl of a disk drive and the cartridge covers must be checked periodically for contaminants and cleaned with 91 percent pure isopropyl alcohol and a lint-free cloth (or Kimwipes). Use the following procedure to clean the spindle bowl:

1. Stop the disk drive (see "Disk Drive Stopping Procedure").
2. Unload the cartridge (see "Cartridge Loading and Unloading Procedure").
3. Clean the spindle bowl with the lint-free cloth moistened with alcohol, and wipe it to remove all dirt and smudges.
4. After cleaning the spindle bowl, use a pad of adhesive-type tape to pick up any particles not removed with the cloth.
5. Ensure that all particles have been removed from the spindle bowl by rewiping it with the moistened cloth.

Only customer service engineers or other qualified maintenance personnel may clean the disk recording surfaces. These surfaces need be cleaned only when the disk is

suspected of being the source of errors. The procedure for cleaning disk surfaces is contained in the maintenance manual for the customer service engineer.

### STORING CARTRIDGES

The following procedures apply to the storage of disk cartridges:

1. Store each cartridge locked in its bottom cover to form a sealed storage container.
2. Store cartridges on their sides or stacked. A stack should contain no more than five cartridges.
3. Store cartridges in clean dust-free cabinets of metal or other fire resistant material.
4. Keep the storage area free of dust and contaminants. The computer room is the best environment for cartridge storage.
5. Do not store cartridges in direct sunlight or in areas exposed to magnetic fields from transformers, high current electric cables, or similar equipment. For high security storage, observe the same precautions used for storing magnetic tapes and microfilm records.
6. If cartridges are exposed to temperatures of less than 60° F or more than 90° F recondition them to the normal computer room environment for 2 hours before using.
7. Nonoperating storage conditions are 8 to 80 percent humidity with no condensation over a temperature range of -40° F to + 150° F.

### USAGE LOG

A log must be maintained for each disk drive in order to identify all cartridges that were used on that drive. In the event of a malfunctioning drive or a defective cartridge, it is important to know which cartridges have been used on a particular drive since one defective drive or cartridge can extend damage to other drives. A log entry consists of at least three items of information: cartridge identification and the date and time the cartridge was loaded.