

The Standard of Excellence in Microcomputer Systems.

IMSAI

PCS 80/15 Microcomputer System

user manual

IMSAI Manufacturing Corporation
San Leandro, CA

IMSAI MANUFACTURING CORPORATION

Dear IMSAI Owner:

I welcome you to the thousands of IMSAI Microcomputer System owners. You now own the finest personal computer in the world. It is inexpensive enough to be the personal computer for every household, and at the same time is powerful enough and has the peripheral and software support for commercial applications. Your IMSAI Microcomputer will serve you well, both now and in the future. We offer a wide range of options which can expand its capabilities as your computer needs grow.

More interfaces and systems will be forthcoming through a continuing engineering and development program. There are a number of projects to be announced soon which will be of interest to both the hobbyist and the full scale system user.

I am aware that minor problems and omissions can occasionally occur. They can be removed only if we know about them, so I ask you to take the time to write me after reading our documentation and trying our machine. Let me know of any problems you notice with either the machine or written material. I need your help to maintain the quality level to which IMSAI is committed. Even if you have no specific points, please return the "Reader Suggestions" sheet.

IMSAI is committed, because each one of us at IMSAI is committed, to making available to our users complete computing capabilities at the highest commercial quality levels, along with all the support necessary for you to use the system. We all look forward to receiving your input and working together with you to provide a system with all the hardware and software capabilities that today's technology makes possible.

Sincerely,



A. Joseph Killian
Engineering Manager

AJK/lap

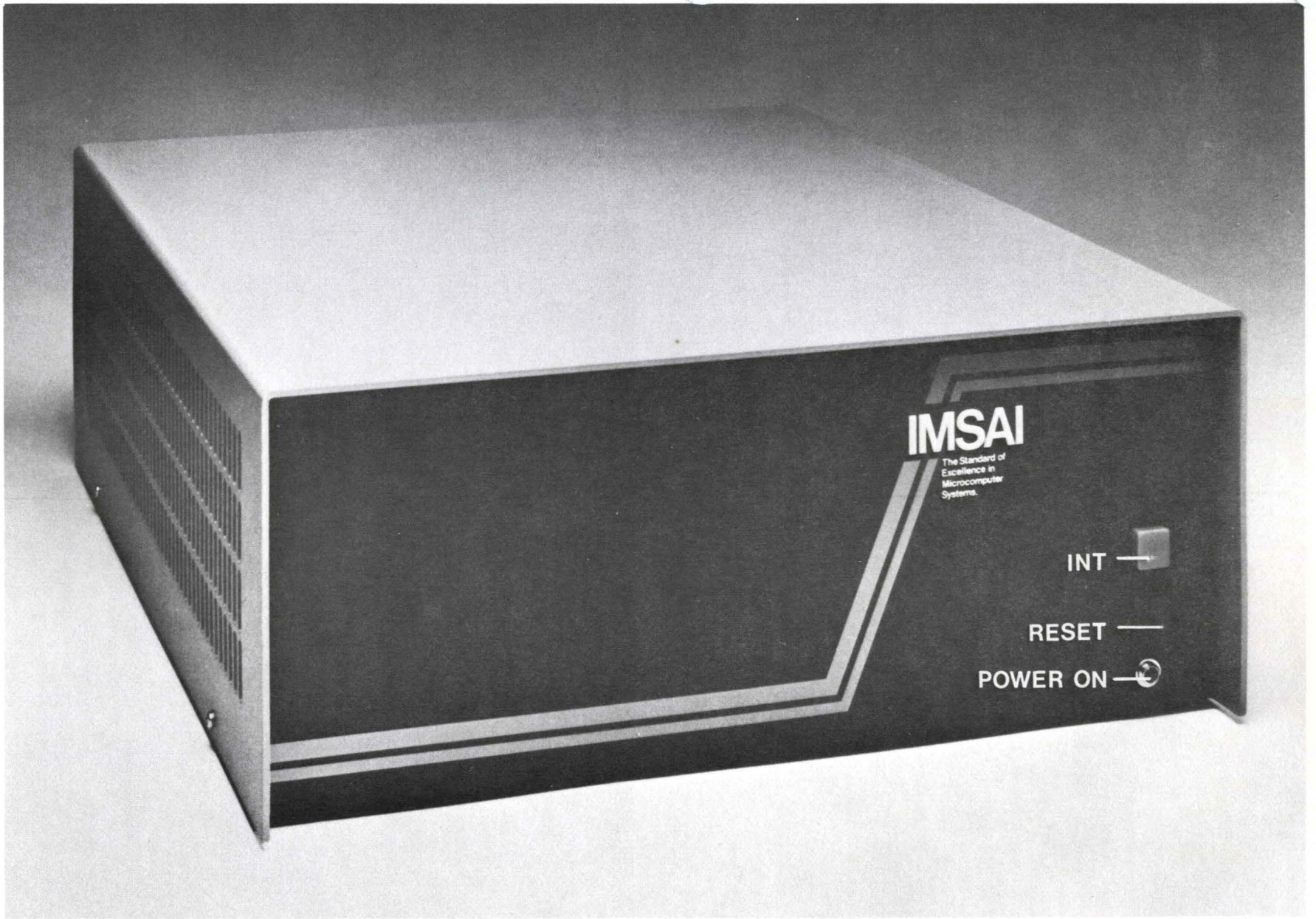

PCSA-80/15 8085-Based Mainframe Computer with operator Front Panel

IMSAI
PCS-80/15
MICROCOMPUTER

Copyright 1977
IMSAI Manufacturing Corporation
14860 Wicks Boulevard
San Leandro, California
Made in the U. S. A.
All rights reserved worldwide.

October, 1977

TABLE OF CONTENTS

SECTION	TOPIC	PAGE
I	THE PCS-80/15 INTEGRATED COMPUTING SYSTEM	
A.	Introduction	I - 3
B.	Functional Description of System Features	
	1. 8085 Microprocessor Board (MPU-B)	I - 7
	2. Power Supply (PS-28U)	I - 9
	3. Motherboard (EXP-10)	I - 11
II	GENERAL ASSEMBLY INSTRUCTIONS	
A.	Kit Unpacking	II - 3
B.	General Assembly Notes	II - 5
III	ASSEMBLY GUIDE	
A.	PS-28U Assembly	III - 3
B.	MPU-B Assembly	III - 17
C.	EXP-10 Assembly	III - 45
D.	Mainframe Assembly	
	1. Bottom Plate Assembly	III - 64
	2. Backframe Assembly	III - 69
	3. Front Panel Assembly	III - 71
	4. Final Chassis Assembly	III - 73
E.	System Testing	III - 75

SECTION	TOPIC	PAGE
IV	OPERATOR'S GUIDE	
A.	Initial System Hook-up and Testing	
	1. Unpacking of Unit	IV - 5
	2. Memory Insertion	IV - 6
	3. Functional Tests	IV - 8
V	HOW TO USE YOUR COMPUTER — A GUIDE TO COMPONENT INTERFACING	
A.	Which Peripheral Should You Buy?	V - 5
B.	Using the VIO Board (with CRT)	V - 13
C.	Using the Intelligent Keyboard (IKB-1)	V - 25
D.	Using An Audio Cassette	V - 35
E.	Using a Floppy Disk	V - 45
F.	Using Paper Tape	V - 55
G.	Using PROMs	V - 59
VI	APPENDICES	
A.	Glossary	VI - 5
B.	Specifications	VI - 11
C.	Schematics	VI - 15
D.	Sample Machine Language Program	VI - 19
E.	The Hex Conversion Table	VI -27

ERRATA INFORMATION

Errata sheets relating to manual clarification and/or correction may be appended to this documentation and will be found either inserted at the front of the manual or immediately preceding the section to which the information applies.

Alteration in content between consecutive editions of a manual are marked by a vertical line on the outside margin of the modified text.

CAUTION: FAILURE TO OBSERVE THESE MODIFICATIONS WILL VOID WARRANTY.

ERRATA

The following changes should be made to your PCS-80/15 User Manual. These modifications are in addition to those presently in the manual.

- a) In the MPU-B assembly instructions, the following should be added at page III - 36:

Insert and solder a 1N4148 diode at location CR1.

Insert and solder a 1N270 diode at location CR2.

Be sure to observe the correct polarity when installing these diodes.

- b) In the System Testing section, the following correction should be made to Step 18 on page III - 78. Connector J1 now is supplied with 6 pins. The table below lists the pins and their voltages.

Pin 1 = 0 volts
Pin 2 = 11.5 - 12.5 volts
Pin 3 = 11.5 - 12.5 volts
Pin 4 = 4.5 - 5.5 volts
Pin 5 = 4.5 - 5.5 volts
Pin 6 = 0 volts

- c) The following change should be noted when installing the front panel switches. Refer to the diagram on page III - 72. Note that these switches should be rotated clockwise, 90 degrees from the way they are illustrated in the manual. That is, the raised lettering should appear on the top of the switches instead of the left side. The instructions below replace steps 71 to 79.

- () 71. Solder the GREY wire from the harness to the top right pin (as viewed from the rear) of the BLUE switch.
- () 72. Solder the GREEN wire to the second pin in from the right of the top row on the blue switch.
- () 73. Solder the RED wire to the third pin in from the right of the top row.
- () 74. Solder the ORANGE wire to the top left pin.

- () 75. Solder the BLACK wire to the lower left pin.
 - () 76. Solder the WHITE wire to the top right pin of the RED switch.
 - () 77. Solder the BROWN wire to the second pin in from the right of the top row on the red switch.
 - () 78. Solder the BLUE wire to the top left pin of the red switch.
 - () 79. Solder the VIOLET wire to the bottom left pin of the red switch.
- d) The supplier of the key-lock switch (part number 26-2000010) has been unable to deliver this part in sufficient quantity. Consequently, your kit may have an alternate switch enclosed. If this is the case, substitute the following assembly instruction on switch installation for those presently in your manual (page III - 71, Steps 60 to 64). If you desire to add the key-lock switch at a later date, please call IMSAI Customer Service, and we will be happy to ship you one as soon as they become available.
- () 1. Connect either wire of the molex connector to pin 2 (the middle pin) of the switch and solder it.
 - () 2. Connect the other wire to pin 3 (the bottom pin) and solder it.
 - () 3. Screw the switch-nut all the way down on the switch shaft. Place the metal washer over the shaft with the raised pin toward the switch body. Place the three nylon washers over the switch shaft.
 - () 4. Insert the switch into the hole in the front panel of the PCS-80/15. Be sure that pin 1 (the pin without a wire connected to it) is towards the top.
 - () 5. Tighten the threaded front plate to hold the switch in position.

I. THE PCS-80/15 INTEGRATED COMPUTING SYSTEM

I. THE IMSAI PCS-80/15 COMPUTER

A. INTRODUCTION

The PCS-80/15 is a general purpose digital computer designed to facilitate simple modular expansion. The unit is supported by a broad range of peripheral devices and interface boards.

The PCS-80/15 features an 8085 microprocessor chip: the Central Processing Unit, or CPU. The 8085 contains all of the basic control and arithmetic functions of the computer in a single integrated circuit. Additional features include a ten-slot motherboard with gold-plated connectors and a 28-amp power supply.

A computer is unable to operate without program material; the machine does not "understand" how to function until you, the programmer, tell it how to do so. Communication between the user and computer cannot occur in English, as computers operate in a binary mode (machine language). Therefore, the man-machine interface is accomplished by supplying the computer with a translating routine prior to loading of user programs. (The only user programs exempt from this procedure are machine-language programs which are entered into memory directly from the keyboard. A machine language listing for a video "chase game" is included in this manual — see Appendix D.)

The ASSEMBLER and the COMPILER are two examples of translating routines. The ASSEMBLER is a program that directs the computer to operate upon a symbolic language program (such as assembly language) and produce a machine language program: a binary-based instruction code, composed of zeros and ones, which is accepted directly by the machine and requires no further translation. Assembly language is a machine-oriented language whose instruction code is often a mnemonic for assembling machine language instructions.

A COMPILER is a program which translates a high-level language program (one written in BASIC or FORTRAN for example) into a machine language program.

The PCS-80/15 requires a program whose function simply is to load other programs into the computer. Your machine is supplied with a set of programs, termed the MONITOR, which allow basic control of the system functions and input of other programs. In the PCS-80/15, the monitor program, rather than having to be loaded into the computer from an external source (such as paper tape, cassette, floppy disk, etc.) is resident in the system in the form of READ-ONLY MEMORY (ROM), also known as FIRMWARE. The resident firmware monitor allows for keyboard control of a wide range of processor, memory, I/O, and text editing functions. Monitor commands also allow loading user programs from floppy disk, cassette, and paper tape.

The monitor exercises primary control of the routines that comprise the operating system as well as functions to observe and verify system operation and to indicate any significant departures from the norm. For example, the user can deposit data into various locations in memory, and can move information from one memory block to another.

The monitor allows the user to control the hardware (physical equipment) by typing in single word commands; this relieves the user from the necessity to toggle in each command in binary from a bank of front-panel switches — a method which is more tedious and prone to error — since the basic commands are already resident in the monitor of the system. For example, in answer to a keyboard command to examine the contents of a particular memory location, i.e., "EXAMINE ADDRESS X", the monitor will give the user the contents of that address.

MULTI-FUNCTION PROCESSOR BOARD:

The heart of the PCS-80/15 is the MPU-B processor board. It contains an 8085 microprocessor chip, and parallel and serial input/output (I/O) interfaces. I/O interfaces allow the central processing unit to communicate data to an external device, such as a printer, paper tape reader, etc. Words are stored in the computer in the form of 8-bit binary numbers (BYTES). Depending upon the requirements of the external device, all eight bits in a word may be supplied simultaneously over eight different lines (PARALLEL I/O), or sequentially, one at a time, over a single line (SERIAL I/O).

The MPU-B contains a unique array of features which may be imposed upon or removed from the system memory space under software control. These features include three 16-bit programmable timers, 256 bytes of read/write or RANDOM ACCESS MEMORY (RAM), keyboard control of a wide range of system functions, and a firmware monitor program which allows for bootstrap loading from an external floppy disk.

A BOOTSTRAP (or BOOTSTRAP LOADER) is a program which is read into the computer in order to supply information necessary to enter yet other programs (which may be a monitor program) into RAM.

PCS-80/15 MAINFRAME:

The PCS-80/15 Mainframe is a quality cabinet and frame system, designed for reliability, easy access, and modular expansion. The mainframe houses a full 28 amp power supply and is designed to be compatible with the S-100 bus system. The S-100 BUS is a system of one hundred lines which include power lines, memory address and data lines, various synchronization and control signals, and lines for input and output of data to and from external devices.

Each printed circuit (PC) board in your PCS-80/15 computer — MPU-B, any RAM you may purchase, etc. — plugs into a socket on another board called a MOTHERBOARD. When a PC board is installed onto the motherboard, all of the one hundred connections described above are made from the circuitry on the PC board to the S-100 lines on the motherboard. All lines in use on a PC board are always connected to the bus and, hence, to similar lines used by every other PC board (i.e., all data lines of one PC board are connected, in parallel, with all data lines of every other board plugged into the motherboard). Any PC board, then, can be plugged into any slot on the motherboard.

Access to the bus is usually controlled by the central processing unit on the MPU-B. The motherboard (EXP-10) supplied with the PCS-80/15 is capable of accepting up to 10 S-100 type PC boards.

The PCS-80/15 Mainframe is available in rackmount or table top versions and may be further combined with the PCS-80/25A or B mainframes (see the IMSAI PCS-80 System Configuration Guide) to form an integrated two-high cabinet system.

DOCUMENTATION:

This volume, the IMSAI PCS-80/15 User Manual, contains a detailed description of the features and configuration of the PCS-80 system module with operator's front panel. The printed circuit boards which constitute the system building blocks are also described.

Section I of the manual presents a functional description of the module features — the circuit boards and power supply.

Section II outlines general assembly instructions; assembly of each unit of the module is described in Section III. Assembly instructions are accompanied by photos, assembly drawings, and a complete parts list which is inserted at the beginning of each set of instructions.

Section IV is an operating guide which details the connections to I/O devices and instructs the builder in the use of the design features of the processor board to implement various functional options.

Section V is a user guide to the interfacing of the PCS-80/15 with peripheral devices and special function PC boards.

Appendices offer a glossary, unit specifications and schematics.

The actual operation of each board in the PCS-80/15 module, as well as detailed functional descriptions for the advanced user, is described in the Reference Manual enclosed with each unit.

Supporting documentation is provided by a copy of the Intel 8085 Microcomputer System Users Manual; supplied in every mainframe kit, the manual supplies IMSAI users with the primary source of detailed information about the function and instruction set of the logic implemented by the IC chip set used in the PCS-80/15. A handy reference card, the Intel 8085 Assembly Language Reference Card, is supplied to summarize much useful information from this manual.

To assist users in gaining a full perspective on the design and use of microprocessor-based computer systems, IMSAI recommends a basic text, An Introduction to Microcomputers, by Adam Osborne.

B. FUNCTIONAL DESCRIPTION OF SYSTEM FEATURES

1. THE 8085 MICROPROCESSOR BOARD (MPU-B)

The MPU-B is the central processing board for the IMSAI PCS-80/15 computer. It is designed using the Intel 8085 microprocessor chip. The bus arrangement and board connector make your IMSAI unit extremely flexible, as the S-100 bus is becoming a small computer industry standard.

Every effort has been made to keep the design simple to maximize reliability and ease of maintenance. Extensive use has been made of MEDIUM SCALE INTEGRATION (MSI) and LARGE SCALE INTEGRATION (LSI) chips, which contain a large amount of circuitry. This minimizes external interconnections, simplifies system construction, and increases system reliability.

In addition to the processor, the board contains:

- Two thousand (2K) bytes (8-bit words) of program (the monitor program) embodied in ROM
- 256 bytes of RAM
- Power On Jump (when the computer is turned on, program control jumps to a specific location in memory)
- Serial I/O
- Parallel I/O
- Timers
- 5-level interrupts

The PCS-80/15 can be used with a standard terminal as a single-board computer, or with one RAM-32 board and a standard terminal for a complete computer with 32K bytes of memory (less mass storage). An MPU-B, RAM-32, Video Interface Board (VIO-C), TV monitor and Intelligent Keyboard (IKB-1) form an alternate complete 32K byte computer. The 2K ROM included provides system initialization, boot loaders, and basic monitor. Complete facilities for machine language development and loading higher level systems are provided by the combination of the firmware on a VIO board (VIOROM) and the MPU-B ROM.

The 8085 is the successor of the most popular microprocessor chip in the industry, the 8080. The 8085 provides a decrease in the number of components, which increases reliability and permits inclusion of more functions on the processor board. It provides 50 per cent faster performance, while maintaining or improving timing margins on the paths over which information is transferred (busses). As a result, higher speed memories are not needed to achieve the higher performance. Standard 450-500 nsec S-100 memories are actually run with greater timing margins in spite of the 50 per cent increase in instruction execution rate. No wait states are required to slow the processor operation.

IMSAI PCS-80/15
SECTION I-B
FUNCTIONAL DESCRIPTION
MPU-B

The 8085 has four new vectored interrupt pins, one non-maskable, three individually maskable. "Masking" refers to the ability of the 8085 to ignore certain interrupts under program control. "Non-maskable" interrupts, on the other hand, will always be responded to.

An interrupt is a request (from an external device to the CPU) to halt execution of the current program in order to service another program required by that interrupt. When the system is halted by a signal from a specific interrupt pin, program control is "vectored" (directed) to a specific location in memory where the program for servicing that interrupt is stored (i.e., four different interrupts could cause the program to halt and resume operation at four different locations).

In the PCS-80/15, three of these interrupts can be masked under program control — the computer can be instructed to ignore these interrupts at certain times — and one of these interrupts is non-maskable (the CPU must always respond to that interrupt). Used with the original interrupt request of the 8085, this provides a five level maskable priority interrupt system. (A priority interrupt system deals with the case in which two external devices simultaneously request an interrupt; a priority system provides rules for which interrupt requests will be serviced first.) This enables the MPU-B to be used in sophisticated interrupt driven systems without additional interrupt controllers. Provisions are made for using the I/O and timers included on the MPU-B with the interrupts. (The PIC-8 interrupt controller board accessory may be used to increase the number of priority interrupts to 12 — see the IMSAI SHORT FORM CATALOGUE.)

All 8080 software is 100 per cent compatible with the 8085. The performance increase of the 8085 is available without recoding, without changing ROM's, and without re-training programmers. All investment in software is completely maintained while gaining the performance increase of the 8085. The board contains a socket for PROM or ROM and is provided with jumper wires to configure the socket for 1K or 2K byte PROMs or 1K, 2K, or 4K byte ROMs. A 2K ROM monitor is included with the system. Under software control, the ROM can be located at location 0000, or at D800 (hexadecimal notation — see Chapter 2 of An Introduction to Microcomputers for a discussion of this and other number systems). In other words when the computer is first turned on, the initialization circuitry ensures that the monitor begins operation at the first address.

(Refer to the PCS-80/15 Reference Manual for further details on the MPU-B.)

2. POWER SUPPLY (PS-28U)

The IMSAI PS-28U is a 28 amp modular, unregulated power supply for the 8085 System with adequate reserve power to drive more than ten S-100 boards. It provides the basic, unregulated +8, +16, and -16 system supply voltages and can be configured for single phase (house current) AC input voltages at either 50 or 60 Hz: 92, 103.5, 115, 126.5, 184, 207, 230, and 253 VAC (volts AC).

The AC line is filtered for increased immunity to noise. A low-pass line filter and 50/60 Hz switched and unswitched terminals for connecting auxiliary power outlets are located on the rear of the PS-28 PC board.

The PS-28U measures 16.5" x 5.75" x 5.5" (42 x 15 x 14 cm) and weighs 16 pounds (7.3 kg).

3. MOTHERBOARD (EXP-10)

The PCS-80/15 Motherboard assembly contains the S-100 bus line and PC board connections, allowing up to 10 S-100 type boards to be plugged into the PCS-80/15 unit. Five connectors are included in the standard unit; an EXPM-5 edge connector must be purchased for system expansion.

The motherboard assembly also contains voltage regulators to provide +5 VDC for the bus line and lamp driver circuits controlling the front panel "Power On" (RESET button) and "Halt/Acknowledge" (INTERRUPT button) indicators.

Signal traces are interleaved with ground traces for better signal isolation on the back plane.

All signal lines are terminated (to 2.6 VDC) with resistors in order to reduce reflected signal noise in the back plane.

The EXP-10 assembly includes a heat sink end bracket for the power components of the termination circuit (see Glossary).

Connections between the motherboard and the rest of the PCS-80/15 unit are accomplished with Molex and tab style quick-disconnect connector assemblies.

II. GENERAL ASSEMBLY INSTRUCTIONS

This section addresses the following topics:

- A. Kit Unpacking Instructions
- B. Construction Hints – general notes on how to build your kit

II. GENERAL ASSEMBLY INSTRUCTIONS

(NOTE: If you have purchased an assembled unit, refer to Section IV-A of this manual for instructions concerning unpacking of your unit.)

A. KIT UNPACKING

1. Remove all packages from the outer box. For a standard IMSAI PCS-80/15, these will consist of:
 - a. Documentation Set (Manual plus two books)
 - b. Cabinet Base Plate
 - c. Table Top Cover (or Rackmount cover and Rackmount painted pieces)
 - d. Two large inner boxes
 - e. Two small inner boxes.
2. The largest inner box contains flat parts such as PC boards and small sheet metal parts.
3. The remaining large inner box contains plastic sacks of components. There will be a plastic sack corresponding to each PC board, plus sacks for the chassis and rackmount hardware.
4. One of the two small boxes contains the large components for the Power Supply (transformer, capacitors, etc.).
5. The remaining small box is either empty (serving as a spacer for packaging purposes) or contains overflow from the sack parts box.
6. Unpack plastic sacks only when you are ready to begin assembly of that particular module. If any parts are missing, contact IMSAI Customer Service for immediate replacement.
7. Exert care in handling the painted sheet metal parts, the plastic parts and film negatives to avoid scratching. PC boards should not be stacked without protective material between them in order to avoid destroying or shorting traces.

B. GENERAL ASSEMBLY NOTES

CONSTRUCTION HINTS

GENERAL

The IMSAI PCS-80/15 module is a complex piece of electronic equipment. This section covers a number of items, each of which must be assimilated to insure a working system at the completion of assembly. While each step of assembly is easy to accomplish accurately, there are many steps and it is easy to do one or more of these incorrectly. This entire section must be read completely before beginning assembly, and the builder should refer back to the notes in this section often enough to ensure that no components are installed improperly.

There may be assembly instructions about which you are uncertain. Should this occur, DO NOT CONTINUE ASSEMBLY!. Study the manual to see if you can resolve your question or seek the help of someone more knowledgeable in digital electronics. If you feel your question is not resolved by further study, call IMSAI. This will enable you to do a better construction job, and it will provide us with the input necessary to the improvement of this manual. We recognize that some builders will have had very little experience in assembling electronic kits; it is our intention to continually revise the manual based on user commentary, so that even the most inexperienced builder can achieve the best results with a minimum of effort. No comment is too insignificant to apprise us of. Refer to the photographs at the end of this section in order to identify components with which you may be unfamiliar.

TOOLS AND WORKPLACE

The production of a working machine requires proper tools and an adequate workspace. Although the kit does not require much space for assembly, enough table surface should be available for the piece being worked on, the tools needed for that unit, and an orderly arrangement of the components which will be used in assembling that unit. The work area should be very well-lit, with no shadows. You may want to protect the table surface with cardboard or newspaper.

The single most important assembly tool is the soldering iron. Other tools which are necessary to an adequate assembly job are screwdrivers which fit the screws used in the kit (both straight slot and phillips), a small pair of diagonal cutters (preferable a 4" pair, flush-cutting), small needle-nose pliers, and a wire stripper. A 1/4" nut driver will make cabinet assembly much easier, as the sheet metal screws used are designed primarily for use with such a driver. A Voltmeter should be available for equipment testing. Any inexpensive meter (VOM) with DC voltage scales between 5 and 30 volts should do. Do not attempt to assemble the kit until you have the necessary tools; parts damaged during assembly cannot be replaced under warranty.

SOLDERING

Most of the problems encountered in kit malfunction reflect improper soldering technique. If you do not have facility in making good solder joints both quickly and reliably, practice before beginning assembly on the IMSAI PCS-80/15 boards. Obtain some extra #20 hook-up wire; practice joining pieces of wire together, as well as soldering locally, until you feel able to make a neat joint quickly and comfortably. The importance of good solder joints cannot be emphasized enough.

SOLDERING IRONS

We do not recommend use of a soldering gun. Not only can a gun provide more heat than is necessary, but also many users tend to make poor solder connections because they do not wait long enough for the gun to reach its operating temperature each time. A great many tools are available with the appellation "soldering iron". Two thirds of these are inappropriate to small electronics assembly — they are too large and too hot — and, if used, are almost certain to damage both parts and boards. Proper soldering irons are available at any local hobbyist electronics outlet and they are inexpensive. Use a 30-40 watt iron with a small tip, such as an Ungar 776 with a 7155 tip. If you wish to invest in a top-quality tool, a temperature-controlled tip model such as the Weller W-TCP with a small 700 degree Fahrenheit tip is well worth the extra cost. Many irons are available with either plated or unplated copper tips. Though slightly more expensive, the plated tips last much longer and give superior service.

SOLDER

There are many types of solder available, and using the proper solder is as important as choosing the proper iron. In normal electronics assembly, paste and liquid flux are not used. Rather, a solder with a "core" of rosin (or resin) base flux is used. This flux (contained in the hollow center of the solder) should be sufficient. Do not use any solder employing an acid flux. **USE ONLY ROSIN CORE SOLDER.** Acid fluxes are used for mechanical soldering where the surfaces are not as clean as those in electronics assembly; they are corrosive and will typically damage a printed circuit.

The ratio of tin to lead used in the solder is also important. We recommend 63% tin, 37% lead, called 63/37 or "eutectic" solder. Avoid using 50/50 or 40/60, even though they are less expensive. The higher-lead ratios solidify gradually, while the 63/37 solidifies almost instantaneously, making "colder solder joints" much less likely.

The gauge (or diameter) of the solder is an important consideration, as well. For fine electronics work, a fine gauge such as #20 should be used (from #19 to #22 is acceptable). Again, the correct solder is easy to obtain from any local hobbyist electronics outlet or TV repair shop. ERSIN Multicore or KESTER are two brands which are reliable. The solder included in the kit should be sufficient. If for some reason it is not, and you cannot obtain the proper solder locally, **DO NOT USE** any substitutes. Additional solder of the proper type can be obtained from IMSAI.

SOLDERING TECHNIQUE

The integrity of every solder connection is essential to a working machine. Good solder joints require application of enough heat so that both pieces of metal involved in the joint are hot enough to melt the solder. Apply the solder and the hot iron at the same time to the junction of wire and foil pad on the PC board, so that a small amount of solder melts and "wets" the joint (flows smoothly onto both the lead and pad). Remove the iron and allow the joint to cool. Careful inspection of each joint is the key to successful soldering. A well-made connection looks smooth and shiny. For the typical joint, heat need be applied for only 2 to 4 seconds, and only a small amount of solder is necessary (approximately 1/8" of 20 gauge solder wire). Do not allow too much solder to build up on the tip of the iron or it may fall onto adjacent circuitry. Additional heat and solder will be required for joints with larger leads and holes or larger foil areas; if more heat or solder is needed on typical component leads (like IC's), it is an indication that something is awry.

Nearly all the holes in IMSAI printed circuit boards are plated-through (the inside walls of the hole have a metal surface, connecting the pads on the opposite sides and providing a greater area for solder to adhere to); some solder will typically wick through and be visible from the top side of the board. If, however, small drops of solder seep through to the top side, it is an indication that too much solder and heat are being applied. These balls of solder can easily short to neighboring pins and must be avoided. If one of the small gaps between foil pads or traces has been shorted with too much solder, the solder bridge can be removed by running the hot iron lightly down the shorted trace, re-melting the solder at the shorted point, and pulling it away with the iron. Do not apply the iron to traces or pads for too long a time when soldering or fixing a short, as overheated traces easily come off the board.

The tip of the iron must be kept clean if it is to work well; if you frequently wipe the tip with a wet sponge and occasionally add a small amount of solder to the tip, it will aid the transfer of heat to the connection. The tip must be kept adequately tinned at all times to avoid formation of an oxide coating and should appear bright and shiny. Tips may be cleansed of oxide by fine steel wool or other abrasive, but a plated tip should never be filed.

A solder drip on a PC board is often extremely difficult to see, and it is sure to short several traces and damage components when the board is operated. Inspect your boards carefully for any such solder drips, for shorts near soldered leads, for incompletely soldered leads, and for unsoldered leads. When soldering components with long leads (resistors, etc.) clip the leads after soldering and check all joints on those components. A completed unit will typically run when first turned on if the soldering is done correctly.

MOS IC HANDLING

Some of the chips in this kit are MOS (Metal Oxide Semiconductor) type chips (such as the 8085 CPU chip) and are sensitive to static electricity and other large transient voltages. In order to prevent damaging these chips, some precautions are in order to avoid the discharge of static through the pins.

Avoid working in a room with very low humidity and wearing fabrics which generate a lot of static. The work area should not be located near the air exit from a "heater" vent, as the air is extremely low in humidity. All objects involved in the construction process (chip, board, iron, tools, boxes, chip containers, work surfaces and you) should be maintained at equal potential, which requires continuous physical contact between them. For example, before removing a chip from a box and setting it on the table, set the box on the table, touch the table, and only then pick up the chip to place it on the work surface. Avoid touching the pins; handle the chip from the ends and always touch the chip's container or the surface which it is touching before picking up the chip itself. In addition, touch the surface or container before placing the chip back inside it. Touch PC boards before inserting chips. Touch the soldering iron to the work surface or to a small piece of metal foil on the work surface before touching it to the PC board. In general, make sure the chip is not the path for any static discharge. Save MOS IC insertion as the last steps in assembly to avoid unnecessary damage to components.

POLARITY

Many electronic components will not work if they are connected backwards. These components are marked to indicate polarity; the boards on which they will be mounted have a corresponding mark at each location, or an indication that all such components are installed in the same manner as a marked "typical" component.

INTEGRATED CIRCUITS (IC'S)

All IC's must be inserted with pin 1 in the correct location to avoid damaging the chip (see Figure II-1 below). The location of pin 1 is indicated by a rounded or square notch at the edge of the chip near the pin or by a slightly depressed or raised dot at the same end. (NOTE: Many IC's have a 4-digit code for date of manufacture; for example, 7425 indicates manufacture in the 25th week of 1974. Do not confuse these numerals with the device numbers which have manufacturer-dependent suffixes and prefixes; for example SN7404N is a 7404 type chip.) The PC board is marked with a square pad, a dot, or an arrow showing pin 1 orientation (with the note "typical", indicating all chips on the board face the same way). If a chip is mounted in the wrong direction and needs to be removed, damage to the board or IC may result. If you do not feel yourself to be capable of unsoldering an integrated circuit without damage to the circuit or to the board, send the board back to the factory to have the work done for you. Remember that these boards have plated-through holes; pins are not only soldered to the top of the board where the bead of solder is visible, but are joined to the inside of the hole as well, making them much more difficult to remove.

FIGURE II-1
IC PIN NOMENCLATURE

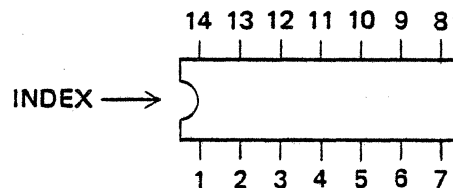

DIODES

Diodes typically have a band around the body of the component next to the cathode end. The band corresponds to the bar on the typical diode symbol. The same is true for Zener diodes. A diode symbol should be found on the board or assembly diagram to indicate the proper mounting direction.

Capacitors

Some capacitors such as the tantalum and power supply electrolytic capacitors have a plus and minus lead. Some mark on the body of the capacitor will indicate the plus lead, typically a + sign near the lead. There will be a mark (normally a + sign) on the board or assembly diagram to indicate the proper direction in which to mount the capacitors. Capacitors of this type are usually destroyed very quickly if power is applied to them in the reverse direction, so check your assembly carefully.

Transistors

Most transistors have a flat side or a small tab to indicate the lead orientation. Transistors with hemispherical caps have pins which are aligned. Pin nomenclature may be stamped on the transistor body above each pin; i.e., "EBC" denotes, in order, "emitter", "base", and "collector". In order to determine the designation of each pin, hold the transistor as shown in Figure II - 2.

Transistors with bubble caps have a flat face which is apparent only after close inspection of the component. Pins of this transistor type are not aligned. The "emitter" is located immediately below the flat side of the cap; the other pins may be identified by orienting the component as shown in the figure below.

When installing transistors on a PC board, ensure that the leads (E, B, C) match the alphabetical designation on the silk screen: drawings of transistor orientation appearing on a PC board may be incorrect. Should the silk screen be unmarked, insert the emitter lead into the square pad on the PC board.

When the transistor is oriented correctly, the leads should fit in the eyelets with little bending and no crossing.

FIGURE II - 2
 TRANSISTOR MOUNT DETAIL

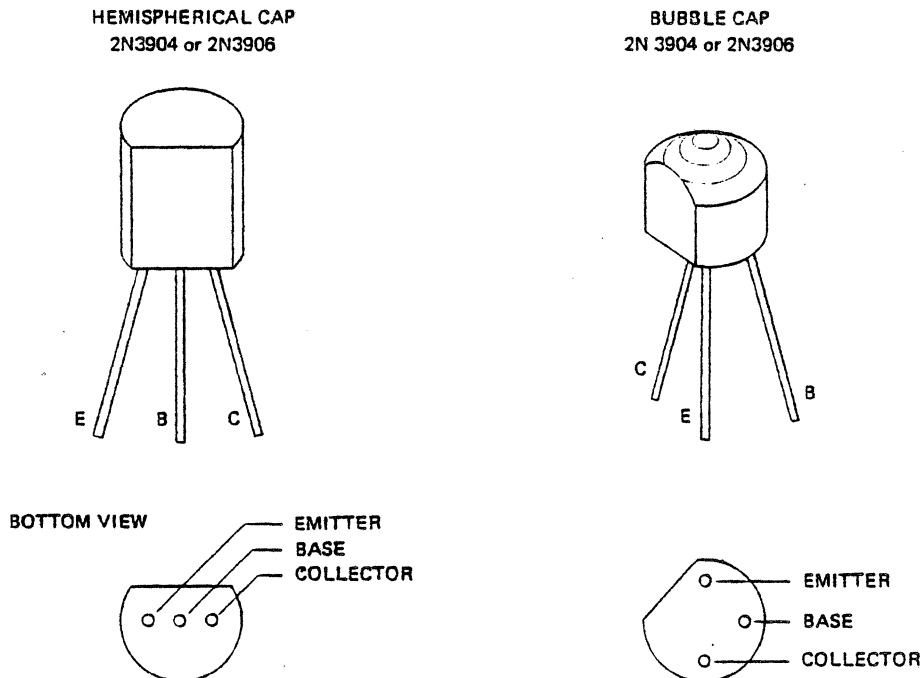

MOUNTING COMPONENTS

Integrated Circuit Chips (IC's)

Some of the chips are shipped in a small plastic rectangular case which can be used to insert the chip into its PC board. Set the carrier and chip on a piece of felt; lightly push down on the top of the carrier with a pencil eraser until the chip slides down with its leads resting against your table top. Pick up the carrier and set it on the PC board; line up the protruding pins of the IC against the mounting holes and, while holding the carrier, push the chip the rest of the way into the board with the pencil eraser. You can use empty carriers to install chips which are not shipped in containers. Turn the carrier upside down and set the naked chip into the carrier. Continue installation using the process described above.

If an insertion aid is unavailable, place the chip in the PC board and bend two diagonally opposite pins slightly in order to hold the IC in place while soldering.

Take special care to observe the following precautions for all chips:

1. Ascertain that pin 1 is installed in the correct orientation. Refer to markings on the board or assembly instructions to determine proper orientation.
2. After inserting the chip and before soldering, check that all pins are inserted into the holes correctly before soldering the chip into place. Sometimes a pin will catch on the edge of a hole and bend under the chip instead of going through the hole.

Power Regulators

The regulators for the power supply are supplied with heat sink and mounting hardware. The three leads on each component should be bent down at the proper lengths to match the solder pads with needle-nose pliers. Each lead should exit straight out of the component and bend sharply down, rather than sloping gradually towards the hole (see Figure II-3 below). After the leads are bent, fasten the regulator to the board along with the heat sink, using the short 6-32 screw on the top of the board and the lockwasher and nut on the back. The regulator should be held to prevent turning while the nut is tightened firmly. The nut should be tight enough to insure good heat conductivity between the regulator and heat sink and board. Heat sink grease may be used if desired.

FIGURE II-3
INSTALLATION OF POWER REGULATOR AND HEAT SINK

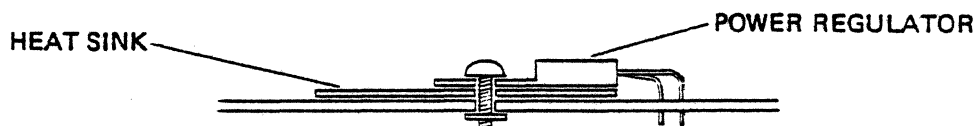

Discrete Components

Resistors and diodes can be installed most neatly using a lead bender to bend the leads consistently. Most pads for this sort of component are .5" apart.

Disk ceramic capacitors often have the dipped insulation extending down the leads a short distance, preventing these components from being pulled all the way to the board. This insulation may be removed by gentle scraping with a fingernail.

All discrete components should be held in their desired final position while being soldered. Normally, this entails holding them against the board by putting a slight bend in the lead behind the board (see below).

FIGURE II-4
BRACING OF DISCRETE COMPONENTS BEFORE SOLDERING

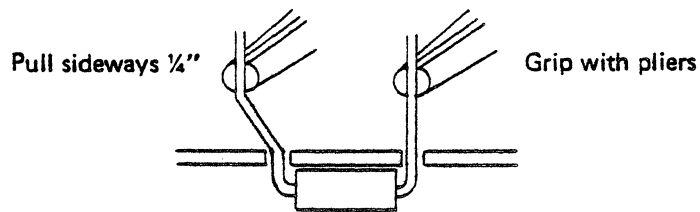

CABLE

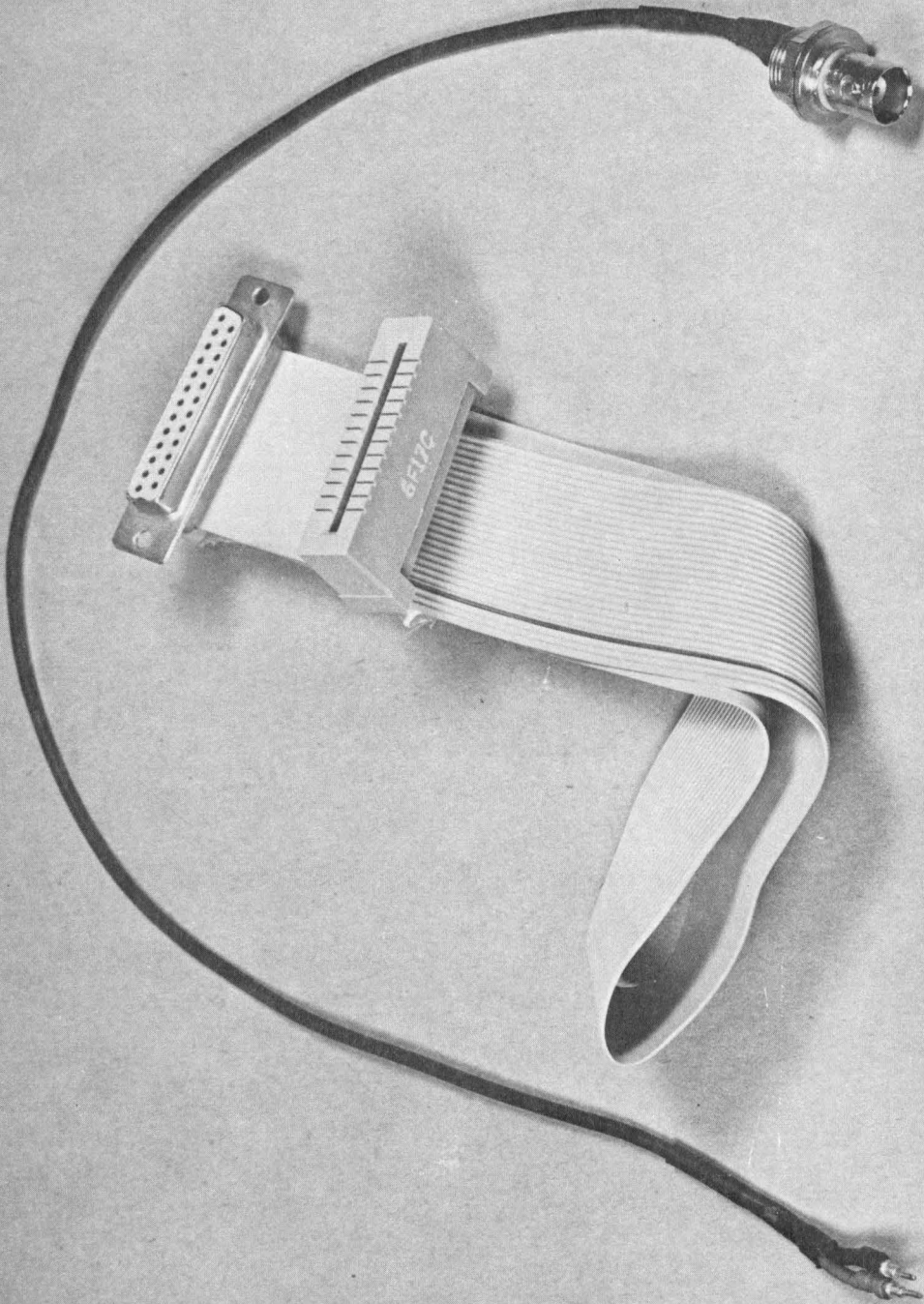

Cable Tie



CAPACITORS

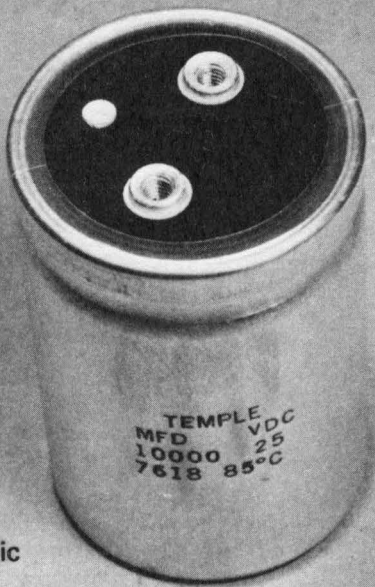

Electrolytic

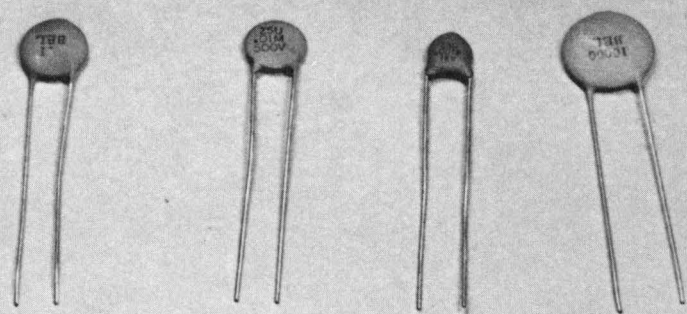

Disk Ceramic

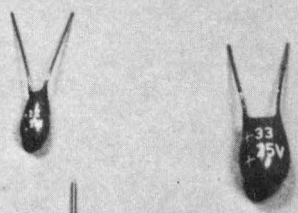

Tantalum

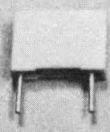

Mylar

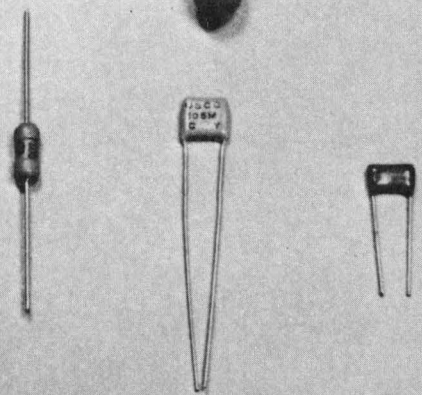

Silver-Mica

CONNECTORS

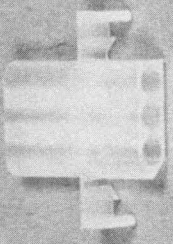
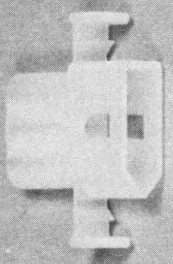

Molex

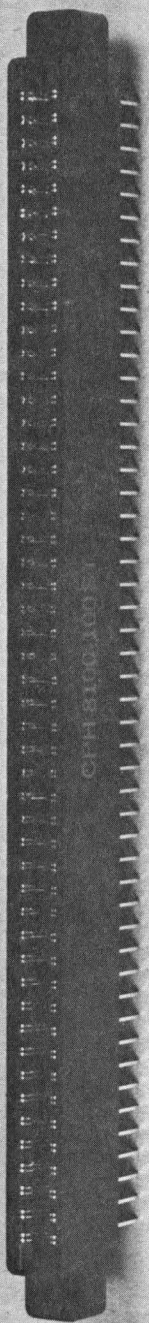

Edge

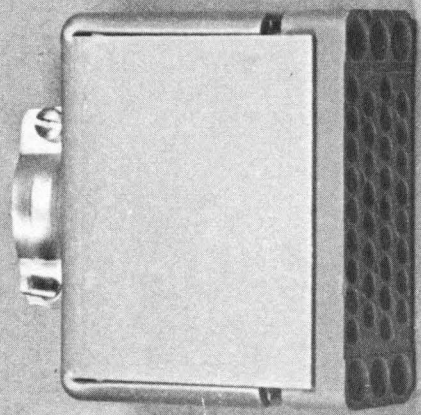

Winchester

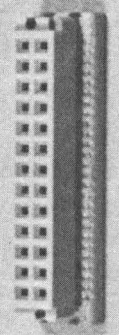

Cable Connector Assembly

CRYSTALS

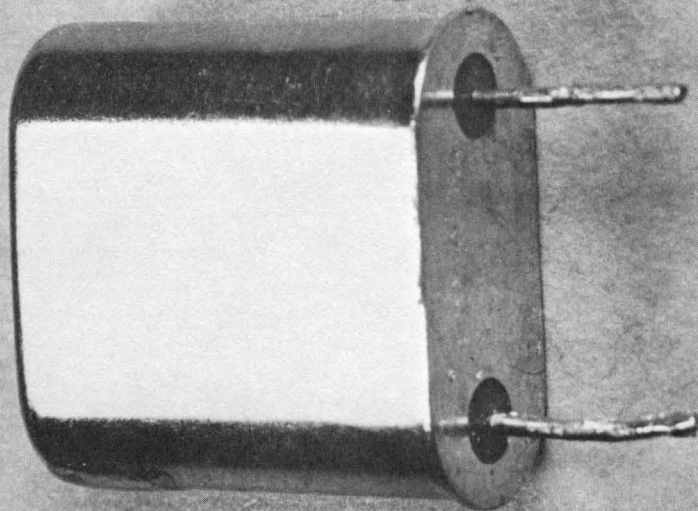
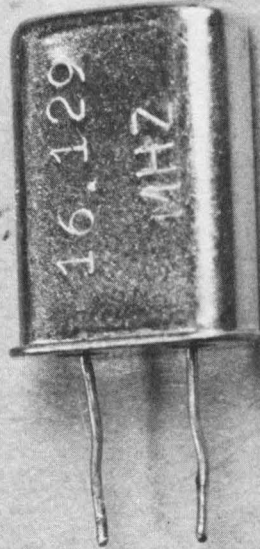

HEAT SINKS

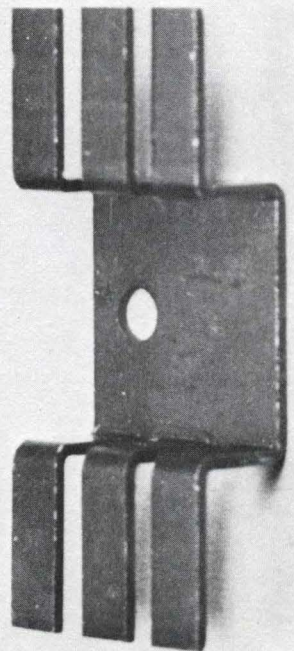
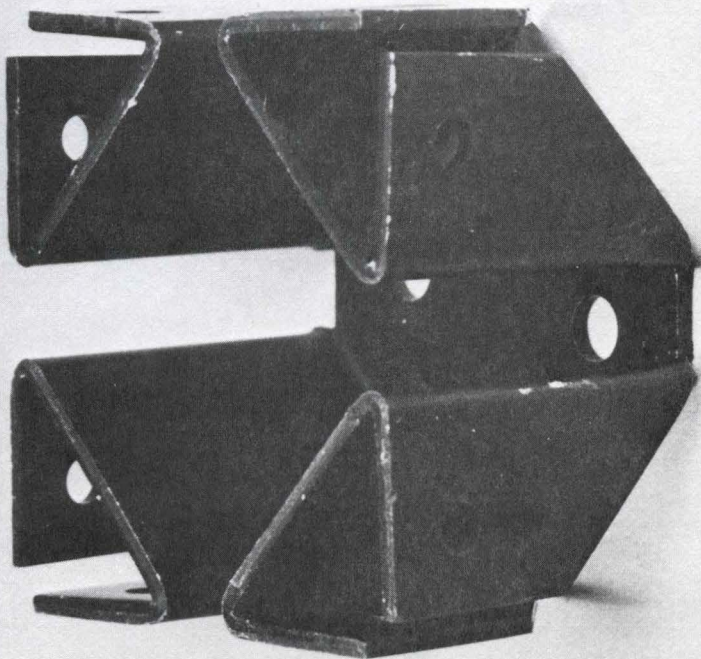
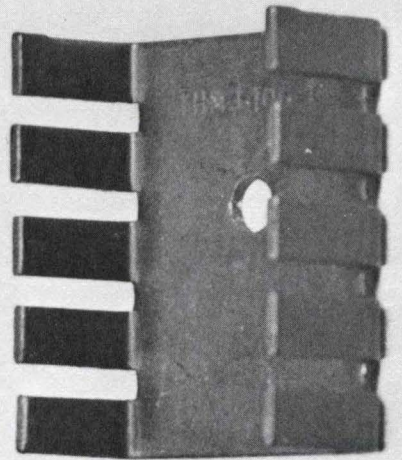
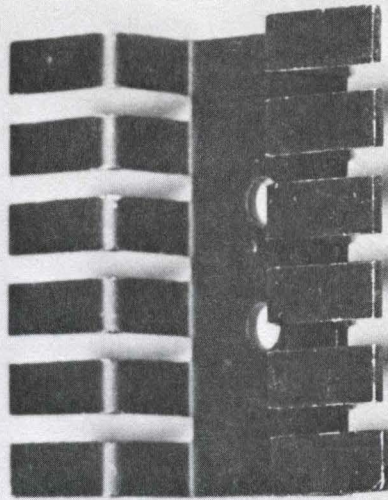

INDUCTORS

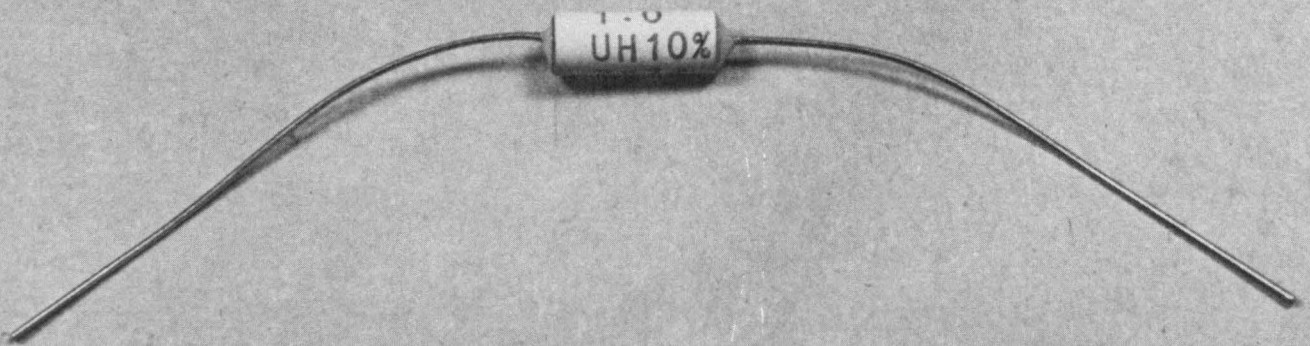
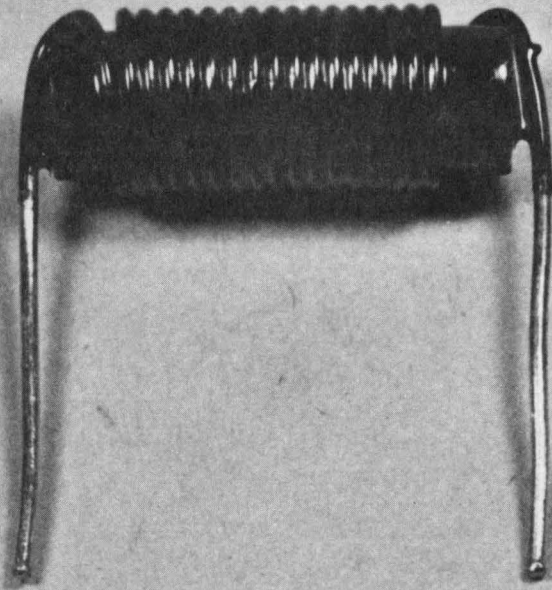

INTEGRATED CIRCUITS

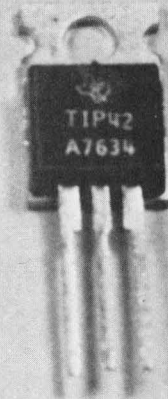
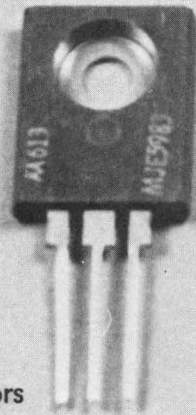
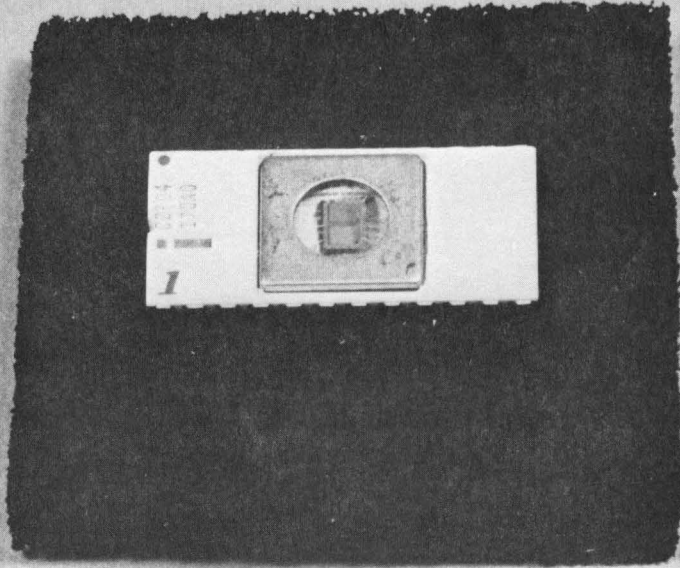
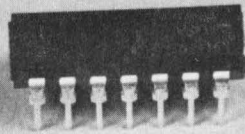

Voltage Regulators

REGULATORS

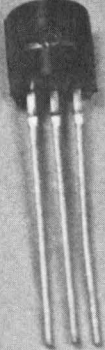
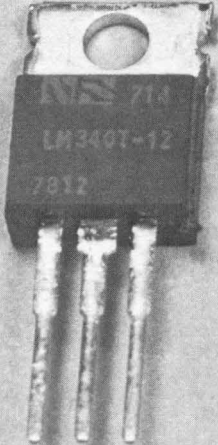

RESISTORS

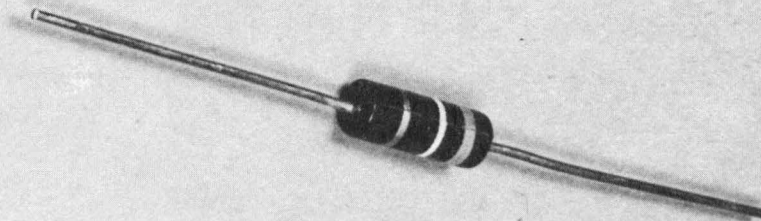
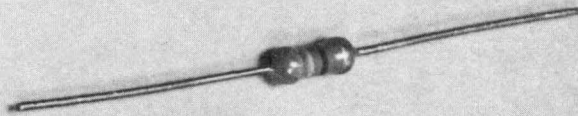
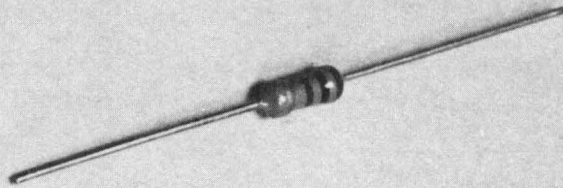

SIP
(single in-line
package resistor array)

SOCKETS

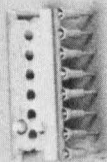
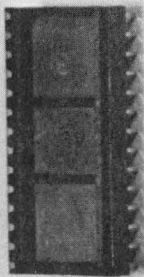
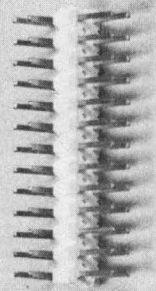
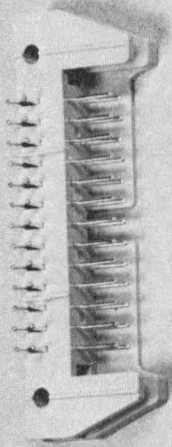
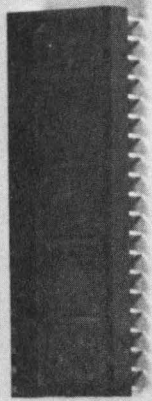

Socket Carrier Assembly

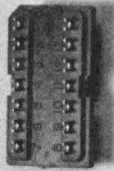

Cambion Pin & Socket

socket

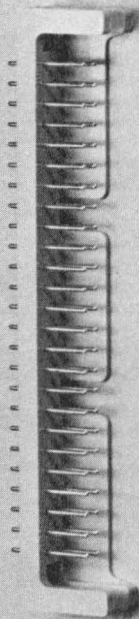

Header

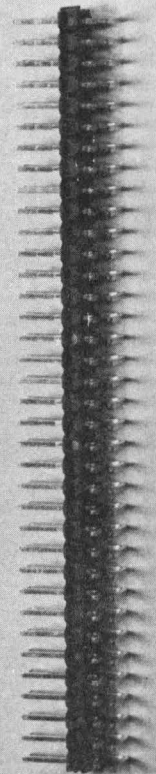

SWITCHES

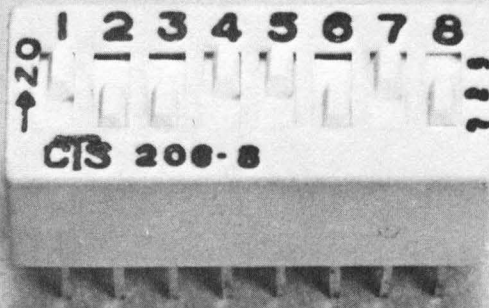

DIP

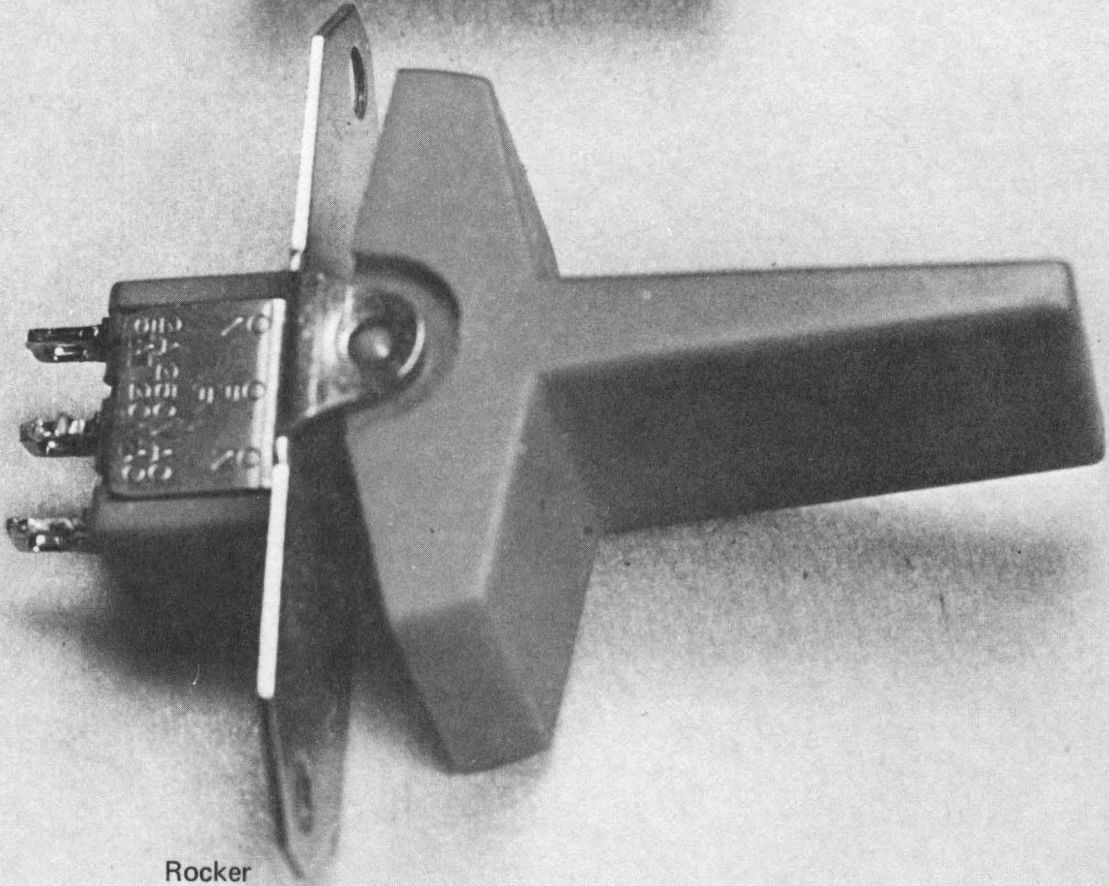

Rocker

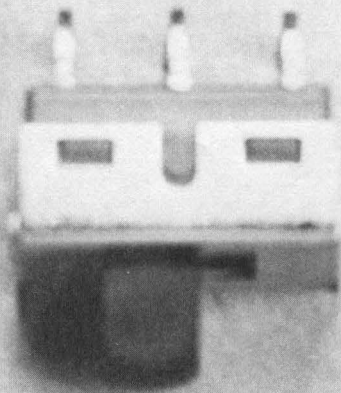

Slide

TRANSFORMERS

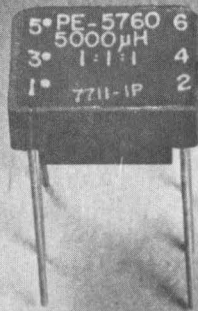
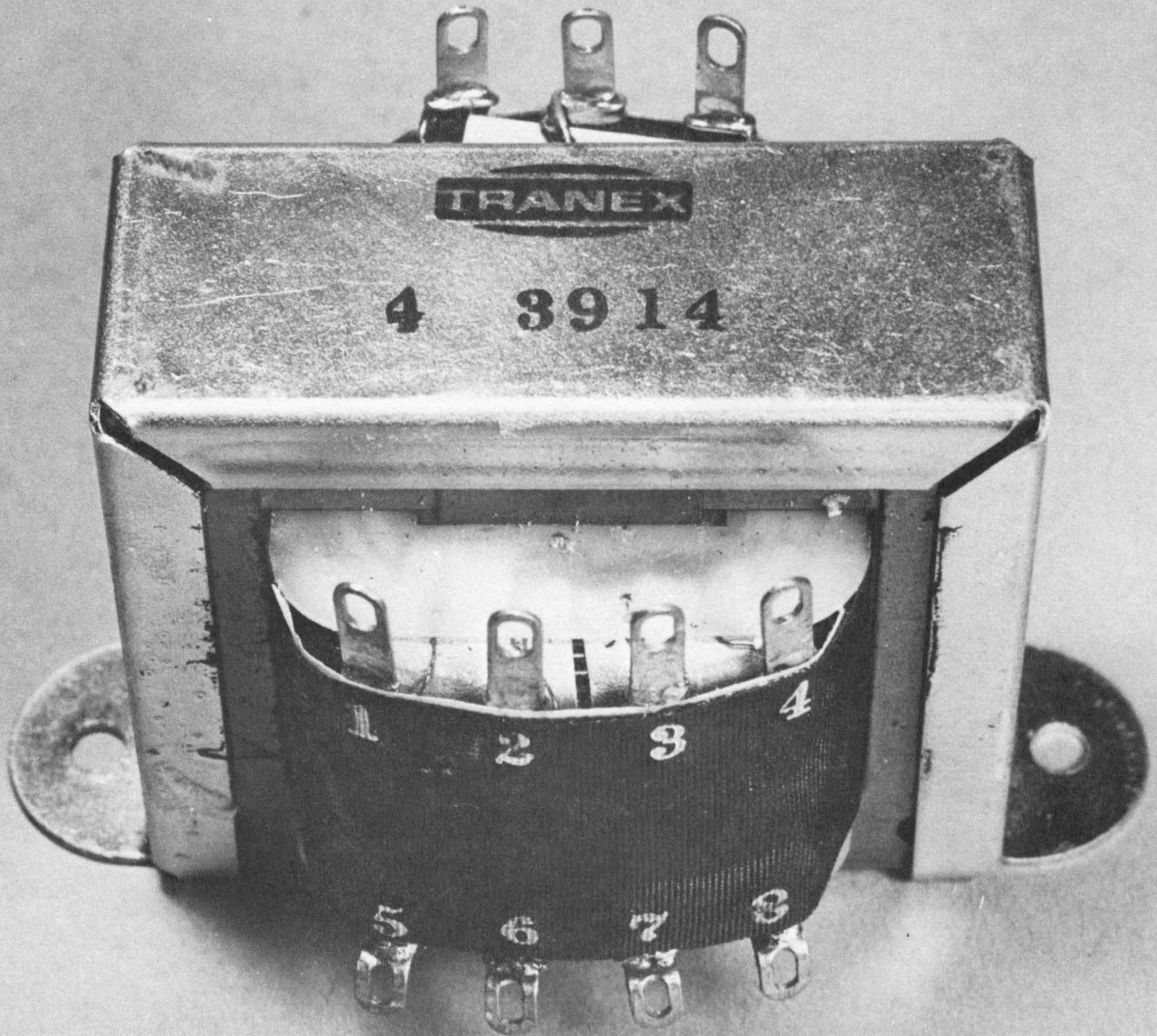

TRANSISTORS

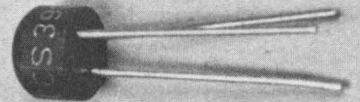
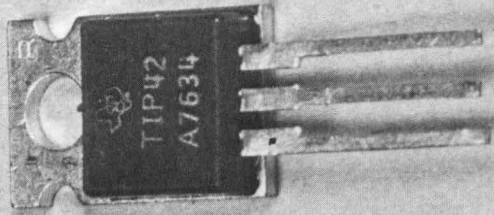
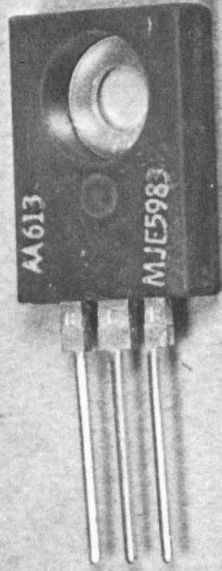

III. ASSEMBLY INSTRUCTIONS

A. PS-28U ASSEMBLY

IMPORTANT

Due to the development of a new transformer, the PS-28U assembly instructions originally included in this manual were rendered inaccurate. Consequently, this section was removed from this manual and replaced with a separate PS-28U chapter. Please refer to this chapter for the information necessary to assemble the power supply.

B. MPU-B ASSEMBLY

MPU-B (PCS-80/15)

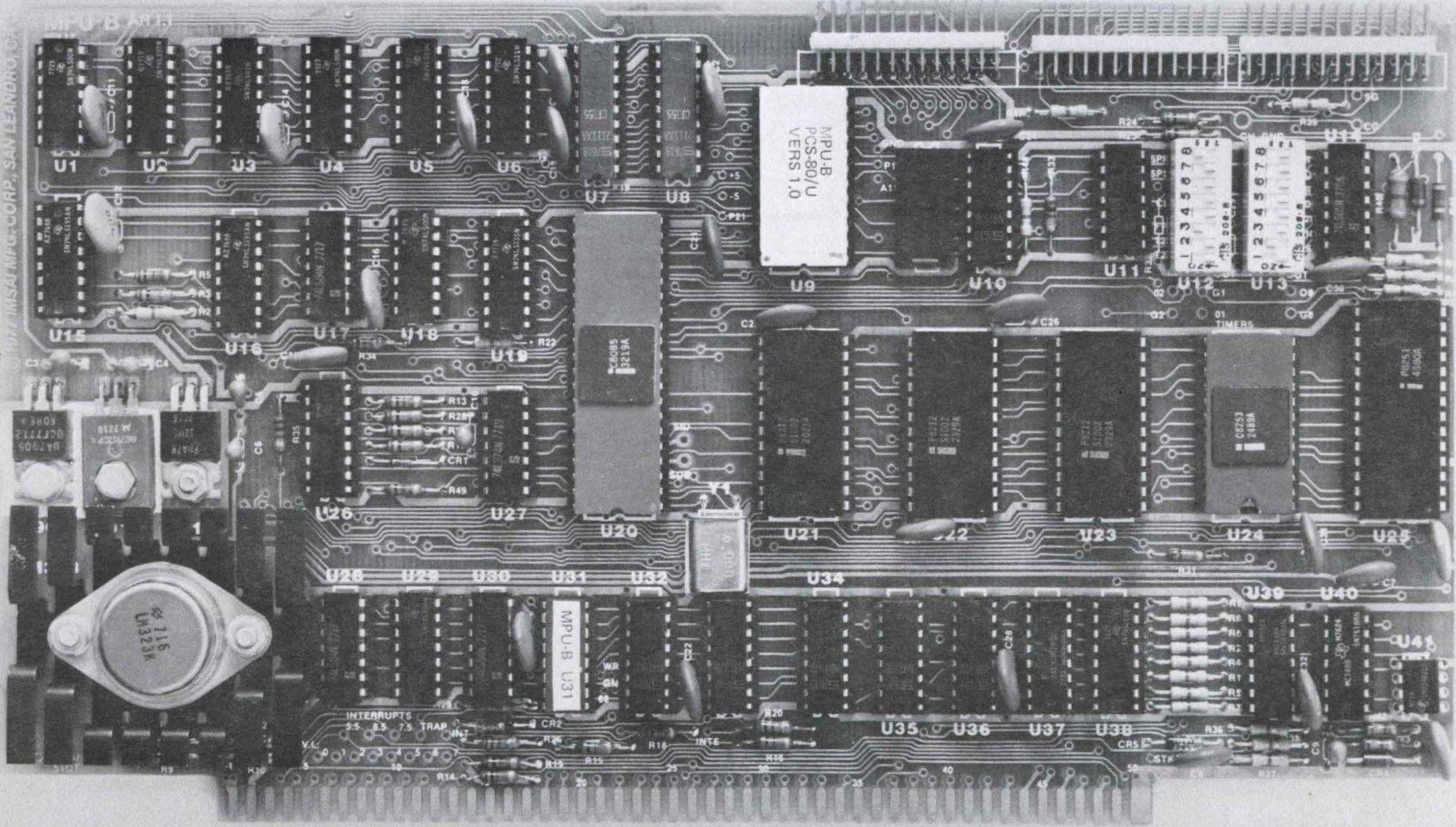

MPU-B AR13

MPU-B
PCS-80/U
VERS 1.0

MPU-B U31

716
U323K

INSAL MFG. CORP., SAN LEANDRO, CA

© 1977 IMSAI MFG. CORP., SAN LEANDRO, CA.

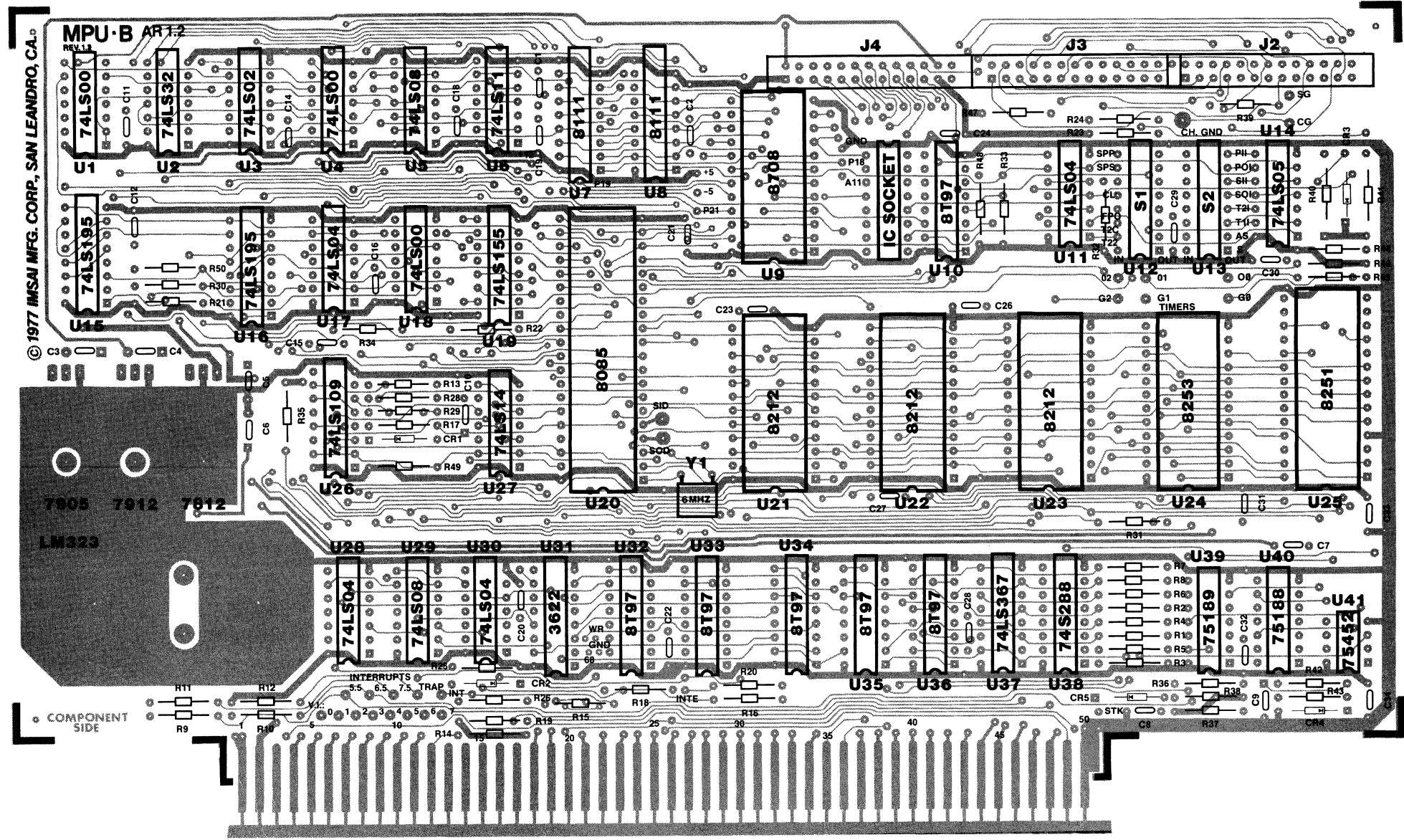

REVISIONS					
LTR	DESCRIPTION	DATE	APPROVED		
U1	74LS00	U39	75189		
U4		U40	75188		
U8		U41	75452		
U2	74LS32	C1, C2, C7, C8, C11, C12, C14, C15, C16, C18, C19, C20, C21, C22, C23, C24, C27, C28, C29, C30, C31 C32, C33, C34	.1 uF		
U3	74LS02				
U5	74LS08			C3, C6, C9, C10	2.2 uF
U29					
U6	74LS11	CR1	IN4148		
U7	8111A-4	CR2	IN270		
U8		CR5			
U9	FIRMWARE PROM SOCKET	CR3	IN4002		
		CR4			
U10	8T97	Y1	6MHZ		
U32-U36					
U11	74LS04	R9 - R16	1K ¼w		
U17		R18 - R20			
U28		R25, R26			
U30		R33 - R35			
		R50			
U12	S1	R17, R23, R24	10K ¼w		
U13	S2	R28 - R32, R38			
U14	74LS05	R1 - R8, R21, R22	4.7 ¼w		
U15	74LS195	R36, R37, R39			
U16		R44 - R48			
U19	74LS155	R40	750 ¼w		
U20	8085	R41	620 ¼w		
U21-U23	8212	R42	150 ¼w		
U24	8253-2	R43			
U25	8251A				
U26	74LS109				
U27	74LS74				
U31	3622				
U37	74LS367				
U38	74S288				

TOLERANCES UNLESS OTHERWISE SPECIFIED		MPU-B REV. 1.2 ASSEMBLY DIAGRAM		
FRACTIONS	DEC.			ANGLES
±	±			±
APPROVALS	DATE			
DRAWN				
CHECKED		SCALE	SIZE B	
		DRAWING NO.		
DO NOT SCALE DRAWING			SHEET	

MPU-B PARTS LIST

ITEM	IMSAI PART #	QUAN	DESCRIPTION
Solder	15-0000001	5'	
Heat Sink	16-0100008	1	Thermalloy 6060 B, -TO-3
Screw	20-3402001	3	6-32x3/8" Phillips Pan Head Machine
Screw	20-3701003	2	6-32x3/8" Round Head Nylon
Nut	20-3120001	5	6-32 Hex
Washer	21-3300001	2	#6 Mica, Pre-greased
Lockwasher	21-3350001	5	#6 Internal Star Lockwasher
Wire	22-0030001	2'	30 GA, Blue, Kynor
Header	23-0400022	3	26 Pin Right Angle
Socket	23-0800001	2	16 Pin Solder Tail DIP
Socket	23-0800002	2	24 Pin Solder Tail DIP
Socket	23-0800003	1	28 Pin Solder Tail DIP
Socket	23-0800004	1	40 Pin Solder Tail DIP
Socket	23-0900007	1	Cambion Pin
Switch	26-1200002	2	8 Position DIP
Foam Tape	28-0600003	1	1/2x1/2x1/16 Double Side Sticky
Resistor	30-3150362	2	150 Ohm, 1/4 W, 5% (br, gr, br)
Resistor	30-3620462	1	620 Ohm, 1/2 W, 5% (bl, r, br)
Resistor	30-3750462	1	750 Ohm, 1/2 W, 5% (v, gr, br)
Resistor	30-4100362	18	1K Ohm, 1/4 W, 5% (br, bl, r)
Resistor	30-4470362	19	4.7K Ohm, 1/4 W, 5% (y, v, r)
Resistor	30-5100362	8	10K Ohm, 1/4 W, 5%, br, bl, o)
Capacitor	32-2010010	24	.1uF Disk Ceramic

IMSAI PCS-80/15
SECTION III-B
MPU-B ASSEMBLY

ITEM	IMSAI PART #	QUAN	DESCRIPTION
Capacitor	32-2122070	6	2.2 uF, 25V Tantalum
Diode	35-1000007	2	1N4002
Diode	35-1000012	1	1N4148
Diode	35-1000013	2	1N270, Germanium
Crystal	35-5000005	1	6 MHz, Series Resonant, .02%, HC-18 Case
Regulator	36-0032301	1	LM323K (Alt: 78H05KC)
8T97	36-0089701	6	IC, Hex 3-State Driver
74LS00	36-0740002	3	IC, Quad 2 Input NAND (Low Power Schottky)
74LS02	36-0740202	1	IC, Quad 2 Input NOR (LPS)
74LS04	36-0740402	4	IC, Hex Inverter (LPS)
74LS05	36-0740502	1	IC, Hex Inverter, Open Collector (LPS)
74LS08	36-0740802	2	IC, Quad 2 Input AND (LPS)
74LS11	36-0741102	1	IC, Triple 3 Input AND (LPS)
74LS32	36-0743202	1	IC, Quad 2 Input OR (LPS)
74LS74	36-0747402	1	IC, Dual D Flip Flop (LPS)
7812	36-0781201	1	IC, +12 V Regulator
7905	36-0790501	1	IC, -5V Regulator
7912	36-0791201	1	IC, -12V Regulator
8085	36-0808501	1	IC, Microprocessor Chip
8111A-4	36-0811101	1	IC, 256x4 RAM (Alt: 2111A-4)
8212	36-0821201	3	IC, 8 Bit Latch
8251A	36-0825101	1	IC, USART (Alt: 8251)
8253-5	36-0825301	1	IC, Timer chip
74LS109	36-7410902	1	IC, Dual JK Flip Flop (LPS)

IMSAI PCS-80/15
SECTION III-B
MPU-B ASSEMBLY

ITEM	IMSAI PART #	QUAN	DESCRIPTION
74LS155	36-7415502	1	IC, Dual 2 to 4 Decoder (LPS)
74LS195	36-7419502	2	IC, 4 Bit Shift Register (LPS)
74LS367	36-7436702	1	IC, Hex 3-State Buffer (LPS)
75188	36-7518801	1	IC, Quad RS232 Driver
75189	36-7518901	1	IC, Quad RS232 Receiver
75452	36-7545201	1	IC, Dual Open Collector Driver
PROM	88-0000042	1	IC, 74S288 IC Prog. "MBSTDEC"
PROM	88-0000043	1	IC, 3622 (Alt: 7622) Prog. "MBADDDEC"
PC Board	92-0000057	1	MPU-B

MPU-B ASSEMBLY ERRATA

The following change turns off the data output line drivers except during writes and outputs. This reduces bus noise and therefore improves bus noise margins.

The modification consists of two parts:

- 1) Two traces on the component side of the board must be cut before any components are mounted on the board. The two traces are shown in Figure 1 and connect to pins 8 and 9 of U11 (74LS04). Cut each trace with a sharp tool such as an Exacta knife. Remove at least 1/16 of an inch of each trace. This may be done easily by making two cuts across the trace and removing the trace between the two cuts.
- 2) Four (4) blue wire jumpers must be installed on the solder side of the board. This is best done after the rest of the board assembly is complete. The locations of these jumpers are shown in Figure 2. Strip about 1/16 of an inch of insulation off of each end of a piece of blue jumper wire that is long enough to reach between two of the pads that are to be connected. Tin each end of the wire with a little solder before soldering each end to one of the two pads being connected. Repeat this procedure for the other three jumpers.

The drawing below illustrates the corrections to be made to the schematic.

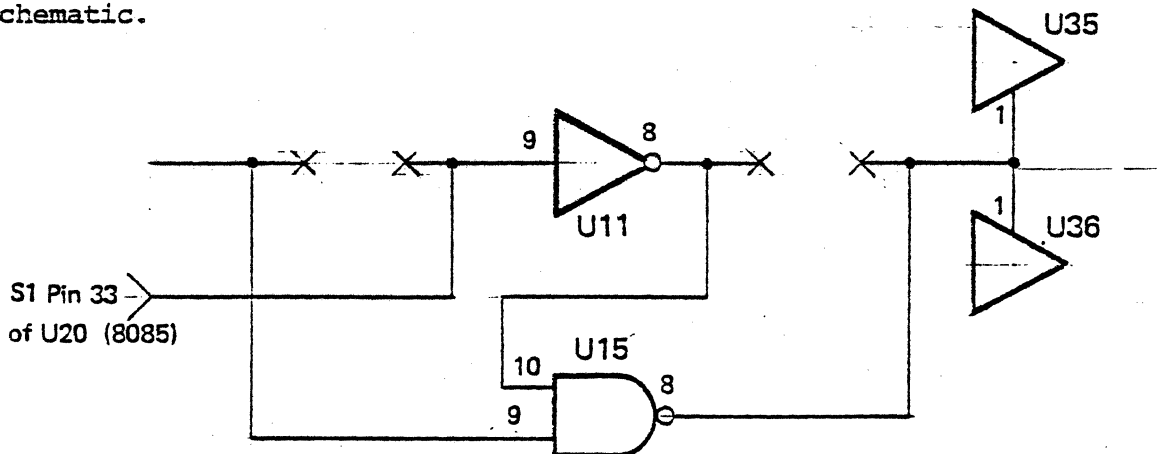

If you have purchased a PCS-80/30, the above changes are to be made in addition to the jumpering instructions required for the 2708 IC at location U9. Refer to the PROM Installation instructions in the PCS-80/30 Reference Manual, page II-55, to make the necessary trace cuts and jumpers.

NOTE: Figure II-4 shows the CIRCUIT SIDE of the board.

© 1977 INSA MFG. CORP., SAN LEANDRO, CA.

CUT TWO TRACES

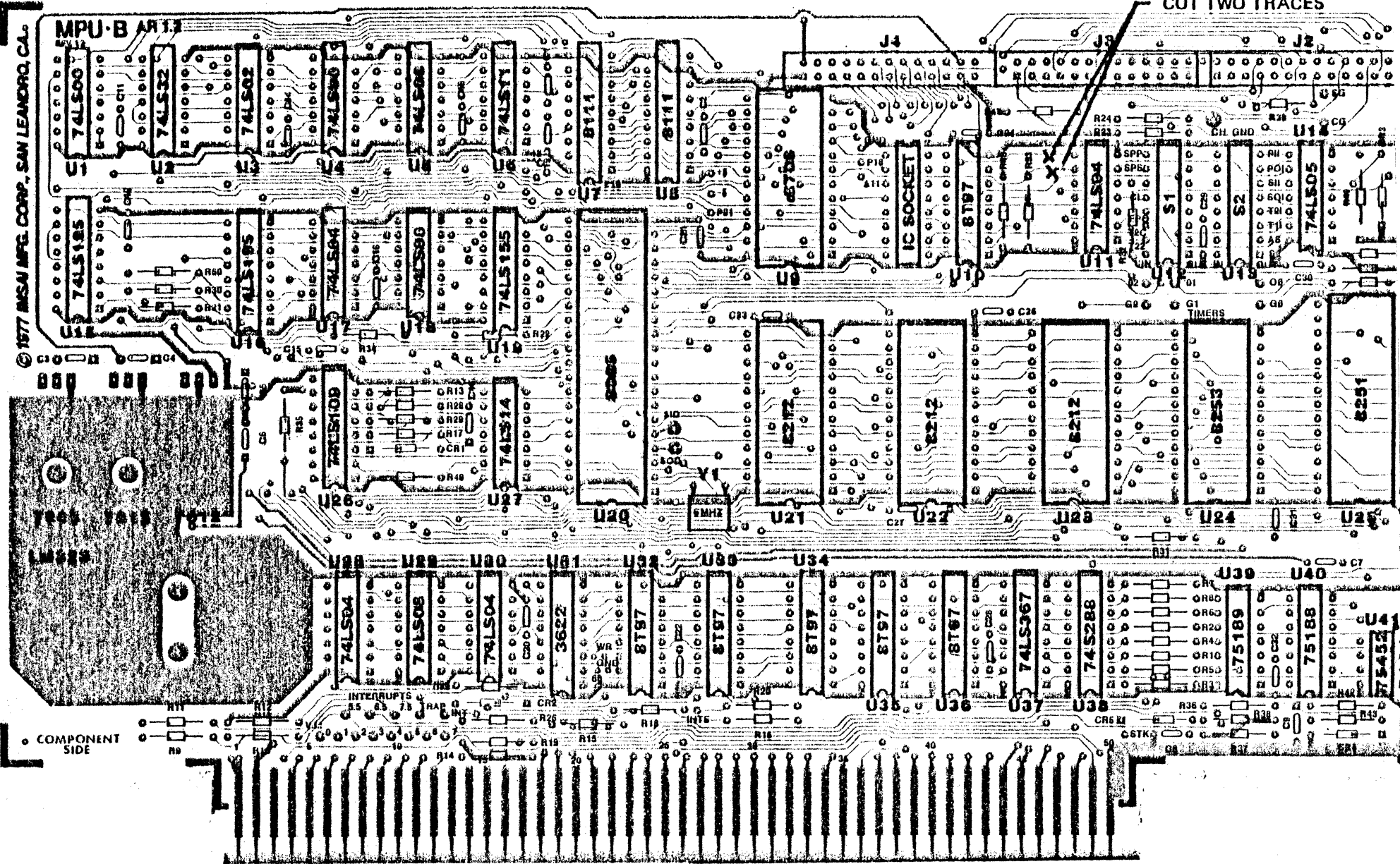
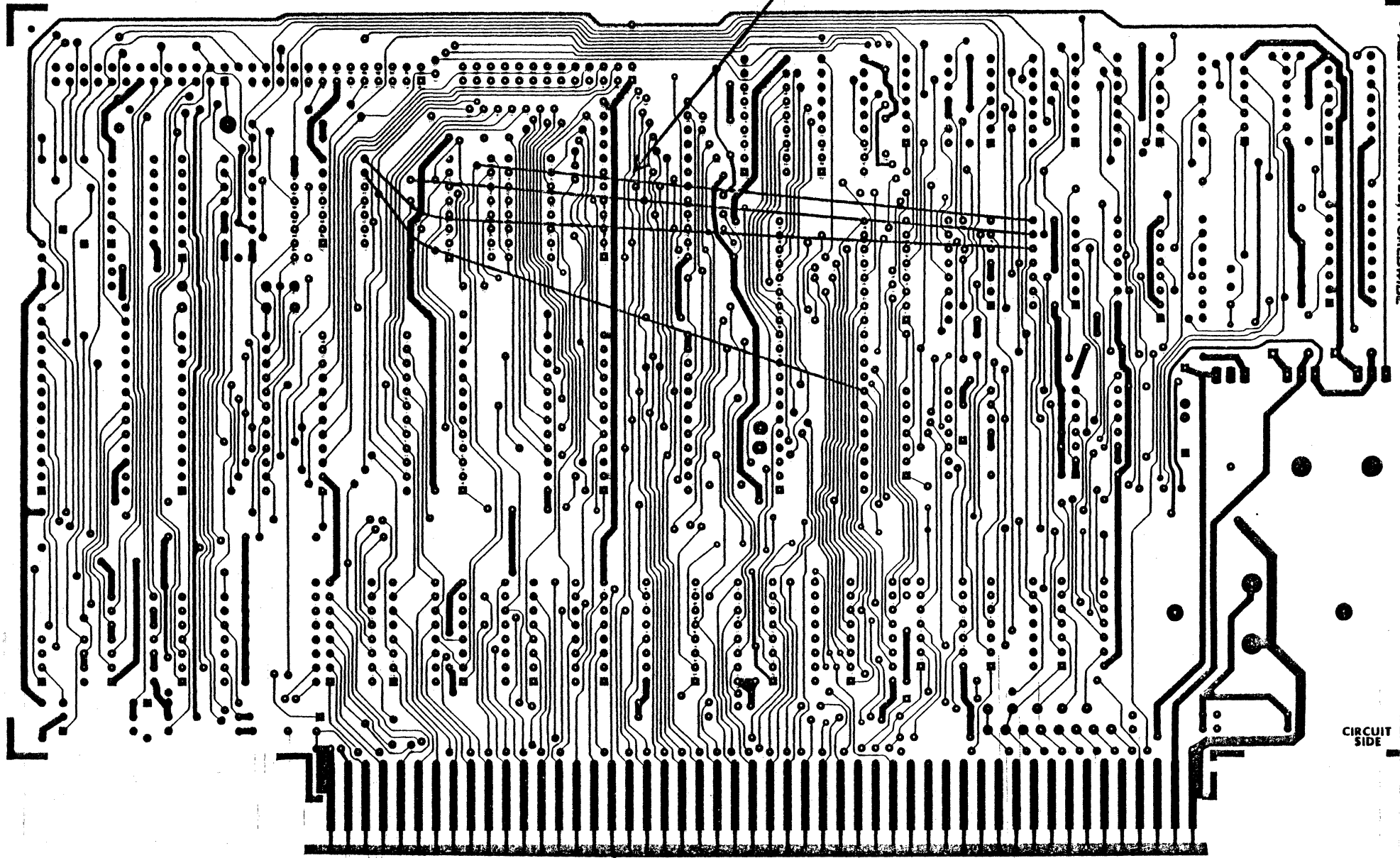

FIGURE 1

FOUR BLUE WIRE JUMPERS



• ALL RIGHTS RESERVED, WORLDWIDE

CIRCUIT
SIDE

FIGURE 2

B. MPU-B ASSEMBLY

() 1. Carefully unpack your board and check all parts against the parts list shown at the beginning of this instruction set. Do not discard any of the packing materials until all of the parts are accounted for. In case of any discrepancies, contact IMSAI Customer Service.

() 2. The MPU-B circuit board has a gold-plated edge connector to insure good contact with the motherboard. Carefully inspect this edge connector (on both sides of the board) for any signs of tarnishing or contamination. If you notice any tarnishing, carefully polish the edge connector using a normal pencil eraser.

CAUTION: NEVER polish the gold-plated connector with anything other than an eraser, as it is very susceptible to damage. The gold is critical to reliable system operation — never cover it with solder or scratch it.

() 3. Position the MPU-B circuit board on your work surface with the side labeled "component side" facing up. The gold-plated edge connector should be facing towards you.

NOTE: Refer to the photographs at the end of Section II in order to identify components with which you may be unfamiliar.

CAPACITOR AND RESISTOR INSTALLATION

In the following steps you will be instructed to "install" a particular part. In this context, to install means to "insert the part into the circuit board and bend the leads back". You will be instructed when to solder the components.

IMSAI PCS-80/15
SECTION III-B
MPU-B ASSEMBLY

- () 4. Install a .1 uf ceramic capacitor at C14.
- () 5. Install a .1 uf ceramic capacitor at C11.
- () 6. Install a .1 uf ceramic capacitor at C12.
- () 7. Install a 1K ohm 1/4 watt resistor (brown-black-red) at R50.
- () 8. Install a 10K ohm 1/4 watt resistor (brown-black-orange) at R30.
- () 9. Solder all components to the board and cut off excess lead lengths.
- () 10. Install a 4700 ohm, 1/4 watt resistor (yellow-violet-red) at R21.
- () 11. Install a 2.2 uf 25V tantalum capacitor at C4.
- () 12. Install a 2.2 uf 25V tantalum capacitor at C3.
- () 13. Install a 2.2 uf tantalum capacitor at C5.
- () 14. Install a 1K ohm, 1/4 watt resistor (brown-black-red) at R35.
- () 15. Solder all components and cut off excess leads.
- () 16. Install a 2.2 uf tantalum capacitor at C6.
- () 17. Install a 1K ohm, 1/4 watt resistor (brown-black-red) at R12.
- () 18. Install a 1K ohm, 1/4 watt resistor (brown-black-red) at R11.
- () 19. Install a 1K ohm, 1/4 watt resistor (brown-black-red) at R9.
- () 20. Install a 1K ohm, 1/4 watt resistor (brown-black-red) at R10.
- () 21. Solder all leads and cut off excess lengths.

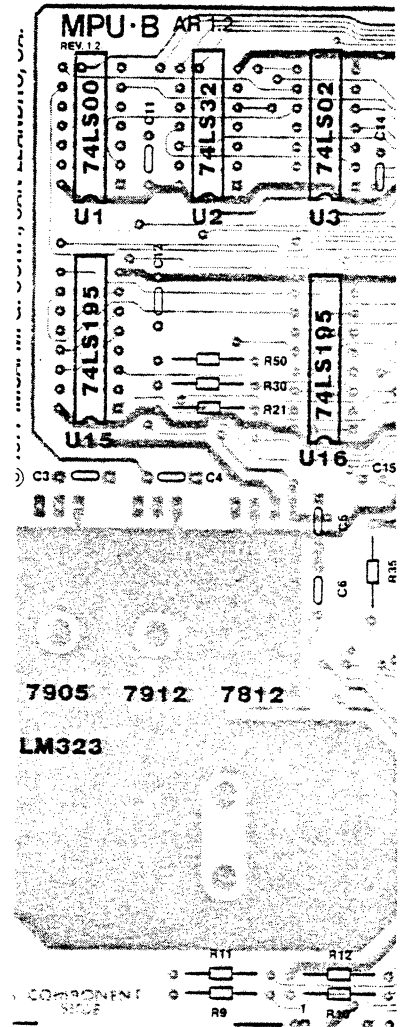

- () 22. Install a .1 uf ceramic capacitor at C18.
- () 23. Install a .1 uf ceramic capacitor at C16.
- () 24. Install a .1 uf ceramic capacitor at C15.
- () 25. Install a 1K ohm, 1/4 watt resistor (brown-black-red) at R34.
- () 26. Install a 4700 ohm, 1/4 watt resistor (yellow-violet-red) at R22.
- () 27. Solder all leads and cut off excess lengths.
- () 28. Install a 1K ohm, 1/4 watt resistor (brown-black-red) at R13.
- () 29. Install a 10K ohm, 1/4 watt resistor (brown-black-orange) at R28.
- () 30. Install a 2.2 uf 25V tantalum capacitor at C10.
- () 31. Install a 10K ohm, 1/4 watt resistor (brown-black-orange) at R29.
- () 32. Install a 10K ohm, 1/4 watt resistor (brown-black-orange) at R17.
- () 33. Install a 1K ohm, 1/4 watt resistor (brown-black-red) at R49.
- () 34. Solder all leads and cut off excess lengths.
- () 35. Install a .1 uf ceramic capacitor at C20.
- () 36. Install a 1K ohm, 1/4 watt resistor (brown-black-red) at R25.
- () 37. Install a 1K ohm, 1/4 watt resistor (brown-black-red) at R26.

Note: Diode CR2 will be installed later; take care not to install a resistor in its position.

- () 38. Install a 1K ohm, 1/4 watt resistor (brown-black-red) at R19.
- () 39. Install a 1K ohm, 1/4 watt resistor (brown-black-red) at R14.

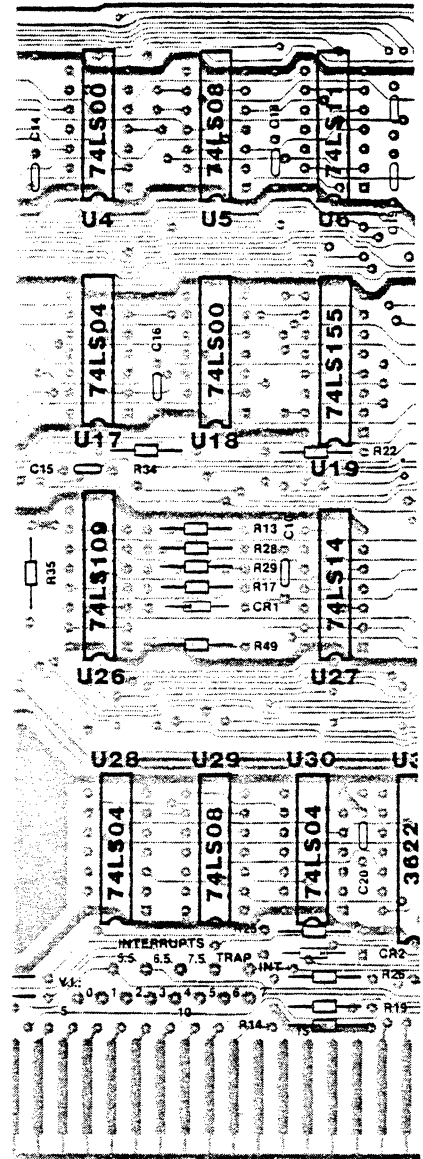

IMSA1 PCS-80/15
SECTION III-B
MPU-B ASSEMBLY

() 40. Solder all components and cut off excess lead lengths.

() 41. Locate five (5) .1 uf ceramic capacitors and install them in the following locations:

() C2
() C1
() C19

() C21
() C23

() 42. Solder all leads and cut off excess lengths.

() 43. Install a 1K ohm, 1/4 watt resistor (brown-black-red) at R20.

() 44. Install a 1K ohm, 1/4 watt resistor (brown-black-red) at R16.

() 45. Install a .1 uf ceramic capacitor at C22.

() 46. Install a 1K ohm, 1/4 watt resistor (brown-black-red) at R18.

() 47. Install a .1K ohm, 1/4 watt resistor (brown-black-red) at R15.

() 48. Solder all components and cut off excess lead lengths.

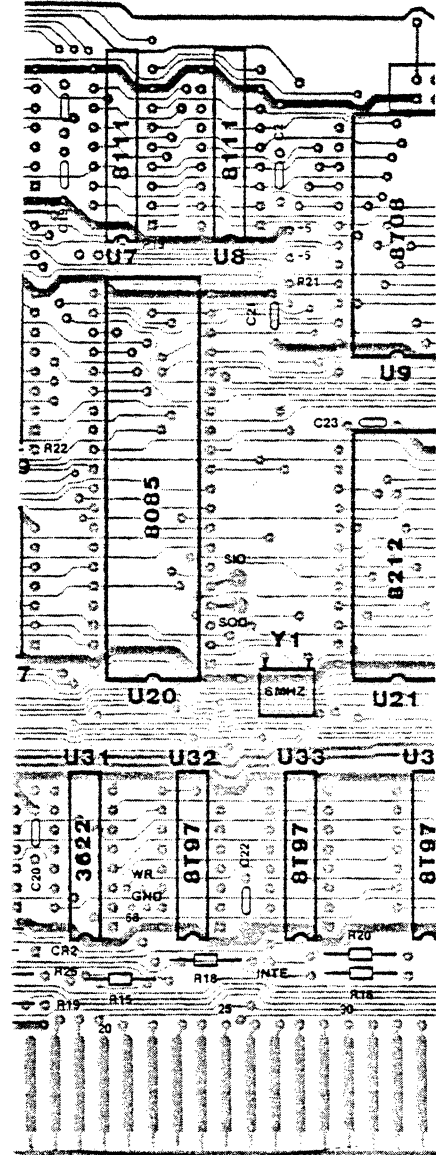

() 49. Install a 4700 ohm, 1/4 watt resistor (yellow-violet-red) at R47.

() 50. Install a .1 uf ceramic capacitor at C24.

() 51. Install a 1K ohm, 1/4 watt resistor (brown-black-red) at R33.

() 52. Install a 4700 ohm, 1/4 watt resistor (yellow-violet-red) at R48.

() 53. Install a .1 uf ceramic capacitor at C26.

() 54. Install a .1 uf ceramic capacitor at C27.

() 55. Install a .1 uf ceramic capacitor at C28.

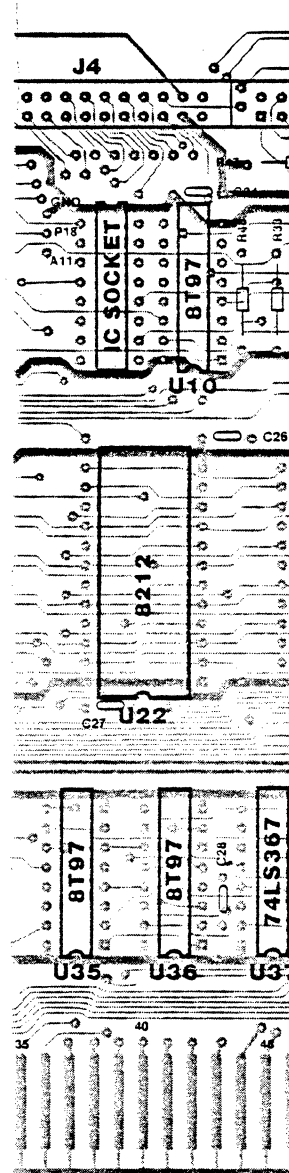

IMSAI PCS-80/15
SECTION III-B
MPU-B ASSEMBLY

- () 56. Install a 620 ohm, 1/2 watt resistor (blue-red-brown) at R41.
- () 57. Install a 750 ohm, 1/2 watt resistor (violet-green-brown) at R40.
- () 58. Install a 4700 ohm, 1/4 watt resistor (yellow-violet-red) at R39.
- () 59. Install a 10K ohm, 1/4 watt resistor (brown-black-orange) at R24.
- () 60. Install a 10K ohm, 1/4 watt resistor (brown-black-orange) at R23.
- () 61. Install a 10K ohm, 1/4 watt resistor (brown-black-orange) at R32.
- () 62. Install a .1 uf ceramic capacitor at C30.
- () 63. Solder all components and cut off excess lead lengths.
- () 64. Locate three (3) 4700 ohm, 1/4 watt resistors (yellow-violet-red) and install them at the following locations:

- () R44
- () R46
- () R45

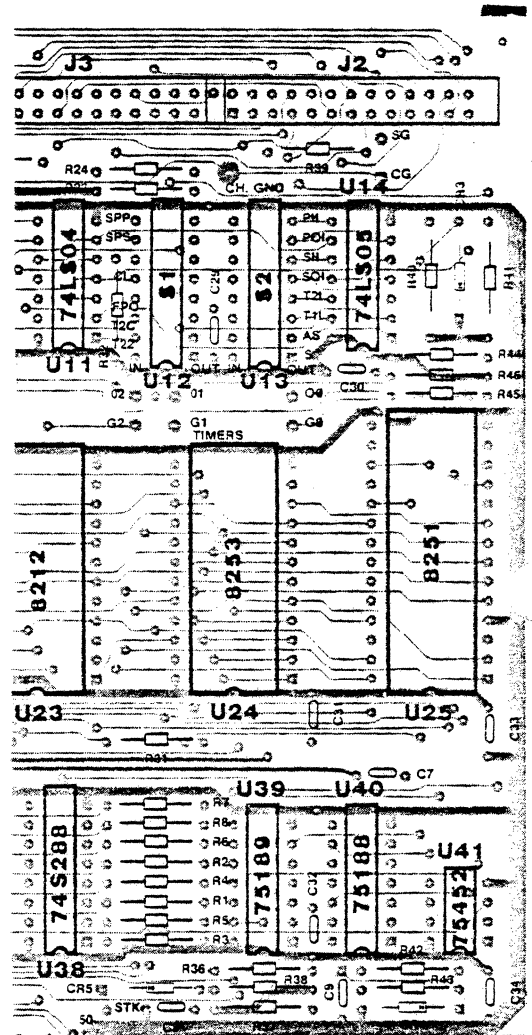

- () 65. Install a 10K ohm, 1/4 watt resistor (brown-black-orange) at R31.
- () 66. Install a .1 uf ceramic capacitor at C31.
- () 67. Solder all components and cut off excess lead lengths.
- () 68. Locate eight (8) 4700 ohm, 1/4 watt resistors (yellow-violet-red) and install them at the following locations:

- | | |
|--------|--------|
| () R7 | () R8 |
| () R6 | () R2 |
| () R4 | () R1 |
| () R5 | () R3 |

- () 69. Solder all components and cut off excess lead lengths.
- () 70. Install a .1 uf ceramic capacitor at C32.
- () 71. Install a .1 uf ceramic capacitor at C8.
- () 72. Locate three (3) 4700 ohm, 1/4 watt resistors (yellow-violet-red) and install them at the following locations:

- | | |
|---------|---------|
| () R36 | () R38 |
| () R37 | |

- () 73. Install a 2.2 uf 25V tantalum capacitor at C9.
- () 74. Install a 150 ohm, 1/4 watt resistor (brown-green-brown) at R42.
- () 75. Install a 150 ohm, 1/4 watt resistor (brown-green-brown) at R43.
- () 76. Install a .1 uf ceramic capacitor at C34.
- () 77. Solder all components and cut off excess lead lengths.

This completes the installation of the resistors and capacitors on the MPU-B board. We recommend that you go back and check your work carefully. Inspect all solder joints and check for any solder splashes and solder bridges. When you are satisfied that there are no errors, proceed with regulator installation.

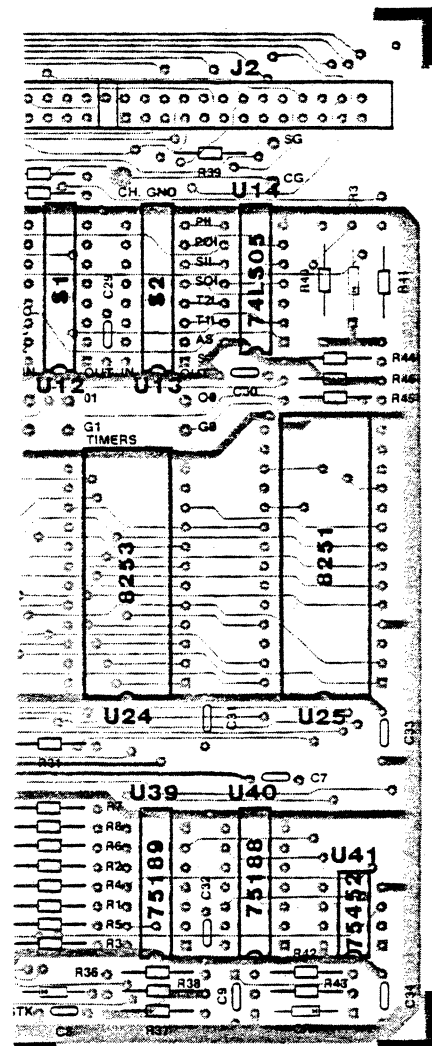

INSTALLATION OF REGULATORS, DIODES AND CONNECTORS

REGULATORS

- () 78. Locate the 7905 regulator. Make a 90 degree bend on all three leads 1/8 inch from the regulator body. See Section II, Figure II-3 for detail.
- () 79. Mount the 7905 regulator to the PC board using a 6x32 NYLON screw, a mica insulator, 6x32 lockwasher and nut. Place the mica insulator between the PC board and the regulator. Insert the nylon screw from the back of the board, through the board, through the mica insulator, then through the regulator body. Secure with a #6 lockwasher and 6-32 nut. Tighten the screw snugly, taking care not to overtighten.

CAUTION: This regulator must be insulated from the PC board or severe damage may result. Be sure to install the mica insulator correctly.

- () 80. Locate the 7912 regulator and bend the leads as described in Step 78.
- () 81. Mount the 7912 regulator on the PC board as described in Step 79. Again, we caution you to install the insulator correctly.

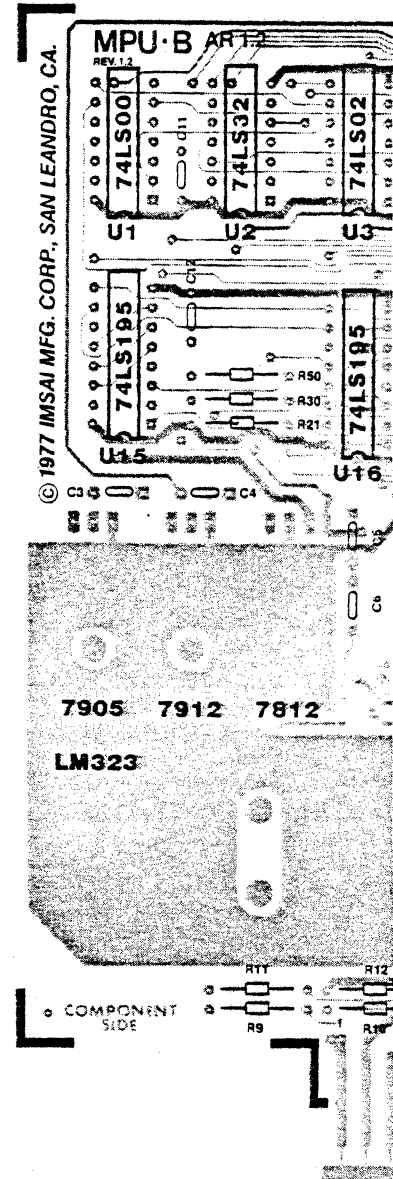

IMSAI PCS-80/15
SECTION III-B
MPU-B ASSEMBLY

- () 82. Locate the 7812 regulator and bend the leads as as described in Step 78.
- () 83. Install the 7812 regulator on the board using a 6x32 machine screw, lockwasher and nut. Note that this regulator is not insulated from the board.
- () 84. Locate the heatsink and position it on the PC board over the area denoted as "LM323". Position the heatsink such that the side with the two holes is facing towards the RIGHT (that is, towards U28). The holes in the heatsink should line up with the holes in the PC board underneath. If the holes do not align, position the heat sink until they do.
- () 85. Locate the LM323 regulator. Note that this regulator does not resemble the three regulators installed above.
- () 86. Install the LM323 onto the heatsink using two 6x32 3/8 screws. Insert the screws from the bottom of the PC board and secure each of them with one lockwasher and 6-32 nut. Tighten these nuts securely (to maximize the efficiency of the heat sink), taking care not to overtighten.

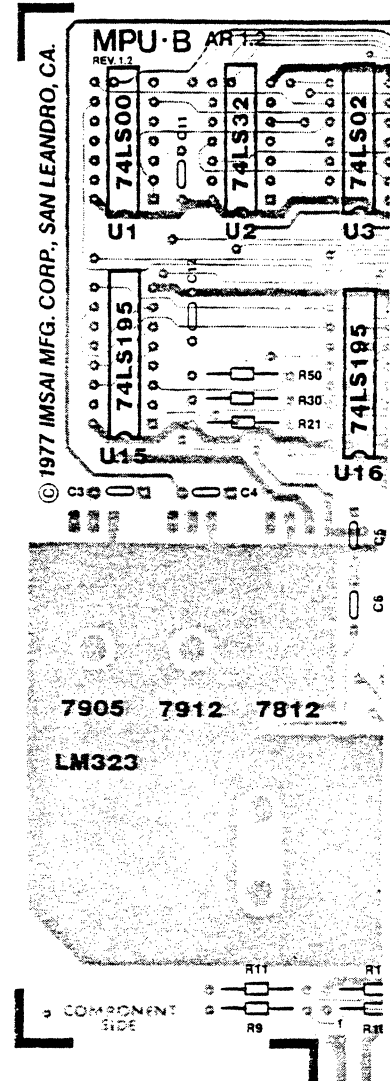

- () 87. Locate the three (3) 26 pin connectors. Note that there is a right-angle bend on one side of the white plastic. Orient the side without the bend towards the top of the board (away from the edge connector) when inserting the connector into the PC board.
- () 88. Insert one of the 26 pin connectors into J4. Press the connector tightly against the board and solder one pin at each end. This will hold the connector in place.
- () 89. Install another 26 pin connector at J3 as described in Step 88.
- () 90. Install the third 26 pin connector at J2.
- () 91. Carefully check all three connectors to ensure that they are seated properly on the PC board, and that the pins are parallel to the board. When you are satisfied that they are installed correctly, solder all of the pins (72) to the board. Solder carefully: the pins are close together and a solder bridge can form easily.

DIODES

- () 92. Locate and install a 1N4002 diode at CR3. Be sure to observe correct diode polarity.
- () 93. Install a 1N270 diode at CR5, once again observing correct polarity.
- () 94. Install a 1N4002 diode at CR4. Observe the correct polarity.

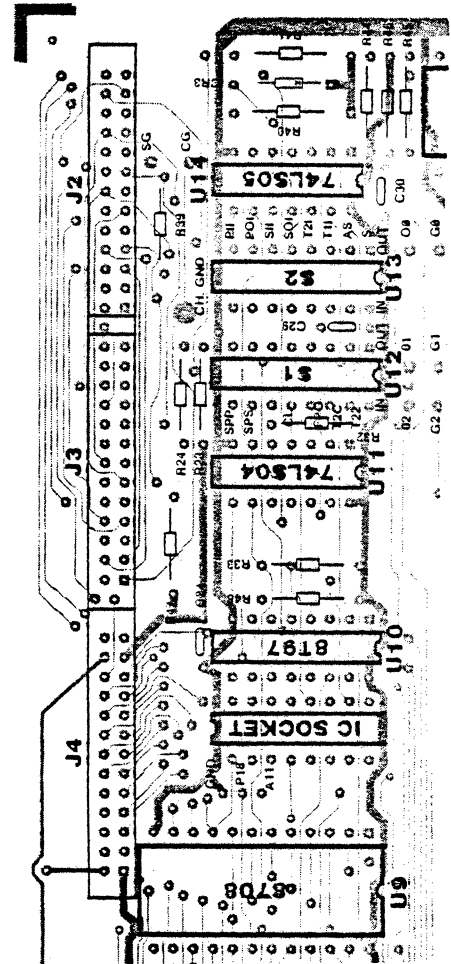

INSTALLATION OF INTEGRATED CIRCUITS

The MPU-B contains many expensive IC's and great care must be taken in their installation. If you have not already done so, please read the "General Assembly Instructions" regarding IC's, and, in addition, observe the following precautions:

REMOVAL OF IC'S

If you install an IC in the wrong position, be extremely careful about removing it. Cut all of the leads near the body of the IC; the plastic body should fall off leaving the pins soldered in the holes. Carefully remove each pin with a soldering iron and a solder-removing device ("solder sucker"). Should you need to remove an IC during construction, we recommend that the PC board be returned to IMSAI Customer Service for IC removal.

SOCKETS

Included in your kit are sockets for the 8085, 8708, 8253, 8251 and the front panel connector. You may order sockets for all of the other IC's on the board. Socket use simplifies IC maintenance and replacement but may decrease system reliability in a harsh environment.

If you use sockets, install a socket at the specified location when an instruction calls for IC installation. Take care to use the correct socket for a particular IC. Do not use a 16 pin IC socket for a 14 pin IC, or vice versa. The number of pins on a particular IC will be specified in the assembly instruction step (for instance, an 18-pin IC is called out as P18).

IC INSTALLATION

In the following steps you will be directed to "install" an integrated circuit at a specified location. In this context, "install" means:

- 1) Insert the IC into the PC board. Ensure that pin 1 on the IC is oriented towards the gold-plated edge connector.
- 2) Be sure that all pins are seated in the appropriate holes.
- 3) Solder pin 1 and the pin at the farthest corner from pin 1. This procedure is followed in order to hold the IC onto the board until the remaining pins are soldered.

You will be instructed when to solder the remaining pins.

IMSAI PCS-80/15
SECTION III-B
MPU-B ASSEMBLY

() 95. Install the specified IC's at the following locations:

- () 74LS00 at U1 (P14)
- () 74LS32 at U2 (P14)
- () 74LS02 at U3 (P14)
- () 74LS00 at U4 (P14)
- () 74LS08 at U5 (P14)
- () 74LS195 at U15 (P16)
- () 74LS195 at U16 (P16)

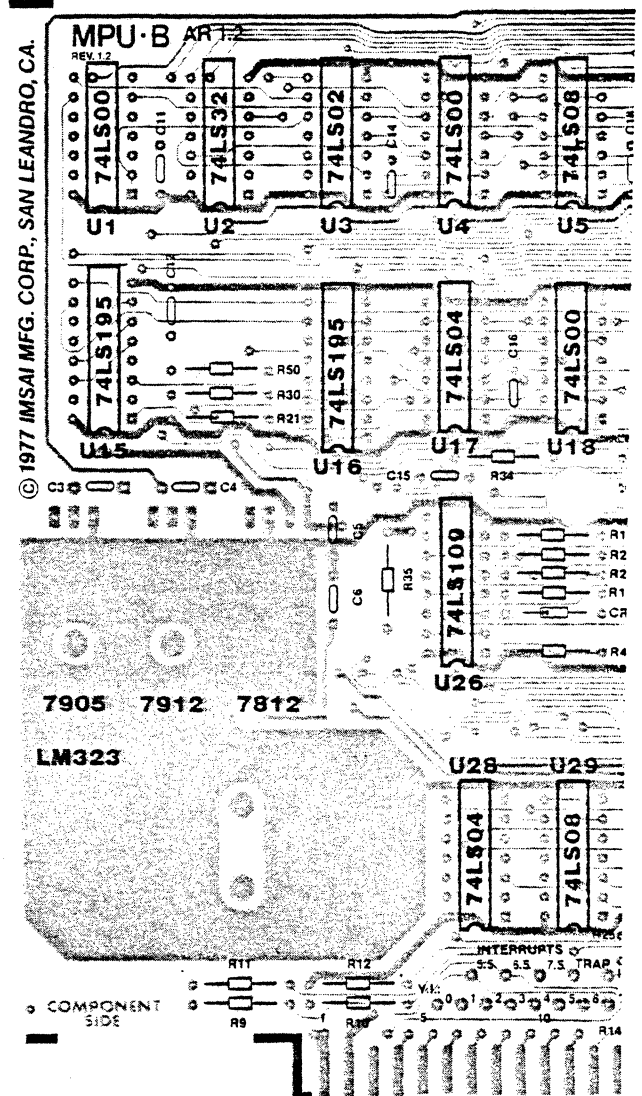

() 96. Install the specified IC's at the locations indicated:

() 74LS04 at U17 (P14)

() 74LS00 at U18 (P14)

() 74LS109 at U26 (P16)

() 74LS04 at U28 (P14)

() 74LS08 at U29 (P14)

See that you have installed the IC's correctly, but
DO NOT SOLDER all of the pins at this time.

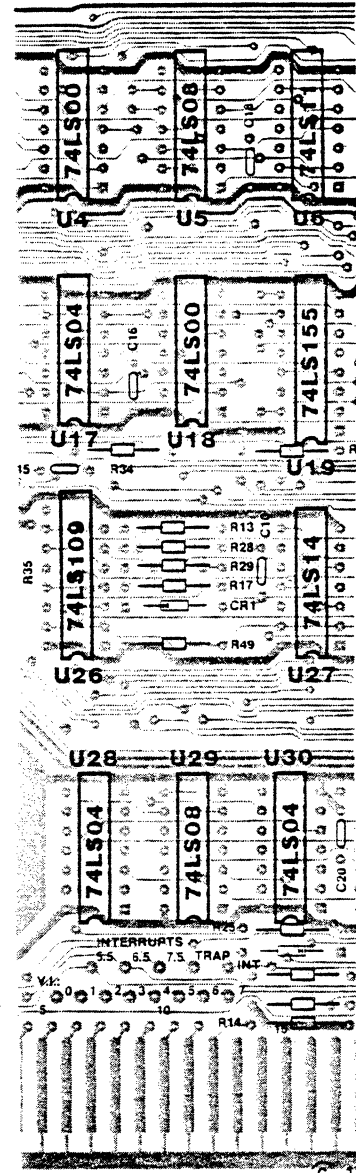

IMSAI PCS-80/15
SECTION III-B
MPU-B ASSEMBLY

() 97. Locate the two (2) 8111 memory chips; note that these are 18 pin IC's.

() 98. Install one 8111 at U8 (P18).

() 99. Install the other 8111 at U7 (P18).

() 100. Install the specified IC's at the locations indicated:

() 74LS11 at U6 (P14)

() 74LS155 at U19 (P16)

() 74LS14 at U27 (P14)

() 101. Locate the 40 pin IC socket and install at U20. Ensure that all of the pins are seated in the appropriate holes. Note that the 8085 chip will be installed later.

() 102. Install a 74LS04 at U30 (P14).

() 103. Install a 3622 at U31 (P16).

() 104. Install a 8T97 at U32 (P16).

Note: The 8097 and 8T97 are interchangeable.

() 105. Install a 8T97 at U33 (P16).

() 106. Inspect your work, checking to see that all IC's are installed in the proper locations.

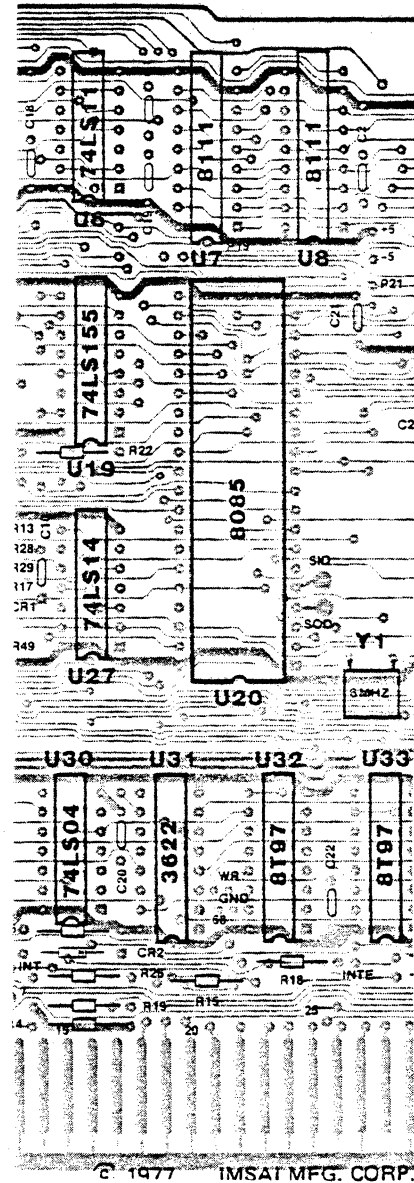

IMSAI PCS-80/15
SECTION III-B
MPU-B ASSEMBLY

() 107. Install a 24 pin IC socket at U9. (The 8708 or 2716 will be installed later).

() 108. Install a 16 pin IC socket between U9 and U10.

() 109. Install an 8T97 at U10 (P16).

() 110. Install an 8212 at U21 (P24).

() 111. Install an 8212 at U22 (P24).

() 112. Install an 8T97 (P16) at the locations indicated:

- () U34
- () U35
- () U36

() 113. Check to see that all IC's have been installed properly. Do NOT solder all of the pins at this time.

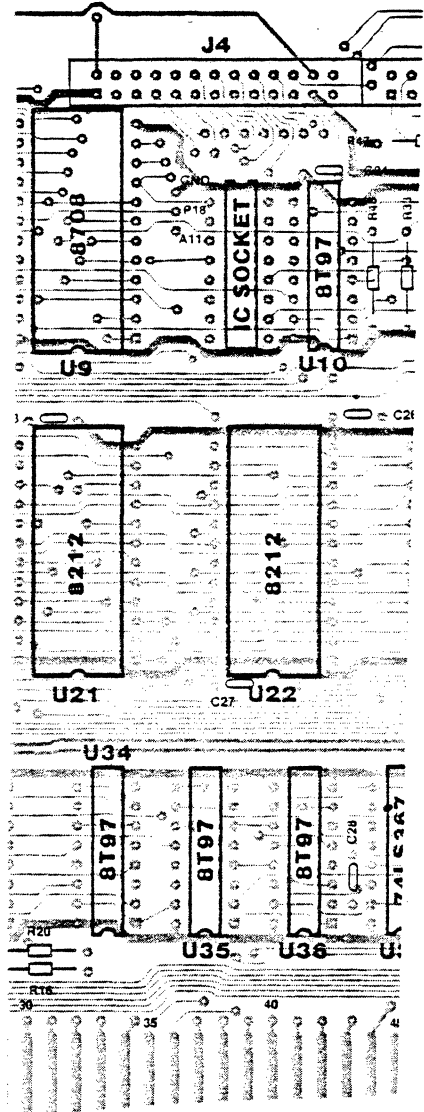

IMSAI PCS-80/15
SECTION III-B
MPU-B ASSEMBLY

- () 114. Install a 74LS05 at U14 (P14).
- () 115. Locate the two (2) eight-position DIP switches. The switches are numbered 1 through 8. Position switch 1 towards the gold-plated edge connector.
- () 116. Install an eight-position dip switch at S1.
- () 117. Install an eight-position dip switch at S2.
- () 118. Install a 74LS04 at U11 (P14).
- () 119. Install a 28 pin IC socket at U25. Do NOT insert an IC into the socket.
- () 120. Install a 24 pin IC socket at U24.
- () 121. Install an 8212 at U23 (P24).
- () 122. Install a 74LS367 at U37 (P16).
- () 123. Install a 74LS288 at U38 (P16).
- () 124. Install a 75189 at U39 (P14).
- () 125. Install a 75188 at U40 (P14).
- () 126. Install a 75452 at U41. Note that this is an eight (8) pin IC.

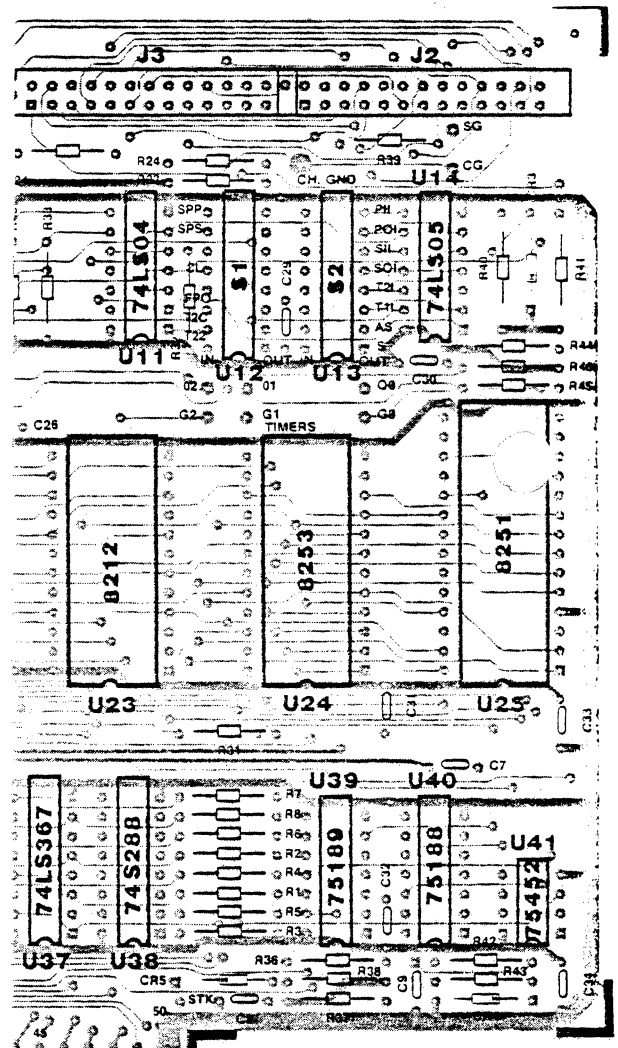

- () 127. Installation of the IC's is now complete. Check the board against the assembly diagram to ensure that each IC is installed in the correct location.
- () 128. When you are satisfied that all IC's are positioned correctly, solder ALL of the remaining pins.
- () 129. Attach the piece of foam tape to one side of the crystal.
- () 130. Bend the leads on the crystal 90 degrees to the crystal body, towards the tape.
- () 131. Remove the backing from the other side of the foam tape, and insert the crystal leads into the holes on the MPU-B circuit board at Y1. Gently press the crystal against the board. The tape should hold the crystal in place. Solder the crystal leads onto the board.
- () 132. THIS COMPLETES THE ASSEMBLY OF THE MPU-B. You should have the following IC's left unmounted: 8085, 8251, 8253, 8708 (or 2716).

Before continuing, carefully inspect BOTH sides of the MPU-B for solder splashes and bridges.

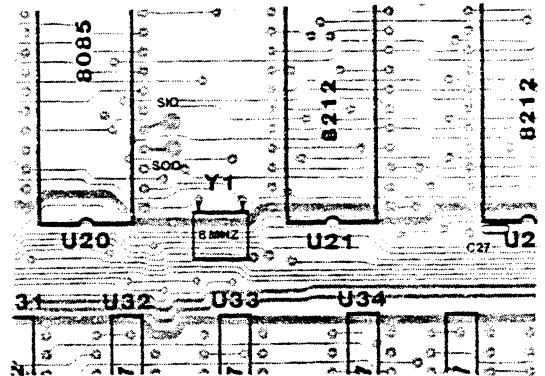

C. EXP-10 ASSEMBLY

EXP-10
ERRATA
ECO 77-0120
11/11/77

EXP-10 ASSEMBLY ERRATA

Before beginning assembly of the EXP-10, eight (8) traces must be cut. These traces connect terminator resistor arrays to lines 71 thru 74, 76 thru 78, and 99.

For locations, see the Figure to the left.

All cuts are made on the solder side of the board. Cut each trace with a sharp tool such as an Exacto knife. Remove at least 1/16 of an inch of each trace. This may be easily done by making two cuts across the trace and removing the trace between the two cuts.

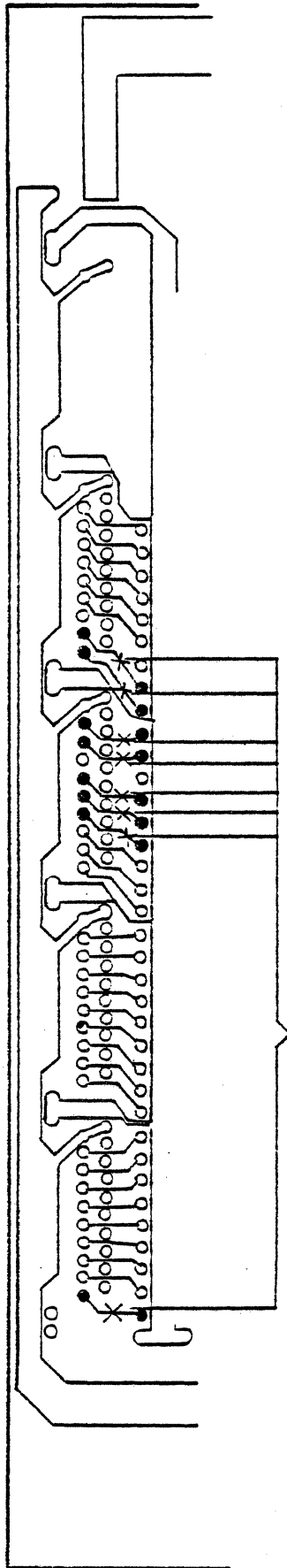

CUT EIGHT PLACES

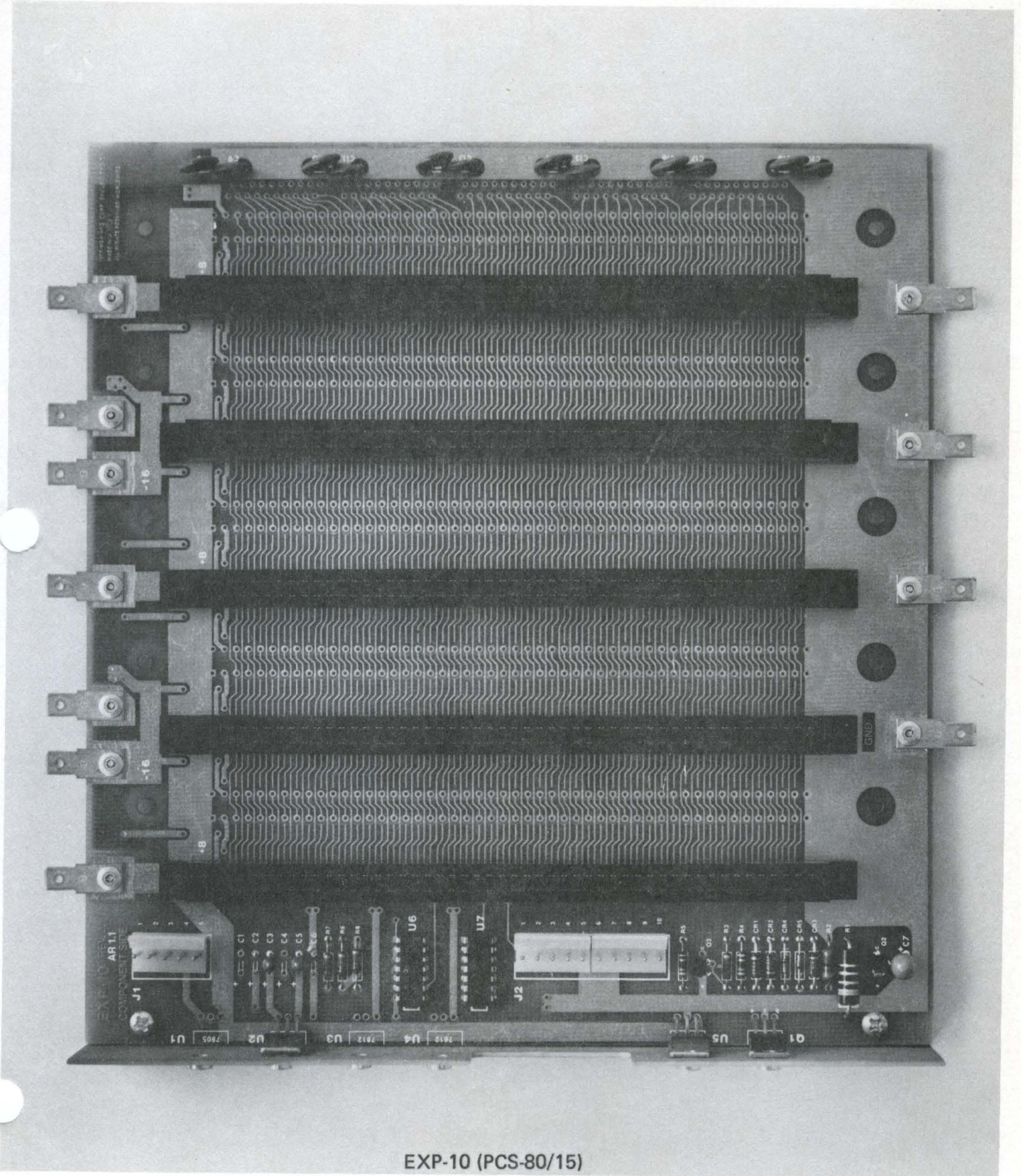

EXP-10 (PCS-80/15)

EXP-10 REV.2.2
AR 1.2

COMPONENT
SIDE

© 1977 IMSAI MFG. CORP., SAN LEANDRO, CA.
MADE IN U. S. A.
ALL RIGHTS RESERVED, WORLDWIDE

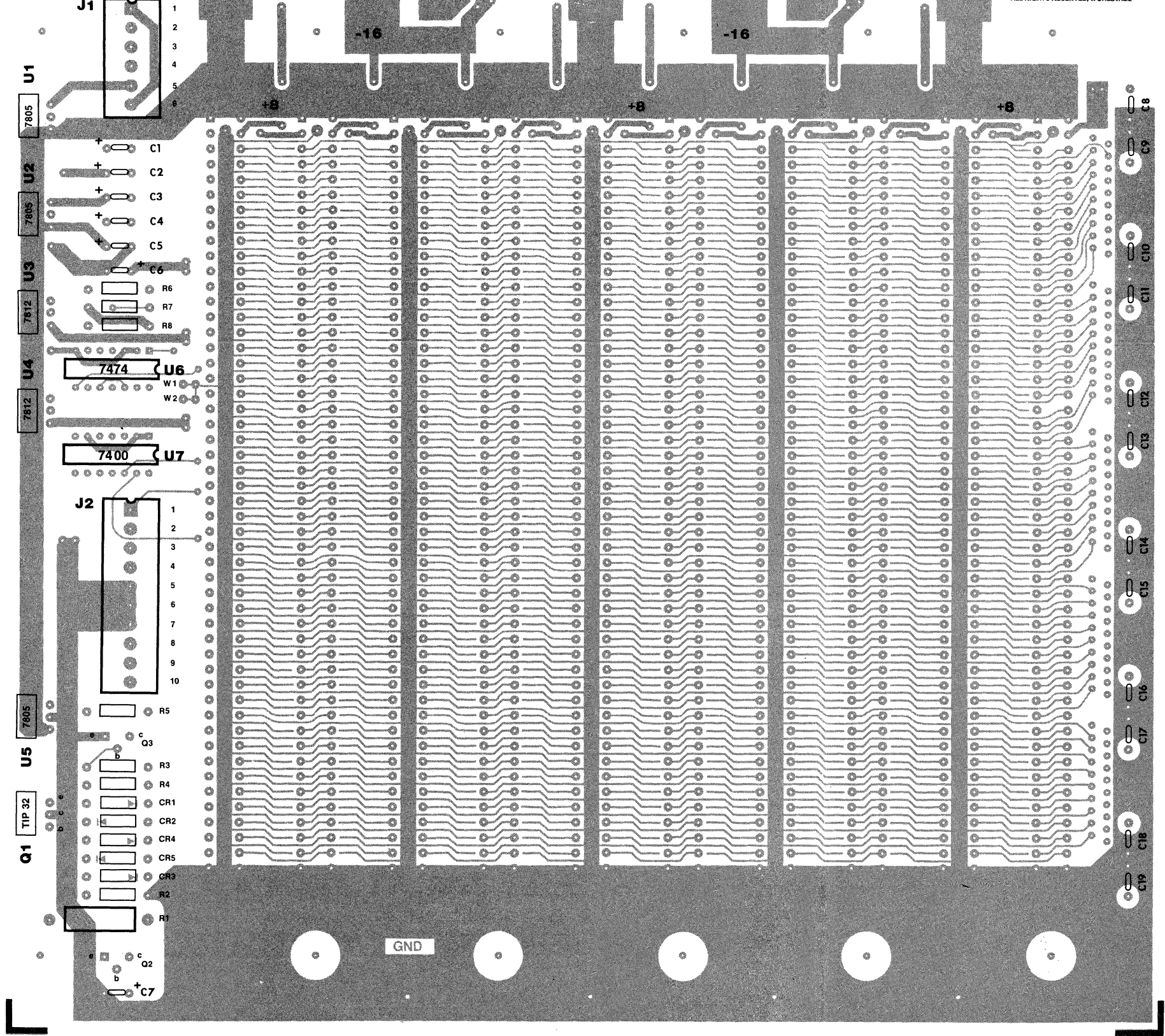

REVISIONS			
LTR	DESCRIPTION	DATE	APPROVED

U1	} 7805	Q1	TIP 32
U2 * SEE NOTE		Q2	2N3906
U3 *	} 7812	Q3	2N3904
U4		CR1	} 1N4002
U5 *	7805	CR2	
U6	7474	CR3	
U7	7400	CR4	} 1N914
C1 - C6 * SEE NOTE		CR5	

C1	} 2.2 uF	J1	6 PIN CONNECTOR
C2		J2	10 PIN CONNECTOR
C3		R1	.47 2W
C4		R2	82 ¼W
C5		R3	220 ¼W
C6		R4	} 47 ¼W
C7	33 uF	R5	
C8	} 0.1 uF	R6	} 2.2K ¼W
C10		R7	
C12		R8	
C14			
C16			
C18			

*NOTE:
FOR PCS 80/15: REGULATORS U2, U5 CAPS C3, C5
FOR PCS 80/30, 34:
REGULATORS U2, U3, U5 CAPS C2, C3, C5, C6
FOR PCS 80/35:
ALL REGULATORS AND 2.2 uF CAPACITORS

TOLERANCES UNLESS OTHERWISE SPECIFIED FRACTIONS DEC. ANGLES ± ± ±		c 1977 IMSAI MFG. CORP. SAN LEANDRO, CA. ALL RIGHTS RESERVED WORLDWIDE MADE IN U.S.A.	
APPROVALS	DATE	EXP 10 REV. 2.2 ASSEMBLY DIAGRAM PCS 80 SYSTEM	
DRAWN			
CHECKED		SCALE	SIZE B
		DRAWING NO.	
		DO NOT SCALE DRAWING	
		SHEET	

EXP-10 PARTS LIST

<u>ITEM</u>	<u>IMSAI PART #</u>	<u>QUANTITY</u>	<u>DESCRIPTION</u>
Solder	15-0000001	5'	
Screw	20-2402004	3	4-40x3/16" Nylon, Round Head, Slot
Screw	20-3202001	3	6-32x $\frac{1}{4}$ " Phillips Pan Head Machine CAD
Screw	20-3302001	2	6-32x5/16" Phillips Pan Head Machine CAD
Screw	20-3702001	10	6-32x3/4" Phillips Pan Head
Nut	21-3120001	10	6-32 Hex
Spacer	21-3600006	10	6-32x5/16" Threaded, Metal
Rivet	21-0220000	11	Pop Rivet, #6x3/32 USM AD42H
Tab	23-0900023	11	Faston, 3M 07-6-250
Connector	23-1700024	1	6 Conductor, Lock, Molex 09-65-1061
Connector	23-1700026	1	10 Conductor, Lock, Molex 09-65-1101
Insulator	28-0100002	3	TO220 Style, GG Semiconductor Package, Bergquist
Resistor	30-2047664	1	.47 Ohm, 2 Watt (yellow, violet, silver)
Resistor	30-2820362	1	82 Ohm, $\frac{1}{4}$ Watt (grey, red, black)
Resistor	30-2470362	2	47 Ohm, $\frac{1}{4}$ Watt (yellow, violet, black)
Resistor	30-3220362	1	220 Ohm, $\frac{1}{4}$ Watt (red, red, brown)
Resistor	30-4220362	3	2.2K Ohm, $\frac{1}{4}$ Watt (red, red, red)
Capacitor	32-2001010	6	.01uF 25V Disk Ceramic
Capacitor	32-2010010	6	.1uF 30V Disk Ceramic
Capacitor	32-2122070	2	2.2uF 25V Tantalum

IMSAI PCS-80/15
SECTION III-B
EXP-10 Assembly

<u>ITEM</u>	<u>IMSAI PART #</u>	<u>QUANTITY</u>	<u>DESCRIPTION</u>
Capacitor	32-2233070	1	33uF 25V Tantalum
Diode	34-1000006	2	1N914, Signal Type
Diode	34-1000007	3	1N4002
Transistor	35-2000002	1	2N3904
Transistor	35-2000003	1	2N3906
Transistor	35-2000010	1	TIP 32 3A
Resistor Pak	35-6000003	10	220 Ohm, SIP
IC	36-0740001	1	7400, Quad 2 Input NAND
IC	36-0747401	1	7474, Dual D Flip Flop
Regulator	36-0780501	2	7805, +5V
Connector	91-1200060	1	EXPM-5 Assembly, Edge Connectors (Alt: 91-1700006)
Harness	91-1200306	1	Harness Assembly, EXP-10/PS-28
PC Board	92-0000059	1	EXP-10 Rev. 2.2
Bracket	93-3170017	1	Heat Sink Bracket, EXP-10

C. EXP-10 ASSEMBLY

- () 1. Carefully unpack your kit and check all parts against the parts list shown at the beginning of this instruction set. Do not discard any of the packing materials until all of the parts are accounted for. In case of any discrepancies, contact IMSAI Customer Service immediately.
- () 2. Position the board as shown in the Assembly Diagram at the beginning of this section. The component side (silk screen) should be towards you and the edge with five (5) pop-riveted tabs should be down. All references in these instructions assume that the board is viewed with this orientation.

Refer to the photographs at the end of Section II in order to identify components with which you may be unfamiliar.

RESISTOR AND CAPACITOR INSTALLATION

NOTE: If you are using a lead bender to bend resistor and diode leads, bend resistor leads R2 - R8 and diode leads CR1 - CR5 for 0.50 inch spacing and bend resistor leads R1 for 0.75 inch spacing.

- () 3. Insert and solder two 2.2uF tantalum capacitors at locations C3 and C5.

CAUTION: When installing the tantalum capacitors, the "+" lead (marked on the capacitor) must be inserted in the pad marked "+" on the silk screen. An incorrectly installed tantalum capacitor could damage the board.

- () 4. Insert and solder three 2.2K Ohm, 1/4 watt resistors (red, red, red) at locations R6, R7, and R8.
- () 5. Insert and solder two 47 ohm, 1/4 watt resistors (yellow, violet, black) at locations R4 and R5.
- () 6. Insert and solder a 220 ohm, 1/4 watt resistor (red, red, brown) at location R3.
- () 7. Insert and solder a 82 ohm, 1/4 watt resistor (grey, red, black) at location R2.
- () 8. Insert and solder a .47 ohm, 2 watt resistor (yellow, violet, grey) at location R1.
- () 9. Insert and solder a 33uF tantalum capacitor at location C7. Observe polarity as shown on the board.
- () 10. Trim excess leads.

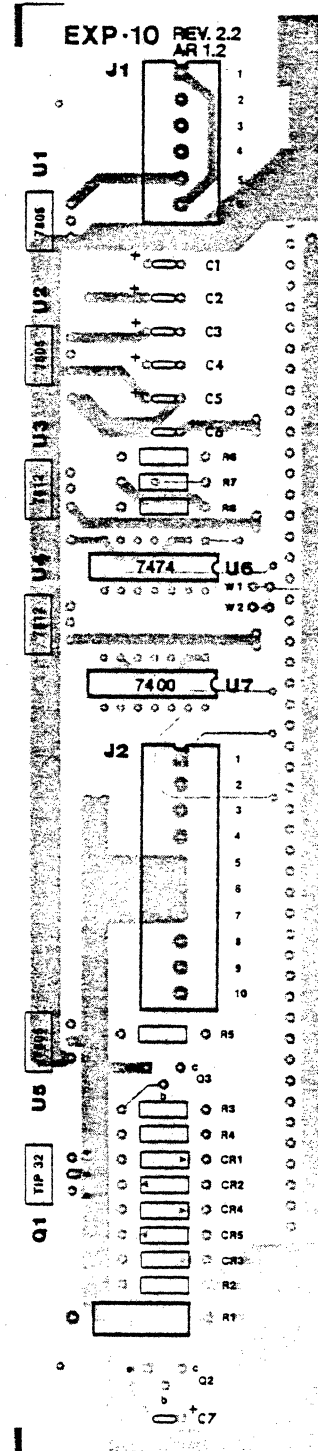

() 11. Insert and solder six .1uF disk capacitors in the following locations.

- | | |
|---------|---------|
| () C8 | () C14 |
| () C10 | () C16 |
| () C12 | () C18 |

() 12. Insert and solder six .01uF disk capacitors in the following locations:

- | | |
|---------|---------|
| () C9 | () C15 |
| () C11 | () C17 |
| () C13 | () C19 |

() 13. Locate the ten resistor packages. These blue plastic, packages are 1 1/8 inch in length and have ten leads each. There is a black dot at one end of the pack which denotes pin 1. Pin 1 should be oriented towards the top of the board when resistor packages are installed.

() 14. Insert and solder the ten resistor packages, side-by-side, in the locations indicated by brackets.

() 15. Trim excess leads.

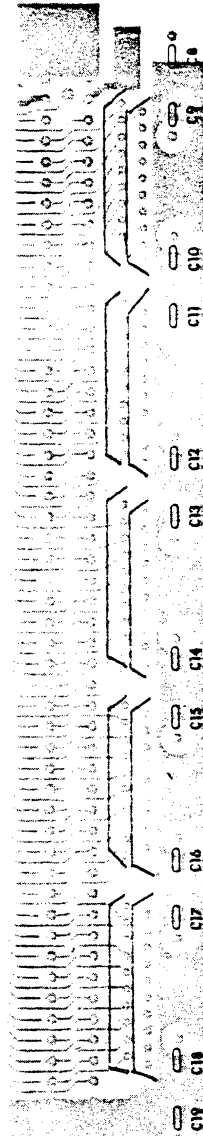

DIODE AND TRANSISTOR INSTALLATION

NOTE: All diodes are polarized and must be installed with a specific orientation. The "cathode" end is marked with a colored band and is represented on the Assembly Diagram in the following manner:

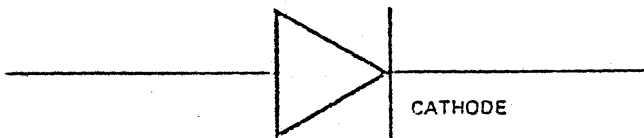

- () 16. Insert and solder three 1N4002 diodes in the following locations, preserving the proper orientations.

- () CR1
- () CR2
- () CR3

- () 17. Insert and solder two 1N914 diodes in the following locations preserving the proper orientations.

- () CR4
- () CR5

NOTE: See Section II, Figure II - 2 for instructions concerning correct transistor orientation.

- () 18. Insert and solder a 2N3906 transistor at location Q2.
- () 19. Insert and solder a 2N3904 transistor at location Q3. NOTE: Q1 will be installed with the regulators.
- () 20. Trim all excess leads.

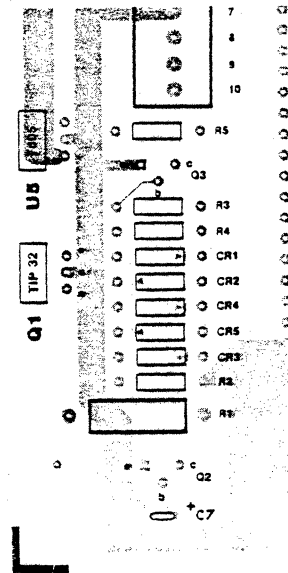

IC AND CONNECTOR INSTALLATION

NOTE: IC's U2 and U5 are voltage regulators and will be installed later.

- () 21. Insert the six pin Molex connector 09-65-1061 at location J1. It is necessary to orient the locking ramp of the connector to the right in order to position this connector correctly.
- () 22. Insert a 7474 IC in location U6 with pin 1 in the upper right-hand corner (see Section II, Figure II - 1).
- () 23. Insert a 7400 IC in location U7 with pin 1 in the upper right-hand corner.
- () 24. Insert the 10-pin Molex connector 09-65-1101 at location J2. Position the locking ramp to the right.
- () 25. Solder the components installed in Steps 21 - 24.
- () 26. The 100 pin edge connectors now are installed. If you have received the standard five edge connectors, we recommend that you install the first connector in the farthest left location, skip a connector slot, install the next connector, etc., until all five connectors are in place. If additional connectors are purchased, begin again at the left and fill the empty connector slots.
- () 27. Solder one pin at each end of each connector. This will keep the connectors level on the board during the remainder of the soldering.

CAUTION: The solder mask minimizes the chances of shorting adjacent traces. It is imperative, however, that extra care be taken during assembly to avoid shorting adjacent pins due to excess solder; a short between board and connector is extremely difficult to locate.

- () 28. Solder the remaining pins on one connector at a time. Check each connector for shorts and solder pools. After thoroughly checking a connector, proceed to the next one, following the same procedure.

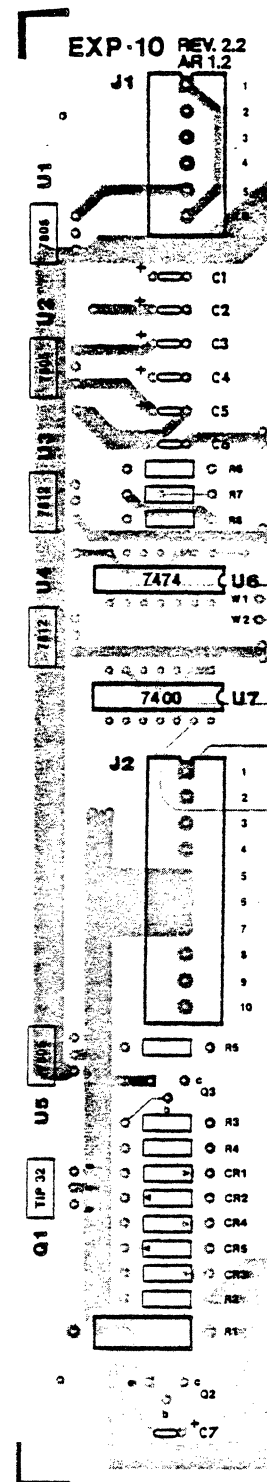

REGULATOR INSTALLATION

- () 29. Locate the regulator bracket. Orient the bracket with the stand-offs under the board, lined up with the holes provided. Attach with two 6-32x5/16" machine screws.
- () 30. The leads of the regulators and transistor Q1 must be double bent in the fashion shown in Figure III - 4.

FIGURE III 4
REGULATOR MOUNTING DETAIL

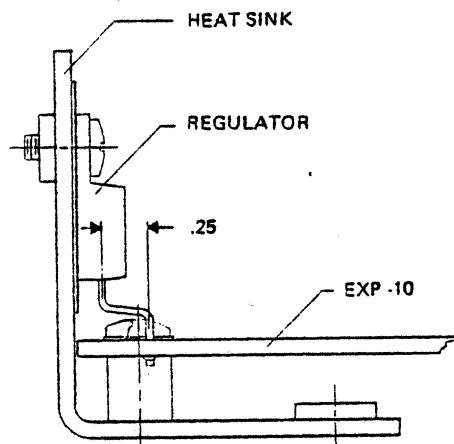

NOTE: To install a regulator the builder first must insert the three legs into the proper holes; an insulator then is placed between the regulator body and the heat sink/bracket. A 4-40x3/16" nylon machine screw then is placed through the regulator and insulator and screwed into the captive nut on the bracket.

- () 31. Install two 7805 regulators in locations U2 and U5.
- () 32. Install a TIP 32 transistor at location Q1.

FINAL INSTRUCTIONS

- () 33. Trim all leads.
- () 34. Carefully check the motherboard for unsoldered joints, excess solder, solder balls and splashes.



ASSEMBLY OF THE EXP-10 MOTHERBOARD IS
COMPLETE. PROCEED WITH ASSEMBLY OF THE
MAINFRAME.

D. PCS-80/15 MAINFRAME ASSEMBLY

PCS-80/15
SECTION III-D
CHASSIS ASSEMBLY

Parts List

<u>ITEM</u>	<u>IMSAI PART #</u>	<u>QUANTITY</u>	<u>DESCRIPTION</u>
Screw	20-3202001	8	6.32 x 1/4" Phillips Pan Head Machine (PPHM) Cad
Screw	20-3302001	6	6.32 x 5/16" PPHM Cad
Washer	21-3350001	14	#6 Internal Star Lockwasher
Rubber Feet	28-0400001	8	
Fan Guard	34-0200001	1	
PS-28U Assembly	91-1200124	1	
Label	93-0000002	1	High Voltage Caution Label
Card Frame	93-3010002	2	I8080,R&L,Rev. C
Back Frame	93-3010003	1	I8080,Rev. E
Cable Clamp	93-3010013	1	I8080,Rev. A
Bottom	93-4010004	1	I8080,Rev. D

PCS-80/15
SECTION III-D
SWITCH HARNESS ASSEMBLY

SWITCH HARNESS ASSEMBLY PARTS LIST

<u>ITEM</u>	<u>IMSAI PART #</u>	<u>QUANTITY</u>	<u>DESCRIPTION</u>
Wire	22-1022001	16"	22 AWG, Brown, Standard
Wire	22-1022002	16"	22 AWG, Red, Standard
Wire	22-1022003	16"	22 AWG, Orange, Standard
Wire	22-1022004	16"	22 AWG, Grey, Standard
Wire	22-1022005	20"	22 AWG, Green, Standard
Wire	22-1022006	16"	22 AWG, White, Standard
Wire	22-1022007	16"	22 AWG, Black, Standard
Wire	22-1026002	8"	18 AWG, Black, Standard
Pin	23-0900002	3	Pin, Male, Molex 02-09-2118
Lamp	23-1400001	2	Lamp, Sub. Min. 14v GE 2182
Connector	23-1700004	1	Connector, Molex 03-09-2031
Connector	23-1700014	1	Connector, HSG 10-Pin Wafer, Molex 09-50-3101
Terminal	23-1700016	9	Female Terminal, Molex 08-50-0106
Key	23-1700017	1	Molex 15-14-0219
Tie Wrap	24-0100002	10	Panduit SSTIM
Shrink Tubing	24-1000003	5"	1/8" Black
Switch	26-1400001	1	PB Red, SPDT MFM Molex 10420B-109-309-412-601
Switch	26-1400002	1	PB Blue, SPDT MFM Molex 10420B-109-309-412-601
Keyswitch	26-2000010	1	2 Position, ALCO CNK-206N
Spacer	93-2170016	1	Safety Keyswitch

D. PCS-80/15 MAINFRAME ASSEMBLY

The PCS 80/15 cabinet is constructed in several stages, each stage yielding a sub-assembly. In the final stage of cabinet construction, the sub-assemblies are integrated into the completed chassis. The major sub-assemblies are:

- 1) Bottom Plate — contains power supply, motherboard and chassis base as well as all associated cables.
- 2) Back Panel — contains card rails, back plate, fan, power cord and cables.
- 3) Front Panel — contains front plate, switches and all associated cables.

Unpack all cabinet parts and check them against the parts list shown at the beginning of this instruction set. In case of any discrepancies, contact IMSAI Customer Service.

1. BOTTOM PLATE ASSEMBLY

a) POWER SUPPLY INSTALLATION

- () 1. Place the PS-28U power supply sub-assembly that you assembled earlier on your work surface.
- () 2. Locate the four (4) black wires. These wires have a crimp-on connector attached to one end.
- () 3. Strip 1/4 inch of insulation from the untreated end of each wire and install the wires onto the power supply board as shown in the diagram below. Solder each wire as soon as it is inserted.

- () Black wire #1
- () Black wire #2
- () Black wire #3
- () Black wire #4

- () 4. Locate the three (3) white wires. These wires have a crimp-on connector at one end.

- () 5. Install and solder the three white wires as shown in the diagram below:

- () White wire #1
- () White wire #2
- () White wire #3

- () 6. Locate two (2) yellow cables and two (2) orange cables. These cables also have a pre-installed connector at one end.

- () 7. Install and solder the two yellow and two orange wires as shown:

- () Orange wire #1
- () Orange wire #2
- () Yellow wire #1
- () Yellow wire #2

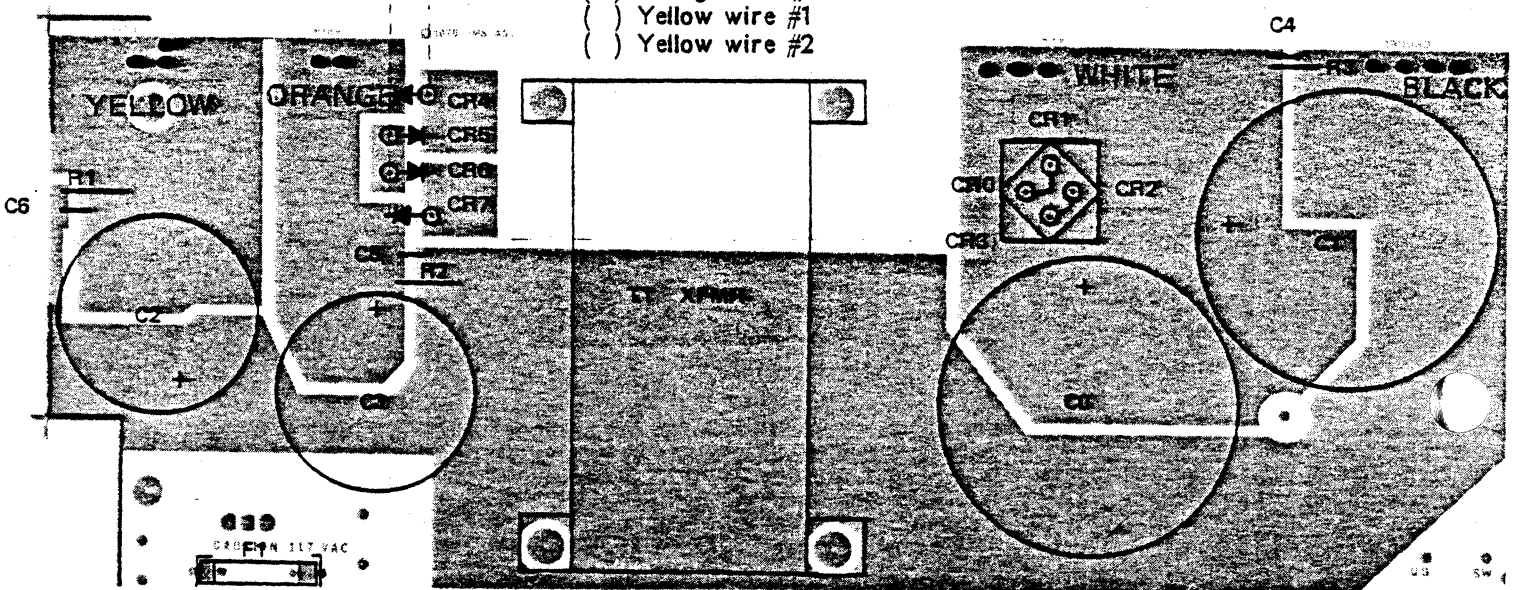

IMSAI PCS-80/15
SECTION III-D
MAINFRAME ASSEMBLY

- () 8. Set the power supply aside temporarily, and position the chassis baseplate in front of you. The baseplate should be positioned so that the bent edges are pointed upwards and are on the right and left sides. Notice that there are some large holes on one side of the chassis. This side should be positioned to your right.
- () 9. Position the PS-28U power supply sub-assembly at the right side of the baseplate. The two larger capacitors should be positioned toward the rear.
- () 10. Notice that the five holes on the PS-28U PC board — two at the rear of the chassis, two at the front and one between the large capacitors — line up with five corresponding holes on the baseplate. These five holes will be used to mount the power supply sub-assembly to the chassis. It is suggested that you mark the holes on the baseplate with a felt tip pen to facilitate locating them later on.
- () 11. Remove the PS-28U power supply sub-assembly from the baseplate.
- () 12. Locate the following hardware:
 - () Five (5) sets of: 8-32x1 1/4" machine screw, 8-32 nut, #8 lockwasher, 8-32x1/2" nylon spacer.
 - () Four (4) sets of: 1/4"-20x1/2" nylon spacer, 1/4"x1/16" nylon washer, 1/4" lockwasher, 1/4" washer, 1/4"-20 nut.
- () 13. Position a 8-32x1/2" nylon spacer over the five holes that you marked in Step 10. This spacer is used to support the power supply above the metal chassis.
- () 14. Position four 1/4"-20x1/2" nylon spacers over the four large holes on the right side of the baseplate. The spacers are used to support the power transformer.
- () 15. Insert a 8-32 screw through each of the five marked holes, from the bottom of the plate to the top, through the nylon spacer. We suggest that a piece of tape be placed over the head of the screw to hold it in place.
- () 16. Insert a 1/4"-20 screw through each of the large holes in a fashion similar to that described in Step 15.
- () 17. Lift the PS-28U power supply sub-assembly onto the baseplate. Be sure that all nine screws are in the appropriate holes.
- () 18. For each of the four large screws place a 1/4" nylon washer between the PC board and the transformer.
- () 19. Secure the large screws that hold the transformer with a 1/4" washer a 1/4" lockwasher and a 1/4" nut, in that order. Do not tighten at this time.
- () 20. Secure the other five screws with a #8 lockwasher and 8-32 nut.
- () 21. Tighten all nine screws securely.

b) MOTHER BOARD INSTALLATION

() 22. Locate the following hardware:

- (10) 6-32x3/4" screw
- (10) 6-32x5/16" metal spacer (threaded)
- (10) 6-32 nut
- (10) fiber washers
- (10) #6 lockwashers

- () 23. Locate the EXP-10 mother board sub-assembly that was constructed earlier and place it on the chassis baseplate. The motherboard should be positioned toward the back of the chassis on the left side. The heat sink fin should be directed towards the front of the chassis.
- () 24. Notice that the ten mounting holes in the motherboard line up with ten holes on the baseplate. We suggest that these holes be marked with a felt pen to facilitate identification in the instructions which follow.
- () 25. Remove the EXP-10 mother board sub-assembly from the baseplate.
- () 26. Place one #6 lockwasher on each of the 6-32x3/4" screws. Insert the screw in each of the ten holes marked in Step 24. The screw should be inserted from the bottom and secured on the top with a 6-32x5/16" spacer. Do not tighten the spacer at this time.
- () 27. Place a fiber washer on each of the spacers installed in Step 26.
- () 28. Place the EXP-10 mother board sub-assembly onto the ten mounting screws. Each screw should protrude through one of the ten mounting holes. If they do not line up, adjust the position of the screws until they do.
- () 29. Remove the mother board from the baseplate.
- () 30. Tighten the ten mother board mounting screws.
- () 31. Place the WHITE cables, which are attached to the power supply, across the area where the motherboard is mounted. The cables should pass below the the screws closest to the front of the chassis.
- () 32. Included in your kit are several plastic cable ties. Use several of these to tie the white wires together where they pass under the mother board. The placement of these ties is not critical.

IMSAI PCS-80/15
SECTION III-D
MAINFRAME ASSEMBLY

- () 33. Place the EXP-10 mother board sub-assembly onto the mother board mounting screws.
- () 34. Secure the mother board with ten (10) 6-32 nuts.
- () 35. Connect the four (4) black cables, attached to the power supply, to the four snap-on connectors on the right side of the mother board. Any cable may be attached to any connector.
- () 36. Position the two yellow and two orange wires attached to the power supply as follows:
 - () Bend all four wires so that they lie parallel to the power supply
 - () Use several cable ties to hold all four wires together.
 - () Bend all four wires so they cross the chassis just below the mother board. Once again, use several cable ties to hold the four wires together.
 - () Bend the cables so that they pass along the left side of the mother board.

IMSAI PCS-80/15
SECTION III-D
MAINFRAME ASSEMBLY

() 37. In the following steps the white, yellow and orange power supply cables will be attached to the mother board. These connectors clip on and should not be soldered. Reference the drawing on the right side of this page for cable placement.

- () WHITE power supply wire (any one of the three)
- () ORANGE power supply wire (either one of the two)
- () YELLOW power supply wire (either one)
- () WHITE power supply wire (either one)
- () ORANGE power supply wire
- () YELLOW power supply wire
- () WHITE power supply wire

CAUTION: Check to see that the cables are connected to the mother board correctly. If a cable is improperly connected, severe damage may result. Remember, these connectors are NOT to be soldered.

() 38. Use several of the cable ties to hold the power supply cables together (placement is not critical).

EXP-10 Motherboard

Left Edge View

Back of Chassis

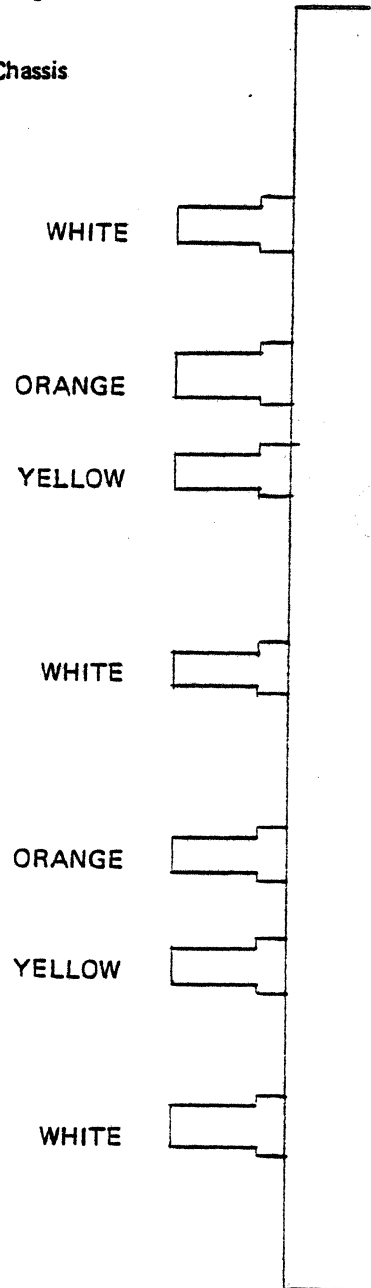

Front of Chassis

2. BACKFRAME ASSEMBLY

- () 39. Locate the two card frame sides. (The left and right pieces are identical). Position both pieces on your work surface so that the flange on the short edge is facing upwards. At this time mark the pieces by applying the power supply warning sticker ("Danger high voltage ...") to the flange on the right side of the right card guide. The arrows should point downward. From now on, the card guide with this sticker will be referred to as the "right" one, the other being the "left".
- () 40. Locate the ten (10) plastic card guides. The card guides are pressed into the rows of holes in the right and left card frame sides. There will be two plastic card guides installed at each position where you have installed an edge connector on the mother board. The instructions here are for the standard configuration of five edge connectors. If you have purchased additional edge connectors (EXPM), install two card guides at the remaining locations (one on each side).
- () 41. Examine one of the plastic card guides. Notice that one end of the slot is beveled (producing a wider slot), while the other side is flat. In the following instructions, the "flat" side will be referred to as such.
- () 42. Beginning at the back (the side farthest from you), count forward to the SECOND hole. Orient a plastic card guide so that the flat side is to the RIGHT. Gently press the tabs on the card guide into the holes on the card frame. Do NOT use a hammer, as the tabs are easily broken.
- () 43. Install another card guide in the FOURTH hole in from the rear, again keeping the flat side once again to the right.
- () 44. Continue in the manner outlined above, and install three (3) more card guides on the left card frame in every OTHER hole.
- () 45. Install five (5) card guides on the right card frame in the same holes (every other one), with the flat side toward the LEFT.
- () 46. If you have purchased additional edge connectors, install the card guides at this time, observing the same orientation.
- () 47. Set the left and right card frames aside, and locate the chassis back frame.
- () 48. Orient the back frame so that the bent edges are facing upward and the large round hole is to the right.

IMSAI PCS-80/15
SECTION III-D
MAINFRAME ASSEMBLY

- () 49. Pick up the fan, noting that this component has an arrow on one side which indicates the direction of airflow. Position the fan over the large hole in the back panel with the arrow pointing downward. Orient the fan so that the connector is at the lower righthand corner.
- () 50. Locate the plastic fan guard; place it on the other side of the metal back panel over the fan. Secure the fan and fan guard to the backpanel with four (4) 6-32x1/4" screws inserted from the side with the fan guard; fasten with a #6 lockwasher and 6-32 nut.
- () 51. Attach the cable clamp to the top edge of the back panel with two 6-32x1/2" screws. Note: the cable clamp can be attached using either set of holes.
- () 52. Locate the AC power cord and the strain relief bushing. Note that three molex pins — without a plastic cover — are installed at the end of the power supply cord.
- () 53. Insert the power cord through the hole directly below the fan. Insert the cord from the fan guard side.
- () 54. Pull approximately 3 inches through the hole. Install the strain relief bushing onto the cable and press it into the hole.
- () 55. Locate the molex shell and install the pins into the shell.
- () 56. Position the back panel on its edge with the fan towards you and to the right. Attach the RIGHT card frame to the back panel with the power supply sticker facing up and the plastic card guides closest to the backpanel.
- () 57. In a similar fashion, attach the left card frame to the back panel. Insure that the card guides are closest to the back.
- () 58. Attach the chassis front frame to the other end of the left and right card frames. Use four (4) 6-32x1/2" screws and #6 lockwashers.
- () 59. Temporarily set the back panel sub-assembly aside.

3. FRONT PANEL ASSEMBLY

- () 60. Place a soft cloth on your work surface to prevent scratching the front panel.
- () 61. Locate the key-lock switch and the female molex connector cable.
- () 62. Solder one of the leads to pin 1 on the switch. See the diagram below.
- () 63. Solder the other lead to pin x on the switch (S-1).
- () 64. Attach the key-lock switch to the front panel using the supplied hardware. The orientation of the switch is not critical.
- () 65. Locate the red and the blue pushbutton switches. Note that one side of the switch has raised letters ("pat. pend", etc.).
- () 66. Press the BLUE switch into the square hole above the key-lock switch from the front of the panel. The side with the raised letters should be to the RIGHT when viewed from the front of the panel.
- () 67. In a similar fashion, press the RED switch into the other square hole.
- () 68. Position the panel so that the backs of the switches are towards you. In the following steps, the LONG cable harness will be attached to the switches. Use the drawing on the next page for reference. Note that the drawing is a REAR view.

Front Panel Switch Assembly

Rear View

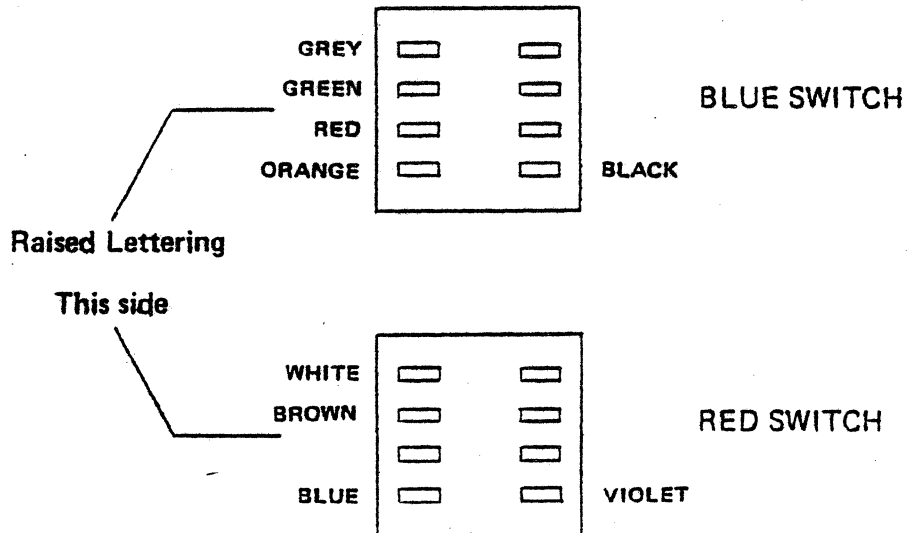

- () 69. Cut nine (9) 1/2 inch lengths of black heat shrinkable tubing.
- () 70. Slip one length of heat shrinkable tubing over each of the wires on the switch wiring harness.
- () 71. Solder the GREY wire from the harness to the top left pin (as viewed from the rear) of the BLUE switch.
- () 72. Solder the GREEN wire to the second pin of the blue switch. (S-1)
- () 73. Solder the RED wire to the third pin. (S-1)
- () 74. Solder the ORANGE wire to the bottom left pin. (S-1)
- () 75. Solder the BLACK wire to the lower right pin. (S-1)
- () 76. Solder the WHITE wire to the top left pin of the RED switch. (S-1)
- () 77. Solder the BROWN wire to the second pin of the red switch. (S-1)
- () 78. Solder the BLUE wire to the bottom left pin of the red switch. (S-1)
- () 79. Solder the VIOLET wire to the bottom right pin of the red switch. (S-1)
- () 80. Slide the heat shrinkable tubing that you installed on each wire down over the soldered connection.
- () 81. Using a heat gun, or a powerful hairdryer, heat the tubing until it shrinks tightly around the connection. If you don't have a powerful enough hairdryer you can hold a soldering iron close to the tubing being careful not to actually touch it.

This completes construction of the Front Panel Assembly. Continue with Final Chassis Assembly.

4. FINAL CHASSIS ASSEMBLY

- () 82. Position the chassis baseplate in front of you.
- () 83. Mount the backframe assembly to the chassis. The lip on the rear panel should be under the baseplate. Use 6-32x1/4" screws.
- () 84. Mount the front panel to the chassis frame. Use 6-32x1/4" screws.
- () 85. Plug the fan cable from the power supply onto the fan connector.
- () 86. Plug the power cord connector into the mating connector at the rear of the power supply.
- () 87. Plug the key-lock switch cable into the cable at the front of the power supply.
- () 88. Plug the free end of the switch cable onto the connector on the mother board. Note that the end of the conector with the BLACK wire should be positioned toward the power supply.

E. SYSTEM TESTING

E. SYSTEM TESTING

The first step in systems testing is ascertaining that all of the power supply voltages are correct. You will need a DC voltmeter in order to perform the test procedures.

- () 1. Remove the connector J2 from the motherboard.
- () 2. Clip the NEGATIVE lead of your DC voltmeter to the BLACK wire connector on the mother board: the lead from the power supply.
- () 3. Clip the POSITIVE lead of your voltmeter to the WHITE wire connector on the mother board.
- () 4. Set the voltmeter to read 25 volts DC full scale.
- () 5. Make sure that a 3-wire, grounded outlet is available. The IMSAI PCS 80 computer should always be plugged into a grounded outlet to eliminate electronic "noise" and to ensure safe operation of your system, particularly when connecting the computer to peripherals.
- () 6. Insert the key to key-lock power switch into the switch. Turn the key counter-clockwise to insure that the machine is OFF when first plugged in.
- () 7. Plug the power cord into an AC outlet.
- () 8. Position yourself so that the voltmeter is visible, and power-up the computer by turning the key CLOCKWISE.
- () 9. When power is first applied, the VOM reading should be in the 8.0 volts to 11.0 volts DC range. If the voltage is 1 - 2 volts low, or 1 - 2 volts high, change the tap on the power transformer AFTER unplugging the power cord from the wall. Refer to the power supply assembly instructions for information concerning changing the tap on the transformer.
- () 10. If ANY of the voltage readings are out of range, discontinue testing immediately. If you are inexperienced in electronic troubleshooting, bring the chassis and power supply to your IMSAI dealer or send the unit to IMSAI Customer Service in San Leandro, California. Be sure to call or write first for return authorization BEFORE YOU SEND THE UNIT BACK TO IMSAI.
- () 11. Turn the key-lock switch to the "on" position, note the meter reading, and then immediately turn off the machine. If the reading is out of range, discontinue testing.

IMSAI PCS-80/15
SECTION III-E
SYSTEM TESTING

- () 12. Disconnect the positive meter lead from the white terminal, and connect it to the ORANGE lead. Set the meter to 50 volts full scale (DC).
- () 13. Turn the switch on and off again, noting the meter reading. The proper range is 16-20 volts. Once again, discontinue testing if the voltage is out of range.
- () 14. Disconnect the positive lead, and re-connect it to the YELLOW terminal. Set your voltmeter to read NEGATIVE DC voltage. (If your meter does not have this feature, reverse the positive and negative leads.)
- () 15. Once again, turn the power switch on and off, noting the meter reading. The proper range is 16-20 volts DC.
- () 16. Connect the NEGATIVE lead of the voltmeter to the BLACK connector on the mother board.
- () 17. Turn the key-lock power switch to "on".
- () 18. Locate connector J1 on the mother board. Measure the voltage at the following pins and check for the correct voltage:
 - pin 1 — 11.5-12.5 volts
 - pin 2 — 11.5-12.5 volts
 - pin 3 — 4.5-5.5 volts
 - pin 4 — 4.5-5.5 volts
 - pin 5 — 0 volts
- () 19. Turn the key-lock power switch "off".

IMSAI PCS-80/15
SECTION III-E
SYSTEM TESTING

- () 20. Locate the MPU-B board assembled earlier. Look at the back of the board and locate the pins on the LM323 regulator. (The regulator is at the lower right-hand corner when viewed from the back.)
- () 21. Make a mental note of the position of the upper pin, and plug the MPU-B into the mother board. (The board can be plugged into any slot; however, for test purposes, one of the slots towards the front of the machine is preferable.)
- () 22. Connect the NEGATIVE lead of the voltmeter to one of the black terminals on the mother board (as before). Connect the POSITIVE lead to upper pin on the LM323 that you located before.
- () 23. Turn the power "on", observe the meter reading, then immediately switch the power "off". The voltage measured should be in the range 4.5 - 5.5 volts DC. If it is not, the LM323 regulator on the MPU-B is probably defective.
- () 24. Locate the 8085, 8251, 8253, 2708 IC's that were left over from the MPU-B assembly. These parts will now be installed.
- () 25. Insert the 8085 into the 40 pin socket at U20. Note that pin 1 is directed towards the gold-plated edge connector.
- () 26. Insert the 8251 into the 28 pin socket at U25.
- () 27. Insert the 8253 into the 24 pin socket at U24.
- () 28. Insert the 2716 into the 24 pin socket at U9.
- () 29. Plug the MPU-B into one of the slots on the motherboard.

THIS COMPLETES THE ASSEMBLY OF YOUR IMSAI PCS-80/15.

IV OPERATOR'S GUIDE

(NOTE: If you have assembled a PCS-80/15 Kit and have purchased a RAM memory board, proceed to Section IV, Part A 2: "Memory Insertion". If you have purchased a keyboard and CRT but have not purchased additional RAM, proceed to Section IV, Part A 3: "Functional Tests".

If you have purchased an ASSEMBLED computer, read Section IV, Part A 1 as well.)

A. INITIAL SYSTEM HOOK-UP AND TESTING

A. INITIAL SYSTEM HOOK-UP AND TESTING

1. UNPACKING OF UNIT

Carefully remove the contents of the two shipping boxes. For a standard IMSAI PCS-80/15 Computer, these will consist of

- a) Documentation Set (Manual plus two books)
- b) PCS-80/15 Computer

We recommend that you save the original shipping cartons and all packaging material to prevent damage should you wish to transport your unit. Carefully inspect your PCS-80/15 for signs of damage during shipping. Your computer has undergone extensive quality inspections and operational tests prior to shipment. If the unit is damaged in any way, notify the carrier and IMSAI Customer Service immediately.

The PCS-80/15 Computer you have purchased contains only 256 bytes of RAM; located on the MPU-B, the RAM provides sufficient memory space for operation of the monitor. In order to load and execute programs in Assembly Language, BASIC or FORTRAN (see Section V), the user must purchase additional RAM which can be ordered preconfigured from the factory.

The IMSAI RAM-16, RAM-32, and RAM-65 comprise a complete line of random access memory boards for S-100 bus microprocessor systems. They are specifically designed to support memory expansion in any multiple of 16K bytes.

Each board, as indicated by its numerical designator, provides 16K, 32K or 65K bytes of dynamic RAM. Dynamic RAM can hold data for only a few milliseconds and therefore must be constantly refreshed. Refresh circuitry is completely self-contained on each board, and no WAIT STATES are required. (Processing speed is normally limited by memory's ACCESS TIME. For example, after the CPU sends a read address to memory, processing halts until the memory has had time to respond. Memory requests a WAIT STATE causing the CPU to idle until memory has responded. IMSAI dynamic RAM board circuitry obviates the necessity for wait states.) All boards have total access time of 400 ns (nanoseconds) and cycle time of 560 ns (max).

We recommend purchase of the RAM-16 board to hobbyists using tape cassettes. 16K of RAM provides adequate memory for BASIC user programs. Users with disk systems should purchase 32K of RAM, required for running FORTRAN and Commercial or Extended BASIC programs. 65K of RAM is necessary for those applications involving text or numerical processing using arrayed variables.

IMSAI PCS-80/15
SECTION IV-A
OPERATOR'S GUIDE
MEMORY INSERTION

To provide full address flexibility, the RAM-16, 32 and 65 boards allow the jumper selection of each 16K block of RAM. This enables any 16K block to reside in one of four 16K quadrants of the computer's standard memory space. The instructions described in Part A,3 of this section allow the user to address RAM so that it resides in the LOWEST block of computer memory space. Jumper options regarding RAM addressing are described in the IMSAI Dynamic RAM System User Manual.

If you do not intend to purchase a memory board at this time, skip to Part 3 of this section — Functional Test of the PCS-80/15 — following memory insertion (Part 2). If you do purchase a RAM 16, 32 or 65 board, proceed to Part 2.

Whether or not you purchase additional RAM, your computer has sufficient memory space to hold the "Cursor Chase" game program listed in Appendix D of this manual. However, this game does require a keyboard for program entry and a CRT for display. We recommend that you perform the Functional Tests prior to loading the program.

2. MEMORY INSERTION

NOTE: If you have purchased a PRECONFIGURED RAM board, proceed to Section IV-A, 2-b: INSTALLING RAM.

a) ADDRESSING RAM

Refer to the photographs and assembly drawings located at the end of Section IV-A to aid in memory installation.

In the instructions which follow, "jumper" means "cut an appropriate length of wire and insert WITHOUT SOLDERING into the eyelets" at the locations illustrated by thick black lines in the figures below.

JUMPER AREAS: There are five jumper areas which exist on each of the RAM boards. The area marked "WP" is located between R12 and U39 in the center of the board. Refer to the appropriate assembly drawing. The area marked "PH" is located between U56 and U57 in the lower right hand corner. The area marked "A16", "A32" or "A65" is located to the left of U36 in the lower left corner of the board. The area marked "B16", "B32" or "B65" is located to the left of U47 in the lower left hand corner.

INSTALLING JUMPERS:

FOR RAM 16 OR RAM 32 OR RAM 65:

- () 1. Locate area "WP" on the assembly drawing appropriate to your RAM board; jumper at the location indicated in Figure IV-1.
- () 2. Locate area "PH" on the assembly drawing appropriate to your RAM board; jumper at the location indicated in Figure IV-1.
- () 3. Locate area A16, A32, or A65 on the assembly drawing appropriate to your RAM board; jumper at the location indicated in Figure IV-1.

You have completed installation of the jumpers common to the three RAM boards. Proceed with Step 4 of the instruction set appropriate to the board you have purchased.

FOR RAM-16 ONLY:

- () 4. Locate area B16 on the RAM-16 assembly drawing; jumper at the location indicated in Figure IV-2.

FOR RAM-32 ONLY:

- () 4. Locate area B32 on the RAM-32 assembly drawing; jumper at the location indicated in Figure IV-2.

FOR RAM-65 ONLY:

- () 4. Locate area B65 on the RAM-65 assembly drawing; jumper at the location indicated in Figure IV-2.

You have completed the jumpering of your RAM board. Refer to the appropriate section of the IMSAI Dynamic RAM System User Manual for information concerning jumper options.

b) INSTALLING RAM

Install the RAM board into an empty edge connector on the motherboard. If no slots are available, carefully remove the motherboard from the chassis, being certain to FIRST remove all PC boards which are plugged into the motherboard, and to detach all power connections which hinder removal of the motherboard. (Detach the two white plastic Molex connectors at the front of the motherboard from their cradles, and slide the ground and power connections off the tabs located along the sides of the EXP-10. There are seven tab-style power connectors on the left edge of the EXP-10 and four ground connections along the right-hand edge of the board. You may wish to use a screwdriver to aid in sliding the tabs apart.) Refer to Section III-C for instructions relating to installation of edge connectors on the EXP-10 .

Proceed to FUNCTIONAL TESTS.

3. FUNCTIONAL TESTS

NOTE: The tests of the PCS-80/15 which are outlined below require access to a CRT and keyboard.

a) SYSTEM INITIALIZATION

1. Turn the computer on: insert the key into the keyswitch located on the front panel. The keyswitch is marked "power on". Turn the key one-half turn clockwise to apply power to the PCS-80/15.

The red RESET button located on the front panel will light up.

2. The sign-on "IMSAI MPU-B 2K VERS 1.0" should appear on the first line of the CRT display and the prompt "?" on the second line.

If you are unable to bring the system up, depress the RESET button. This button is also depressed in order to return to the monitor following a system crash or program execution. The sign-on should appear on the screen.

NOTE: Your front panel also has a blue INTERRUPT (INT) button which lights during a "halt/acknowledge" interchange. Depressing the INT button generates an interrupt which, however, must be software-supported. If the button is depressed accidentally during program loading or execution, the system will crash.

The INTERRUPT signal is automatically cleared by an "Interrupt Acknowledge" from the CPU.

The procedures outlined in Steps 3 and 4 should be performed by VIO kit-builders ONLY. If you have purchased an assembled unit, proceed to FUNCTIONAL MEMORY TEST OF MPU-B RAM (Section IV-A,3-b).

3. If your monitor has excessive over-scan, these lines may be off the screen. Adjust horizontal and vertical size on your monitor as necessary. The display will not be sharp if your monitor has inadequate bandwidth. Refer to the photograph on the next page when adjusting your screen display.

Regulate HORIZONTAL HOLD by adjusting the blue, circular trim pot (potentiometer) located in the SECOND position from the front panel. Insert an appropriately-sized screwdriver into the slot on the trim pot, and turn the pot in small increments until horizontal display is stabilized.

Regulate HEIGHTH by adjusting the trim pot located in the position nearest the back panel in a manner similar to that described above, until the horizontal display is centered on the screen.

Regulate the VERTICAL HOLD by adjusting the trim pot located in the FIFTH position from the front panel in a manner similar to that described above.

Regulate the VERTICAL LINEARITY by adjusting the SIXTH trim pot from the front panel in a manner similar to that described above, so that the vertical distance between lines shown on the screen is equivalent throughout the display.

FIGURE IV-1
JUMPERS COMMON TO ALL BOARDS

WP



PH

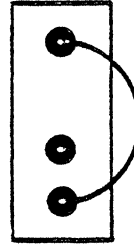

A16/A32/A65

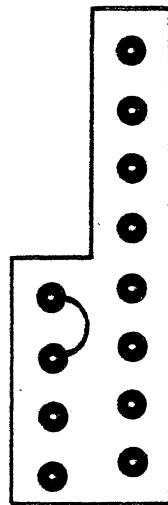
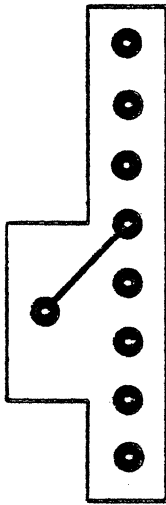

FIGURE IV-2

RAM 16 B16 JUMPERS



0000-3FFF

RAM 32 B32 JUMPERS

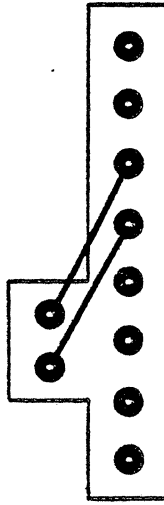

0000-7FFF

RAM 65 B65 JUMPERS

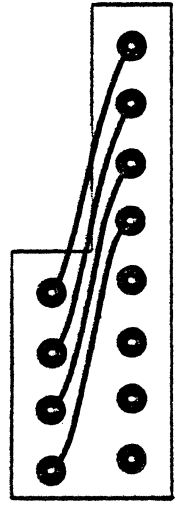

0000-FFFF

4. Adjust the CRT display before proceeding with the functional memory test:

Regulate FOCUS by adjusting the blue, circular trim pot nearest the front panel. Insert an appropriately-sized screwdriver into the slot on the trim pot, and turn the pot in small increments until the CRT display is focused.

Regulate BRIGHTNESS by adjusting the trim pot located in the THIRD position from the front panel in a manner similar to that described above.

Regulate CONTRAST by adjusting the FOURTH trim pot from the front panel (the pot located immediately behind the two blue capacitors) as described above.

Regulate WIDTH by adjusting the width coil using the plastic hex wrench enclosed with you kit. The red coil is located behind and to the right of the CRT, below the yellow rectangular capacitor. Insert one end of the alignment tool into the hex-shaped opening (slug) at the front of the coil tube, and rotate the coil clockwise or counterclockwise to adjust character width to your requirements.

b) FUNCTIONAL MEMORY TEST OF MPU-B RAM

NOTE: These test procedures require access to a CRT and a keyboard.

The monitor program allows you to control the PCS-80/15 with a series of commands called the monitor COMMANDS. Proceed with the functional test of the monitor.

NOTE: When an instruction to type CTL-X (control-X) is given, depress the CTL key while simultaneously typing X. DO NOT TYPE "CTL".

Instructions to hit the RETURN (CARRIAGE RETURN) key are indicated as "@".

1) Type T @

This procedure tests memory from start address to end address. Every memory cell is cycled through all 256 bit patterns and tested to see if it contains the correct pattern. If all memory within the specified range is good, a prompt "?" will appear. If a bad cell or non-existent cell is located, the following display will occur:

AAAA VV SS

where: AAAA is the bad address
 VV is the value in the memory
 SS is what the value should be

Using the form T@ begins the memory test at location 0 and continues until the first bad cell, non-existent cell, or ROM memory is found.

The memory diagnostic DOES NOT destroy the contents of the memory tested.

2) Type T D000,D0FF @ (to test MPU-B RAM)

This memory diagnostic is similar to the test outlined above. If you experience any difficulties with these procedures, call IMSAI Customer Service.

c) FUNCTIONAL TEST OF VIO RAM

1. Type T F000,F7FF @

This memory diagnostic is equivalent to the test outlined immediately above. If you experience any difficulties, contact IMSAI Customer Service.

d) FUNCTIONAL TEST OF VIO ROM FIRMWARE

The following tests apply only to the VIO-C VIOROM firmware. Any problems which arise during these Final Tests must be corrected before proceeding. If you experience difficulties which you are unable to correct, contact IMSAI Customer Service for assistance.

You are still in the PCS-80/30 monitor.

1. Adjust the controls on your monitor for a stable and clear display. You should see the prompt "?" on the CRT display. If your monitor has excessive over-scan, this line may be off the screen. Adjust horizontal and vertical size on your monitor as necessary.
2. Hit the RETURN (carriage return) key on your keyboard. Each time you hit RETURN, the "?" prompt should appear on the following line. Keep hitting RETURN until the prompt is on the bottom line and sign-on scrolls off the top of the screen.
3. Type the sequence FF000, F200, 41 then type RETURN. The top of the screen should be filled with A's. There should be 40 A's in each line.
4. Hit the ESC (ESCAPE) key, then type C. The top of the screen should still be filled with A's but there should now be 80 characters per line.
5. Hit ESC, then type L. The video for the entire screen should now be 80 characters per line, 24 lines per page.
6. Hit ESC, then type V. The video for the entire screen should now be reversed with dark characters on a light background. You may have to readjust the brightness and contrast controls on your monitor for a pleasing display. Again hit ESC, then V. The video should return to normal.
7. Type CTL-C. The screen now should appear as it did in Step 1.
8. Type JF809 then hit RETURN. Control is now transferred to a test routine. Any of the standard alphanumeric characters typed on the keyboard will be echoed to the display.

IMSAI PCS-80/15
SECTION IV-A
OPERATOR'S GUIDE
FUNCTIONAL TESTS

9. Type sequentially: CTL-V, XXX, CTL-V, XXX. DO NOT TYPE COMMAS. The first three X's should appear on the screen in reverse video. The second three X's should appear on the screen in positive video.
10. At this point, testing of the VIO is complete. TURN POWER OFF. If you wish to reconfigure the VIO Board for a particular application, refer to the VIO Manual.

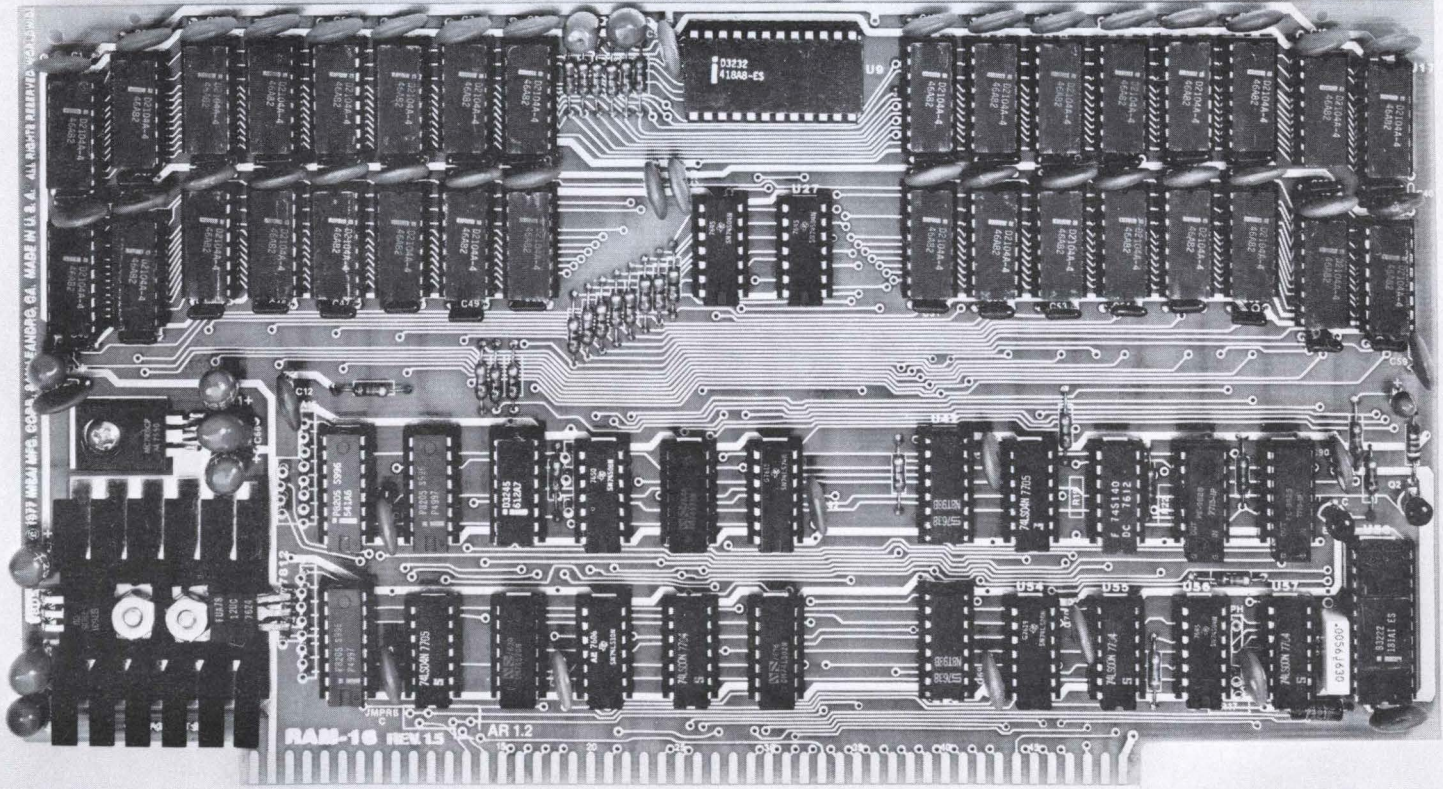

RAM 16K Rev. 1

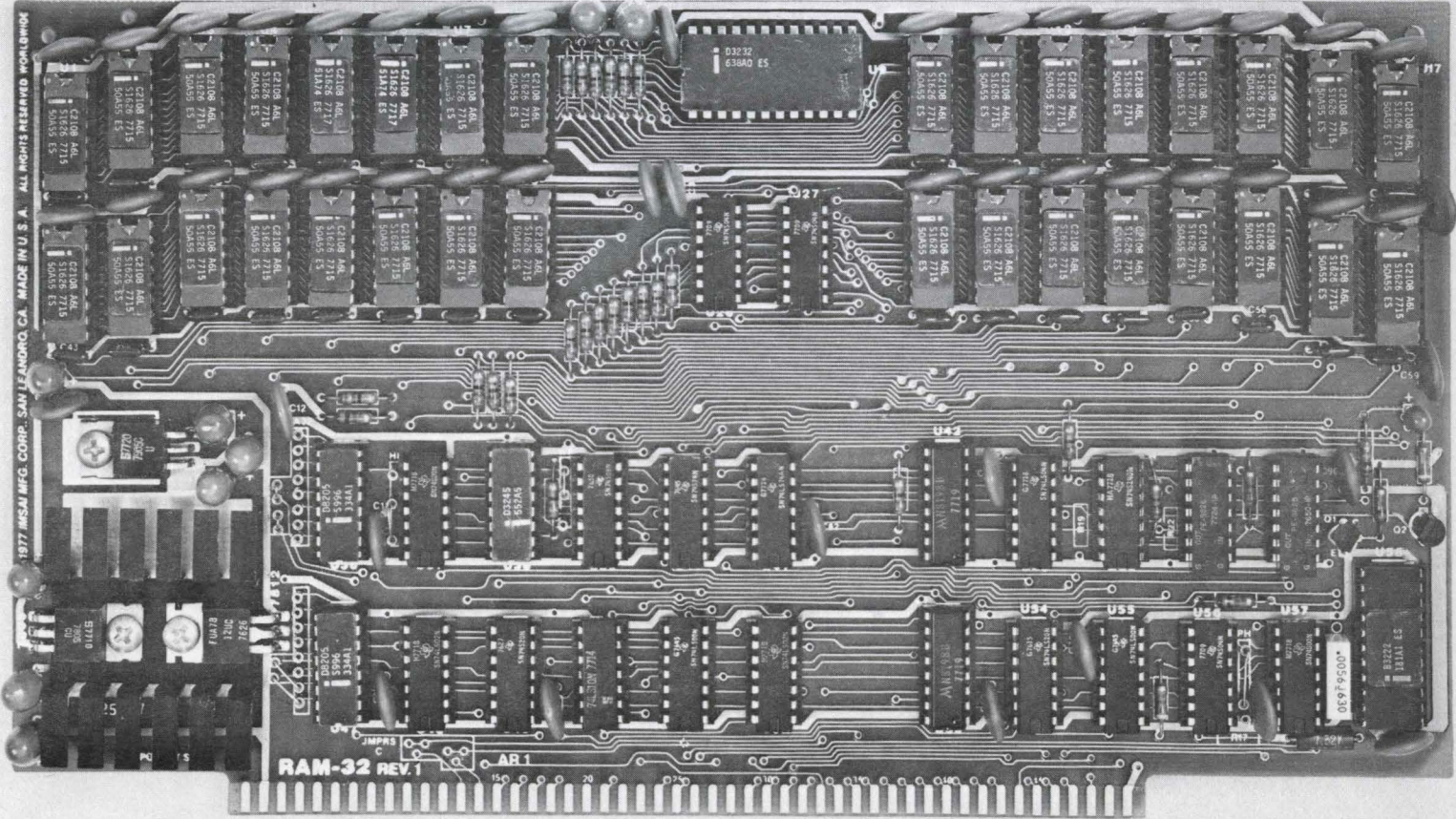

RAM 32K REV.1

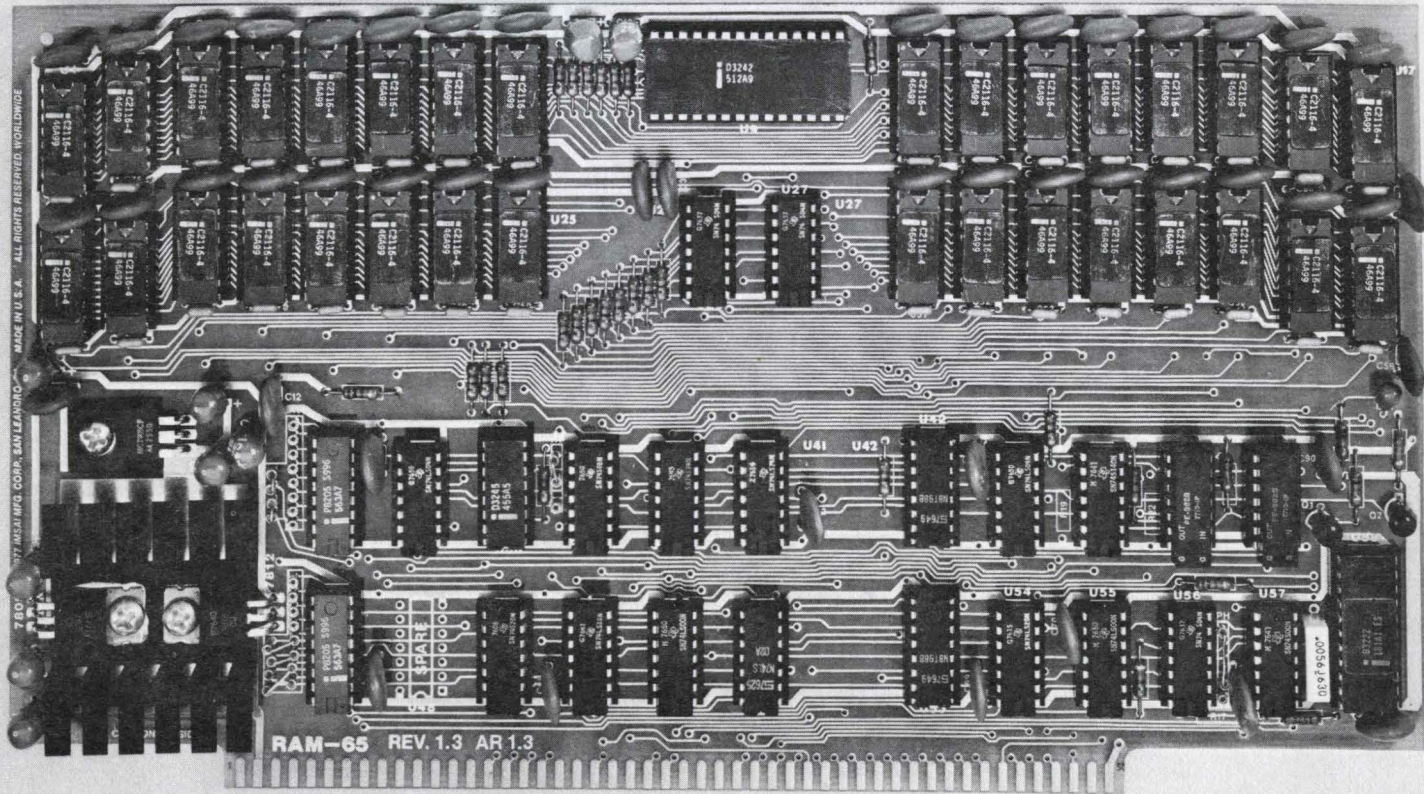

RAM 65K Rev. 1

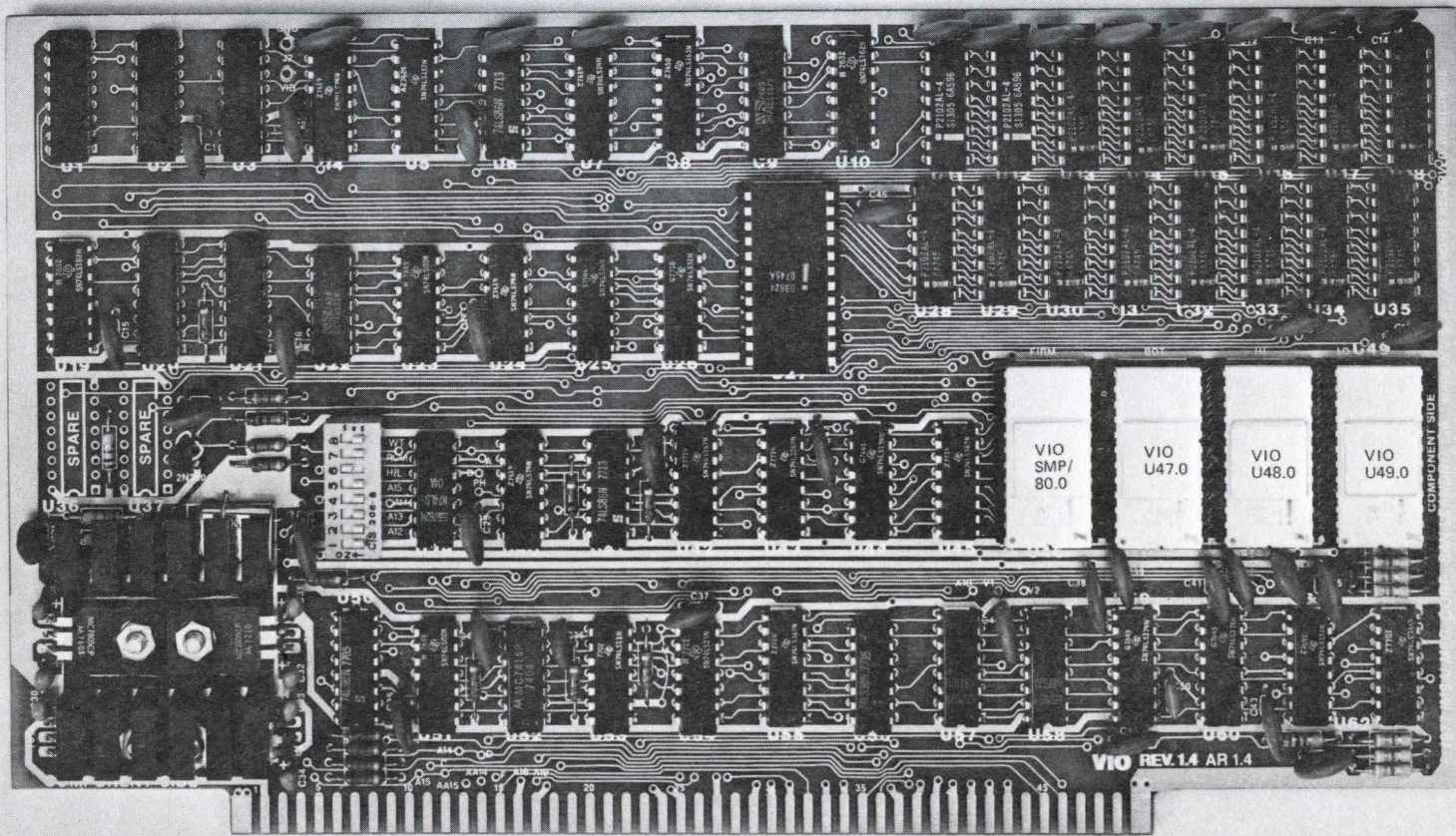

VIO-C

V HOW TO USE YOUR COMPUTER — A GUIDE TO COMPONENT INTERFACING

A. INTRODUCTION TO THE USER GUIDE —
WHICH PERIPHERAL SHOULD YOU BUY?

A. INTRODUCTION — WHICH PERIPHERAL SHOULD YOU BUY

The man-machine interface — the communication link between the user and the computer — presents a number of problems. Data input to the system from the user needs to occur at the greatest possible rate; also, data output from the system to the peripheral device must be accepted at great speed. The problem is further exaggerated as computers do not understand English, but operate in a binary mode (machine language). A computer system must also be cost-effective. What type of peripheral equipment, then, is right for YOU? The following section describes the advantages and limitations of a number of digital input/output units, the languages which can be loaded into the computer using these units, and the instructions for interfacing these units to your PCS-80/15 mainframe.

For data entry and display, you may wish to purchase the IMSAI Intelligent Keyboard (IKB-1), which requires a Video Input/Output Board (VIO-C), and a CRT screen. The VIO-C Board contains the logic and firmware necessary to create and control all CRT screen displays. The VIO-C is capable of displaying up to 1920 alphanumeric and graphic characters and provides for a number of software (program) controlled display options which include:

- 1) 12 or 24 line display pages (to create characters of single or double height)
- 2) 40 or 80 character display lines (to create characters of single or double width)
- 3) full screen blanking (to allow the display to be blanked during screen updates)
- 4) Full screen or character-by-character reverse video (to allow characters to be displayed as light characters on a dark background or as dark characters on a light background)

The character set of the VIO-C allows 256 upper and lower case alphanumeric, punctuation, and graphic characters to be used in creating versatile displays of text, pictures, forms and games. Included on the VIO board are 2K bytes of VIOROM firmware (programs which are embodied in a piece of hardware, i.e., in ROM) to allow the PCS-80/15 to operate with text editing, data entry, and general purpose system commands, acting in conjunction with the ROM monitor on the MPU-B board. The ROM on the VIO-C sets up the necessary conditions to allow the CPU to output information to a CRT.

The IKB-1 (Intelligent Keyboard) is a unique, programmable keyboard console designed around an 8048 control processor, an auxiliary central processing unit used to control keyboard functions, hence the term "intelligent".

The IKB-1 uses a high quality keyboard array, fully debounced (to ensure that a character is printed only once each time a key is engaged), with keys arranged in a standard terminal type layout for operator convenience. In addition, the terminal provides a full N-KEY ROLLOVER (each key stroke is registered regardless of the number of keys pressed simultaneously).

A number of features are programmable both directly from the keyboard and remotely, from the processor. These features provide: 1) serial or parallel interface operation; 2) fully ASCII (see Glossary) encoded outputs (for standard data entry) or unencoded outputs (for games or music applications); and 4) upper/lower case or upper case only operation. The IKB-1 is packaged in a high quality, modular aluminum cabinet and contains an audible beep tone speaker and 3 light-emitting diode (LED) indicators to facilitate user operation.

What are the other peripherals accessible to the small computer owner? A CASSETTE is a magnetic tape cartridge similar to those used in music recording but adapted to the storage of programs and data. Use of the cassette requires a standard audio tape cassette recorder.

Data may also be stored on FLOPPY DISK (or "diskette"): a small magnetic disk resembling a 45-rpm record which is sealed in a plastic jacket about eight inches square. Unlike the cassette, in which data can only be written or read sequentially from beginning to end, the floppy disk is a semi-random access medium. The DISK DRIVE provides for information to be read or written anywhere on the disk in concentric tracks. Any track is rapidly accessible by means of a read/write head which moves rapidly across the disk as it rotates at constant velocity. The diskette, like the cassette, is reusable and can easily be corrected or updated. FLOPPY disks are a versatile medium for handling large volumes of data at rapid rates, making them especially useful in business applications. Data can be entered and recorded on the diskettes at remote locations, such as branch sales offices, then can be mailed or carried to a central location for further processing.

An inexpensive and widely used input/output medium is punched paper tape. It is possible to record any alphanumeric character, as well as a number of special characters, on a continuous roll of paper tape by punching holes in the tape according to a certain code; therefore, any amount of information can be entered into a roll. The information on the tape is sensed by metallic brushes or photocells on the PAPER TAPE READER. As the tape is moved smoothly by a sprocket drive wheel, light shining through the punched-out holes or brush contact through the holes to the metallic surface of the drive wheel beneath the paper tape generates an electrical signal which represents a binary 1.

NOTE: The chips discussed below are not considered peripheral devices in the usual sense but are mentioned here because they are used as program storage devices.

PROM (Programmed Read-Only Memory) chips are factory-programmed memory chips in which an assembler or compiler is stored. PROMs provide extremely rapid access to such often-used programs, and do not require allocation of RAM space for these programs, allowing maximum use of memory capabilities.

Cassettes, floppy disks, paper tapes and PROMs are all MEMORY STORAGE DEVICES which share a common feature: they retain the programs stored in their respective memories when system power is turned off, i.e., their memories are "non-volatile". Two such programs which are of particular interest to us in this section are the ASSEMBLER and the COMPILER.

The ASSEMBLER is a program that directs the computer to operate upon a symbolic language program (such as ASSEMBLY LANGUAGE) and produce a MACHINE LANGUAGE program: a binary-based instruction code, composed of zeros and ones, which is accepted directly by the machine and requires no further translation. Assembly language is a machine-oriented language whose instruction code is often a mnemonic for assembling machine language instructions (i.e., "JMP 30" implies "jump to location 30").

A COMPILER is a program which translates a high-level language program (one written in BASIC or FORTRAN, for example) into a machine language program. BASIC (Basic All-purpose Symbolic Instruction Code) is one of the easiest programming languages to learn; if

IMSAI PCS-80/15
SECTION V-A
USER GUIDE
INTRODUCTION

you are a novice in the area of computer programming, BASIC will serve as an invaluable instructional tool for learning fundamental programming concepts — it is the first programming language with which you should familiarize yourself. FORTRAN (FORMula TRANslator) is another compiler language which was originally conceived for use in scientific computing; it has, however, been adapted for commercial use as well. Refer to elementary tutor textbooks, available in local bookstores, for instruction in BASIC and FORTRAN programming.

As a user, you have the option of loading into your system either commercially-available programs or those which you generate yourself. These programs may be input to the computer by means of a tape cassette, floppy disk, or paper tape; alternately, you may enter programs directly into computer memory by using the keyboard. Since the computer operates in a binary mode, a translating routine (i.e., an assembler, if you wish to program in assembly language, or a compiler, for higher-level language programs) must be entered into computer memory PRIOR to loading of user programs. The only user programs exempt from this procedure are machine-language programs which are entered into memory directly from the keyboard. Assemblers and compilers are available on cassette, floppy disk, paper tape, and PROM chips.

The table below outlines the limitations of the peripheral devices which are available to the user. Refer to the IMSAI Short Form Catalogue and the Domestic Price List enclosed with each kit when choosing your equipment. If you have any questions regarding the choice of an input/output device, call IMSAI for further information.

TABLE V-1
ADVANTAGES AND DISADVANTAGES OF VARIOUS
PERIPHERAL DEVICES

	CASSETTE	FLOPPY DISK	PAPER TAPE	PROM
Cost	Least Expensive	Most Expensive — requires a disk drive	Paper tape is inexpensive but requires a paper tape reader	Expensive
Speed	Fairly slow — information only available serially (1500 baud: bits per second)	Fast random access device 250K baud	Slow — 110 (for Teletype) to 500 baud	Most rapid — no program loading required
User Storage Capacity	Cassette has limited space	High storage capacity — most useful in applications which require the handling of large amounts of data. More versatile storage medium than either cassette or paper tape. Excellent for research or inventory purposes.	Storage of large volumes of data required considerable amount of paper tape	None — cannot write onto PROM
Volatility	Programs loaded from cassette are erased when power is turned off	Although software loaded from disk is lost when power is removed, reloading the assembler or compiler is trivial due to the speed at which this device operates.	Programs Loaded from paper tape are erased when power is turned off	PROM boards provide non-volatile program storage that cannot be changed by the computer or erased when power is turned off. Use a PROM board for storage of programs that are run frequently.

B. USING THE VIO BOARD (WITH CRT)

B) THE VIDEO INTERFACE BOARD (VIO)

1. FUNCTIONAL DESCRIPTION

The IMSAI VIO board provides composite video — picture signal blanking pulse (see Glossary) and the recurrent synchronizing pulses which establish each frame — with a number of visual format options; the board can produce versatile displays of up to 1920 alphanumeric and graphic characters on a video monitor (CRT).

VISUAL FORMATS

The VIO provides for a number of visual format options which may be selected under software control. These options allow for the selection of 40 or 80 character lines, 12 or 24 line pages, full screen or character-by-character reverse video, and full screen blanking.

Maximum display density is achieved through the use of the 80 character by 24 line screen format. Selection of a 40 character line produces double-width characters while the selection of a 12 line page produces double scanned lines (characters of double height). Regardless of format, characters are taken in order from the refresh memory. This preserves the integrity of displayed text when the format is changed.

The VIO defaults to a positive video display (light characters on a dark background). However, the selection of full screen reverse video provides for dark characters on a light background. In addition, character-by-character reverse video may be selected to facilitate the creation of special graphic effects or the highlighting of sections of text.

CHARACTER SETS

Another feature of the VIO is user-programmable character sets ("fonts"). The VIO can support character sets of up to 256 characters. The standard 256 character set supports both upper and lower case ASCII (see Appendix E) and special graphic symbols. Alternately, standard 2708 EPROMs can be used to produce custom fonts of the User's design. When the character-by-character reverse video is selected under software control, the font is restricted to 128 characters, but either half of a 256 character font can be software selected.

Each character in the font is displayed as a 7x10 dot matrix (see the Reference Manual) which includes inter-character and inter-line spacing. This enables the use of graphic characters when producing continuous display segments with no gaps between characters or lines. When the font is restricted to 128 characters, a 5x7 dot matrix with two blank columns between characters and three blank rows between lines is used.

INTELLIGENT TERMINAL FIRMWARE

The 2K bytes of on board VIOROM Intelligent Terminal Firmware allows User Programs to efficiently create extremely versatile screen displays.

VIIOROM Firmware commands allow for:

Cursor control

Controls the position indicator on the video display

X-Y addressable cursor

Control of cursor position by either its X or Y plane rectangular coordinate.

Fully adjustable tab stops

Controls spacing between words or groups of characters. The user can set up and/or clear tab stops on a line basis. Once set, whenever a tab is requested by the appropriate control code, the cursor will automatically skip to the next tab stop (if not within a protected field) or to the first non-protected character following the next protected field.

Field protect/unprotect

Protected field capability is provided for data entry applications. In brief, what this means is that if a certain portion of the screen is declared protected, no character will be written into it and it will not be erased during clearing operations. This allows an applications program to display a "mask" requesting and prompting certain information from the user such as name, address, zip, etc.; as the user inputs such information, the cursor will bypass the fields that request the information.

Direct screen editing

Display wrap-around

Continuation of a read or cursor movement from the last character position in the video display storage space to the first position.

Display formatting

Arrangement of characters, fields, lines, punctuation marks, page numbers, etc.

Mode selection

The monitor can operate in one of three basic modes: alphanumeric mode, graphics mode, or both (when the latter mode is software selected, character-by-character reverse video is lost).

In addition to the firmware driver, the VIIOROM contains a complete system monitor program, IMSAI SMP/80. This monitor allows for keyboard control of all VIO hardware and firmware features plus a number of extremely useful memory and I/O functions. These include:

MEMORY FUNCTIONS:

display memory block

examine and modify memory location

fill memory with specified character

move memory block

search memory for 16 bit masked value

Masking is a technique used to sense specific binary conditions while ignoring others; generally, ones are placed in bit positions to be sensed, and zeros in positions to be ignored.

compare memory blocks

jump to memory location

call to memory location and return

protect/unprotect IMSAI RAM 4A memory blocks

perform memory diagnostics

INPUT/OUTPUT FUNCTIONS:

perform direct I/O to specified port

dump cassette tape to VIO display

Outputs the contents of cassette to video display.

generate sync stream for cassette alignment

(see Section V-D,2)

load cassette file with optional offset

Permits user to load cassette file at an address other than the one specified by the cassette file.

load and execute cassette file with optional offset

load paper tape (Intel Hex format)

PROCESSOR INTERFACE

The VIO board interfaces to the processor (MPU-B) as a block of up to 4K bytes of memory. To provide complete flexibility, the address of this block is switch selectable to allow residence in any 4K byte block of the system memory space.

If the VIO is used with the IMSAI RAM-16, RAM-32, or RAM-65 boards, a separate "phantom" address line, A16, allows the VIO to co-exist with a full complement of memory. The "phantom" channel is a control line which turns memory on and off. When the VIO is selected and the phantom line is driven, the phantom channel denies access to the 4K of memory space required by the VIO to all other devices.

The 4K block itself provides for up to 2K bytes of display character storage and allows the 2K bytes of VIO "Intelligent Terminal" firmware to reside on-board.

CPU control of screen formats is achieved through the use of a memory-mapped command port (logical data path to and from CPU) which resides in the 4K block. The port provides for complete CPU control of VIO functions.

2. CONFIGURATION THE VIO-C FOR THE PCS-80/15

Refer to the VIO Assembly Diagram in the VIO Manual.

- () 1. Remove the VIO-C from the chassis and install a jumper on the VIO-C from the pad labeled "F" (located between areas U51 and U52) to the pad labeled "A16" (located directly below U52).
- () 2. Return the VIO board to the chassis.

The VIO and memory boards are now configured to coexist with one another, if you have jumpered your RAM boards as described in Section IV-A. The VIO will disable the memory boards using address line A16 whenever the VIO is accessed. Note that, in this configuration, the memory boards are not accessible when the VIO board is removed from the computer unless some other provision is made to drive A16 (e.g., using the DISK INPUT/OUTPUT BOARD — DIO).

See the VIO Manual for instructions regarding cable connection between the VIO-C and PCS-80/15 mainframe.

3. USING THE VIO-C

NOTE: This section applies only to those users who own a CRT and an IMSAI Intelligent Keyboard (IKB-1).

a) UNDERSTANDING THE MONITOR

1) INTRODUCTION TO MONITOR OPERATION

At the monitor ENTRY POINT, the display will come up in the default mode:

80x24 screen format
Upper case only
ASCII text mode
Screen scroll mode

Any monitor command may be executed by simply typing the command with any required parameters and then hitting the carriage return key (indicated by @). All monitor commands will appear on the screen display as they are typed.

Any command can be aborted before hitting the CARRIAGE RETURN key by typing a CTL-C (control-C).

All CONTROL CHARACTERS typed on the keyboard will cause the appropriate VIO CONTROL CHARACTER COMMAND to be executed. For example, type a CTL-Z will erase the screen, and CTL-^ will home the cursor to the upper left hand corner of the screen.

Any ESCAPE SEQUENCE typed on the keyboard will cause the appropriate VIO ESCAPE SEQUENCE to be executed. For example, typing an ESC-C will change the number of columns per line on the display. Similarly, typing an ESC-L will change the number of lines per page.

Once a monitor command has been initiated, it may be terminated before execution is complete by typing any key on the keyboard.

See the Reference Manual and the IMSAI PCS-80/30 System Reference Card (which has been inserted at the end of this section) for a complete listing of monitor commands. Remove the card from the manual by tearing along the perforation.

2) CONTROL SEQUENCES:

There are two basic methods of controlling or modifying VIO operations: CONTROL CHARACTER COMMANDS and ESCAPE SEQUENCES.

a) CONTROL CHARACTER COMMANDS

Note that CONTROL CHARACTER COMMANDS will not be accepted when operating in the Graphics Mode (see explanation of Graphics Mode in the discussion of ESCAPE SEQUENCES below).

Carriage Return (@)

causes the cursor to return to position 1 of the current line and forces the overwrite mode (see explanation under Insert Mode below).

Line Feed (key)

causes the cursor to move one line down in the same column position

Up Cursor (CTL-K)

causes the cursor to move one line up in the same column position

Forward Cursor (CTL-L)

causes the cursor to move non-destructively to the right one position. An auto line feed/carriage return occurs at the end of the line.

Back Cursor (CTL-H)

causes the cursor to move non-destructively to the left one position; i.e., a "backspace" function. The cursor will not move past position 1.

Home Cursor (CTL-)

moves cursor to column 1, row 1

Erase Screen (CTL-Z)

fills screen with blanks and homes cursor.

Clear to End of Field (CTL-U)

clears the characters from the cursor to the end of the line or until the existence of the first protected character, whichever comes first.

Tab (CTL-I)

causes the cursor to move to the next tab stop that is not within a protected field or the first unprotected character following the next protected field or the home position, whichever comes first.

Insert Mode (CTL-T)

toggles the system in and out of the insert mode. In the insert mode, any character entered at the cursor causes the remaining characters of the line to be shifted to the right one place. The last character on the line is lost. When not in the insert mode, the system is in the overwrite mode. In the overwrite mode, any new character output just overwrites any previous character in that position.

Delete Line (CTL-D)

deletes the current line indicated by the cursor by moving all lines below the current line up one line and filling in the last line with blanks. The cursor is returned to the beginning of the line.

Enter Line (CTL-E)

all lines from the current line to the end of the screen are moved down one line with the last line being lost. The former current line is then blanked and the cursor returned to position 1.

Protect Fields/Unprotect Fields (CTL-P)

all inverted characters currently existing or subsequently entered are treated as protected fields when the protect mode is active. When inactive, there is no significance to the inverted video other than visual. When protected, these fields will not allow entry of data in most cases and affect such things as tabs and cursor control.

Inverse Character Video (CTL-V)

selects inverse video for the next character position.

b) ESCAPE SEQUENCES

To execute an ESCAPE SEQUENCE, hit the ESC key, and type the appropriate character or characters listed below.

Set/Clear Tab ("I")

Set a Tab stop at the current cursor position or clear an existing tab stop at current cursor position.

Clear All Tabs (CTL-I)

Unconditionally clear all tab positions

ASCII Text Mode ("T")

Standard ASCII Text Mode allows for the display of the 96 character ASCII set. (Character codes 20-7FH may be displayed — see Appendix A of the Reference Manual.) Character-by-character reverse video is available in this mode.

Extended Text Mode ("E")

Extended Text mode currently allows for the display of 96 graphic characters but could be used to display foreign language fonts when the upper half of the character generator ROMs are appropriately programed. (Character codes A0-FFH may be displayed — see Appendix A in Reference Manual.) Character-by-character reverse video is available in this mode.

Graphic Mode ("G")

Graphic Mode allows 255 ASCII and graphic characters to be displayed. (Codes 00-1AH and codes 1C-FFH may be displayed — see Appendix A in Reference Manual.) Character-by-character reverse is NOT available in this mode. Note that new Control Character Commands will not be accepted; however, escape sequences will be accepted.

Scroll Mode Toggle ("S")

Alternately places the screen mode scroll or wrap-around mode. The Text or Extended Text Modes default to the scroll option while the Graphic Mode defaults to the Wrap-Around Option. Note that the scroll option may not be used in the Graphic Mode.

Upper/Lower Case Toggle ("U")

Alternately selects the Upper Case only or Upper/Lower Case display. Defaults to Upper Case only.

Inverse Video Toggle ("V")

Alternately selects positive video (white characters on black background) or inverse video (black characters on a white background). Default is positive video (white on black).

Lines Per Page Toggle ("L")

Alternately selects 12 line pages or 24 line pages. Default is 24 line pages.

Columns Per Line Toggle ("C")

Alternately selects 40-column lines or 80-column lines. Default is 80-column lines.

Addressable Cursor (=YX)

Places the cursor at the position defined by Y-axis (line number) and X-axis (column number). "Y" and "X" are Hex characters. Y-axis and X-axis position codes may be determined from Appendix F in the Reference Manual.

DETAILED INFORMATION CONCERNING MONITOR OPERATION AND MPU-B COMMANDS CAN BE FOUND IN THE VIO MANUAL. A SAMPLE PROGRAMMING PROCEDURE IS LISTED BELOW.

Suppose you wish to deposit some value in a specific location in memory, move the memory block, then verify that the value entered earlier has, indeed, been moved to the new location.

1. Turn the computer on.
2. You are in the monitor when the words "IMSAI MPU-B 2K VERS 1.0" appear on the screen.
3. Type F<D800>,<D87F>,<1F> @ to fill location D800 through D87F with the value 1F (31 in decimal notation). DO NOT TYPE BRACKETS. A prompt (?) will appear on the screen.
4. Type D<D800>,<D87F> @ to display the contents of addresses D800 through D87F. The screen will come up in a 16 column by 8 row format displaying the value "1F".
5. Type M<D800>,<D87F>,<D880> @ to move 1F to a new memory block beginning at location D880. A prompt (?) will appear on the screen.
6. Type D<D880>,<D900> @ to display the contents of addresses D880 through D900. The screen will display the value 1F in a 16 column by 8 row format.

NOTE: If your specifications cause the screen to fill, HIT THE SPACE BAR in order to clear the screen and continue data display.

C. USING THE INTELLIGENT KEYBOARD (IKB-1)



The Intelligent Keyboard (IKB-1)

C. USING A KEYBOARD

1. FUNCTIONAL DESCRIPTION

KEYBOARD: The IMSAI Intelligent Keyboard (IKB-1) utilizes a high quality, 55 key mechanical contact keyboard for high reliability. All keys are fully debounced, and the keyboard provides full N-KEY ROLLOVER: each key stroke is registered regardless of the number of keys pressed simultaneously. Continuous depression of a key will invoke an auto repeat function, causing a character to be output continuously until the key is released. Standard alphanumeric and control keys are arranged in a typewriter type layout.

SERIAL/PARALLEL OPERATION: The keyboard may be configured to operate as a parallel OR serial input device. The parallel mode supports a full 8-bit parallel format with RDY (READY) and ACK (ACKNOWLEDGE) handshaking. "Handshaking" refers to an exchange of predetermined signals when a connection is established between two devices. The serial mode supports both EIA and TTL levels (see Glossary). Serial baud (bits per second) rates are selectable by keyboard commands and allow for the selection of six separate rates from 110 - 2400 baud.

ENCODED/UNENCODED MODES: User or system CPU programming allows the keyboard to operate in encoded or unencoded modes. Selection of the encoded mode allows the keyboard to output standard ASCII code, while the unencoded mode gives the user a raw map of the keyboard array allowing multiple key depressions to be used for games, music, etc.

TAB STOPS: Tab stops are fully adjustable and may be set or cleared directly from the keyboard.

KEY PROGRAMMING: Individual keys may be reprogrammed to output any given ASCII character.

SHIFTLOCK - UPPER/LOWER CASE: The keyboard may be programmed to operate in upper case only (shift lock) or in upper and lower case.

CABINET: The cabinet is constructed of high quality aluminum and is finished in an IMSAI System compatible blue. The cabinet houses the keyboard, an audible beep tone speaker and 3 LED indicators. The LED display indicates entry into the program mode, shift mode (upper/lower case), or shift lock mode (upper case only).

EXTERNAL CONNECTIONS: A 25 pin D-type connector provides for the +5V power and computer interface connection. Interface lines are completely compatible with the IMSAI MIO and SIO interface boards. An additional 15 pin D-type connector allows an external keypad to be used.

2. HOW TO INTERFACE YOUR KEYBOARD TO THE PCS-80/15

CABLE C is a 5-foot ribbon cable which carries signals between the rear of the computer mainframe and keyboard. The cable has a male 25-pin EIA-type connector at each end.

One end of the cable has been attached to the terminal at the factory. The other end of Cable C attaches to the rear panel of the mainframe as follows:

- () 1. Identify the female 25-pin EIA-type connector which has been screwed to the back panel of the mainframe. (This connector is attached to Cable AF which would carry signals between the rear of the PCS-80/15 cabinet and the MPU-B board.)
- () 2. Plug the free end of Cable C into the female connector protruding from the rear of the mainframe.

CABLE CONNECTION IS COMPLETED.

3. KEYBOARD OPERATION

NOTE: Since the keyboard may be used as a serial or parallel device, it is important that the circuit board jumpers be properly configured for the type of hardware interface to be used. Assembled units are shipped already jumpered as parallel devices, and most users will wish to retain this configuration. Experienced users, wishing to configure the keyboard for serial operation, should refer to the Keyboard Manual for further details.

a) THE KEYS

In addition to the displayable character keys, the 1KB-1 contains a number of other keys for various terminal and system control functions. (The space bar is considered a displayable character key.)

BACK SPACE non-destructively moves the cursor one character position to the left

BREAK a provision used only in serial mode; therefore, not applicable to most users. This feature permits the keyboard to interrupt transmission (usually telephone communication) and take control of the circuit.

CTL (CONTROL) this key, when held down while typing another key, modifies the code pattern of the typed key.

END ENTRY depressing this key terminates Program Mode and allows user to enter Data Entry Mode: the standard mode of operation to input data to the computer. (Program Mode and Data Entry Mode are described below in greater detail.)

ESC (ESCAPE) when combined with succeeding characters, generates an escape sequence and the development of additional data communications control operations.

FLAG 1 does not transmit code to the computer, but sets the high-order bit of any character sent out from the terminal. May be used in advanced software applications to mark a particular character sent to the computer (using inverse video), or to generate special characters from the keyboard when in graphics mode.

LINE FEED cursor down; causes the display to scroll upward one line, leaving the cursor positioned in the same place on the next bottom line.

MODE depressing key allows user to enter Program Mode and select keyboard options described below.

RETURN moves the cursor to the first character position of the present line.

RUBOUT not effective when monitor is in use; when key is depressed twice, the cursor moves to the next line and a prompt is issued. When CP/M is in use (see Section V-E,1-b), the key transmits a non-displayable rubout code to the processor to effect deletion of a previous character.

- SHIFT either of the two SHIFT keys is held down while typing another key to generate upper case alphabetic characters or to generate the character shown in the upper portion of a typed key.
- SHIFT LOCK locks the SHIFT key until SHIFT LOCK is depressed a second time. Puts user in UPPER CASE ONLY mode.
- TAB this key transmits to the computer a code used to separate words or groups of characters

b) KEYBOARD OPTIONS

The keyboard will operate in two basic modes of operation: PROGRAM MODE and DATA ENTRY MODE. The program mode allows the keyboard options to be programmed either directly from keyboard commands or from an output port. The data entry mode is the standard data input mode of operation and allows data to be entered to the computer. Keyboard operation in the data entry mode is determined by the option selected in the program mode.

PROGRAM MODE (FROM KEYBOARD)

The keyboard options may be programmed directly from keyboard commands. Programming is initiated by depressing the "MODE" key located in the upper right corner of the keyboard. The keyboard will verify entry into the program mode with an audible beep, and the PROG LED will light.

Once the keyboard is in the PROGRAM mode, a valid command typed on the keyboard will select a particular keyboard option. A number of commands may be typed in sequence to select more than one keyboard option where applicable. The last character of each valid command will be confirmed with an audible beep.

When all features have been selected, the program mode is terminated by pressing the "END ENTRY" key located to the left of the "MODE" key. Once the keyboard options have been selected and the END ENTRY key has been depressed, the keyboard will operate in the DATA ENTRY MODE.

Valid commands are as follows:

- RQ places the keyboard in parallel mode
- R1 selects 110 baud serial output
- R2 selects 150 baud serial output
- R3 selects 300 baud serial output
- R4 selects 600 baud serial output
- R5 selects 1200 baud serial output
- R6 selects 1800 baud serial output
- R7 selects 2400 baud serial output

NOTE: See the Keyboard Manual for instructions concerning the jumpering of the keyboard for serial output.

- D selects DEFAULT MODE ...
Parallel outputs; upper case only; encoded outputs
- E sets the keyboard in normal ENCODED mode
In this mode, the keyboard is scanned using an N-key Rollover algorithm and characters are output in Standard ASCII format; any key or sequence of keys typed on the keyboard or external keypad (optional) will cause the corresponding ASCII code to be sent to the computer. In the encoded mode, continuous depression of a key will invoke the AUTO REPEAT function, causing the character to be output continuously until the key is released.
- U selects UPPER CASE ONLY mode
Operation is similar to TTY keyboard. All alphabetic character output in upper case. Shift key controls upper case for all non-alphabetic characters. Selection of the "U", upper case only option, will cause the SHIFTLOCK LED to light.
- L enables LOWER CASE characters
Operation is similar to typewriter keyboard. SHIFT key controls upper case for all characters. SHIFTLOCK key will lock all alphabetic characters to upper case. SHIFTLOCK may be released by depressing the key a second time.
- SAB substitutes any ASCII character, B, for any other ASCII character, A
The keyboard will output the character, B, whenever the key, A, is typed. The resulting character, B, is unaffected by "CTL", "SHIFT" or "FLAG". To cancel the current substitution, type "S" followed by two blank spaces.
- V places the keyboard in verbatim or unencoded mode
When the END ENTRY key is depressed, the keyboard will start outputting a continuous stream of bytes providing the user with a continuously updated map which indicates the state of the keyboard array. This information may be used to transmit multiple key depression information for music or games. Each key, when depressed, causes a continuous stream of 1's to be transmitted to the CPU. Keys which are not depressed output continuous strings of zeros to the CPU. Thus the computer is provided with uninterrupted data concerning the state of the keyboard. For details of the unencoded format see the appropriate section in the Reference Manual.

PROGRAM MODE (FROM COMPUTER)

The keyboard is configured for parallel operation with the IMSAI MPU-B (see Section V-C,2 for instructions concerning cable attachment between IKB-1 and MPU-B). Programming is achieved by outputting a series of bytes to the keyboard. Programming from the computer, the experienced user can write an Assembly Language program to

- beep the speaker;
- place the keyboard in default mode;
- set the lower case mode; and
- select unencoded (verbatim) mode.

Refer to the Keyboard Manual for details concerning the Program Mode.

c. CONTROLLING THE SCREEN

NOTE: This section pertains to those users who own a CRT.

1) SELECTION OF UPPER OR LOWER CASE CHARACTERS

NOTE: Both keyboard AND VIO must be programmed in order to select character type.

FOR SELECTION OF UPPER CASE CHARACTERS:

1. Turn the computer on.
2. The computer comes up in UPPER CASE MODE; proceed with keyboard programming as described in Step 3.
3. Depress the "MODE" key. The keyboard will verify entry into the program mode with an audible beep, and the PROG LED will light.
4. Type U to select UPPER CASE alphabetic characters. (The SHIFT key will access characters in the upper portion of the terminal keys.)
5. Hit the END MODE key. The keyboard is now programmed for UPPER CASE.

FOR SELECTION OF UPPER AND LOWER CASE CHARACTERS:

1. Turn the computer on.
2. Hit ESC, then type U. You are in UPPER AND LOWER CASE mode. Programming of the computer is now completed; proceed with keyboard programming described in Step 3.
3. Depress the "MODE" key. The keyboard will verify entry into the program mode with an audible beep, and the PROG LED will light.
4. Type L to select UPPER CASE AND LOWER CASE alphabetic characters. (The SHIFT key will access characters in the upper portion of the terminal keys.)
5. Hit the END MODE key. The keyboard is now programmed for UPPER AND LOWER CASE.

NOTE: If you wish to enter UPPER CASE mode at this point, do the following: type ESC U again to reprogram the computer, then re-enter program mode from the keyboard, type U, then hit the END MODE key.

2) CONTROLLING THE NUMBER OF LINES PER PAGE
(CHARACTER HEIGHT)

Enter the monitor
(display in default mode comes up 24 lines per page)

Hit ESC, then type L
(display changes to 12 lines per page of double-height characters)

Hit ESC L again
(display reverts to default mode)

3) CONTROLLING THE NUMBER OF CHARACTERS PER LINE
(CHARACTER WIDTH)

Enter the monitor
(display in default mode comes up 80 columns per line)

Hit ESC, then type C
(display changes to 40 double-width characters per line)

Hit ESC C again
(display reverts to default mode)

4) REVERSING BACKGROUND/CHARACTER TONE

Enter the monitor

Hit ESC key, then type V
(default mode - white lettering on black background - reverses to black lettering on white background)

Hit ESC V again
(character/background tone will revert to default mode)

(For detailed information regarding Mode Selection, Advanced Graphics Displays, and program control of cursor movement, refer to the VIO Manual.)

IMSAI PCS-80/30 SYSTEM REFERENCE CARD

PCS-80/30 MONITOR

BOOTSTRAP LOADERS

- * B Load DOS from disk
- H Load INTEL Hex format paper tape
- L $\langle \text{start} \rangle, \langle \text{end} \rangle, \langle \text{exec} \rangle$ Load cassette file

EXECUTE COMMANDS

- J $\langle \text{start} \rangle$ jump to memory
- * K $\langle \text{start} \rangle$ jump to memory, switch out MPU-B ROM/RAM
- C $\langle \text{start} \rangle$ call to memory
- X $\langle \text{start} \rangle, \langle \text{end} \rangle, \langle \text{exec} \rangle$ load file from cassette and execute
- * Q jump to VIO monitor and switchout MPU-B ROM/RAM
- \uparrow C jump to VIO monitor

I/O FUNCTIONS

- I $\langle \text{port} \rangle$ input from port
- O $\langle \text{port}, \text{hex data} \rangle$ output data to port
- * R $\langle \text{track} \rangle, \langle \text{sector} \rangle, \langle \text{buffer} \rangle, \langle \text{unit} \rangle$ read track sector drive in to RAM
- * W $\langle \text{track} \rangle, \langle \text{sector} \rangle, \langle \text{buffer} \rangle, \langle \text{unit} \rangle$ write track, sector, drive from RAM
- * Z $\langle \text{baud rate} \rangle$ set baud rate
- * Z Auto set baud rate
- * N $\langle \text{address} \rangle$ set disk command string
- * N set default disk command
- * Y $\langle \text{address} \rangle$ set I/O RAM
- * Y set default I/O RAM

MEMORY COMMANDS

- D $\langle \text{start} \rangle, \langle \text{end} \rangle$ display contents of RAM
- E $\langle \text{address} \rangle$ examine address
- $\langle \text{space bar} \rangle$ continue,
- $\langle \text{left arrow} \rangle$ back up, $\langle \text{hex value} \rangle$
- F $\langle \text{start} \rangle, \langle \text{end} \rangle, \langle \text{hex} \rangle$ fill memory with value
- M $\langle \text{start} \rangle, \langle \text{end} \rangle, \langle \text{dest} \rangle$ move memory block
- S $\langle \text{start} \rangle, \langle \text{end} \rangle, \langle 16 \text{ value} \rangle, \langle \text{mask} \rangle$ search memory for 16 bit value
- V $\langle \text{start} \rangle, \langle \text{end} \rangle, \langle \text{dest} \rangle$ compare memory blocks
- P $\langle \text{start} \rangle, \langle \text{end} \rangle$ protect RAM 4-A memory
- U $\langle \text{start} \rangle, \langle \text{end} \rangle$ unprotect RAM 4-A memory

TEST FUNCTIONS

- T test all memory
- T $\langle \text{start} \rangle, \langle \text{end} \rangle$ test memory
- G generate sync stream
- A align

VIO TERMINAL

ESCAPE SEQUENCES

- =XY direct cursor (0 at 20Hex)
- C change columns displayed 40/80
- L change lines displayed 12/24
- S set scroll/wrap around mode
- U upper case only/upper and lower case
- V reverse screen video
- I set/clear tab stop at cursor
- \uparrow I clear all tab stops
- T select lower half of character set
- E select upper half
- G select both halves

GENERAL

- \uparrow P begin/end protected field
- \uparrow Z erase screen

CURSOR

- \uparrow K up
- \uparrow L right
- \uparrow H left
- \uparrow J down
- \uparrow M home
- \uparrow I tab

EDITING

- \uparrow E enter line
- \uparrow D delete line
- \uparrow T insert character
- RUB erase character
- \uparrow U erase to end of field
- \uparrow V inverse character video

VIO GRAPHICS MODE

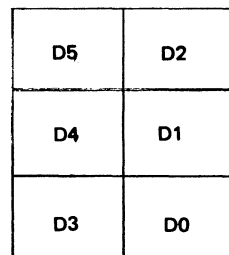

D6=~~0~~, D7=1

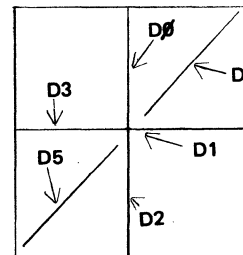

D6=1, D7=1

IKB-1

USER PROGRAMMABLE COMMANDS

(press "MODE KEY" then commands, then "END ENTRY")

- RQ set keyboard to parallel mode
- R1 set 110 baud
- R2 set 150 baud
- R3 set 300 baud
- R4 set 600 baud
- R5 set 1200 baud
- R6 set 1800 baud
- R7 set 2400 baud
- D default (encoded, upper only, parallel)
- E encoded mode
- U upper case only
- L upper and lower case
- SAB substitute B for A
- V unencoded mode

ADDRESSES

MPU-B

- Monitor D800-DFFFH
- RAM D000-D0FFFH
- Counters D100-D103H
- I/O RAM D0FA-D0FCH
- Disk Command 80H

PORTS

MPU-B

- Parallel 14-15
- Serial 12-13, 4-5
- System 2-3
- Control F3

VIO

MPU-B CONTROL PORTS

- Refresh RAM F000-F7FFH if D0=0 2K ROM at 0 enabled
- Command byte F7FFH if D0=1 System RAM at 0 enabled
- Initialization F800H if D1=0 2K ROM at D800 enabled, RAM, timers
- Character Output F803H if D1=1 System RAM at D000 enabled
- Monitor Entry F806H
- Echomode entry F809H

KEY:



optional
refers to MPU-B only
CTL key

D. USING AN AUDIO CASSETTE

D. IF YOU WISH TO USE A CASSETTE PERIPHERAL:

NOTE: This section is pertinent to those users who have a CRT and keyboard.

1. WHAT YOU NEED TO BUY

a) Hardware

Audio Cassette Deck (any high quality tape cassette recorder equipped with an auxiliary input jack)

IMSAI Multiple Input/Output (MIO) board —
provides a data transfer interface to a standard audio cassette recorder

Cable M set — (connects the MIO to the back panel jacks)

Standard Patch Cable —
to connect the tape recorder to the back panel; available in any stereo shop.

b) Software

1) If you program in ASSEMBLY LANGUAGE you will need to purchase:

PGM-2A

the tape cassette operating system (TCOS). Use of this system requires at least 4K bytes of RAM. This package includes features for reading and writing files stored on a tape cassette, and for loading programs from the cassette. TCOS contains an Executive (a routine which controls loading and relocating of other routines) to handle memory files, an Assembler, a line-oriented editor (see Glossary) and Tape I/O commands.

2) If you program in BASIC, you will need to purchase:

BASIC 8A

an interpreter for a compact, yet powerful, version of BASIC which requires only 8K bytes of memory. An additional minimum 1K bytes are required for the user's program. A brief specification follows:

Statements:

IF ... THEN
READ
DATA
INPUT
PRINT
LET
GOTO
GOSUB
RETURN
FOR
NEXT
RESTORE
REM

RANDOMIZE
STOP
END
ON ... GOTO
ON ... GOSUB
DIM CHANGE
DEF
OUT

Commands:

CONTINUE
LOAD
CLEAR
SCRATCH
LIST
NEW
RUN

Functions:

RND
SQR
ABS
INT
SGN
INP
TAB
SIN (radians or degrees)
COS
TAN
CSC
SEC
COT
ARC/SIN or ASN
ARCCOS or ACS
ARCTAN or ATN
LOG (base e or base 10)
EXP
LEN
VAL
ASC or ASCII
LEFT\$
RIGHT\$
MID\$
CHR\$
INSTR\$
SPACES
NUM
STR\$ or STRINGS
+ (string concatenate)

Operators:

+
-
^
*
/

Other features include:

IF ... THEN may be followed by any statement
even another IF. For example,

IF A=B THEN PRINT A, B

Handles strings, string vectors and arrays with
length to 255 characters

Handles multiple statements per line,
separated by /.

Statements, commands and functions can be
abbreviated to three characters.

\$ may be omitted from string functions.

OUT will write to any IMSAI 8080 port; IN will
read a byte.

OR

BASIC 9A

A 9K high-level language which includes BASIC 8A features plus supports tape
cassette source program storage.

(NOTE: An IMSAI FORTRAN package for use with cassette tape is not available at
this time.)

2. LOADING PROGRAMS

a) INTERFACING YOUR NEW HARDWARE TO THE PCS-80/15 MAINFRAME:

Setting Up the MIO Board

The MIO board may be purchased in either kit or assembled form. What follows are the instructions for interfacing an ASSEMBLED board to your cassette machine. A photo jumper and assembly diagram are included in this section to aid in preparing your MIO for use with audio cassette deck.

NOTE: A roll of wire is supplied with your MIO board. In the following steps, "jumper" means "cut an appropriate length of wire and insert WITHOUT SOLDERING into the eyelets" at the locations illustrated in Figure V-1 by thick black lines.

INSTALLING JUMPERS

- () 1. Locate the L-shaped box next to area C17 in Figure V-1. Jumper at the eight locations (0-7) as indicated in the box.
- () 2. Jumper at the two locations indicated in area U44.
- () 3. Locate the box between U17 and U48. Install one jumper wire as indicated.

CABLE CONNECTIONS

The cables which connect the MIO board to the rear of the computer mainframe chassis are installed next. Reference to the MIO Assembly Diagram will aid cable connection. An Assembly Diagram for Cable M is also included in this section.

- () 1. The cable subserving cassette output to the computer is attached in the following manner: The RED lead is inserted in the large socket immediately to the left of R27. The BLACK, or ground, connection is made immediately below the red one (above the designation, "CR1 INPUT" on the Assembly Diagram).
- () 2. The second cable in the set subserves output to the cassette deck from the MIO. The BLACK pin is inserted into the socket immediately to the left of the designation, "CR1 OUTPUT" above location U8. The RED signal lead is attached below the black one, to the right of the letter "S" on the diagram.
- () 3. Install the MIO board into an empty edge connector on the motherboard. If no slots are available, carefully remove the motherboard from the chassis, being certain to FIRST remove all PC boards which are plugged into the motherboard and to detach all power connections which hinder removal of the motherboard. (Detach the two white plastic Molex connectors at the front of the motherboard from their cradles, and slide the ground and power connections off the tabs located along the sides of the EXP-10. There are seven tab-style power connectors on the left edge of the EXP-10 and four ground connections along the right-hand edge of the board. You may wish to use a screwdriver to aid in sliding the tabs apart.) Refer to Section III-C for instructions relating to installation of edge connectors on the EXP-10.

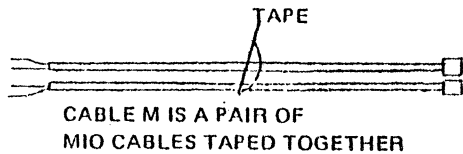

REVISIONS				
LTR	DESCRIPTION	DATE	APP	ID
0	ORIGINAL	12/76	ajk	
1	MOD. SHRINK TUBING SPECS. ECN 76-0067	12/76		
2	ADDITION JACK DETAIL MISC. ADD'L CALLOUTS FOR CLARIFICATION ECN 77-0037	1/77	msj	

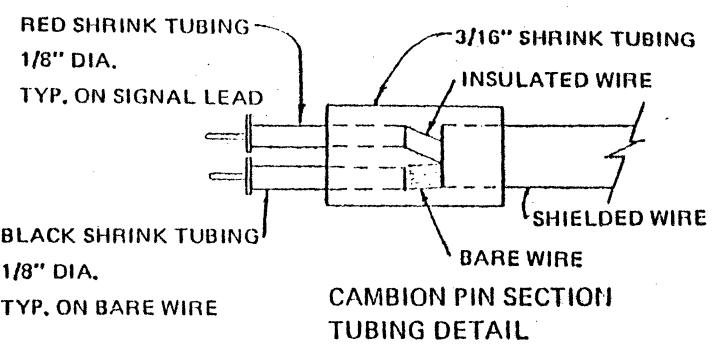
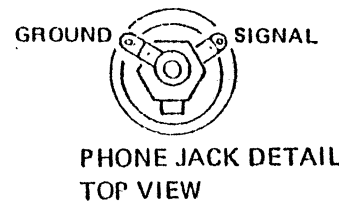
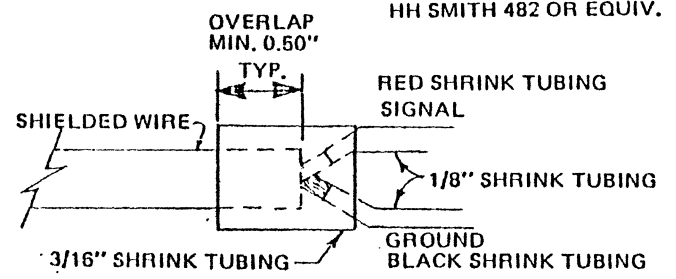
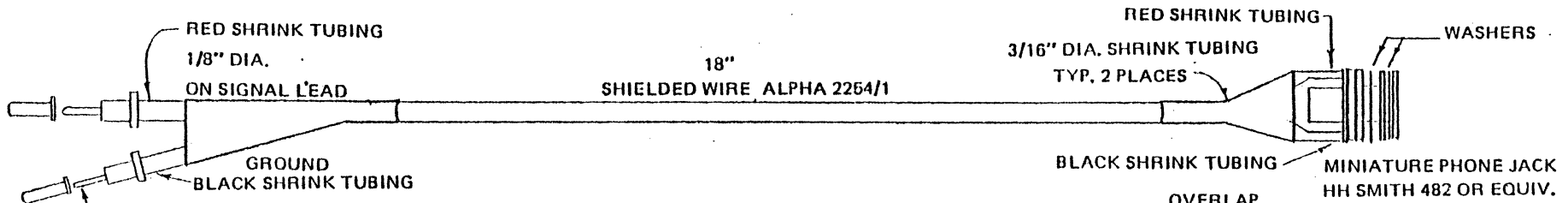

© 1977 IMSAI MFG. CORP.
SAN LEANDRO, CA.
ALL RIGHTS RESERVED WORLDWIDE
MADE IN U.S.A.

TOLERANCES UNLESS OTHERWISE SPECIFIED		© 1976 IMSAI MFG. CORP. SAN LEANDRO, CA.	
FRACTIONS	DEC	ANGLES	
±	±	±	
APPROVALS	DATE	MIO CABLE M ASSEMBLY	
DRAWN PRU	10/15/76		
CHECKED J.C.	12/6/76		
SCALE	SIZE	DRAWING NO. 91-040017	
		91-040017	
DO NOT SCALE DRAWING		SHEET 1 OF 1	

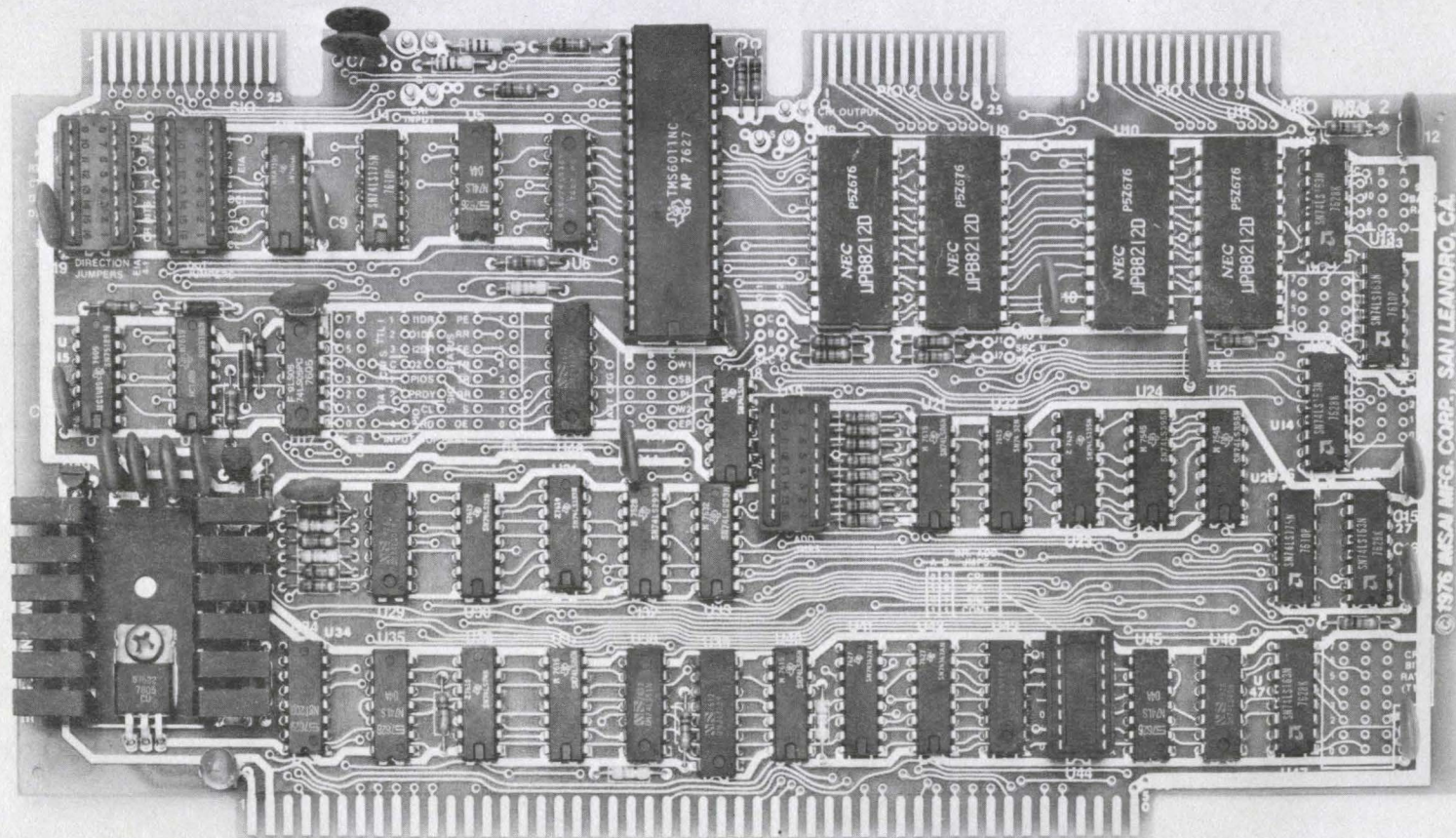

© 1976 INSAI MFG. CORP., SAN LEANDRO, CA.

REVISIONS			
LTR	DESCRIPTION	DATE	APPROVED
0	ORIGINAL MIO REV. 2	11/76	ajk
1	ECN 77-0012, 77-0004	2/77	
2	ECN 77-0062	5/77	

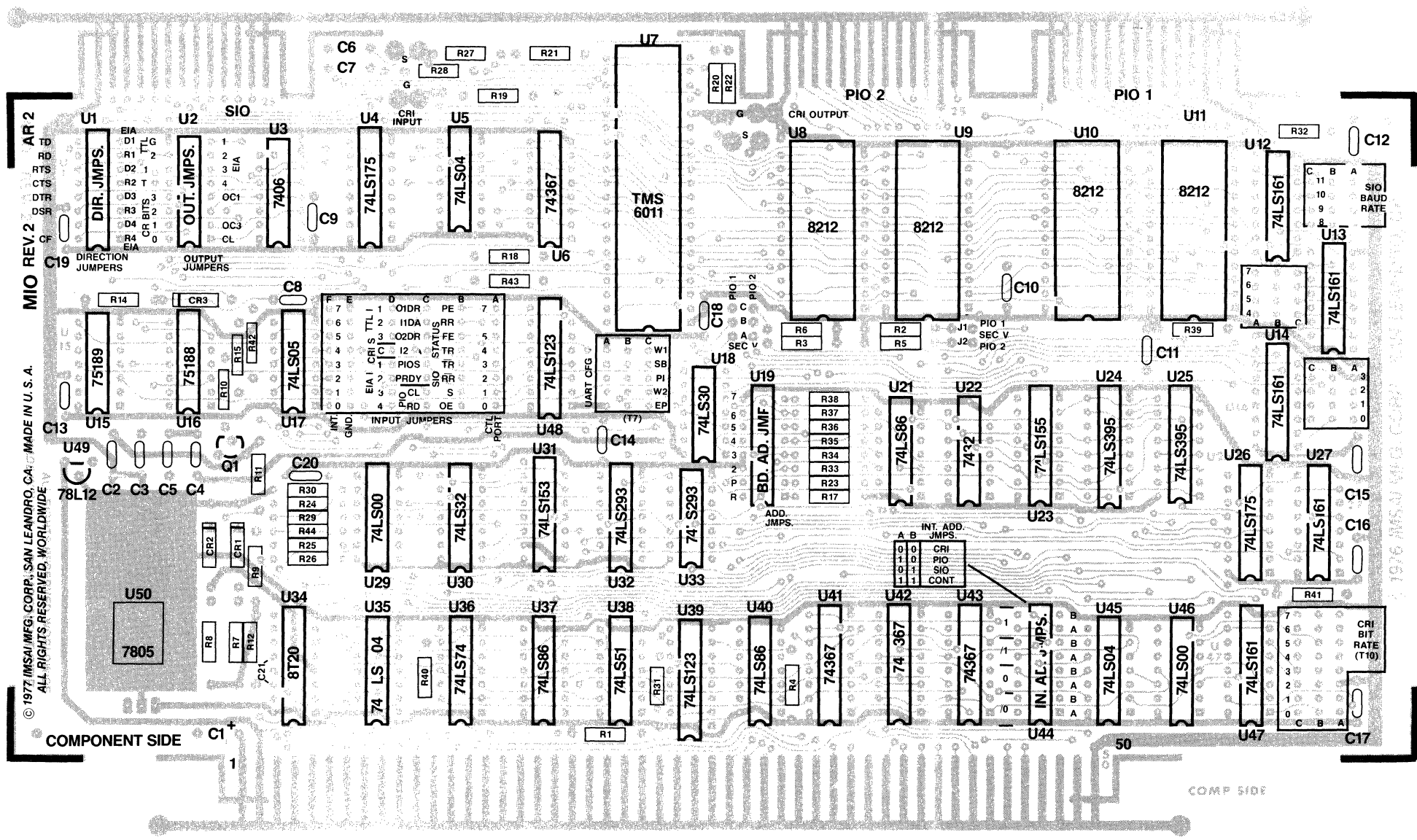

NOTES:
 U1, U2, U19 & U44 are with 16 pin sockets.
 U7 is a TMS 6011.
 U12, U13, U14, U27 & U47 are 74LS161 or 74LS163.
 U39 & U48 are 74LS123 or 74123.
 Capacitors are .1uF unless noted below.
 C1 is 33uF.
 C6 & C7 are .02uF.
 C21 is 10 pF. C21 is on circuit side of board.
 Resistors are 1/4 watt unless noted.
 R1, R4, R24 & R43 are 36K.
 R2, R3, R5, R6, R17, R18, R23, R25, R26 & R31 through R41 are 1K.
 R7 is 56 1/2 watt.
 R8 is 470 1/2 watt.
 R9 & R15 are 1.2K.
 R10, R12 & R29 are 470.
 R11, R19, R21, R42 & R44 are 10K.
 R14 is 330.
 R27 & R28 are 100.
 R30 is 220.
 Diode CR1 is 1N4742.
 Diode CR2 is 1N751A.
 Diode CR3 is 1N914.
 Transistor Q1 is 2N3906.

AR 2
 MIO REV. 2
 © 1977 IMSAI MFG. CORP., SAN LEANDRO, CA. MADE IN U.S.A.
 ALL RIGHTS RESERVED, WORLDWIDE

TOLERANCES UNLESS OTHERWISE SPECIFIED FRACTIONS DEC. ANGLES ± ± ±		© 1977 IMSAI MFG. CORP., SAN LEANDRO, CA. ADD © 1977	
APPROVALS		MIO REV. 2 11/76 ASSEMBLY DIAGRAM	
DATE		SCALE	SIZE
DRAWN DNN 11/10/76		DRAWING NO.	B
CHECKED JA 11/12/76			
DO NOT SCALE DRAWING			
			SHEET

- () 4. Install the phone jack at the opposite end of the cable installed in Step 1 through any unused circular cut-out on the back panel of the chassis. Position each piece of hardware as shown in the sketch below. The jack exits the inside of the chassis and protrudes through the back panel to the outside. The insulating plastic ring with the shoulder fits over it inside the back panel. Firmly tighten the hardware.

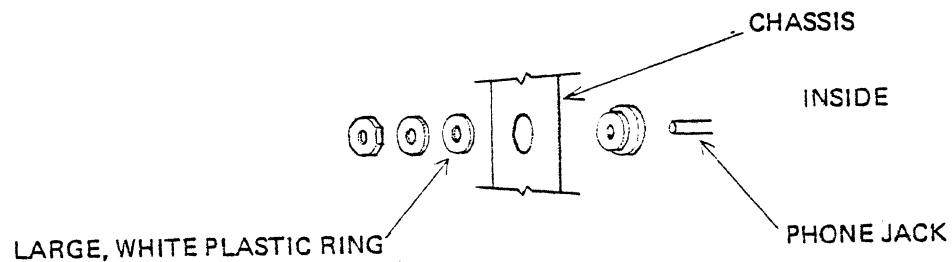

- () 5. Another cable (usually supplied with your tape machine) must be connected from the speaker (EXT SP) or EARPHONE output of your cassette recorder to the cable installed in Step 4.
- () 6. Repeat the procedure outlined in Step 4 for the cable installed in Step 2.
- () 7. Another cable (not supplied by IMSAI) must be connected from the cable installed in Step 6 to the auxiliary (AUX) input to your cassette machine. On some machines, which do not contain an auxiliary input, it is sometimes possible to use the microphone (MIC) input instead. However, this procedure may result in overloading the tape recorder, as microphone inputs are designed to accept much smaller signals than those generated by the MIO board.

CASSETTE RECORDER ADJUSTMENT

NOTE: The instructions concerning cassette recorder adjustment apply only to those users who have purchased a CRT and IMSAI VIO-C board.

Necessary adjustments involve finding the proper volume settings for recording and reading back data, and setting the MIO interface so that it reads and writes in the proper phase. The VIO monitor (embodied by firmware on the VIO-C) includes software containing a "sync stream generator", which transmits characters to your cassette to establish synchronous communication between the MIO and tape machine. The IMSAI MIO cassette interface uses software that detects special Hex characters, hereinafter called "sync characters" (see Glossary). The sync stream generator sends a continuous stream of sync characters to the cassette for recording. The sync stream tape thus evolved can subsequently be used to adjust the volume and tone controls of your cassette recorder to insure error free input at any baud rate (baud = bits per second) within the range of your particular tape recorder.

IMSAI supplies an MIO TEST TAPE with each MIO board. The test tape contains approximately ten minutes of a pre-recorded sync stream, one minute of header (which has a spacing function and can be identified by its high-pitched tone) and the test

IMSAI PCS-80/15
SECTION V-D
USER GUIDE
CASSETTE

programs listed in Appendices B and C of the IMSAI MIO User's Manual (for use with front panels containing a switch bank). Side Two of the test tape is blank.

Cassette adjustment involves use of the test tape followed by generation of a sync stream on a BLANK cassette (using the appropriate monitor command).

- () 8. Turn on the computer.
- () 9. You are in the monitor when the words "IMSAI MPU-B 2K VERS 1.0 appear on the screen.
- () 10. Load the IMSAI MIO TEST TAPE (Side 1) into your cassette recorder, and turn the recorder on. The test tape contains the pre-recorded sync stream.
- () 11. Set the tone control on your recorder for best high frequency response. Turn the volume to a middle position.
- () 12. Depress the "PLAY" button on your recorder.
- () 13. Type A@. The upper one-quarter of your screen should fill with inverted (black on white) LOWER CASE "f"s.

The alignment routine you have just entered reads characters from the cassette tape and dumps them directly into the refresh memory of the video board causing them to be displayed directly on the screen. The monitor searches the sync stream bit by bit, until it locates the first sync character: E6 (hexadecimal) or, in binary, 11100110. The alignment routine begins reading the tape following detection of E6 and the sync character is displayed on the CRT. Thus, by looking at the screen with the help of an ASCII Code Table, the tape actually can be read by the user.

When an E6 is detected and placed in the refresh memory, an inverted (black on white) LOWER CASE "f" appears on the screen. The VIO hardware scans the refresh memory for E6; once the sync character is recognized the character field is inverted if the high order bit is a "1", and the resulting character (01100110 or in hex, 66H) is displayed on the screen. If we look at the ASCII Code Table (in the VIO Manual) we find that a lower case "f" is encoded by the character 66H. Using the "A" command to read an MIO Test Tape (or a tape generated with the "G" command — see below) dumps (lists the contents of memory) what should be a continuous stream of inverted lower case "f"s. The volume and tone controls, and possibly the phase jumper on the MIO board (see Step 14), should be adjusted until only inverted lower case "f"s appear on the screen.

NOTE: Your screen may fill with characters other than inverted lower case "f"s. You may, for example, see inverted upper case "M"s or a graphic pattern. Your cassette machine is properly adjusted so long as the CRT displays a stream containing ONLY ONE graphic or alphanumeric character. The computer may lose a few bits of the sync stream during the adjustment of volume and tone; i.e., several bits of the string 11100110 ... 11100110 ... may be disregarded and only part of the string "recognized" as a valid sync character. If, for example, a high order bit (1) is lost, 11001101 may be

detected as the sync character; inversion of the high order bit yields 01001101 or 4DH (hex). The ASCII Code Table shows 4DH to be the code for an upper case "M".

If no characters appear on the screen, see Step 14. If your machine appears to be properly aligned, proceed to Step 16.

- () 14. If no characters appear on the CRT screen, the READ phase jumper on the MIO board must be adjusted. The flux reversals of the recording pulse used to generate the test tape often will be out of phase with the playback electronics. TURN OFF THE COMPUTER. Unplug the MIO from the motherboard. A black rectangular plastic box (a "header") is included with your MIO board; refer to Figure V-1 and plug the header into the socket at UT9. Locate the box labeled "Polarity Select Jumpers" and SOLDER a piece of wire across the two header pins as indicated in the figure. Return the MIO to the chassis.
- () 15. Repeat Steps 8 through 13.

The instructions which follow outline the procedure for generating your own sync stream on a blank cassette.

- () 16. Hit ANY key on the keyboard (in order to exit the "A" command).
- () 17. Load a blank tape in your cassette recorder.
- () 18. Depress the "RECORD" button on your tape machine.
- () 19. Type G@. The sync stream generator will send a continuous stream of E6H bytes to the cassette for recording. The sync stream tape you are generating will be used to adjust the volume and tone controls of your cassette machine.
- () 20. Allow at least 10 minutes for the sync stream to be generated.
- () 21. Hit ANY key on the keyboard (in order to exit the "G" command).
- () 22. Rewind the tape.
- () 23. Repeat Steps 12 and 13.
- () 24. If no characters appear on the CRT screen, the WRITE phase jumper on the MIO board must be adjusted. TURN OFF THE COMPUTER. Unplug the MIO from the motherboard. Refer to the box labeled "Polarity Select Jumpers" in Figure V-1 and SOLDER a piece of wire across the BOTTOM two header pins shown in the box. Return the MIO to the chassis.
- () 25. Turn on the computer.
- () 26. After verifying that you are in the monitor, repeat Steps 17 through 23.

b) HOW TO LOAD SOFTWARE

NOTE: PGM-2A, BASIC 8A and BASIC 9A are all loaded in the manner outlined below.

1. Place a language cassette in your tape recorder and turn the machine on.
2. Turn on the computer.
3. If you own a CRT, you can verify that you are in the monitor when the words "IMSAI MPU-B 2K VERS 1.0" appear on the CRT screen.
4. If you have purchased a keyboard type X@ (in order to load and execute your cassette file).
5. Depress the "PLAY" button on your tape recorder.
6. The screen will indicate the address of the program you have just loaded. (In this case, the address should be 0000; if an error is indicated, contact the IMSAI Customer Service Department.)

The computer now "understands" the language you have loaded; consult the software manual enclosed with the cassette you have purchased for instructions concerning the loading of additional programs as well as the writing of your own.

E. USING FLOPPY DISKS

E. IF YOU WISH TO USE A FLOPPY DISK

1. WHAT YOU NEED TO BUY

a) HARDWARE

PCS-80/21 or 22

A single (21) or dual (22) IBM 3741-compatible single-density floppy disk drive with 256K bytes of storage space per drive. Units include a floppy disk interface board (FIF): an interface/controller consisting of an IFM (Interface Master Board) and a FIB (Floppy disk Interface Board) which interface the disk to the computer. The IFM board uses its own 8080A processor which is programmed to support the floppy disk system. The program is stored in 1K byte EPROM chips and can be changed to support different data formats and densities on the floppy disk drives. Included is a disk bootstrap capability that reads and executes the contents of the first disk sector (storage space), allowing the disk operating system to gain control after turning on the computer.

A single FIF interface will control up to four disk drives in a daisy chain signal bus, and can write-protect drives under software control.

FIF commands include:

- Read Clock and Data Bits
- Write Sector
- Read Sector
- Verify Sector
- Format Track
- Write Deleted Data Sector Mark
- Write Protect
- Write Enable
- Restore Drive

Logical and physical track addresses may be different. Cyclic redundancy checks are performed automatically. When an error is detected in reading or writing, the logic automatically retries up to 10 times.

CABLE A

to connect the FIB board to the rear of the computer chassis

CABLE C

to connect the chassis to the Floppy Disk Drive cabinet

Two Edge Connectors (EXPM)

connects the FIF to the Motherboard. Each EXPM consists of a 100-pin edge connector to be soldered to the Motherboard, plus two card-edge guides that attach to the sides of the card cage.

OR

PCS-80/25 A or B

A dual floppy disk drive available with single (A) or double (B) density storage capacity. The "A" model disk drive can store up to 256K bytes of information per drive; the "B" model, 512K bytes per drive. Units include a disk interface board (DIO) and cable.

b) SOFTWARE

- 1) If you program in ASSEMBLY LANGUAGE, you will need to purchase:

DOS-A (CP/M)

The floppy Disk Operating System which permits you to create and access files on disk from assembly language programs.

- 2) If you program in BASIC, you will need to purchase:

DOS-A and BASIC 9B

BASIC 9B is a high-level BASIC requiring 9K bytes of memory. It includes the BASIC 8A features (listed in the previous section on cassettes) plus the features listed below. In addition, BASIC 9B supports tape cassette source program storage.

Commands:

DDT
ASAVE
ALOAD
AMERGE

Statements:

ACHAIN
BYE

OR

DOS-A and BASIC E (Extended BASIC)

A brief description of BASIC-E follows:

Statements:

LET
IF ... THEN line number
IF ... THEN any statement
IF ... THEN ... ELSE ...
FOR
NEXT
GOTO
GOSUB
RETURN
ON ... GOTO list of line numbers
ON ... GOSUB list of line numbers
RANDOMIZE
PRINT

READ
OUT port, data
DATA
RESTORE
REM
END
DIM

Functions:

DEF FName
PRINT
READ
ABS(X)
ATN(X)
COS(X)
COSH(X)
FRE number of bytes of unused storage
INP(X) input from port X
INT(X)
LOG(X)
POS(X) carriage position
RND
SGN(X)
SIN(X)
SINH(X)
SQR(X)
TAB(X)
EXP(X)
ASC(A\$)
CHR\$(X)
LEFT\$(A\$,length)
LEN(A\$)
MID\$(A\$,start,length)
RIGHT\$(A\$,length)
STR\$(X)
VAL(A\$)

File Operations:

FILE
PRINT\$
READ\$
CLOSE
IF END

Operators:

NOT
AND
OR
+ - / * ^
< <= = >= >

OR

DOS-A and BASIC-C (Commercial BASIC)

BASIC-C includes all BASIC-E features (except the SINH and COSH functions) plus the features listed below. BASIC-C displays double precision mathematics and will carry 14 significant digits (whereas BASIC-E carries only 6.5).

Statements:

WHILE
WEND
PRINT USING
DEF
FEND
LPRINTER [WIDTH]
CONSOLE
INPUT LINE
POKE
CALL

Files:

OPEN [RECL recordlength] AS filename
CREATE filename [RECL recordlength] AS filename
FILE A\$
DELETE
CLOSE

Functions:

PEEK (X)
MATCH
RENAME
SIZE

Directives:

% LIST
% NOLIST
% INCLUDE

Operators:

XOR

NOTE: PRINT and PRINT USING may be used to print or read from a file.

3) If you program in FORTRAN, you will need to purchase:

DOS-A and FORTRAN IV

The latter, a level 2 ANSI (American National Standards Institute) compiler: a program which converts FORTRAN into machine language. See the brief description below.

Statements:

EXTERNAL	DO
DIMENSION	CONTINUE
COMMON	STOP
EQUIVALENCE	PAUSE
DATA	CALL
INTEGER	RETURN
REAL	READ
LITERAL	WRITE
HEXADECIMAL	BACKSPACE
GO TO	REWIND
ASSIGN	ENDFILE
IF	

Functions and Subprograms:

PROGRAM
FUNCTION
SUBROUTINE

Library Functions:

ABS	IABS	AINT
INT	AMOD	MOD
AMAX0	AMAX1	MAX0
MAX1	AMIN0	AMIN1
MIN0	MIN1	FLOAT
IFIX	SIGN	ISIGN
DIM	IDIM	EXP
ALOG	ALOG10	SIN
COS	TANH	SQRT
ATAN	ATAN2	PEEK
POKE	INP	OUT

Operators:

.NOT.	-	.LE.
.AND.	*	.EQ.
.OR.	/	.NE.
.XOR.	**	.GT.
+	.LT	.GE.

2. PROGRAM LOADING

a) INTERFACING YOUR NEW HARDWARE TO THE PCS-80/15 MAINFRAME.

NOTE: the instructions outlined below only refer to the PCS-80/21 and 22. Instructions pertaining to the PCS-80/25 A or B, currently in the development stage, will be described in a future edition of this manual.

- () 1. Insert the IFM and FIB boards into empty edge connectors on the motherboard. If no slots are available, carefully remove the motherboard from the chassis, being certain to FIRST remove all PC boards which are plugged into the motherboard, and to detach all power connections which hinder removal of the motherboard. (Detach the two white plastic MOlex connectors at the front of the motherboard from their cradles, and slide the ground and power connections off the tabs located along the sides of the EXP-10. There are seven tab-style power connectors on the left edge of the EXP-10 and four ground connections along the right-hand edge of the board. You may wish to use a screwdriver to aid in sliding the tabs apart.) Refer to Section III-C for instructions relating to installation of edge connectors on the EXP-10.
- () 2. Connect the IFM and FIB to one another by installing the flat 5 inch Cable F (with card edge connectors at both ends of the cable) between the boards; plug the connectors into the slots provided along the upper right hand edges of the two boards.
- () 3. Cable A is a 15 inch flat ribbon cable which carries signals from the FIB to a female 25-pin EIA-type connector (included) attached to the rear of the chassis. A card edge connector (included) on the other end attaches to the PC board. Plug the card edge connector end of Cable A into the slots provided along the upper left hand edge of the FIB.
- () 4. Screw the free end of Cable A to the back panel of the PCS-80/15 chassis, using any free rectangular cutout. The connector pins should protrude through the chassis to the outside.
- () 5. Cable C is a 5 foot ribbon cable which carries signals between the rear of the computer mainframe and the disk drive. The cable has a male 25-pin EIA-type connector at each end. Connect one end of Cable C to the Cable A female connector protruding from the rear of the PCS-80/15 chassis.
- () 6. Connect the free end of Cable C to the factory-installed female connector protruding from the right hand side of the disk drive back panel.

b) HOW TO LOAD SOFTWARE

NOTE: ALL software is loaded in the manner outlined below.

- () 1. Turn on the computer.
- () 2. Insert the language "diskette" into the slot on the disk drive. DO NOT REMOVE THE PAPER ENVELOPE IN WHICH THE DISK IS SUPPLIED.

IMSAI PCS-80/15
SECTION V-E
USER GUIDE
FLOPPY DISK

- () 3. If you own a CRT, you can verify that you are in the PCS-80/30 monitor when the words "IMSAI MPU-B 2K VERS 1.0" appear on the screen.
- () 4. If you own a keyboard, type B@ (the monitor command allowing you to boot from disk).

The computer now "understands" the language you have loaded; consult the software manual enclosed with the disk you have purchased for instructions concerning the loading of additional programs as well as the writing of you own.

F. USING PAPER TAPE

F. IF YOU WISH TO USE PAPER TAPE

1. WHAT YOU NEED TO BUY

a) HARDWARE

Paper Tape Reader

none of which are available from IMSAI. We recommend the purchase of a Teletype® terminal or other compatible device.

CABLE C

to carry signals between the rear of the mainframe and the terminal.

b) SOFTWARE

1) If you program in ASSEMBLY LANGUAGE you will need to purchase

PGM-1A

The Self-Contained System, PGM-1A, contains an assembler, editor, debugger, loader and monitor. EDITORS are used to create and modify the assembly language programs from the keyboard. The editor provides easy manipulation of text by commands such as: create new text; delete old text; insert new text; store text on the file. LOADERS are short programs which when in memory, enable the computer to accept and store other programs. PGM-1A has commands to modify memory, dump memory contents, manage memory-located files, list a file, execute a program and use breakpoints (see Glossary). Programs are read from paper tape by a bootstrap loader program contained in the monitor resident on the CPU board.

Use of this system requires 4K bytes of RAM plus additional memory space for user programs. Generally, at least 8K of memory is needed to store the package and user-created programs.

The purchase of PGM-1A, furnished on paper tape, includes a documentation package.

2) If you program in BASIC, you will need to purchase:

BASIC 8A

(See section V-B for sample list of specifications.)

(NOTE: An IMSAI FORTRAN package for use with paper tape is not available.)

2. LOADING OF PROGRAMS

a) INTERFACING YOUR NEW HARDWARE TO THE PCS-80/15 MAINFRAME:

- () 1. Identify the female 25-pin EIA-type connector which has been screwed to the back panel of the mainframe at the factory. (This connector is attached to Cable AF which carries signals between the rear of the PCS-80/15 cabinet and the MPU-B board.)
- () 2. CABLE C is a 5 foot ribbon cable which carries signals between the rear of the computer mainframe and the terminal. The cable has a male 25-pin EIA-type connector at each end. Plug one end of Cable C into the female connector protruding from the rear of the mainframe.
- () 3. Connect the free end of Cable C into the female connector provided on your terminal.

b) HOW TO LOAD SOFTWARE

- () 1. Mount paper tape in reader (refer to the manual supplied with your particular paper tape reader).
- () 2. Turn on the computer.
- () 3. If you own a CRT, you can verify that you are in the monitor when the words "IMSAI MPU-B 2K VERS 1.0" appear on the CRT screen.
- () 4. If you have purchased a keyboard, type H@ (in order to load your paper tape file).
- () 5. Start the paper tape reader (refer to your reader manual for instructions). You are now reading the language file from paper tape into memory.
- () 6. When loading stops, turn off the paper tape reader.
- () 7. Type J<starting address>@. DO NOT TYPE BRACKETS. The starting address to be typed in is specified in your software manual; the same address in NOT referenced for all languages.

The computer now "understands" the language you have loaded; consult the manual enclosed with the software you have purchased for instructions concerning the loading of additional programs as well as the writing of your own.

G. USING PROMS

G. IF YOU WISH TO USE PROMS

1. WHAT YOU NEED TO BUY

a) HARDWARE

For ASSEMBLY LANGUAGE programming:

- 1 PROM 4-4 Board
for non-volatile storage of PGM-1A assembly language, which requires 4K bytes of memory. The board contains sockets for 16 Intel 1702A (or equivalent) PROM chips.
- 1 EXPM Edge Connector
(see Section V-E for description)

OR

For BASIC programming:

- 2 PROM 4-4 Boards
for non-volatile storage of BASIC 8A, which requires 8K bytes of memory.
- 2 EXPM Edge Connectors

b) FIRMWARE

- 1) If you wish to program in ASSEMBLY LANGUAGE, you will need to purchase:

PGM-1A Assembler on PROM
16 Intel 1702A (or equivalent) PROM chips which are programmed at the factory with the PGM-1A Assembler.

- 2) If you wish to program in BASIC, you will need to purchase:

BASIC 8A Compiler on PROM
32 Intel 1702A (or equivalent) PROM chips which are programmed at the factory with the BASIC 8A Compiler.

2. LOADING PROGRAMS

a) ADDRESSING PROMS

Address your PROMs by jumpering according to the directions in the manual supplied with the PROMs you have purchased; install PROMs on PROM 4-4 board (see firmware manual).

b) INSTALLING PROM BOARDS

- () 1. Install the PROM board(s) into an empty edge connector(s) on the motherboard. If no slots are available, carefully remove the motherboard from the chassis, being certain to FIRST remove all PC boards which are plugged into the motherboard and to detach all power connections which hinder removal of the motherboard. (Detach the two white plastic Molex connectors at the front of the motherboard from their cradles, and slide the ground and power connections off the tabs located along the sides of the EXP-10. There are seven tab-style power connectors on the left edge of the EXP-10 and four ground connections along the right-hand edge of the board. You may wish to use a screwdriver to aid in sliding the tabs apart.) Refer to Section III-C for instructions relating to installation of edge connectors on the EXP-10.
- () 2. Turn the computer on.
- () 3. If you own a CRT, you can verify that you are in the monitor when the words "IMSAI MPU-B 2K VERS 1.0" appear on the CRT screen.
- () 4. If you have purchased a keyboard, type J<starting address>@ (MPU-B command permitting you to begin execution of your program at the starting address specified in your software manual). DO NOT TYPE BRACKETS.

Refer to your software manual for instructions concerning the writing of your own programs.

VI. APPENDICES

APPENDIX A

GLOSSARY

APPENDIX A

GLOSSARY

- address —
The number which identifies a memory location.
- alphanumeric —
Pertaining to characters which may be either alphabetic or numeric.
- ASCII (American Standard Code for Information Interchange) —
An industry standard 7-bit code for encoding alphanumeric characters and punctuation marks.
- blanking pulse —
The negative pulse that cuts off the electron beam of the CRT (the writing tube which converts the picture signal into light).
- bootstrap —
A short program which, when in memory, instructs the computer to accept and store other programs.
- breakpoint —
A location in a routine, where, specified by an instruction, the routine can be interrupted by the monitor or by external intervention.
- cursor —
Position indicator on video display; indicates a character to be corrected, or a position in which data is to be entered.
- EIA (Electronic Industries Association standard code) —
A group of signal characteristics (voltage, current, time duration) specified by the EIA relating to the connection of terminals to computer modules.
- EPROM (Erasable Programmable Read-Only Memory) —
Erasable PROMs.
- firmware —
Programs which are embodied in a piece of hardware; i.e., a read-only memory (ROM) chip.
- font —
A collection of characters of a given size and style.
- format —
Arrangement of characters, fields, lines, punctuation marks, page numbers, etc.
- hardware —
The physical equipment; the electronic, mechanical, and magnetic elements in a computer.

hex(adecimal) —

A base 16 number system; digits range from 0 through 9 and A through F (which represents the highest units position — a value of 15).

LSI (Large Scale Integration) —

Refers to an IC with the complexity of more than 100 logic gates.

microprocessor —

The central processing unit of a computer, generally contained on a single semiconductor chip; the CPU consists of the arithmetic unit and the control logic unit.

monitor —

A program allowing basic control of system functions and input of other programs into computer memory.

motherboard —

The printed circuit board with card sockets into which the logic cards are plugged.

MSI (Medium Scale Integration) —

Means the complexity of an IC is comparable to a logic circuit with 12 to 100 logic gates.

port — That element of a processor, dedicated to a single channel, which receives data from or transmits data to one or more remote devices.

program —

Logically related instructions stored in computer memory.

PROM (Programmable Read-Only Memory) —

ROM which is programmable using a programming circuit.

RAM (Random Access Memory) —

Memory with both read and write capability.

ROM (Read-Only Memory) —

Memory that can be read from but not written into.

single-phase —

Refers to AC power supplies where one outward and one return line are required for signal conduction.

software —

Programs: including operating systems, programming languages and their translators, and applications procedures.

terminated line —

A transmission line with a resistance, equal to the impedance of the line, attached to its far end; reflection and standing waves are eliminated when a signal is placed on the near end of the line.

time-out —

A program wait loop attending an event expected to occur within a fixed time limit.

TTL (Transistor-Transistor Logic) —

A type of integrated circuit logic deriving its name from the manner in which the basic transistor components are interconnected.

wrap-around —

On a video display, the continuation of an operation — for example, a read or cursor movement — from the last character position in the display to the first position in the display.

APPENDIX B
SPECIFICATIONS

APPENDIX B-1
MPU-B SPECIFICATIONS

MPU-B SPECIFICATIONS

Processor	8085
Bus	S-100
Clock Speed	3 MHz
Program Speed	
Mem. read cycle	1 microsecond
Mem. write cycle	1 microsecond
Register move	1.33 microsecond
8 bit ADD	1.33 microsecond
Load register	2.33 microseconds
Jump	3.33 microseconds
Instruction set	113 instructions
Static memory	
access time	575 nanoseconds
Priority interrupts	5 levels
On board interrupts	DIP Switch selectable
PROM/ROM	2K Bytes
RAM	256 Bytes
Power on jump	Yes
PROM/ROM/TIMER	Software enable
Hardware front panel:	
Required	No
Available	Use CP-A or FIF
Software front panel:	
Power on jump	To monitor
Auto baud rate set	Yes
Paper tape loader	Yes
Cassette loader	Yes
Floppy Disk loader	Yes
Monitor	Yes
Serial I/O:	
USART	8251
Asynchronous	Yes
Synchronous	Yes
RS-232, terminal end	Yes
RS-232, computer end	Yes
RTS, CTS, DTR, DSR	Yes
Current Loop	20 mil.
Interrupts	Rec., Trans., Sync det.

IMSAI PCS-80/15
SECTION VI-B
SPECIFICATIONS

Baud rate:	
Async	0.5 to 9600
Sync	30.5 to 56,000
Rate	Software controlled
Number of bits	Software controlled
Parity odd/even	Software controlled
Parity disable	Software controlled
Number of stop bits	Software controlled
Single Sync char.	Yes
Double sync. char.	Yes
Sync characters	Software loaded
Send BREAK char.	Yes
Error detect	parity, overrun, framing
Parallel I/O:	
Input data	8 bits
Output data	8 bits
Handshaking	Input and output
Latched data	Input and Output
Status	Input data ready, Output buffer empty
Input interrupt	Yes
Output Interrupt	Yes
Timers:	
Timer chip	8253
Sections	3
Bits/Section	16
Clock rate 0	2 MHz
Clock rate 1	2 MHz
Clock rate 2	2 MHz or Timer 1 output
Interrupts	Timer 1 and 2 outputs
Timer 0	Used as baud rate generator
Minimum time	0.5 microsecond
Max. time, 1 timer	32.77 microseconds
Max. time, #1 and 2	35.79 minutes
Power:	
+8 Volts typical	1230 milliamperes
+8 Volts max.	1700 milliamperes
+18 Volts typical	20 to 110 milliamperes
+18 Volts Max.	145 milliamperes
-18 Volts typical	20 to 50 milliamperes
-18 volts max.	85 milliamperes

APPENDIX B-2

PS-28U SPECIFICATIONS

Power Requirements:

Input Voltages: 92, 103.5, 115, 126.5, 184, 207, 230, and
253 volts, single phase, 500 watts (max)

No Load Voltages: 115 VAC, 60 Hz input, nominal taps
#6 and #9 in parallel with taps #1
and #4

+8V. supply: +9.7 volts
+16V. supply: +18.0 volts
-16V. supply: -18.0 volts

Current Supplied:

At 115 VAC, 60 Hz, resistive load:

28.0 amperes at 7.0 volts ripple valley
4.5 amperes at +13.5 volts ripple valley
4.5 amperes at -13.5 volts ripple valley

At 100 VAC, 50 Hz, resistive load:

25.0 amperes at +7.0 volts ripple valley
4.0 amperes at +13.5 volts ripple valley
4.0 amperes at -13.5 volts ripple valley

APPENDIX C

SCHEMATICS

1. PS-28U
2. MPU-B
3. EXP-10

APPENDIX D

SAMPLE MACHINE LANGUAGE PROGRAM

APPENDIX D

MACHINE LANGUAGE "CHASE GAME"

This 200-byte game involves chasing a randomly-moving target with the cursor, using the monitor commands which control cursor movement. After the program listed below is keyed into the computer, the cursor and small cross-shaped target will appear on the CRT screen. The game begins as soon as the player types any key on the keyboard. Using the following commands

CTL-H — moves cursor to the left
CTL-J — moves cursor down
CTL-K — moves cursor up
CTL-L — moves cursor to the right

the player can move the cursor one character position in any direction. Each cursor displacement is counted as one move in the game, and the target itself moves each time the player shifts the cursor position. The object of the game is to "kill the cursor"; when the cursor is hit, the screen will display the duration of play as well as the number of times the cursor was moved before the target was encountered. (A sample listing might be: T=28.57 C=56; the player took 56 moves and 28.57 seconds to hit the cursor.) The limitation on the count is 99 and on the time is 99.99 seconds

The game program is listed below.

```
D000 CD 00 F8 3E 1B CD 03 F8 3E 53 CD 03 F8 21 97 F3
D010 22 D4 D0 3E 2B 77 21 0B 28 22 D6 D0 21 03 D1 36
D020 B5 36 74 2D 36 00 36 00 2D 36 20 36 4E 21 D8 D0
D030 36 00 CD 10 FF 3A D8 D0 C6 01 27 32 D8 D0 2A D4
D040 D0 7E 07 DA 87 D0 2A 8F F7 E5 2A 80 F7 E5 2A D4
D050 D0 22 8F F7 36 20 2A D6 D0 22 80 F7 21 03 D1 36
D060 44 2D 2D 7E CD BA D0 7E CD BA D0 21 03 D1 2A 80
D070 F7 22 D6 D0 2A 8F F7 22 D4 D0 36 2B E1 22 80 F7
D080 E1 22 8F F7 C3 32 D0 21 CC D0 CD B6 FF 21 03 D1
D090 36 84 2D 46 3E 99 90 F5 46 3E 99 90 CD 9A FF 3E
D0A0 2E CD 03 F8 F1 CD 9A FF 21 CF D0 CD B6 FF 3A D8
D0B0 D0 CD 9A FF CD 10 FF C3 00 D0 E6 07 FE 05 CA CB
D0C0 D0 FE 01 CA CB D0 F6 08 CD 03 F8 C9 54 3D 00 20
D0D0 20 43 3D 00 00 00 00 00 00 58 10 F0 01 3A 51 6C
```

The procedure for loading and executing the program is as follows:

1. Turn on the computer and verify that you are in the monitor.
2. Type ED000@ (in order to examine the contents of location D000).
3. The screen will display:

D000 7E (the contents of location D000)

4. Type CD (the character in the second column of row 1 of the of the program listing), then hit the space bar.
5. After each computer response, type the next character in the program listing, then hit the space bar. Follow the listing from left to right, working sequentially from row 1 through row 14.
6. Following entry of the last character in the listing (6C), the prompt (?) sign will come up on the screen.

Type DD000,D0F0@

The program listing you have keyed in will come up on the screen. Verify that the program has been entered correctly.

7. Type JD000@

The target and cursor will be displayed on the CRT; the game is begun by hitting any character on the keyboard.

Once over, the game can be restarted by typing any keyboard character. Typing a CTL-C puts you back into the monitor.

The Assembly Language game program listing is given below.

```
; THIS IS THE GAME OF CHASE WRITTEN FOR A MINIMAL
; PCS 80/30 SYSTEM. 9/24/77 DMH
```

```
; COPYRIGHT (C) 1977
; IMSAI MANUFACTURING CORPORATION
; 14860 WICKS BLVD, SAN LEANDRO, CA. 94577
; ALL RIGHTS RESERVED WORLDWIDE
```

```
; CONSTANTS
```

```
F800 = INITV EQU 0F800H ;VIO INITIATION ADDR
F803 = CHAROUT EQU 0F803H ;VIO OUTPUT CHARACTER SUBR
FF10 = CHIN EQU 0FF10H ;VIO INPUT CHARACTER SUBR
F78F = CURPTR EQU 0F78FH ;VIO CURSER POINTER
F780 = CURLIN EQU 0F780H ;VIO CURSOR LINE POINTER
F7FF = VICCOM EQU 0F7FFH ;VIO COMMAND PORT
F7B6 = MSGNC EQU 0FFB6H ;SUBR TO PRINT MESSAGES
A = CHEX EQU 0FF9AH ;SUBR TO PRINT HEX NUMBERS
D103 = MODE EQU 0D103H ;TIMER COMMAND PORT
F397 = STAPOS EQU 0F397H ;TARGET STARTING POSITION
280B = LINCOL EQU 280BH ;TARGET SCREEN STARTING POSITION
002B = TARGET EQU '+' ;TARGET CHARACTER
```

```
D000 ORG 0D000H
```

```
; THIS IS WHERE IT BEGINS
```

```
D000 CD00F8 INIT: CALL INITV ;INITIALIZE VIO
D003 3E1B MVI A, 1BH ;GET 'ESCAPE'
D005 CD03F8 CALL CHAROUT
D008 3E53 MVI A, 53H ;GET SCROLL TOGGLE
D00A CD03F8 CALL CHAROUT
D00D 2197F3 LXI H, STAPOS ;GET TARGET MEM POSITION
D010 22D4D0 SHLD TARPTR ;PUT IT IN TARGET POINTER
D013 3E2B MVI A, TARGET ;GET TARGET CHARACTER
D015 77 MOV M, A ;PUT IT
D016 210B28 LXI H, LINCOL ;GET TARGET SCREEN POSITION
D019 22D6D0 SHLD TARLIN ;PUT IT IN POINTERS
```

```
; SETUP TIMERS
```

```
D01C 2103D1 LXI H, MODE ;GET TIMER COMM PORT
D01F 36B5 MVI M, 0B5H ;MODE FOR TIMER2
D021 3674 MVI M, 74H ;MODE FOR TIMER1
D023 2D DCR L ;POINT TO TIMER2
D024 3600 MVI M, 0 ;SET TIMER2 TO 0
D026 3600 MVI M, 0
```

```

D028 2D          DCR L          ;POINT TO TIMER1
D029 3620        MVI M, 20H      ;SET TIMER1 TO 4E20H,
D02B 364E        MVI M, 4EH      ; OUTPUT TOGGLES AT .01 SEC

; SETUP MOVE COUNTER

D02D 21D8D0      LXI H, COUNT
D030 3600        MVI M, 0        ;INITIAL VALUE OF ZERO

; MAIN PART OF PROGRAM

D032 CD10FF      MOVE:   CALL CHIN          ;GET PLAYER MOVE WITH ECHO
D035 3AD8D0      LDA COUNT          ;GET MOVE COUNT
D038 C601        ADI 01H          ;BUMP IT
D03A 27          DAA              ;KEEP IT DECIMAL
D03B 32D8D0      STA COUNT          ;PUT IT AWAY

; CHECK FOR WIN

D03E 2AD4D0      LHLD TARPTR       ;GET TARGET POINTER
D041 7E          MOV A, M          ;GET TARGET
D042 07          RLC              ;CHECK FOR BIT 7 HIGH
D043 DA87D0      JC WIN

; TARGET GETS TO MOVE

D046 2A8FF7      LHLD CURPTR       ;GET CURSOR POINTER
D049 E5          PUSH H           ;SAVE IT
D04A 2A80F7      LHLD CURLIN       ;GET CUSOR SCREEN POSITION
D04D E5          PUSH H           ;SAVE THAT ONE TOO
D04E 2AD4D0      LHLD TARPTR       ;GET TARGET MEM POINTER AND
D051 228FF7      SHLD CURPTR       ; SCREEN POINTER AND
D054 3620        MVI M, 20H       ;BLANK TARGET
D056 2AD6D0      LHLD TARLIN       ;GET TARGET SCREEN POINTER TOO
D059 2280F7      SHLD CURLIN       ;AND STORE IT IN CURSOR POINTER
; TARGET NOW LOOKS LIKE CURSOR
; TO VIO MONITOR

D05C 2103D1      MOVTAR: LXI H, MODE ;GET TIMER MODE ADDRESS
D05F 3644        MVI M, 44H       ;LATCH TIMER1 COUNT
D061 2D          DCR L
D062 2D          DCR L           ;GET TIMER1 ADDRESS
D063 7E          MOV A, M         ;GET COUNT IN ACC
D064 CDBAD0      CALL CHECK        ;MOVE #1
D067 7E          MOV A, M
D068 CDBAD0      CALL CHECK        ;MOVE #2
D06B 2103D1      LXI H, MODE
D06E 2A80F7      LHLD CURLIN       ;GET TARGET SCREEN POINTER
D071 22D6D0      SHLD TARLIN       ;PUT IT AWAY
D074 2A8FF7      LHLD CURPTR       ;GET TARGET MEM POINTER
D077 22D4D0      SHLD TARPTR       ;PUT IT AWAY

```

```

D07A 362B      MVI M, TARGET      ;REPLACE CURSOR CHAR WITH TARGET
D07C E1        POP H          ;RESTORE CURSOR POINTERS
D07D 2280F7    SHLD CURLIN
D080 E1        POP H
D081 228FF7    SHLD CURPTR
D084 C332D0    JMP MOVE          ;GO AND DO IT AGAIN

```

; HERE IF CURSOR IS ON TOP OF TARGET

```

D087 21CCD0    WIN:      LXI H, TMESG      ;POINT TO 'T='
D08A CDB6FF    CALL MSGNC     ;PUT IT ON VIO
D08D 2103D1    LXI H, MODE
D090 3684      MVI M, 84H     ;LATCH ELAPSED TIME
D092 2D        DCR L          ;POINT TO TIMER2
D093 46        MOV B,M        ;GET LOW BYTE
D094 3E99      MVI A, 99H     ;COUNTER IS A COUNT DOWN
D096 90        SUB B          ; SUB FROM ORIGINAL LOAD
D097 F5        PUSH A         ;SAVE IT
D098 46        MOV B,M        ;GET HIGH BYTE
D099 3E99      MVI A, 99H
D0A0 90        SUB B
D09C CD9AFF    CALL OHEX      ;PUT IT ON VIO
D09F 3E2E      MVI A, '.'     ;GET DECIMAL POINT
D0A1 CD03F8    CALL CHAROUT   ;PUT IT
D0A4 F1        POP A          ;RETRIEVE LOW BYTE
D0A5 CD9AFF    CALL OHEX      ;PUT IT
D0A8 21CFD0    LXI H, CMESG   ;POINT TO 'C='
D0AB CDB6FF    CALL MSGNC     ;PUT IT ON VIO
D0AE 3AD8D0    LDA COUNT     ;GET COUNT
D0B1 CD9AFF    CALL OHEX      ;PRINT IT
D0B4 CD10FF    CALL CHIN     ;ANOTHER GAME?
D0B7 C300D0    JMP INIT      ;SET UP ANOTHER ROUND JOE

```

; SUBROUTINES

```

D0BA E607      CHECK:   ANI 07H      ;STRIP HIGH BITS
D0BC FE05      CPI 05H      ;'CR'?
D0BE CACBD0    JZ ILLEGL    ;GIVE ME ANOTHER
D0C1 FE01      CPI 01H      ;TAB?
D0C3 CACBD0    JZ ILLEGL
D0C6 F608      ORI 08H      ;MAKE IT CONTROL CHARAC
D0C8 CD03F8    CALL CHAROUT   ;PUT IT
D0CB C9        ILLEGL:  RET      ;GET BACK WHERE YOU BELONG

```

; PROGRAM STORAGE AREAS

```

D0CC 543D      TMESG    DW      'T='
D0CE 00        DB      0
D0CF 2020433D  CMESG    DW      2020H, 'C='
D0D3 00        DB      0

```

D0D4 0000 TARPTR DW 00
D0D6 0000 TARLIN DW 00
D0D8 00 COUNT DB 0

D0D9 END

APPENDIX E

THE HEX CONVERSION TABLE

APPENDIX E

HEX CONVERSION TABLE

DECIMAL	BINARY	HEX	ASCII
0	0000	00	NUL
1	0001	01	SOH
2	0010	02	STX
3	0011	03	ETX
4	0100	04	EOT
5	0101	05	ENQ
6	0110	06	ACK
7	0111	07	BEL
8	1000	08	BS
9	1001	09	HT
10	1010	0A	LF
11	1011	0B	VT
12	1100	0C	FF
13	1101	0D	CR
14	1110	0E	SO
15	1111	0F	SI
16	10000	10	DLE
17	10001	11	DC1 (X-ON)
18	10010	12	DC2 (TAPE)
19	10011	13	DC3 (X-OFF)
20	10100	14	DC4
21	10101	15	NAK
22	10110	16	SYN
23	10111	17	ETB
24	11000	18	CAN
25	11001	19	EM
26	11010	1A	SUB
27	11011	1B	ESC
28	11100	1C	FS
29	11101	1D	GS
30	11110	1E	RS
31	11111	1F	US
32	100000	20	SP
33	100001	21	!
34	100010	22	"
35	100011	23	#
36	100100	24	\$
37	100101	25	%
38	100110	26	&
39	100111	27	'
40	101000	28	(

41	101001	29)
42	101010	2A	*
43	101011	2B	+
44	101100	2C	,
45	101101	2D	-
46	101110	2E	.
47	101111	2F	/
48	110000	30	0
49	110001	31	1
50	110010	32	2
51	110011	33	3
52	110100	34	4
53	110101	35	5
54	110110	36	6
55	110111	37	7
56	111000	38	8
57	111001	39	9
58	111010	3A	:
59	111011	3B	;
60	111100	3C	<
61	111101	3D	=
62	111110	3E	>
63	111111	3F	?
64	1000000	40	@
65	1000001	41	A
66	1000010	42	B
67	1000011	43	C
68	1000100	44	D
69	1000101	45	E
70	1000110	46	F
71	1000111	47	G
72	1001000	48	H
73	1001001	49	I
74	1001010	4A	J
75	1001011	4B	K
76	1001100	4C	L
77	1001101	4D	M
78	1001110	4E	N
79	1001111	4F	O
80	1010000	50	P
81	1010001	51	Q
82	1010010	52	R
83	1010011	53	S
84	1010100	54	T
85	1010101	55	U
86	1010110	56	V
87	1010111	57	W
88	1011000	58	X
89	1011001	59	Y

90	1011010	5A	z
91	1011011	5B	[
92	1011100	5C	\
93	1011101	5D]
94	1011110	5E	^
95	1011111	5F	_
96	1100000	60	`
97	1100001	61	a
98	1100010	62	b
99	1100011	63	c
100	1100100	64	d
101	1100101	65	e
102	1100110	66	f
103	1100111	67	g
104	1101000	68	h
105	1101001	69	i
106	1101010	6A	j
107	1101011	6B	k
108	1101100	6C	l
109	1101101	6D	m
110	1101110	6E	n
111	1101111	6F	o
112	1110000	70	p
113	1110001	71	q
114	1110010	72	r
115	1110011	73	s
116	1110100	74	t
117	1110101	75	u
118	1110110	76	v
119	1110111	77	w
120	1111000	78	x
121	1111001	79	y
122	1111010	7A	z
123	1111011	7B	{
124	1111100	7C	
125	1111101	7D	} (ALT MODE)
126	1111110	7E	~
127	1111111	7F	DEL (RUBOUT)

CUSTOMER SERVICE

REPLACEMENT PARTS

If you need a replacement part, use only standard parts from commercial sources. Use of surplus or second-run parts will void warranty. If you have trouble locating a part, write IMSAI and include:

- Part number and description as shown in the parts list.
- Serial number of cabinet or board name and revision number.
- Date of purchase.
- Nature of defect.

Note: Parts damaged through carelessness or misuse will not be replaced under warranty.

TECHNICAL CONSULTATION

Need help with your kit or system?

We encourage you to call or write IMSAI for assistance with any technical problems (except program debugging and "customizing" of hardware for special application, which we will not handle).

The effectiveness of our technical assistance depends on the information you furnish. Be sure to include:

- Serial number of cabinet and/or board name and revision number.
- Date of purchase.
- Exact description of problem.
- Everything you have done in attempting to correct the problem.
- All switch positions, connections to other equipment, system configuration, operation procedure, voltage readings and any other information that you think might be useful.

Note: Telephone traffic is lightest at midweek . . . please be sure your manual and all notes are on hand at time of call.

REPAIR SERVICE

Service facilities are available for both warranty and non-warranty repair work. If this service is desired, send IMSAI:

- Name and address.
- Date of purchase.
- Copies of all correspondence and notes relevant to the problem.
- A complete description of the problem.
- Authorization to return your kit C.O.D. for service (IF ANY) and shipping charges.
- The equipment to be repaired should be sent to IMSAI well packed.
- The original packing slip number.

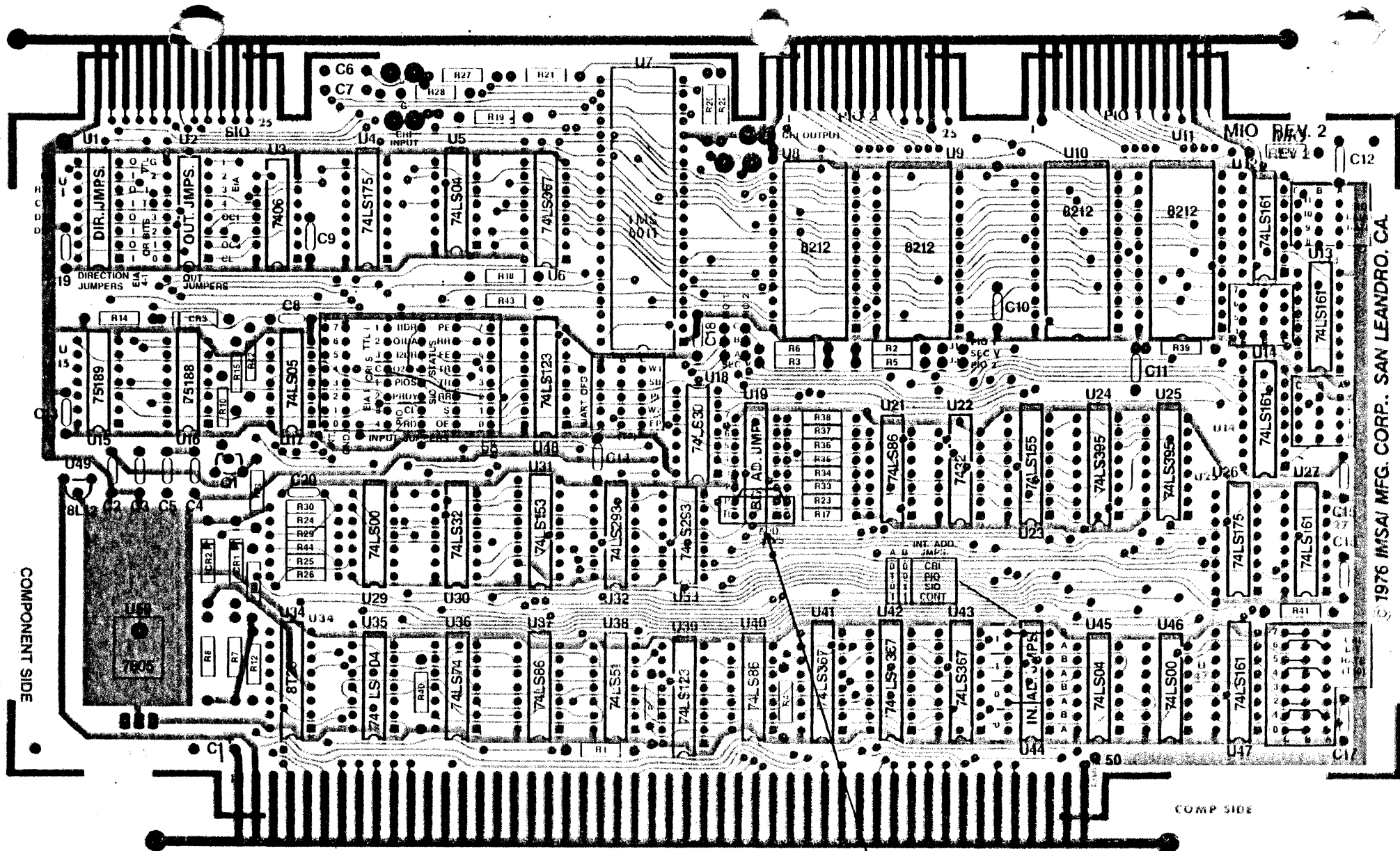

© 1976 IMSAI MFG. CORP. SAN LEANDRO, CA.

FIGURE V-1
 TARBELL CASSETTE
 1500 BITS PER SECOND

POLARITY SELECT JUMPS

© 1976
 IMSAI MFG. CORP.
 SAN LEANDRO, CA.

IMSAI READER SUGGESTIONS

IMPROVEMENT OF OUR MANUAL IS DEPENDENT UPON USER INPUT. PLEASE FILL OUT THIS FORM AND MAIL IT
BACK TO US. NOTE: (NO POSTAGE IS REQUIRED)

DID YOU FIND ERRORS IN THIS MANUAL? (If so, please specify by page)

IS THE MANUAL UNDERSTANDABLE, USABLE, AND WELL ORGANIZED? (Please make suggestions for improvement)

DID YOU FIND SUFFICIENT DOCUMENTATION FOR ASSEMBLY AND USE OF YOUR *IMSAI* SYSTEM?
(What material is missing and where should it be placed)

PLEASE INDICATE THE TYPE OF USER/READER YOU MOST NEARLY REPRESENT.

- HOBBYIST
 ENGINEER
 COMPUTER PROGRAMMER
 STUDENT
 BUSINESS PERSON
 USER WITH LITTLE ELECTRONIC BACKGROUND
 OTHER _____

NAME

DATE

ORGANIZATION

STREET

CITY

STATE

ZIP CODE or COUNTRY



BUSINESS REPLY MAIL

First Class, Permit No. 2001, San Leandro, CA

IMSAI
MANUFACTURING CORPORATION
14860 Wicks Boulevard
San Leandro, CA 94577

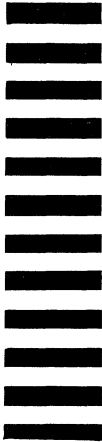

IMSAI

**Manufacturing Corporation
14860 Wicks Boulevard
San Leandro, CA, 94577**