



Storage Subsystem Library

GC26-4495-02

# Maintaining IBM Storage Subsystem Media

331  
R

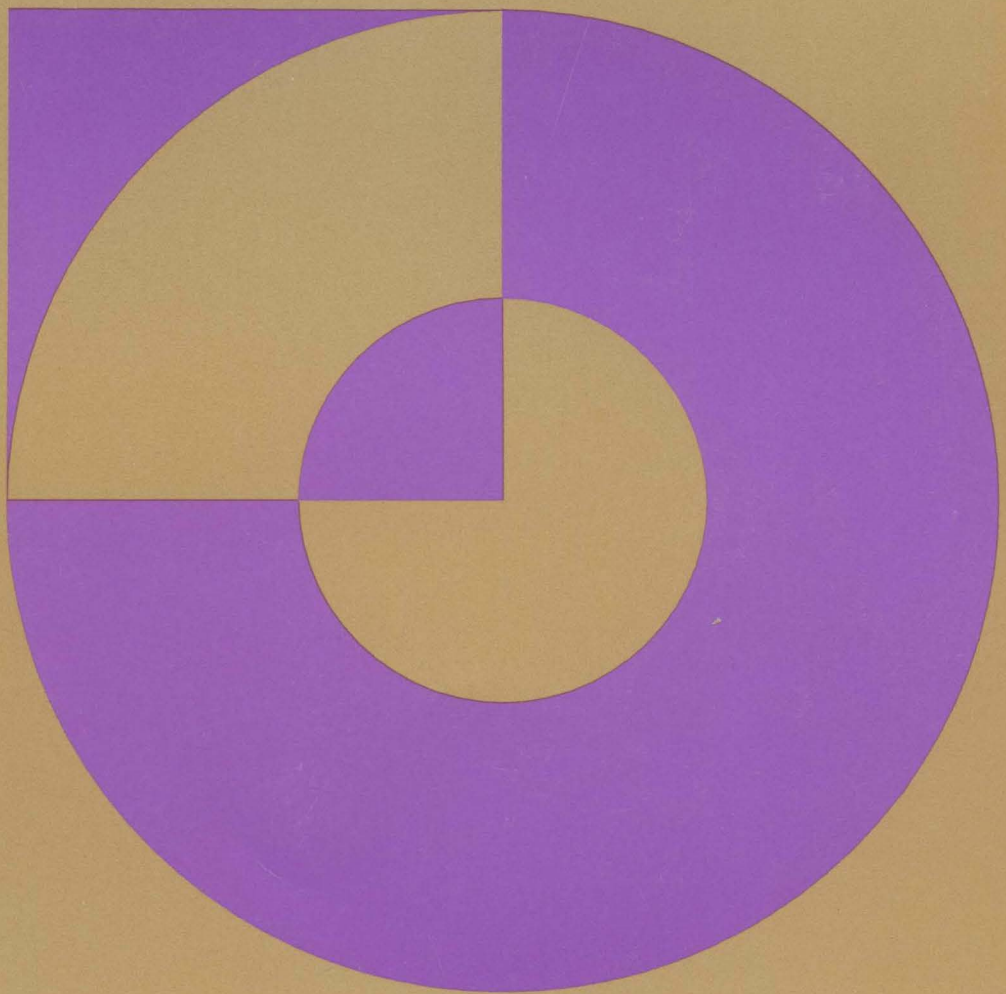



---

Storage Subsystem Library

GC26-4495-02

**Maintaining IBM Storage Subsystem Media**

---

## **Federal Communications Commission (FCC) Statement**

**Warning:** This equipment generates, uses, and can radiate radio frequency energy and if not installed and used in accordance with the instructions manual, may cause interference to radio communications. It has been tested and found to comply with the limits for a Class A computing device pursuant to Subpart J of Part 15 of FCC Rules, which are designed to provide reasonable protection against such interference when operated in a commercial environment. Operation of this equipment in a residential area is likely to cause interference in which case the user at his own expense will be required to take whatever measures may be required to correct the interference.

**Instructions to User:** Properly shielded and grounded cables and connectors must be used for connection to peripherals in order to meet FCC emission limits. Proper cables are available from IBM. IBM is not responsible for any radio or television interference caused by using other than recommended cables or by unauthorized modifications to this equipment. It is the responsibility of the user to correct such interference.

**Canadian Department of Communications compliance statement:** This equipment does not exceed Class A limits per radio noise emissions for digital apparatus, set out in the Radio Interference Regulation of the Canadian Department of Communications. Operation in a residential area may cause unacceptable interference to radio and TV reception requiring the owner or operator to take whatever steps are necessary to correct the interference.

**Avis de conformité aux normes du ministère des Communications du Canada:** Cet équipement ne dépasse pas les limites de Classe A d'émission de bruits radioélectriques pour les appareils numériques, telles que prescrites par le Règlement sur le brouillage radioélectrique établi par le ministère des Communications du Canada. L'exploitation faite en milieu résidentiel peut entraîner le brouillage des réceptions radio et télé, ce qui obligerait le propriétaire ou l'opérateur à prendre les dispositions nécessaires pour en éliminer les causes.

**The United Kingdom Telecommunications Act 1984:** This apparatus is approved under the approval No. NS/G/23/J/100003 for the indirect connections to the public telecommunications systems in the United Kingdom.

### **Third Edition (September, 1990)**

This edition replaces and makes obsolete the previous edition, GC26-4495-1.

Changes are made periodically to this publication; before using this publication in connection with the operation of IBM systems, consult the latest *IBM System/370, 30xx, 4300, and 9370 Processors Bibliography*, GC20-0001, for the editions that are applicable and current.

The changes for this edition are summarized under "Summary of Changes" following the preface. Specific changes are indicated by a vertical bar to the left of the change. A vertical bar to the left of a figure caption indicates that the figure has changed. Editorial changes that have no technical significance are not noted.

Requests for IBM publications should be made to your IBM representative or to the IBM branch office serving your locality. If you request publications from the address given below, your order will be delayed because publications are not stocked there.

A Reader's Comment Form is provided at the back of this publication. If the form has been removed, comments may be addressed to IBM Corporation, Department J58, P. O. Box 49023, San Jose, California, U.S.A. 95161-9023. IBM may use or distribute whatever information you supply in any way it believes appropriate without incurring any obligation to you.

**© Copyright International Business Machines Corporation 1987, 1990. All rights reserved.**

Note to U.S. Government Users — Documentation related to restricted rights — Use, duplication or disclosure is subject to restrictions set forth in GSA ADP Schedule Contract with IBM Corp.

# Contents

<b>Preface</b> .....	1
About This Book .....	1
Tips on Using this Book .....	2
Terminology .....	3
The Storage Subsystem Library .....	3
Library Overview .....	6
3390 Direct Access Storage Publications .....	6
3990 Storage Control Publications .....	6
3380 Direct Access Storage Publications .....	7
Storage Subsystem Library Shared Publications .....	8
Storage Subsystem Library Ordering Information .....	8
3390 and 3990 Publications .....	9
3380 and 3990 Publications .....	10
Storage Subsystem Library Binders .....	11
Related Publications .....	11
<b>Summary of Changes</b> .....	13
Third Edition, September 1990 .....	13
<b>Chapter 1. Introduction</b> .....	15
Characteristics of an Error .....	15
Types of Errors .....	15
Understanding Error Recoverability .....	16
Handling Data Checks .....	17
Repeatability and Visibility of Data Checks .....	17
Source of Data Checks .....	18
Impact of Data Checks .....	20
<b>Chapter 2. The Error Handling Process</b> .....	21
Overview .....	21
The Role of the Storage Subsystem .....	22
Sense Information .....	22
Subsystem Counting and Logging .....	23
The Role of the Operating System Error Recovery Procedures .....	23
System Recovery Actions .....	23
System Logging .....	24
System Console Messages .....	24
Routine Practices .....	24
Backing up Volumes .....	24
Using EREP to Generate Reports .....	25
Performing Media Maintenance .....	26
Understanding Concurrent Media Maintenance .....	26
<b>Chapter 3. Performing Media Maintenance on SIM DASD</b> .....	27
Using the Service Information Message (SIM) .....	27
Identifying the Need for Service .....	27
Using the Console SIM Alert .....	28
Using EREP Reports for SIM DASD .....	33
Interpreting the Service Information Messages Report .....	33
Understanding the Asynchronous Notification Record Detail Report .....	35
The Steps in Handling a SIM .....	36
Automating the Steps in Handling a SIM .....	38

Using NetView in an MVS Environment .....	38
Using the PROP Facility in VM .....	41
<b>Chapter 4. Performing Media Maintenance on Non-SIM DASD .....</b>	<b>43</b>
Handling Errors on Non-SIM DASD .....	43
Using Concurrent Media Maintenance on Non-SIM DASD .....	43
Identifying the Error .....	43
Using the System Exception Reports .....	44
System Error Summary (Part 2) Report .....	46
DASD Subsystem Exception Report .....	48
DASD Data Transfer Summary .....	50
The Steps in Handling Errors on Non-SIM DASD .....	53
Additional Activities .....	56
<b>Chapter 5. Device Support Facilities .....</b>	<b>57</b>
Overview of Media Maintenance .....	57
Establishing Guidelines for Performing Media Maintenance .....	58
Using Concurrent Media Maintenance .....	58
Performing Media Maintenance on Dual Copy Volumes .....	59
Performing Media Maintenance in VM .....	59
The ANALYZE Command .....	59
ANALYZE on Dual Copy Volumes .....	60
How to Use ANALYZE DRIVETEST .....	60
What to Expect from ANALYZE DRIVETEST .....	60
How ANALYZE SCAN Works .....	60
What to Expect from ANALYZE SCAN .....	61
The INSPECT Command .....	62
INSPECT on Dual Copy Volumes .....	62
How INSPECT Works for Surface Checking .....	62
How to Use INSPECT for Surface Checking .....	64
What to Expect from INSPECT When Surface Checking .....	65
Rewriting Data with INSPECT .....	65
What to Expect from INSPECT When Rewriting Data .....	66
The INIT Command .....	66
Rewriting Home Address (HA) and Record Zero (R0) with INIT .....	67
How To Use INIT for Rewriting HAs and R0s (Medial Initialization) .....	67
Reclaiming Alternate Blocks with INIT .....	68
What to Expect from INIT When Reclaiming Alternate Blocks .....	68
The INSTALL Command .....	68
Using INSTALL to Change Modes on a 3390 .....	68
What to Expect from the INSTALL Command .....	69
The REVALIDATE Command .....	69
How to Use REVALIDATE .....	69
What to Expect From REVALIDATE .....	70
<b>Appendix A. Background Information .....</b>	<b>71</b>
Resources for Additional Information .....	71
DASD Physical Characteristics .....	71
Disk Surface Structure - Tracks .....	72
Access to the Disk Surface .....	72
Cylinders .....	72
Packaging .....	72
Tracks and Records on CKD and FBA Devices .....	73
Logical and Physical Record Relationship .....	73
Physical Records (CKD Devices) .....	73
Count-Key-Data Record Format .....	74

Physical Records (FEA Devices)	76
Fixed-Block Architecture Record Format	76
Identification of Storage Subsystem Components	77
I/O Address	77
Physical Identifier	78
The Components of the Storage Subsystem	78
Disk Storage	78
Controllers	79
Storage Control	79
Direct Channel Attach	79
<b>Appendix B. Specific Guidelines by DASD Type</b>	<b>81</b>
Error Handling for 3330	83
Special Instructions	83
3330 Condition 1 - Permanent Data Check at 1 to 10 Tracks	84
3330 Condition 2 - Temporary Data Checks at Known Tracks	85
3330 Condition 3 - Temporary Data Checks at Unknown Tracks	85
3330 Condition 4 - Permanent Data Checks at 11 or More Tracks	85
Error Handling for the 3340	86
3340 Condition 1 - Permanent Data Checks at 1 to 10 Tracks	86
3340 Condition 2 - Temporary Data Checks	87
3340 Condition 3 - Permanent Data Checks at 11 or More Tracks	87
Error Handling for 3344	88
3344 Condition 1 - Permanent Data Checks at 1 to 10 Tracks	88
3344 Condition 2 - Temporary Data Checks	89
3344 Condition 3 - Permanent Data Checks at 11 or More Tracks	89
Error Handling for 3350	90
Special Instructions	90
3350 Condition 1 - Permanent or Temporary Data Checks with 4940/4941 Symptom Code	91
3350 Condition 2 - Permanent Data Checks at 1 to 10 Tracks	92
3350 Condition 3 - Temporary Data Checks at Known Tracks	93
3350 Condition 4 - Temporary Data Checks at Unknown Tracks	93
3350 Condition 5 - Permanent Data Checks at 11 or More Tracks	93
Error Handling for 3370	94
Special Instructions	94
3370 Condition 1 - Permanent Data Checks at 1 to 10 Blocks	94
3370 Condition 2 - Temporary Data Checks at Known Blocks	95
3370 Condition 3 - Temporary Data Checks at Unknown Blocks	95
3370 Condition 4 - Permanent Data Checks at 11 or More Blocks	95
Error Handling for 3375 and 3380	96
Special Instructions	96
3375 and 3380 Condition 1 - Temporary Data Checks with Offset at 3 or More Tracks	99
3375 and 3380 Condition 2 - Permanent Data Checks at 1 to 10 Tracks	100
3375 and 3380 Condition 3 - Temporary Data Checks	101
3375 and 3380 Condition 4 - Permanent Data Checks at 11 or More Tracks	101
Error Handling for 3390	102
Special Instructions	102
3390 Media Maintenance Procedure 1	103
3390 Media Maintenance Procedure 3	104
3390 Media Maintenance Procedure 5	105
3390 Media Maintenance Procedure 7	106
3390 Media Maintenance Procedure 9	107
Error Handling for 9332	108
9332 Condition 1 - Field Replaceable Unit (FRU) Replacement	108

9332 Condition 2 - Alternate Block Assignment	108
9332 Condition 3 - File Backup	109
Error Handling for 9335	110
Special Instructions	110
9335 Condition 1 - Temporary Data Checks on Multiple Devices	110
9335 Condition 2 - Permanent Data Checks at 1 or 2 Blocks	111
9335 Condition 3 - Permanent Data Check at 3 or More Blocks	111
9335 Condition 4 - Temporary Data Checks at 1 to 3 Blocks	112
9335 Condition 5 - Temporary Data Check at More Than 3 Blocks	112
9335 Condition 6 - Sector Read Retry Exceeded	113
9335 Condition 7 - Alternate Block Assignment Fails	113
<b>Acronyms and Abbreviations</b>	115
<b>Glossary</b>	117
<b>Bibliography</b>	121
<b>Index</b>	125

# Figures

1.	The Storage Subsystem Library Publications	5
2.	3390 and 3990 Subsets	9
3.	3380 and 3990 Subsets	10
4.	Effects of Failures	19
5.	Description of the 3390 SIM Alert Fields	29
6.	Sample SIM Alert Message in VSE	30
7.	SIM Alert Messages and Recommended Responses in VSE	31
8.	General Description of SIM Alert Severity Fields for 3990 and 3390	31
9.	Interpreting the Severity Field of the SIM Alert by Failing Component	32
10.	Service Information Messages Report Example	34
11.	Asynchronous Notification Record Detail Report Example	35
12.	The Steps in Handling a SIM	36
13.	Example of the MVS REXX EXEC	39
14.	Modifications to the RTABLE for VM	41
15.	REXX EXEC Used for Automated Generation of EREP Reports in VM	42
16.	How Volumes are Listed in the System Error Summary Report	45
17.	How Volumes are Listed in the DASD Subsystem Exception Report	45
18.	How Volumes are Listed in the DASD Data Transfer Summary	45
19.	Comparison Summary of Relevant System Exception Report Contents	46
20.	The System Error Summary Report	47
21.	DASD Subsystem Exception Report Example	49
22.	DASD Data Transfer Summary Example	51
23.	The Steps in Error Handling	53
24.	Disks with Two Read/Write Heads per Surface	71
25.	Count-Key-Data (CKD) Track and Record Formats	74
26.	Fixed-Block Architecture (FBA) Track and Record Formats	76
27.	Example of Locating 3350 Symptom Code	90
28.	Example of DASD Data Transfer Summary Report, with Offset Invoked	96
29.	Example of DASD Data Transfer Summary Report, without Offset Invoked	98





---

## Special Notices

References in this publication to IBM products, programs or services do not imply that IBM intends to make these available in all countries in which IBM operates.

Any reference to an IBM licensed program or other IBM product in this publication is not intended to state or imply that only IBM's program or other product may be used. Any functionally equivalent program which does not infringe any of IBM's intellectual property rights may be used instead of the IBM product. Evaluation and verification of operation in conjunction with other products, except those expressly designated by IBM, is the user's responsibility.

IBM may have patents or pending patent applications covering subject matter in this document. The furnishing of this document does not give you any license to these patents. You can send license inquiries, in writing, to the IBM Director of Commercial Relations, IBM Corporation, Purchase, NY 10577.

---

## Trademarks

The following terms, asterisked in this publication, are trademarks of the IBM Corporation in the United States and/or other countries:

ECKD  
ESA/370  
IBM  
MVS/ESA  
MVS/XA  
NetView  
System/360  
System/370  
VM/ESA  
VM/XA  
VSE/ESA  
VSE



---

## Preface

This manual is part of the Storage Subsystem Library (SSL) – a set of manuals that provides information about the hardware components of IBM disk storage subsystems. Although the SSL is concerned primarily with 3380 and 3390 direct access storage devices (DASD), information is provided for the following DASD types as well: 3330, 3333, 3340, 3344, 3350, 3370, 3375, 9332, and 9335.

This manual is written for the storage administrator, system programmer, or hardware performance specialist who is responsible for providing and maintaining required levels of storage subsystem availability and performance.

The information in this book helps you understand the types of errors that require your attention. It also tells you what tools are available to help you evaluate error situations and select the appropriate corrective action. By using the disk storage media maintenance facilities described here, you can:

- Ensure data accessibility for your user community and applications
- Reduce the time spent in problem determination
- Anticipate and fix problems before serious errors occur
- Reduce the number of calls for outside service
- Reduce performance degradation caused by disk storage errors.

The information applies generally to the MVS, VM, and VSE operating environments.

---

## About This Book

You can use this book either as a guide for handling specific error conditions, or as a learning tool for understanding and maintaining the disk storage subsystems at your processing complex.

This manual contains:

**“Chapter 1. Introduction” on page 15**, describes the characteristics of errors and the handling of checks.

**“Chapter 2. The Error Handling Process” on page 21**, explains the respective roles of the operating system and the storage subsystem in detecting errors and recovering from problems. This chapter recommends routine practices for maintaining disk storage media effectively. In addition, this chapter introduces concurrent media maintenance.

**“Chapter 3. Performing Media Maintenance on SIM DASD” on page 27**, describes the use of service information messages (SIMs) and the Service Information Messages report. This chapter also provides step-by-step procedures for performing media maintenance for devices that produce SIMs and describes how you can automate the media maintenance process.

**“Chapter 4. Performing Media Maintenance on Non-SIM DASD” on page 43**, describes how to handle errors for devices that do not produce SIMs. This chapter emphasizes the use of the System Exception Reports produced by the Environmental Record Editing and Printing (EREP) program for disk storage activity.

**“Chapter 5. Device Support Facilities” on page 57**, describes the specific Device Support Facilities commands and functions that you can use in correcting disk media errors. This chapter provides guidelines for using concurrent media maintenance, and also describes how to use Device Support Facilities to initiate the procedure.

**Appendix A, “Background Information” on page 71**, contains background material on several concepts related to direct access storage devices and the storage subsystem, and is included to give you an understanding of how direct access storage devices work.

**Appendix B, “Specific Guidelines by DASD Type” on page 81**, provides the explicit details for using the generally applicable instructions in Chapters 2, 3, 4, and 5.

**“Glossary” on page 117**, lists the terms used in the Storage Subsystem Library manuals.

**“Bibliography” on page 121**, lists the related publications that you may want to refer to while performing the tasks in this manual.

---

## Tips on Using this Book

If you are interested in learning about error handling and maintenance processes, you should read all the chapters in this manual. If you are not familiar with EREP and Device Support Facilities, you should consider reading Chapters 2 and 5 before you read Chapters 3 and 4.

If you are not acquainted with disk storage technology, you should start by reading Appendix A, “Background Information” on page 71 to gain a basic understanding of disk storage hardware and its operation.

In most cases, the body of this book (Chapters 1 through 5) and Appendix A, “Background Information” apply to all of the direct access storage devices listed at the beginning of this preface. Information concerning specific DASD types is located in Appendix B, “Specific Guidelines by DASD Type” on page 81. Some of the maintenance and error handling features unique to the newer 3380 and 3390 models are presented in the main chapters; the applicability of such material is clearly identified.

If you want to look up information related to a specific error condition on a particular type of DASD, you will find the index, the contents, and the partial contents at the beginning of Appendix B, “Specific Guidelines by DASD Type” on page 81 helpful in locating information quickly.

The comparison table of EREP reports (Figure 19 on page 46) can help you to quickly identify the report you need for a specific situation for devices that do not produce SIMs. For devices that produce SIMs, the Service Information Messages Report is the only report necessary for identifying error situations.

---

## Terminology

A glossary is provided at the back of this book; however, the following terms have a precise meaning in this book:

**controller** refers to the hardware component of a DASD head-of-string unit which provides the path control and data transfer functions (sometimes referred to as a **device adapter** for the 3390).

**DASD SIM** refers to a SIM that informs you of a hardware error that has occurred on the 3390 requiring the attention of your IBM service representative. A DASD SIM is also referred to as a **SERVICE ALERT** on the EREP System Exception reports. The term DASD SIM will be used throughout this book unless there is a specific example of a **SERVICE ALERT** on a System Exception Report.

**device adapter** performs the controller functions in a 3390 A-unit, and is referred to as controller throughout this book.

**ERDS** refers to the area in which error records are logged for any operating environment. For example, ERDS information is stored in SYS1.LOGREC by MVS, in SYSREC by VSE, and in the error recording area by VM.

**media SIM** refers to a SIM informing you that an error that requires your attention has occurred on the 3390 disk media.

**non-SIM DASD** refers to a direct access storage device that does not produce SIMs, for example, 3380 and prior DASD.

**operating system** refers to the MVS, VM, or VSE operating environment. The term is sometimes shortened to "system" in this book.

**SIM** refers to a service information message generated by the 3990-3390 subsystem to indicate that an abnormal condition exists and service action is required. This book discusses SIMs that relate to the 3390 only. For a discussion of SIMs that relate to the 3990, see the *IBM 3990 Storage Control Planning, Installation, and Storage Administration Guide*.

**SIM Alert** refers to the message that is received at the operator console when a SIM is generated. The term SIM Alert refers to both **MEDIA ALERT** and **DASD ALERT**.

**SIM DASD** refers to a direct access storage device that produces SIMs, specifically a 3390.

**storage subsystem** refers to a storage control and its attached storage devices. The term is sometimes shortened to subsystem in this book.

---

## The Storage Subsystem Library

The SSL provides information for using DASD and storage control units. This library describes features, characteristics, capabilities and configuration options for the storage devices. In addition, the library offers detailed instructions for planning configurations, installing devices, manipulating data and managing the use of devices effectively in various IBM operating environments (MVS, VM and VSE).

The SSL also specifies software requirements for storage devices and offers direction on using required system products as well as optional storage management tools, such as DFDSS in the MVS environment. The SSL complements related software libraries and the MVS Storage Management Library by providing device-specific information on managing storage resources.

Figure 1 on page 5 shows the relationship among the SSL books (and subsets) in terms of high-level tasks described in each book. Following that, under "Library Overview" on page 6, the books of each subset are summarized providing an overview of their contents. Each book contains a glossary of terms, a bibliography, and an index of its contents.

# Storage Subsystem Library

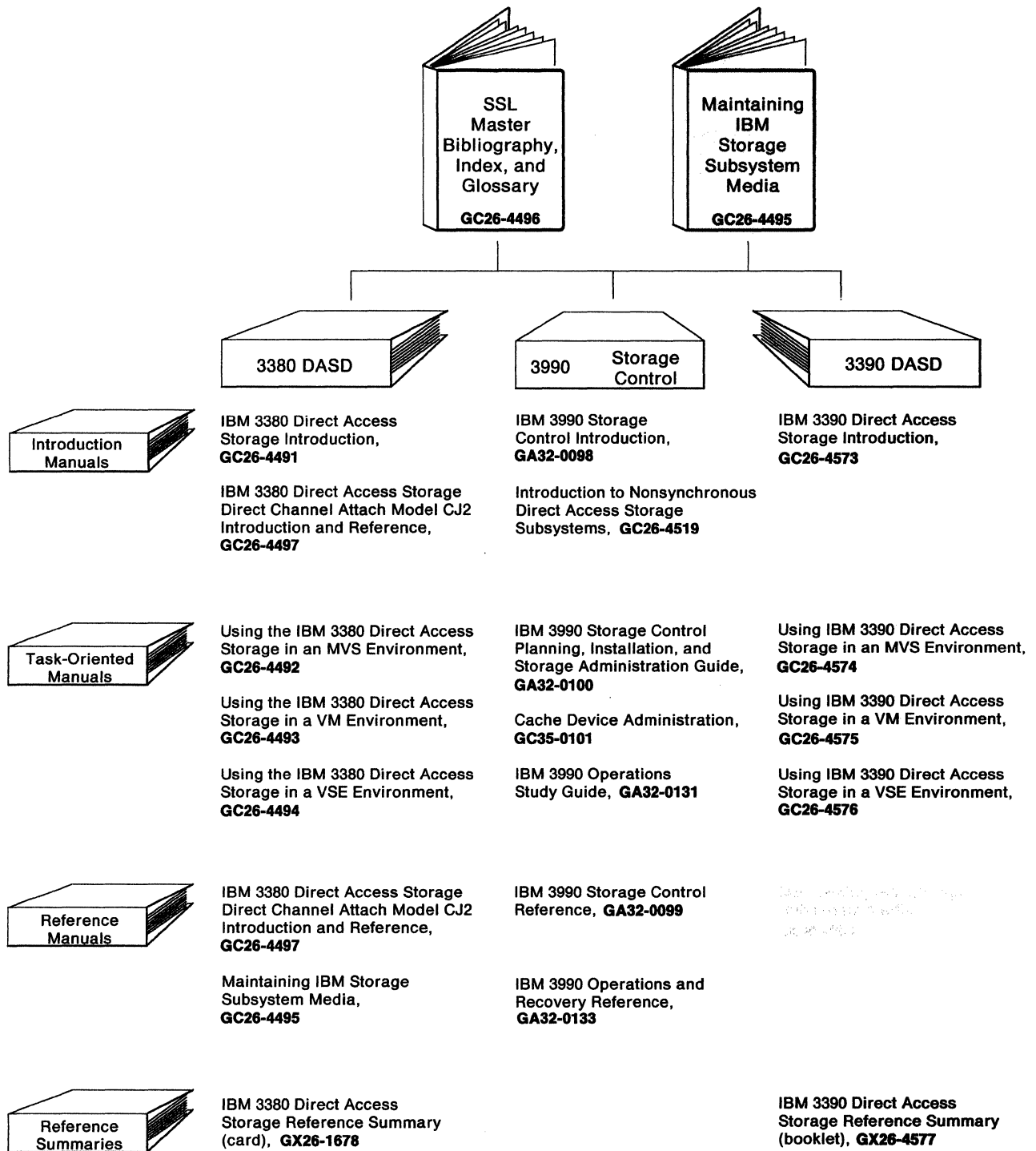

Figure 1. The Storage Subsystem Library Publications



---

## Library Overview

### 3390 Direct Access Storage Publications

The 3390 subset of the SSL includes:

- *IBM 3390 Direct Access Storage Introduction, GC26-4573*  
Provides a complete description of each 3390 model, including characteristics, features, and capabilities. In addition, configuration and attachment options are described along with related information to help you design a subsystem to meet your needs.
- *Using IBM 3390 Direct Access Storage in an MVS Environment, GC26-4574*  
Provides specific guidance for using 3390s in an MVS operating environment. The book provides detailed instruction for planning the addition of new 3390 devices, installing devices, moving data to new devices, and performing ongoing storage subsystem management.
- *Using IBM 3390 Direct Access Storage in a VM Environment, GC26-4575*  
Provides specific guidance for using 3390s in a VM operating environment. The book provides detailed instruction for planning the addition of new 3390s, installing devices, moving data to new devices, and performing ongoing storage subsystem management. In addition, this book discusses storage considerations related to guest systems.
- *Using IBM 3390 Direct Access Storage in a VSE Environment, GC26-4576*  
Provides specific guidance for using 3390s in a VSE operating environment. The book provides instruction for planning the addition of new 3390s, installing devices, moving data to new devices, and performing ongoing storage subsystem management.
- *IBM 3390 Direct Access Storage Reference Summary, GX26-4577*  
Provides a summary of 3390 capacity, performance, and operating characteristics in a compact, portable card form.

### 3990 Storage Control Publications

The 3990 subset of the SSL includes:

- *IBM 3990 Storage Control Introduction, GA32-0098*  
Provides a complete description of the various models of the 3990 Storage Control, including its data availability, performance, and reliability improvements over previous storage controls. In addition, the book provides descriptions of the configuration attachment options, optional features, performance characteristics, and software support of the 3990 Storage Control.
- *IBM 3990 Storage Control Planning, Installation, and Storage Administration Guide, GA32-0100*  
Provides a functional description of the 3990 Storage Control. The book describes the planning, program installation, and storage management tasks used in typical environments. Configuration examples and sample programs for controlling the various functions of the 3990 Storage Control are provided.

- *IBM 3990 Storage Control Reference, GA32-0099*  
Provides descriptions and reference information for the 3990 Storage Control. The book contains channel commands, error recovery, and sense information.
- *Cache Device Administration, GA35-0101*  
Specifies the access method services tools for administering a cache device under MVS. The book supports the following storage controls: 3990 Model 3, 3880 Model 23, 3880 Model 21, 3880 Model 13, and 3880 Model 11.
- *IBM 3990 Operations Study Guide, GA32-0131*  
A study guide for operators of 3990 storage subsystems. Provides general information on system control program commands and messages, and guidelines for basic problem determination.
- *IBM 3990 Operations and Recovery Reference, GA32-0133*  
A user's guide for operators of 3990 storage subsystems. Provides general guidelines for 3990 problem determination, testing of 3990 extended functions, and also provides recommended recovery actions for the 3990.
- *Introduction to Nonsynchronous Direct Access Storage Subsystems, GC26-4519*  
Provides specific information for programmers responsible for writing DASD channel programs that operate in a nonsynchronous environment. This book defines synchronous and nonsynchronous operations, explains ECKD data transfer commands, and provides examples of using ECKD commands to build nonsynchronous channel programs.

### **3380 Direct Access Storage Publications**

The 3380 subset of the SSL includes:

- *IBM 3380 Direct Access Storage Introduction, GC26-4491*  
Provides a complete description of the various models of the 3380, including characteristics, features, and capabilities. In addition, the configuration and attachment options are described along with other information that helps in designing a storage subsystem to meet your needs. This book does *not* cover 3380 Model CJ2.
- *IBM 3380 Direct Access Storage Direct Channel Attach Model CJ2 Introduction and Reference, GC26-4497*  
Provides a complete description of the 3380 direct channel attach Model CJ2 characteristics, features, capabilities, and string configuration options.
- *Using the IBM 3380 Direct Access Storage in an MVS Environment, GC26-4492*  
Provides specific guidance for using the 3380 in an MVS environment. The book provides detailed instruction for planning the addition of new 3380 devices from a logical and physical point of view, installing devices, moving data to new devices, and performing some ongoing activities to maintain a reliable storage subsystem.

- *Using the IBM 3380 Direct Access Storage in a VM Environment, GC26-4493*  
Provides specific guidance for using the 3380 in a VM operating environment. The book provides detailed instruction for planning the addition of new 3380 devices, installing devices, moving data to new devices, and performing ongoing storage management activities to maintain reliable performance and availability. In addition, this manual discusses storage considerations related to guest systems.
- *Using the IBM 3380 Direct Access Storage in a VSE Environment, GC26-4494*  
Provides specific guidance for using the 3380 in a VSE operating environment. The book provides instruction for planning the addition of new 3380 devices, installing devices, moving data to new devices, and performing ongoing storage subsystem management.
- *IBM 3380 Direct Access Storage: Reference Summary, GX26-1678*  
Provides a summary of 3380 capacity, performance, and operating characteristics in a portable, compact card form.

## Storage Subsystem Library Shared Publications

The following publications contain information relevant to the entire SSL.

- *Maintaining IBM Storage Subsystem Media, GC26-4495*  
Describes how the storage subsystem and the various operating systems handle disk storage errors and provides instruction on using the EREP program and the Device Support Facilities (ICKDSF) program to diagnose and correct disk media errors. Recovery procedures are provided for the various device types. In addition, background material on DASD concepts is included.
- *Storage Subsystem Library Master Bibliography, Index, and Glossary, GC26-4496*  
Provides a central source for information related to storage subsystem topics. Books for IBM 3390 DAS, IBM 3380 DAS, and 3990 Storage Controls are indexed in this publication. The manual also includes an overview of the material in the Storage Subsystem Library.

---

## Storage Subsystem Library Ordering Information

You can order the entire SSL or parts of it tailored to your hardware and software environment with bill of form numbers.

## 3390 and 3990 Publications

You can obtain a copy of **every manual** in the 3390 and 3990 subsets of the SSL with one order number, **GBOF-3124**. Select one of the following bill of form numbers to obtain information tailored to your hardware and software environment. To obtain an individual manual, use its order number.

Title	MVS GBOF- 3121	VM GBOF- 3122	VSE GBOF- 3123	3990 GBOF- 0366	SSL GBOF- 3124
<i>IBM 3390 Direct Access Storage Introduction, GC26-4573</i>	X	X	X		X
<i>Using IBM 3390 Direct Access Storage in an MVS Environment, GC26-4574</i>	X				X
<i>Using IBM 3390 Direct Access Storage in a VM Environment, GC26-4575</i>		X			X
<i>Using IBM 3390 Direct Access Storage in a VSE Environment, GC26-4576</i>			X		X
<i>Maintaining IBM Storage Subsystem Media, GC26-4495</i>	X	X	X		X
<i>IBM 3390 Direct Access Storage Reference Summary, GX26-4577</i>	X	X	X		X
<i>IBM 3990 Storage Control Introduction, GA32-0098</i>				X	X
<i>IBM 3990 Storage Control Planning, Installation, and Storage Administration Guide, GA32-0100</i>				X	X
<i>IBM 3990 Storage Control Reference, GA32-0099</i>				X	X
<i>Cache Device Administration, GC35-0101</i>				X	X
<i>IBM 3990 Operations Study Guide, GA32-0133</i>				X	X
<i>IBM 3990 Operations and Recovery Reference, GA32-0133</i>				X	X
<i>Introduction to Nonsynchronous Direct Access Storage Subsystems, GC26-4519</i>				X	X
<i>Storage Subsystem Library Master Bibliography, Index, and Glossary, GC26-4496</i>	X	X	X	X	X
<i>Binder and 3390 inserts, GX26-3777</i>	X	X	X		X
<i>Binder and 3990 inserts, GX26-3768</i>				X	X

Figure 2. 3390 and 3990 Subsets

## 3380 and 3990 Publications

You can obtain a copy of **every manual** in the 3380 and 3990 subsets of the SSL using one General Bill of Forms (GBOF) number, **GBOF-1762**. Select one of the following bill of form numbers to obtain information tailored to your hardware and software environment. To obtain an individual manual, use its order number.

Title	MVS GBOF- 1756	VM GBOF- 1757	VSE GBOF- 1758	CJ2/MVS GBOF- 1759	CJ2/VM GBOF- 1760	CJ2/VSE GBOF- 1761	3990 GBOF- 0366
<i>IBM 3380 Direct Access Storage Introduction, GC26-4491</i>	X	X	X				
<i>IBM 3380 Direct Access Storage Direct Channel Attach Model CJ2 Introduction and Reference, GC26-4497</i>				X	X	X	
<i>Using IBM 3380 Direct Access Storage in an MVS Environment, GC26-4492</i>	X			X			
<i>Using IBM 3380 Direct Access Storage in a VM Environment, GC26-4493</i>		X			X		
<i>Using IBM 3380 Direct Access Storage in a VSE Environment, GC26-4494</i>			X			X	
<i>Maintaining IBM Storage Subsystem Media, GC26-4495</i>	X	X	X	X	X	X	
<i>IBM 3380 Direct Access Storage Reference Summary, GX26-1678</i>	X	X	X	X	X	X	
<i>IBM 3990 Storage Control Introduction, GA32-0098</i>							X
<i>IBM 3990 Storage Control Planning, Installation, and Storage Administration Guide, GA32-0100</i>							X
<i>IBM 3990 Storage Control Reference, GA32-0099</i>							X
<i>Cache Device Administration, GC35-0101</i>							X
<i>IBM 3990 Operations Study Guide, GA32-0133</i>							X
<i>IBM 3990 Operations and Recovery Reference, GA32-0131</i>							X
<i>Introduction to Nonsynchronous Direct Access Storage Subsystems, GC26-4519</i>							X
<i>Storage Subsystem Library Master Bibliography, Index, and Glossary, GC26-4496</i>	X	X	X	X	X	X	X
<i>Binder and 3380 inserts, GX26-3767</i>	X	X	X	X	X	X	
<i>Binder and 3990 inserts, GX26-3768</i>							X

Figure 3. 3380 and 3990 Subsets

## Storage Subsystem Library Binders

You can organize your library with binder kits. Kits consist of a binder with identifying cover and spine inserts for 3390, 3380, or 3990 manuals, and are included when you order the following numbers:

- GBOF-3121 through GBOF-3123 include a binder with 3390 inserts.
- GBOF-1756 through GBOF-1761 include a binder with 3380 inserts.
- GBOF-0366 includes a binder with 3990 inserts.
- GBOF-3124 includes binders and inserts for both 3990 and 3390.
- GBOF-1762 includes binders and inserts for both 3990 and 3380.

Binder kits may also be ordered separately.

- Order number GX26-3777 contains a binder and 3390 inserts.
- Order number GX26-3767 contains a binder and 3380 inserts.
- Order number GX26-3768 contains a binder and 3990 inserts.

---

## Related Publications

This manual is intended for use in conjunction with the following publications.

- **Error Recovery Information**

*IBM 3990 Operations and Recovery Reference, GA32-0133*

Provides guidelines for problem determination, testing of 3990 extended functions, and recommended recovery actions.

- **Device Support Facilities**

*Device Support Facilities User's Guide and Reference, GC35-0033*

Contains information on command syntax, parameters and use of media maintenance functions for all IBM DASD types. This manual describes differences in executing maintenance operations in supported operating environments.

*Device Support Facilities: Primer for the User of IBM Direct Access Storage, GC26-4498*

Provides an overview of the Device Support Facilities product and its intended use and capabilities with the IBM 3380 and 3390 family of direct access storage devices.

- **EREP Information**

*Environmental Record Editing and Printing Program User's Guide and Reference, GC28-1378*

Provides information on how to obtain reports needed for routine maintenance and error handling. The EREP manual explains how to designate a physical ID that the EREP program can use and what unique device information you may need. This manual provides instructions for obtaining and reading the System Exception Reports.

**EREP Release Level**

The examples presented in this manual assume you are operating on EREP Version 3.4.1 or higher.

- **3380 Information on Moving Data**

Occasionally it is necessary to move data to another volume before performing media maintenance activities. Refer to the appropriate Storage Subsystem Library operating environment manual for your device type, listed in "The Storage Subsystem Library" on page 3 for further references on copying data in the MVS, VM or VSE environment.

- **Storage Control Information**

The following manuals provide information on error recovery procedures for the 3880 Storage Control with descriptions of sense information and formats:

- *IBM 3880 Storage Control Models 1, 2, 3 and 4 Description Manual*
- *IBM 3880 Storage Control Model 11 Description*
- *IBM 3880 Storage Control Model 13 Description*
- *IBM 3880 Storage Control Model 21 Description*
- *IBM 3880 Storage Control Model 23 Description*

See the appropriate 3390 manual listed in Figure 1 on page 5 for information on error recovery procedures and descriptions of sense information and formats for 3990 storage controls.

Other publications referenced in this manual that may provide additional related information are included in the "Bibliography" on page 121. The bibliography includes a short description of each publication.

---

# Summary of Changes

---

## Third Edition, September 1990

---

Technical additions include:

- New information regarding ICKDSF Release 12, primarily related to directed I/O for dual copy.
- VSE/SP Version 4, Release 1.2 support for IBM 3390 Direct Access Storage.
- Updates to media maintenance procedures in Appendix B.

In addition to the technical changes listed above, the following non-technical change has been made:

- The information presented in this book has been reorganized to separate specific SIM and non-SIM information. This change will help to focus on new information for future products, as it becomes available.

A vertical bar in the left margin indicates a specific change to the text. Vertical bars do not appear next to editorial changes that have no technical significance.





---

# Chapter 1. Introduction

Knowing what an error is and how to handle an error is important to maintaining your IBM® storage subsystem. This book provides information about identifying types of errors and provides guidance in handling errors that can occur on the storage media, or disk surface. You need to know the types of errors that can occur, and how the error type should be handled.

---

## Characteristics of an Error

This section explains the various attributes of an error situation. Depending on these specific attributes, or characteristics, the subsystem and system handle the error by employing specific techniques. The following attributes, described in this section, must be considered when evaluating any error situation:

- Type
- Recoverability

Additional characteristics and considerations of special interest for handling the data check type of errors are described in "Handling Data Checks" on page 17.

## Types of Errors

The categories for describing disk storage errors are: **data check**, **programming check**, **overrun**, and **equipment check**. The category, or type, is indicated in the sense information, console messages, and reports described in this book. An error type is similar to a symptom; it is evidence of a problem, but does not necessarily reveal either the source or the cause.

**Data Check:** A data check is an error detected in the bit pattern read from the disk. Some data checks are caused by hardware, some are caused by media, and others are the result of random events such as transient electrical interference. A data check can occur as a result of:

- A defect on the surface of the media
- An error when writing the data
- A hardware error when reading the data
- A random event.

**Programming Check:** A programming check, such as an invalid track format or incorrect record specification, causes a unit check. This type of error is indicated to either the system or subsystem, and is always returned to the requesting program.

**Overrun:** An overrun is a condition that exists because the data cannot be received at the rate it is transmitted. It is usually the result of timing and usually will not recur if the I/O operation is retried.

**Equipment Check:** An equipment check is an error detected in mechanical or electrical operation of the hardware. For the 3390, error conditions that cause seek checks in other DASDs are presented as equipment checks.

---

\* IBM is a trademark of the International Business Machines Corporation.

## Understanding Error Recoverability

When a data or equipment error is detected by the subsystem, either the subsystem or the operating system will attempt recovery, depending on the situation and the type of hardware involved. The terms **temporary** and **permanent** refer to the recoverability of the error.

**Temporary:** An error is temporary if subsystem or system error recovery procedures are successful. A temporary error is only seen by the subsystem or system, and is never returned to the application.

### Terminology

The term **error recording data set (ERDS)** is used in this manual to refer to the area in which error records are logged for any operating environment. For example, ERDS information is stored in SYS1.LOGREC by MVS, in SYSREC by VSE\*, and in the error recording area by VM.

Some DASD types log all temporary errors to the ERDS. However, for the 3390, errors recovered by the subsystem are not logged at the host system. They are logged only when the subsystem requires the assistance of the system error recovery procedures. When necessary, the subsystem will generate a SIM, and send it to the operating system.

**Permanent:** The term permanent has meaning from two different perspectives.

- System view

From the system perspective, an error is permanent if error recovery procedures performed by the operating system or storage subsystem cannot recover from the error condition.

- Application view

An error is permanent from an application perspective if an error indication must be returned to the application. The application is then responsible for determining how to deal with the error.

A data check may be permanent to the system because it cannot be recovered on that path. However, when system error recovery procedures retry the operation from an alternate path, the operation may complete successfully. The application program would not be notified of the error, so the error would not be permanent to the application. On the other hand, if the system error recovery procedures are not successful, the data check is permanent from both the system and application points of view.

Throughout this manual, permanent refers to errors from the system view, unless otherwise noted.

---

\* VSE is a trademark of the International Business Machines Corporation.

## Recoverability by Error Type

An error is recoverable if it is not seen as a permanent error by the application.

**Data Check:** When data is written, additional control information is recorded along with the data in order to enable data verification when the data is being read. This control information is the error checking and correcting (ECC) bytes. Along with the ability to detect the data check, ECC bytes can provide sufficient information to reconstruct the data in error. When this reconstruction occurs, the data check is designated **ECC-correctable** by the subsystem. ECC-correctable data checks are corrected either by the storage subsystem or by the operating system error recovery procedures. ECC-correctable data checks are always recoverable.

When the ECC bytes are insufficient to reconstruct the data, the data check is designated **ECC-uncorrectable** by the subsystem. Then, either the storage subsystem or operating system will retry the I/O operation. If the retry is unsuccessful, the data check is unrecoverable. This is known as a permanent error.

The techniques used to handle data checks and the role played by the subsystem and system differ for different DASD types.

**Overrun Errors and Equipment Checks:** When an overrun or equipment check is detected, the operation is retried a specific number of times, depending on the DASD. If the operation is successful, the error is recoverable. If retry is not successful within that number of retries, the error is recorded as permanent.

---

## Handling Data Checks

Media maintenance is not required for all data checks. Only the data checks that have an effect on your data require media maintenance actions. Understanding some additional attributes of data checks, namely the repeatability, visibility, and source is helpful when you need to analyze a data check. With the 3390, the subsystem analyzes the errors for you and notifies you when a condition exists that requires you to take corrective action.

## Repeatability and Visibility of Data Checks

Every error has a certain degree of **repeatability**. The repeatability determines the probability of an error being detected for any given read operation. For example, if a data check is 1% repeatable, 99 times out of 100 the data is read error free. Conversely, if a data check is 99% repeatable, 1 time out of 100 the data is read error free.

A data check can occur for defects smaller than the area of a single bit on the surface of the media. Because these defects are so small, data that is rewritten has the potential to "straddle" the defect and prevent subsequent reads from detecting an error. Such an error has low repeatability.

The percentage of time that a data check is detected after multiple write operations determines its **visibility**.

These attributes can be useful when you need to determine whether corrective action should be taken immediately, or scheduled for a time that will minimize the impact to your operations.

## Source of Data Checks

You should correctly identify the source of an error to determine whether you can handle the error situation yourself, or if you will require the assistance of an IBM service representative. Errors that appear to be media-related can actually be the result of a hardware problem. For example, the source of a data check may be:

- A slight misalignment of the head with the center of the track. This is a hardware problem that you can rectify with media maintenance procedures.
- A transient electrical interference. This is a random event and will probably not recur.
- An imperfection on the disk surface. This is a media problem for which you can perform maintenance.
- Controller or device errors. Assistance of an IBM service representative is required.

Determining the source of an error, and then the exact cause, can require analysis of sense information and other diagnostics, such as Device Support Facilities.

**Identifying the Source with SIM DASD:** Some DASD types monitor data checks and other events taking place in the storage subsystem and thoroughly analyze this information for you. When a given event continues to recur, or is serious enough to require attention, the subsystem produces a SIM. The SIM is formatted by the system error recovery procedures, and sent to the operator console to notify the operator that a SIM has been generated. The console SIM provides the following information:

- Whether the source of the problem is media or hardware related.
- An indication of the severity of the SIM being reported.
- If the source of the problem is media related, the media maintenance procedure number that you need to perform.
- The serial number of the failing volume.

The EREP program produces two reports that contain similar information found in the console SIM message. For more information about SIMs and EREP, see "Chapter 2. The Error Handling Process" on page 21 and "Chapter 3. Performing Media Maintenance on SIM DASD" on page 27. For detailed information on the Device Support Facilities media maintenance functions, see "Chapter 5. Device Support Facilities" on page 57.

**Determining the Source with non-SIM DASD:** For DASD that do not produce SIMs, determining the source of an error, and then the exact cause, requires analysis of sense information and possibly other diagnostics such as Device Support Facilities. There are several System Exception Reports produced by EREP that provide the information you need to complete the analysis of the error. For hardware errors, the IBM service representative uses EREP reports and other tools to further isolate the cause of the error and determine the required repair action. The probable source of an error, as defined by the EREP program, is referred to as a **probable failing unit (PFU)** in the System Exception Reports.

If the PFU is a channel, storage control, controller, or device, then the source of the error is defined as the **hardware**. The error might be detected during a write, read, or control operation. Hardware errors usually require the attention of an IBM service representative.

When the cause of the problem is determined to be hardware, it is usually possible to replace the failing component, which might be a logic card, power component, or other field replaceable unit (FRU).

If the PFU is a volume, the source of the error is defined as *media*, or something associated with writing or reading data on the disk media. The error is detected during reading of data from the disk and is called a data check. You can use Device Support Facilities when media maintenance actions are required.

Refer to “Chapter 2. The Error Handling Process” on page 21 for an overall description of the error handling process and to “Chapter 4. Performing Media Maintenance on Non-SIM DASD” on page 43 for more information on EREP System Exception Reports and non-SIM DASD. For detailed information on the Device Support Facilities media maintenance functions, see “Chapter 5. Device Support Facilities” on page 57.

Figure 4 summarizes some of the effects of data checks occurring in the various storage subsystem components.

Failing Component	Effects of the Failure
<b>Channel or Storage Control</b>	<p>Availability of data on all connected DASD strings <i>may be</i> affected. If the error is permanent, data is unavailable through the path associated with the failing component until the problem is corrected.</p> <p>If the storage subsystem configuration includes alternate paths, data can continue to be written and read through another path.</p> <p>If the error is permanent, service for the failing unit is required to restore use of the path.</p> <p>The data on the volume is accessible during the repair action.</p>
<b>Controller</b>	<p>Availability of data on all volumes in the string <i>may be</i> affected. If the error is permanent, data is unavailable through the failing controller until the problem is corrected.</p> <p>If there is an alternate controller (3350, 3375, 3380, 3390), data can continue to be written and read through another controller.</p> <p>If the error is permanent, service is required to restore the controller to use.</p> <p>The data on the volume is accessible during the repair action.</p>
<b>Device</b>	<p>Availability of data on the volume(s) associated with the failing device is affected. If the error is permanent, data is unavailable from the affected volume(s) until the problem is corrected.</p> <p>If the error is permanent, service for the probable failing unit is required to restore its use.</p> <p>The data on the volume is not accessible during the repair action.</p>
<b>Volume</b>	<p>A specific portion of data on volume <i>may be</i> damaged.</p> <p>If the error is temporary (because it was recovered by the subsystem or system), the data remains available. If the error is permanent, the affected data on the track is no longer available.</p> <p>Media maintenance performed with the Device Support Facilities can remedy the cause of the error in most cases. With concurrent media maintenance, it is possible to recover from the error while retaining access to the data on the volume.</p>

Figure 4. Effects of Failures

For more information on concurrent media maintenance, see “Understanding Concurrent Media Maintenance” on page 26 and “Using Concurrent Media Maintenance” on page 58.

## **Impact of Data Checks**

When a data check occurs, the error could affect:

- The operation in progress
- Continued availability of the data
- Continued processing
- The data itself

It is essential to quickly determine the severity and impact of data checks at your data processing center and to correct them. Data checks caused by media errors that are affecting your operation can be corrected using the media maintenance services provided by Device Support Facilities. For detailed information on the Device Support Facilities media maintenance functions, see "Chapter 5. Device Support Facilities" on page 57.

---

## Chapter 2. The Error Handling Process

Maintaining required levels of availability and performance for your data processing system depends upon your recognizing and handling errors that can occur during disk storage operations. Normal processing by the storage subsystem (that is, the storage control and its attached storage devices) and by the operating system (MVS, VM, or VSE) include various functions that recognize errors and recover from them whenever possible. For input/output (I/O) activity, descriptive records of errors may be generated and recorded for future analysis. The storage subsystem and the operating system, communicating with each other, recognize and usually recover from errors before you know they exist.

This chapter gives a general description of the respective roles of the storage subsystem and the operating system in the automatic handling of errors followed by a section that describes regular backup and recovery procedures that can help minimize disruption to your operation. In addition, this chapter provides a brief section on performing media maintenance, including a description of concurrent media maintenance.

---

### Overview

Maintenance facilities provided by the storage subsystem and the operating system help to ensure reliable disk storage operations. Maintenance functions include:

- Notification of conditions that require corrective action (SIMs)
- Statistical counts, such as number of bytes read (MDRs)
- Generating records that describe error activity (CCHs/SLHs, OBRs, MIHs)
- Detecting errors that occur and automatically recovering when possible with error recovery procedures

Each storage subsystem performs some level of error correction activity. The subsystem may send sense information to a host to request recovery actions. In addition, this same sense information may request logging of error or statistical information, if applicable. Refer to "The Role of the Storage Subsystem" on page 22 for a more complete description of sense information.

If an error is detected during execution of a channel command, the subsystem activates its error recovery procedures. If subsystem error recovery is unsuccessful, the system error recovery procedures are activated.

As part of the recovery process, the subsystem can attempt to read the data by offsetting the access mechanism to the left and to the right of the track center. The **offset recovery** process often results in a successful read of the data.

The remainder of this chapter covers the following topics:

- The respective roles of the storage subsystem and the operating system in handling errors
- Routine practices that can help in the error recovery process
- The benefits of performing media maintenance and concurrent media maintenance.



---

## The Role of the Storage Subsystem

The storage subsystem, consisting of the storage control, controller, and disk storage, participates in monitoring I/O activity and error recovery during disk storage operations. (Refer to Appendix A, "Background Information" on page 71 for more information on the subsystem components.)

The subsystem performs the following functions:

- Adds ECC information to each field of a record when it is written.
- Detects errors in reading data, in performing control operations, in functioning of the hardware, and in programming.
- Retries I/O operations for certain error conditions.
- Assembles usage and error information in the form of sense information.
- Maintains counts of disk storage usage factors (such as seeks and number of bytes read), and for some disk storage, maintains counts of errors.
- Some subsystems perform ECC correction activity. Other subsystems send the ECC data to the operating system for correction.

Subsystems that generate SIMs perform the following SIM generation-related tasks, as well as the functions listed above:

- Log all errors internally.
- Determine if SIM reporting is necessary.
- Send the resulting information to the system for presentation of a SIM.

To supplement your understanding of error handling, these topics are discussed in more detail in the remainder of this section.

### Sense Information

Sense information is data that is sent from the subsystem to the operating system when a condition occurs that requires logging to the ERDS or when recovery actions are required by the operating system. These sense bytes identify the conditions that caused the interruption, indicate the type of error, and provide information about where the error was detected. The sense bytes could provide further information for system error recovery procedures and for diagnosing and isolating the cause of an error condition.

The following conditions will cause the subsystem to return sense information to the operating system:

- An error condition that could not be recovered by subsystem retry
- An error condition that was successfully recovered by the subsystem, but is to be logged by the operating system
- An error condition that the subsystem does not retry and presents to the operating system to recover
- Filled counters of usage or errors that need to be sent to the operating system for logging
- The storage subsystem determines there is a need for service

## Subsystem Counting and Logging

A buffered log is kept in the storage control for each disk storage device that attaches to it. The log may contain counts of the seeks made, the bytes read, and overruns. This data may be used by the operating system when performing analysis functions.

For some DASD, counts of data checks and seek checks are also kept.

**For the 3390**, all subsystem activity is buffered in the subsystem and analysis of this data is done at the subsystem level. A SIM is generated and logged in ERDS if any abnormal condition is detected. The SIM provides sufficient information regarding media maintenance and repair actions. Statistical records (MDRs) are also sent to the operating system to be logged in ERDS.

For all other devices, EREP analyzes the data in the ERDS and then determines if media maintenance or repair actions are required. In some cases, additional data may be needed to complete the analysis. For more information on how to acquire additional data, see "The Steps in Handling Errors on Non-SIM DASD" on page 53.

**For the 3380, 3375, 9332, and 9335, and for the 3370 attached to a 3880**, seek checks and data checks are monitored by the subsystem. If either reaches an abnormal level, according to the subsystem standards, sense information for a preset number of subsequent errors is sent to the system for logging.

**For the 3330/3333 and for the 3370 attached directly to a processor**, counts are kept of all data checks and seek checks and are sent to the system.

**For the 3350**, counts are kept of retried data checks and seek checks and are sent to the system.

**For the 3340/3344**, no count is kept of data or seek checks.

---

## The Role of the Operating System Error Recovery Procedures

The operating system provides standard error recovery procedures to handle errors detected by the storage subsystem.

The system error recovery process:

- Implements recovery actions
- Logs usage and error information records
- Issues system messages at the operator console.

More information on each of these functions is included in the remainder of this chapter. In addition, the EREP reports that are used in the media maintenance process are described. These reports are generated from the contents of the ERDS maintained by the system.

## System Recovery Actions

A specific recovery action by the system is based on a particular error condition that was defined in the sense information sent from the subsystem. For example, system recovery actions include retrying an operation when an equipment check is reported in the sense information.

## System Logging

Error data that is sent to the system is stored in the ERDS. The process of recording information in the ERDS is called *logging*.

For logging purposes, the system processes the sense information to produce and supplement data records describing the conditions under which the error occurred. The operating system processes three types of data records for disk storage; all are based on sense information supplied by the subsystem. The three kinds of data records are:

- Usage and error counts
- Synchronous events
- Asynchronous events.

The EREP program formats error reports and may also perform error analysis based on information it obtains from the ERDS. (See “Using EREP to Generate Reports” on page 25.)

## System Console Messages

System console messages may be the initial notification of hardware or media problem. Most information messages contain data on the type and location of an error, and give sense information in hexadecimal format. Generally, console messages can be associated with information in the ERDS. The appropriate EREP reports should be run for a more detailed analysis of the problem.

For information on system console messages for SIM DASD, see “Chapter 3. Performing Media Maintenance on SIM DASD” on page 27. For information on system console messages for non-SIM DASD, see “Chapter 4. Performing Media Maintenance on Non-SIM DASD” on page 43.

---

## Routine Practices

Certain routine practices can help to ensure error recovery with minimal disruption to processing and to the user community. First of all, your normal backup and recovery procedures must be effective and adequate to meet your needs if data is damaged or lost for any reason, including disk media problems. In addition, the appropriate EREP reports should be generated on a regular basis to help you identify errors and provide a history of problems related to disk storage.

## Backing up Volumes

The way you control and manage backup procedures must be tailored to suit the needs of your applications and users. It is important to back up data at the correct frequency, select an appropriate backup medium, and maintain an adequate number of backup versions. Several of the major considerations for defining the backup procedures can affect the ease with which error recovery takes place. For example:

- The rate at which data changes
- The time and resources required for synchronizing and updating backup copies
- Options for rebuilding, as opposed to re-creating data from backup versions.

In assessing the adequacy of your backup procedures, you should also consider factors such as how critical the data is to the business and what the time requirements are in your applications.

For more information on backup and recovery applicable to your device type and operating environment, refer to appropriate operating environment manual listed in the "Storage Subsystem Library" sections of the "Bibliography" on page 121.

## Using EREP to Generate Reports

EREP is an IBM product that helps you to monitor the functioning of various units in your system, such as the processor, disk storage, tape drives and other I/O devices, controllers, and channels. This diagnostic aid provides you with information on errors that have occurred in the components of your system. EREP helps you to identify units that may be malfunctioning or exceeding predefined error limits. By taking prompt corrective action, you can help to achieve continued efficient operation.

If an error occurs, the operating system creates a record from data provided by the hardware or software and writes it in the ERDS, in accordance with the error recording requirements for the DASD type. EREP processes these records and produces reports, according to your specifications. These reports are designed for use by you, or by the service representative who may be called for certain error conditions.

Traditionally, these reports have been used primarily by an IBM service representative. However, you can use the EREP reports to help you determine the nature of error incidents and make decisions regarding media maintenance actions. These reports include explicit information on disk storage errors.

The EREP reports describe the type and location of errors and give other needed details. If you are running EREP and consolidating from all of the systems that share DASD, the EREP reports will give you information from all the systems that share the disk storage. The ERDS for each system should be used as a basis for a multi-system report. These reports also include temporary and permanent errors, and suggest the probable failing unit. Refer to "Chapter 1. Introduction" on page 15 for information on error classification considerations, such as "temporary versus permanent" and "probable failing unit."

You should run these reports daily as a normal procedure, and a member of the data processing center staff should be responsible for reviewing the reports for actual or potential disk storage problems.

"Using EREP Reports for SIM DASD" on page 33 provides specific instructions for reading EREP reports pertaining to SIMs.

For non-SIM DASD, "Using the System Exception Reports" on page 44 provides specific instructions for reading the System Exception Reports and "The Steps in Handling Errors on Non-SIM DASD" on page 53 explains how each of these reports is used along with Device Support Facilities for handling an error situation.

Refer to *EREP User's Guide and Reference* for a complete description of the program and its functions.

---

## Performing Media Maintenance

Performing media maintenance actions on a timely basis will help insure that performance and availability of your data processing system are maintained.

The exact procedures that you implement for handling and scheduling media maintenance activities must be tailored to suit the performance and availability requirements of your user community. ***It is a good idea to document your procedures for handling disk storage errors along with your other data processing operational procedures.***

If your media maintenance actions do not correct the problem, call your IBM service representative for assistance.

## Understanding Concurrent Media Maintenance

Concurrent media maintenance is a capability that allows media maintenance to be performed on a track while access to the data from that track continues concurrently. The entire volume, including the data on the track being repaired, is available for use by all users from all systems that share the volume. The capability is designed to address media problems that have resulted in temporary or correctable data check events.

To allow concurrent access, the track to be worked on is copied to an alternate track on the same volume. The 3990 directs I/Os for the original track to the alternate track for the duration of the Device Support Facilities operation on the original track. No loss of data access is incurred. When the operation is complete, the data is copied back to the original track and the alternate track is released.

Concurrent media maintenance is offered with the 3990 Models 2 and 3 in combination with Device Support Facilities (Release 11 and subsequent releases), 3990 features, and operating system support. Both 3380 and 3390 DASD are supported. For more information on performing concurrent media maintenance with ICKDSF, see "Using Concurrent Media Maintenance" on page 58.

For information on how concurrent media maintenance works with SIM DASD, see "The Steps in Handling a SIM" on page 36 and "Automating the Steps in Handling a SIM" on page 38.

For information on how concurrent media maintenance works with non-SIM DASD, see "Using Concurrent Media Maintenance on Non-SIM DASD" on page 43.

---

## Chapter 3. Performing Media Maintenance on SIM DASD

This chapter describes how SIMs produced by the 3990-3390 subsystem help you determine when media maintenance is necessary and what Device Support Facilities functions are required to perform it. Media maintenance techniques are centered around the use of the SIM for the 3390. SIMs appear on the operator console and are listed in the Service Information Messages report, a report within the System Exception Report series, and Asynchronous Notification Record Detail report produced by EREP.

It is important to note that this section describes SIMs that relate to the DASD portion of the 3990-3390 subsystem only, particularly those that relate to media maintenance. For a complete description of SIMs that relate to the 3990, see the *IBM 3990 Storage Control Planning, Installation, and Storage Administration Guide* and the *IBM 3990 Storage Control Reference*.

Before reading this chapter, you should have a basic understanding of error characteristics, how the storage subsystem and operating system contribute to the error handling process, and a basic understanding of EREP functions. This information is described in detail in "Chapter 1. Introduction" on page 15 and "Chapter 2. The Error Handling Process" on page 21

---

### Using the Service Information Message (SIM)

A SIM is a summary message prepared and sent to a host asynchronous to any given error event or events. It reflects the result of error event collection and analysis in the 3990/3390 storage subsystem and indicates that some kind of service action needs to be taken.

The SIM message contains a description of the problem the subsystem has identified (the *impact of failure*), a description of what resources the repair action will affect (the *impact of repair*), and defines what action should be taken to resolve the problem.

With the introduction of the 3990/3390 storage subsystem, error collection, consolidation, filtering, and analysis is handled within the subsystem. The subsystem's SIM problem analysis programs are more comprehensive than the host EREP problem analysis capability used in support of earlier DASD subsystems.

SIMs eliminate the need for customers to perform problem determination activities. They also greatly reduce problem re-creation activities by the service representative that are often required with earlier DASD subsystems. The SIM contains complete information for the service representative including coded information that identifies the FRU that should be replaced. The SIM also provides improved information for customers in planning for the service action.

### Identifying the Need for Service

There are several ways to identify that service is required:

- The SIM Alert console message is usually the first indication that service may be needed.
- The Service Information Messages report produced by EREP provides a listing of SIMs currently in the EREP history file.

The Service Information Messages report produced by EREP, is the most complete means to verify that a service action is required, and is a useful tool in following up on service needs brought to your attention in other ways. The EREP Asynchronous Notification Record Detail report is also useful when information regarding a specific SIM is needed.

## Types of SIMs for DASD Devices

There are two types of SIMs that provide service information for the 3390:

**DASD SIM** Indicates a hardware condition exists. This condition is not media related and requires the attention of an IBM Service Representative. A DASD SIM causes a **DASD ALERT** message to be sent to the console and a **SERVICE ALERT** to appear on EREP reports that provide SIM information.

**Media SIM** Indicates a media condition exists. The customer should perform the recommended media maintenance action. A media SIM causes a **MEDIA ALERT** message to be sent to the console and a **MEDIA ALERT** to appear on EREP reports that provide SIM information.

### Terminology

The term **SIM Alert** is used where information pertains to both **MEDIA ALERT** and **DASD ALERT** console messages.

On a 3990-3390 subsystem, a media SIM is generated when the source of the failure is the volume. A SIM Alert presented at an operator console, provides valuable information regarding source and severity of the problem.

The Service Information Messages report and Asynchronous Notification Record Detail report produced by EREP, contain similar information to that found in the SIM Alert, including the track address where the failure occurred and the action required to correct it.

## Using the Console SIM Alert

If the subsystem determines that a service action is needed, a SIM is logged in ERDS and a SIM Alert message is routed to the operator's console.

A **MEDIA ALERT** presented at the operator's console, provides the volume serial number of the failing volume and the address of the failing track. The **MEDIA ALERT** also provides the Device Support Facilities procedure number required for media maintenance. The severity field allows you to determine if the condition needs immediate attention or if it is possible to defer the action. For a more detailed description of the SIM severity field, see "SIM Severity Levels" on page 31.

Depending on your operating system, operator console messages may go unnoticed because they are displayed for such a short time or they *roll off* the screen. When possible, SIM Alerts are highlighted and issued so as not to roll off the screen to encourage immediate operator attention. In any event, you should continue to run EREP on a routine basis.

Some SIM Alerts can be suppressed using the **SIM Severity Reporting Option** in the 3990 VPD. See *IBM 3990 Storage Control Planning Installation and Storage Administration Guide*, for more details on this option.

The following sections describe how to interpret the console SIM Alert.

### Console SIM Alert in MVS and VM

The following example shows a SIM Alert formatted to the system operator's console. This MEDIA ALERT was generated in the MVS/XA<sup>\*</sup> operating environment, for a 3390 Model 2.

```
00000090 *IEA480E 0EAD,MEDIA,SERIOUS ALERT,MT=33902 ,SER=0113-T4172,REFCODE=43C0-
8880-ED87,VOLSER=TSOCAD,ID=0F,CCHH=X'027B 0000'
```

The following example shows the components of a SIM Alert and the possible fields that can occur in the SIM Alert message for the 3390.

IEA480E	yyyy	DASD,	ACUTE	ALERT, MT=
DMKmmm403I		MEDIA,	SERIOUS	machine type/model,
HCPERP403I			MODERATE	SER=MMPP-SSSS
			SERVICE	

REFCODE=nnnn-nnnn-nnnn, VOLSER=volser, ID=id, cchh=x'cccc hhhh', REPEATED

Figure 5 describes the fields in the 3390 SIM Alert.<sup>\*</sup>

<i>Figure 5 (Page 1 of 2). Description of the 3390 SIM Alert Fields</i>	
<b>IEA480E</b>	The 'IEA' message is received for SIM Alerts on MVS systems.
<b>DMKmmm403I</b>	The 'DMK' message is received for SIM Alerts on VM/SP HPO systems, 'mmm' represents the module issuing the message.
<b>HCPERP403I</b>	The 'HCP' message is received for SIM Alerts on VM/XA systems.
<b>yyyy</b>	The address of the device that reported the failure.
<b>DASD</b>	Tells you the problem is hardware related and will require the attention of an IBM Service Representative.
<b>MEDIA</b>	Tells you the problem is media related and will require you to perform a media maintenance action.
<b>ACUTE SERIOUS MODERATE SERVICE</b>	Represents the severity of the SIM being reported. For a description of severity levels, see "SIM Severity Levels" on page 31.
<b>MT</b>	Machine type and model number (7 characters maximum).

\* MVS/XA is a trademark of the International Business Machines Corporation.

\* VM/XA is a trademark of the International Business Machines Corporation.



*Figure 5 (Page 2 of 2). Description of the 3390 SIM Alert Fields*

<b>SER</b>	MM identifies manufacturer (01 indicates IBM). PP identifies the manufacturing plant SSSSS is the five digit machine serial number.
<b>REFCODE</b>	Twelve hex characters, tells IBM service representative information needed to repair the fault. For MEDIA ALERTs, the last character is the media maintenance procedure that you need to perform.
<b>VOLSER</b>	The volume serial number of the failing volume.
<b>ID</b>	SIM ID, two hex characters.
<b>CCHH</b>	Appears for MEDIA ALERTs only. The cylinder and head address of the failing track.
<b>REPEATED</b>	Appears for DASD ALERTs only. This field is shown when the SIM is a repeat presentation of a previously reported SIM.

**Console SIM Alert in VSE**

A SIM Alert message has the same format as a unit check error message. The format of a SIM Alert message is shown in Figure 6. Relevant fields are highlighted.

```
BG 0PxxI I MSG DESCRP SYS011=yyy
CCSW=xxxxxxxxxxxxxxxxxxxx CCB=xxxxxx SK=xxxxxxxxxxxx
SNS=xxxxxxxxxxxxxxxxxxxxxxxxxxxxxxxxxxxxxxxxxxxxxxxxxxxxxxxxxxxxxxxxxxxxxxxx
```

*Figure 6. Sample SIM Alert Message in VSE*

where:

- 0PxxI* Message ID
- MSG DESCRP* Message text
- SYS011=yyy* I/O address
- SNS=nn...nn* Sense bytes

The 32 sense bytes, shown in hexadecimal, are the data upon which the SIM is based. The Service Information Messages report and the Asynchronous Notification Record Detail report contain detailed information, including the severity, the track address where the abnormal condition occurred, and the action required to correct it. Therefore, you should continue to run EREP on a routine basis. Use this report to get a complete listing of all SIMs generated by the subsystem. For further information on interpreting SIM sense bytes, see *IBM 3990 Storage Control Reference*.

The following messages indicate that a SIM may have been received. The four SIM Alert message IDs, message descriptions, and recommended actions are shown in Figure 7.

Message ID	Message Description	Recommended Action
0P04I	PATH FENCE	Generate the Service Information Messages report or the Asynchronous Notification Record Detail report by running EREP. Schedule system maintenance with your service representative.
0P05I	OPER INFO	Generate the Service Information Messages report or the Asynchronous Notification Record Detail report by running EREP. Schedule system maintenance with your service representative.
0P64I	MAINT REQD	Generate the Service Information Messages report or the Asynchronous Notification Record Detail report by running EREP. Schedule system maintenance with your service representative.
0P65I	MEDIA ERR	Generate the Service Information Messages report or the Asynchronous Notification Record Detail report by running EREP. You can fix most media errors using Device Support Facilities.

Figure 7. SIM Alert Messages and Recommended Responses in VSE

For more information, see *Using IBM 3390 Direct Access Storage in a VSE Environment* and *IBM VSE/SP Messages and Codes*.

### SIM Severity Levels

SIM Alerts include a severity level which indicates if the service action can be deferred or if you need to take immediate action. The following table provides a brief description of SIM severity levels.

Figure 8 (Page 1 of 2). General Description of SIM Alert Severity Fields for 3990 and 3390

Severity Field	Meaning	Recommended Action
SERVICE	No system or application performance degradation is expected in any environment. No system or application outage has occurred.	At the earliest convenience, evaluate the potential effects on system operations. Plan to take corrective action, if necessary  If you defer action, application outages and/or unacceptable performance degradation may occur if previously recoverable exceptions become unrecoverable.
MODERATE Not applicable for MEDIA ALERTs.	Performance degradation is possible in a heavily loaded environment. No system or application outage has occurred.	Promptly evaluate the effects on system operations. Plan to take corrective action, if necessary.  If you defer action, application outages and/or unacceptable performance degradation may occur if previously recoverable exceptions become unrecoverable.
SERIOUS	A primary I/O subsystem resource is disabled. Significant performance degradation is possible. System or application outage may have occurred.	Immediately evaluate the effect on system operations. Plan appropriate system recovery actions.  Product service and/or action by the installation is required to restore the product to full operation. Determine the actions required.

Figure 8 (Page 2 of 2). General Description of SIM Alert Severity Fields for 3990 and 3390

Severity Field	Meaning	Recommended Action
ACUTE  Not applicable for MEDIA ALERTs.	A major I/O subsystem resource is disabled, or damage to the product is possible. Performance may be severely degraded. System and/or application outages may have occurred.	Treat as an emergency. Remove data from any DASD volumes implicated. Evaluate the current or potential effect on system and application operations. Determine appropriate system recovery actions or actions to prevent possible product damage.  Product service and/or action by the installation is required to restore the product to full operation. Determine the actions required.  Data restoration may be required to resume normal system or application operation.

Figure 9 shows the relationship between the failing component and the meaning of the severity field in the SIM Alert message as it pertains to a 3390.

Figure 9. Interpreting the Severity Field of the SIM Alert by Failing Component

Failing Component	Severity Field			
	SERVICE	MODERATE	SERIOUS	ACUTE
DASD	Indicates degraded DASD performance due to recurring recoverable equipment/data checks caused by a hardware fault. Service can be deferred, but IBM service representative must handle error.	A permanent error occurred on the path to the device or controller. Service can be deferred, but IBM service representative must handle error.	Permanent error occurred on the device. Access to data is lost. Contact your IBM service representative as soon as possible.	Permanent error occurred on the device. Potential loss of data. Contact your IBM service representative as soon as possible.
MEDIA	Temporary data checks have occurred. Media maintenance action recommended for track addresses identified in SIM Alert console message or in the Service Information Messages report. Your service action can be deferred. An IBM service representative is not required.	Not applicable for MEDIA ALERTs.	Permanent data check has occurred. Media maintenance action recommended for track addresses identified in SIM Alert console message or in the Service Information Messages report. Respond to the error as soon as possible. An IBM service representative is not required.	Not applicable for MEDIA ALERTs.

---

## Using EREP Reports for SIM DASD

The Service Information Messages report and Asynchronous Notification Record Detail report may be generated by running EREP. These reports include information such as the track address where the failure occurred and the action required to correct it. Use the Service Information Messages report to get a complete listing of all SIMs currently in the EREP history file. The Asynchronous Notification Record Detail report is useful when information regarding a specific SIM is needed.

For the 3390, it is not necessary to run EREP to get the information needed to perform media maintenance. The console SIM Alert contains similar information to that found in the EREP reports and is sufficient for performing media maintenance actions.

### EREK Release Level

The examples presented in this manual assume that you are operating on EREP Version 3.4.1 or higher.

## Interpreting the Service Information Messages Report

The Service Information Messages report is a report within the System Exception Report series that shows a formatted listing of SIMs currently in the EREP history file, regardless of whether action was taken or not. Each SIM listed shows necessary information on the type of error. In addition, for media SIMs, it provides you with the Device Support Facilities media maintenance procedure number required to correct the problem. For a listing and description of each 3390 media maintenance procedure, see "Error Handling for 3390" on page 102. The following sample Service Information Messages report shows a listing that includes SERVICE ALERTs and MEDIA ALERTs.

SERVICE INFORMATION MESSAGES (SIMS)		REPORT DATE 097 89	
		PERIOD FROM 090 89	
		TO 093 89	
<b>A</b>	<b>B</b>	<b>B</b>	<b>B</b>
COUNT	FIRST OCCURRENCE	LAST OCCURRENCE	
1	090/89 00:31:05:73	090/89 00:31:05:73	
	MEDIA ALERT 3390-02 S/N 0113-T4172 REFCODE 4340-8880-2283 ID=0A		
	TEMPORARY DATA CHECK(S) ON SSID 0040, VOLSER TS08E2 DEV 08E2, 48		
	PHYSICAL DEVICE 22, CYLINDER 022B TRACK 07		
	REFERENCE MEDIA MAINTENANCE PROCEDURE 3		
1	093/89 16:31:23:38	093/89 16:31:23:38	
	MEDIA ALERT 3390-02 S/N 0113-T4172 REFCODE 4380-E081-2585 ID=08		
	TEMPORARY DATA CHECK(S) ON SSID 0040, VOLSER JES8E5 DEV 08E5, 59		
	PHYSICAL DEVICE 25, CYLINDER 0669 TRACK 03		
	REFERENCE MEDIA MAINTENANCE PROCEDURE 5		
1	090/89 07:33:46:47	090/89 07:33:46:47	
	SERVICE ALERT 3390-02 S/N 0113-T4172 REFCODE 43C0-8080-E602 ID=01		
	PERMANENT ERROR(S) ON SSID 0044, VOLSER JES226 DEV 0226, 66		
	REPAIR WILL DISABLE PHYSICAL DEVICES 26-27		
1	090/89 01:11:07:95	090/89 01:11:07:95	
	SERVICE ALERT 3390-01 S/N 0113-A8416 REFCODE E437-6011-0501 ID=10		
	TEMPORARY ERROR(S) ON SSID 0044, VOLSER TS0105 DEV 0105, 57		
	REPAIR WILL DISABLE PHYSICAL DEVICES 04-05		

Figure 10. Service Information Messages Report Example

**Notes to Figure 10:**

**Key Description (SIMs)**

- A** Number of times subsystem reported this SIM.
- B** The time at which the SIM was first reported and the time at which it was last reported.
- C** This portion of the message tells you the type of SIM generated. In this case a MEDIA ALERT indicates that an error condition exists on the media and you need to perform a media maintenance action. A SERVICE ALERT indicates that the failure occurred on the hardware and you must contact your service representative.
- D** Product type, model number, (in this case, a 3390 Model 2). The serial number is also listed.
- E** The reference code provides information (including PFU and FRU) for your IBM service representative to use to correct the problem. You will need to provide your service representative with REFCODE data for SERVICE ALERTs.
- F** The unique identifier for each SIM. Each time a new SIM is reported by the subsystem, it is assigned an ID number.
- G** Specifies the channel path ID (CHPID)
- H** Appears for MEDIA ALERTs only. This line shows the physical ID of the device, as well as the track and cylinder address where the failure occurred.

- I** Appears for MEDIA ALERTs only. This line tells you the appropriate Device Support Facilities procedure number to perform media maintenance. For a description of 3390 media maintenance procedures, see Appendix B, "Specific Guidelines by DASD Type" on page 81.
- J** This line provides information on the impact and the location of the failure.
- K** Appears for SERVICE ALERTs only. This line tells you the impact the repair action will have on the device(s) involved.

## Understanding the Asynchronous Notification Record Detail Report

The Asynchronous Notification Record Detail report is useful when information regarding a specific SIM is needed. This report provides the same information that is in the Service Information Messages report. For a description of the fields, see "Interpreting the Service Information Messages Report" on page 33.

```

REPORTING DEVICE:    0008F0   REPORT: ASYNCHRONOUS           DAY YEAR
REPORTING DEVICE TYPE: 3390   REPORTING SYSTEM: VS 2 REL. 3 370XA DATE: 319 89
REPORTING PATH:      59-08F0                                     HH MM SS.TH
                                                                TIME: 02 35 30.73

RECORD TYPE:        DASD SIM
DEVICE DEPENDENT DATA
SERVICE INFORMATION MESSAGE

                MEDIA ALERT 3390-02 S/N 0113-T4172 REFCODE 41A0-0000-3083 ID=00
                PERMANENT DATA CHECK(S) ON SSID 0022, VOLSER RAS8F0 DEV 08F0, 59
                PHYSICAL DEVICE 30, CYLINDER 0000 HEAD 01
                REFERENCE MEDIA MAINTENANCE PROCEDURE 3

HEX DUMP OF RECORD
HEADER  A3831810 00000000 0089319F 02353073 423B3826 30900000
0018  00000000 00000000 00000000 00000000 00000000 00000000 205908F0 80052027
0038  080008F0 D9C1E2F8 C6F00000 00800500 3027EF00 11030000 00308304 2360857C
0058  002241A0 05104600 FF000001

```

Figure 11. Asynchronous Notification Record Detail Report Example

## The Steps in Handling a SIM

When handling a SIM, you should evaluate the condition in relation to the specific circumstances, such as the job in progress and the data in use at the time. For instance, the same condition that would cause you to take prompt action if it occurred in a catalog data set might be deferred (after investigation) if it occurred on a volume being used for temporary data.

The exact procedures that you implement for handling and scheduling media maintenance activities must be tailored to suit the performance and availability requirements of your user community. ***It is a good idea to document your procedures for handling disk storage errors along with your other data processing operational procedures.***

The most effective control of operations can be achieved by reviewing SIM activity and performing media maintenance on a regular basis. This will help you maintain required levels of availability and performance for your data processing system. For most situations, your media maintenance actions with Device Support Facilities can be scheduled at a convenient time, or be automatically handled using the concurrent media maintenance capability, for minimal impact on system performance and availability. It is important to remember that concurrent media maintenance allows you to continue to access the data while using Device Support Facilities to perform maintenance on the track. For more information on concurrent media maintenance, see "Understanding Concurrent Media Maintenance" on page 26, and "Automating the Steps in Handling a SIM" on page 38, and "Using Concurrent Media Maintenance" on page 58.

If your media maintenance actions do not correct the problem, call your IBM service representative for assistance. Have the associated EREP reports and Device Support Facilities output available for the service representative.

The process outlined here consists of basic steps describing the tasks and tools involved in handling a SIM. These steps are shown in Figure 12.

Figure 12. The Steps in Handling a SIM

Step	Task	Tool(s)	Resulting Action
1	<b>Detect the need for service</b>	Console SIM Alert Service Information Messages report or Asynchronous Notification Record Detail report	If the SIM appears as a DASD ALERT on the console or SERVICE ALERT on the report, call your service representative.  If the SIM appears as a MEDIA ALERT on the console or the report, perform step 2.
2	<b>Perform media maintenance</b>	Device Support Facilities, as specified by the media maintenance procedure number listed in the SIM.	See Appendix B, "Specific Guidelines by DASD Type" on page 81 for a listing of media maintenance procedures performed using Device Support Facilities.

## **Step 1: Identifying the Need for Service**

Generating EREP reports daily should be part of your routine maintenance process. If an abnormal condition is reported by a user or noted from a system console message, you may want to confirm the occurrence of the incident using the Service Information Messages report or Asynchronous Notification Record Detail report.

The severity field of the console SIM Alert tells you whether you can defer further handling of the error. For a complete description of SIM severity fields, see "SIM Severity Levels" on page 31.

Use the console SIM Alert or the EREP reports to determine whether the failing component is the hardware (DASD ALERT or SERVICE ALERT) or if it is disk media (MEDIA ALERT).

If the source of the error is hardware, the console DASD ALERT or the EREP reports will provide the information needed to place a service call. The EREP reports contain additional information about the impact the service action will have on your operation. Save the report for your own reference and for your IBM service representative to review. No further action is required.

If the source of the error is the disk media, the nature of the condition is determined by the severity field in the console MEDIA ALERT or by the temporary or permanent designation in the EREP reports.

A MEDIA ALERT provides the volume serial number (volser) and track address for the failing volume. The EREP reports provide the similar information. Perform step 2.

## **Step 2: Perform Media Maintenance**

Each media SIM that is generated contains a media maintenance procedure number. In the console MEDIA ALERT, the media maintenance procedure number is shown as the last digit of the REFCODE. MEDIA ALERTS that are presented in the EREP reports also provide you with the appropriate media maintenance procedure number. Each number corresponds to a specific Device Support Facilities command or set of commands to be run on a specific track or tracks. Appendix B, "Specific Guidelines by DASD Type" on page 81 lists each Device Support Facilities media maintenance procedure.



## Automating the Steps in Handling a SIM

It is possible to capture SIM information and automatically initiate tasks to assist you in handling the SIM. This capability allows you to create a series of commands that review SIM ALERTs sent to the operator console and take whatever action is appropriate for your installation. In an MVS environment, you can use the NetView<sup>®</sup> facility to automate console message handling. In the VM environment, you can use the VM Programmable Operator (PROP) facility.

In order to ensure console messages are created, the 3990 SIM Severity Reporting Option must be set to 0. For more information on how to set the SIM Severity Reporting Option, see the *IBM 3990 Storage Control Planning Installation and Storage Administration Guide*.

## Using NetView in an MVS Environment

NetView Release 3 runs on MVS as an automated operations facility. NetView automatically processes MVS console messages and executes EXECs, which in turn execute MVS commands. For example, you can create an EXEC that can examine a SIM and, in turn, invoke Device Support Facilities to perform media maintenance as required by the SIM.

Refer to "Understanding Concurrent Media Maintenance" on page 26 and "Using Concurrent Media Maintenance" on page 58 for information on concurrent media maintenance.

**Note:** You can use NetView to suppress console SIM Alerts. For more information on using NetView for tasks such as suppressing console messages, see:

*NetView Customization: Writing EXECs*

If you have NetView Release 3 installed, there are two steps you must follow to enable automated message handling.

1. Modify the NetView message automation table. Since the process is triggered by a console message, you must place the message ID in the automation table. For console SIM Alerts, the message ID is IEA480E. This will automatically invoke the EXEC that is specified in the automation table.

The following example shows how NetView begins the automated message handling process. This entry will capture the MEDIA ALERT resulting in the execution of the CMDSF EXEC.

```
/* *****  
/* Sample DSIPARM - Message automation to trap MEDIA SIM console */  
/* resulting in the invocation of the CMDSF EXEC. This */  
/* EXEC will in turn invoke ICKDSF to run INSPECT. */  
/* *****  
IF MSGID = 'IEA480E' & TEXT='MEDIA'. & TEXT=THEMSG THEN  
EXEC(CMD('CMDSF ' THEMSG)) DISPLAY(N);
```

\* NetView is a trademark of the International Business Machines Corporation.

2. Install the EXEC in your NetView EXEC library. The following sample EXEC is called CMDSF, but you can choose another name for it. Also, you may want to modify the EXEC to better suit your installation's needs. For example, it might not be appropriate to automatically schedule media maintenance on all volumes. The increased I/O load caused by the media maintenance process may not be acceptable on page volumes, or certain database volumes. To exclude these volumes from the process, modify the EXEC. Another change you might want to make is to limit the automatic invocation to certain times of the day.

A sample EXEC is shown in Figure 13.

**Note:** The sample provided is intended to serve as a pattern. You should fully test the EXEC after inserting any installation dependent code.

```

/* REXX ***** */
/* EXEC Name - CMDSF */
/*
/* Descriptive name - Invokes ICKDSF INSPECT */
/*
/* Function - This EXEC is used to run INSPECT using the */
/* Concurrent Media Maintenance facilities of */
/* ICKDSF. It is intended to be invoked */
/* automatically from the NetView facility. */
/* The MEDIA SIM console message is parsed into */
/* the necessary fields to build the necessary */
/* control cards to submit ICKDSF. */
/*
/* Scope: This EXEC is intended to serve as AN EXAMPLE of */
/* how you can automate the initiation of a */
/* Concurrent Media Maintenance task. It's purpose, */
/* therefore, is to serve as a pattern. It is still */
/* recommended that you fully test the EXEC after */
/* inserting any installation dependent code. */
/*
/* Notes - 1. This EXEC will address temporary errors reflected */
/* in media SIMs. */
/* 2. This EXEC contains the pattern JOBCARD that will */
/* have to be adapted for your installation. These */
/* three statements (JCL1, JCL2, JCL3) are found */
/* towards the end of this EXEC. */
/* 3. This EXEC may also be modified, for example, */
/* to not process certain volumes, or change the */
/* message routing. */
/*
/* Normal exit conditions - */
/* RC is the return code that gets passed back to the caller */
/* RC = 0 when the ICKDSF job was successfully submitted. Check */
/* the ICKDSF output for the return code from the */
/* INSPECT process. */
/*
/****** */

```

Figure 13 (Part 1 of 2). Example of the MVS REXX EXEC

```

Address 'COMMAND'

MsgText = MSGSTR()          /* Retrieve message without id */

TypePos = POS('MEDIA',MsgText) /* Look for MEDIA SIMs only */
If TypePos = 0 Then Exit 0   /* Terminate if not MEDIA SIM */

SevPos = POS('SERVICE',MsgText) /* Look for temp errors only */
If SevPos = 0 Then Exit 0   /* Terminate if not temps */

RefPos = POS('REFCODE',MsgText) /* Look for the REFCODE. */
If RefPos = 0 Then Exit 0   /* Terminate if none */
If SUBSTR(MsgText,RefPos+21,1) = 9 Then Exit 0
/* Check Media Maintenance Proc
   Code - Terminate if not a
   correctable error */

If TypePos > SevPos Then Exit 0 /* The word MEDIA found */
/* somewhere else in message */

UnitAdd = SUBSTR(MsgText,TypePos-5,4) /* Get UNIT address */

VolPos = POS('VOLSER=',MsgText) /* Locate beginning of volser */
If VolPos = 0 Then Exit 0   /* Terminate if no Volume in msg*/
VolPos = VolPos + 7        /* Adjust to 1st pos of volser */
VolEnd = POS(' ',MsgText,VolPos) /* Locate end of volser */
Volume = SUBSTR(MsgText,VolPos,VolEnd-VolPos) /* Extract Volser */

CHPos = POS('CCHH=',MsgText) /* Locate CCHH type in msg */
If CHPos = 0 Then Exit 0   /* Terminate if no CCHH in msg */
CC = SUBSTR(MsgText,CHPos+7,4) /* Get Cylinder */
HH = SUBSTR(MsgText,CHPos+12,4) /* Get Track */
CCHH = "X"CC"X"HH"         /* Form full Hexadecimal CCHH */

/*-----*/
/* The following steps build the ICKDSF job with control statements, */
/* allocate the internal reader (INTRDR), and submit the job. */
/* Additional JCL changes may be required to suit your installation. */
/*-----*/

/*-----*/
/* The following 3 statements must be */
/* changed to reflect a valid JOBCARD */
/* in your installation. */
/*-----*/

JCL1 = '/*JOBCARD JOB (ACCOUNT INFO) ...'
JCL2 = '/*'
JCL3 = '/******'
JCL4 = '/* FUNCTION - RUN INSPECT ON CORRECTABLE DATA CHECK *'
JCL5 = '/* AS INDICATED IN MEDIA SIM *'
JCL6 = '/******'
JCL7 = '/*DSFRUN EXEC PGM=ICKDSF'
JCL8 = '/*INSPDD DD UNIT=SYSDA,VOL=SER='Volume'DISP=OLD'
JCL9 = '/*SYSPRINT DD SYSOUT=*'
JCL10 = '/*SYSIN DD *'
JCL11 = ' IODELAY SET MSECONDS(100) '
JCL12 = ' ANALYZE DDNAME(INSPDD) DRIVETEST NOSCAN '
JCL13 = ' IF LASTCC < 8 THEN - '
JCL14 = ' INSPECT DDNAME(INSPDD) NOVERIFY - '
JCL15 = ' TRACKS('CCHH') - '
JCL16 = ' SKIP CHECK(2) ASSIGN '

ADDRESS TSO 'FREE F(DD1)'
ADDRESS TSO 'ALLOC F(DD1) SYSOUT(A) WRITER(INTRDR) RECFM(F) LRECL(80)'
ADDRESS MVS 'EXECIO 16 DISKW DD1 (STEM JCL'
EXIT

```

Figure 13 (Part 2 of 2). Example of the MVS REXX EXEC

## Using the PROP Facility in VM

VM/XA SP\* and VM/SP HPO contain the PROP facility capable of intercepting messages, such as SIMs, and handling them with preprogrammed actions. For example, you can create a Restructured Extended Executor (REXX) EXEC which invokes EREP to generate the Service Information Messages report.

**Note:** You can use PROP to suppress console SIM Alerts that are handled by the system-assisted facility. For more information on PROP and suppressing messages see:

- *VM/SP HPO System Programmer's Guide*
- *VM/SP HPO CP for System Programming*
- *VM/XA SP Planning and Administration.*

To use the automated message handling capability in VM, you must change your Programmable Operator Message Table (RTABLE). This change, shown in Figure 14, causes the MEDIA ALERT to be intercepted. The REXX EXEC is invoked whenever this message is issued. This REXX EXEC is shown in Figure 15 on page 42.

LGLOPR USERB						
TEXTSYM / \$ -						
ROUTE						
*-----*						
*T	S	E	T	U	N	A P
*E	C	C	Y	S	O	C A
*X	O	O	P	E	D	T R
*T	L	L	E	R	E	N M
*-----*						
\$403I\$MEDIA\$CCHH			1			EREPSIM

Figure 14. Modifications to the RTABLE for VM

The REXX EXEC provided can be tailored to suit your installation's needs. For example, you might want to modify the EXEC to specify your level of operating system.

**Note:** The sample provided is intended to serve as a pattern. You should fully test the EXEC after inserting any installation dependent code.

\* VM/XA SP is a trademark of the International Business Machines Corporation.

```

/*****
/* EXEC name:  EREPSIM                               */
/*                                                    */
/* This sample REXX EXEC produces an EREP System Exception Report for */
/* use in real-time problem determination for DASD subsystems.  EREP */
/* message data and the EREP Subsystem Exception Report will be sent */
/* to printer files.                                           */
/*                                                    */
/* NOTE1: There should be at least 7M of virtual storage.      */
/* NOTE2: No tapes should be attached at 181 or 182.          */
/* NOTE3: The VM/SP HPO user must have a privilege class that allows */
/* the execution of the CPEREPI module; the IBM supplied */
/* defaults would be privilege classes C, E, or F.            */
/* NOTE4: The VM/XA user must have access to the minidisk containing */
/* the error recording file and have filemode X and virtual */
/* device address 195 available to LINK to it; a password may */
/* need to be supplied.                                       */
*****/

'GLOBAL TXTLIB ERPTFLIB ERFTRLIB EREPLIB'
erep = 'CPEREPI'
parse value(diag(0)) with 1 sys 9 .
if sys = 'VM/XA SP'
  then do
    erep = 'CPEREPIXA'
    'EXECIO 0 CP ( STRING LINK EREP 191 195 RR'
    'ACCESS 195 X'
    'COPYFILE XAEREPIO RECORD X XAEREPIO RECORD A1 ( REPLACE'
    'RELEASE 195 ( DET'
  end

/*****
/* Step 1.  create a working copy of SIM and OBR records      */
*****/

'ERASE WRKCOPY EREP'
push; push 'HIST=N,ACC=Y,ZERO=N,TABSIZE=999K,TYPE=A0,PRINT=NO'
'FILEDEF ACCDEV DISK WRKCOPY EREP ( RECFM VB BLKSIZE 12000'
'FILEDEF TOURIST PRINTER ( BLKSIZE 133'
erep
if rc = 0 then exit rc
'ESTATE WRKCOPY EREP A'
if rc = 0
  then do;
    say 'EREP step 1 did not create a history file'
    exit rc
  end

/*****
/* Step 2.  create the System Exception Report for DASD subsystems. */
*****/

push; push 'HIST=Y,ACC=N,ZERO=N,TABSIZE=999K,DEV=(33XX),SYSEXN=Y'
'FILEDEF ACCIN DISK WRKCOPY EREP'
'FILEDEF TOURIST PRINTER ( BLKSIZE 133'
erep
exit rc

```

Figure 15. REXX EXEC Used for Automated Generation of EREP Reports in VM

---

## Chapter 4. Performing Media Maintenance on Non-SIM DASD

This chapter describes how to determine when media maintenance is necessary and what Device Support Facilities functions are required to perform it. Media maintenance techniques are centered around the use of the System Exception Reports produced by EREP.

Before reading this chapter, you should have a basic understanding of error characteristics, how the storage subsystem and operating system contribute to the error handling process, and a basic understanding of EREP functions. This information is described in detail in "Chapter 1. Introduction" on page 15 and "Chapter 2. The Error Handling Process" on page 21

---

### Handling Errors on Non-SIM DASD

First, you must establish that an error situation exists. There are several ways of discovering that an error has occurred:

- Your regular review of System Exception Reports reveals temporary error situations requiring attention.
- Messages displayed at a terminal or console provide immediate notification of permanent errors.
- Users may notify you of a storage error that occurred during execution of an application program.

The System Exception Reports produced by EREP are the most useful and complete means to verify that errors have occurred, and these reports are a necessary tool in following up on errors brought to your attention in other ways.

Most permanent errors cause a console message to be generated. Console messages may not provide the information in a form you need to evaluate an error situation.

### Using Concurrent Media Maintenance on Non-SIM DASD

It is important to remember that concurrent media maintenance allows you to continue to access the data while using Device Support Facilities to perform maintenance on the track. For more information on concurrent media maintenance, see "Understanding Concurrent Media Maintenance" on page 26 and "Using Concurrent Media Maintenance" on page 58.

If your media maintenance actions do not correct the problem, call your IBM service representative for assistance. Have the associated EREP reports and Device Support Facilities output available for the service representative.

### Identifying the Error

The means used for handling the problem depends on the **source** of the error, and the Subsystem Exception DASD report designates the source as a probable failing unit.

Console messages and application program facilities usually describe an error in terms of its *type*. The source of an error is a more reliable basis for recovery than the type of error because a type of error can have different sources. For instance, a data check type of error might be caused by a problem in the device hardware or by a defect on the disk surface. The source of an error points to where recovery action should be applied and to the means for recovery, as described in "The Steps in Handling Errors on Non-SIM DASD" on page 53.

Console messages may go unnoticed because they require no response or operator intervention. You may obtain listings of all console messages that have occurred over a period of time or in connection with a specific processing job. In these listings, however, disk storage messages are intermixed with other messages and may not be easy to locate. This is why it is important to run EREP System Exception reports for more information.

Reports of disk storage errors from users always warrant further investigation. It's a good idea to request as much information as possible concerning the error and the conditions under which it occurred. If possible, obtain the job log from the processing step that incurred the error. System Exception Reports provide additional information on such errors.

---

## Using the System Exception Reports

It is essential that you run all EREP reports that pertain to disk errors on a daily basis. The following sections present detailed information on reading and using the three System Exception Reports that are intended for DASD media maintenance.

Although a variety of System Exception Reports are available through EREP, only three reports are applicable to disk media errors for non-SIM DASD. The other reports apply to other components, or are for use by IBM service representatives.

The System Exception Reports produced by EREP will be most useful to you in handling data checks. (Data checks are errors detected when data is read.) The reports also provide information that will help you decide if and when to call for service.

The reports for disk storage errors, discussed in this chapter, are listed here in the order in which you use them in identifying and handling a media error situation.

- 1 System Error Summary (Part 2)** lists incidents of permanent I/O errors (data or equipment checks) and identifies each error by job name and time.
- 2 Subsystem Exception DASD** provides information on accumulated permanent and temporary I/O errors.
- 3 DASD Data Transfer Summary** presents details on data checks.

Your use of the reports will be more efficient if you locate volume information quickly. Figure 18 provides a "snapshot" of volume information locations for each type of report. The reports are numbered in the order you would use them for identifying and handling errors.

### Samples of Volume Information

1				SYSTEM ERROR SUMMARY				REPORT DATE 225 88			PROBABLE FAILING UNIT
(PART 2)								PERIOD FROM 224 88			
								TO 225 88			
TIME	JOBNAME	CPU	PHYSICAL ID	PHYSICAL TYPE ADDRESS	ERROR PATH VOLUME	ERROR DESCRIPTION					
DATE 224/88											
19:21:13:42	TSOD02W	A	XX-84-05	3380 0335	04-0335	SYSTSL PERMANENT EQUIPMENT CHECK	DEVICE				
DATE 225/88											
19:20:14:81	ICOTPSG	D	XX-0A-03	3380 07C3	50-07C3	PSG091 PERMANENT DATA CHECK	VOLUME				

Figure 16. How Volumes are Listed in the System Error Summary Report

2												SUBSYSTEM EXCEPTION		REPORT DATE 097 89											
DASD												PERIOD FROM 052 89		TO 052 89											
												B-BUS OUT PARITY CHK		C-CHECK DATA CHK	D-DISKETTE CHK	I-INVOKED OFFSETS	---IMPACT OF TEMPORARY ERRORS----								
												PROBABLE FAILING UNIT		FAILURE AFFECT CPU	PHYSICAL ADDRESS	-----TOTALS-----			EQU	CHK	SKS	RD	OVRN	OTHER	
																SIMS	PERM	TEMP							
*****												DEV 01.X-17		SEEK		TOTAL		2	1					1	
												3380-JK			00	01.2-17			1					1	
															00	01.2-17		2							
												02.X-17		SEEK		TOTAL		2							
												3380-JK			00	02.1-17		2							
-----+												VOL RASC77		DATA XFR		TOTAL			1					1	
												3380-JK			00	01.3-17		1						1-I	

Figure 17. How Volumes are Listed in the DASD Subsystem Exception Report

3												DASD DATA TRANSFER SUMMARY		REPORT DATE 225 88							
PROBABLE FAILING UNIT - VOLUME												PERIOD FROM 224 88		TO 225 88							
												SENSE COUNTS		TEMPORARY	OFFSET INVK THRESHOLD	PERM	NO	YES	LOGGING		
*****																					
SEQUENCE BY VOLUME LABEL, HEAD, CYLINDER																					
UNIT ADDRESS 07C3												DEVTYPE 3380		VOLUME PSG091							
CPU A												PHYSICAL ADDRESS XX-0A-03									
FAILURE AT ADDRESS: CYLINDER 0341 HEAD 01												10	0	0	0						
08800000 83551141 01550001 16860B00 00000000 00114941																					
LAST SENSE AT: 225/88 15:56:31:25																					

Figure 18. How Volumes are Listed in the DASD Data Transfer Summary



Figure 19 compares the contents of the three pertinent System Exception Reports. Detailed instructions for reading and using these reports are provided on the following pages. For the sample reports that are shown, report elements irrelevant to the handling of media errors are not discussed. See the *EREP User's Guide and Reference* for complete information on defining report requests to meet your needs.

	<b>System Error Summary (Part 2)</b>	<b>Subsystem Exception DASD</b>	<b>DASD Data Transfer Summary</b>
<b>Type of errors</b>	Permanent: Equipment and data checks	Permanent and temporary: Equipment and data checks	Permanent and temporary: Data checks
<b>What is reported</b>	Each incident (job and time)	Accumulated total errors	Details by volume (location of error)
<b>Probable failing units</b>	Hardware and volume	Hardware and volume	Volume

Figure 19. Comparison Summary of Relevant System Exception Report Contents

## System Error Summary (Part 2) Report

The System Error Summary (Part 2) report applies to disk and tape errors. (Part 1 describes processor and channel checks.) The report lists **each incident of a permanent I/O error**. The type of error might be a data check or an equipment check. The errors are in sequence according to the time they occurred.

The System Error Summary report provides a quick perspective on all permanent I/O errors during the time period covered by the report and is the starting point for DASD error management. Figure 20 on page 47 shows an example of a System Error Summary report.

SYSTEM ERROR SUMMARY (PART 2)										REPORT DATE 097 89	
										PERIOD FROM 052 89	
										TO 052 89	
<b>A</b>	<b>B</b>	<b>C</b>	<b>D</b>	<b>E</b>	<b>F</b>	<b>G</b>	<b>H</b>	<b>I</b>	<b>J</b>		
TIME	JOBNAME	CPU	PHYSICAL ID	PHYSICAL TYPE	PHYSICAL ADDRESS	ERROR PATH	VOLUME	ERROR DESCRIPTION	PROBABLE FAILING UNIT		
DATE 052/89											
00:14:01:27	EOS EXIT	00	02.X-17	3380-JK	0C77	4D-0C77	RASC77	PERMANENT SEEK CHECK	DEVICE		
00:14:58:56	EOS EXIT	00	01.X-17	3380-JK	0C77	5D-0C77	RASC77	PERMANENT SEEK CHECK	DEVICE		
00:28:41:28	EOS EXIT	00	01.X-17	3380-JK	0C77	4C-0C77	RASC77	PERMANENT SEEK CHECK	DEVICE		
00:41:00:47	EOS EXIT	00	02.X-17	3380-JK	0C77	4D-0C77	RASC77	PERMANENT SEEK CHECK	DEVICE		
*****											
CPU	MODEL	SERIAL									
00	3090XA	373826									

Figure 20. The System Error Summary Report

**Key Description**

**A** TIME

Dates and times the errors occurred. The time shown is for each permanent error. The first four numbers are the hours and minutes. The next four numbers are seconds and hundredths of seconds.

**B** JOBNAME

Name of the job in progress when the permanent error occurred. The name can be as many as eight alphanumeric characters and is assigned by the programmer.

**C** CPU

Numeric characters identifying the processor that received the error record.

At the bottom of the report, the processor identifiers are given with their model and serial numbers.

**D** PHYSICAL ID

A unique identifier for the device, set by the service representative at installation time. The format of this ID varies by device type.

**E** TYPE

Device Type, for example 3380, in the JK model class.

**Note:** The DASD reports, which include both permanent and temporary errors, might include other disk storage types that are not included in the System Error Summary (Part 2) if there are no permanent errors during this reporting period.

**F** PHYSICAL ADDRESS

The unit address known to the operating system.

**G** ERROR PATH

The address designation that identifies the components involved in the data transfer that incurred the error. This is the address actually used for selection, and is the address from which sense information was received.

**H** VOLUME

The 6-digit volume serial number identifying the logical volume at the address that incurred the error.

## **I** ERROR DESCRIPTION

Type of permanent error—either equipment check or data check.

*This information is useful during Step 1 of the error handling process for permanent errors shown in Figure 23 on page 53 .*

## **J** PROBABLE FAILING UNIT

Probable error source determined by the EREP program. It could be a channel, storage control, controller, device, or volume.

When the probable failing unit is a volume, the volume serial number on this report is used to continue the investigation of the error with the Subsystem Exception DASD and the DASD Data Transfer Summary reports.

*This information is useful during Step 1 of the error handling process for permanent errors shown in Figure 23 on page 53 .*

## **DASD Subsystem Exception Report**

The Subsystem Exception DASD report lists **accumulated permanent and temporary errors**. The accumulated errors are given for each unit in the probable failing unit category. For example, each volume with errors is listed in the volume category. The accumulated total includes each permanent error in the System Error Summary (Part 2). Description of the type of error depends on the probable failing unit.

- If the probable failing unit is a hardware component, permanent and temporary errors can be data or equipment type errors.
- If the probable failing unit is a volume, both permanent and temporary errors are always data type errors.

The hardware probable failing units are listed first, and the volume probable failing units last. Figure 21 on page 49 shows a sample of this report.

The DASD Subsystem Exception report highlights problems related to disk storage operation that may need further investigation and treatment. If the span of error records in the report covers more than three days, a message is printed at the top of the report. A report that spans a broad period of time might not provide the most accurate probable failing unit indication, because corrective action might have been taken.

For certain device types, you establish the limit for the number of temporary data errors acceptable in your data processing complex. Probable failing units with temporary data errors below this limit are not printed. If there are units with errors not reported because the errors did not exceed the limit, a message gives the total number of such units. Limits can be set for each type of error, and for each storage control and disk storage type. You specify these with LIMIT control statements.

Refer to *EREP User's Guide and Reference* for instructions on specifying limits. If no limits are specified, all temporary errors are listed. It is recommended that you do not specify error limits.

For more recent DASD types (listed below), you do not specify temporary error limits because the subsystem controls this process:

- 3370 attached to 3880 storage controls
- 3375
- 3380
- 3390
- 9332
- 9335

SUBSYSTEM EXCEPTION DASD		REPORT DATE 097 89 PERIOD FROM 052 89 TO 052 89		
B-BUS OUT PARITY CHK	C-CHECK DATA CHK	D-DISKETTE CHK	I-INVOKED OFFSETS	
<b>A</b> PROBABLE FAILING UNIT	<b>B</b> FAILURE AFFECT CPU	<b>C</b> PHYSICAL ADDRESS	<b>D</b> -----TOTALS----- SIMS PERM TEMP	
			<b>E</b> ---IMPACT OF TEMPORARY ERRORS--- EQU CHK SKS RD OVRN OTHER	
DEV 01.X-17 3380-JK	SEEK	TOTAL 01.2-17 01.2-17	2 1 1 1 2	1 1
02.X-17 3380-JK	SEEK	TOTAL 02.1-17	2 2	
VOL RASC77 3380-JK	DATA XFR	TOTAL 01.3-17	1 1	1 1-I
*****				
0 UNIT(S) EXCLUDED DUE TO LIMITS				
** ENTRIES WITH AN ASTERISK INDICATE THAT DASDID CARDS WERE NOT FOUND FOR THE UNIT.				
NOTE: "IMPACT OF TEMPORARY ERRORS" IS THE NUMBER OF TIMES ERROR THRESHOLD HAS BEEN EXCEEDED.				
NOTE: BLANK ENTRIES INDICATE ZERO VALUES OR NOT APPLICABLE. N/A = NOT AVAILABLE.				
NOTE: ZERO ENTRIES INDICATE RECORDS EXIST IN EREP REPORTS BUT THRESHOLDS WERE NOT EXCEEDED.				

Figure 21. DASD Subsystem Exception Report Example

**Key Description**

**A** PROBABLE FAILING UNIT

Listed by probable failing unit categories: channel (CHAN), storage control (SCU), controller (CTLR), device (DEV), and volume (VOL). All units in each category that had errors are listed with probable failing unit identifiers and device type number. When a physical ID identifies a probable failing unit, the physical ID represents a real physical ID set with switches, or a physical ID made up especially for the EREP program based on an address.

*This information is useful during Step 2 of the error handling process shown in Figure 23 on page 53.*

**B** CPU

As in the System Error Summary (Part 2), the numeric identifier identifies the processor that received the error records. At the bottom of the report, all processor alphabetic identifiers are given with their model and serial numbers.

**C** PHYSICAL ADDRESS

An identifier of a serviceable unit. A four digit physical address, or a physical ID for units that have physical IDs.

**D** --TOTALS--  
SIMS PERM TEMP

The SIM column is blank for DASD that do not produce SIMs. The numbers under **PERM** and **TEMP** indicate total permanent and total temporary errors for each unit. If the probable failing unit is a *volume*, the permanent and temporary error is *always a data check* on a read operation.

**E** IMPACT OF TEMPORARY ERRORS

The total shown under **TEMP** is the sum of the individual totals shown under **IMPACT OF TEMPORARY ERRORS**

*This information is useful during Step 1 of the error handling process for temporary errors shown in Figure 23 on page 53.*

A statement about unknowns may be printed after the regular listings. An unknown indicates that a probable failing unit could not be determined from the sense information. Also at the bottom of the report is the number of units excluded because of limits set by the processing complex on temporary errors reported.

## DASD Data Transfer Summary

Although the DASD Data Transfer Summary Report has a *Volume* and an *Other* section, only the *Volume* section is discussed here. In the *Volume* section, all errors are data errors, and the volumes are the probable failing units. For these, you can use Device Support Facilities for recovery action. For errors in the *Other* section, you should contact an IBM service representative.

The DASD Data Transfer Summary report provides details on data checks. All volumes listed in the DASD Subsystem Exception report (where they are listed with a total count of errors) are provided here with details of the data errors for that volume. Figure 22 on page 51 shows a sample report.

Information is provided for all permanent data errors, because permanent errors are recorded in the ERDS. For temporary errors, the information is provided if the error description (not just the count) is logged in the ERDS. Whether a temporary error is logged depends on the disk storage device type, and the area in which the error occurred.

```

DASD DATA TRANSFER SUMMARY                                REPORT DATE 225 88
PROBABLE FAILING UNIT - VOLUME                          PERIOD FROM 224 88
                                                         TO 225 88
                                                         E
                                                         SENSE COUNTS
                                                         TEMPORARY F
D OFFSET INVK THRESHOLD
PERM NO YES LOGGING
*****
SEQUENCE BY VOLUME LABEL, HEAD, CYLINDER

UNITADDRESS 07CC  DEVTYPE 3380      VOLUME ASCR84
CPU A  PHYSICAL ADDRESS XX-0A-0C  A
      FAILURE AT ADDRESS: CYLINDER 0708 HEAD 00 B      1  0  0  0
00001000 8CC42053 02C40000 0B700B00 1100057A 60000000
C      LAST SENSE AT: 224/88 14:32:58:32

      FAILURE AT ADDRESS: CYLINDER 0004 HEAD 03      0  0  34  0
00001000 8C040353 00040003 02700B00 11004762 00040000
      LAST SENSE AT: 225/88 23:50:36:53

      FAILURE AT ADDRESS: CYLINDER 0083 HEAD 07      0  2  0  115
00003000 8C530743 00530007 045E0B51 00000000 00114943
      LAST SENSE AT: 225/88 11:58:18:85

UNITADDRESS 0B54  DEVTYPE 3350      VOLUME ICOM15
CPU B  PHYSICAL ADDRESS 0B54
      FAILURE AT ADDRESS: CYLINDER 0003 HEAD 08      0  26  0  0
08004000 08030853 00030008 02210000 120C0496 00040000
      LAST SENSE AT: 224/88 09:51:38:40

      FAILURE AT ADDRESS: CYLINDER 0018 HEAD 08      0  29  0  0
08004000 08120853 00120008 02210000 121401AC 00200000
      LAST SENSE AT: 225/88 22:52:06:17

UNITADDRESS 07C3  DEVTYPE 3380      VOLUME PSG091
CPU A  PHYSICAL ADDRESS XX-0A-03
      FAILURE AT ADDRESS: CYLINDER 0341 HEAD 01     10  0  0  0
08800000 83551141 01550001 16860B00 00000000 00114941
      LAST SENSE AT: 224/88 15:56:31:25

      FAILURE AT ADDRESS: CYLINDER 0571 HEAD 03      0  0  2  0
00003000 833B2343 023B0003 01050B11 00000000 00114943
      LAST SENSE AT: 225/88 11:24:01:79

```

Figure 22. DASD Data Transfer Summary Example

**Key Description**

**A** UNITADDRESS xxxx DEVTYPE xxxx-xx VOLUME xxxxxx  
CPU x PHYSICAL ADDRESS xxxx

Detailed error information is grouped by volume. These lines serve as a "header" for the error details for a volume and specify the unit address used to select the volume, the type of device (for example, 3380), and the volume serial number. In addition, the processor designation and the physical address for the failing volume is provided.

**B** FAILURE AT ADDRESS: CYLINDER xxxx HEAD xx

This is the track address where the error occurred. For count-key-data types, addresses are cylinder and head numbers. For fixed block architecture, the designation is FAILURE AT BLOCK and the address is expressed as a relative block number or as cylinder, head, and sector numbers. Addresses on this line are expressed as decimal values.

*This information is useful during Step 3 of the error handling process shown in Figure 23 on page 53.*

**C** Sense Information

This is the sense record received from the subsystem. It is either 24 or 32 hexadecimal bytes of sense data. If more than one error is reported for an address, the sense information applies to the *last* error. The sense information is primarily for use by the service representative. However, you need the information in bytes 22 and 23 for interpreting certain error conditions described in Appendix B, "Specific Guidelines by DASD Type" on page 81.

Byte 0	Bytes 22 & 23
XXXXXXXXXXXXXXXXXXXXXXXXXXXXXXXX	XXXXXXXXNNNN (XXXXXXXXXXXXXXXX)

Below each sense record is the date and time of this last sense record.

**D** PERM

Error counts for permanent data checks are shown.

**E** SENSE COUNTS  
TEMPORARY

Error counts for temporary data checks are shown to the right of permanent error counts. There are two *Offset Invoked* columns for temporary errors. *No* or *Yes* values for temporary errors are interpreted as follows:

- For the 3330, 3340, 3350, and 3370s attached directly to the 4321, 4331, or 4361, the values under "Temporary" are all logged temporary data errors. The value is always listed under "Offset Invoked, No." (Zero always appears under Threshold Logging.)
- For the 3375, 3380, and those 3370s not attached directly to the 4321, 4331, or 4361, the value under "Offset Invoked, No" is the number of times the data error rate threshold for the volume was exceeded.

The value under "Offset Invoked, Yes" is the actual number of errors that were logged with offset. See "Error Handling for 3375 and 3380" on page 96 for further information on "Offset Invoked, Yes"

**F** THRESHOLD LOGGING

This information is related to temporary errors and does not apply to the 3330, 3340, 3350, or 3370 attached directly to 4321, 4331, or 4361. This value is the *number of errors* at that cylinder and head address *during the error reporting interval*. Other volumes on the same string may show values in this column, even if there are no values under the other error columns. This is because *all* volumes on the string may be placed in logging mode when *any* volume causes logging mode to begin.

*This information is useful during Step 3 of the error handling process shown in Figure 23 on page 53.*

It is possible for 3330, 3350, and 3370 disks (not attached by way of the 3880 control unit) to have temporary data errors that were not logged. There are no cylinder and head numbers available for these errors. In such cases, volumes involved *are* listed after the volume listings for which cylinder and head numbers are available. These errors are included in the error count in the Subsystem Exception DASD report. See "Chapter 5. Device Support Facilities" on page 57 for information on determining the addresses for temporary errors at unknown addresses.

## The Steps in Handling Errors on Non-SIM DASD

The error handling process outlined here consists of basic steps that show each error handling task and the tool(s) involved to complete it.

In following these procedures, you should evaluate the error situation in relation to the specific circumstances, such as the job in progress and the data in use at the time. For instance, the same error that would cause you to take prompt action if it occurred in a catalog data set might be disregarded (after investigation) if it occurred on a volume being used for temporary data.

The exact procedures that you implement for handling and scheduling error recovery activities must be tailored to suit the performance and availability requirements of your user community. ***It is a good idea to document your procedures for handling disk storage errors along with your other data processing operational procedures.***

The most effective control of operations can be achieved by reviewing error information and performing recovery on a regular basis, so that error situations do not accumulate. For most situations, your recovery actions with Device Support Facilities can be scheduled at a convenient time for minimal impact on system performance and availability. It is important to remember that concurrent media maintenance allows you to continue to access the data while using Device Support Facilities to perform maintenance on the track. For more information on concurrent media maintenance see "Understanding Concurrent Media Maintenance" on page 26 and "Using Concurrent Media Maintenance" on page 58.

If your recovery actions do not correct the problem, call your IBM service representative for assistance. Have the following material available for the service representative:

- System Exception Reports obtained prior to recovery actions
- Device Support Facilities output
- System Exception Reports obtained following recovery actions.

Figure 23 (Page 1 of 2). The Steps in Error Handling

Step	Task	Tool(s)	Resulting Action
1	Detect error occurrence	System Error Summary (Part 2) report (permanent errors) DASD Subsystem Exception report (temporary errors)	If permanent error exists, perform Step 2. If temporary errors require investigation, perform Step 2.
2	Determine source of errors using EREP	DASD Subsystem Exception report	If the source of error is hardware, call your service representative. If the source of error is volume, perform Step 3.



<i>Figure 23 (Page 2 of 2). The Steps in Error Handling</i>			
<b>Step</b>	<b>Task</b>	<b>Tool(s)</b>	<b>Resulting Action</b>
<b>3</b>	<b>Determine location and nature of error using EREP.</b>	DASD Data Transfer Summary report	If location information is complete, perform Step 5.  If location information is not complete, perform Step 4.
<b>4</b>	<b>Supplement information on location and nature of error using Device Support Facilities</b>	Device Support Facilities ANALYZE DRIVETEST SCAN	Perform Step 5.
<b>5</b>	<b>Perform media maintenance.</b>	Device Support Facilities as specified in Appendix B, "Specific Guidelines by DASD Type" on page 81	Follow through as specified in Appendix B, "Specific Guidelines by DASD Type."

### **Step 1: Detecting the Error**

Generating System Exception Reports daily should be part of your routine maintenance process. Even if an error situation is reported by a user or noted from a system console message, you need to confirm the occurrence of a permanent or temporary error. For permanent errors, review the System Error Summary (Part 2). Use the Subsystem Exception DASD report to determine number and frequency of both permanent and temporary errors.

Depending on the recoverability status of the error (permanent or temporary) and the repeatability of the error, you can choose to defer further handling. The seriousness of temporary data errors is related to their number, frequency, and concentration in specific locations. The Subsystem Exception DASD report specifies the total number of temporary and permanent errors

**Note: Permanent data errors with a probable failing unit of VOLUME require immediate investigation.**

### **Step 2: Determining the Error Source with the Subsystem Exception Report**

Use the DASD Subsystem Exception report to determine whether the probable failing unit is the hardware (listed as CHANNEL, STORAGE CONTROL, CONTROLLER, and DEVICE) or if it is disk media (listed as **VOLUME**).

If the source of the error is hardware, save the DASD Subsystem Exception report output and contact your IBM service representative.

If the source of the error is VOLUME, determine the location and nature of the error (Step 3).

In your review of the DASD Subsystem Exception report, you can determine the total permanent and temporary errors for each volume ID. When a volume probable failing unit has temporary errors, you must decide whether the number of temporary errors is within acceptable limits for your processing complex.

It is important to consider the DASD type when looking at numbers of temporary errors:

- For the 3330, 3340, 3344, 3350, and those 3370s that are attached directly to a 4321, 4331, or 4361, the value given in the EREP report description for total

temporary errors (as many as 9999) is the actual number of temporary errors that occurred for that volume.

- For the 3375, 3380, 9332, 9335, and those 3370s that are not attached directly to a 4321, 4331, or 4361 the value given in the EREP report description in the temporary column indicates the number of times the subsystem reported temporary errors.

When a temporary data check occurs, the affected data is available for processing, so the operation in progress continues without interruption. At issue is whether the time and resources required for the subsystem and system to execute error recovery procedures is impacting performance. In general, the impact of the temporary error recovery process is not regarded as significant enough to take time and system resources required for immediate media maintenance— unless the frequency of temporary data checks is excessive or they occur repeatedly with frequently used data.

### **Step 3: Determining Location and Nature of Errors with the DASD Data Transfer Summary**

Use the DASD Data Transfer Summary report to determine the track or block addresses where data errors occurred on a given volume.

The DASD Data Transfer Summary contains error information for a specific time period. The amount of time that elapses between EREP report executions can affect the scope of the data included. Examining DASD Data Transfer Summary reports that collectively span a greater time period might provide a perspective that is not apparent from a single report.

The information on the DASD Data Transfer Summary might not always provide sufficient information because the application program has not referred to tracks that might need to be read to provide complete failure source analysis. Use the Device Support Facilities ANALYZE SCAN command (Step 4) to get more complete information for evaluating error occurrences, and to supplement DASD Data Transfer Summary data in the following situations:

- Permanent data checks have been reported.
- The data checks appear to be following a pattern; for example, involvement of a single head or a small range of cylinders.
- The report does not identify locations for temporary errors (applicable only to certain disk storage types).

If the location information on the DASD Data Transfer Summary is complete and none of the conditions above exists, perform media maintenance (Step 5).

### **Step 4: Supplementing Error Information with the ANALYZE Command**

Use the ANALYZE command of the Device Support Facilities, specifying DRIVETEST (for nonremovable media DASD) and, optionally, SCAN to obtain additional error information. It is not always necessary that ANALYZE SCAN operate on the entire volume:

- For a permanent data check, limit ANALYZE SCAN to a range of 10 cylinders that starts 5 tracks before the track with the error and ends 5 tracks beyond the track with the error. For example, if the error is on cylinder 55, head 6, then run ANALYZE SCAN from cylinder 50 to cylinder 60.
- For errors clustering around a single head, limit the scan to cylinders for that head only.

ANALYZE reports the tracks on which data checks are detected. Use the error information reported by ANALYZE, along with the information on the DASD Data Transfer summary, in performing media maintenance (Step 5).

If ANALYZE reports a suspected drive problem, save the ANALYZE output and call your IBM service representative.

### **Step 5: Perform Media Maintenance**

Specific error recovery instructions are provided in Appendix B, "Specific Guidelines by DASD Type" on page 81 for using Device Support Facilities for each DASD type.

To use these guidelines effectively, you first need to establish the category of error condition that exists. The error conditions to be treated are: permanent versus temporary; the number of errors on the volume; and whether cylinder/head addresses are known or unknown.

1. Using the volume serial number obtained from the Subsystem Exception DASD report, find the same volume serial number on the DASD Data Transfer Summary report. Then, confirm that the type and physical address are the same as those for the volume in the DASD Subsystem Exception report.
2. Determine how many times FAILURE AT ADDRESS appears for that volume. This count gives you the number of track or block addresses with data errors on that volume. You need to perform media maintenance on all or part of this set of tracks or blocks. This varies by DASD type.
3. For each track or block address, check to see if the data error at that address is permanent or temporary.
4. For temporary errors with no cylinder and head specifications, you can determine the number of errors by referring to the DASD Subsystem Exception report.

---

## **Additional Activities**

After performing the recovery actions specified in Step 5 in the error handling process, review the DASD Data Transfer Summary report on subsequent days to verify that the tracks or blocks that received maintenance do not have recurring errors.

Remember, if your recovery actions have not corrected the problem, call your IBM service representative for assistance and have the following material available:

- System Exception Reports obtained prior to recovery actions
- Device Support Facilities output
- System Exception Reports obtained following recovery actions.

---

## Chapter 5. Device Support Facilities

This chapter describes some functions and commands of Device Support Facilities (often referred to as ICKDSF), which are fundamental tools in diagnosing and handling DASD media errors.

Device Support Facilities is an IBM program provided for use by customers to perform volume formatting, or initialization and disk surface (media) maintenance functions. This chapter guides you in using disk surface maintenance commands and functions effectively. Given the versatility of Device Support Facilities and the fact that it operates on all models of IBM DASD, there are many combinations of commands and parameters that are device specific. Refer to *Device Support Facilities User's Guide and Reference* for complete information. For specific considerations for IBM 3380 and 3390 DASD, see *Device Support Facilities: Primer for the User of IBM Direct Access Storage*.

### Device Support Facilities Release Level

The material presented in this chapter assumes that you are using Device Support Facilities Release 11.0 or higher.

Using the information in this chapter requires an understanding of DASD physical characteristics which are discussed in "Characteristics of an Error" on page 15.

---

## Overview of Media Maintenance

Device Support Facilities consists of various commands, with multiple parameters associated with each command to tailor it for a specific operation. Various media maintenance functions associated with the following commands are discussed here:

- |                   |  |
|-------------------|--|
| <b>ANALYZE</b>    | Used to perform hardware and data verification tests, and to report the location of potential error sites.   |
| <b>INSPECT</b>    | Used for checking the media surface to detect and bypass potential error sites.  |
| <b>INIT</b>       | Used for rewriting home addresses (HA), record zeros (R0), and volume label on the volume.   |
| <b>INSTALL</b>    | Used to perform tasks necessary for installation, head-disk assembly (HDA) replacement, and physical movement of IBM 3380 and 3390 direct access storage devices.<br><br>Also used for conversion of 3390 models from "3390 mode" to "3380 track compatibility mode," or vice versa. See "Using INSTALL to Change Modes on a 3390" on page 68. |
| <b>REVALIDATE</b> | Combines track validation, problem determination, and data verification functions, and surface checking functions, if required.  |

Only applicable parameters of each of these commands are discussed in this chapter. Defaults are mentioned only when relevant. Guidelines for command use in performing media maintenance for specific error conditions are provided by DASD type in Appendix B, "Specific Guidelines by DASD Type" on page 81.

Device Support Facilities operates on one device at a time. However, more than one copy of Device Support Facilities can be used simultaneously to operate on other devices. All commands require that a device be specified. This is done with the UNIT, DDNAME, or SYSNAME parameter, depending upon your environment and the disposition of the DASD. Device specification is not included in the discussions that follow.

Commands can be conditionally combined into one Device Support Facilities invocation by use of the IF-THEN-ELSE sequence of commands. As an example, you can run an INIT (initialize) and follow it with an ANALYZE only if the INIT is successful, as follows:

```
INIT UNIT(ccuu) NOVFY VALIDATE DATA VOLID(volser)
IF LASTCC < 8 THEN -
  ANALYZE UNIT(ccuu) DRIVETEST SCAN
```

See *Device Support Facilities User's Guide and Reference* for details on command syntax.

## Establishing Guidelines for Performing Media Maintenance

It is important that you take note of devices at your data processing center that have critical data and applications before scheduling media maintenance. You might not want to any schedule media maintenance procedures at a peak period of your business day or you might choose to defer maintenance on specific volumes. It is a good idea to develop a strategy for performing media maintenance to allow for minimal interruption to your daily routine. For more information on identifying critical data on your DASD, see the appropriate Storage Subsystem Library operating environment manual listed in the "Bibliography" on page 121.

## Using Concurrent Media Maintenance

Concurrent media maintenance provides you with the ability to access your data while Device Support Facilities performs the surface checking function on the track in error. If you are running INSPECT on a 3380 or 3390 DASD attached to a 3990 Model 2 or 3 with the correct level of microcode, the surface checking function is accomplished by temporarily moving the data to an alternate track and directing I/O to that track during the Device Support Facilities operation on the original track. The data is returned to the original track when the operation completes. If the original track is defective, the data will remain on the alternate track and will not be restored to the original track.

Concurrent media maintenance, during the INSPECT command, minimizes the disruption to your operation and eliminates the need for your data to be unavailable due to media maintenance actions.

It is possible to further minimize the impact of performing media maintenance on system performance by using the INSPECT command (with concurrent media maintenance functions) in conjunction with the IODELAY command. The purpose of the IODELAY command is to "slow down" INSPECT processing by allowing a delay time in between I/O processing rather than issuing consecutive I/O operations. This will increase the run time of the INSPECT operation.

For more information on using the concurrent media maintenance function, and the IODELAY command, see the *Device Support Facilities User's Guide and Reference*.

You should review current guidelines you've established for performing media maintenance and update them to take advantage of the concurrent media maintenance capability. Performing media maintenance on high activity volumes can impact system performance, so you should consider this when scheduling maintenance tasks.

## Performing Media Maintenance on Dual Copy Volumes

With ICKDSF Release 12 and the correct level of microcode installed on the 3990, the ANALYZE and INSPECT commands allow processing on a volume in *duplex state* or *suspended duplex state*. When performing media maintenance on a volume that is part of a dual copy pair, the user may first need to determine whether it is the *primary volume* or *secondary volume* that requires media maintenance.

By using the DIRECTIO parameter with the ANALYZE or INSPECT commands, Device Support Facilities provides a means for I/O to be directed to either the primary volume or the secondary volume without having to put the volumes into *simplex mode*.

For more information on command parameters and defaults, and dual copy support, see *Device Support Facilities User's Guide and Reference*. For additional information on dual copy support, see *IBM 3990 Planning, Installation and Storage Administration Guide*.

## Performing Media Maintenance in VM

VM users should be aware that some Device Support Facilities commands and/or parameters are valid only for devices that are dedicated to a virtual machine. However, VM operating systems with CMS minidisk support for media maintenance (DIAGNOSE code X'E4' with subcodes hex.02' and X'03') provide additional capabilities. On these systems the CMS command form of ICKDSF can perform ANALYZE, without DRIVETEST, and INSPECT functions against a minidisk for which there are no outstanding write links. Users may continue to access other minidisks on the volume concurrent with the media maintenance procedure.

For more information on using Device Support Facilities in a VM environment, see *Device Support Facilities User's Guide and Reference*.

---

## The ANALYZE Command

The ANALYZE command is used to examine a device and/or the data on a volume to help determine the existence and the nature of errors. There are two parts to the command: the drive test, for nonremovable media only, (invoked by the DRIVETEST parameter) and the scan (invoked by the SCAN parameter). DRIVETEST and SCAN can be invoked independently or together.

The drive test applies only to nonremovable media. DRIVETEST performs fundamental tests to ensure that device hardware can perform basic operations, such as seeks, reads, and writes. DRIVETEST is not disruptive to user operation.

## ANALYZE on Dual Copy Volumes

When using the ANALYZE command to process dual copy volumes in duplex state or in suspended duplex state, you can use the DIRECTIO(PRIMARY) or DIRECTIO(SECONDARY) parameters to select either the primary or secondary volume. The UNITADDRESS parameter or DDNAME parameter must always point to the primary volume. See *Device Support Facilities User's Guide and Reference* for additional information, restrictions, and defaults when processing dual copy volumes.

## How to Use ANALYZE DRIVETEST

You invoke DRIVETEST by specifying:

```
ANALYZE UNIT(ccuu) DRIVETEST
```

You can also use ANALYZE DRIVETEST to identify the path to the device where an error occurred. If you specify the path control parameter, you can direct Device Support Facilities to process the drive test down every channel path, or limit processing to a specific path(s). Path control is available for any DASD that attaches to the 3990. For more information on path control see the *Device Support Facilities User's Guide and Reference*.

DRIVETEST parameter is the default when the ANALYZE command is invoked.

**Note:** Other parameters (not shown here) are available for this command. For more information on command parameters, see the *Device Support Facilities User's Guide and Reference*.

## What to Expect from ANALYZE DRIVETEST

A specific invocation of DRIVETEST produces one of two basic messages. One indicates that no drive problems were found. The other indicates a Suspected Drive Problem.

A Suspected Drive Problem message means that an error condition has been detected and that you need to call an IBM service representative.

Additional information contained in the ANALYZE output is provided to supplement the information used in the problem determination process. It is important to save this output and provide it to the service representative to aid in resolving the problem. No data is recorded in the ERDS during ANALYZE DRIVETEST processing.

Your service representative might ask for additional Device Support Facilities functions to be run as part of the repair process.

## How ANALYZE SCAN Works

SCAN reads data that currently exists on a volume. If SCAN reads the data successfully the first time, no further rereading of the track takes place. If a data check is detected on the first read, further reads of the data are issued to establish that the data check is not a random occurrence and that a message should be reported for the track.

Data is read with subsystem and error recovery processes disabled to allow SCAN to identify all data checks. Data is never recorded in the ERDS during ANALYZE SCAN processing. SCAN has no affect on user data on the volume.

## How to Use ANALYZE SCAN

SCAN is invoked by specifying:

```
ANALYZE UNIT(ccuu) SCAN
```

The SCAN parameter initiates the scan function and must be specified.

### Defaults and Optional Parameters:

- Limits can be placed on the area of data that is scanned by using the range parameters (TORANGE, FROMRANGE, CYLRANGE, HEADRANGE, LIMITS). ALL is the default limit parameter if SCAN is specified, as in the sample provided.
- SPEED can be specified to read an entire cylinder with each I/O. Caution is advised when using the SPEED option when other activity is heavy on the channel, because performance on the channel could be degraded. NOSPEED, the default, reads one track at a time. Because SPEED was not specified in the syntax shown, NOSPEED is used.
- The sample invocation provided for ANALYZE SCAN will first perform the drive test function, because DRIVETEST is also defaulted. The drive test can be bypassed by specifying NODRIVETEST.

**Note:** Other parameters (not shown here) are available for this command. For more information on command parameters, see the *Device Support Facilities User's Guide and Reference*.

## What to Expect from ANALYZE SCAN

SCAN presents messages to indicate that the error is either correctable (ECC-correctable) or uncorrectable (ECC-uncorrectable). SCAN cannot distinguish between temporary and permanent data checks because it operates with all levels of recovery disabled. An uncorrectable data check message is **not** an indication that the error would be permanent to the application when the data is accessed during normal processing and recovery procedures. For example, the data might be readable using the offset recovery process.

ANALYZE SCAN provides specific track messages. In addition, a table indicating which heads have experienced an error is presented.

### Notes on Invocations of SCAN

A data check must be detected the first time a track is read in order for further analysis of the track to take place. Any low repeatability data check can be detected on any given SCAN. Therefore, the following conditions can occur:

- Multiple runs of SCAN can produce messages regarding different tracks. (Data checks occurring as a result of additional runs are likely to be low repeatability data checks.)
- Tracks that are known to have experienced data checks might not be reported by ANALYZE SCAN.

ANALYZE SCAN contains logic to monitor data check information, and can produce a Suspected Drive Problem message when needed. It is important to save all output and provide it to the IBM service representative to aid in resolving the problem.



---

## The INSPECT Command

The INSPECT command is used for two primary purposes:

- Surface checking a track
- Rewriting data

If you are invoking INSPECT on a device not attached to a 3990 Model 2 or 3, customer workload scheduling must allow Device Support Facilities exclusive control of the track being processed. For DASD attached to the 3990 Model 2 or 3 with the correct level of microcode installed, you have the advantage of using concurrent media maintenance.

The INSPECT command uses data protection mechanisms available for each operating environment, and it locks out other processors if the DASD is shared. However, the processor affected by the INSPECT command can continue to access all tracks on the device.

You must specify either VERIFY or NOVERIFY for every invocation of the INSPECT command. VERIFY provides additional control to ensure that the existing volume serial number and/or owner identification on the volume are correct. NOVERIFY bypasses this checking, and is used in all sample invocations of INSPECT shown here.

### INSPECT on Dual Copy Volumes

The DIRECTIO(PRIMARY) and DIRECTIO(SECONDARY) parameters are provided to allow processing on dual copy volumes in duplex state or suspended duplex state. When in duplex state, only DIRECTIO(PRIMARY) is allowed, which will select the primary volume to be processed. When in suspended duplex state, either DIRECTIO(PRIMARY) or DIRECTIO(SECONDARY) are allowed to select either the primary or secondary volume to be processed.

Two copies of each track exist and, throughout the media maintenance process, the data is preserved. However, to ensure proper execution, the NOPRESERVE parameter must always be used when processing the secondary volume. The PRESERVE parameter must always be used when processing the primary volume. If errors are present using PRESERVE on the volume that is the active primary, then the dual copy pair can be split and NOPRESERVE can be used on the volume in simplex state. If duplexing has been suspended, when it is made active again, the data will be preserved from the good copy on the primary.

The UNITADDRESS parameter or DDNAME parameter must always point to the primary volume. See *Device Support Facilities User's Guide and Reference* for additional information, restrictions, and defaults when processing dual copy volumes.

### How INSPECT Works for Surface Checking

Surface checking is performed to determine the repeatability and visibility of data checks. The degree of surface checking performed is determined by the input parameters and the characteristics of the specific device type.

In order to reliably locate low-repeatability, low-visibility data checks, INSPECT performs multiple write operations on a given track or block.

## Notes on using INSPECT with Concurrent Media Maintenance

If INSPECT is processing using concurrent media maintenance functions and terminates before the task is completed, you should note the following:

- Your data remains on the alternate track and can be accessed from there until a subsequent INSPECT is run for that device.
- If a subsequent INSPECT is started from the same processor, processing continues for the track that originally received the failure.
- If a subsequent INSPECT is started from a different processor (in a shared environment), use the FORCE parameter to support recovery of a prior concurrent media maintenance failure from another processor. This is necessary to prevent multiple INSPECT jobs from different processors accessing the same track simultaneously.

**CAUTION:** Only use the FORCE parameter to recover from a prior concurrent media maintenance failure on another processor. Misuse of this parameter can cause data integrity problems when two INSPECT jobs are running simultaneously.

## Count, Key, Data (CKD) Devices

This section describes how surface checking works for devices that use the count-key-data format.

**3340, 3344, 3350, 3375, 3380, 3390:** Most media related data checks are the result of a small defective area on the surface of a track. This area can be skipped over by the DASD subsystem, and is referred to as a **skip displacement**. When a skip displacement is assigned to a track, data written on that track straddles the displaced location. Area reserved at the end of the track is used to replace the skipped area, and the track capacity remains constant.

Device Support Facilities surface checking is invoked by executing INSPECT, and is designed to detect all error sites that might produce uncorrectable or correctable data checks when user data is stored on the track. The maximum number of skip displacements that a track can have varies by device type:

<u>Device</u>	<u>Skip Displacements</u>
3340	1
3344	1
3350	3
3375	7
3380	7
3390	7

If more than the maximum number of skip displacements are needed, an alternate track assignment can be made.

Skip displacement processing has been designed to detect and skip displace all locations that are determined to have the potential of causing a data check. The skip displacement algorithm is extremely sensitive. In fact, skip displacements might be assigned to locations that were not experiencing data checks.

Skip displacements are not necessarily an indication that normal running conditions would encounter any data checks. More important, they are not an indication that an error site would be a detriment to the running of any application against user data on that track.

**3330:** Surface checking is done for the 3330 by specifying CHECK(n) on the INSPECT command, where 'n' specifies the number of times the track is examined for data checks. An alternate track is assigned if an uncorrectable data check is detected. Alternate tracks reside beyond the last cylinder on the volume. For a correctable data check, a message is issued. If an alternate track is required for a correctable data check, INSPECT can be used to unconditionally assign an alternate track.

## Fixed Block Architecture (FBA) Devices

This section describes how surface checking works for devices that use fixed-block architecture format.

**3370, 9335:** Surface checking is done for the 3370 and 9335 by specifying CHECK(n) on the INSPECT command, where 'n' specifies the number of times the block is examined for data checks. An alternate block is assigned for any data check that is detected. Alternate blocks reside on the same cylinder, or on a nearby cylinder and generally cause no measurable performance degradation.

**9332:** No surface checking is available for the 9332. INSPECT can be used to unconditionally assign an alternate block if subsystem messages direct you to do so.

## How to Use INSPECT for Surface Checking

Surface checking for a 3380 or 3390 volume is invoked by using the INSPECT command with the SKIP parameter:

```
INSPECT UNIT(ccuu) NOVERIFY SKIP TRACKS(cccc,hhhh)
```

The SKIP parameter invokes the skip displacement surface checking. The TRACKS parameter specifies the track to be processed.

### Notes on INSPECT parameters

When using the NOSKIP parameter, if a data check is detected on a track during primary checking, skip displacement is performed for that track.

Other parameters (not shown here) are available for the INSPECT command. For more information on command parameters, see the *Device Support Facilities User's Guide and Reference*.

### Defaults and Optional Parameters:

- PRESERVE is defaulted to ensure existing data is restored to the primary track when processing is complete. With DASD attached to the 3990 Models 2 or 3 with the correct level of microcode installed, concurrent media maintenance functions are also defaulted. If PRESERVE is specified, and the track is exhibiting permanent data checks that prevent the successful reading of the data, no processing is done on the track.

INSPECT can be rerun specifying NOPRESERVE to skip displace the permanent data check location on the original track. **NOPRESERVE erases the data on the track.** If NOPRESERVE is used, the data on the track must be restored using recovery procedures for your computing complex.

- The CHECK(1) parameter is the default in the syntax sample shown. This ensures that surface checking procedures are in effect for this invocation.
- ASSIGN is a default in the sample shown, and allows an alternate track to be automatically assigned if more than seven skip areas are required on the track.
- This sample invocation of INSPECT operates on one track. Multiple tracks can be specified in a single invocation.

## What to Expect from INSPECT When Surface Checking

INSPECT prints a message about any track for which it assigns a skip displacement and/or assigns an alternate track. It also provides a summary of any currently assigned alternate tracks.

Skip displacement processing requires approximately one minute per track without the concurrent media maintenance function. INSPECT does multiple writes and reads, and the track is unavailable for other use until processing on it completes. Concurrent media maintenance allows you to access the data on the track during this time.

## Rewriting Data with INSPECT

During high-activity workload periods, it might not be acceptable for a track to be unavailable for the time required to run INSPECT SKIP CHECK(1). However, with concurrent media maintenance, you can run INSPECT SKIP CHECK(1) and continue to access your data. In those cases in which you do not have access to concurrent media maintenance functions, you can rewrite data with INSPECT NOSKIP CHECK(1) and then schedule INSPECT SKIP CHECK(1) for a later time, if necessary. This rewriting process provides for possible straddling of small defects, and it also eliminates those data checks that were caused by hardware errors during writing or reading (assuming no hardware repair action was required, or has already been performed).

### Notes on the NOSKIP parameter

When using the NOSKIP parameter, if a data check is detected on a track during primary checking, skip displacement is performed for that track.

## How To Use INSPECT to Rewrite Data

The INSPECT command can be used to read and rewrite the data on a track. Existing data is read from the track. The surface of the track is checked for high repeatability, high visibility error sites, and the data is rewritten to the track.

The process of rewriting data is invoked with the INSPECT command using the CHECK(1) parameter, and using the NOSKIP parameter for CKD devices that support skip displacement processing. For devices that do not support skip displacement processing, the procedure is identical to the surface checking process; see "How INSPECT Works for Surface Checking" on page 62.

```
INSPECT UNIT(ccuu) NOVERIFY NOSKIP TRACKS(cccc,hhhh)
```

The NOSKIP parameter invokes the rewrite procedure.

The NOVERIFY parameter allows INSPECT to run on this device regardless of volume serial number and owner ID of this volume.

The TRACKS parameter specifies the track to be processed.

**Note:** Other parameters (not shown here) are available for this command. For more information on command parameters, see the *Device Support Facilities User's Guide and Reference*.

**Defaults and Optional Parameters:**

- PRESERVE is a default and therefore is not shown in the sample. It ensures the rewrite procedure.
- The CHECK parameter, which is also a default, not explicitly shown in the sample, ensures that the rewrite procedure is invoked.
- For an FBA device, specify BLOCKS (instead of TRACKS) and eliminate the NOSKIP parameter.
- The command sample shown operates on one track. Multiple tracks or blocks can be specified in the same invocation.

## What to Expect from INSPECT When Rewriting Data

If an error site is detected during any part of the rewrite procedure, surface checking procedures applicable to the device types are automatically invoked for the track or block. (See "How INSPECT Works for Surface Checking" on page 62.)

INSPECT provides a summary of all the currently assigned alternate tracks.

---

## The INIT Command

The INIT command, which performs the initialize function, always writes a volume label, a volume table of contents (VTOC), and other items required for using volumes in specific operating environments. These functions are referred to as **minimal initialization** and only minimal initialization is supported on dual copy volumes.

**Access to existing data through a previous VTOC is destroyed by use of the INIT command.** The INIT command should be followed by a command that will format the volume for the operating system that will be using it. For MVS and VSE volumes or minidisks, use the INIT command to perform a minimal initialization to write a volume label and a VTOC on the volume or minidisk. For VM volumes, you may use the ICKDSF CPVOLUME command to FORMAT/ALLOCATE cylinder zero or the entire volume.

For CKD devices, the INIT command can be used to rewrite the home address and record zero fields for all tracks on a volume. This process is called **medial initialization**, and it includes all functions provided by a minimal initialization.

For FBA devices, INIT can be invoked to reclaim alternate blocks for the entire volume. This procedure is called **maximal initialization** and includes all the functions provided by minimal initialization.

Customer workload scheduling must allow Device Support Facilities exclusive control of the volume being processed. The INIT command uses data protection mechanisms available for each operating environment, and locks out other processors if the DASD is shared. However, INIT cannot guarantee Device Support Facilities exclusive access to the volume from the same processor.

You must specify either VERIFY or NOVERIFY for every invocation of the INIT command. VERIFY provides additional control to ensure that the existing volume serial number and/or owner identification on the volume are correct. NOVERIFY bypasses this checking, and is used in all samples shown here.

## Rewriting Home Address (HA) and Record Zero (R0) with INIT

INIT run at the medial level rewrites the home address and record zero on every primary and alternate track on the volume. **All other data on the volume is erased.**

## How To Use INIT for Rewriting HAs and R0s (Medial Initialization)

Using the VALIDATE parameter with the INIT command starts medial initialization:

```
INIT UNIT(ccuu) NOVERIFY VOLID(volser) VALIDATE NODATA
```

The NOVERIFY parameter allows INSPECT to run on this device regardless of volume serial number and owner ID of this volume.

The VALIDATE parameter forces the home address and record zero on every track to be rewritten.

NODATA parameter ensures that all tracks not formatted in the minimal initialization process contain only a home address and a standard record zero at the completion of processing.

**Note:** Other parameters (not shown here) are available for this command. For more information on command parameters, see the *Device Support Facilities User's Guide and Reference*.

### **Defaults and Optional Parameters:**

- DATA can be specified instead of NODATA. That will write a full track of data on every track on the volume. That data is a predefined pattern similar to the data used to certify the volume at the factory. The data is referred to as *factory functional verification data patterns*. Note that previously existing data on the volume is erased.

## What to Expect from INIT When Rewriting HAs and R0s (Medial Initialization)

At the completion of processing, INIT provides a summary of the assigned alternate tracks. These alternates were already assigned when INIT processing began; no alternates are assigned or reclaimed as a result of a medial initialization.

For a single device, medial initialization takes from 15-60 minutes to execute, depending upon the capacity of the device. When multiple devices are being initialized concurrently, that time increases based on the number of devices and the number of paths. The run time is the same with and without the DATA option.

## Reclaiming Alternate Blocks with INIT

When INIT is run for FBA devices at the maximal level with the RECLAIM option, it effectively "unassigns" alternate blocks for those blocks that do not experience data checks during the surface checking procedure. Alternate blocks assigned at the factory are never reclaimed.

### How to Use INIT for Reclaiming Alternate Blocks on FBA Devices

Use the RECLAIM and CHECK parameters with the INIT command:

```
INIT UNIT(ccuu) NOVERIFY VOLID(volser) CHECK(3) RECLAIM
```

The NOVERIFY parameter allows INSPECT to run on this device regardless of volume serial number and owner ID of this volume.

The CHECK(3) parameter ensures a sufficient level of surface checking for each block on the volume.

RECLAIM parameter is required to regain access to blocks that were previously flagged as defective, if surface checking is successful.

### What to Expect from INIT When Reclaiming Alternate Blocks

The process takes about one hour, depending on the device type. At the completion of processing, INIT provides a summary of the assigned alternate blocks. This function is not supported for the 9332 device.

---

## The INSTALL Command

The INSTALL command is used to:

- Change modes on the 3390 device from 3390 to 3380 track compatibility mode or vice versa.
- Prepare volumes of the 3380 and 3390 DASD.

The command is an enhanced installation procedure which includes the writing of home address and record zero on every track on the volume. It can be used when the validation functions of medial initialization are desirable.

The INSTALL functions are invoked by specifying the following command.

```
INSTALL UNIT(ccuu)
```

The INSTALL command does not support dual copy volumes.

### Using INSTALL to Change Modes on a 3390

The 3390 device is capable of functioning in either **3390** or **3380 track compatibility mode**. In 3390 mode, the entire track capacity of the device is available for use. In 3380 track compatibility mode, devices are formatted so that their tracks have the same capacity as 3380 tracks. You must use the Device Support Facilities INSTALL command to change a 3390 to a particular mode.

You can switch the mode of a 3390 from 3390 mode to 3380 track compatibility mode using the SETMODE parameter as follows:

```
INSTALL UNIT(ccuu) SETMODE(3380)
```

You can switch the mode of a 3390 from 3380 track compatibility mode to 3390 mode as follows:

```
INSTALL UNIT(ccuu) SETMODE(3390)
```

For information on selecting a mode, refer to the *Device Support Facilities User's Guide and Reference*. Similar information can also be found in:

- *Using IBM 3390 Direct Access Storage in an MVS Environment*
- *Using IBM 3390 Direct Access Storage in a VM Environment*
- *Using IBM 3390 Direct Access Storage in a VSE Environment*

## What to Expect from the INSTALL Command

**After the INSTALL command processes, the volume is not initialized for any operating system or operating environment.** Alternate tracks are reset and reassigned if necessary.

After a successful completion of the INSTALL command, a minimal initialization should be run.

---

## The REVALIDATE Command

The REVALIDATE command combines the track validation functions of medial initialization with the problem determination and data verification functions of the ANALYZE command, and also the INSPECT functions, if required. This command is valid on IBM 3380 and 3390 volumes only. REVALIDATE , in one command, performs the following combination of functions:

- A drive test
- Home address and record zero validation
- Data verification of the factory functional verification data patterns (FFVDP)
- Surface checking on tracks if required.

## How to Use REVALIDATE

The REVALIDATE functions are invoked by specifying the following command:

```
REVALIDATE UNITADDRESS(ccuu) VERIFY(serial,owner)
```

The UNITADDRESS parameter identifies the device on which the volume is mounted. For *ccuu*, specify the address, in hexadecimal (3 or 4 digits), of the channel and unit on which the volume is mounted.

The UNITADDRESS parameter is required for processing a volume in MVS or in a CMS or stand-alone environment. For processing a volume in the VSE environment, the SYSNAME parameter must be used.

The VERIFY parameter is required when you want to verify the volume serial number and owner identification before processing the volume. If the volume serial number or owner identification does not match that found on the volume, the REVALIDATE command terminates.

For *serial*, substitute 1 to 6 alphanumeric characters for the volume serial number.

For *owner*, substitute 1 to 14 alphanumeric characters for the owner identification.



When you want to bypass verification of the volume serial number and owner identification, the NOVERIFY parameter must be used.

**Note:** The device must be on a channel that is online. If the device is on a channel that is offline, the program might enter a nonterminating wait state.

See *Device Support Facilities User's Guide and Reference* for more information on required parameters and restrictions.

## What to Expect From REVALIDATE

At the completion of this command, all tracks are formatted for use by IBM operating systems. Alternate tracks are reset and reassigned if necessary. **However, the volume label, VTOC, and all user data are destroyed.** The REVALIDATE command should be followed by a command that will format the volume for the operating system that will be using it. For MVS and VSE volumes or minidisks, use the INIT command to perform a minimal initialization to write a volume label and a VTOC on the volume or minidisk. For VM volumes, you may use the CPVOLUME command to FORMAT/ALLOCATE cylinder zero or the entire volume. See "The INIT Command" on page 66 for more information on minimal initialization.

Summary information regarding the results of the drive test and surface checking are presented.

### Note

This command operates on the full volume and destroys all data. It should not be used as an alternative when media maintenance actions are required for the device unless explicitly directed to do so by media maintenance procedures in Appendix B.

The REVALIDATE command does not support dual copy volumes.

---

## Appendix A. Background Information

This appendix provides background information on several topics related to direct access storage devices and the structure of the storage subsystem. An understanding of this material is helpful for performing media maintenance.

---

### Resources for Additional Information

The information in this appendix provides high-level, introductory material on disk storage function. In addition to the manuals listed in the bibliographies for this manual and other members of the Storage Subsystem Library, there are some other types of educational opportunities available from IBM. Consult your IBM representative for information on current offerings in classroom education, self-study, and technical update video presentations.

---

### DASD Physical Characteristics

The various types and models of direct access storage have some common attributes related to the physical components of the units and the way these components function together to store data. Be sure to refer to the disk storage manuals listed in the bibliography for information on the characteristics of specific types of DASD.

Disks are the media used for storing data. They are arranged either horizontally or vertically, depending on the type of DASD. As the disks rotate, the heads (which are carried on the access arms as shown in Figure 24), write and read data (bit patterns) on the disk surface. The **read/write heads** do not contact the disk surface but remain above it, on a cushion of air. The access arms and read/write heads move back and forth between the disks so that both sides of the disk surfaces can be accessed for data storage.

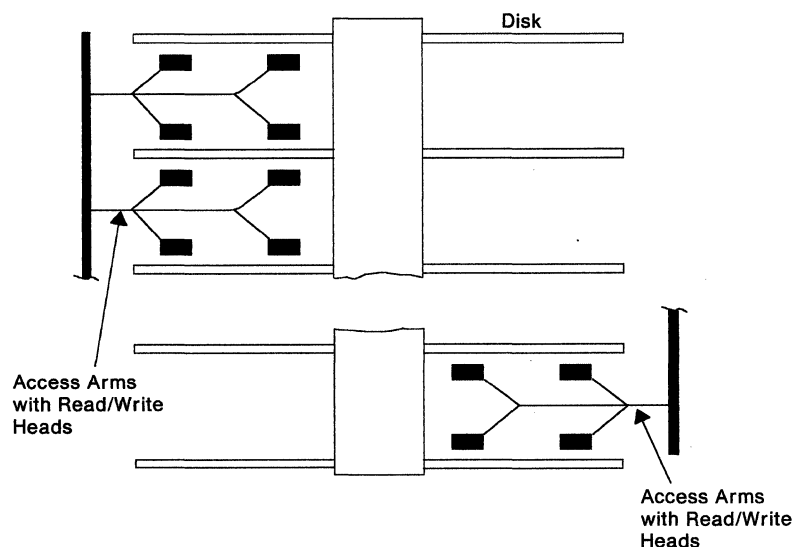

Figure 24. Disks with Two Read/Write Heads per Surface

## Disk Surface Structure - Tracks

The disk surface is subdivided into separate concentric circles, or tracks, for storing data. For a given DASD type, each track can hold the same amount of data (number of bytes). The number of tracks per disk surface and the number of bytes of data that can be stored on a track vary for the different DASD types. Refer to "Tracks and Records on CKD and FBA Devices" on page 73 for additional information on tracks and their function in structuring and addressing data.

## Access to the Disk Surface

A set of access arms that carries read/write heads accesses the disk surface. An access arm moves all the heads at the same time and for the same distance. Therefore, when the heads are positioned at a track on one of the disk surfaces, a track at the comparable location at each of the other disk surfaces is accessible with only a small movement of the access arm. Although there are multiple read/write heads on each access arm, only one head transfers data at any given time.

A set of access arms with read/write heads, the associated set of disk surfaces, and the electronic circuitry that controls access to the disk surfaces are collectively referred to as a **device**. Some types of DASD have only one device for each set of disks, but more recent types have two devices for each physical arrangement of disks. When there are two devices associated with each head-disk assembly, each is uniquely addressable and operates independently on a different subset of the disk surfaces.

See "The Components of the Storage Subsystem" on page 78 for additional information on the elements of the DASD unit.

## Cylinders

Tracks are grouped into sets called **cylinders**. Whereas CKD terminology implied that there was a geometric relationship between tracks in the same cylinder, extended count-key-data (ECKD)\* defines a cylinder to be an arbitrary grouping of tracks. The only requirement is that all cylinders contain the same number of tracks, and that tracks within a cylinder be numbered consecutively, starting with zero.

ECKD makes a specific point of discouraging geometry-dependent channel programs by systematically denying any reliable inference of device geometry underlying the track and cylinder arrangements. ECKD clearly promotes the construction of straightforward channel programs to perform data transfer operations.

## Packaging

The disk and device components for the various types of DASD are packaged in different ways. The disk pack used on a 3330, and the data module used on the 3340 can be moved from one disk drive mechanism to another by operations personnel. For 3344, 3350, 3370, 3375, 3380, 3390, 9332, and 9335 devices, the head-disk assemblies are sealed in an enclosure and permanently mounted on the drive mechanism. Only the IBM service representative can remove them. Nonremovable, sealed head-disk assemblies help to prevent problems that can cause data errors.

---

\* ECKD is a trademark of the International Business Machines Corporation.

---

## Tracks and Records on CKD and FBA Devices

There are some concepts and techniques, common to most DASD types, that are key to understanding how data is arranged for storage on disk, how it is specified for selection, and how it is grouped for transfer between the processor and disk storage. Introductory information is provided here on those topics, along with some additional considerations for the application view of data. The information is presented first for count-key-data (CKD) devices and then for fixed-block architecture (FBA) devices.

### Logical and Physical Record Relationship

The unit of data stored on disk is a **physical record**. A physical record contains both data and control information which describes the data and allows it to be checked for correctness when being read. The physical record is the unit of data that is transferred between disk storage and the processor.

A **logical record** is the unit of data that is meaningful to the user and the processing programs. The user specifies the length and format of logical records. A single logical record can be the same length as a physical record, or multiple logical records can be **blocked** into one physical record. Usually, logical records are relatively small, and combining them into physical records has several advantages:

- First, larger physical records result in better use of storage space on the track by reducing the amount of space required for addressing information and gaps and diminishing any leftover or wasted space.
- In addition, blocking can increase processing efficiency by reducing the number of I/O operations required to process data.

The operating system handles both the blocking of logical records into physical records for storage on disk, and the deblocking of records for use by the processing program.

It is possible for a logical record to extend beyond one physical record into another physical record, especially if the physical records are a predetermined fixed length that is relatively small. In this case, the operating system separates the portions of the logical record for storage on disk and then recombines them for use by the processing program. Depending on the access method used, the blocking and deblocking functions might not be performed automatically by the operating system.

### Physical Records (CKD Devices)

With CKD format DASD, the needs of the application determine the length in bytes allocated for the data portion of the physical records. A channel program writes control information for each record in a predefined pattern for CKD format. One physical record is separated from the next physical record by a gap, or unused space, on the disk surface.

**Note:** All of the disk storage types covered in this section use the **count-key-data (CKD)** format and control. Refer to "Count-Key-Data Record Format" on page 74 for more detailed descriptions of these record formats.

A physical record on a CKD DASD type has a **track address** that identifies its location on the volume. A track address is four bytes in length and consists of a cylinder number and a head number:

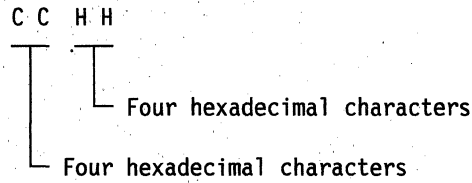

For a specific device, both cylinder and heads are numbered sequentially beginning with zeros.

With two heads per surface, the two tracks accessed when the device is in a given position have the same cylinder number. There are two possible head address numbers per surface for each cylinder address number. For example, cylinder address 02 might have head addresses 02 and 03 on one surface, 04 and 05 on another surface, and so on, depending on the number of disk surfaces.

The technique for specifying a record for selection for CKD format is by means of a 5-byte record identifier. This identifier may contain a track address and a record number or a user specified identifier. For DASD using the CKD record format, the unit of data that is transferred between disk storage and the processor might involve the entire record including the control areas, or it might involve only the data area or only the control information.

## Count-Key-Data Record Format

ECKD uses the same track addressing scheme as CKD. The track is the smallest directly addressable space on a device. Each track has an arbitrary starting point, called an *index* (see Figure 25).

You usually visualize a track as occupying a full 360 degree rotation of the disk medium; however, ECKD specifically defines tracks in such a way that there is no assurance that a track corresponds to a full device rotation.

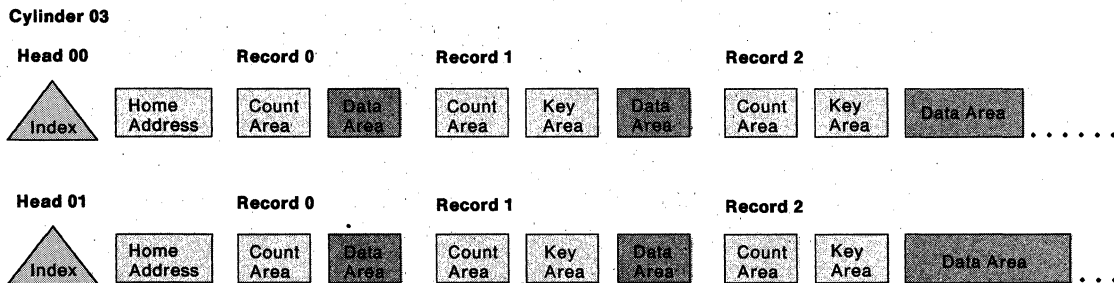

Figure 25. Count-Key-Data (CKD) Track and Record Formats

The CKD format consists of the following elements:

## Home Address

The first field on a CKD track that identifies and defines its operational status is the home address. It is written on each track immediately after the index point.

The home address area also includes descriptive information on the condition of the track. For most CKD direct access storage, there is information to control the skipping of defective areas on the track. A flag in the home address area indicates whether an entire track is defective or whether it is an alternate for another track that is defective.

The home address is written during the manufacturing process and is sometimes rewritten by means of the Device Support Facilities in performing maintenance operations.

## Record Zero

The *track descriptor record* is always the first record on the track following the home address. It is **record zero (R0)**. If a flag in the home address area indicates the track is defective, then the count area of record zero contains the track address of the track that is to be used as an alternate. The count area of record zero on the alternate track contains the track address of the defective, primary track. The data area of a standard record zero is 8 bytes long and is initialized to zero.

Record zero is written during the manufacturing process. When it is necessary to rewrite record zero in performing maintenance operations with the Device Support Facilities, all data on the track is erased.

## Data Records

Following the track descriptor record (record zero), one or more user records can be written on the track. These records are typically numbered in sequence. Each of these physical records contains a count area, an optional key area, and a data area, each of which is separated by a gap. Checking information is added to each area when it is written and is used later for detecting and correcting data errors.

**Count Area** contains the ID of the data area that follows. The record ID is specified by a value expressed as five bytes (CCHHR). In addition to the record id, the count area specifies the length in bytes of the key and data areas of the record.

**Key Area** is an optional portion of the record. It can be used by the programmer to identify the information in the data area of the record. (Note that there is no key area in the standard record zero.)

**Data Area** contains data that has been organized and arranged by the programmer.

The number of records that can be placed on a track depends on the length of the data areas of the records, whether the records contain a key area, and the size of the gaps required by the DASD type. Records may be of equal or unequal lengths.

For 3330, 3340, and 3350 disk storage, there is hardware support for extending a physical record from the end of one track to the beginning of the next. This is called **record or track overflow**. For each segment of the record that overflows to another track, there is separate control information (that is, a separate count area). For the 3375, 3380, and 3390, a physical record can not extend beyond the end of a track, because track overflow is not supported.

The terms “block” and “physical block” are sometimes used to refer to the data area of the record. The size of the data area of the physical record is used in calculating the number of records that can be placed on a track. The manuals for the specific device types provide instructions and guidance for calculating block sizes for effective performance and use of space.

## Physical Records (FBA Devices)

For **fixed-block architecture (FBA)** devices, the data area of all physical records has a standard length that is predetermined for a disk storage type. The user or application is not involved with specifying the number of bytes for the data area, and the control information is written on the track in a pre-established pattern during the manufacturing process. One physical record is separated from the next physical record by a gap, or unused space, on the disk surface.

For FBA DASD, a **relative block number** identifies the location of a specific physical record. The entire volume is formatted into a continuous sequence of numbered blocks, arranged at evenly spaced intervals.

Records selected for FBA format are specified by the relative block number. The storage subsystem converts the block number to a track address and sector location.

For DASD using the FBA record format, the unit of data that is transferred between disk storage and the processor can also involve the data area, control area, or both. In addition, it is possible for the operating system to combine multiple records for transfer at a **control interval**, which contains user data from multiple physical records plus certain control information.

## Fixed-Block Architecture Record Format

For FBA disk storage, tracks and records are formatted at the time of manufacture. Each track is subdivided into a specific number of fixed-block records. Figure 26 shows how the records are arranged on the track.

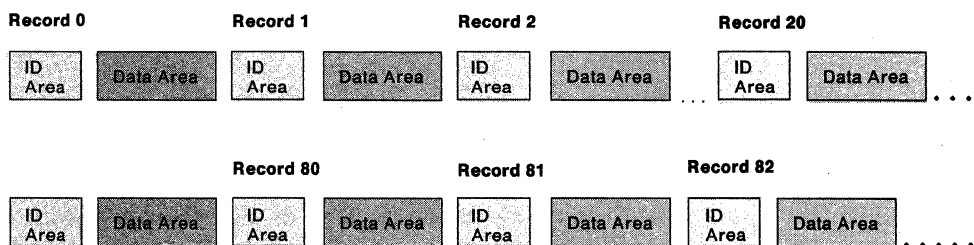

Figure 26. Fixed-Block Architecture (FBA) Track and Record Formats

Each fixed-block record has the following elements:

An **ID Area** which contains the block number and the cylinder and head numbers. If the block is skipped because it is defective, information pointing to the alternate block is contained in the ID area of the defective block. The ID area of the alternate block contains information pointing to the defective block it is replacing.

A **Data Area**, of a fixed number of bytes, to store user data.

---

## Identification of Storage Subsystem Components

Each disk storage subsystem component needs to be identifiable both for I/O selection by the operating system and for serviceability. There are two distinct types of designations for the disk storage components to fulfill these needs.

- An **I/O Address** allows the system to select a specific device.
- A **Physical Identifier** provides unique identification of each physical component of the storage subsystem.

A high-level description of each of these identification concepts follows. For detailed information on I/O addressing and identification for the specific DASD types, see the appropriate manuals listed in the bibliography.

### I/O Address

You assign the addresses that are used by the operating system to access each disk storage device for I/O operations. The addresses used for I/O selection are also reported in system console messages and included in various usage and EREP reports.

Because a disk storage device can be accessed through several different channels and storage controls, a given disk storage device has multiple access paths and thus has multiple I/O addresses.

Although a given disk storage volume can be selected by various I/O addresses that reflect different channels, the device portion of the address is always the same for a given device. Each device has a unique address that is physically set in the hardware at the time of manufacture and cannot be changed by the user.

There are valid ranges for the device addresses in a storage subsystem configuration. The operating system might impose additional addressing constraints and conventions that are not required by the hardware. In addition, operating systems have their own techniques for device identification. For example, MVS uses **unit addresses** in System/370<sup>\*</sup> mode and **device numbers** in Extended Architecture mode and ESA/370<sup>\*</sup> mode.

As configuration options for alternate access paths increase, it is important to understand and plan the addressing of I/O devices ahead of time. For specific information on bit composition and valid ranges for I/O addresses for 3380 DASD, see:

*IBM 3380 Direct Access Storage Introduction*  
*IBM 3380 Direct Access Storage Direct Channel Attach Model CJ2 Introduction and Reference.*

For similar information for the 3390, see:

*Using IBM 3390 Direct Access Storage in an MVS Environment*  
*Using IBM 3390 Direct Access Storage in a VM Environment*  
*Using IBM 3390 Direct Access Storage in a VSE Environment.*

See other disk storage manuals listed in the bibliography for information on storage subsystems composed of other DASD types.

---

\* SYSTEM/370 and ESA/370 are trademarks of the International Business Machines Corporation.



## Physical Identifier

The 3375, 3380, and 3390 direct access storage and the 3880 and 3990 storage controls, have physical identifiers. The primary purpose of the physical identifier is to describe a failing unit in an error situation, and physical IDs can also be used in configuration management. Physical IDs are especially useful for programs such as EREP, which correlate information on specific devices from multiple systems.

For a storage subsystem that has a 3880 Storage Control, each storage director, string, and device has a unique physical ID. For a storage subsystem that has a 3990 Storage Control, each logical subsystem, string, and device has a unique physical ID. These IDs (either the storage director or the subsystem, the string, and the device) cover a complete path of an error occurrence.

---

## The Components of the Storage Subsystem

A storage subsystem contains disk storage, string controllers, and storage control hardware. Collectively, these components, and the software that supports them, form the DASD storage subsystem portion of the I/O subsystem in a processor complex. A general description of each of these components is provided here; see the hardware manuals listed in the bibliography for detailed information on specific storage hardware types and models.

### Disk Storage

A direct access storage device is a complex unit consisting of various mechanical, electrical, and electronic subassemblies.

The **disks** are the media, or surfaces, on which the data is stored. For some DASD types, the disks are stacked vertically and for other types, the disks are arranged on a horizontal axis. A **drive mechanism** controls the rotation of the disks. Some DASD types have multiple drive mechanisms in each unit.

A set of **access arms** and the **read/write heads** attached to the access arms move as an independent component called an **actuator**. A set of access arms with read/write heads, the associated set of disk surfaces, and the electronic circuitry that controls access to the disk surfaces are collectively referred to as a **device**. The DASD space that is accessible by a specific device is referred to as a **volume**.

The field replaceable unit that contains the device hardware is a **head-disk assembly (HDA)**. Some types of DASD units contain more than one HDA. For example, the 3380 model AK4 has two HDAs, each of which contains two devices. A 3390 A-unit can have two or four HDAs, while a B-unit can have either two, four or six HDAs. Each 3390 HDA contains two devices.

"DASD Physical Characteristics" on page 71 provides additional information on how the DASD components function in I/O operations.

## Controllers

One or more DASD units can be connected to form a **string** of DASD. The number of DASD units allowed in a string is dependent on the disk storage type; a string may include fewer than the maximum allowable number.

The **controller** is an integral part of certain disk storage models and controls operations between the storage control and the devices. A DASD model that contains controller hardware (for example, a 3380 A-unit or C-unit) is often referred to as a **head-of-string**; the other DASD models in the string, B-units, do not contain controller hardware.

A disk storage string has one or more controllers. Two controllers, for example, may be used on a 3350 where one operates as an alternate. A 3370 string has one controller. With the exception of the 3380 Model A04 string, a string of 3380s can have two concurrently active controllers when configured with a 3880 Storage Control; a 3380 4-path string attached to a 3990 Model 2 or 3 Storage Control can have four concurrently active controllers.

A 3390 controller is sometimes referred to as a **device adapter**. This hardware component of a DASD head of string unit provides the path control and data transfer function. Four of these adapters (numbered 0-3) are contained in each 3390 A-unit and can be concurrently active.

## Storage Control

One or more DASD strings can be attached to a **storage control**. A storage control handles interaction between the processor channel and the DASD; it executes channel commands, manages subsystem error recovery, controls the DASD devices, and manages cache (when applicable). **Cache**, electronic storage in the storage control, is used to retain frequently used data for faster access by the processor.

The 3880 Storage Control has two **storage directors**, each of which has all the functions of an independent storage control unit and provides two independent paths for accessing DASD.

The 3990 Model 2 or 3 Storage Control has two independently functional areas called **storage clusters** that have separate power and service regions. Each storage cluster provides access to DASD through two **storage paths**. Depending on the configuration, as many as four independent storage paths can be available to each device in the attached string.

## Direct Channel Attach

The IBM 3380 Direct Channel Attach Model CJ2 provides 3380 disk storage, controller function for a DASD string, and storage control function in a single unit called a "C-unit." This 3380 model can be directly attached to a host processor channel. See *IBM 3380 Direct Access Storage Direct Channel Attach Introduction and Reference* for further details.



---

## Appendix B. Specific Guidelines by DASD Type

This appendix provides specific error handling guidelines for each DASD type. General error recovery procedures are described in "Chapter 2. The Error Handling Process" on page 21. Details on using the Device Support Facilities commands to perform specific functions are provided in "Chapter 5. Device Support Facilities" on page 57.

The specific guideline information is presented in tabular form, with a separate table for each error condition that applies to the DASD type. (Because they are operationally similar, guidelines for the 3375 and 3380 are combined.) The tables are preceded by special instructions for each type, as required.

The tables for each DASD type are arranged in the priority order in which you should treat the conditions. You can identify conditions from information obtained in the Service Information Messages report, if your device produces SIMs. If your device does not produce SIMs, use the DASD Data Transfer Summary report to obtain this information. These reports are described in "Using EREP to Generate Reports" on page 25.

For SIM DASD, the media maintenance procedure number determines the priority with which you should treat the procedure task(s). If you have a non-SIM DASD, and a volume shows more than one condition in the DASD Data Transfer Summary report, treat the condition with the highest priority first, and this might take care of lower priority conditions.

To use the tables, select the device type and condition that apply and then perform media maintenance actions as described.

### Device Support Facilities Commands

It is important to note that the command syntax shown in this appendix includes only relevant commands and parameters needed to illustrate the media maintenance actions. Most of the sample coding sequences shown in this appendix operate on one block or track at a time.

See the *Device Support Facilities User's Guide and Reference* for command and parameter syntax before you code any of these media maintenance actions.

The following corrective-action tables are provided in this appendix. Error conditions are listed in the priority order in which you should handle them if more than one condition is present. You can identify the presence of these conditions by reviewing the Service Information Messages report for SIM DASD, or the DASD Data Transfer Summary report for non-SIM DASD. These reports are discussed in detail in "Using EREP to Generate Reports" on page 25.

**3330 Conditions . . . . .** See "Error Handling for 3330" on page 83

1. Permanent Data Checks at 1 to 10 Tracks
2. Temporary Data Checks at Known Tracks
3. Temporary Data Checks at Unknown Tracks
4. Permanent Data Checks at 11 or More Tracks

**3340 Conditions . . . . .** See "Error Handling for the 3340" on page 86

1. Permanent Data Checks at 1 to 10 Tracks
2. Temporary Data Checks
3. Permanent Data Checks at 11 or More Tracks

**3344 Conditions . . . . .** See "Error Handling for 3344" on page 88

1. Permanent Data Checks at 1 to 10 Tracks
2. Temporary Data Checks
3. Permanent Data Checks at 11 or More Tracks

**3350 Conditions . . . . .** See "Error Handling for 3350" on page 90

1. Permanent or Temporary Data Checks with 4940/4941 Symptom Codes
2. Permanent Data Checks at 1 to 10 Tracks (<3 4940/4941 Symptom Codes)
3. Temporary Data Checks at Known Tracks (<3 4940/4941 Symptom Codes)
4. Temporary Data Checks at Unknown Tracks
5. Permanent Data Checks at 11 or More Tracks

**3370 Conditions . . . . .** See "Error Handling for 3370" on page 94

1. Permanent Data Checks at 1 to 10 Blocks
2. Temporary Data Checks at Known Blocks
3. Temporary Data Checks at Unknown Blocks
4. Permanent Data Checks at 11 or More Blocks

**3375 and 3380 Conditions. . . . .** See "Error Handling for 3375 and 3380" on page 96

1. Temporary Data Checks with Offset at 3 or More Tracks
2. Permanent Data Checks at 1 to 10 Tracks
3. Temporary Data Checks
4. Permanent Data Checks at 11 or More Tracks

**3390 . . . . .** See "Error Handling for 3390" on page 102

Procedures are odd numbers 1 through 9.

1. 3390 Media Maintenance procedure 1
2. 3390 Media Maintenance procedure 3
3. 3390 Media Maintenance procedure 5
4. 3390 Media Maintenance procedure 7
5. 3390 Media Maintenance procedure 9

**9332 Conditions. . . . .** See "Error Handling for 9332" on page 108

1. Field Replaceable Unit (FRU) Replacement
2. Alternate Block Assignment
3. File Backup

**9335 Conditions.** . . . . See "Error Handling for 9335" on page 110

1. Temporary Data Checks on Multiple Devices
2. Permanent Data Checks at 1 or 2 Blocks
3. Permanent Data Checks at 3 or More Blocks
4. Temporary Data Checks at 1 to 3 Blocks
5. Temporary Data Checks at 4 or More Blocks
6. Sector Retry Exceeded
7. Alternate Block Assignment Fails

---

## Error Handling for 3330

### Special Instructions

**Caution**

Be cautious when moving the disk pack to another drive. If there is a serious defect on the disk, you may damage a head on the other drive.

For permanent data checks, Device Support Facilities automatically assigns an alternate track if defects on the track are confirmed with surface checking.

For temporary checks with cylinder and head numbers, you may use the INSPECT command to unconditionally assign an alternate track, without surface checking the track.

If excessive temporary data checks are reported in the DASD Exception report, use the ANALYZE command with NODRIVETEST and SCAN options to determine the location of the data checks. If surface defects are confirmed, the cylinder and head numbers of the tracks are reported in Device Support Facilities messages. If you decide to take action, you may then use the INSPECT command to unconditionally assign an alternate track.

Before assigning an alternate track for temporary errors, be aware that when data is later read or written, performance can be affected by the time needed to detour to the alternate track and then return to the normal data location.

### 3330 Condition 1 - Permanent Data Check at 1 to 10 Tracks

Your Actions	Device Support Facilities Actions	Your Response to Device Support Facilities Actions
<p>You can try moving disk pack to another drive, and attempt to rerun the job. If data check does not occur, call your IBM service representative for possible hardware problem. If data check does occur, return disk pack to original drive.</p> <p><b>When moving the disk pack to another drive, it is possible to damage a head at the other drive if there is a serious defect on the disk surface.</b></p> <p><b>Important:</b> Because the data check is permanent, it is likely that the INSPECT sequence shown below will fall into the NOPRESERVE portion. Thus, your data will be lost and you will need to rely on other backup copies to recover.</p>	None	None
<p><b>Use the following Device Support Facilities command sequences:</b></p>		
<p>ANALYZE NODRIVETEST SCAN - CYLRANGE(cccc-5, cccc + 5)</p>	<p>Gives messages with cylinders and head numbers for tracks, within the specified range, that have repeatable data checks.</p>	<p>Add new tracks that ANALYZE reports as having uncorrectable data checks to those already established as permanent data checks on the volume. If the total is 10 or fewer, perform INSPECT (as shown) for each track. If the total is more than 10, call your IBM service representative.</p>
<p>INSPECT TRACK(cccc hhhh) - CHECK(1) - ASSIGN - PRESERVE IF LASTCC = 8 - THEN - INSPECT TRACK(cccc hhhh) - CHECK(1) - ASSIGN - NOPRESERVE</p>	<p>Preserves data from track if readable. Checks track surface. Skips defects. Assigns alternate track if necessary. If data is preserved, restores data.</p>	<p>If INSPECT executes and data was not preserved, restore data from a backup copy created before error occurred, and update as needed.</p>
<p><b>Note:</b> Cylinder parameters cannot be entered exactly as specified, for example: CYLRANGE(X'cccc' + 1, X'cccc' + 8). The calculation must be performed first, then enter the result.</p>		

VM users operating on volumes that are not attached to a userid should see "Performing Media Maintenance in VM" on page 59.

### 3330 Condition 2 - Temporary Data Checks at Known Tracks

Applicable when you know the error locations and want to assign alternate tracks.

Your Actions	Device Support Facilities Actions	Your Response to Device Support Facilities Actions
INSPECT TRACKS(cccc hhhh) - NOCHECK - ASSIGN - PRESERVE	Preserves data from the track. Does <i>not</i> surface check. Unconditionally assigns an alternate track for the specified track.  Restores data to alternate track.	None

VM users operating on volumes that are not attached to a userid should see "Performing Media Maintenance in VM" on page 59.

### 3330 Condition 3 - Temporary Data Checks at Unknown Tracks

Applicable when error locations (cylinder and head numbers) are unknown and you want to determine error locations.

Your Actions	Device Support Facilities Actions	Your Response to Device Support Facilities Actions
Use Device Support Facilities command ANALYZE NODRIVETEST SCAN.	If temporary data checks are repeatable, gives message with cylinder and head numbers.	Use Device Support Facilities INSPECT command as in Condition 2, <i>if you want to assign alternate tracks</i>

VM users operating on volumes that are not attached to a userid should see "Performing Media Maintenance in VM" on page 59.

### 3330 Condition 4 - Permanent Data Checks at 11 or More Tracks

Your Actions	Device Support Facilities Actions	Your Response to Device Support Facilities Actions
Call your IBM service representative	None	None

VM users operating on volumes that are not attached to a userid should see "Performing Media Maintenance in VM" on page 59.



## Error Handling for the 3340

### 3340 Condition 1 - Permanent Data Checks at 1 to 10 Tracks

Your Actions	Device Support Facilities Actions	Your Response to Device Support Facilities Actions
<p>Move data module to a different drive and attempt to read data. If data check does not occur, call your IBM service representative for a possible hardware problem. If a data check does occur, return data module to original drive.</p> <p><b>Important:</b> Because the data check is <b>permanent</b>, it is likely that the INSPECT sequence shown below will fall into the NOPRESERVE portion. Thus, your data will be lost and you will need to rely on other backup copies to recover.</p>	None	None
<b>Use the following Device Support Facilities command sequences:</b>		
<p>ANALYZE NODRIVETEST SCAN - CYLRANGE(cccc-5, cccc + 5)</p>	<p>Gives messages with cylinders and head numbers for tracks, within the specified range, that have repeatable data checks.</p>	<p>Add new tracks that ANALYZE reports as having uncorrectable data checks to those already established as permanent data checks on the volume. If the total is 10 or fewer, perform INSPECT (as shown) for each track. If the total is more than 10, call your IBM service representative.</p>
<p>INSPECT TRACK(cccc hhhh) - CHECK(1) - ASSIGN - PRESERVE IF LASTCC = 8 - THEN - INSPECT TRACK(cccc hhhh) - CHECK(1) - ASSIGN - NOPRESERVE</p>	<p>Preserves data from track if readable. Checks track surface. Skips defects. Assigns alternate track if necessary. If data is preserved, restores data.</p>	<p>If INSPECT executes and data was not preserved, restore data from a backup copy created before error occurred, and update as needed.</p>
<p><b>Note:</b> Cylinder parameters cannot be entered exactly as specified, for example: CYLRANGE(X'cccc' + 1, X'cccc' + 8). The calculation must be performed first, then enter the result.</p>		

VM users operating on volumes that are not attached to a userid should see "Performing Media Maintenance in VM" on page 59.

### 3340 Condition 2 - Temporary Data Checks

Your Actions	Device Support Facilities Actions	Your Response to Device Support Facilities Actions
INSPECT TRACKS(cccc hhhh) - CHECK(1) - ASSIGN - PRESERVE	Preserves data if readable. Checks track surfaces. Skips defects. Assigns an alternate track if necessary.  Restores data.	If data could not be preserved, you might want to use INSPECT with NOPRESERVE.

VM users operating on volumes that are not attached to a userid should see "Performing Media Maintenance in VM" on page 59.

### 3340 Condition 3 - Permanent Data Checks at 11 or More Tracks

Your Actions	Device Support Facilities Actions	Your Response to Device Support Facilities Actions
Call your IBM service representative	None	None

VM users operating on volumes that are not attached to a userid should see "Performing Media Maintenance in VM" on page 59.

## Error Handling for 3344

### 3344 Condition 1 - Permanent Data Checks at 1 to 10 Tracks

Your Actions	Device Support Facilities Actions	Your Response to Device Support Facilities Actions
<p><b>Important:</b> Because the data check is permanent, it is likely that the command sequence shown below will fall into the INSPECT NOPRESERVE portion. Thus your data will be lost and you will need to rely on other backup copies to recover.</p>	None	None
<p><b>Use the following Device Support Facilities command sequences:</b></p>		
<p>ANALYZE DRIVETEST SCAN - CYLRANGE(cccc-5, cccc + 5)</p>	<p>Exercises hardware. Gives messages with cylinders and head numbers for tracks, within the specified range, that have repeatable data checks.</p>	<p>If "Suspected Drive Problem" message from ANALYZE, use appropriate utility or program to temporarily dump as much data as possible from <i>all volumes of head disk assembly</i> to another volume. Call your service representative for a possible hardware problem.</p> <p>Add new tracks that ANALYZE reports as having uncorrectable data checks to those already established as permanent data checks on the volume. If the total is 10 or fewer, perform INSPECT (as shown) for each track. If the total is more than 10, call your IBM service representative.</p>
<p>INSPECT TRACK(cccc hhhh) - CHECK(1) - ASSIGN - PRESERVE IF LASTCC = 8 - THEN - INSPECT TRACK(cccc hhhh) - CHECK(1) - ASSIGN - NOPRESERVE</p>	<p>Preserves data from track if readable. Checks track surface. Skips defects. Assigns alternate track if necessary. If data is preserved, restores data.</p>	<p>If INSPECT executes and data was not preserved, restore data from a backup copy created before error occurred, and update as needed.</p>
<p><b>Note:</b> Cylinder parameters cannot be entered exactly as specified, for example: CYLRANGE(X'cccc' + 1, X'cccc' + 8). The calculation must be performed first, then enter the result.</p>		

VM users operating on volumes that are not attached to a userid should see "Performing Media Maintenance in VM" on page 59.

### 3344 Condition 2 - Temporary Data Checks

Your Actions	Device Support Facilities Actions	Your Response to Device Support Facilities Actions
ANALYZE DRIVETEST NOSCAN IF LASTCC < 8 - THEN - INSPECT TRACK(cccc hhhh) - CHECK(1) - ASSIGN - PRESERVE	Exercises hardware. If ANALYZE test detects hardware problem, issues diagnostic message, "Suspected Drive Problem."  If ANALYZE does not detect hardware problem, executes INSPECT. If data can be preserved, checks track surfaces. Skips defect. Assigns an alternate track if necessary.  Restores data.	If "Suspected Drive Problem" message, call your IBM service representative for a possible hardware problem.  If data could not be preserved, you may want to try INSPECT with NOPRESERVE.

VM users operating on volumes that are not attached to a userid should see "Performing Media Maintenance in VM" on page 59.

### 3344 Condition 3 - Permanent Data Checks at 11 or More Tracks

Your Actions	Device Support Facilities Actions	Your Response to Device Support Facilities Actions
Call your IBM service representative	None	None

VM users operating on volumes that are not attached to a userid should see "Performing Media Maintenance in VM" on page 59.

## Error Handling for 3350

### Special Instructions

If permanent or temporary data checks occur on three to ten tracks, examine bytes 22 and 23 of the sense information for each track address. Sense information is provided in the DASD Data Transfer Summary report, as shown in Figure 27.

---

```

UNITADDRESS 0B54  DEVTYPE 3350          VOLUME ICOM15
CPU B  PHYSICAL ADDRESS 0B54

FAILURE AT ADDRESS: CYLINDER 0003 HEAD 08          0  2  0  0
08004000 08030840 00030008 02210000 120C0496 00044940
LAST SENSE AT: 224/86 09:51:38:40

FAILURE AT ADDRESS: CYLINDER 0018 HEAD 08          0  1  0  0
08004000 08120840 00120008 02210000 121401AC 00204940
LAST SENSE AT: 225/86 22:52:06:17

```

---

Figure 27. Example of Locating 3350 Symptom Code

Bytes 22 and 23 of the sense information (shaded area) are the symptom code. Codes 4940 and 4941 indicate errors in a home address or count area. If 4940 or 4941 is indicated for three or more tracks, special treatment is needed, as described in the Condition 1 table. If you cannot copy your data, your IBM service representative might be able to help.

If temporary data checks, which exceed acceptable limits for your processing complex, are reported in the Subsystem Exception report but cylinder and head numbers are not given in the DASD Data Transfer Summary report, you may use ANALYZE SCAN to assist in determining the location of data checks.

A 3350 processing in 3330 emulation mode can be examined as a 3330, by following the 3330 guidelines. First, use the ANALYZE DRIVETEST function to determine if there is a suspected drive problem. If checking the 3350 as a 3330, defects are not skipped. However, you may want to perform error handling as it applies to a 3350 to obtain defect skipping. Follow these steps:

1. Copy the 3330 volume(s) to another volume.
2. Call your IBM service representative to put the volume in 3350 (native) mode.
3. Use the Device Support Facilities INIT command with CHECK(3). The program surface-checks all disks of the 3350 head and disk assembly, and skips any defects.
4. Have your IBM service representative put the volume back into emulation mode.
5. Re-initialize the 3330 volumes, using the INIT command with VALIDATE.
6. Restore the data.

### 3350 Condition 1 - Permanent or Temporary Data Checks with 4940/4941 Symptom Code

Applicable when **at least three tracks** show sense bytes 22 and 23 equal to 4940 or 4941.

Your Actions	Device Support Facilities Actions	Your Response to Device Support Facilities Actions
Use appropriate utilities or program to copy data from volume temporarily to another volume.	None	None
ANALYZE DRIVETEST NOSCAN IF LASTCC < 8 - THEN - INIT VALIDATE	Exercises hardware. If ANALYZE test detects hardware problem, issues diagnostic message, "Suspected Drive Problem."  If no hardware problem detected, executes INIT.  Rewrites home address and record zero of all tracks.	If "Suspected Drive Problem" message, call your IBM service representative for a possible hardware problem.  If INIT executed, restore data from temporary copy.

VM users operating on volumes that are not attached to a userid should see "Performing Media Maintenance in VM" on page 59.

## 3350 Condition 2 - Permanent Data Checks at 1 to 10 Tracks

Applicable when three or more tracks do **not** show 4940 or 4941 in sense bytes 22 and 23. Follow the instructions for Condition 1 when the symptom code is 4940 or 4941 at three or more tracks.

Your Actions	Device Support Facilities Actions	Your Response to Device Support Facilities Actions
<p><b>Important:</b> Because the data check is <b>permanent</b>, it is likely that the command sequence shown below will fall into the INSPECT NOPRESERVE portion. Thus, your data will be lost and you will need to rely on other backup copies to recover.</p>	None	None
<p><b>Use the following Device Support Facilities command sequences:</b></p>		
<p>ANALYZE DRIVETEST SCAN - CYLRANGE(cccc-5, cccc + 5)</p>	<p>Exercises hardware. Gives messages with cylinders and head numbers for tracks, within the specified range, that have repeatable data checks.</p>	<p>If "Suspected Drive Problem" message from ANALYZE, use appropriate utility or program to temporarily dump as much data as possible from <i>all volumes of head disk assembly</i> to another volume. Call your IBM service representative for a possible hardware problem.</p> <p>Add new tracks that ANALYZE reports as having uncorrectable data checks to those already established as permanent data checks on the volume. If the total is 10 or fewer, perform INSPECT (as shown) for each track. If the total is more than 10, call your IBM service representative.</p>
<p>INSPECT TRACK(cccc hhhh) - CHECK(1) - ASSIGN - PRESERVE IF LASTCC = 8 - THEN - INSPECT TRACK(cccc hhhh) - CHECK(1) - ASSIGN - NOPRESERVE</p>	<p>Preserves data from track if readable. Checks track surface. Skips defects. Assigns alternate track if necessary. If data is preserved, restores data.</p>	<p>If INSPECT executes and data was not preserved, restore data from a backup copy created before error occurred, and update as needed.</p>
<p><b>Note:</b> Cylinder parameters cannot be entered exactly as specified, for example: CYLRANGE(X'cccc' + 1, X'cccc' + 8). The calculation must be performed first, then enter the result.</p>		

VM users operating on volumes that are not attached to a userid should see "Performing Media Maintenance in VM" on page 59.

### 3350 Condition 3 - Temporary Data Checks at Known Tracks

Applicable when three or more tracks do not show 4940 or 4941 in sense bytes 22 and 23 (or when 1 or 2 tracks do show 4940 or 4941.) Follow instructions for Condition 1 when the symptom code is 4940 or 4941 at three or more tracks.

Your Actions	Device Support Facilities Actions	Your Response to Device Support Facilities Actions
ANALYZE DRIVETEST NOSCAN IF LASTCC < 8 - THEN - INSPECT TRACK(cccc hhhh) - CHECK(1) - ASSIGN - PRESERVE	Exercises hardware. If ANALYZE test detects hardware problem, issues diagnostic message, "Suspected Drive Problem."  If no hardware problem detected, executes INSPECT. If data can be preserved, checks track surfaces. Skips defect. Assigns an alternate track if necessary.  Restores data.	If "Suspected Drive Problem" message, call your IBM service representative for a possible hardware problem.  If data cannot be preserved, you may want to try INSPECT with NOPRESERVE.

VM users operating on volumes that are not attached to a userid should see "Performing Media Maintenance in VM" on page 59.

### 3350 Condition 4 - Temporary Data Checks at Unknown Tracks

Applicable when error locations (cylinder and head numbers) are unknown and you want to determine error locations.

Your Actions	Device Support Facilities Actions	Your Response to Device Support Facilities Actions
ANALYZE DRIVETEST SCAN	Exercises hardware. If ANALYZE test detects hardware problem, issues diagnostic message, "Suspected Drive Problem."  Gives messages with cylinders and head numbers for tracks that have repeatable data checks.	If "Suspected Drive Problem" message, call your IBM service representative for a possible hardware problem.  Use INSPECT as in Condition 3.

VM users operating on volumes that are not attached to a userid should see "Performing Media Maintenance in VM" on page 59.

### 3350 Condition 5 - Permanent Data Checks at 11 or More Tracks

Your Actions	Device Support Facilities Actions	Your Response to Device Support Facilities Actions
Call your IBM service representative.	None	None

VM users operating on volumes that are not attached to a userid should see "Performing Media Maintenance in VM" on page 59.



## Error Handling for 3370

### Special Instructions

For temporary errors on 3370s not attached directly to a 4321 or 4331, you should take action whenever the error rate threshold is exceeded. Examine the DASD Data Transfer Summary report to help determine which blocks to check when the temporary threshold is exceeded. It is important to understand that the blocks indicated show the location at which an operation was in progress when the data error rate threshold for the volume was exceeded. This is not necessarily the only failing address; errors might have accumulated at other blocks on the volume until the error at this failing address caused the threshold to overflow.

**Whenever the symptom code (last 4 digits of the sense information on the DASD Data Transfer Summary report) is 4940 at more than three tracks, you should contact your hardware service representative.**

### 3370 Condition 1 - Permanent Data Checks at 1 to 10 Blocks

Your Actions	Device Support Facilities Actions	Your Response to Device Support Facilities Actions
<p><b>Important:</b> Because the data check is <b>permanent</b>, it is likely that the command sequence shown below will fall into the INSPECT NOPRESERVE portion. Thus, your data will be lost and you will need to rely on other backup copies to recover.</p>	None	None
<p><b>Use the following Device Support Facilities command sequence:</b></p>		
<pre>ANALYZE DRIVETEST NOSCAN IF LASTCC &lt; 8 - THEN DO   INSPECT BLOCK(rbn) -     CHECK(1) -     ASSIGN -     PRESERVE IF LASTCC = 8 - THEN -   INSPECT BLOCK(rbn) -     CHECK(1) -     ASSIGN -     NOPRESERVE END</pre>	<p>Exercises hardware. If ANALYZE test detects hardware problem, issues diagnostic message, "Suspected Drive Problem."</p> <p>If ANALYZE test does not detect hardware problem, executes INSPECT. Preserves data from block if readable. Checks block surface. If defects confirmed, assigns alternate block. If data was preserved, restores data.</p>	<p>If "Suspected Drive Problem" message, use appropriate utility or program to copy as much data as possible from <i>all volumes of head disk assembly</i> to other volumes. Call your IBM service representative for a possible hardware problem.</p> <p>If INSPECT executes and data was not preserved, restore data from backup copy created before error occurred, and update as needed.</p>

VM users operating on volumes that are not attached to a userid should see "Performing Media Maintenance in VM" on page 59.

### 3370 Condition 2 - Temporary Data Checks at Known Blocks

Applicable when the 3370 is attached directly to a 4321 or 4331 and temporary data checks occur, or when the 3370 is not attached directly to a 4321 or 4331 and the data error rate threshold is exceeded.

Your Actions	Device Support Facilities Actions	Your Response to Device Support Facilities Actions
ANALYZE DRIVETEST NOSCAN IF LASTCC < 8 - THEN - INSPECT BLOCK(rbn) - CHECK(1) - ASSIGN - PRESERVE	Exercises hardware. If ANALYZE test detects hardware problem, issues diagnostic message, "Suspected Drive Problem."  If ANALYZE test does not detect hardware problem, executes INSPECT. If data can be preserved, checks block surface. If defect confirmed, assigns alternate block. Restores data.	If "Suspected Drive Problem" message, call your IBM service representative for a possible hardware problem.  If data could not be preserved, you may want to try INSPECT with NOPRESERVE.

VM users operating on volumes that are not attached to a userid should see "Performing Media Maintenance in VM" on page 59.

### 3370 Condition 3 - Temporary Data Checks at Unknown Blocks

Applicable when the 3370 is attached directly to a 4321 or 4331 and temporary data checks occur.

Your Actions	Device Support Facilities Actions	Your Response to Device Support Facilities Actions
ANALYZE DRIVETEST SCAN.	Exercises hardware. If ANALYZE test detects hardware problem, issues diagnostic message, "Suspected Drive Problem."  Gives messages with relative block numbers for blocks that have repeatable data checks. If temporary checks are repeatable, gives message with cylinder and head number of blocks with defects.	If "Suspected Drive Problem" message, call your IBM service representative for a possible hardware problem.  Use INSPECT as in Condition 2 if you want to assign alternate tracks.

VM users operating on volumes that are not attached to a userid should see "Performing Media Maintenance in VM" on page 59.

### 3370 Condition 4 - Permanent Data Checks at 11 or More Blocks

Your Actions	Device Support Facilities Actions	Your Response to Device Support Facilities Actions
Call your IBM service representative.	None	None

VM users operating on volumes that are not attached to a userid should see "Performing Media Maintenance in VM" on page 59.

## Error Handling for 3375 and 3380

### Special Instructions

Examine the DASD Data Transfer Summary report to determine which tracks to check when the temporary threshold is exceeded. For temporary errors, you should take action whenever the error rate threshold is exceeded. The value (number of times threshold was exceeded) is listed in the TEMPORARY column beside the address that failed when the threshold was reached.

Temporary errors can be recovered with or without offset invoked. (When offset is invoked, the error is successfully recovered by retrying the operation with the head in an offset position on the track.) Temporary errors with and without offset invoked are treated differently, as described in the condition tables. The following material describes which tracks to treat under each of these circumstances.

### With Offset Invoked

If temporary errors are retried with offset invoked, you might need to rewrite the home address. Errors recovered by retry with offset invoked are listed for the 3375 and 3380 in the DASD Data Transfer Summary report under the TEMPORARY OFFSET INVK YES column, as shown in Figure 28. In the illustration, offset is invoked on many scattered tracks on the volume. If offset is invoked on three or more tracks, special treatment is needed, as described in "3375 and 3380 Condition 1 - Temporary Data Checks with Offset at 3 or More Tracks" on page 99. For this error type, each occurrence at each location is included in the count, which is 8 in the example shown here.

				SENSE COUNTS			
				TEMPORARY		THRESHOLD	
				OFFSET	INVK	LOGGING	
				PERM	NO	YES	
*****							
UNITADDRESS	07C3	DEVTYPE	3380	VOLUME	PSG091		
CPU C	PHYSICAL ADDRESS XX-10-00						
FAILURE AT ADDRESS:	CYLINDER 0355	HEAD 00		0	0	2	0
	00001000	008F205B	01220000 08951000 0600007A 0001C000				
	LAST SENSE AT: 225/86 23:41:29:82						
FAILURE AT ADDRESS:	CYLINDER 0355	HEAD 01		0	0	1	0
	00001000	008F205B	01220000 08951000 0600007A 0001C000				
	LAST SENSE AT: 224/86 14:23:39:42						
FAILURE AT ADDRESS:	CYLINDER 0770	HEAD 02		0	0	3	0
	00001000	0002315B	01950001 08951000 06000F5A 00400000				
	LAST SENSE AT: 224/86 16:13:20:39						
FAILURE AT ADDRESS:	CYLINDER 0328	HEAD 05		0	0	2	0
	00001000	0048125B	01480002 195C1000 0600072A 00100000				
	LAST SENSE AT: 225/86 22:34:11:07						

Figure 28. Example of DASD Data Transfer Summary Report, with Offset Invoked

### Without Offset Invoked

The threshold for temporary data errors represents an accumulation of temporary error counts for a volume. A value other than zero in the TEMPORARY OFFSET INVK NO column identifies a track address where an operation was in progress when error logging was started. The value shown in the THRESHOLD LOGGING column is the total number of temporary errors logged for that cylinder/head address during the error reporting interval.

To determine which tracks to check for temporary errors without offset invoked, see the examples in Figure 29 on page 98. *Add the value in the TEMPORARY OFFSET INVK NO column to the value in the THRESHOLD LOGGING column.* The tracks with the *highest total values* are having the greatest impact on your system. Media maintenance should be performed on a track that has a total of two or more, unless a hardware failure condition exists. A track with a total of one can be ignored.

Examine the three examples in Figure 29 on page 98. In each case, the volume has exceeded the threshold two times, but the error distribution is different in each example. In Example 1, the tracks at cylinder 0328, head 02 and cylinder 0532, head 07 can be ignored. In contrast, all four tracks reported in Example 2 and all three tracks reported in Example 3, should be considered for media maintenance.

		SENSE COUNTS				
		TEMPORARY		THRESHOLD		
		OFFSET	INVK	LOGGING		
PERM	NO	YES				
*****						
UNITADDRESS 07C3	DEVTYPE 3380	VOLUME PSG091				<b>EXAMPLE 1</b>
CPU C	PHYSICAL ADDRESS XX-10-00					
FAILURE AT ADDRESS: CYLINDER 0655	HEAD 00	0	0	2		= 2
00001000 008F2053 01220000 08951000 0600007A 0001C000						
LAST SENSE AT: 224/86 23:41:29:82						
FAILURE AT ADDRESS: CYLINDER 0770	HEAD 01	0	2	15		= 17
00001000 00023153 01950001 08951000 06000F5A 00400000						
LAST SENSE AT: 224/86 16:13:20:39						
FAILURE AT ADDRESS: CYLINDER 0328	HEAD 02	0	0	1		= 1
00001000 00481253 01480002 195C1000 0600072A 00100000						
LAST SENSE AT: 224/86 22:34:11:07						
FAILURE AT ADDRESS: CYLINDER 0532	HEAD 07	0	0	1		= 1
00001000 00142753 00A70007 07811000 06000284 06000000						
LAST SENSE AT: 224/86 23:14:05:02						
*****						
UNITADDRESS 07C3	DEVTYPE 3380	VOLUME PSG091				<b>EXAMPLE 2</b>
CPU C	PHYSICAL ADDRESS XX-10-00					
FAILURE AT ADDRESS: CYLINDER 0655	HEAD 00	0	0	2		= 2
00001000 008F2053 01220000 08951000 0600007A 0001C000						
LAST SENSE AT: 225/86 23:41:29:82						
FAILURE AT ADDRESS: CYLINDER 0770	HEAD 01	0	1	15		= 16
00001000 00023153 01950001 08951000 06000F5A 00400000						
LAST SENSE AT: 225/86 16:13:20:39						
FAILURE AT ADDRESS: CYLINDER 0328	HEAD 02	0	1	2		= 3
00001000 00481253 01480002 195C1000 0600072A 00100000						
LAST SENSE AT: 225/86 22:34:11:07						
FAILURE AT ADDRESS: CYLINDER 0532	HEAD 07	0	0	2		= 2
00001000 00142753 00A70007 07811000 06000284 06000000						
LAST SENSE AT: 225/86 23:14:05:02						
*****						
UNITADDRESS 07C3	DEVTYPE 3380	VOLUME PSG091				<b>EXAMPLE 3</b>
CPU C	PHYSICAL ADDRESS XX-10-00					
FAILURE AT ADDRESS: CYLINDER 0655	HEAD 00	0	1	2		= 3
00001000 008F2053 01220000 08951000 0600007A 0001C000						
LAST SENSE AT: 226/86 23:41:29:82						
FAILURE AT ADDRESS: CYLINDER 0770	HEAD 01	0	1	15		= 16
00001000 00023153 01950001 08951000 06000F5A 00400000						
LAST SENSE AT: 226/86 16:13:20:39						
FAILURE AT ADDRESS: CYLINDER 0328	HEAD 02	0	0	22		= 22
00001000 00481253 01480002 195C1000 0600072A 00100000						
LAST SENSE AT: 226/86 22:34:11:07						

Figure 29. Example of DASD Data Transfer Summary Report, without Offset Invoked

## 3375 and 3380 Condition 1 - Temporary Data Checks with Offset at 3 or More Tracks

Applicable when offset is invoked at three or more tracks. Refer to the special instructions at the beginning of this section.

Your Actions	Device Support Facilities Actions	Your Response to Device Support Facilities Actions
Use appropriate utilities or program to copy data from volume temporarily to another volume.	None	None
<b>Use the following Device Support Facilities command sequence:</b>		
ANALYZE DRIVETEST NOSCAN IF LASTCC < 8 - THEN - INIT VALIDATE	Exercises hardware. If ANALYZE test detects hardware problem, issues diagnostic message, "Suspected Drive Problem."  If ANALYZE test does not detect hardware problem, executes INIT.  Rewrites home address and record zero on each track of volume.	If "Suspected Drive Problem" message, call your IBM service representative for a possible hardware problem.  If INIT executes, restore data from temporary copy.

VM users operating on volumes that are not attached to a userid should see "Performing Media Maintenance in VM" on page 59.

If the volume requiring media maintenance is part of a dual copy pair, the DIRECTIO parameter allows you to specify the proper volume of the pair. See "Performing Media Maintenance on Dual Copy Volumes" on page 59.

**3375 and 3380 Condition 2 - Permanent Data Checks at 1 to 10 Tracks**

Your Actions	Device Support Facilities Actions	Your Response to Device Support Facilities Actions
<p><b>Important:</b> Because the data check is permanent, it is likely that the command sequence shown below will fall into the INSPECT NOPRESERVE portion. Thus, your data will be lost and you will need to rely on other backup copies to recover.</p>	<p>None</p>	<p>None</p>
<p><b>Use the following Device Support Facilities command sequences:</b></p>		
<p>ANALYZE DRIVETEST SCAN - CYLRANGE(cccc-5, cccc + 5)</p>	<p>Exercises hardware. Gives messages with cylinders and head numbers for tracks, within the specified range, that have repeatable data checks.</p>	<p>If "Suspected Drive Problem" message from ANALYZE, use appropriate utility or program to temporarily dump as much data as possible from <i>all volumes of head disk assembly</i> to another volume. Call your IBM service representative for a possible hardware problem.</p> <p>Add new tracks that ANALYZE reports as having uncorrectable data checks to those already established as permanent data checks on the volume. If the total is 10 or fewer, perform INSPECT (as shown) for each track. If the total is more than 10, call your IBM service representative.</p>
<p>INSPECT TRACK(cccc hhhh) - CHECK(1) - ASSIGN - PRESERVE IF LASTCC = 8 - THEN - INSPECT TRACK(cccc hhhh) - CHECK(1) - ASSIGN - NOPRESERVE</p>	<p>Preserves data from track if readable. Checks track surface. Skips defects. Assigns alternate track if necessary. If data is preserved, restores data.</p>	<p>If INSPECT executes and data was not preserved, restore data from a backup copy created before the media problem occurred, and update as needed.</p>
<p><b>Note:</b> Cylinder parameters cannot be entered exactly as specified, for example: CYLRANGE(X'cccc' + 1, X'cccc' + 8). The calculation must be performed first, then enter the result.</p>		

VM users operating on volumes that are not attached to a userid should see "Performing Media Maintenance in VM" on page 59.

If the volume requiring media maintenance is part of a dual copy pair, the DIRECTIO parameter allows you to specify the proper volume of the pair. See "Performing Media Maintenance on Dual Copy Volumes" on page 59.

### 3375 and 3380 Condition 3 - Temporary Data Checks

Applicable for temporary checks. However, if offset has been invoked at three or more tracks, follow the instructions for Condition 1.

Your Actions	Device Support Facilities Actions	Your Response to Device Support Facilities Actions
<b>If data checks show a pattern (for example, are clustered around a single head), use the following Device Support Facilities command sequences:</b>		
ANALYZE DRIVETEST SCAN - HEADRANGE(hhhh, hhhh)	Exercises hardware. Gives messages with cylinders and head numbers for tracks, within the specified range, that have repeatable data checks.	If "Suspected Drive Problem" message from ANALYZE, use appropriate utility or program to temporarily dump as much data as possible from <i>all volumes of head disk assembly</i> to another volume. Call your IBM service representative for a possible hardware problem.  Add the new tracks that ANALYZE reports as having data checks to those already established for this head; proceed to the next step for each track.
INSPECT TRACK(cccc hhhh) - CHECK(1) - ASSIGN - PRESERVE	Preserves data from track if readable. Checks track surface. Skips defects. Assigns alternate track if necessary. Restores data.	If data could not be preserved, you may want to try INSPECT with NOPRESERVE.
<b>If data checks do not follow a pattern, use the following Device Support Facilities command sequence:</b>		
ANALYZE DRIVETEST NOSCAN IF LASTCC < 8 - THEN - INSPECT TRACK(cccc hhhh) - CHECK(1) - ASSIGN - PRESERVE	Exercises hardware.  Preserves data from track if readable. Checks track surface. Skips defects. Assigns alternate track if necessary. Restores data.	If "Suspected Drive Problem" message from ANALYZE, use appropriate utility or program to temporarily dump as much data as possible from <i>all volumes of head disk assembly</i> to another volume. Call your IBM service representative for a possible hardware problem.  If data could not be preserved, you may want to try INSPECT with NOPRESERVE.
<b>Note:</b> The HEADRANGE parameter should only specify the same value for the beginning and end of the range, for example: HEADRANGE (X'03', X'03').		

VM users operating on volumes that are not attached to a userid should see "Performing Media Maintenance in VM" on page 59.

If the volume requiring media maintenance is part of a dual copy pair, the DIRECTIO parameter allows you to specify the proper volume of the pair. See "Performing Media Maintenance on Dual Copy Volumes" on page 59.

### 3375 and 3380 Condition 4 - Permanent Data Checks at 11 or More Tracks

Your Actions	Device Support Facilities Actions	Your Response to Device Support Facilities Actions
Call your IBM service representative.	None	None

VM users operating on volumes that are not attached to a userid should see "Performing Media Maintenance in VM" on page 59.

If the volume requiring media maintenance is part of a dual copy pair, the DIRECTIO parameter allows you to specify the proper volume of the pair. See "Performing Media Maintenance on Dual Copy Volumes" on page 59.



---

## Error Handling for 3390

### Special Instructions

Each media SIM listed in the Service Information Messages report shows the failing track address and appropriate media maintenance procedure number necessary to correct the media problem. **If the SIM is listed as a SERVICE ALERT on the Service Information Messages report, contact your IBM service representative.** This section discusses error handling guidelines for the MEDIA ALERT only. The following example shows a MEDIA ALERT listed on the Service Information Messages report.

```
093/89 16:31:23:38      093/89 16:31:23:38
MEDIA ALERT  3390-02  S/N 0113-T4172 REFCODE 4380-E081-2585 ID=08
TEMPORARY DATA CHECK(S) ON SSID 0040, VOLSER JES8E5 DEV 08E5, 59
  PHYSICAL DEVICE 25, CYLINDER 0669 TRACK 03
REFERENCE MEDIA MAINTENANCE PROCEDURE 5
```

When viewing the SIM, check the media maintenance procedure number and find the corresponding media maintenance procedure that is described in the following tables. This will tell you which Device Support Facilities action to take. The media maintenance procedures are numbered 1, 3, 5, 7 and 9. The 3390 device is capable of operating in 3390 mode or 3380 track compatibility mode. Media maintenance is performed in the same manner, regardless of the mode of the device. For more information on the modes a 3390 can operate in, see:

*Using the IBM 3390 Direct Access Storage in an MVS Environment*  
*Using the IBM 3390 Direct Access Storage in a VM Environment*  
*Using the IBM 3390 Direct Access Storage in a VSE Environment*

### 3390 Media Maintenance Procedure 1

Conditions indicate that action is required on all tracks of the volume

Your Actions	Device Support Facilities Actions	Your Response to Device Support Facilities Actions
Use appropriate utilities or program to copy data from volume temporarily to another volume.	None	None
Use the following Device Support Facilities Command: REVALIDATE	Exercises hardware and performs all functions necessary to ensure that the device is now operating properly.	This procedure should not be used with the "system-assisted facility" for performing media maintenance since the volume must be off-line to the operating system, and all data on the volume will be destroyed.  Run minimal INIT to create volume label, volume table of contents (VTOC), etc. Restore data from the temporary copy.

VM users operating on volumes that are not attached to a userid should see "Performing Media Maintenance in VM" on page 59.

The REVALIDATE command does not support dual copy volumes. A dual copy volume must be put into simplex state before using REVALIDATE.

### 3390 Media Maintenance Procedure 3

Comprehensive analysis is required on a specific track. The error might be temporary or permanent. In addition, tracks in the vicinity of the specific track should be checked, and a comprehensive test done for them if necessary.

This procedure should not be used with the automated capability for performing media maintenance since data on the track will be destroyed.

Your Actions	Device Support Facilities Actions	Your Response to Device Support Facilities Actions
ANALYZE DDNAME(dname) + DRIVETEST NOSCAN IF LASTCC < 8 + THEN +  DO INSPECT SKIP TRACK(X'cccc' X'hhhh') + CHECK (2) ASSIGN PRESERVE + DDNAME(dname) NOVERIFY If LASTCC = 8 + THEN + INSPECT SKIP TRACK(X'cccc' X'hhhh') + CHECK (2) ASSIGN PRESERVE + DDNAME(dname) NOVERIFY	Exercises hardware.  If Analyze test detects hardware problem, issues diagnostic message "Suspected Drive Problem"  If ANALYZE test does not detect hardware problem, executes INSPECT.  Concurrently preserves data from track Checks track surface. Skips defects. Assigns alternate track if necessary. If data is preserved, restores data.	If "Suspected Drive Problem" message from ANALYZE, call your service representative for a possible hardware problem.  If INSPECT executes and data was not preserved, restore data from backup copy created before the media problem occurred, and update as needed.
INSPECT NOSKIP + HEADRANGE (X'hhhh', X'hhhh') + CYLRANGE(X'cccc' + 1, X'cccc' + 8) + CHECK (2) ASSIGN PRESERVE + DDNAME(dname) NOVERIFY	Concurrently preserves data from each track as it is processed. Performs a primary surface check on all tracks for head hhhh for all cylinders specified. If primary surface checking suspects a problem, it checks the tracks surface and assigns defects. Assigns alternate track if necessary.  Restores data.	If data could not be preserved, you may want to try INSPECT with NOPRESERVE.
INSPECT NOSKIP + HEADRANGE (X'hhhh', X'hhhh') + CYLRANGE(X'cccc' - 8, X'cccc' - 1) + CHECK (2) ASSIGN PRESERVE + DDNAME(dname) NOVERIFY END	Concurrently preserves data from each track as it is processed. Performs a primary surface check on all tracks for head hhhh for all cylinders specified. If primary surface checking suspects a problem, it checks the track's surface and assigns defects. Assigns alternate track if necessary.  Restores data.	If data could not be preserved, you may want to try INSPECT with NOPRESERVE.
<b>Note:</b> The HEADRANGE parameter should only specify the same value for the beginning and end of the range, for example: HEADRANGE (X'03', X'03'). Also, cylinder parameters cannot be entered exactly as specified, for example: CYLRANGE(X'cccc' + 1, X'cccc' + 8). The calculation must be performed first, then enter the result.		

VM users operating on volumes that are not attached to a userid should see "Performing Media Maintenance in VM" on page 59.

If the volume requiring media maintenance is part of a dual copy pair, the DIRECTIO parameter allows you to specify the proper volume of the pair. See "Performing Media Maintenance on Dual Copy Volumes" on page 59.

## 3390 Media Maintenance Procedure 5

Tracks in the vicinity of the specific track should be checked, and a comprehensive test done for them if necessary.

This procedure should not be used with the "system-assisted facility" for performing media maintenance since data on the track will be destroyed.

Your Actions	Device Support Facilities Actions	Your Response to Device Support Facilities Actions
ANALYZE DRIVETEST NOSCAN IF LASTCC < 8 + THEN +  INSPECT NOSKIP + HEADRANGE (X'hhhh', X'hhhh') + CYLRANGE(X'cccc'-8, X'cccc'+8) + CHECK (2) + ASSIGN + PRESERVE	Exercises hardware.  If Analyze test detects hardware problem, issues diagnostic message "Suspected Drive Problem"  If ANALYZE test does not detect hardware problem, executes INSPECT.  Concurrently preserves data from each track as it is processed. Performs a primary surface check on all tracks for head hhhh for all cylinders specified. If primary surface checking suspects a problem, it checks the track's surface and assigns defects. Assigns alternate track if necessary.  Restores data.	If "Suspected Drive Problem" message from ANALYZE, call your service representative for a possible hardware problem.  If data could not be preserved, you may want to try INSPECT with NOPRESERVE.
<b>Note:</b> The HEADRANGE parameter should only specify the same value for the beginning and end of the range, for example: HEADRANGE (X'03', X'03'). Also, cylinder parameters cannot be entered exactly as specified, for example: CYLRANGE(X'cccc'+1, X'cccc'+8). The calculation must be performed first, then enter the result.		

VM users operating on volumes that are not attached to a userid should see "Performing Media Maintenance in VM" on page 59.

If the volume requiring media maintenance is part of a dual copy pair, the DIRECTIO parameter allows you to specify the proper volume of the pair. See "Performing Media Maintenance on Dual Copy Volumes" on page 59.

## 3390 Media Maintenance Procedure 7

Comprehensive analysis is required on a specific track. The error might be temporary or permanent.

This procedure should not be used with the "system-assisted facility" for performing media maintenance since data on the track will be destroyed.

Your Actions	Device Support Facilities Actions	Your Response to Device Support Facilities Actions
<p><b>Important:</b> If the data check is <b>permanent</b>, it is likely that the command sequence shown below will fall into the INSPECT NOPRESERVE portion. Thus, your data will be lost and you will need to rely on other backup copies to recover. Use the following Device Support Facilities command sequence:</p>		
<pre>ANALYZE DRIVETEST NOSCAN IF LASTCC &lt; 8 + THEN +  INSPECT SKIP TRACK(X'cccc' X'hhhh') CHECK(2) - ASSIGN - PRESERVE If LASTCC = 8 - THEN - INSPECT SKIP TRACK(X'cccc' X'hhhh') + CHECK(2) + ASSIGN + NOPRESERVE</pre>	<p>Exercises hardware.</p> <p>If Analyze test detects hardware problem, issues diagnostic message "Suspected Drive Problem"</p> <p>If ANALYZE test does not detect hardware problem, executes INSPECT.</p> <p>Concurrently preserves data from the track as it is processed. Checks track surface. Skips defects. Assigns alternate track if necessary. Restores data.</p>	<p>If "Suspected Drive Problem" message from ANALYZE, call your service representative for a possible hardware problem.</p> <p>If INSPECT executes and data was not preserved, restore data from backup copy created before media problem occurred, and update as needed.</p>

VM users operating on volumes that are not attached to a userid should see "Performing Media Maintenance in VM" on page 59.

If the volume requiring media maintenance is part of a dual copy pair, the DIRECTIO parameter allows you to specify the proper volume of the pair. See "Performing Media Maintenance on Dual Copy Volumes" on page 59.

## 3390 Media Maintenance Procedure 9

The specific track is checked, and a comprehensive test done if necessary.

Your Actions	Device Support Facilities Actions	Your Response to Device Support Facilities Actions
<p>ANALYZE DRIVETEST NOSCAN IF LASTCC &lt; 8 + THEN +</p> <p>INSPECT NOSKIP + TRACK(X'cccc' X'hhhh') + CHECK(2) + ASSIGN + PRESERVE</p>	<p>Exercises hardware.</p> <p>If Analyze test detects hardware problem, issues diagnostic message "Suspected Drive Problem"</p> <p>If ANALYZE test does not detect hardware problem, executes INSPECT.</p> <p>Concurrently preserves data from each track as it is processed. Performs a primary surface check on all tracks for head hhhh for all cylinders specified. If primary surface checking suspects a problem, it checks the track's surface and assigns defects. Assigns alternate track if necessary.</p> <p>Restores data.</p>	<p>If "Suspected Drive Problem" message from ANALYZE, call your service representative for a possible hardware problem.</p> <p>If data could not be preserved, you may want to try INSPECT with NOPRESERVE.</p>

VM users operating on volumes that are not attached to a userid should see "Performing Media Maintenance in VM" on page 59.

If the volume requiring media maintenance is part of a dual copy pair, the DIRECTIO parameter allows you to specify the proper volume of the pair. See "Performing Media Maintenance on Dual Copy Volumes" on page 59.

## Error Handling for 9332

The 9332 contains sophisticated error detection, thresholding, isolation, and reporting that helps to reduce your involvement in maintenance. Media and hardware errors are detected and tracked. Faulty field replaceable units (FRUs) requiring replacement are reported to you using the System Reference Code. The 9332 aids maintenance by monitoring media and hardware errors and reporting them when the respective threshold is exceeded. The error thresholds cannot be updated by the user.

As a result of the error handling capabilities of the 9332, you need only be concerned with the following conditions:

- Field replaceable unit (FRU) replacement
- Alternate block assignment
- File backup

### 9332 Condition 1 - Field Replaceable Unit (FRU) Replacement

9332 Actions	Your Response to 9332 Actions
A Field Replaceable Unit (FRU) needs to be replaced. You receive System Reference Code Condition 1.	Call the IBM service representative, and provide the System Reference Code (1).

VM users operating on volumes that are not attached to a userid should see "Performing Media Maintenance in VM" on page 59.

### 9332 Condition 2 - Alternate Block Assignment

9332 Actions	Your Response to 9332 Actions
The 9332 determines that an alternate block should be assigned because of a media defect. Usually the data is readable because the 9332 detects defect trends and recommends alternate block assignment before an unrecoverable data error occurs.	<p>Use the following Device Support Facilities command sequence to assign an alternate block:</p> <pre>INSPECT BLCOCK(rbn) -   NOCHECK -   ASSIGN -   PRESERVE</pre> <p>If PRESERVE fails, you can retry this step with NOPRESERVE. You will then need to restore your data from a backup copy.</p> <p>If the alternate block assignment fails, proceed as in Condition 3.</p>

VM users operating on volumes that are not attached to a userid should see "Performing Media Maintenance in VM" on page 59.

### 9332 Condition 3 - File Backup

9332 Actions	Your Response to 9332 Actions
When a condition exists that threatens data (that is, an alternate block cannot be assigned), this action is required. This recommendation means that all nearby alternates have been used. This does <i>not</i> imply that the assignment of other alternate blocks will be unsuccessful.	Use the appropriate system utility to backup the file contents, and contact your IBM service representative.

VM users operating on volumes that are not attached to a userid should see "Performing Media Maintenance in VM" on page 59.



## Error Handling for 9335

### Special Instructions

The 9335 counts the number of times that recoverable data checks occur for each device. When a predetermined number is exceeded, error information for this occurrence and the next seven occurrences is logged in EREP. On the eighth recoverable error, the EREP Informational Messages Report contains the message:

THRESHOLD LOGGING COMPLETE FOR DATA CHECKS

Recoverable errors that occur when the threshold has not been exceeded will **not** be reported to the system.

The 9335 has a Sector Read Retry counter. During internal recovery of data checks, a count is kept of the number of retries performed. If a predetermined number is exceeded, the EREP Informational Messages Report includes the message:

SECTOR RETRY THRESHOLD EXCEEDED AT BLOCK (RBN)

The "Threshold Logging" message takes precedence over the "Sector Retry Exceeded" message.

### 9335 Condition 1 - Temporary Data Checks on Multiple Devices

Occurs in connection with the message THRESHOLD LOGGING COMPLETE FOR DATA CHECKS appearing for more than one device attached to the same Model A01.

Your Actions	Device Support Facilities Actions	Your Response to Device Support Facilities Actions
Call your IBM service representative.	None	None

VM users operating on volumes that are not attached to a userid should see "Performing Media Maintenance in VM" on page 59.

## 9335 Condition 2 - Permanent Data Checks at 1 or 2 Blocks

Your Actions	Device Support Facilities Actions	Your Response to Device Support Facilities Actions
<p><b>Important:</b> Because the data check is <b>permanent</b>, it is likely that the command sequence shown below will fall into the INSPECT NOPRESERVE portion. Thus, your data will be lost and you will need to rely on other backup copies to recover.</p>	None	None
<p><b>Use the following Device Support Facilities command sequence for each block:</b></p>		
<pre>ANALYZE NOSCAN IF LASTCC &lt; 8 - THEN - INSPECT BLOCK(rbn) - CHECK(3) - ASSIGN - PRESERVE IF LASTCC = 8 - THEN - INSPECT BLOCK(rbn) - CHECK(3) ASSIGN NOPRESERVE</pre>	<p>If ANALYZE does not detect a hardware problem, INSPECT is executed. Preserves data from block if readable. Checks block surface. Assigns alternate block if necessary. If data was preserved, restores data.</p>	<p>If ANALYZE indicates that a possible hardware problem exists, call for a service representative.</p> <p>If the data on the failing block was not preserved, it will be necessary to restore it from a backup copy.</p> <p>If INSPECT ASSIGN fails because there are no spare alternate blocks left for reallocation, or there is a Missing Interrupt Handler timeout, run diagnostic test 10. If the diagnostic test fails, call your IBM service representative; otherwise, proceed as in Condition 7.</p>

VM users operating on volumes that are not attached to a userid should see "Performing Media Maintenance in VM" on page 59.

## 9335 Condition 3 - Permanent Data Check at 3 or More Blocks

Your Actions	Device Support Facilities Actions	Your Response to Device Support Facilities Actions
<p>Call your IBM service representative, and attempt to copy all data to another volume. Note that data from both devices of the model B01 should be backed up if possible.</p>	None	None

VM users operating on volumes that are not attached to a userid should see "Performing Media Maintenance in VM" on page 59.

### 9335 Condition 4 - Temporary Data Checks at 1 to 3 Blocks

Occurs in connection with "Threshold Exceeded" message for one device.

Your Actions	Device Support Facilities Actions	Your Response to Device Support Facilities Actions
ANALYZE NOSCAN IF LASTCC < 8 - THEN - INSPECT BLOCK(rbn) - CHECK(3) - ASSIGN - PRESERVE	If ANALYZE does not detect a hardware problem, INSPECT is executed. Preserves data from block if readable. Checks block surface. Assigns alternate block if necessary.  Restores data.	If ANALYZE indicates that a possible hardware problem exists, call for a IBM service representative.  If INSPECT ASSIGN fails because there are no spare alternate blocks left for reallocation or there is a Missing Interrupt Handler timeout, run diagnostic test 10. If the diagnostic test fails, call IBM service representative; otherwise, proceed as in Condition 7.

VM users operating on volumes that are not attached to a userid should see "Performing Media Maintenance in VM" on page 59.

### 9335 Condition 5 - Temporary Data Check at More Than 3 Blocks

Occurs in connection with "Threshold Exceeded" message for one device.

Your Actions	Device Support Facilities Actions	Your Response to Device Support Facilities Actions
Call your IBM service representative, and attempt to copy all data to another volume. Note that data from both devices of the model B01 should be backed up if possible.	None	None

VM users operating on volumes that are not attached to a userid should see "Performing Media Maintenance in VM" on page 59.

## 9335 Condition 6 - Sector Read Retry Exceeded

Your Actions	Device Support Facilities Actions	Your Response to Device Support Facilities Actions
INSPECT BLOCK(rbn) - CHECK(3) - ASSIGN - PRESERVE	Preserves data from block. Checks surface of block, flags defects, and assigns alternate block. Restores data.	If INSPECT fails because there are no spare alternate blocks left for reallocation or there is a Missing Interrupt Handler timeout, run diagnostic test 10. If the diagnostic test fails, call your IBM service representative; otherwise, execute the Device Support Facilities RECLAIM function. If INSPECT does not execute successfully for any other reason, call your IBM service representative.

VM users operating on volumes that are not attached to a userid should see "Performing Media Maintenance in VM" on page 59.

## 9335 Condition 7 - Alternate Block Assignment Fails

Occurs in connection with the message THRESHOLD LOGGING COMPLETE FOR DATA CHECKS appearing for more than one device attached to the same Model A01.

Your Actions	Device Support Facilities Actions	Your Response to Device Support Facilities Actions
Backup the data on the volume.	None	None
INIT CHECK(3) - RECLAIM	Reclaims all primary blocks that are not experiencing data checks.	Restore data. If condition persists, contact your IBM service representative.

VM users operating on volumes that are not attached to a userid should see "Performing Media Maintenance in VM" on page 59.



---

## Acronyms and Abbreviations

This list contains definitions for acronyms and abbreviations used in the various books in the Storage Subsystem Library. Some terms are more specifically defined in the glossary.

<b>CCH</b>	channel-check handler	<b>ESQA</b>	Extended system queue area
<b>CCHH</b>	Cylinder, cylinder, head, head	<b>FBA</b>	Fixed-block architecture
<b>CCHHR</b>	Cylinder, cylinder, head, head, record	<b>FRU</b>	Field replaceable unit
<b>CHL-I</b>	Channel interface	<b>HA</b>	Home address
<b>CHPID</b>	Channel path identifier	<b>HDA</b>	Head-disk assembly
<b>CKD</b>	Count-key-data	<b>ID</b>	Identifier
<b>CMS</b>	Conversational Monitor System	<b>IML</b>	Initial microcode load
<b>CP</b>	Control program	<b>I/O</b>	Input/output
<b>DASD</b>	Direct access storage device	<b>JCL</b>	Job control language
<b>DD</b>	Data definition	<b>MDR</b>	Miscellaneous data record
<b>DFDSS</b>	Data Facility Data Set Services	<b>OBR</b>	Outboard recorder
<b>DLS</b>	Device level selection	<b>OS</b>	Operating system
<b>DLSE</b>	Device level selection enhanced	<b>R0</b>	Record zero
<b>DPS</b>	Dynamic path selection	<b>SIM</b>	Service information message
<b>ERDS</b>	Error recording data set	<b>SLH</b>	Subchannel-logout record
<b>EREP</b>	Environmental Record Editing and Printing program	<b>SMS</b>	Storage Management Subsystem
		<b>SSID</b>	Subsystem identifier
		<b>TSO</b>	Time sharing option
		<b>VTOC</b>	Volume table of contents



---

# Glossary

This glossary contains disk storage subsystem terms used in the various books of the Storage Subsystem Library (SSL).

Each of the terms included here is not necessarily used in *this specific* book. If you do not find the term you are looking for, refer to the index or to the *Dictionary of Computing*, SC20-1699.

## A

**A-unit.** The direct access storage unit that contains the controller functions to attach to the storage control. An A-unit controls the B-units that are attached to it and is often referred to as a head of string.

**access mechanism.** See actuator.

**actuator.** A set of access arms and their attached read/write heads, which move as an independent component within a head-disk assembly (HDA). See also device and volume.

**alternate track.** On a direct access storage device, a track designated to contain data in place of a defective primary track.

## B

**B-unit.** A direct access storage unit that attaches to the subsystem through an A-unit.

## C

**C-unit.** A direct channel attach 3380 direct access storage unit that contains both the storage control functions and the DASD controller functions. A 3380 C-unit (3380 Model CJ2) functions as a head of string and controls the B-units that are attached to it.

**cache.** A random access electronic storage in selected storage controls used to retain frequently used data for faster access by the channel. For example, the 3990 Model 3 contains cache.

**channel interface (CHL-I).** The circuitry of a storage control that attaches storage paths to a host channel.

**cluster.** See storage cluster.

**concurrent media maintenance.** The capability that enables a customer to perform maintenance on a track while allowing user access to that data.

**control unit.** A hardware unit that controls the reading, writing, or displaying of data at one or more input/output devices. See also storage control.

**controller.** The hardware component of a DASD head of string unit that provides the path control and data transfer functions. For example, 3390 A-units have four controllers, and there are two controllers in a 3380 Model AE4, AK4, or CJ2. See also device adapter.

**count-key-data (CKD).** A DASD data recording format employing self-defining record formats in which each record is represented by a count area that identifies the record and specifies its format, an optional key area that may be used to identify the data area contents, and a data area that contains the user data for the record. CKD is also used to refer to a set of channel commands that are accepted by a device that employs the CKD recording format. See also extended count-key-data.

## D

**DASD.** Direct access storage device.

**DASD subsystem.** A storage control and its attached direct access storage devices.

**device.** A uniquely addressable part of a DASD unit that consists of a set of access arms, the associated disk surfaces, and the electronic circuitry required to locate, read, and write data. See also volume.

**device adapter (DA).** The hardware component of a 3390 head of string unit that provides the path control and data transfer functions. See also controller.

**device ID.** An 8-bit identifier that uniquely identifies a physical I/O device.

**device level selection (DLS).** A DASD function available with 3380 Models AD4, BD4, AE4, BE4, AJ4, BJ4, AK4, BK4, and CJ2. With DLS, each of the two controllers in the DASD string has a path to all devices in the string, and any two devices in the 2-path DASD string can read or write data simultaneously. See DLS mode.

**device level selection enhanced (DLSE).** A DASD function providing four data transfer paths to each device in a 4-path DASD string. With DLSE, any four devices in a 4-path DASD string can read or write data simultaneously. See DLSE mode.

**Device Support Facilities program (ICKDSF).** A program used to initialize DASD at installation and provide media maintenance.



**director.** See storage director.

**dual copy.** A high availability function made possible by nonvolatile storage in a 3990 Model 3. Dual copy maintains two functionally identical copies of designated DASD volumes in the logical 3990 Model 3 subsystem, and automatically updates both copies every time a write operation is issued to the dual copy logical volume.

**duplex state.** Two devices in a 3990 Model 3 subsystem are in duplex state when they have been made into a dual copy logical volume.

**dynamic path selection (DPS).** DASD subsystem functions available with all 3380 heads of string except Model A04. These functions include:

- Two controllers providing data paths from the 3380 strings to the storage directors
- Simultaneous transfer of data over two paths to two devices, providing the two devices are on separate internal paths within the string
- Sharing DASD volumes by using System-Related Reserve and Release
- Providing dynamic path reconnect to the first available path.

## E

**Environmental Record Editing and Printing (EREP) program.** The program that formats and prepares reports from the data contained in the error recording data set (ERDS).

**error recording data set (ERDS).** The area in which error records are logged. ERDS information is stored in SYS1.LOGREC by MVS, in SYSREC by VSE, and in the error recording area by VM.

**extended count-key-data.** A set of channel commands that use the CKD track format. Extended count-key-data uses the Define Extent and Locate Record commands to describe the nature and scope of a data transfer operation to the storage control to optimize the data transfer operation. The 3990 Storage Control supports the extended count-key-data commands.

## F

**fence.** To separate one or more paths or elements from the remainder of the logical DASD subsystem. The separation is by logical boundaries rather than power boundaries. This separation allows isolation of failing components so that they do not affect normal operations.

## H

**head-disk assembly (HDA).** A field replaceable unit in a direct access storage device containing the disks and actuators.

**head of string.** The unit in a DASD string that contains controller functions. Also called the A-unit. See also device adapter.

**home address (HA).** The first field on a CKD track that identifies the track and defines its operational status. The home address is written after the index point on each track.

## I

**ICKDSF.** See Device Support Facilities program.

**ICAMS.** A component of Data Facility Product that is also referred to as access method services.

**identifier (ID).** A sequence of bits or characters that identifies a program, device, controller or system.

**index point.** The reference point on a disk surface that determines the start of a track.

**initial microcode load (IML).** The act of loading microcode.

## M

**media.** The disk surface on which data is stored.

**media SIM.** A message generated when 3390 detects a device media fault that requires media maintenance. See also service information message (SIM).

## N

**nonsynchronous operation.** A type of operation in which the channel and storage control activities required to end one command and initiate the next do **not** necessarily occur within the inter-record gap between two adjacent fields. With nonsynchronous operations, the channel can be slower than the device on reads, and faster than the device on writes. The time difference in processing a channel program will be as a result of the current operating environment rather than on a property of the device or storage control. Contrast with synchronous operation.

## P

**physical ID.** A unique designation to identify specific components in a data processing complex.

**primary track.** On a direct access storage device, the original track on which data is stored. See also alternate track.

## R

**release.** A facility that allows other host systems to communicate with the reserved device. Contrast with reserve.

**resume.** A function on a 3990 Model 2 or 3 Storage Control in DLSE mode, configured with only 4-path strings. This function enables a component that has been quiesced. This function is initiated by a service representative. Contrast with quiesce.

## S

**service information message (SIM).** A message that appears on the operator console and in EREP reports, generated by a 3990, a 3380 Model CJ2, or a 3390, that contains notification of a need for repair or customer action. The SIM identifies the affected area of the storage control or device and the effect of the service action. See also media SIM.

**SIM Alert.** An operator console message that alerts the operator that an action requiring attention has occurred. The service information message (SIM) can be obtained from the EREP exception report.

**simplex state.** A volume is in the simplex state if it is not part of a dual copy logical volume. Terminating a dual copy logical volume returns the two devices to the simplex state. In this case, there is no longer any capability for either automatic updates of the secondary device or for logging changes, as would be the case in suspended duplex state.

**storage cluster.** In the 3990 Storage Control and 3380 Model CJ2, a power and service region containing two independent transfer paths. See also storage director, single-path storage director, and multipath storage director.

**storage control.** The component in a DASD subsystem that connects the DASD to the host channels. It performs channel commands and controls the DASD devices. For example, the 3990 Model 2 and Model 3 are storage controls.

**storage director.** In a 3990 storage control, a logical entity consisting of one or more physical storage paths

in the same storage cluster. In a 3880, a storage director is equivalent to a storage path. See also storage path, single-path storage director, and multipath storage director.

**storage management subsystem (SMS).** An operating environment that helps automate and centralize the management of storage. To manage storage, SMS provides the storage administrator with control over data class, storage class, management class, storage group, and automatic class selection routine definitions.

**storage path.** The hardware within the 3990 Storage Control that transfers data between the DASD and a channel. See also storage director.

**storage subsystem.** A storage control and its attached storage devices.

**string.** A series of connected DASD units sharing the same A-unit (or head of string).

**subsystem identifier (SSID).** In a 3990 Storage Control configuration, a number that identifies the physical components of a logical DASD subsystem. This number is set by the service representative at the time of installation, and is included in the vital product data in the support facility. This number is identified on the DASD A-units and 3990 operator panels.

**subsystem.** See DASD subsystem or storage subsystem.

**subsystem storage.** A term used for cache in a 3880 Model 13 or 23. See cache.

**suspended duplex state.** When only one of the devices in a dual copy logical volume is being updated because of either a permanent error condition or an authorized user command. All writes to the remaining functional device are logged. This allows for automatic resynchronization of both volumes when the dual copy logical volume is reset to the active duplex state.

## T

**track compatibility mode.** See 3380 track compatibility mode

## U

**unit address.** The last two hexadecimal digits of a DAS device address. This identifies the storage control and DAS string, controller, and device to the channel subsystem. Often used interchangeably with control unit address and device address in System/370 mode.

## V

**vital product data (VPD).** Nonvolatile data that includes configuration data, machine serial number, engineering change level, and machine features. It is maintained by the 3990 support facility. It is stored in the 3990 support facility and the 3390.

**volume.** The DASD space accessible by a single actuator.

**3380 track compatibility mode.** A mode of operation in which a 3390 device manages its tracks as if they were 3380 tracks. Contrast with 3390 mode.

**3390 mode.** The mode of the actuator when the entire capacity of the 3390 device is initialized. Contrast with 3380 track compatibility mode.

**4-path string.** A series of physically connected DASD units in which the head of string provides four data transfer paths that can operate simultaneously. A 3390 4-path string requires one A-unit, while two 3380 Model AJ4/AK4 units are required for a 3380 4-path string.

# Bibliography

The bibliography is divided into two parts. The books listed in "Part One" and "Part Two" contain more detailed information on subjects discussed in the Storage Subsystem Library. For each book, the tables show the short and expanded title with the book's order number, and a short description of its contents.

"Part One— Hardware Publications" contains **hardware** information. Storage Subsystem Library publications, along with publications containing information on physical planning and reference, 3880 storage control, and storage hardware maintenance, are listed here.

"Part Two— Software Publications" on page 123 contains **software** information related to various operating environments. Both parts are organized alphabetically by major heading, and alphabetically within each heading.

For information on how to order these manuals, contact your local IBM branch office.

## Part One— Hardware Publications

The books listed below contain more detailed information on **hardware-related** subjects. They are arranged alphabetically by major heading, and alphabetically within each heading.

Short Title	Full Title	Order Number	Contents
<b>Shared Manuals</b>			
Maintaining IBM Storage Subsystem Media	<i>Maintaining IBM Storage Subsystem Media</i>	GC26-4495	Description of DASD media maintenance and error handling
Master Index	<i>Storage Subsystem Library Master Bibliography, Index, and Glossary</i>	GC26-4496	Index to information in Storage Subsystem Library publications
<b>Storage Subsystem Library</b>			
<b>3380 DASD Manuals</b>			
IBM 3380 Direct Access Storage Introduction	<i>IBM 3380 Direct Access Storage Introduction</i>	GC26-4491	Overview of all 3380 models
IBM 3380 Direct Access Storage Direct Channel Attach Model CJ2 Introduction and Reference	<i>IBM 3380 Direct Access Storage Direct Channel Attach Model CJ2 Introduction and Reference</i>	GC26-4497	Overview of functions and reference information for 3380 Model CJ2
IBM 3380 Direct Access Storage: Reference Summary	<i>IBM 3380 Direct Access Storage: Reference Summary</i>	GX26-1678	Summary card containing 3380 device characteristics
Using the IBM 3380 Direct Access Storage in an MVS Environment	<i>Using the IBM 3380 Direct Access Storage in an MVS Environment</i>	GC26-4492	Discussion of 3380 use under MVS
Using the IBM 3380 Direct Access Storage in a VM Environment	<i>Using the IBM 3380 Direct Access Storage in a VM Environment</i>	GC26-4493	Discussion of 3380 use under VM
Using the IBM 3380 Direct Access Storage in a VSE Environment	<i>Using the IBM 3380 Direct Access Storage in a VSE Environment</i>	GC26-4494	Discussion of 3380 use under VSE
<b>Storage Subsystem Library</b>			
<b>3390 DASD Manuals</b>			
IBM 3390 Direct Access Storage Introduction	<i>IBM 3390 Direct Access Storage Introduction</i>	GC26-4573	Overview of all 3390 models
IBM 3390 Direct Access Storage Reference Summary	<i>IBM 3390 Direct Access Storage Reference Summary</i>	GX26-4577	Summary card containing 3390 device characteristics
Using IBM 3390 Direct Access Storage in an MVS Environment	<i>Using IBM 3390 Direct Access Storage in an MVS Environment</i>	GC26-4574	Discussion of 3390 use under MVS.
Using IBM 3390 Direct Access Storage in a VM Environment	<i>Using IBM 3390 Direct Access Storage in a VM Environment</i>	GC26-4575	Discussion of 3390 use under VM.
Using IBM 3390 Direct Access Storage in a VSE Environment	<i>Using IBM 3390 Direct Access Storage in a VSE Environment</i>	GC26-4576	Discussion of 3390 use under VSE
<b>Storage Subsystem Library</b>			
<b>3990 Storage Control Manuals</b>			
Cache Device Administration	<i>Cache Device Administration</i>	GC35-0101	Describes the IDCAMS cache utility commands necessary to manage cache and to obtain information about cache status and performance
IBM 3990 Storage Control Introduction	<i>IBM 3990 Storage Control Introduction</i>	GA32-0098	Overview of 3990 storage control unit functions
IBM 3990 Storage Control Planning, Installation, and Storage Administration Guide	<i>IBM 3990 Storage Control Planning, Installation, and Storage Administration Guide</i>	GA32-0100	Detailed information on installation and use of the 3990 storage control

Short Title	Full Title	Order Number	Contents
IBM 3990 Storage Control Reference	<i>IBM 3990 Storage Control Reference</i>	GA32-0099	Information on the 3990 channel interface (channel commands and sense bytes)
Introduction to Nonsynchronous Storage Subsystems	<i>Introduction to Nonsynchronous Direct Access Storage Subsystems</i>	Gc26-4519	Describes nonsynchronous operation and provides descriptions of the ECKD command set and ECKD channel programs.
<b>3880 Storage Control Information</b>			
IBM 3880 Storage Control Models 1, 2, 3, and 4 Description	<i>IBM 3880 Storage Control Models 1, 2, 3, and 4 Description Manual</i>	GA26-1661	Overview of 3880 Models 1, 2, 3, and 4 functions
IBM 3880 Storage Control Model 11 Description	<i>IBM 3880 Storage Control Model 11 Description</i>	GA32-0061	Reference manual for 3880 Model 11 functions
IBM 3880 Storage Control Model 13 Description	<i>IBM 3880 Storage Control Model 13 Description</i>	GA32-0067	Reference manual for 3880 Model 13 functions
IBM 3880 Storage Control Model 21 Description	<i>IBM 3880 Storage Control Model 21 Description</i>	GA32-0081	Reference manual for 3880 Model 21 functions
IBM 3880 Storage Control Model 21 Installation and Administration Guide	<i>IBM 3880 Storage Control Model 21 Installation and Administration Guide</i>	GA32-0085	Reference manual for 3880 Model 21 functions
IBM 3880 Storage Control Model 23 Description	<i>IBM 3880 Storage Control Model 23 Description</i>	GA32-0083	Reference manual for 3880 Model 23 functions
IBM 3880 Storage Control Model 23 Installation and Administration Guide	<i>IBM 3880 Storage Control Model 23 Installation and Administration Guide</i>	GA32-0085	Describes how to install and use the 3880 Model 23 effectively
IBM 3880 Storage Control Model 23 Introduction	<i>IBM 3880 Storage Control Model 23 Introduction</i>	GA32-0082	Overview of 3880 Model 23 functions
IBM 3880 Storage Control Model 23 with RPQ #8B0035 Description	<i>IBM 3880 Storage Control Model 23 with RPQ #8B0035 Description</i>	GA32-0087	Reference manual for 3880 Model 23 functions
Introduction to IBM 3880 Storage Control Model 21	<i>Introduction to IBM 3880 Storage Control Model 21</i>	GA32-0080	Overview of 3880 Model 21 functions
Introduction to IBM 3880 Storage Control Model 23 with RPQ #8B0035	<i>Introduction to IBM 3880 Storage Control Model 23 with RPQ #8B0035</i>	GA32-0086	Overview of 3880 Model 23 functions
<b>Other IBM Disk Storage Models</b>			
IBM 3370 Direct Access Storage Description	<i>IBM 3370 Direct Access Storage Description</i>	GA26-1657	Description of 3370 Direct Access Storage functions
IBM 3375 Direct Access Storage Description and User's Guide	<i>IBM 3375 Direct Access Storage Description and User's Guide</i>	GA26-1666	Description of 3375 Direct Access Storage functions
IBM 9332 Disk Unit Models 200/400 Customer and Service Information	<i>IBM 9332 Disk Unit Models 200/400 Customer and Service Information</i>	SX21-9854	Set of publications covering planning, installing, problem analysis, and service considerations for the IBM 9332
IBM 9335 Direct-Access Storage Subsystem Customer Information	<i>IBM 9335 Direct-Access Storage Subsystem Customer Information</i>	SX33-6058	Set of publications describing disk functional characteristics and how to set up and use the IBM 9335
Reference Manual for IBM 3330 Series Disk Storage	<i>Reference Manual for IBM 3330 Series Disk Storage</i>	GA26-1615	Reference material for 3330 Series Disk Storage
Reference Manual for IBM 3340/3344 Disk Storage	<i>Reference Manual for IBM 3340/3344 Disk Storage</i>	GA26-1619	Reference material for 3340/3344 Disk Storage
Reference Manual for IBM 3350 Direct Access Storage	<i>Reference Manual for IBM 3350 Direct Access Storage</i>	GA26-1638	Reference material for 3350 Direct Access Storage
<b>Storage Hardware Maintenance</b>			
EREP User's Guide and Reference	<i>Environmental Record Editing and Printing (EREP) program User's Guide and Reference</i>	GC28-1378	Description of EREP functions and commands for DASD media reporting
ICKDSF Primer	<i>Device Support Facilities: Primer for the User of IBM 3380 and 3390 Direct Access Storage</i>	GC26-4498	Describes how to use ICKDSF with the 3380 and 3390
ICKDSF User's Guide and Reference	<i>Device Support Facilities User's Guide and Reference</i>	GC35-0033	Description of ICKDSF functions and commands for DASD initialization and maintenance
<b>Physical Planning and Reference Information</b>			
IBM 3390 Direct Access Storage Migration Guide	<i>IBM 3390 Direct Access Storage Migration Guide</i>	GG24-3373	Provides guidelines and detailed procedures for moving MVS and VM data to 3390 from other DASD

Short Title	Full Title	Order Number	Contents
Introduction to IBM Direct Access Storage Devices	<i>Introduction to IBM Direct Access Storage Devices</i>	SR21-3208	Textbook describing large IBM early DASD and data storage theory and methods

## Part Two— Software Publications

The books listed below contain more detailed information on **software-related** subjects discussed in the Storage Subsystem Library. They are arranged alphabetically by major heading, and alphabetically within each heading.

Short Title	Full Title	Order Number	Contents
<b>DFDSS, NetView and VM Reference Information</b>			
DFDSS: User's Guide and Reference (Version 2, Release 3)	<i>Data Facility Data Set Services: User's Guide and Reference (Version 2, Release 3)</i>	SC26-4125	Describes syntax and usage of DFDSS commands
DFDSS: User's Guide Version 2 Release 4	<i>Data Facility Data Set Services: User's Guide Version 2, Release 4</i>	SC26-4388	Describes usage of DFDSS commands
NetView Customization: Writing Command Lists	<i>NetView Customization: Writing Command Lists</i>	SC31-6015	Shows step by step instructions for writing command lists (CLISTS).
VM/SP HPO CP for System Programming (Release 5)	<i>VM/SP HPO CP for System Programming (Release 5)</i>	SC19-6224	Discussion of system programming tasks and commands, including CP INDICATE, SYSOWN, MONITOR
VM/XA SP Planning and Administration	<i>VM/XA SP Planning and Administration</i>	GC23-0378	Discussion of VM/XA SP hardware and software planning, system design, and system definition



# Index

## A

access arms, description 72, 78  
actuator, description 78  
additional reference material 71  
addressing  
    CKD devices 73  
    FBA devices 76  
aid, diagnostic, EREP 25  
alternate block assignment, 9332 108  
ANALYZE command  
    multiple invocations of SCAN 61  
    relevant parameters with DRIVETEST 60  
    relevant parameters with SCAN 61  
    running the drive test 59  
    use in problem isolation 54, 56  
    using the SCAN option 60  
asynchronous notification record detail report  
    description 25  
    example 35  
    generating 25  
attributes, error 15  
automated media maintenance  
    description 38  
    SIM severity reporting option 38  
    track address in SIM Alert 37  
    using NetView in MVS 38  
        modifying the message table 38  
        sample REXX EXEC 38  
    using PROP in VM 41  
        modifying the message table 41  
        sample REXX exec 41  
    using to perform media maintenance 25

## B

backup and recovery regularly, of volumes 24  
block 76  
    on FBA devices 73  
block number, relative 76

## C

cache 79  
channel  
    as failing unit 18, 19, 54  
CKD (count-key data) devices  
    CCHH addressing 74  
    count area 75  
    data area 75  
    data record 75  
    data transfer 74  
    home address 75  
    key area 75

CKD (count-key data) devices (*continued*)  
    logical record 73  
    physical record 73  
    record format 74  
    selecting records 74  
    structure 73  
    track addressing 73  
    track descriptor record 75  
comparison table, EREP 46  
concurrent media maintenance  
    and media maintenance actions 36, 43, 53  
    automating 38  
    description 26, 58  
    Device Support Facilities Release 11 26  
    INSPECT command 63  
    IODELAY command 58  
    on a volume 19  
    PRESERVE parameter 64  
    3990 model 2 or 3  
        level of microcode 26, 58  
console SIM  
    See also SIM Alert  
    format 28  
    in MVS and VM 29  
    in VSE 30  
control interval 76  
controller  
    as failing unit 18, 19, 54  
    description 79  
counting subsystem 23  
counts  
    of disk usage factors 22  
    of errors 22  
CPU field  
    subsystem exception report 49  
    system error summary 47  
CYLINDER field  
    DASD data transfer summary 52  
cylinder, definition 72

## D

DASD 71  
DASD data transfer summary  
    comparison table 46  
    description 50  
    EREP report 44  
    find error location 54  
    using locating errors 55  
DASD SIM  
    description of 28  
DASD subsystem exception report  
    description 48  
    example 49



- DASD subsystem exception report (*continued*)
  - temporary errors 54
- data area
  - CKD devices 75
  - FBA records 76
- data check
  - description 15
  - effects 19
  - permanent 17
  - repeatability 17
  - source 18
  - temporary 17, 55
  - visibility 17
- data record 75
- data transfer
  - CKD devices 74
  - FBA devices 76
- device
  - as failing unit 18, 19, 54
  - CKD, tracks 73
  - description 72
  - FBA, blocks 73
  - I/O address 77
  - multiple 72
  - packaging 72
- device adapter
  - description 79
- Device Support Facilities
  - ANALYZE command 59
  - ANALYZE DRIVETEST 54, 59
    - path control parameter 59
  - ANALYZE SCAN 54, 56, 60
  - automated capability 38
  - commands for use with 3380 57
  - concurrent media maintenance 36, 43, 53, 58
  - DIRECTIO parameter 59
  - dual copy 59
  - general considerations for use 57
  - handling error situation 25
  - if-then-else processing 58
  - INIT command 66
  - INSPECT command 62
  - INSTALL command 68
  - invoking with PROP 41
  - IODELAY command 58
  - media maintenance actions, procedures 36, 37, 43
  - media maintenance procedures
    - description 102-107
    - Service Information Messages report 25
  - recovery actions 53
  - REVALIDATE command 69
  - sample invocation EXEC 38
  - using for DASD 37, 56
  - using to locating errors 55
- DEVTYPE field
  - DASD data transfer summary 51
- diagnostic aid, EREP 25

- direct channel attach 79
- DIRECTIO parameter 59
- disk
  - description 78
  - packaging 72
  - surface 72
- disk media, as failing unit 37, 54
  - as failing unit 37
  - DASD alert 37
  - MEDIA ALERT 37
- disk storage subsystem
  - component identification 77
- drive mechanism
  - description 78
- dual copy 59

## E

- ECC 17, 22
- emulation mode 90
- equipment check
  - description 15
  - permanent 17
  - temporary 17
- ERDS (error recording data set)
  - data captured 25
  - EREP 24
  - permanent errors recorded 50
  - system exception 25
- EREP
  - description 24
  - identifying malfunctioning units 25
  - I/O address 77
  - reports 43
    - asynchronous notification record detail 25, 28, 33
    - DASD data transfer summary 50
    - DASD subsystem exception 48
    - service information messages 28, 33
    - system error summary 46
    - system exception 25, 43
  - system exception reports
    - comparison table 46
  - total temporary errors 55
  - use 25
  - using to get a specific SIM 35
  - using to get SIM history 33
  - volumes listed in reports 45
- error
  - accumulated 48
  - attributes 15
  - automatic recovery 21
  - availability of data 19
  - category 56
  - collecting sense information 22
  - condition 56
  - confirm occurrence 37, 54
  - correcting 17, 22

**error (continued)**  
 counting 21, 24  
 DASD data transfer summary 50  
 DASD subsystem exception report 48  
 data and control, recovering 22  
 detecting 21, 22  
 determine source 37, 54  
   service information messages report 37  
 generating records 21  
 handling 37  
   basic steps 53  
   basic steps for non-SIM DASD 54  
   basic steps using SIM 37  
   by operating system 23  
   by subsystem and operating system 21  
   overview 15  
   3330 83–85  
   3340 86–87  
   3344 88–89  
   3350 90–93  
   3370 94–95  
   3375 96–101  
   3380 96–101  
   3390 102–107  
   9332 108–109  
   9335 110–113  
 identifying 27, 43  
 impact on data 20  
 locating 37  
   using DASD data transfer summary 55  
   using Device Support Facilities 55  
   using service information messages 37  
 logging 24  
 notification 21  
 permanent 16, 17, 37, 46, 54, 56  
   data 50  
   messages at console 43  
   system error summary 46  
   3330 84, 85  
   3340 86, 87  
   3344 88, 89  
   3350 92, 93  
   3370 94, 95  
   3375 100, 101  
   3380 100, 101  
   9335 111  
 perspective 16  
 recovery 22, 37, 43, 56  
   guidelines 21  
   system and subsystem 21  
 reviewing reports 43  
 reviewing SIM data 27  
 SIM Alert 28  
   console message 28  
   using the SIM Alert 28  
 SIM Alert console message 27  
 SIM generation 22  
 source 18, 44

**error (continued)**  
 specifying limits 48  
 storage 43  
 subsystem handling 22  
 system error summary 46  
 system recovery 23  
 temporary 16, 17, 50, 54, 55, 56  
   data check 55  
   logging 16  
   recovery 55  
   3330 85  
   3340 87  
   3344 89  
   3350 91, 93  
   3370 95  
   3375 99, 101  
   3380 99, 101  
   9335 110, 112  
   temporary accumulated 48  
   type 15, 44  
**ERROR DESCRIPTION field**  
   system error summary 48  
**error handling 81**  
   basics 81  
   by operating system 81  
   guidelines 81  
**ERROR PATH field**  
   system error summary 47

## **F**

failing unit 18  
**FAILURE AT ADDRESS field**  
   DASD data transfer summary 52  
**FBA (fixed-block architecture) devices**  
   general considerations 76  
   logical/physical records 76  
   record format 76  
   structure 73  
   track format 76  
 file backup, 9332 109  
**FRU**  
   description 19  
   replacement, 9332 108  
 functional verification data patterns 67

## **G**

generating asynchronous notification record detail  
   report 25  
 generating system exception reports 25  
 guidelines  
   error recovery 21, 81

## **H**

handling errors, guidelines 81

- hardware
- hardware failure
  - DASD ALERT 27
- HDA (head-disk assembly)
  - description 78
- HEAD field
  - DASD data transfer summary 52

**I**

- ICKDSF (Device Support Facilities)
  - ANALYZE command 59
  - ANALYZE DRIVETEST 54, 59
    - path control parameter 59
  - ANALYZE SCAN 54, 56, 60
    - automated capability 38
    - commands for use with 3380 57
    - concurrent media maintenance 36, 43, 53
    - general considerations for use 57
    - handling error situation 25
    - if-then-else processing 58
  - INIT command 66
  - INSPECT command 62
  - INSTALL command 68
  - invoking with PROP 41
  - media maintenance actions, procedures 36, 37, 43
  - media maintenance procedures
    - description 102–107
    - Service Information Messages report 25
  - recovery actions 53
  - REVALIDATE command 69
  - sample invocation EXEC 38
    - using for DASD 37, 56
    - using to locating errors 55
- ID area, FBA records 76
- identification
  - I/O address 77
  - physical address 77
- identifier, physical 78
- identifying errors 43
- identifying the need for service 27
- if-then-else processing 58
- impact of failure 27
- impact of repair 27
- index point
  - on track 74
- INIT command
  - for reclaiming alternate blocks 68
  - for rewriting HA and R0 67
  - general considerations 66
  - relevant parameters 67
- initializing
  - using ICKDSF 57
- initializing a volume 69
- INSPECT command
  - and concurrent media maintenance 63
  - PRESERVE parameter 64
  - relevant parameters for rewriting data 65

- INSPECT command (*continued*)
  - relevant parameters for surface checking 64
  - use in rewriting data 65
  - use in surface checking 62
- INSTALL command
  - how to use 68
  - using to change modes on a 3390 68
- invocations of ANALYZE SCAN 61
- IODELAY command
  - concurrent media maintenance 58
- I/O address
  - description 77
  - identifier 77

**J**

- JOBNAME field
  - system error summary 47

**K**

- key area 75

**L**

- limits, specifying 48
- logging subsystem 23
- logical record 73

**M**

- maximal initialization
  - description 66
- media error
  - MEDIA ALERT 27
- media maintenance
  - automated capability
    - using NetView 38
  - VM PROP 41
    - performing 37, 56
    - performing on non-SIM DASD 27, 43
    - performing on SIM DASD 27, 28
    - procedure number 37
    - procedures
      - description 102–107
    - SIM severity reporting option 38
    - tools used to perform 27
- media SIM
  - description of 28
- medial initialization
  - description 66
  - time to complete 67
- messages
  - system console 24, 28
  - SIM example 24, 28
- minimal initialization
  - description 66
- mode
  - track compatibility 68

mode (*continued*)  
3390 68

## N

### NetView

- automated capability 38
- modifying the message table 38
- sample EXEC 38
- SIM severity reporting option 38

### non-SIM DASD

- performing media maintenance on 43

## O

- offset recovery 21
- operating system
  - error handling 23
- overflow, record 75
- overrun
  - description 15
  - permanent 17
  - temporary 17

## P

- path control parameter 59

### PERM field

- DASD data transfer summary 52

### permanent check

- 3330 84, 85
- 3340 86, 87
- 3344 88, 89
- 3350 91, 92, 93
- 3370 94, 95
- 3375 100, 101
- 3380 100, 101
- 9335 111

### PHYSICAL ADDRESS (PA) field

- DASD data transfer summary 51
- subsystem exception report 49
- system error summary 47

### physical block 76

### physical characteristics

- DASD 71

### PHYSICAL ID field

- system error summary 47

### physical identifier

- description 78

### physical record 73, 76

### probable failing unit

- description 18
- hardware 48
- volume 48, 50

### PROBABLE FAILING UNIT field

- subsystem exception report 49
- system error summary 48

- probable failing unit (PFU) 18

### PROCESSOR field

- DASD data transfer summary 51
- programmable operator (PROP) facility
  - automated capability 41
  - message table modification 41
  - example 41
- programming check, description 15

## R

- read/write head 71

### record

- blocked 73
- CKD devices 73, 74
  - format 74
  - logical 73
  - physical 73
  - selection 74
- data 75
- deblocking 73
- FBA devices 73, 76
  - format 76
  - logical 73
  - physical 73
  - selection 76
- fixed block format 76
- home address, description 75
- logical physical relationship 73
- overflow 75
- per track 75
- track descriptor 75
- record number 74
- record zero (R0) 75
- recovering from errors 16
- recovery procedures 21
- relative block number 76
- reports
  - asynchronous notification record detail 28, 33
  - comparison table, EREP 46
  - DASD data transfer summary 50—53
  - DASD subsystem exception 48—50
  - obtaining 25
  - service information messages 28, 33—35
  - system error summary 46—48
  - system exception 27, 46
    - comparison table 46
  - system exception reports 25
- REVALIDATE command
  - description 69
  - how to use 69

## S

- sector location 76
- sector read retry, 9335 113
- SENSE COUNTS field
  - DASD data transfer summary 52

- sense information
  - conditions given under 22
  - definition 21
  - overview 22
- SENSE INFORMATION field
  - DASD data transfer summary 52
- service
  - identifying the need 27
- service information message
  - subsystem generation 22
- Service Information Messages report
  - example 33
  - using to handle errors 37
    - determine location 37
    - determine source 37
- SIM Alert
  - components 28
  - console message
    - in MVS and VM 29
    - in VSE 30
  - DASD 27
  - MEDIA 27
  - SERVICE 27
  - severity level 31
    - suppression 31
- SIM DASD
  - performing media maintenance on 28
- SIM (service information message)
  - asynchronous notification record detail report
    - example 35
  - console message 38
    - in MVS and VM 29
    - in VSE 30
  - DASD SIM 28
  - description 27
  - impact of failure 27
  - impact of repair 27
  - media SIM 28
  - performing media maintenance using 28
- Service Information Messages report
  - example 33
- severity levels
  - ACUTE 32
    - general description 31
  - MODERATE 32
    - relationship to failing component 32
  - SERIOUS 32
  - SERVICE 32
- severity reporting option 38
- skip displacement
  - allowable number per track 64
  - description of 63
  - how to invoke 64
  - PRESERVE parameter
    - concurrent media maintenance default 64
  - time to perform 65
- specifying limits 48

- storage control 19
  - as failing unit 18, 19, 54
  - description 79
- storage director 79
- storage path 79
- storage subsystem
  - component identification 77
  - errors 22
  - physical components 78
- subsystem
  - functions 22
  - log 23
  - role for errors 22
- subsystem exception DASD report
  - comparison table 46
  - EREP report 44
- subsystem storage
  - components 78
- system console message 24, 28
- system error summary report
  - comparison table 46
  - EREP report 44
  - example 48
  - permanent errors 54
- system exception reports
  - DASD data transfer summary 50–53
  - DASD subsystem exception 48–50
  - description 25
  - generating 25
  - system error summary 46–48

## T

- temporary check
  - 3330 85
  - 3340 87
  - 3344 89
  - 3350 91, 93
  - 3370 95
  - 3375 99, 101
  - 3380 99, 101
  - 9335 110, 112
- THRESHOLD LOGGING field
  - DASD data transfer summary 52
- TIME field
  - system error summary 47
- TOTALS field
  - subsystem exception report 50
- track
  - address 74, 76
  - disk surface 72, 74
  - format
    - CKD devices 73, 74
    - ECKD devices 74
    - FBA devices 74
  - format, FBA devices 76
- track address
  - provided in SIM Alert 37

track compatibility mode, 3380 68  
track descriptor record 75  
TYPE field  
    system error summary 47

## U

UNITADDRESS field  
    DASD data transfer summary 51

## V

volume  
    as failing unit 18, 19  
    backup 25  
    description 78  
    information, EREP 45  
    initializing 69  
    I/O address 77  
    media SIM 18  
VOLUME field  
    DASD data transfer summary 51  
    system error summary 47

## Numerics

### 3330

disk pack 72  
error counts 23, 52, 53  
error handling 83–85  
permanent check 84, 85  
record overflow 75  
temporary check 85  
temporary errors 54

### 3340

data module 72  
error counts 23, 52  
error handling 86–87  
permanent check 86, 87  
record overflow 75  
temporary check 87  
temporary errors 54

### 3344

error handling 88–89  
HDA assembly 72  
permanent check 88, 89  
temporary check 89  
temporary errors 54

### 3350

error counts 23, 52, 53  
error handling 90–93  
HDA assembly 72  
permanent check 91, 92, 93  
record overflow 75  
temporary check 91, 93  
temporary errors 54

### 3370

error counts 23, 52, 53  
error handling 94–95

### 3370 (continued)

HDA assembly 72  
limits restriction 49  
permanent check 94, 95  
temporary check 95  
temporary errors 54, 55

### 3375

error counts 23, 52  
error handling 96–101  
HDA assembly 72  
identifiers 78  
limits restriction 49  
permanent check 100, 101  
record overflow restriction 75  
temporary check 99, 101  
temporary errors 55

### 3380

error counts 23, 52  
error handling 96–101  
HDA assembly 72  
identifiers 78  
limits restriction 49  
permanent check 100, 101  
record overflow restriction 75  
temporary check 99, 101  
temporary errors 55  
track compatibility mode 68

### 3390

error counts 23  
error handling 102–107  
identifiers 78  
mode 68  
record overflow restriction 75

### 3390 media maintenance procedures

procedure 1 102  
procedure 3 104  
procedure 5 105  
procedure 7 106  
procedure 9 107

### 3990 Storage Control

SIM severity reporting option 38

### 9332

alternate block assignment 108  
error counts 23  
error handling 108–109  
file backup 109  
FRU replacement 108  
HDA assembly 72  
limits restriction 49  
temporary errors 55  
9332 108

### 9335

alternate block assignment failure 113  
error counts 23  
error handling 110–113  
HDA assembly 72  
limits restriction 49  
permanent check 111

9335 (continued)

sector read retry 113  
temporary check 110, 112  
temporary errors 55







Fold and Tape

Please do not staple

Fold and Tape



NO POSTAGE  
NECESSARY  
IF MAILED IN THE  
UNITED STATES

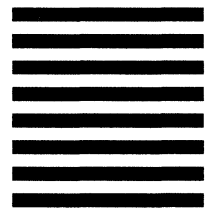

# BUSINESS REPLY MAIL

FIRST CLASS MAIL PERMIT NO. 40 ARMONK, NEW YORK

POSTAGE WILL BE PAID BY ADDRESSEE

International Business Machines Corporation  
Department J58  
PO BOX 49023  
SAN JOSE CA 95161-9945



Fold and Tape

Please do not staple

Fold and Tape



## Storage Subsystem Library

### 3390 Publications

IBM 3390 Direct Access Storage Introduction	GC26-4573
Using IBM 3390 Direct Access Storage in an MVS Environment	GC26-4574
Using IBM 3390 Direct Access Storage in a VM Environment	GC26-4575
Using IBM 3390 Direct Access Storage in a VSE Environment	GC26-4576
IBM 3390 Direct Access Storage Reference Summary	GX26-4577

### Shared Publications

Master Bibliography, Index, and Glossary	GC26-4496
Maintaining IBM Storage Subsystem Media	GC26-4495

### 3990 Publications

IBM 3990 Storage Control Introduction	GA32-0098
Introduction to Nonsynchronous Direct Access Storage Subsystems	GC26-4519
IBM 3990 Storage Control Planning, Installation, and Storage Administration Guide	GA32-0100
IBM 3990 Storage Control Reference	GA32-0099
Cache Device Administration	GC35-0101
IBM 3990 Operations Study Guide	GA32-0131
IBM 3990 Operations and Recovery Reference	GA32-0133

### 3380 Publications

IBM 3380 Direct Access Storage Introduction	GC26-4491
Using the IBM 3380 Direct Access Storage in an MVS Environment	GC26-4492
Using the IBM 3380 Direct Access Storage in a VM Environment	GC26-4493
Using the IBM 3380 Direct Access Storage in a VSE Environment	GC26-4494
IBM 3380 Direct Access Storage Reference Summary	GX26-1678
IBM 3380 Direct Access Storage Direct Channel Attach Model CJ2 Introduction and Reference	GC26-4497

GC26-4495-02

