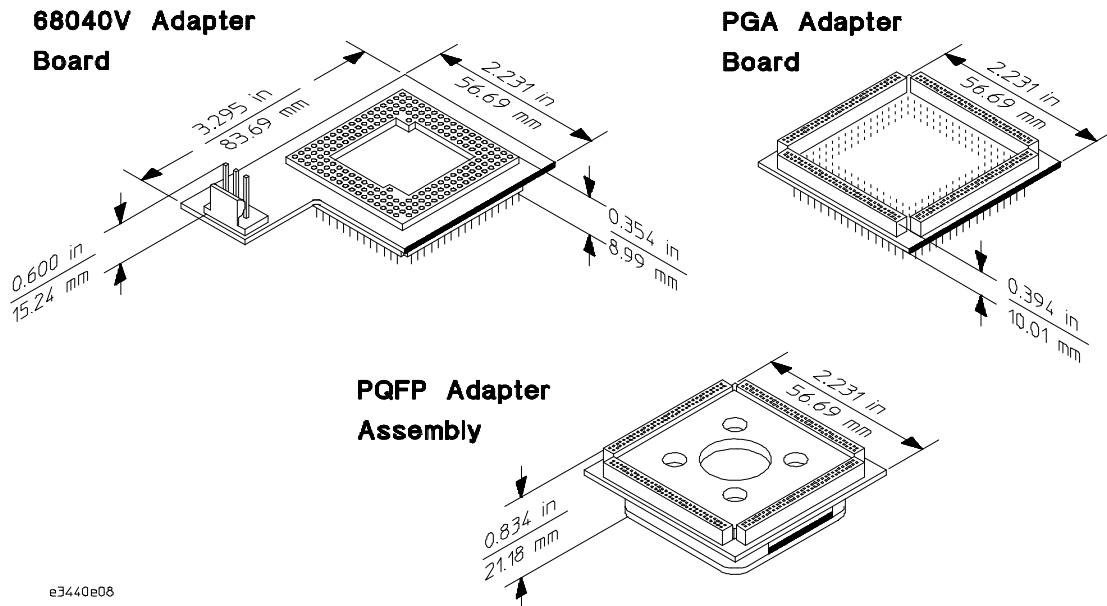

Installation Note

Publication number E3440-92000
December 1995

© Copyright Hewlett-Packard Company 1995
All Rights Reserved

HP E3440A 68040V Adapter

Your HP E3440A 68040V Adapter — At a Glance



The HP E3440A 68040V Adapter allows the HP 64783A 68040 Emulator, to be used with a 68040V target system. It adapts the 68040V pin-out to that of the 68040 processor and also provides signal and power supply translation from 3.3V to 5V.

Limitations

While the HP E3440A Adapter and HP 64783A Emulator provide a way to emulate the 68040V processor, there are some limitations. Since the processor on the HP 64783A Emulator probe is still a standard 68040 processor, the enhancements in the 68040V processor are not supported. *Specifically, the low power stop mode and low frequency operation are not supported.*

The HP E3440A can be used to probe a target system with either a PGA or PQFP 68040V processor. The following information and diagrams will show you how to probe each of these packages and also how to run the

performance verification diagnostics on the HP 64783A Emulator while using the HP E3440A Adapter.

Table 1

Performance characteristics of the HP E3440A 68040V adapter

Used With	HP 64783A Emulator	
Electrical Characteristics	Signal loading in addition to emulator load	25 pF to Vss with E3429A Flex Cable 12 pF to Vss without E3429A Flex Cable
	Maximum operating frequency	16 MHz with E3429A Flex Cable 25 MHz without E3429A Flex Cable
Environmental Characteristics	Operating Temperature	0 °C to 50 °C
	Relative Humidity	75% Maximum

Remove the 68040V adapter board from the PQFP adapter assembly

- Gently pry the 68040V adapter board from the PQFP adapter assembly using the pry tool (HP P/N 5081-7784) as shown.

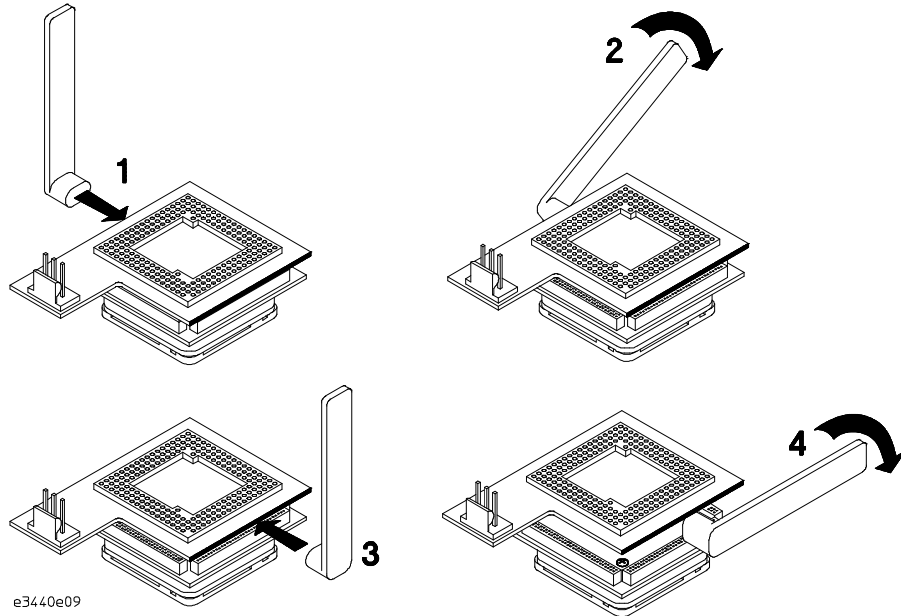

To probe a PQFP device

- 1 Follow the instructions in the *PQFP Adapter Installation Guide* to install the PQFP adapter assembly onto the package to be probed.

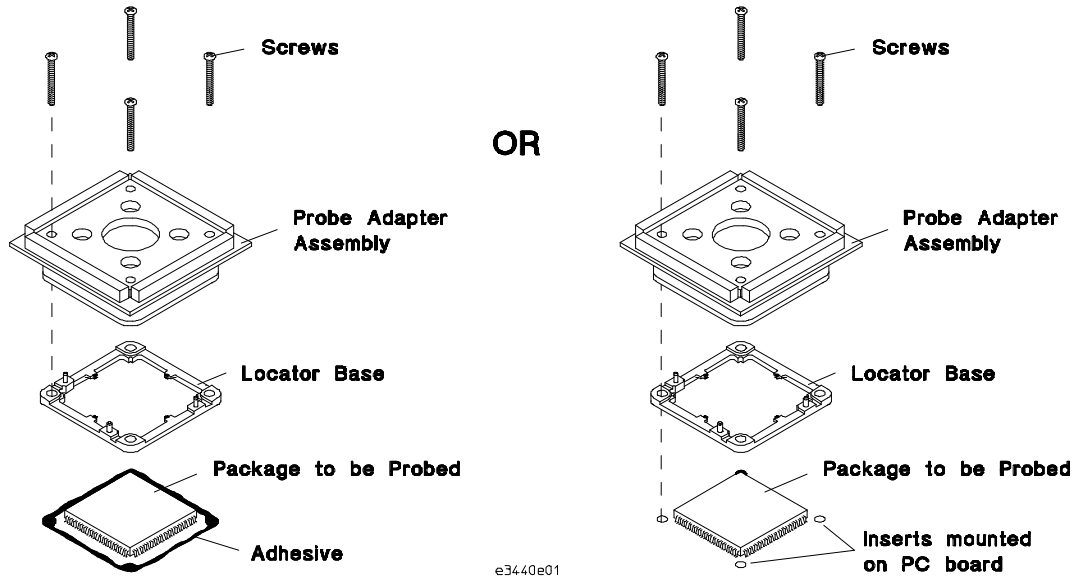

- 2 Align the yellow band on the 68040V adapter board with the yellow band on the PQFP probe adapter assembly. Attach the adapter by plugging it into the sockets on top.

CAUTION

To prevent pin damage and ensure a proper connection, make sure the pins of the adapter are aligned and seated correctly in the socket.

- 3 Attach your emulator probe to the HP E3440A 68040V Adapter as shown.

CAUTION

The weight of the emulator probe on the PQFP adapter assembly could break the glue bond between the locator base and the PC board. Support the weight of your emulator probe, or use the HP E3429A flexible cable if it does not interfere unacceptably with performance (see table 1).

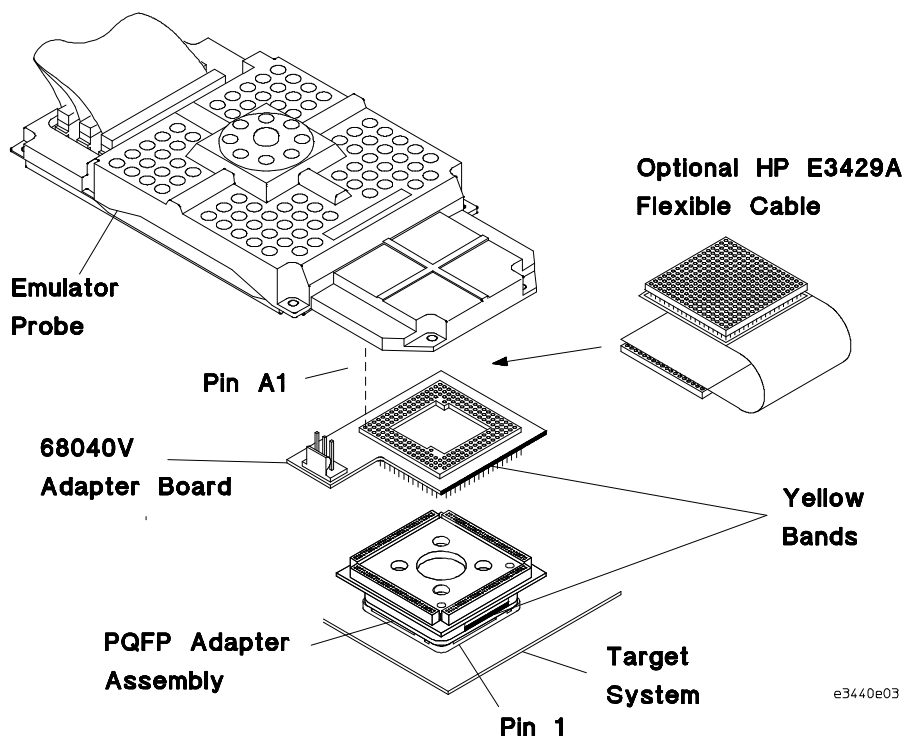

e3440e03

- 4 Connect the auxiliary power cable from the front of the HP 64700A/B Mainframe to the 68040V adapter board.

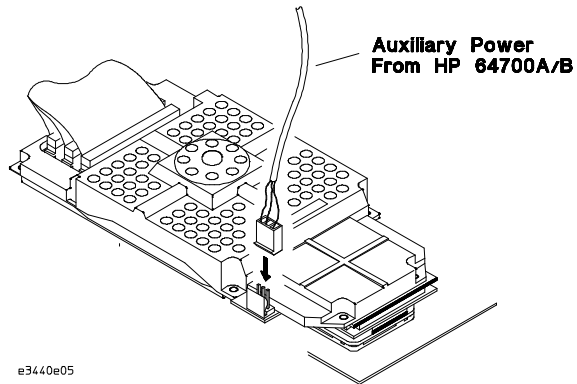

To probe a PGA device

- 1 Align the yellow band on the PGA adapter board with the PGA socket on your target system as shown in the following picture. Attach the PGA adapter board by plugging it into the PGA socket.

CAUTION

To prevent pin damage and ensure a proper connection, make sure the pins of the PGA adapter board are aligned and seated correctly in the PGA socket.

- 2 Align the yellow band on the 68040V adapter board with the yellow band on the PGA adapter board. Attach the 68040V adapter by plugging it into the sockets on the top of the PGA adapter board.

CAUTION

To prevent pin damage and ensure a proper connection, make sure the pins of the 68040V adapter board are aligned and seated correctly in the PGA adapter board.

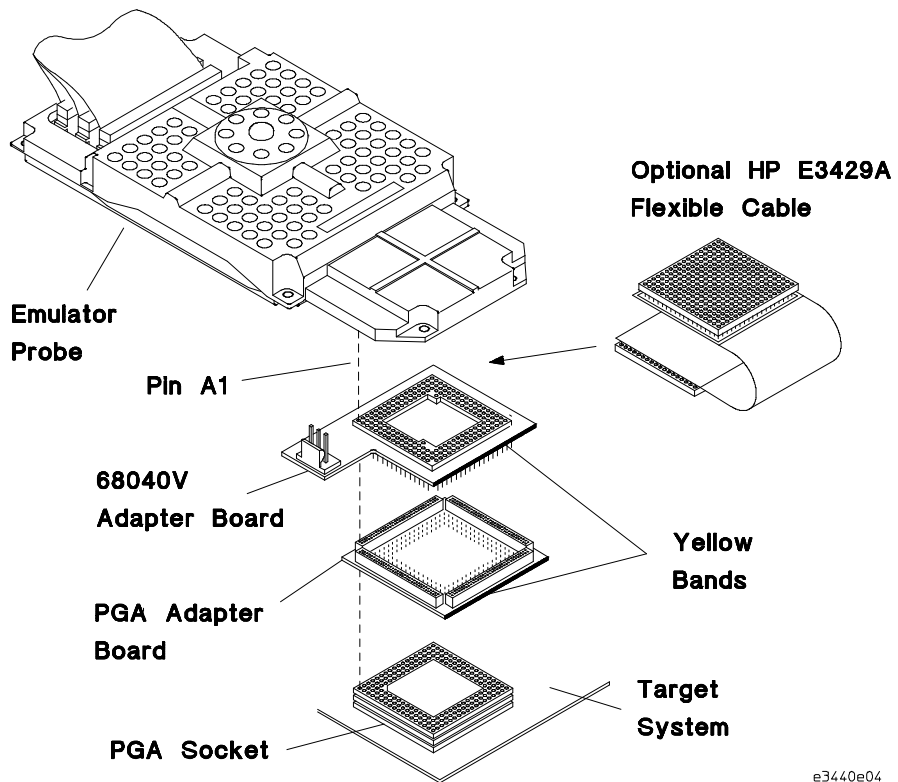

e3440e04

- 3 Align pin A1 of your emulator probe with pin A1 on the 68040V adapter board. Attach the emulator probe as shown.

CAUTION

The weight of the emulator probe on the adapter boards could damage the pins and cause poor connection. Support the weight of your emulator probe, or use the HP E3429A flexible cable if it does not interfere unacceptably with performance (see table 1).

- 4 Connect the auxiliary power cable from the front of the HP 64700A/B Mainframe to the E3440A adapter board.

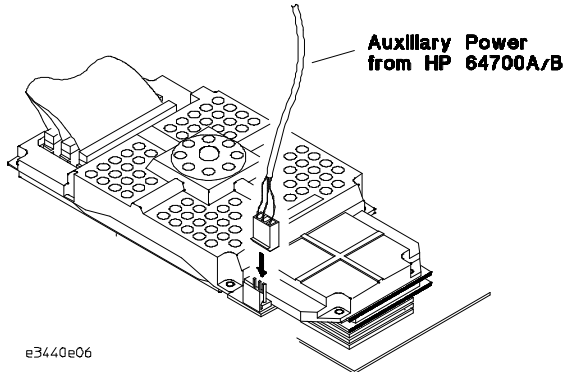

e3440e06

To do performance verification

- 1 Align the yellow band on the PGA adapter board with the PGA socket on the demo board, as shown. Attach it to the PGA socket.

CAUTION

To prevent pin damage and ensure a proper connection, make sure the pins of the PGA adapter board are aligned and seated correctly in the PGA socket.

- 2 Align the yellow band on the 68040V adapter board with the yellow band on the PGA adapter board. Attach it to the PGA adapter board.

CAUTION

To prevent pin damage and ensure a proper connection, make sure the pins of the 68040V adapter board are aligned and seated correctly in the PGA adapter board.

- 3 Attach your emulator probe to the 68040V adapter board as shown.

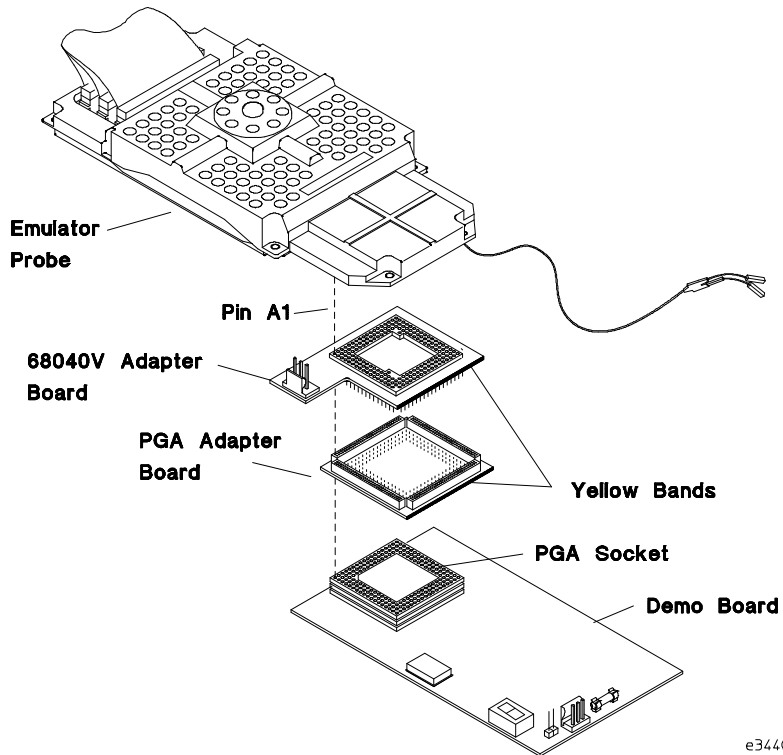

e3440e02

- 4 Connect the auxiliary power cable from the front of the HP 64700A/B Mainframe to the demo board and the flying lead from the probe to the demo board.

The power cable can be connected to either the 68040V adapter board or the demo board; however, it is best to plug it into the demo board.

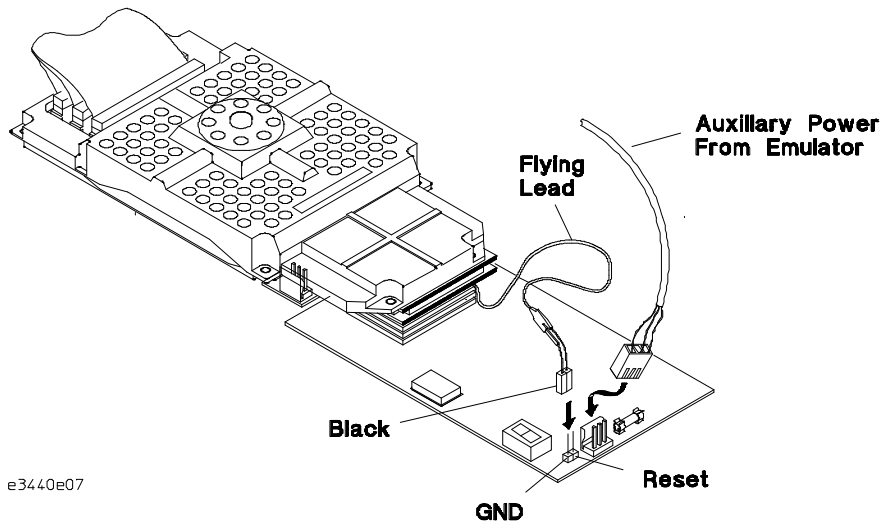

e3440e07

- 5 Perform verification by typing **pv** at the terminal interface prompt:

M> pv

When you use the **pv** command, the emulator is initialized as if power were cycled.

If **pv** reports failures, first check your hardware installation as documented in the *64783A Terminal Interface User's Guide*. If the failures persist, call your local HP Sales and Service office for assistance. A list of offices is provided in the *Support Services* guide.

For further information on the **pv** command, refer to the *64783A Terminal Interface User's Guide*.

HP E3440A 68040V Adapter
To do performance verification