

64000

**HP 64000
Logic Development
System**

**File Format
Reference Manual**



CERTIFICATION

Hewlett-Packard Company certifies that this product met its published specifications at the time of shipment from the factory. Hewlett-Packard further certifies that its calibration measurements are traceable to the United States National Bureau of Standards, to the extent allowed by the Bureau's calibration facility, and to the calibration facilities of other International Standards Organization members.

WARRANTY

This Hewlett-Packard system product is warranted against defects in materials and workmanship for a period of 90 days from date of installation. During the warranty period, HP will, at its option, either repair or replace products which prove to be defective.

Warranty service of this product will be performed at Buyer's facility at no charge within HP service travel areas. Outside HP service travel areas, warranty service will be performed at Buyer's facility only upon HP's prior agreement and Buyer shall pay HP's round trip travel expenses. In all other cases, products must be returned to a service facility designated by HP.

For products returned to HP for warranty service, Buyer shall prepay shipping charges to HP and HP shall pay shipping charges to return the product to Buyer. However, Buyer shall pay all shipping charges, duties, and taxes for products returned to HP from another country.

HP warrants that its software and firmware designated by HP for use with an instrument will execute its programming instructions when properly installed on that instrument. HP does not warrant that the operation of the instrument, or software, or firmware will be uninterrupted or error free.

LIMITATION OF WARRANTY

The foregoing warranty shall not apply to defects resulting from improper or inadequate maintenance by Buyer, Buyer-supplied software or interfacing, unauthorized modification or misuse, operation outside of the environment specifications for the product, or improper site preparation or maintenance.

NO OTHER WARRANTY IS EXPRESSED OR IMPLIED. HP SPECIFICALLY DISCLAIMS THE IMPLIED WARRANTIES OF MERCHANTABILITY AND FITNESS FOR A PARTICULAR PURPOSE.

EXCLUSIVE REMEDIES

THE REMEDIES PROVIDED HEREIN ARE BUYER'S SOLE AND EXCLUSIVE REMEDIES. HP SHALL NOT BE LIABLE FOR ANY DIRECT, INDIRECT, SPECIAL, INCIDENTAL, OR CONSEQUENTIAL DAMAGES, WHETHER BASED ON CONTRACT, TORT, OR ANY OTHER LEGAL THEORY.

ASSISTANCE

Product maintenance agreements and other customer assistance agreements are available for Hewlett-Packard products.

For any assistance, contact your nearest Hewlett-Packard Sales and Service Office.

FOLD HERE



NO POSTAGE
NECESSARY
IF MAILED
IN THE
UNITED STATES

BUSINESS REPLY CARD
FIRST CLASS PERMIT NO. 1303 COLORADO SPRINGS, COLORADO

POSTAGE WILL BE PAID BY ADDRESSEE

HEWLETT-PACKARD
Logic Product Support Dept.
Attn: Technical Publications Manager
Centennial Annex - D2
P.O. Box 617
Colorado Springs, Colorado 80901-0617

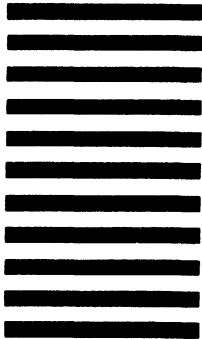

FOLD HERE

Your cooperation in completing and returning this form
will be greatly appreciated. Thank you.

READER COMMENT SHEET

Operating Manual
File Format Reference Manual
64980-90933, May 1985

Your comments are important to us. Please answer this questionnaire and return it to us. Circle the number that best describes your answer in questions 1 through 7. Thank you.

1. The information in this book is complete:

Doesn't cover enough (what more do you need?) 1 2 3 4 5 Covers everything

2. The information in this book is accurate:

Too many errors 1 2 3 4 5 Exactly right

3. The information in this book is easy to find:

I can't find things I need 1 2 3 4 5 I can find info quickly

4. The Index and Table of Contents are useful:

Helpful 1 2 3 4 5 Missing or inadequate

5. What about the "how-to" procedures and examples:

No help 1 2 3 4 5 Very helpful

Too many now 1 2 3 4 5 I'd like more

6. What about the writing style:

Confusing 1 2 3 4 5 Clear

7. What about organization of the book:

Poor order 1 2 3 4 5 Good order

8. What about the size of the book:

too big/small 1 2 3 4 5 Right size

Comments: _____

Particular pages with errors?

Name (optional): _____

Job title: _____

Company: _____

Address: _____

Note: If mailed outside U.S.A., place card in envelope. Use address shown on other side of this card.

FOLD HERE



NO POSTAGE
NECESSARY
IF MAILED
IN THE
UNITED STATES

BUSINESS REPLY CARD

FIRST CLASS PERMIT NO. 1303 COLORADO SPRINGS, COLORADO

POSTAGE WILL BE PAID BY ADDRESSEE

HEWLETT-PACKARD

Logic Product Support Dept.
Attn: Technical Publications Manager
Centennial Annex - D2
P.O. Box 617
Colorado Springs, Colorado 80901-0617

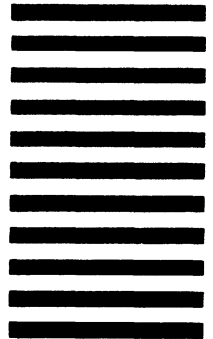

FOLD HERE

Your cooperation in completing and returning this form
will be greatly appreciated. Thank you.

READER COMMENT SHEET

Operating Manual
File Format Reference Manual
64980-90933, May 1985

Your comments are important to us. Please answer this questionnaire and return it to us. Circle the number that best describes your answer in questions 1 through 7. Thank you.

1. The information in this book is complete:

Doesn't cover enough
(what more do you need?)

1 2 3 4 5

Covers everything

2. The information in this book is accurate:

Too many errors

1 2 3 4 5

Exactly right

3. The information in this book is easy to find:

I can't find things I need

1 2 3 4 5

I can find info quickly

4. The Index and Table of Contents are useful:

Helpful

1 2 3 4 5

Missing or inadequate

5. What about the "how-to" procedures and examples:

No help

1 2 3 4 5

Very helpful

Too many now

1 2 3 4 5

I'd like more

6. What about the writing style:

Confusing

1 2 3 4 5

Clear

7. What about organization of the book:

Poor order

1 2 3 4 5

Good order

8. What about the size of the book:

too big/small

1 2 3 4 5

Right size

Comments: _____

Particular pages with errors?

Name (optional): _____

Job title: _____

Company: _____

Address: _____

Note: If mailed outside U.S.A., place card in envelope. Use address shown on other side of this card.



OPERATING MANUAL

FILE FORMAT

REFERENCE MANUAL

© COPYRIGHT HEWLETT-PACKARD COMPANY 1984, 1985
LOGIC SYSTEMS DIVISION
COLORADO SPRINGS, COLORADO, U.S.A.

ALL RIGHTS RESERVED

Manual Part No. 64980-90933

PRINTED: May 1985
UPDATED: July 1986

PRINTING HISTORY

Each new edition of this manual incorporates all material updated since the previous edition. Manual change sheets are issued between editions, allowing you to correct or insert information in the current edition.

The print date changes only when each new edition is published. Minor corrections or additions may be made as the manual is reprinted between editions. Vertical bars in a page margin indicate the location of reprint corrections.

First Edition	May 1984	64980-90933
Revised	July 1984	
Revised	May 1985	
Update U0785	July 1985	
Update U0386	March 1986	
Update U0786	July 1986	

SOFTWARE VERSION NUMBERS

Your HP 64000 software is identified with a version number in the form XX.YY. This version number is printed on a label attached to the software media or media envelope. This manual applies to the following:

Model 64100AF/AR Version 2.XX

Within the software version number, the digit to the left of the decimal point indicates the product feature set. This manual supports all software versions identified with this same digit.

The digits to the right of the decimal point indicate feature subsets. These feature subsets normally have no affect on the manual. However, if you subscribe to the "Software Material Subscription" (SMS), these subset items are covered in the "Software Response Bulletin" (SRB).

TABLE OF CONTENTS

Chapter 1: 64000 SYSTEM FILES AND THEIR ORGANIZATION

Introduction	1-1
File Types	1-1

Chapter 2: 64000 SYSTEM FILE GENERATION AND USAGE

System Software Generation	2-1
Editor	2-1
Assemblers	2-1
Pascal and "C" Compilers	2-1
Linkers	2-4
Symbol Definitions and Look-up	2-5
Emulators	2-6
Software Performance Analyzer	2-8
Timing Analyzer	2-9
State/Software Analyzer	2-9

Chapter 3: SYSTEM FILE FORMAT

System File (File Type 1)	3-1
---------------------------------	-----

Chapter 4: SOURCE AND LISTING FILE FORMATS

Source File (Type 2) and Listing File (Type 5)	4-1
Special Source or Listing Files	4-3

Chapter 5: RELOCATABLE FILE FORMAT

Relocatable File (File Type 3)	5-1
Name Record Format	5-3
Global Record Format	5-6
External Record Format	5-8
Double Record Format	5-9
T-Parameters	5-12
End Record Format	5-15

Chapter 6: ABSOLUTE FILE FORMAT

Absolute File (File Type 4)	6-1
Processor Information Record	6-2
Data Record	6-2

Chapter 7: EMULATION COMMAND FILE FORMAT

Emulation Command File (File Type 6)	7-1
Special Emul_Com Files	7-1

Chapter 8: LINKER COMMAND FILE FORMAT

Linker Command File (File Type 7)	8-1
---	-----

TABLE OF CONTENTS (Cont'd)

Chapter 9: TRACE FILE FORMAT

Trace File (File Type 8)	9-1
Product Descriptions	9-3
Software Performance Analyzer	9-3
Timing Analyzer	9-6
State/Software Analyzer	9-8
Optional Data Header Record Format - State Analyzer Trace File	9-13
Optional Overview Data Record Format - State Analyzer File	9-15
Optional Tracelist Data Record Format - State Analyzer Trace	9-16
Emulation With Internal Analysis	9-17
Trace Files	9-17
Special Trace Files	9-20
Measurement System	9-20

Chapter 10: PROM FILE FORMAT

Prom File (File Type 9)	10-1
-------------------------------	------

Chapter 11: DATA FILE FORMAT

Data File (File Type 10)	11-1
--------------------------------	------

Chapter 12: STATE ANALYZER DATABASE FILE FORMAT

State Analyzer Database File (File Type 11)	12-1
Header Record Format - State Analyzer Database File	12-2
32-Bit Program Range Record - State Analyzer Database File	12-4
16-Bit Symbol Record - State Analyzer Database File	12-5
32-Bit Symbol Record - State Analyzer Database File	12-6
16-Bit Line Number Symbol Record - State Analyzer Database File	12-7
32-Bit Line Number Symbol Record - State Analyzer Database File	12-7

Chapter 13: ASSEMBLER SYMBOL FILE FORMAT

Assembler Symbol File (File Type 12)	13-1
Assembler Symbol Record	13-2

Chapter 14: LINKER SYMBOL FILE FORMAT

Linker Symbol File (File Type 13)	14-1
80286 Protected Mode Linker	14-1
Processor Configuration Record	14-3
Global Symbol Record	14-5
Source Name Record	14-7
Memory Space Record	14-9
80286 Protected Mode Linker Record Types	14-12
Address Calculation Examples	14-16

TABLE OF CONTENTS (Cont'd)

Chapter 15: TEMPORARY FILE FORMAT

Temporary File (File Type 800H - 8FFH)	15-1
Regular Temp Files	15-1
Special Temp Files	15-1

Chapter 16: DEVICE FILE FORMAT

Device File (File Type 8000H - 8FFFH)	16-1
---	------

Chapter 17: THE COMPILER DATABASE FILE

Introduction	17-1
Index Information	17-1
Symbol Information	17-2
Subroutine Element	17-2
Level 0 Variable Records	17-2
Specific Records	17-3
Absolute File Record	17-3
Program File Record	17-4
Index Table Records	17-6
Subroutine Record	17-8
Variable Record	17-10
External Procedure Record	17-12
Type Records (Scalar)	17-13
Type Records (Subrange)	17-14
Type Record (Pointer)	17-15
Type Record (Set)	17-15
Type Record (Array)	17-16
Type Record (Record)	17-17
Type Record (Record Field Ptr) (Member Type)	17-18
Type Record (Selector Record) (Tag)	17-19
Type Record (Record Variant)	17-20
Type Record (Real Number)	17-21
Type Record (Character)	17-21
Type Record (Fundamental Integer)	17-22
Type Record (Bit Field)	17-22
Type Record (Function Type)	17-23
Type Record (File Type)	17-23

Chapter 18: SIMULATED I/O FILE FORMAT

Simulated I/O File (all non-specified types)	18-1
--	------

Appendix A: SUPPORTED PROCESSORS AND FORMAT NUMBER DESCRIPTIONS

Format Numbers and Skeleton Requirements	A-2
8085/80 and Z80	A-2
6800/01/02/03/05/09	A-3
650X	A-4
68000/08/10	A-4
8021/22/41/48	A-6
9900/40/85/89/99	A-7
99XXX	A-8
1802	A-9

TABLE OF CONTENTS (Cont'd)

Appendix A: SUPPORTED PROCESSORS AND FORMAT NUMBER DESCRIPTIONS (Cont'd)	
F8	A-10
Z8	A-11
8086/88/89	A-12
Z8001/2	A-13
8051	A-18
1750A	A-19
TMS320	A-19
8096	A-20
Appendix B: FILE NAME DESCRIPTION - FIXED LENGTH	B-1
Appendix C: LINKER TABLE DESCRIPTION - FIXED LENGTH	C-1
Appendix D: SYMBOL NAME DESCRIPTION - VARIABLE LENGTH	D-1
Appendix E: MEMORY SPACE RECORD - SOURCE NAME DESCRIPTION - FIXED LENGTH	E-1
INDEX	I-1

LIST OF ILLUSTRATIONS

2-1. File Generation and Usage During Microprocessor Software Generation Activities	2-2
2-2. File Generation and Usage During Emulation	2-7
2-3. File Generation and Usage for Software Performance Analyzer	2-8
2-4. File Generation and Usage for Timing Analyzer	2-9
2-5. File Generation and Usage for State/Software Analyzer	2-9
4-1. Source and Listing Files - Overall Structure	4-1
4-2. Source and Listing Files - Source Record Format	4-2
5-1. Relocatable Files - Overall Structure	5-2
5-2. Relocatable File - Name Record Format	5-4
5-3. Global Symbol Record - Overall Structure	5-7
5-4. External Symbol Record - Overall Structure	5-9
5-5. Double Record - Overall Structure	5-10
5-6. Ti=00 Format	5-12
5-7. Ti=01 Format	5-13
5-8. Ti=10 Format	5-13
5-9. Ti=11 Format	5-14
5-10. End Record - Overall Structure	5-15
6-1. 64000 Systemb Files - Overall Structure	6-1
6-2. Absolute File - Processor Information Record Format	6-2
6-3. Absolute File - Data Record Format	6-3

LIST OF ILLUSTRATIONS (Cont'd)

9-1. Trace Files - Overall Structure	9-1
9-2. Identification Record - Overall Structure	9-2
9-3. Trace File Format - Software Performance Analyzer	9-3
9-4. Identification Record - Software Performance Analyzer	9-4
9-5. Event Array Entry	9-5
9-6. Data Record Format	9-5
9-7. Time Event Boundary Definition	9-6
9-8. Time Event Boundary Example	9-6
9-9. Trace File Format - Timing Analyzer	9-7
9-10. Identification Record - Timing Analyzer	9-7
9-11. Trace File Format - State Analyzer	9-9
9-12. Identification Record - State Analyzer	9-11
9-13. Fixed Configuration Dump Record Format	9-11
9-14. Last Configuration Dump Record Format	9-12
9-15. Symbol Table Record Format	9-12
9-16. Expression Record Format	9-12
9-17. Optional Data Header Record Format	9-14
9-18. Optional Overview Data Record Format	9-15
9-19. Optional Tracelist Data Record Format	9-17
9-20. Trace File Format - Internal Analysis	9-18
9-21. Identification Record - Internal Analysis	9-18
9-22. Display Spec Record Format	9-19
9-23. Trace Status Record Format	9-19
9-24. Data Record Format - Emulation	9-20
11-1. Data Files - Overall Structure	11-1
11-2. Data Record Format	11-2
12-1. Database File Format - State Analyzer	12-1
12-2. Header Record Format	12-3
12-3. 32-Bit Program Range Record Format	12-4
12-4. 16-Bit Symbol Record Format	12-5
12-5. 32-Bit Symbol Record Format	12-6
12-6. 16-Bit Line Number Symbol Record Format	12-7
12-7. 32-Bit Line Number Symbol Record Format	12-7
13-1. Assembler Symbol File - Overall Structure	13-1
13-2. Assembler Symbol File - Assembler Symbol Record Format	13-3
14-1. Linker Symbol File - Overall Structure	14-2
14-2. Linker Symbol File - Processor Configuration Record Format	14-4
14-3. Linker Symbol File - Global Symbol Record Format	14-6
14-4. Linker Symbol File - Source Name Record Format	14-8
14-5. Linker Symbol File - Memory Space Record Format	14-11
14-6. Record Type 22 - 80286 Protected Mode Linker	14-13
14-7. Record Type 222 - 80286 Protected Mode Linker	14-14
14-8. Record Type 33 - 80286 Protected Mode Linker	14-15

LIST OF ILLUSTRATIONS (Cont'd)

17-1. File Organization	17-1
17-2. Absolute File Record	17-3
17-3. Program File Record	17-5
17-4. Index Table Record	17-7
17-5. Subroutine Record	17-9
17-6. Variable Record	17-11
17-7. External Procedure Record	17-12
17-8. Type Record (Scalar)	17-13
17-9. Type Record (Subrange)	17-14
17-10. Type Record (Pointer)	17-15
17-11. Type Record (Set)	17-15
17-12. Type Record (Array)	17-16
17-13. Type Record (Record)	17-17
17-14. Type Record (Field Names and Member Names)	17-18
17-15. Type Record (Selector Record) (Tag)	17-19
17-16. Type Record (Record Variant)	17-20
17-17. Type Record (Real Number)	17-21
17-18. Type Record (Character)	17-21
17-19. Type Record (Fundamental Integer)	17-22
17-20. Type Record (Bit Field)	17-22
17-21. Type Record (Function Type)	17-23
17-22. Type Record (File Type)	17-23
18-1. Simulated I/O Files - Overall Structure	18-1
18-2. Data Record Format	18-2
B-1. Source Name Description Block	B-1
B-2. Source Name Description Example	B-2
C-1. Linker Table Description Block	C-1
C-2. Linker Table Description Example	C-2
D-1. Symbol Name Description Block	D-1
D-2. Symbol Name Description Example	D-2
E-1. Memory Space Record - Source Name Description Block	E-1
E-2. Memory Space Record - Source Name Description Example	E-2

LIST OF TABLES

1-1. 64000 System File Type Numbers and Associated Names	1-2
A-1. Supported Microprocessors	A-1
A-2. Format Number Descriptions for 8080/85,Z80	A-2
A-3. Format Number Descriptions for 6800/01/02/03/05/09	A-3
A-4. Format Number Descriptions for 650X	A-4
A-5. Format Number Descriptions for 68000/08/10	A-5
A-6. Format Number Descriptions for 8021/22/41/48	A-6
A-7. Format Number Descriptions for 9900/40/85/89/99	A-7
A-8. Format Number Descriptions for 9980	A-7
A-9. Format Number Descriptions for 99XXX	A-8
A-10. Format Number Descriptions for 1802	A-9
A-11. Format Number Descriptions for F8	A-10
A-12. Format Number Descriptions for Z8	A-11
A-13. Format Number Descriptions for 8088/86/88/89	A-12
A-14. Format Number Descriptions for Z8001/2	A-13
A-15. Format Number Descriptions for 8051	A-18
A-16. Format Number Descriptions for 1750A	A-19
A-17. Format Number Descriptions for TMS320	A-20
A-18. Format Number Descriptions for 8096	A-21

NOTES

Chapter 1

64000 SYSTEM FILES AND THEIR ORGANIZATION

INTRODUCTION

This manual provides descriptions of the Hewlett-Packard 64000 System file structures. However, it is not intended to provide methods for manipulating these files. For that information, please refer to the applicable HP documentation on Simulated I/O, terminal mode and HP protocol, copy command, HOST Pascal, and HPIB transfers.

The first two chapters of this manual provide an overview of the 64000 System file types, their generation, and their usage. Succeeding chapters more fully describe the contents of each file type by showing the overall file structure and by presenting the specific details of each record type in the file.

FILE TYPES

A collection of information is stored on a 64000 system disc as a file. Each 64000 file has four associated attributes which give it a unique identification: the name, the userid, the disc logical unit (LU) number, and the file type. For more information on the name, userid, and LU number, refer to the System Software Reference Manual.

There are 15 designated file type names currently in use by the 64000 system. These are the names which appear in the column labeled "TYPE" in a directory listing. Each file type name has a file type number associated with it. The file type number is stored in one 16-bit word. The 64000 System file type names and numbers are shown in Table 1-1.

**File Format
Reference Manual**

Table 1-1. 64000 System File Type Numbers and Associated Names

File Type #	File Type Name	Abbreviation
1	system	
2	source	
3	relocatable	reloc
4	absolute	
5	listing	
6	emulation command	emul_com
7	linker command	link_com
8	trace	
9	prom	
10	data	
11	assembler database	asmb_db
12	assembler symbol	asmb_sym
13	linker symbol	link_sym
0800H-08FFH	temporary	temp
8000H-8FFFH	device	
all others	simulated I/O	sim_I/O

Chapter 2

64000 SYSTEM FILE GENERATION AND USAGE

SYSTEM SOFTWARE GENERATION

The relationships between the files generated and used by the 64000 System in the process of creating software for execution on target microprocessors are shown in Figure 2-1.

EDITOR

The 64000 System Editor allows the user to create new files of type :source or type :listing or to edit existing source or listing files. In the process of generating micro-processor software, files of type :source must be used. The next step is to assemble or compile the source file.

ASSEMBLERS

Assemblers in the 64000 System accept source files as input and typically create two files, each having the same name, userid, and disc LU number as the source file which was assembled. The first, a file of type :reloc, contains the relocatable code, along with global and external symbol information. The second, of type :asmb__sym, is an assembler symbol file which contains all of the symbols defined in the source file along with their relocatable addresses.

Additionally, a file of type :listing, showing the code generated by each assembly language instruction (in hexadecimal) and symbol usage, will be generated by the 64000 System Assembler when the user requests it. For more detailed information on file generation and usage, refer to the 64000 System Assembler/Linker Reference Manual.

PASCAL AND "C" COMPILERS

The 64000 System Pascal and "C" Compilers accept source files as input and typically create two files, each having the same name, userid, and disc LU number as the source file which was compiled. The first, a file of type :reloc, contains the relocatable code, along with global and external symbol information. The second, of type :asmb__sym, is an assembler symbol file which contains all of the local compiler generated symbols, along with their relocatable addresses.

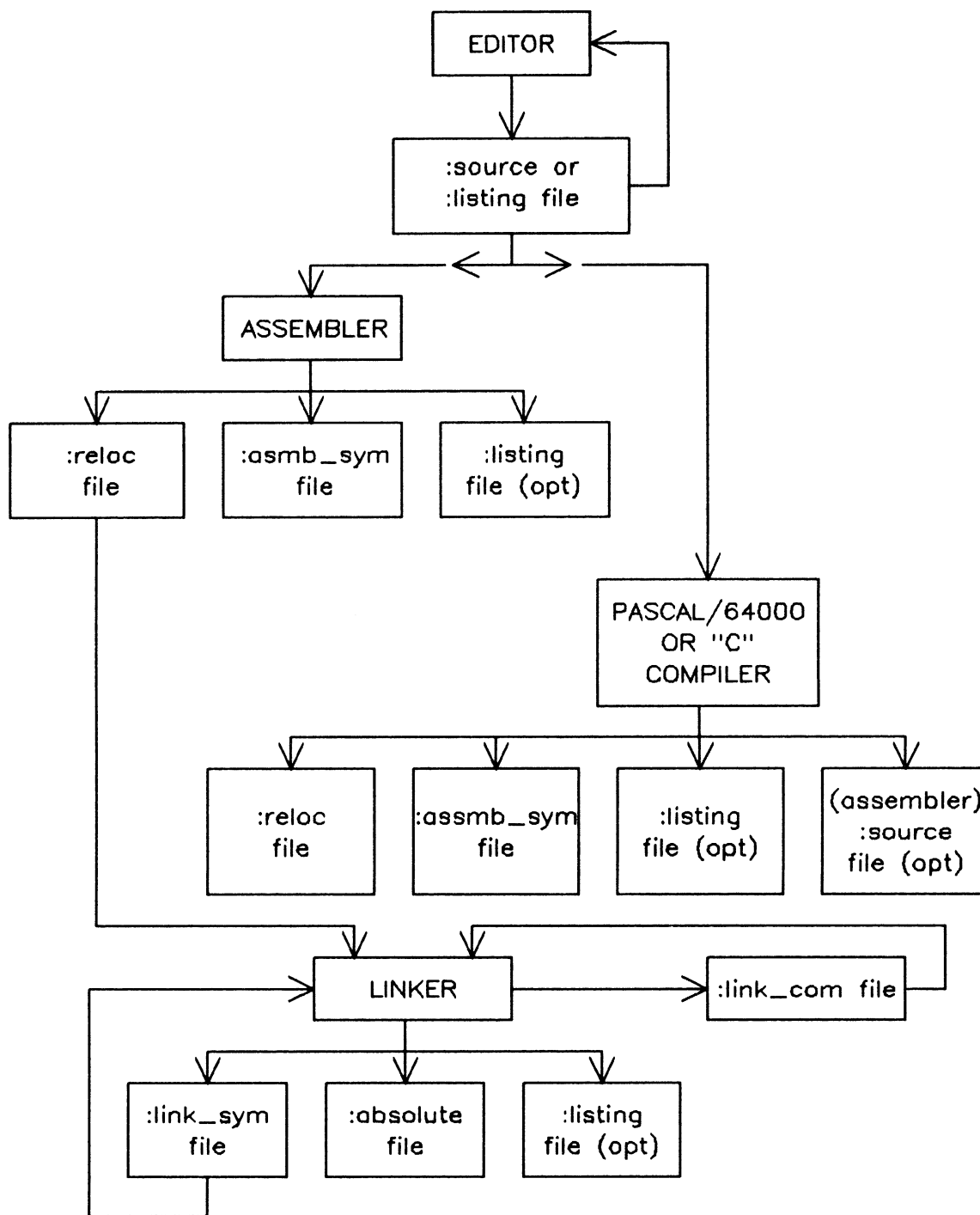

**Figure 2-1. File Generation and Usage During
Microprocessor Software Generation Activities**

The user may specify the generation of files of type :listing or :source by the 64000 System Pascal and "C" Compilers. The listing file gives assembly language code generated and symbol usage, while the source file consists of assembly language code which can be assembled to generate separate relocatable and assembler symbol files.

For more information on file generation and usage, refer to the Pascal/64000 Compiler Reference Manual or the C/64000 Compiler Reference Manual.

PASCAL COMPILER GENERATED SYMBOLS. Assembler symbol files which are generated by the Pascal/64000 Compilers contain any user-defined labels within procedures. The compiler generates these labels in the form LABEL__NN, where NN is the number of the label; they are always local. In addition, the asmb__sym file contains several types of symbols which are defined by the compiler itself. Line number labels of the form #dddd, where dddd is a fixed-length, four-digit number which is right-justified and blank-filled, are specified for each line of source code. Their addresses correspond to those of the first executable line of code which is generated as a result of the source statement. These line numbers are then referenced by measurement system module software upon user request.

Also defined is a Procedure Entry Label which has the name of the procedure itself. It will be a global symbol if the procedure is global and its address corresponds to that of the first executable line of assembly language code generated for the procedure. (The main program is always global.) Other symbols generated by the Pascal/64000 Compilers are of the form Xfunc, where X is a character and func is the user-defined procedure name, truncated (if necessary) so that the total label has a maximum length of 15 characters.

The first of these symbols, called an End Label, consists of the letter "E" concatenated with the procedure name; it is generated for each procedure. Its address is the same as that of the last byte of assembly language code generated for the procedure. This includes any data associated with the procedure which is in the PROG area. The End Label will be global if the procedure is global.

The return instruction from a procedure is labeled with the letter "R" concatenated with the procedure name and called a Return Label. Its address corresponds to that of the assembly language return instruction. The Return Label will be global if the procedure is global.

If a procedure has an associated data area in memory, the beginning of that area will be labeled with the letter "D" concatenated with the procedure name. This is called a Data Label, and it is always a local symbol.

Other labels may be used by specific processor Pascal/64000 compilers. For more information, refer to the appropriate Pascal/64000 Compiler Supplement Manual.

"C" COMPILER GENERATED SYMBOLS. Assembler symbol files which are generated by the 64000 System "C" Compilers contain any user-defined labels within functions. These labels are always local. In addition, the `asmb__sym` file contains several types of symbols which are defined by the compiler itself. Line number labels of the form `#dddd`, where `dddd` is a fixed-length, four-digit number which is right-justified and blank-filled, are specified for each line of source code. Their addresses correspond to those of the first executable line of code which is generated as a result of the source statement. These line numbers are then referenced by measurement system module software upon user request.

The first of these symbols, called a Function Entry Label, has the name of the function itself. It will be a global symbol if the function is global and its address corresponds to that of the first executable line of assembly language code generated for the function. Other symbols generated by the 64000 System "C" Compilers are of the form `Xfunc`, where `X` is a character and `func` is the user-defined function name, truncated, if necessary, so that the total label has a maximum length of 15 characters.

The first of these symbols, called an End Label, consists of the letter "E" concatenated with the function name; it is generated for each function. Its address is the same as that of the last byte of assembly language code generated for the function. This includes any data associated with the function which is in the PROG area. The End Label will be global if the function is global.

The return instruction from a function is labeled with the letter "R" concatenated with the function name and called a Return Label. Its address corresponds to that of the assembly language return instruction. The Return Label will be global if the function is global.

If a function has an associated data area in memory, the beginning of that area will be labeled with the letter "D" concatenated with the function name. This is called a Data Label, and it is always a local symbol.

Other labels may be used by specific processor "C" compilers. For more information, refer to the appropriate "C" Compiler Supplement Manual.

LINKERS

The final step in the microprocessor software generation process on the 64000 System is the creation of the absolute file. This is accomplished by a 64000 System Linker which accepts relocatable and/or linker symbol files as inputs and typically produces three files which have the same name, userid, and LU number as specified in the answer to the question "Absolute file?" which is asked during linker configuration.

The first, a file of type `:absolute`, contains the absolute data to be used to program a PROM or is loaded into the microprocessor memory space by the emulator along with information indicating where the code is to be loaded. If only `:link__sym` files have been linked, the absolute file consists solely of a header record with no data records specified.

A linker symbol file, type `:link__sym`, is the second file type generated by the linker. It contains a list of the sources from which the relocatable files that were linked were derived and the starting addresses of each of the segments of code (PROG, DATA, COMN, and ABSOLUTE) that were produced for that file. Additionally, it contains a list of all global symbols from those sources and their addresses. (Global symbols are those symbols which are defined in the source file as being global.) If any `:link__sym` files have been linked, the global symbols from each of those files, along with their addresses, are included in the new linker symbol file which is created. This new linker symbol file DOES NOT contain the list of the original source files from which those global symbols were gathered.

A file of type `:link__com` is the third file type generated by the 64000 System Linker. This file stores the answers given to the questions that were asked during linker configuration. configured. Future links may be accomplished simply by calling up the link command file and having the linker read the configuration information.

A file of type `:listing`, showing the load map for the absolute file and global symbol usage, will be generated by the 64000 System Linker when the user requests it.

For more detailed information, refer to the 64000 System Assembler/Linker Reference Manual, the Pascal/64000 Compiler Reference Manual, or the C/64000 Compiler Reference Manual.

SYMBOL DEFINITIONS AND LOOK-UP

An important part of the 64000 System microprocessor software generation process is the creation of symbols which may be used to reference addresses from the 64000 Measurement System modules. Two types of symbols are identified in the 64000 System: local and global; they may be defined by the user in the source program or supplied by the 64000 System Compilers. (Refer to "PASCAL AND "C" COMPILERS" in this chapter.)

LOCAL SYMBOLS. Local symbols are those symbols which are defined in, and only referenced by, a single source program. They are not declared to be global by the user. Local symbol names and their relocatable addresses are stored in the `:asmb__sym` file. It is important to note that the address stored with the local symbol name in the `asmb__sym` file is not necessarily the same address that will be associated with the symbol in the absolute file.

GLOBAL SYMBOLS. Global symbols are those symbols which are defined in one source program and may be referenced by it and any other source program. They are declared by the user to be global. Global symbol names and their associated addresses in the absolute file are stored in the `:link__sym` file.

SYMBOL LOOK-UP. When the user specifies a symbol name instead of an actual address in a Measurement System module such as the Software Performance Analyzer or the Emulation System, the address value of the symbol must be looked up or calculated. This is done using the appropriate `:link__sym` and `:asmb__sym` files. Each Measurement Module has a particular absolute file name associated with it at any time. In the 64000 System Emulators, for example, that is the name of the last file to be loaded via a "load__memory" or "continue" command. Similarly, the `link__sym` file to be searched for symbol information is the one with the same name as the absolute file currently associated with the Measurement System module. For more information, refer to the appropriate Measurement System module reference manual.

When a symbol is specified in a Measurement System module as `SYMBOL__NAME`, the appropriate `:link__sym` file will be searched to determine whether it is a global symbol. If it is found, the address will be obtained and the symbol resolution is complete. If it is not found, then a message indicating that it is not a global symbol will be displayed, and the user has the opportunity to define the source file in which the local symbol was specified. This definition takes the form `SYMBOL__NAME:SOURCE__NAME`.

When a symbol is specified in a Measurement System module as `SYMBOL__NAME:SOURCE__NAME`, the appropriate `:link__sym` file is searched to find the `SOURCE__NAME`. If the source name is not found, a resulting message is displayed for the user. If the source name is found, information on relocating symbols in the areas that were used by the source (PROG, DATA, COMN, etc.) is obtained and the `:asmb__sym` file of the same name is then searched to find `SYMBOL__NAME`. If the symbol name is not found, a resulting message is displayed for the user.

When the symbol name is found, its relocatable address is obtained and combined with the pertinent information from the `:link__sym` file to complete the symbol address resolution. It is important to note that the 64000 System must have access to all of the appropriate files in order to do the symbol address resolution if symbolic reference is desired.

EMULATORS

Files generated and used by the 64000 System Emulators are outlined in Figure 2-2. These emulators can configure from or generate configuration information files of type `:emul__com`. Emulation command (`emul__com`) files are given the name provided to the emulation configuration question "Command file name?"

If no command file name is given, a file of type `:emul__com` named `EcnfgXY:HP` (where X is the System Bus Address of the station in use and Y is the card slot number containing the Emulation Control Card of the Emulator in use) is automatically generated or rewritten by the Emulation System. This file may then be used to configure the emulator automatically in the future, either by the system if the emulator is exited and re-entered with a "continue", or by the user if so specified.

The 64000 System Emulators can reload into the emulator or store away information gathered when a trace command was executed in files of type `:trace`.

Upon leaving an emulation session, the 64000 Emulation System creates or rewrites a file of type `:trace` named `EcnfgXY:HP` (where X is the System Bus Address of the station in use and Y is the card slot number containing the Emulation Control Card of the Emulator in use). This file may then be used to access that trace information automatically in the future, either by the system if the emulator is exited and re-entered with a "continue," or by the user if so specified. Similarly, microprocessor memory may be loaded from or stored to files of type `:absolute`.

Symbol address information from the files of type `:link__sym` and `:asmb__sym` associated with the last absolute file which has been loaded by the Emulator can be accessed by the 64000 System Emulators. For more information on how this works, refer to "SYMBOL DEFINITIONS AND LOOK-UP" in this chapter.

Finally, files of type `:listing` will be generated by the 64000 System Emulators when the user issues a "list" or "listfile" command. For more information, refer to the Emulator Reference Manual for the specific microprocessor emulator being used.

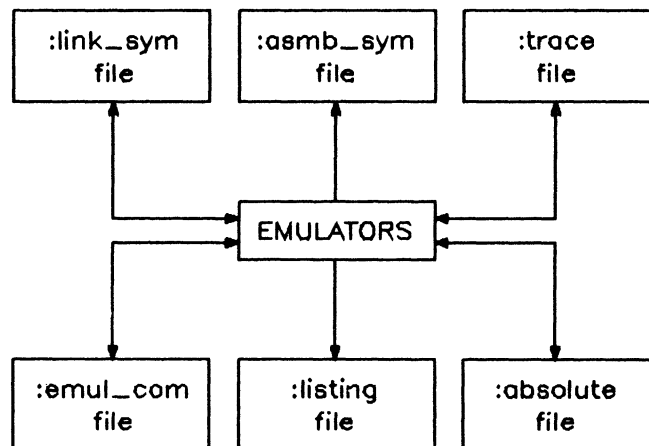

Figure 2-2. File Generation and Usage During Emulation

SOFTWARE PERFORMANCE ANALYZER

The files generated and used by the 64000 System Software Performance Analyzer are outlined in Figure 2-3.

The Software Performance Analyzer (Model 64310A) works in conjunction with a 64000 System Emulator. It can configure from or generate configuration information files of type :trace.

When a user specifies the name of the absolute file he is working with, symbol address information from the files of type :link__sym and :asmb__sym associated with this absolute file is available to the Software Performance Analyzer. For more information on how this works, refer to "SYMBOL DEFINITIONS AND LOOK-UP" in this chapter.

In order for the 64000 System Software Performance Analyzer to automatically reference a Pascal or "C" procedure, the Return Labels and End Labels must be available to it (refer to PASCAL AND "C" COMPILERS" on Page 2-1). Additionally, to specify a module as a range of compiler source line numbers, the assembler symbol file for the source must contain line number labels.

The file spa__table:HP of type :data provides the algorithms for use in the statistical analysis done by the Software Performance Analyzer.

Finally, files of type :listing will be generated by the 64000 System Software Performance Analyzer when the user issues a "copy" command. For more information, refer to the Software Performance Analyzer Reference Manual.

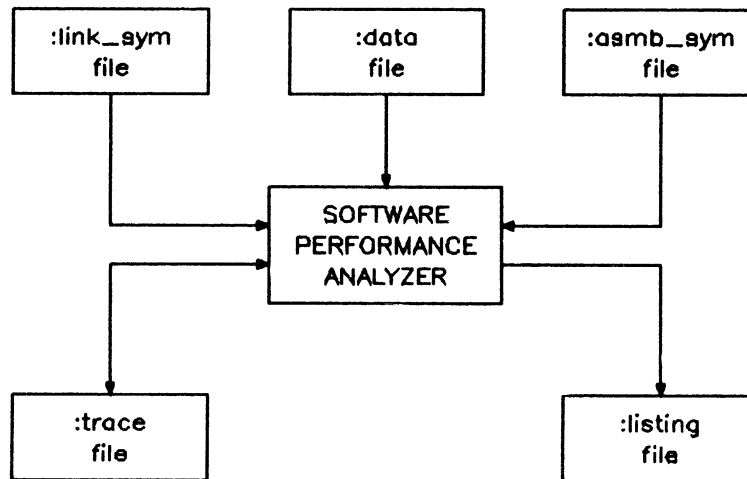

Figure 2-3. File Generation and Usage for Software Performance Analyzer

TIMING ANALYZER

The files generated and used by the 64000 System Timing Analyzer are outlined in Figure 2-4. The Timing Analyzer (Model 64600A) can configure from or generate configuration information files of type :trace. Additionally, files of type :listing will be generated by the 64000 System Timing Analyzer when the user issues a "copy" command. For more information, refer to the Timing Analyzer Reference Manual.

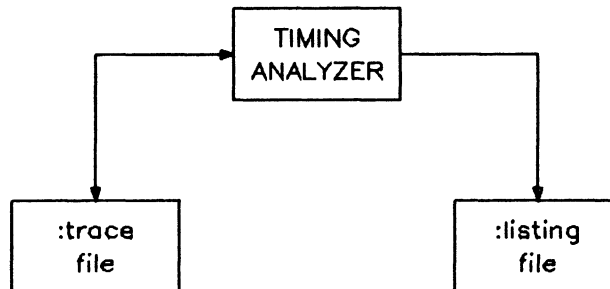

Figure 2-4. File Generation and Usage for Timing Analyzer

STATE/SOFTWARE ANALYZER

The files generated and used by the 64000 System State/Software Analyzer are outlined in Figure 2-5. The State/Software Analyzer (Model 64620A) can configure from or generate configuration information files of type :trace. This trace file exists in one of two forms: the first contains only analyzer configuration information and the second contains trace data as well as the configuration information.

When using the symbol information from the :asmb__sym and link__sym files, the state analyzer creates an :asmb__db file. This file allows the analyzer to quickly access the symbol table information. Additionally, files of type :listing will be generated by the 64000 System State/Software Analyzer when the user issues a "copy" command. For more information, refer to the State/Software Analyzer Reference Manual.

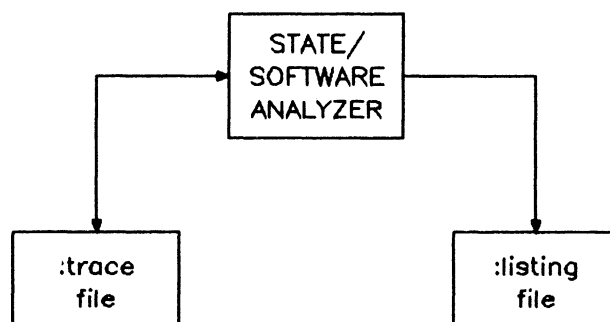

Figure 2-5. File Generation and Usage for State/Software Analyzer

**File Format
Reference Manual**

Chapter 3

SYSTEM FILE FORMAT

SYSTEM FILE (FILE TYPE 1)

System files contain software to run the 64000 system. System file names begin with a lower-case letter, making normal access to these files by a system user impossible. All system files are stored under userid :HP. System files are not stored in a record format but are images of memory. The only access of system files permitted is the ability to display, copy or remove modules of system files from a floppy disc equipped station via the system generator (sys__gen) program.

**File Format
Reference Manual**

Chapter 4

SOURCE AND LISTING FILE FORMATS

SOURCE FILE (TYPE 2) and LISTING FILE (TYPE 5)

A source file is a user-generated file consisting of a series of ASCII records. Each ASCII source record is of variable length and may contain up to 128 sixteen-bit words. Each 16-bit word is made up of two 8-bit ASCII bytes.

NOTE

The 64000 system editor program will only read or write 240 characters (120 words). In editing a file with lines longer than 240 characters, those characters in words 120 through 127 will be truncated.

A listing file is generated whenever the user issues a "listfile <FILE>" or "list <something> to <FILE>" command. Its format is exactly the same as that of a source file. For a pictorial representation of the source and listing file formats, see Figures 4-1 and 4-2.

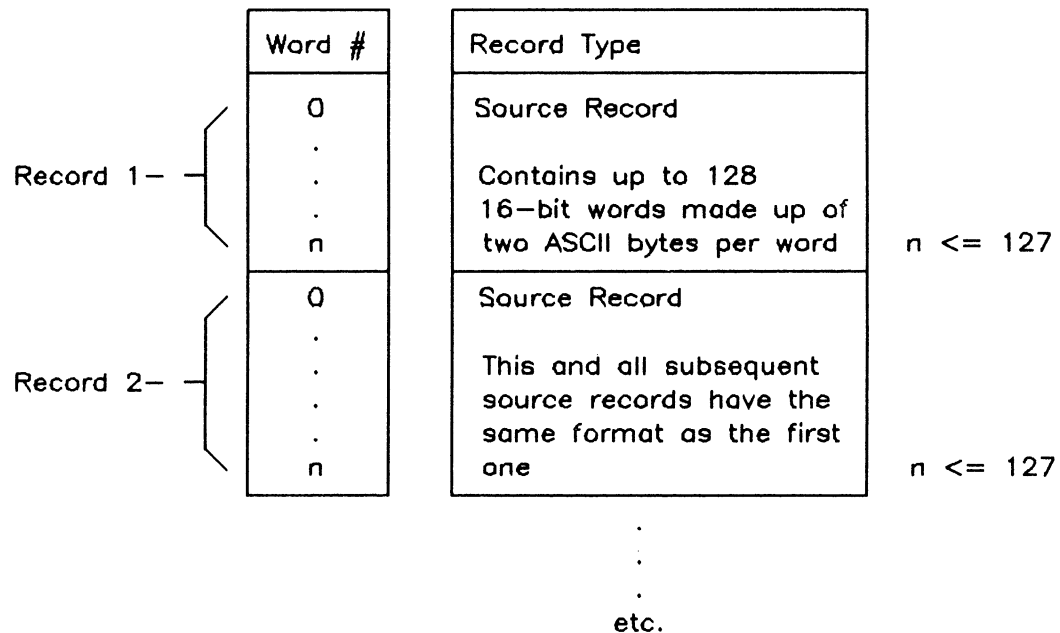

Figure 4-1. Source and Listing Files - Overall Structure

**File Format
Reference Manual**

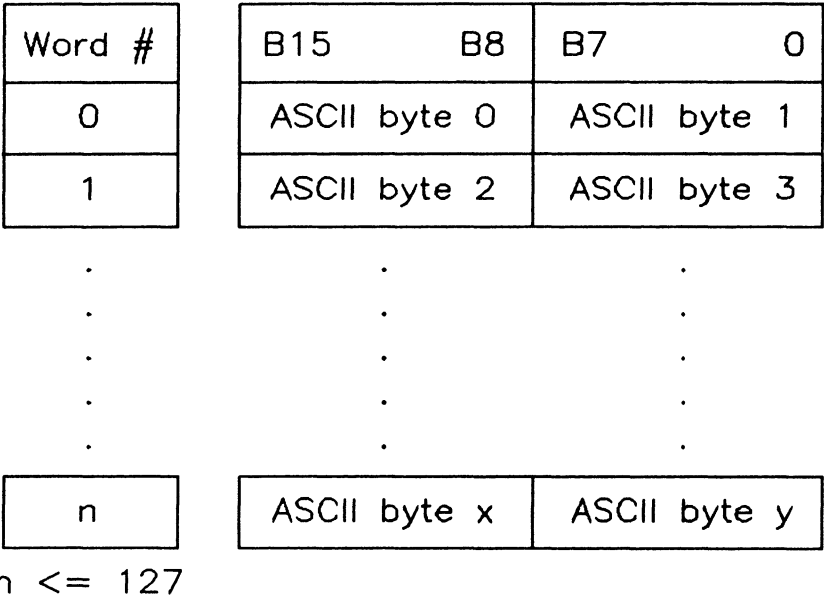

Figure 4-2 Source and Listing Files - Source Record Format

WORD n - If the last byte of word n is not used, it should be padded with an ASCII blank (20H) such that all records are word-aligned.

SPECIAL SOURCE OR LISTING FILES

Ndestfile:HP

When ending an edit session the Editor creates an intermediate file named Ndestifile:HP, where N is the System Bus address of the station in use. This file is of type :souce or :listing, depending upon the type of file being edited.

CAUTION

The occurrence of a power failure or of SHIFT-RESET being pressed before the edit session is completely ended will result in that intermediate file remaining on the disc. Depending upon when the power failure or SHIFT RESET occurs, it is possible that the original file and the current file which is ending will BOTH be lost. There is no way to recover either file.

To eliminate an Ndestfile:HP, edit a file which already exists from the station at System Bus Address N and end the edit session.

**File Format
Reference Manual**

Chapter 5

RELOCATABLE FILE FORMAT

RELOCATABLE FILE (FILE TYPE 3)

Relocatable files are produced by the HP 64000 system assemblers and compilers, and are the input used by the HP 64000 system linker. As such, they must provide to the linker all the information it needs to produce absolute code. For each relocatable file the first record must be a Name record. This is followed by a variable number of Global Symbol Records, External Symbol Records, and Double Records in any order. The last record must be an End record.

Relocatable files are also the input and output of the library command. The command library A to B appends the relocatable file A to the relocatable file B. This creates a file which consists of one or more relocatable file overall structures. All future references to a relocatable file in this document are referring to a file created by assembling or compiling a source file.

In the discussion of the relocatable file format it is important to keep in mind the relationship between relocatable file names and source file names. The name of the source file that is assembled or compiled is permanently saved in the Name Record of the Relocatable File. Since files may be renamed, it is possible to have a relocatable file with a name that is different from the source file name which was saved in the Relocatable Name Record. In the case of a library of relocatables there is only one relocatable file name, but multiple source file names are associated with the library.

For this document, the term Source Name is used to refer to the source file which was assembled or compiled to create an individual relocatable file or one of the individual relocatable files in a library.

For a pictorial representation of the relocatable file format, see Figures 5-1 through 5-10.

**File Format
Reference Manual**

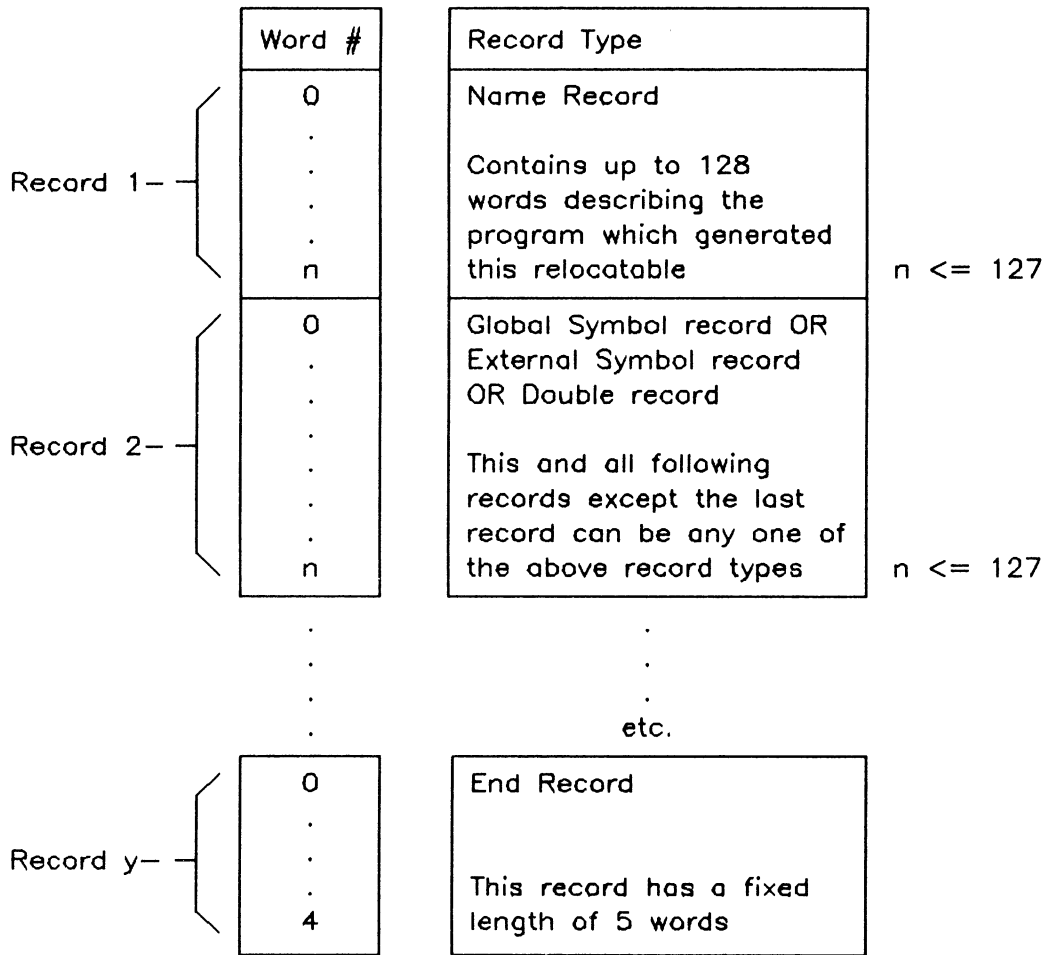

Figure 5-1. Relocatable Files - Overall Structure

A library of relocatable files consists of one or more relocatable file blocks concatenated together. (Name/record for next file immediately follows End record of previous file.)

NAME RECORD FORMAT

WORD 0 - A Record ID of 1 is specified to indicate that this is a Name Record. The Record ID is used internally to the relocatable file and should not be confused with the 64000 System file type number, which is 3.

WORD 1 through WORD 8 make up the Source File Name Description Block. This block provides the source file name which generated the relocatable file. For a complete description of this block see Appendix B.

WORD 9-10 - The PROG segment length is the number of bytes or words (processor dependent) of code which are produced by the assembler or compiler as the PROG relocatable code.

WORD 11-12 - The DATA segment length is the number of bytes or words (processor dependent) of code which are produced by the assembler or compiler as the DATA relocatable code.

WORD 13-14 - The COMN segment length is the number of bytes or words (processor dependent) of code which are produced by the assembler or compiler as the COMN relocatable code.

WORD 15 - A word containing the number of external symbols defined in this file. The maximum number of external symbols in a relocatable file is 512.

WORD 16-23 - This group of words is used to define the name of the linker table used to generate the corresponding absolute file. For a complete description of this block see Appendix C.

WORD 24 - contains the Date on which the relocatable was created. Encoded as a binary number describing the number of days since January 1, 1976. January 1, 1976 = 0.

WORD 25 - contains the time at which the relocatable was created. Encoded as a binary number describing the number of minutes since midnight. Midnight = 0.

WORD 26 through WORD 36 - contains 22 characters of comment (unused characters must be set to blank (20H). This field is given a value using the pseudo opcode NAME in the assembler and otherwise is unused (all bytes set to 20H). This field is output in the comments field of the linker listing file.

WORD 37 through n-1 contain up to 22 (all are optional) Absolute Code Segment Blocks. These blocks define the memory space used by the ORG'd code segments. These words are not used unless there are absolute code segments to be described.

**File Format
Reference Manual**

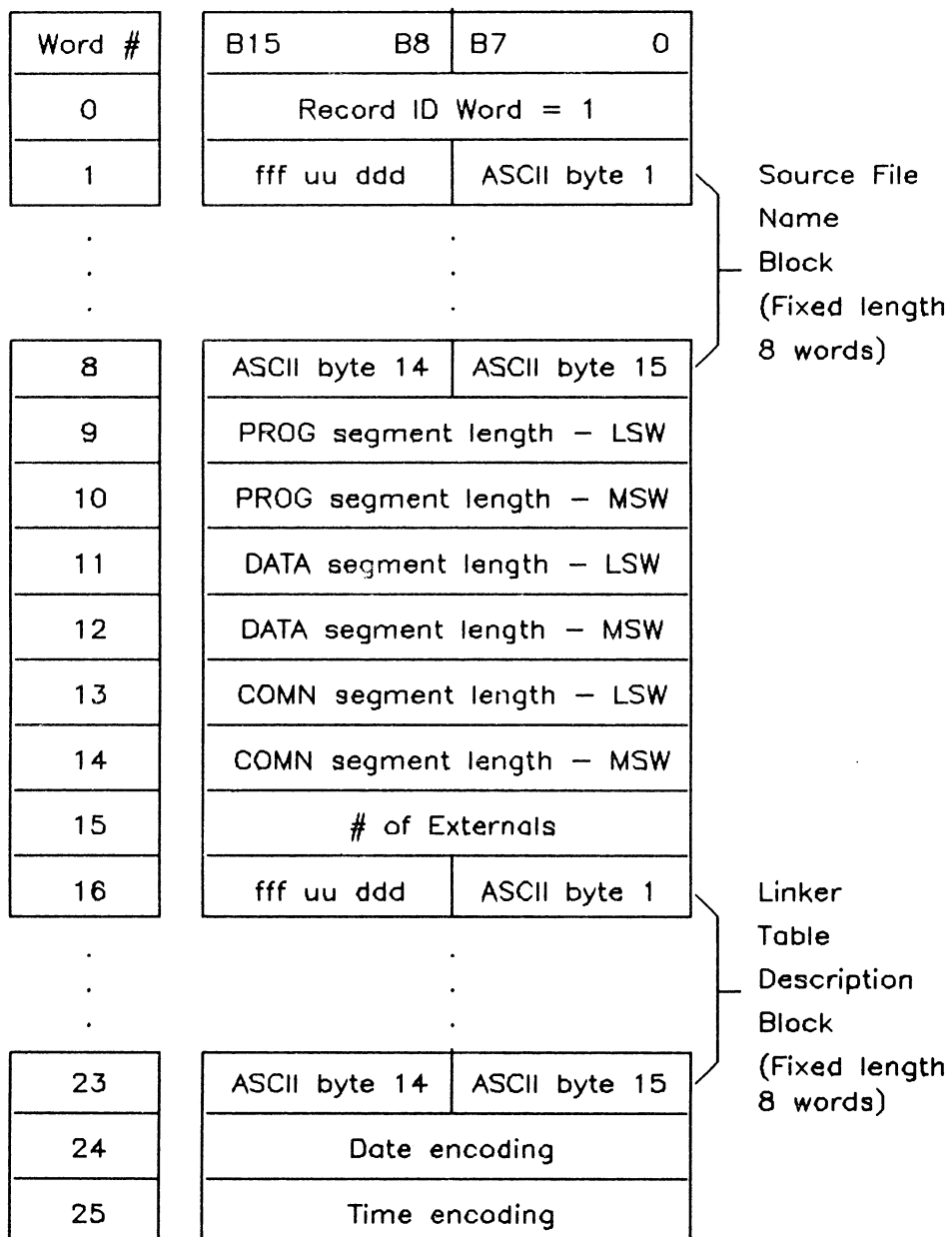

**Figure 5-2. Relocatable File - Name Record Format
(Continued on next page)**

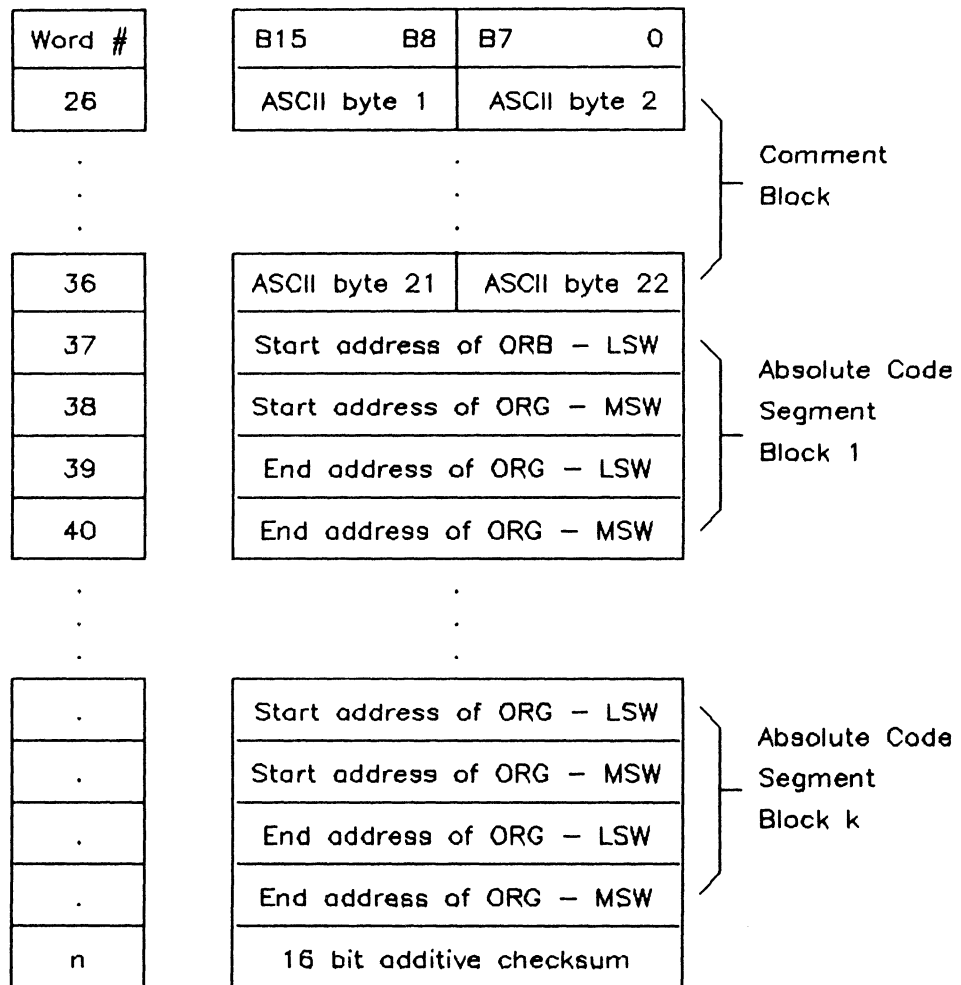

Figure 5-2. Relocatable File - Name Record Format (Cont'd)

GLOBAL RECORD FORMAT

WORD 0 – A Record ID of 2 is specified to indicate that this is a Global Symbol record. The Record ID is used internally to the relocatable file and should not be confused with the 64000 System file type number, which is 3.

WORD 1 through $n-1$ make up the k Global Symbol Definition Blocks. These blocks describe the global symbols generated as part of the relocatable file. Each global symbol definition block has a variable length of from 2 to 10 words.

The structure of each Global Symbol Definition Block is as follows:

WORD 0 through WORD sss (of a Global Symbol Definition Block) make up the Global Symbol Name Description Block. This block provides the name of the global symbol being defined. For a complete description of this block see Appendix D.

WORDS $sss+1$ and $sss+2$ (of a Global Symbol Definition Block) contain the value of the symbol. WORD $sss+2$ exists only in those processors which generate 2 words for each address (see Appendix A).

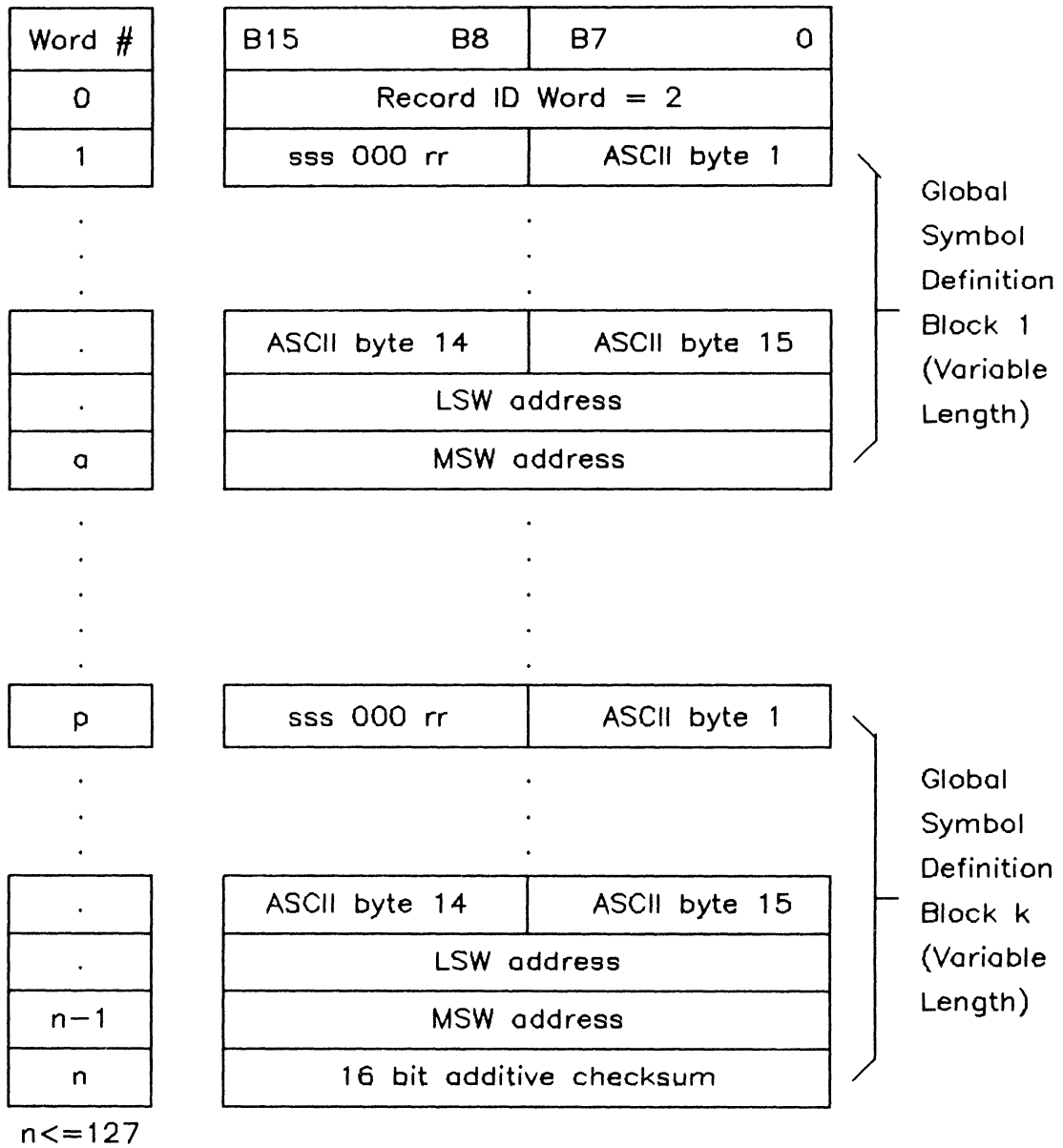

Figure 5-3. Global Symbol Record - Overall Structure

EXTERNAL RECORD FORMAT

WORD 0 - A Record ID of 4 is specified to indicate that this is an External Symbol record. The Record ID is used internally to the relocatable file and should not be confused with the 64000 System file type number, which is 3.

WORD 1 through $n-1$ make up the k External Symbol Definition Blocks. These blocks describe the external symbols required by the relocatable code. Each external symbol definition block has a variable length of from 2 to 9 words.

The structure of each External Symbol Definition Block is:

WORD 0 through WORD sss (of an External Symbol Definition Block) make up the External Symbol Name Description Block. This block provides the name of the global symbol being defined. For a complete description of this block see Appendix D.

WORD $sss+1$ - contains the external ID number of the symbol. The up to 512 symbols are numbered from 0 to 511. The external ID number is used when this external symbol is referenced in a double record in the same relocatable file.

**File Format
Reference Manual**

Word 2 (3) - rr indicates with respect to which relocation counter the relative address described in WORD 1 is being relocated.

- 00 = absolute (no relocation)
- 01 = PROG
- 10 = DATA
- 11 = COMN

WORD 3 (4) through n-1 contain the k T Parameter Blocks. These blocks are variable length from 2 to 41 words.

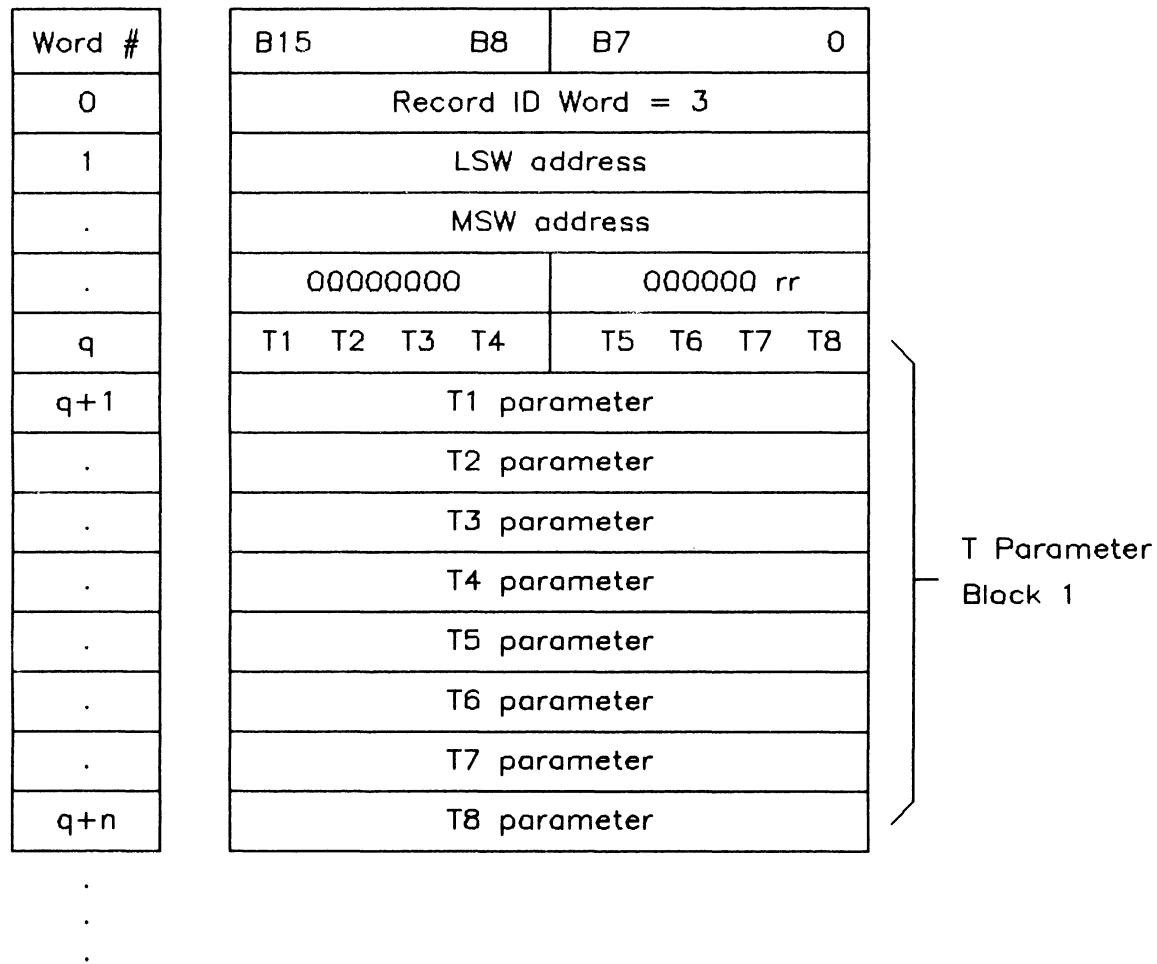

**Figure 5-5. Double Record - Overall Structure
(Continued on next page)**

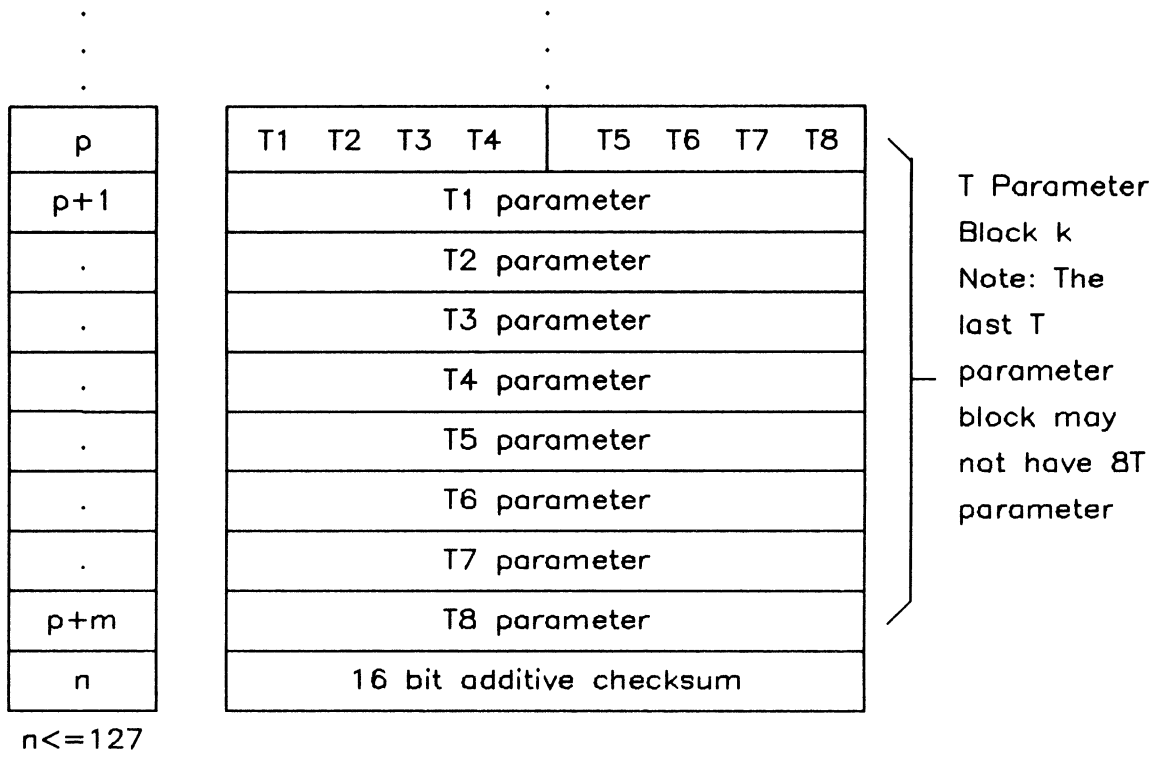

Figure 5-5. Double Record - Overall Structure (Cont'd)

**File Format
Reference Manual**

The structure of each T Parameter Block is:

WORD 0 – contains 8 two bit fields T1 through T8 describing the action to be performed by the linker on the T parameters which follow. All T Parameter Blocks in a record must be complete (use all of T1 through T8) except the last data description block.

WORD 1 through the end of this T Parameter Block contain the T Parameters as described below.

T-PARAMETERS

If $T_i = 00$, the required T-parameter is a single word of which the low order byte contains a byte of code which will be written as is to the absolute file by the linker. The high order byte is not used.

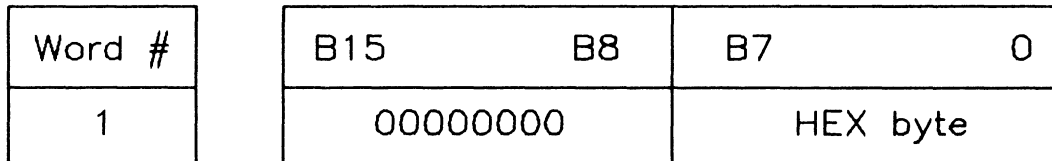

Figure 5-6. $T_i = 00$ Format

If $T_i = 01$, the required T-parameter is a single word in which both bytes of data will be written as is by the linker to the absolute file. The byte in B15 through B8 is the first byte loaded, B7 through B0 is the second byte loaded.

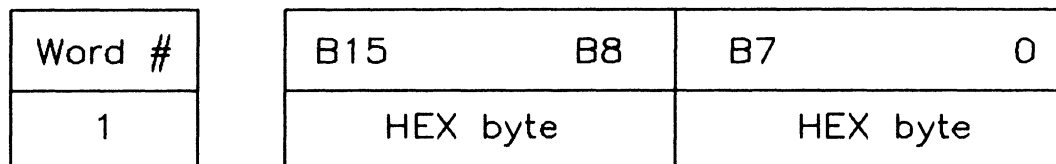

Figure 5-7. $T_i = 01$ Format

If $T_i = 10$, the required T-parameter is from 2 to 5 words of data organized as follows:

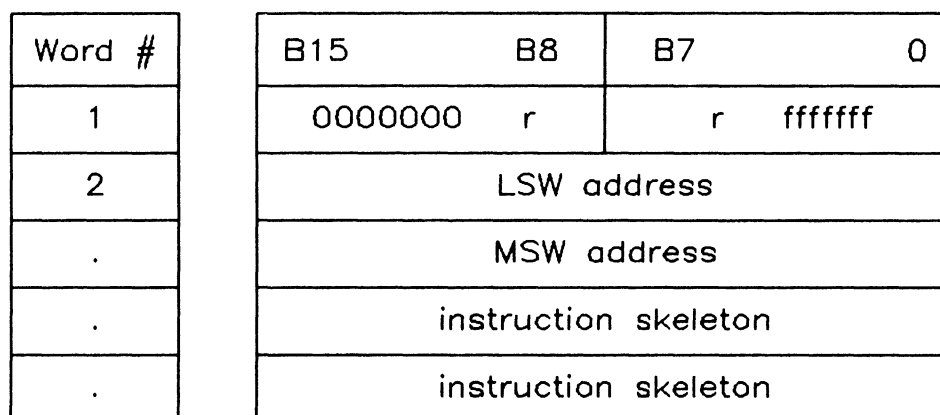

Figure 5-8. $T_i = 10$ Format

WORD 1 - The contents of Word 1 is broken down as follows:

rr - bits 9,8 - contain a code describing which relocation counter to use in relocating this symbol.

- 00 = absolute (no relocation)
- 01 = PROG
- 10 = DATA
- 11 = COMN

ffffff -- a 7 bit field used to indicate to the linker the format number for processor dependent instructions. See Appendix A for description of processor dependent format numbers.

WORD 2 (and **WORD 3** for processors using 2 words for each address) contains the address to be relocated (see Appendix A).

**File Format
Reference Manual**

WORD 3 (or WORDs 4 & 5 as indicated in Appendix A) contains an instruction skeleton. A given format number for a specific processor requires having or not having a 16 bit or 32 bit (depending on processor) instruction skeleton. See Appendix A for details.

If $T_i = 11$, the required T-parameter is from 2 to 5 words of data organized as shown in Figure 5-9.

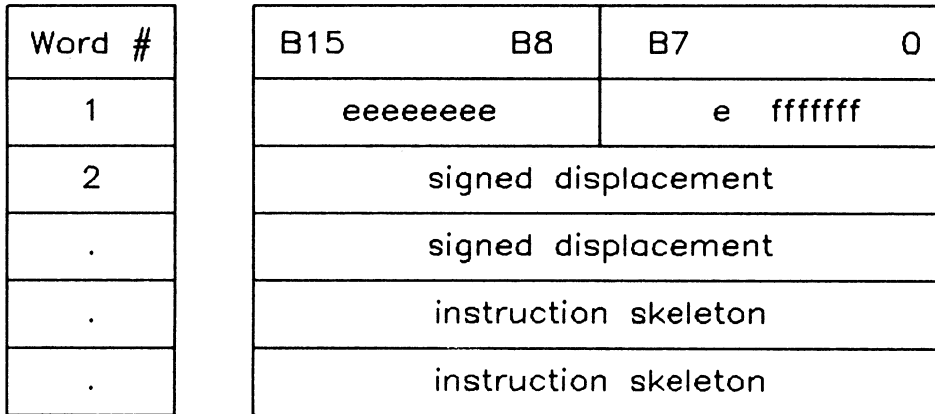

Figure 5-9. $T_i = 11$ Format

WORD 1 - The contents of Word 1 is broken down as follows: eeeeeeee -- a nine bit field which holds the external identification number of a symbol in an external symbol record. The external symbol record defining this symbol must be physically located before any data definition record referencing it.

ffffff -- a 7 bit field used to indicate to the linker the format for processor dependent instructions. See Appendix A for description of processor dependent format numbers.

WORD 2 (and WORD 3 for processors using 2 words for each address) contains the address to be relocated (refer to Appendix A).

WORD 3 (or WORDs 4 & 5 for processors indicated in Appendix A) contains an instruction skeleton. A given format number for a specific processor requires having or not having a 16 bit or 32 bit (depending on processor) instruction skeleton. See Appendix A for details.

END RECORD FORMAT

WORD 0 – A Record ID of 5 is specified to indicate that this is an End record. The Record ID is used internally to the relocatable file and should not be confused with the 64000 System file type number, which is 3.

WORD 1 – bits 2,1, and 0 (rrr) define with respect to which relocation counter the transfer address of the program is defined.

000 = absolute (no relocation)
 001 = PROG
 010 = DATA
 011 = COMN
 100 = no transfer address for this module

WORD 2 and WORD 3 contain the transfer address for the program relative to the relocation counter specified in word 1. Note the MSW is not optional but is set to 0 for processors requiring only 1 word of address (see Appendix A).

WORD 4 – 16 bit additive checksum of this record.

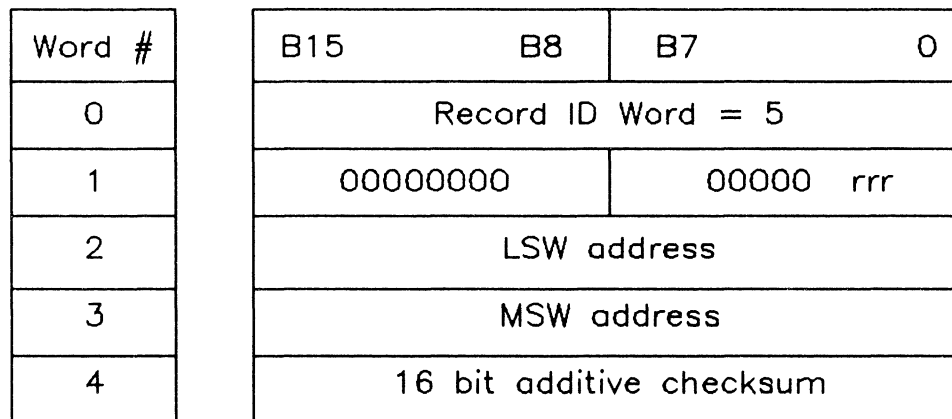

Figure 5-10. End Record - Overall Structure

**File Format
Reference Manual**

Chapter 6

ABSOLUTE FILE FORMAT

ABSOLUTE FILE (FILE TYPE 4)

An absolute file is a binary object file generated by the linker, or by the emulation system when a "store memory to <FILE>" command is executed. It consists of a variable number of records, the first of which, called the Processor Information Record, provides information about the microprocessor for which the file is intended. All subsequent records, called Data Records, are of variable length up to 128 sixteen-bit words and contain header information about the record along with data words.

For a pictorial representation of the absolute file format, see Figures 6-1, 6-2, and 6-3.

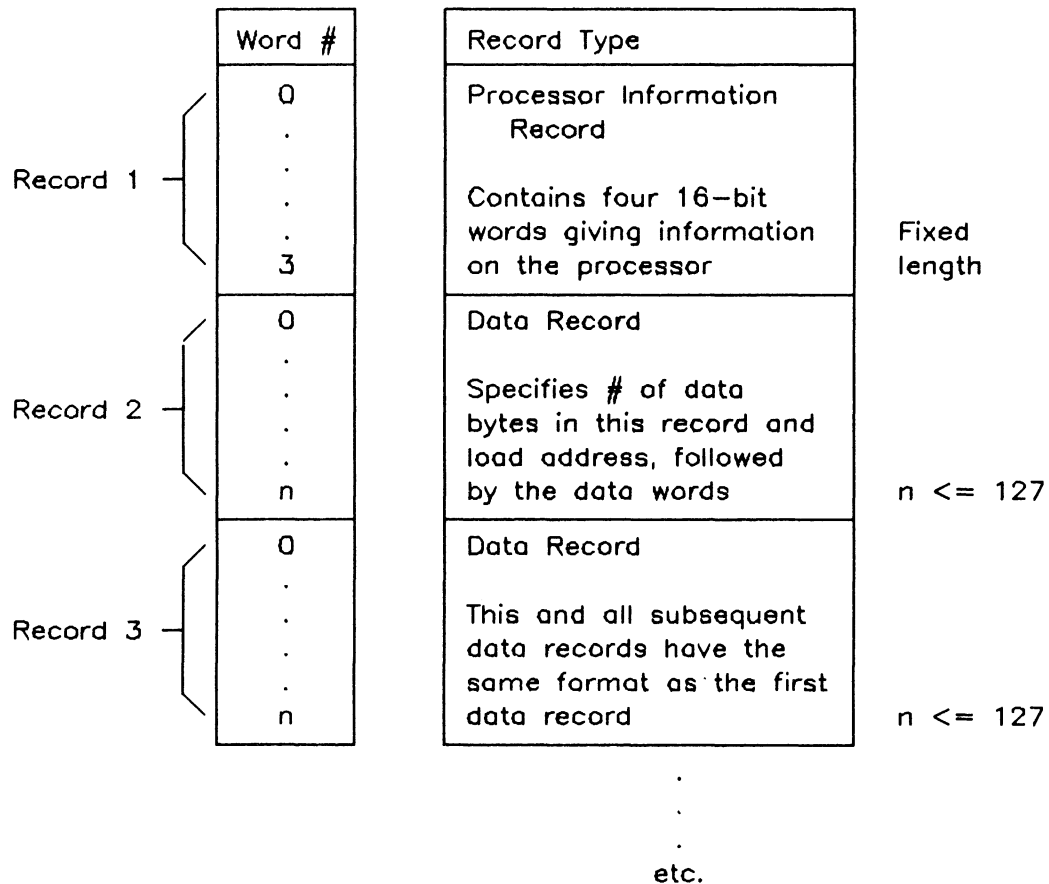

Figure 6-1. 64000 System Absolute Files - Overall Structure

PROCESSOR INFORMATION RECORD

WORD 0 – Data Bus Width is the width of processor data bus (i.e. 8,16, etc. See Appendix A).

WORD 1 – Data Width Base is the minimum addressable entity (group of bits) used by the microprocessor. Usually this will be 8, but not always (see Appendix A).

WORD 2-3 – Transfer Address is the value to be loaded into the microprocessor Program Counter by the emulator. It is generated only by the linker and is set to zero when an absolute file is created by storing memory from the emulator. The Most Significant Word of the Transfer Address should be set to zero if it is not needed by the processor (see Appendix A).

Word #	B15	B8	B7	0
0	Data Bus Width			
1	Data Width Base			
2	Transfer Address LS Word			
3	Transfer Address MS Word			

Fixed Length = 4 words

Figure 6-2. Absolute File -Processor Information Record Format

DATA RECORD

WORD 0 – # of Data Bytes in this record expressed in binary.

WORD 1-2 – Load Address is the binary address in the microprocessor memory space into which the first data byte (from WORD 3) should be loaded. Subsequent data from this record is loaded into the following microprocessor memory space. The Most Significant Word of the Load Address should be set to zero if it is not needed by the processor (see Appendix A).

WORD 3 through n – Data Words are the binary representation of the absolute data to be loaded into microprocessor memory space.

WORD n – If the last byte of word n is not used, it should be set to 0.

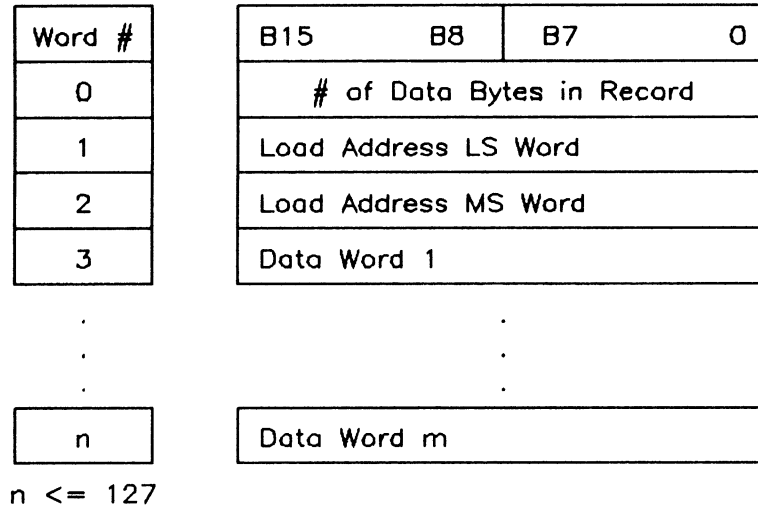

Figure 6-3. Absolute File - Data Record Format

**File Format
Reference Manual**

Chapter 7

EMULATION COMMAND FILE FORMAT

EMULATION COMMAND FILE (FILE TYPE 6)

Emulation command files contain information used to configure an emulator. These files are very complicated, and the user will find it easier to change, create, or decode an :emul__com file by using measurement system. For this reason, the details of the structure of an emulation command file will not be described.

SPECIAL EMUL__COM FILES

EcnfgXY:HP

If a name is not given for the emul__com file when you are configuring the emulator, an emul__com file will be created for you with the name EcnfgXY:HP where X is the System Bus address of your station, and Y is the card cage number of the slot which has the emulator control card in it.

**File Format
Reference Manual**

Chapter 8

LINKER COMMAND FILE FORMAT

LINKER COMMAND FILE (FILE TYPE 7)

Linker command files contain information used to tell the linker how to create an absolute file with the same name as the `:link__com` file (which files to link together, where to relocate them, etc.). The format used to store this information is a memory dump which has a very complex format. The user will find it easier to modify, create, or decode a link command file by using the linker. For this reason, the details of the structure of a linker command file will not be described.

**File Format
Reference Manual**

Chapter 9

TRACE FILE FORMAT

TRACE FILE (FILE TYPE 8)

Trace files are created and used by the HP64000 system software performance analyzer, state analyzer, timing analyzer, and emulation with analysis systems. They are used to store configuration information and/or measurement data. Each module has defined its trace files differently. The basic structure of a trace file is an Identification Record followed by a variable number of additional records (see Figures 9-1 and 9-2).

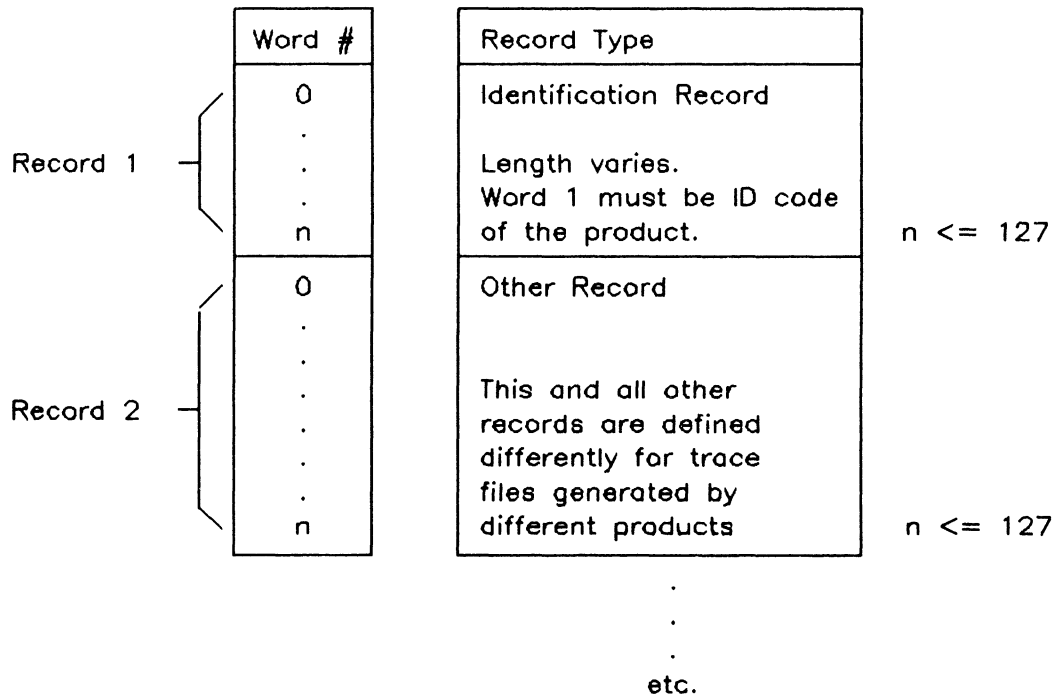

Figure 9-1. Trace Files - Overall Structure

**File Format
Reference Manual**

WORD 0 - The 4 HEX digit ID code describing the board which generated the trace file.

- 0101 -- HP64310 Software Performance Analyzer
- 1001 -- HP64601 Timing Analyzer
- 1100 -- HP64620 State Analyzer
- 0102 -- HP64300/HP64302 internal analysis running with emulation
- 0000 -- Measurement System

WORD 2 through n - provides other information needed by the product. See "Product Descriptions" for more complete information.

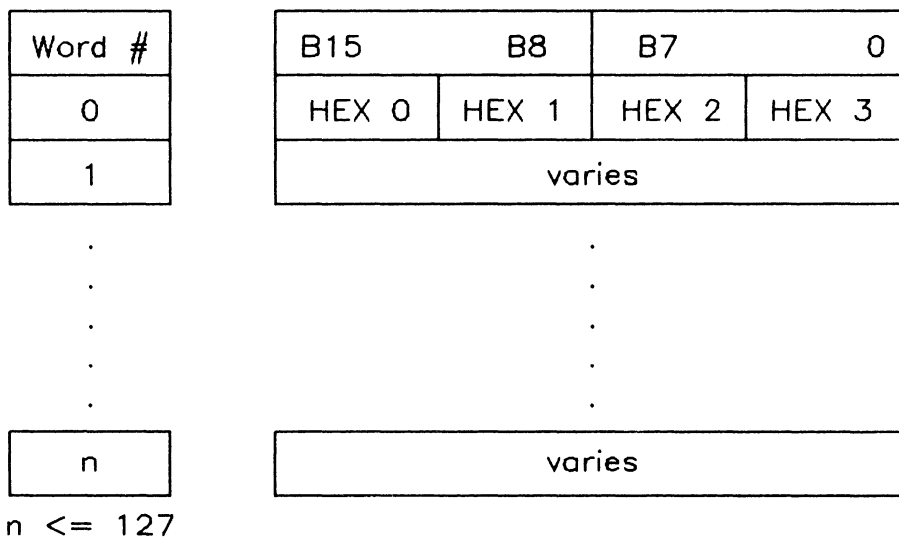

Figure 9-2. Identification Record - Overall Structure

PRODUCT DESCRIPTIONS

SOFTWARE PERFORMANCE ANALYZER

WORD 0 – A board ID of 0101H is specified to indicate that this trace file was created by a Software Performance Analyzer (see Figures 9-3 and 9-4).

WORD 1 – file lock provides the user with a way to protect his files from being over-written. A zero in this location means the file may be read or written. A non-zero value means the file can only be read.

Software Performance Analyzer stores only configuration information in the trace file. There is no data stored. In most cases, it is simplest for the user to modify his configuration by using measurement systems and modifying a previous configuration file. However, if a user is doing remote development, it may be useful to reconfigure the EVENT_ARRAY remotely. For such a purpose, only that part of the configuration file is described here. **IMPORTANT:** To incorrectly change this trace file should be attempted **ONLY** by a highly experienced SPA user. It is very important that the user does not modify any part of the trace file other than the event array. Note also that **NO** guarantees are made concerning operation of SPA if invalid values are written into the event array.

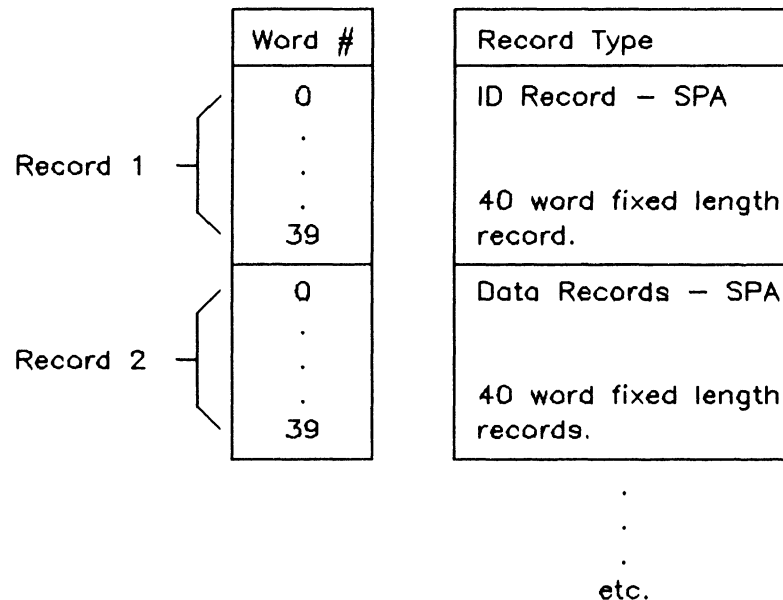

Figure 9-3. Trace File Format – Software Performance Analyzer

**File Format
Reference Manual**

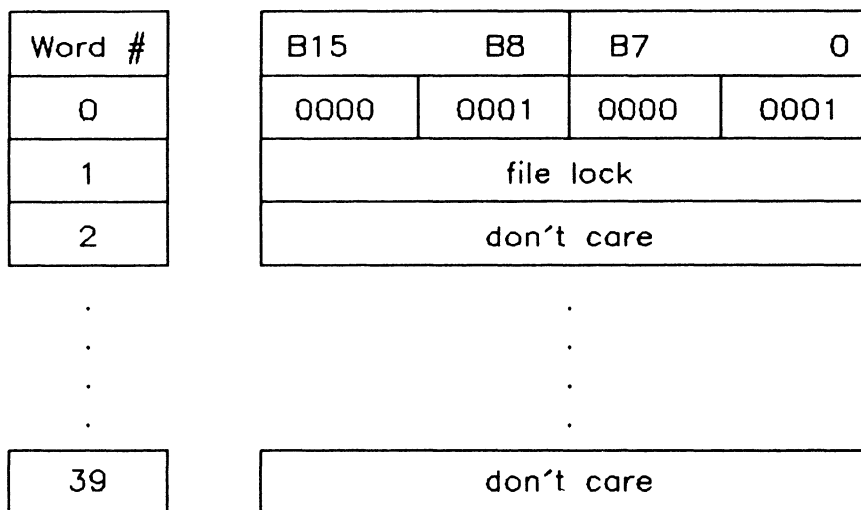

Figure 9-4. Identification Record - Software Performance Analyzer

The EVENT_ARRAY is stored in records 1 through 29, and the first 28 words of record 30. There are 99 EVENT_ARRAY entries, each having a length 12 words. Since all records have a fixed length of 40 words, the array entries will cross record boundaries. The EVENT_ARRAY has a format as shown in Figure 9-5. See Figure 9-6 for a detailed description of the Data record format.

WORD 0 through WORD 7 - Provides the 15 character title for the event specified as well as some information indicating what the event was. Word 0 through word 6 contain the first 14 characters packed two characters per word. The fifteenth character is stored in the upper byte of word 7. All unused characters must be set to blank (20H). The lower byte of word 7 is decoded as follows:

Bits 7,6,5,4 - this four-bit field defines the number of bytes in the title field that contain title information.

Bit 3 - This bit defines whether the event specified is a time event. A one indicates a time event.

Bit 2 - This bit defines whether the event specified is an address event. A one indicates an address event.

Bit 1 - This bit indicates whether the title field contains a title for this event. A one indicates that the title exists.

Bit 0 - This bit indicates whether this is a valid entry in the event array. A one indicates it is a valid event.

Word #	B15	B8	B7	0
0	ASCII 0		ASCII 1	
1	ASCII 2		ASCII 3	
2	ASCII 4		ASCII 5	
3	ASCII 6		ASCII 7	
4	ASCII 8		ASCII 9	
5	ASCII 10		ASCII 11	
6	ASCII 12		ASCII 13	
7	ASCII 14		llll t a n v	
8	LSW lower bound			
9	MSW lower bound			
10	LSW upper bound			
11	MSW upper bound			

Figure 9-5. Event Array Entry

Word #	B15	B8	B7	0
0	data 0			
1	data 1			
2	data 2			
⋮	⋮			
⋮	⋮			
⋮	⋮			
⋮	⋮			
39	data 39			

Figure 9-6. Data Record Format

**File Format
Reference Manual**

WORD 8 through 11 – lower bound/upper bound: For an address event, these fields are defined to contain a 32-bit absolute address. At present only the lower 24 bits are used. For a time event, the boundary field is defined as shown in Figure 9-7.

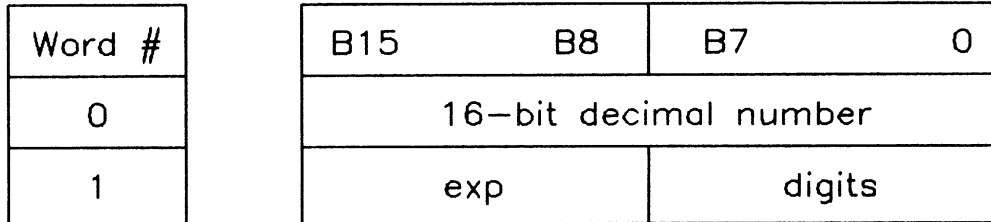

Figure 9-7. Time Event Boundary Definition

To encode the field:

1) Time = (x.yza X 10 exp w) microseconds. This number is in scientific notation (w is a multiple of 3).

The binary equivalent of decimal xyza (no decimal point) is stored in the first word.

The number of digits to the right of the decimal point is stored in the lower byte of the second word.

The exponent (w) is stored in the upper byte of the second word.

For example: If time is 65.74 X 10 exp 3 microseconds, the time event would be stored as shown in Figure 9-8.

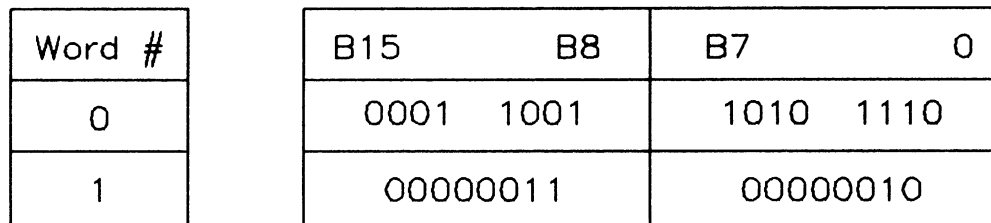

Figure 9-8. Time Event Boundary Example

TIMING ANALYZER

WORD 0 – A board ID of 1001H is specified to indicate that this trace file was created by a Timing Analyzer (see Figures 9-9 and 9-10).

WORD 1 – ID code of data structure provides a version number. It is set up as an HP date code and converted to HEX. For example if the ID code was 08AA, that would be 2218 decimal or week 18 of 1982.

WORD 3 and WORD 4 – provide a 32-bit checksum of the rest of the records of the file. The checksum is computed by adding the 16-bit words together. To get the LSW of the checksum, and every time there is an overflow incrementing the MSW of the checksum.

WORD 5 – file lock provides the user with a way to protect his files from being over-written. A zero in this location means the file may be read or written. A non-zero value means the file can only be read.

The Timing Analyzer currently stores only configuration information in the trace file. There is no data stored. If the user wishes to modify his configuration he should do so by entering measurement systems and modifying a previous configuration file. **IMPORTANT:** Be very careful if you modify any part of a trace file and then try to use it again to configure the timing analyzer; to do otherwise may cause unexpected results.

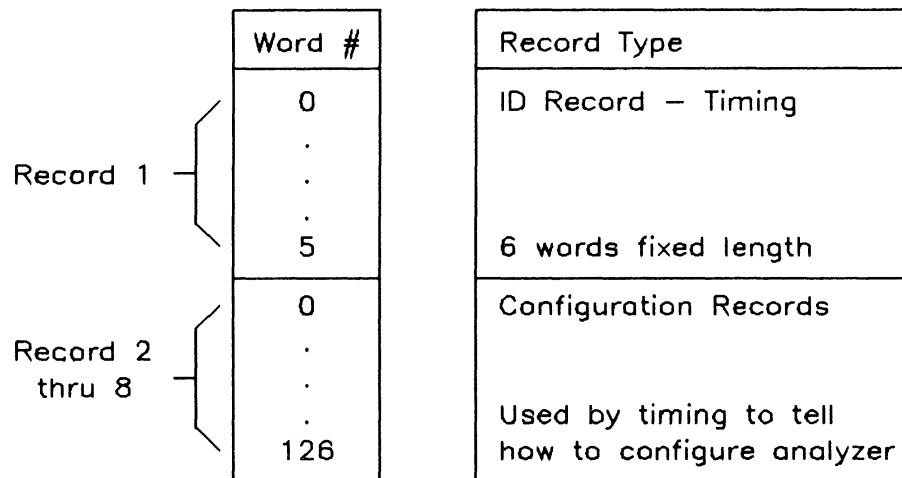

Figure 9-9. Trace File Format - Timing Analyzer

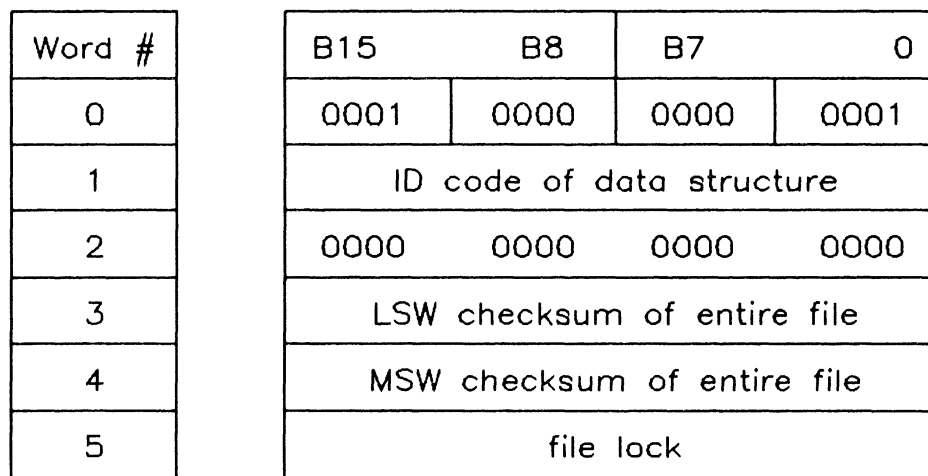

Figure 9-10. Identification Record - Timing Analyzer

STATE/SOFTWARE ANALYZER

WORD 0 – A board ID of 1100H is specified to indicate that this trace file was created by the Model 64620 State Analyzer (see Figures 9-11 and 9-12).

WORD 1 – The identification code provides a version number for the data structure.

WORD 2 – Modification number provides a version number. It is a binary encoded decimal number representing an HP date code. For example, if the modification number was 2218, that would represent week 18 of 1982.

WORD 3 through 10 – Provides the State Analyzer software with the name of the dis-assembler table it is to use. This should be in the form of an HP64000 system file name (nnnnnnnnn:uuuuuu). nnnnnnnnn is the file name, up to nine characters. uuuuuu is the userid of the file, up to 6 characters. The file name should be packed with the extra bytes set to blank (20H). The colon (:) must be included.

WORD 11 and WORD 12 – provide a 32-bit checksum of the rest of the records of the file. The checksum is computed by adding the 16-bit words together. to get the LSW of the checksum, and every time there is an overflow incrementing the MSW of the checksum.

WORD 13 – file lock provides the user with a way to protect his files from being overwritten. A zero in this location means the file may be read or written. A non-zero value means the file can only be read.

The State Analyzer stores configuration information in the trace file. However, the information is stored as an image of memory, and as such it would not be feasible to try to extract or modify these parts of the trace files.

NOTE: Modifying any part of the configuration portion of the trace file trace file and then using it again to configure the state analyzer may cause unexpected results.

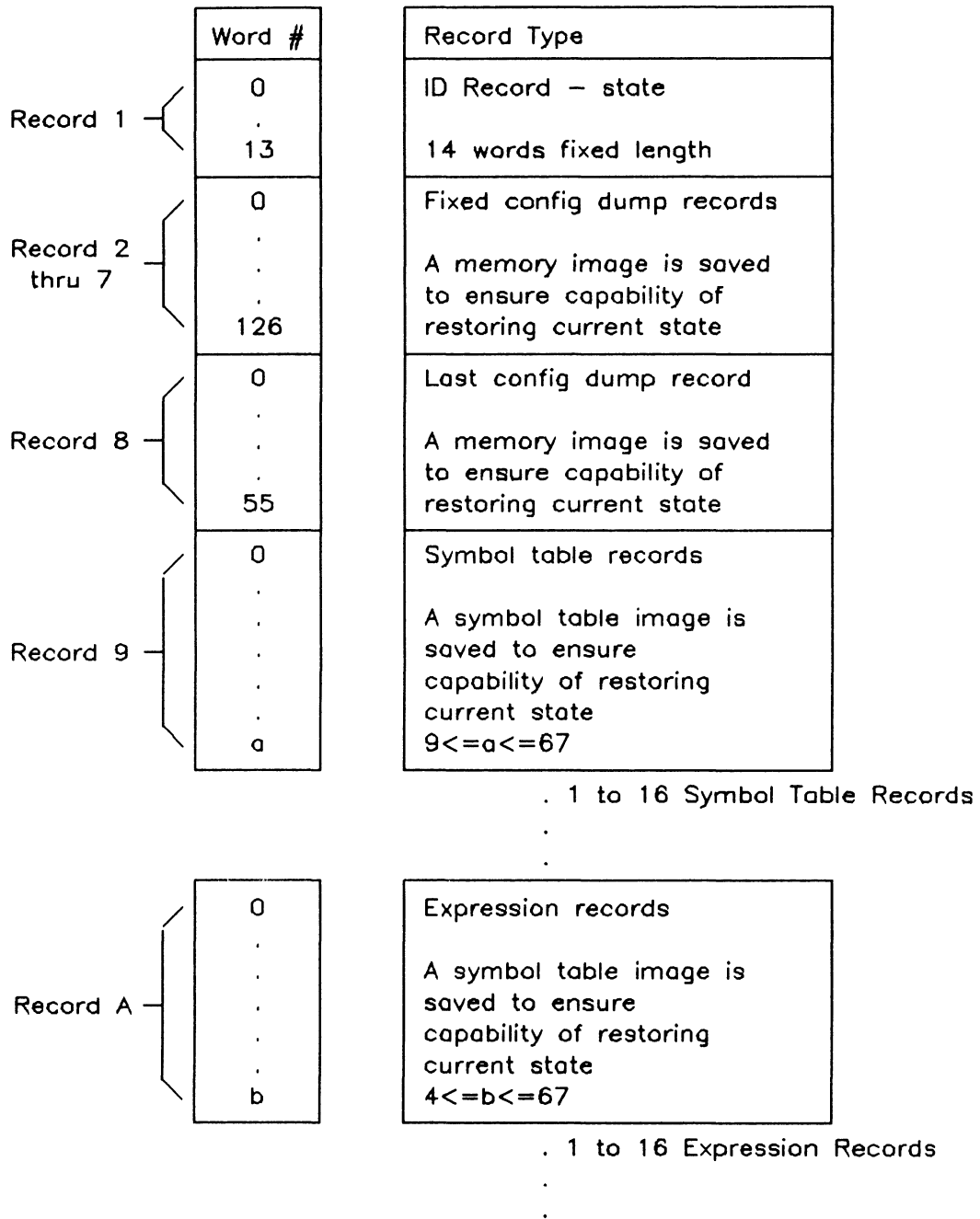

**Figure 9-11. Trace File Format – State Analyzer
(Continued on next page)**

**File Format
Reference Manual**

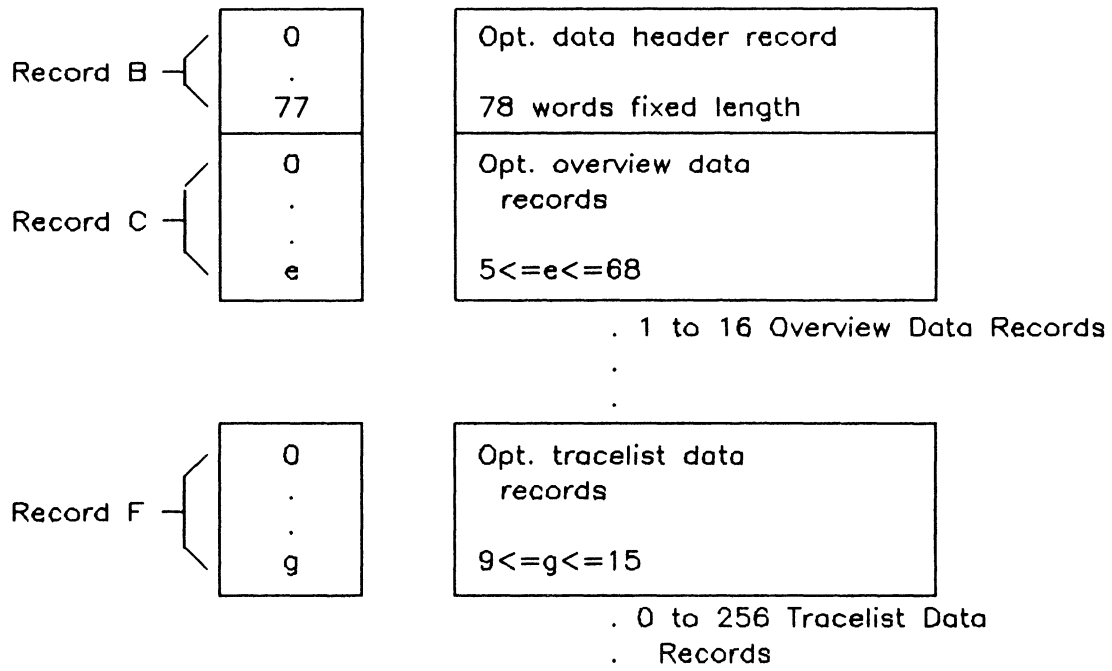

Figure 9-11. Trace File Format - State Analyzer (Cont'd)

Word #	B15	B8	B7	0
0	0001	0001	0000	0000
1	0111	0010	0000	0100
2	modification number			
3 to 10	Disassembler table file name packed in standard HP 64000 file name format			
11	LSW checksum of entire file			
12	MSW checksum of entire file			
13	file lock			

Figure 9-12. Identification Record - State Analyzer

The configuration dump records contain information used to configure the analyzer. These records are memory images and are very complicated. Users will find it easier to create or change the information using the measurement system. For this reason, only the structures of the configuration records (Configuration Dump, Symbol Table, and Expression Records) are shown (see Figures 9-13 thru 9-16). NOTE: Modifying any of the records and then attempting to use them again to configure the state analyzer may cause unexpected results.

Word #	B15	B8	B7	0
0	0000	0000	0000	0001
1	relative position pointer			
2 to 124	123 words of memory image			
125	LSW checksum of record			
126	MSW checksum of record			

Figure 9-13. Fixed Configuration Dump Record Format

Word #	B15	B8	B7	0
0	0000	0000	0000	0001
1	relative position pointer			
2 to 53	52 words of memory image			
54	LSW checksum of record			
55	MSW checksum of record			

Figure 9-14. Last Configuration Dump Record Format

Word #	B15	B8	B7	0
0	0000	0000	0000	0002
1	relative position pointer			
2 to a-2	a-3 words of memory image			
a-1	LSW checksum of record			
a	MSW checksum of record			

Figure 9-15. Symbol Table Record Format

Word #	B15	B8	B7	0
0	0000	0000	0000	0003
1	relative position pointer			
2 to b-2	b-3 words of memory image			
b-1	LSW checksum of record			
b	MSW checksum of record			

Figure 9-16. Expression Record Format

OPTIONAL DATA HEADER RECORD FORMAT - STATE ANALYZER TRACE FILE
(See Figure 9-17.)

Word - 0 An ID code of 0100 is given to indicate that this record is the data header record.

Word - 1 Signifies whether the count is time count or state count.

Word - 2 Specifies the width of the analyzer used in the measurement

Word - 3 Indicate the mode used in the measurement.

bit 0 - sequence on

bit 1 - window 1 on

bit 2 - window 2 on

Word 4 - If the trigger condition was met the HISTORY__FLAG will be 0, otherwise it will be equal to 1 signifying that the information represents data history.

Word 5 - the number of words added in the trace list data records. This value can be from 2 thru 8.

Word 6 and Word 7 - the valid range of lines contained in the data records.

Word 8 and Word 9 - specifies the first and last line of valid trace data.

Word 10 - specifies the number of valid data cells in the overview records.

Word 11 - this value is the identification code of the preprocessor used to capture the data.

Words 12 to 75 - This information represents special information required by the inverse assembler and should not be required by a user.

Words 76 and Word 77 - provide a 32-bit checksum of the rest of the record. The checksum is computed by adding the 16-bit words together to get the LSW of the checksum and also every time there is an overflow incrementing the MSW of the checksum.

**File Format
Reference Manual**

Word #	B15	B8	B7	0
0	0000	0001	0000	0000
1	state or time count flag			
2	number of bits of analysis			
3	sequencer mode			
4	HISTORY_FLAG			
5	MICRO_SIZE 2<=g<=8			
6	MIN_LINE			
7	MAX_LINE			
8	FIRSTVALID			
9	LASTVALID			
10	NUM_OF_OVERVIEW 0<=e<=4096			
11	PP_ID			
12 to 75	soft tag array for IAL			
76	LSW checksum of record			
77	MSW checksum of record			

Figure 9-17. Optional Data Header Record Format

OPTIONAL OVERVIEW DATA RECORD FORMAT - STATE ANALYZER FILE (See Figure 9-18.)

Word 0 - the ID code for the overview data record

Word 1 - starting line number of the overview data it can range from 0 to 4096.

Word 2 to Word e-2 - Overview data of from 1 to 64 words each containing 4 nibbles of overview data.

Words e-1 and e - provide a 32-bit checksum of the rest of the record. The checksum is computed by adding the 16-bit words together to get the LSW of the checksum, and everytime there is an overflow incrementing the MSW of the checksum.

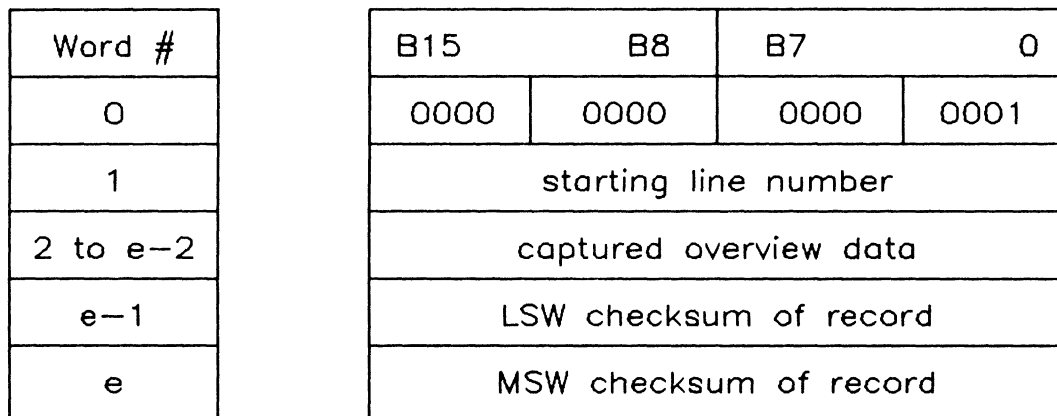

Figure 9-18. Optional Overview Data Record Format

OPTIONAL TRACELIST DATA RECORD FORMAT - STATE ANALYZER TRACE

Word 0 - ID code for tracelist data

Word 1 - the 16-bit two's complement number of the first trace list line number.

Word 2 - specifies the trace status

bit 15 - Overview Trigger flag, signifies that the trigger on overview event condition was true for this state.

bit 14 - Micro count reset flag **

bit 13 - Store block flag, indicates that there is a discontinuity in the trace data due to a store disable occurring.

bit 12 - always zero

bit 11 - Sequence occurrence flag **

bit 10 - Sequence resource 2 **

bit 9 - Sequence resource 1 **

bit 8 - Sequence resource 0 **

bit 7 - Window 2 enable flag **

bit 6 - Window 1 enable flag **

bit 5 - Sequence enable flag **

bit 4 - always zero

bit 3 to 0 - Logical sequencer state **

** These flags are used by the state analyzer to correctly format and calculate the various information in the trace. Since the data in the trace list data record have been formatted correctly, these flags are not needed by the user.

Word 3 thru Word 4 - the number of states or clock ticks (40 nsec) relative to the FIRST__VALID line of the trace data.

Word 6 thru Word g-2 - captured trace data, the least significant bits in word 6.

Words g-1 and g - provide a 32-bit checksum of the rest of the record. The checksum is computed by adding the 16-bit words together to get the LSW of the checksum, and every time there is an overflow incrementing the MSW of the checksum.

Word #		B15	B8	B7	0
0		0000	0001	0000	0002
1		trace list line number			
2		trace status			
3		LSW of count for the state			
4		MID of count for the state			
5		MSW of count for the state			
6		captured state data			
7 to g-2		captured state data			
g-1		LSW checksum of record			
g		MSW checksum of record			

Figure 9-19. Optional Tracelist Data Record Format

EMULATION WITH INTERNAL ANALYSIS

The variables in the trace specification record are all related to the commands as the user sets up emulation. This record is very complicated and its details are not needed by the user. Therefore, the details of its structure will not be presented here.

TRACE FILES (See Figures 9-20 thru 9-23.)

WORD 0 - run/step indicates the status of the emulator. 0 indicates the emulator was stepping, therefore data (if present) is not valid. Not 0 indicates the emulator was running.

WORD 1 - data stored indicates whether data was stored in this trace file. 0 indicates data is not stored in the file. Not 0 indicates that data follows.

**File Format
Reference Manual**

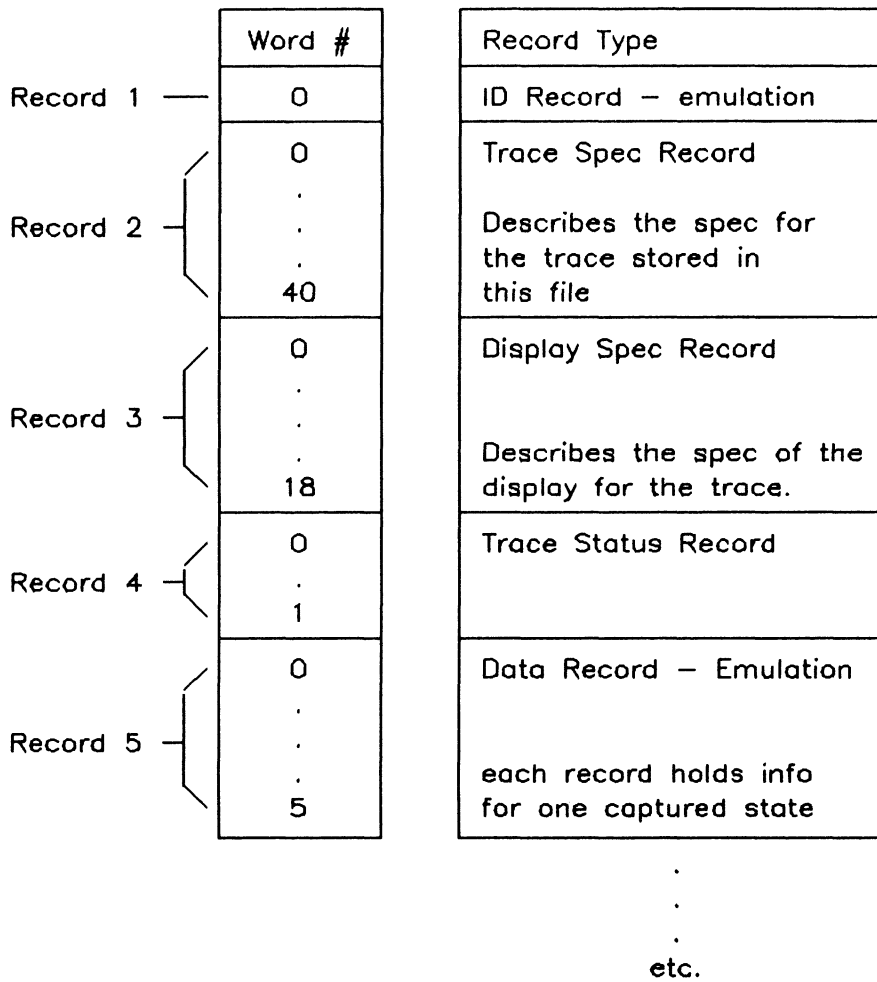

Figure 9-20. Trace File Format - Internal Analysis

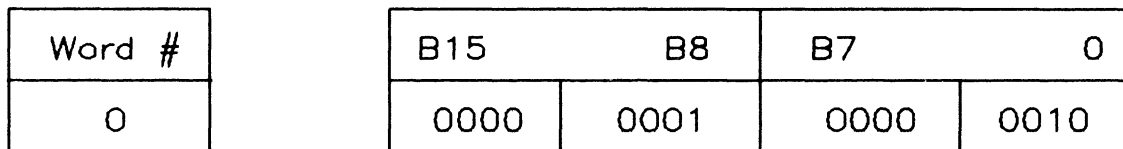

Figure 9-21. Identification Record - Internal Analysis

Word #	B15	B8	B7	0
0	Trace point			
1	Start of trace			
2 – 3	Not needed by user			
4	Count Overflow			
5 – 14	Not needed by user			
15	Prestore			
16	Totalstore			
17 – 18	Not needed by user			

Figure 9-22. Display Spec Record Format

Word #	B15	B8	B7	0
0	run/step			
1	data stored			

Figure 9-23. Trace Status Record Format

**File Format
Reference Manual**

One data record is stored for each state captured (see Figure 9-24). Information stored is the address, data, and status during the state, and a 24-count value. Count starts at OFFFFFH at the beginning of the measurement and counts down to 0.

Word #	B15	B8	B7	0
0	LSW address			
1	MSW address			
2	data			
3	status			
4	LSW of countdown			
5	MSW of countdown			

Figure 9-24. Data Record Format - Emulation

SPECIAL TRACE FILES

When you exit emulation, a trace file will be created called EcnfgNM:HP where N is the GPIB address of the station, and M is the slot number of the emulator being used. This file is used by emulation when options continue is specified.

MEASUREMENT SYSTEM

When you exit measurement systems, a trace file will be created called meas_sysN:HP where N is the GPIB address of the station. This file is used by measurement system when options resume is specified. The contents of this file are not needed by the user.

Chapter 10

PROM FILE FORMAT

PROM FILE (FILE TYPE 9)

Prom files are no longer created by the 64000 system. The format of existing prom files is the same as the absolute file format. Refer to Chapter 6 for information about the absolute file format.

**File Format
Reference Manual**

Chapter 11

DATA FILE FORMAT

DATA FILE (FILE TYPE 10)

Data files (file type = 10) are for the convenience of the user. The only :data file used by the system is spa_table:HP used by the Software Performance Analyzer. Because of its file name, this file is not accessible by the user. SPA will never use a users data file so the exact format of this data file is not needed by the user. Data files are created and accessed using Sim I/O or HOST Pascal. The system commands {copy, rename, directory, purge, and recover} will work on files of type :data.

For a pictorial representation of the data file format, see Figures 11-1 and 11-2.

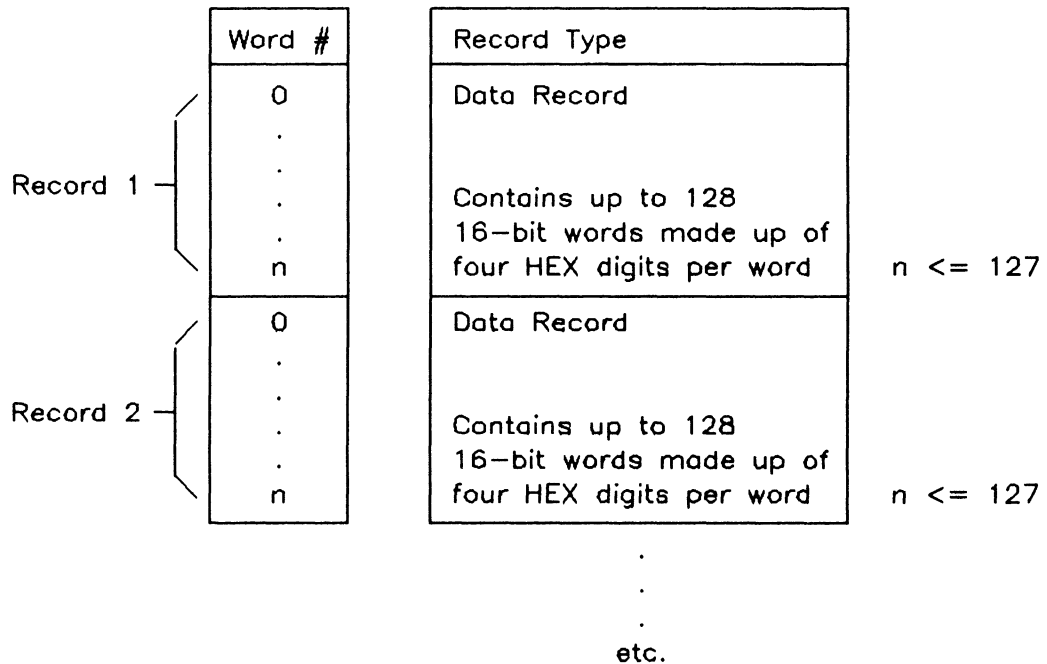

Figure 11-1. Data Files - Overall Structure

**File Format
Reference Manual**

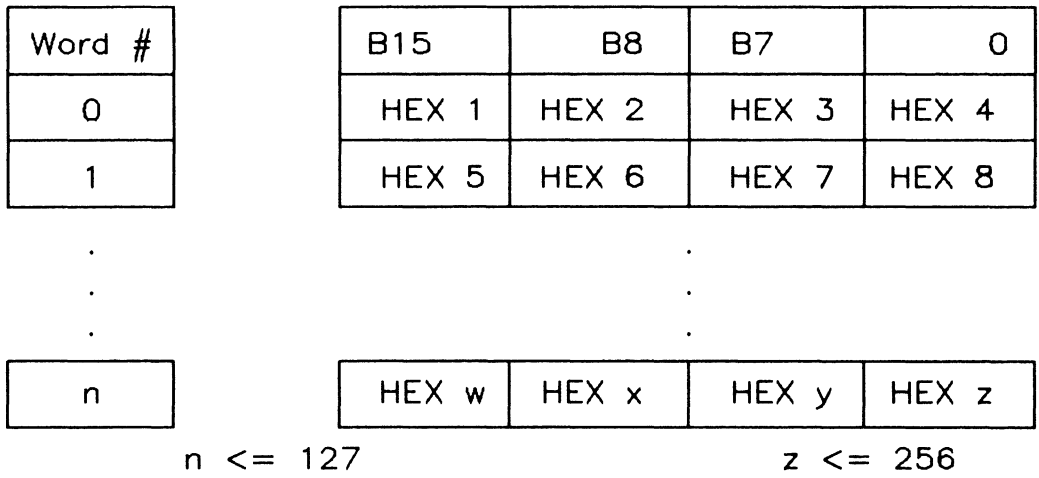

Figure 11-2. Data Record Format

Chapter 12

STATE ANALYZER DATABASE FILE FORMAT

STATE ANALYZER DATABASE FILE (FILE TYPE 11)

The state analyzer database file is created by the state analyzer. It combines the relevant information in the link__sym and asmb__sym files which apply to the absolute file being debugged. The structure of this file allows quick access to the symbols during operation of the analyzer (see Figure 12-1).

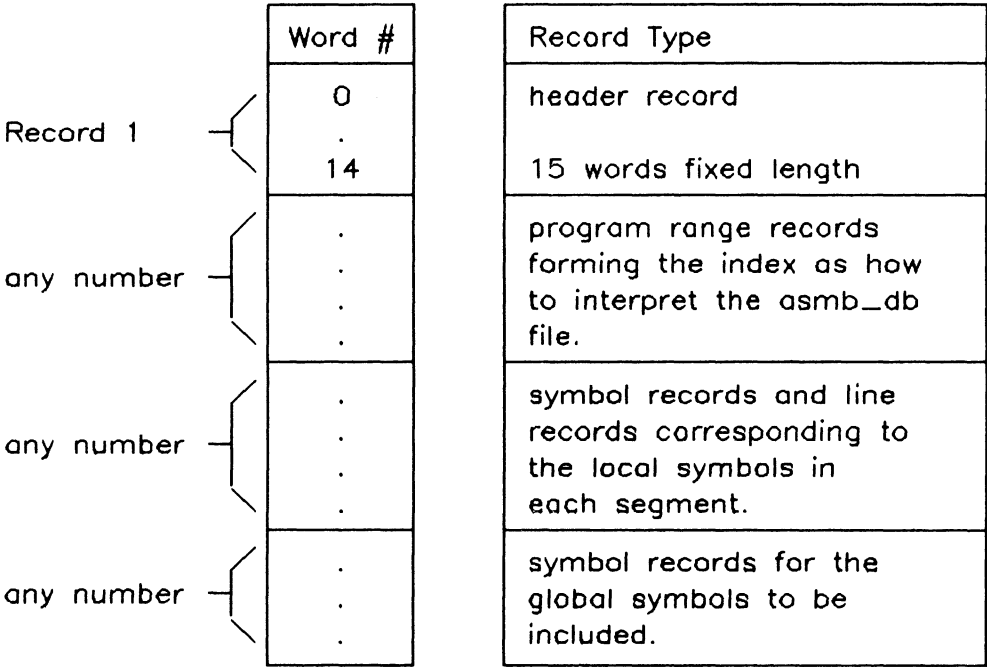

Figure 12-1. Database File Format - State Analyzer

**File Format
Reference Manual**

HEADER RECORD FORMAT - STATE ANALYZER DATABASE FILE (See Figure 12-2)

There is a program range record for each segment of the program: PROG, DATA COMM and all absolute segments.

Word 0 - ID code for the database header record

Word 1 thru Word 4 - define the range of physical address within which all of the segments fall.

Word 5 thru Word 8 - range of record numbers for local and global symbols

Word 9 - address information

bit 15 to bit 8 (highshift) - specifies the number of bits to the right to shift a 16-bit segment number to create the physical address.

bit 7 to bit 0 (address size) - indicates whether the addresses to be used are 1 or 2 words long

Word 10 - total number of local symbols in the database

Word 11 - total number of line number symbols in the database

Word 12 - total number of global symbols in the database

Word 13 - the identification code of the database file structure

Word 14 - modification of this specific database file structure

Word #	B15	B8	B7	0
0	0000	0000	0000	0000
1	LSW low bound			
2	MSW low bound			
3	LSW high bound			
4	MSW high bound			
5	first local sym rec no			
6	last local sym rec no			
7	first global sym rec no			
8	last global sym rec no			
9	highshift		address size	
10	number of local symbols			
11	number of line numbers			
12	number of global symbols			
13	0000	0000	0000	0001
14	0002	0003	0004	0004

Figure 12-2. Header Record Format

**File Format
Reference Manual**

32-BIT PROGRAM RANGE RECORD - STATE ANALYZER DATABASE FILE (See Figure 12-3.)

There is a program range record for each segment in the program: PROG, DATA, COMM and each absolute segment.

Word 0 - 32-bit program range record ID code

Word 1 - number of the first symbol record for this segment

Word 2 - number of the last symbol record for this segment

Word 3 - record number of the first line number symbol record for this segment

Word 4 - record number of the last line number symbol record for this segment.

Word 5 thru Word 8 - physical address range of this segment. The LSW and MSW are always in physical address form and are sorted in increasing address order in the file. In the case of the 8086/88, the data in the link__sym file has been converted.

Word #	B15	B8	B7	0
0	0000	0000	0000	0002
1	symbol start record			
2	symbol end record			
3	line start record			
4	line end record			
5	LSW line bound			
6	MSW low bound			
7	LSW high bound			
8	MSW high bound			
9	fff u u 0 rr		c1	
9 - 16	var length file name			

Figure 12-3. 32-Bit Program Range Record Format

16-BIT SYMBOL RECORD - STATE ANALYZER DATABASE FILE (See Figure 12-4.)

The symbol records contain the symbols and their values, a 16-bit symbol record will be used to conserve space if the address is less than 65536.

Word 0 - ID code for the 16-bit symbol record

Word 1 - symbol length and type

bit 15 to bit 13 - number of 16-bit words minus 1 in the symbol name

bit 12 to bit 10 - always zero

bit 9 to bit 8 - type of segment:

- 0 - absolute
- 1 - program relocatable
- 2 - data relocatable
- 3 - common relocatable

bit 7 to bit 0 - the beginning of the symbol name filling out the record in standard 64000 format (refer to Appendix B).

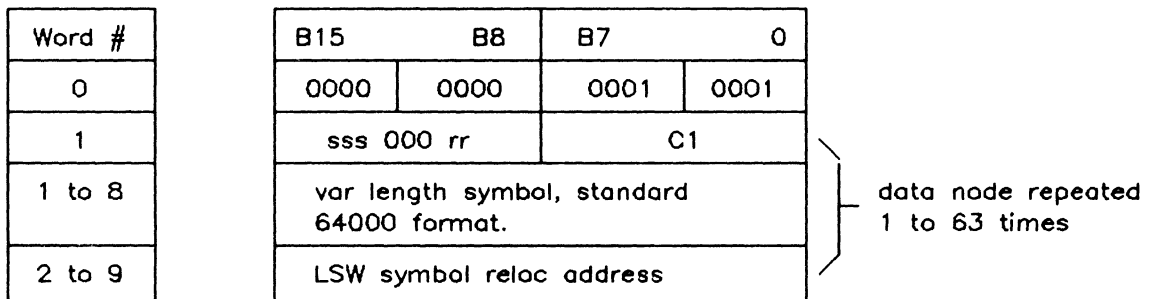

Figure 12-4. 16-Bit Symbol Record Format

**File Format
Reference Manual**

32-BIT SYMBOL RECORD - STATE ANALYZER DATABASE FILE (See Figure 12-5.)

Word 0 - ID code for the 32-bit symbol record

Word 1 - symbol length and type

bit 15 to bit 13 - number of 16-bit words minus 1 in the symbol name

bit 12 to bit 10 - always zero

bit 9 to bit 8 - type of segment:

- 0 - absolute
- 1 - program relocatable
- 2 - data relocatable
- 3 - common relocatable

bit 7 to bit 0 - the beginning of the symbol name filling out the record in standard 64000 format (refer to Appendix B).

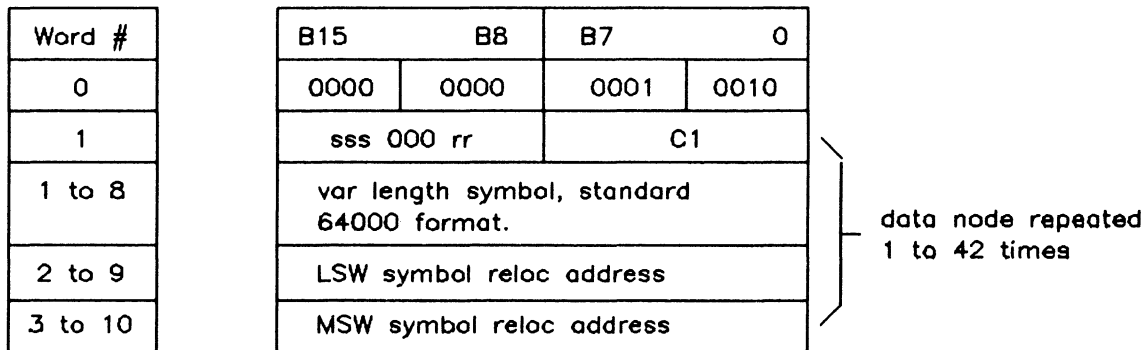

Figure 12-5. 32-Bit Symbol Record Format

16-BIT LINE NUMBER SYMBOL RECORD - STATE ANALYZER DATABASE FILE
(See Figure 12-6.)

Word 0 - ID code for the 16-bit line number symbol

Word 1 to Word 2 - the range of line numbers assigned to the value in Word 3

Word 3 - value of the above line number symbols

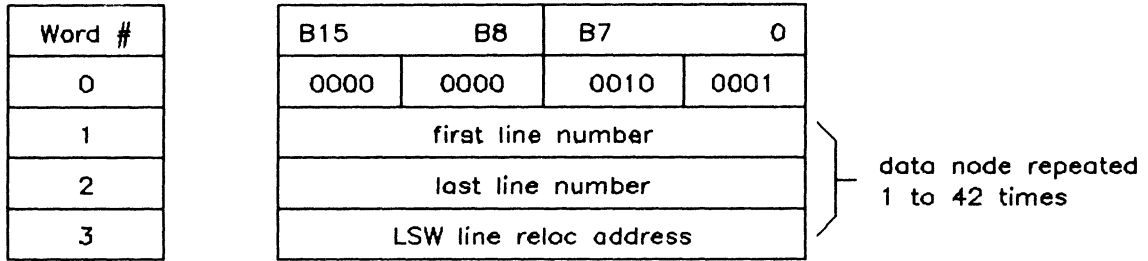

Figure 12-6. 16-Bit Line Number Symbol Record Format

32-BIT LINE NUMBER SYMBOL RECORD - STATE ANALYZER DATABASE FILE
(See Figure 12-7.)

Word 0 - ID code for the 32-bit line number symbol

Word 1 to Word 2 - the range of line numbers assigned to the value in Word 3 & Word 4.

Word 3 and Word 4 - the value of the above line number symbols.

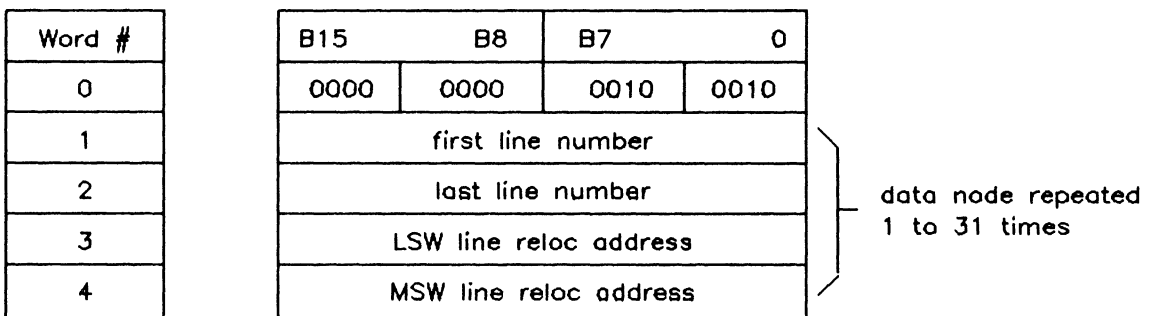

Figure 12-7. 32-Bit Line Number Symbol Record Format

**File Format
Reference Manual**

Chapter 13

ASSEMBLER SYMBOL FILE FORMAT

ASSEMBLER SYMBOL FILE (FILE TYPE 12)

An assembler symbol (:asmb__sym) file is generated whenever a source file is assembled or compiled, except with options no_code. It consists of one or more records of up to 128 sixteen-bit words long which contain descriptions for local symbols defined in the source file.

For a pictorial representation of the assembler symbol file format, see Figures 13-1 and 13-2.

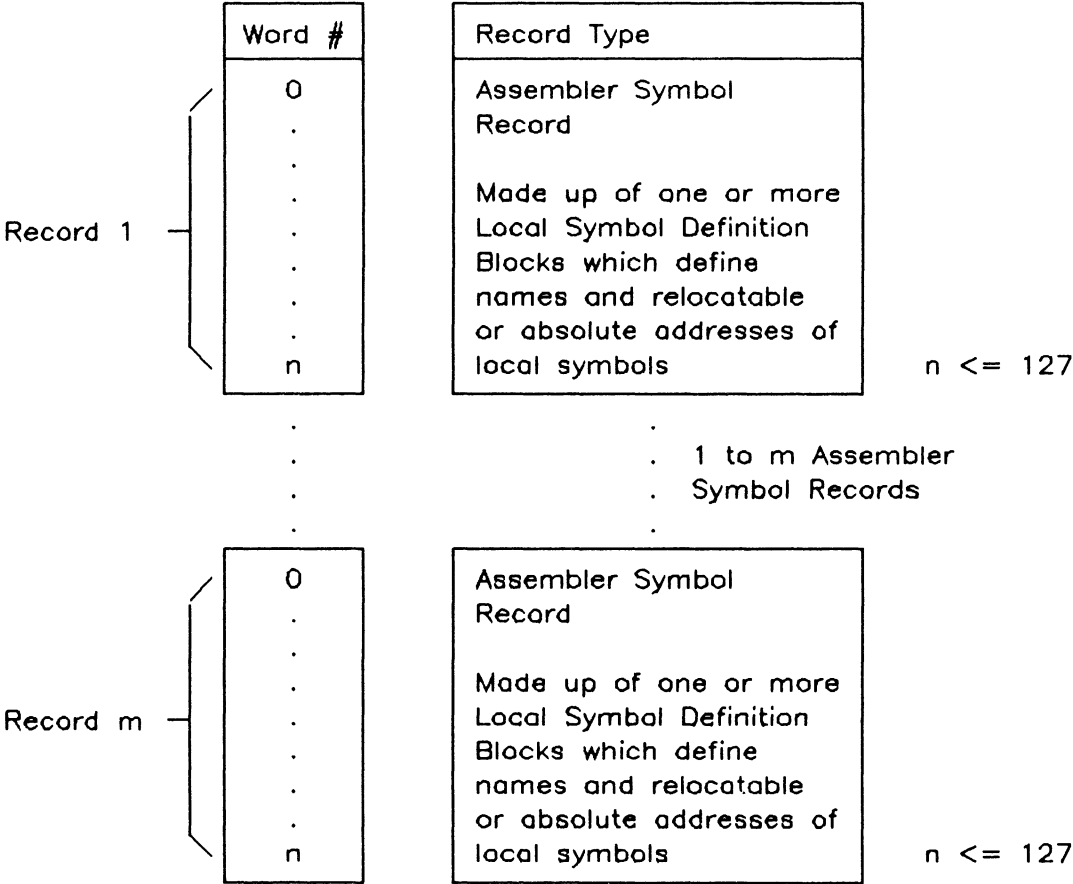

Figure 13-1. Assembler Symbol File - Overall Structure

ASSEMBLER SYMBOL RECORD

WORD 0 – A Record ID of 6 is specified to indicate that this is an Assembler Symbol Record. The Record ID is used internally to the linker symbol file and should not be confused with the 64000 System file type number, which is 12.

WORD 1 through $n-1$ make up the k Local Symbol Definition Blocks. These blocks define the local symbols from the source file. Each local symbol block has a variable length of from 2 to 10 words.

The structure of each Local Symbol Definition Block is:

WORD 0 through WORD sss (of a Local Symbol Definition Block) make up the Local Symbol Name Description Block. This block provides the name of the local symbol being defined. For a complete description of this block see Appendix D.

WORDS $sss+1$ and $sss+2$ (of a Local Symbol Definition Block) contain the value of the symbol. WORD $sss+2$ exists only in those processors which generate 2 words for each address (see Appendix A).

See the User-Definable Emulator Manual for more information about symbol usage in the UDE.

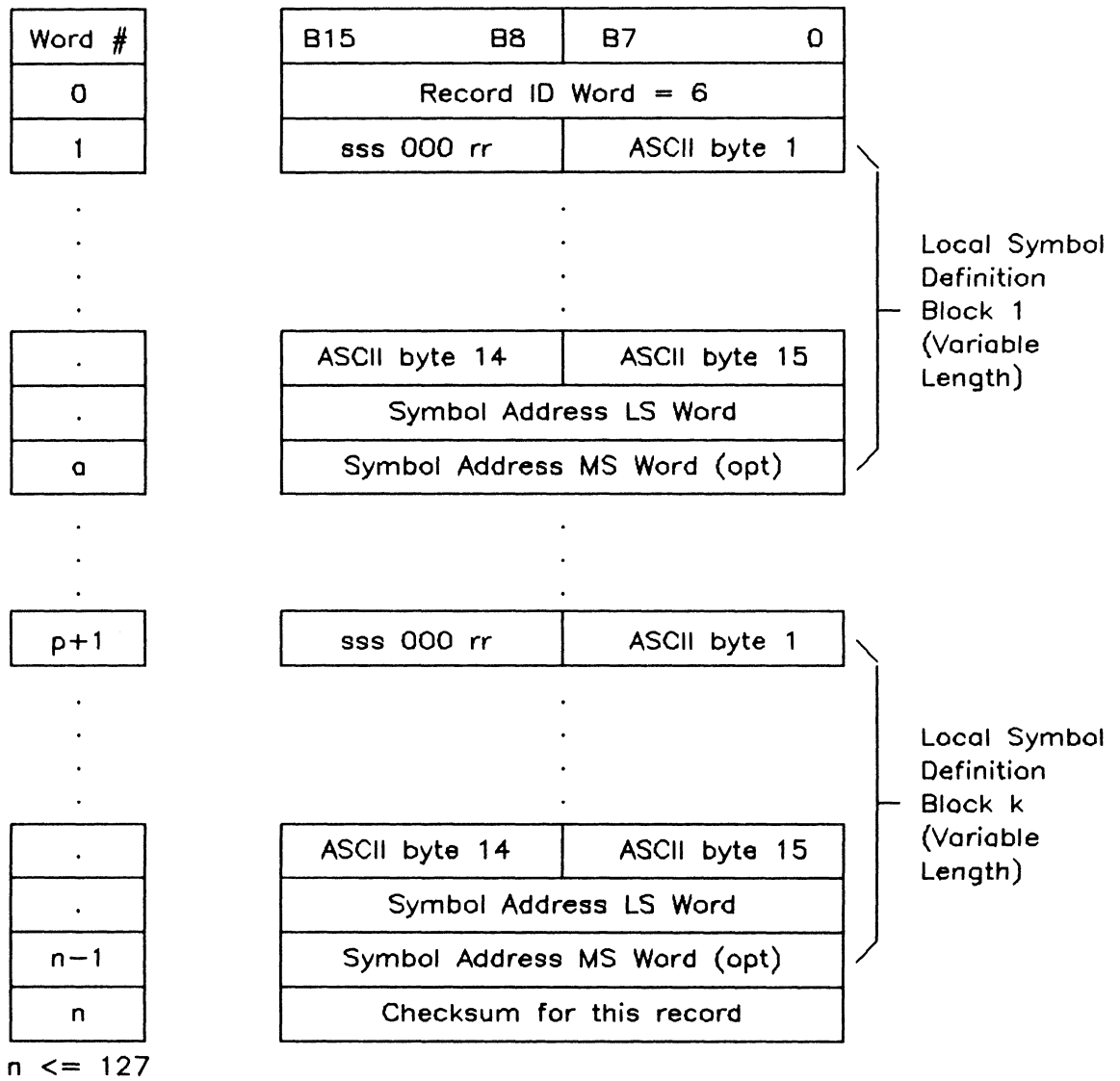

Figure 13-2. Assembler Symbol File -Assembler Symbol Record Format

**File Format
Reference Manual**

Chapter 14

LINKER SYMBOL FILE FORMAT

LINKER SYMBOL FILE (FILE TYPE 13)

A linker symbol (:link_sym) file is generated by the linker and it contains four types of records.

There is one Processor Configuration Record, which is used to configure the linker when only link_sym files are being linked. It is followed by one or more Global Symbol Records which provide global symbol names and their relocated addresses. Next, the linker symbol file contains one or more Relocatable Name Records, which provide the names of the relocatable files which created each segment in the absolute file. These are followed by one or more Memory Space Records which give lists of the memory bounds of each of the sections of code which were linked.

In the discussion of the linker symbol file format it is important to keep in mind the relationship between relocatable file names and relocatable file names. The name of the relocatable file that is assembled or compiled is also permanently saved in the Name Record of the Relocatable File (see description of Relocatable File Record Formats). Since files may be renamed, it is possible to have a relocatable file with a name that is different from the relocatable file name which was saved in the Relocatable Name Record. It is also possible to combine multiple relocatable files into a single relocatable file (a library.) In this case there is only one relocatable file name, but multiple relocatable file names are associated with the library.

Relocatable Names are specified in the Relocatable Name Record; File Names in the Memory Space Record.

For a pictorial representation of the linker symbol file format, see Figures 14-1 through 14-5.

80286 PROTECTED MODE LINKER

If you are using the 80286 protected mode linker, you will be interested in the additional record types at the end of this chapter. The additional records include types 22, 222 and 33. These records are discussed in detail in the section titled 80286 Protected Mode Linker Record Types.

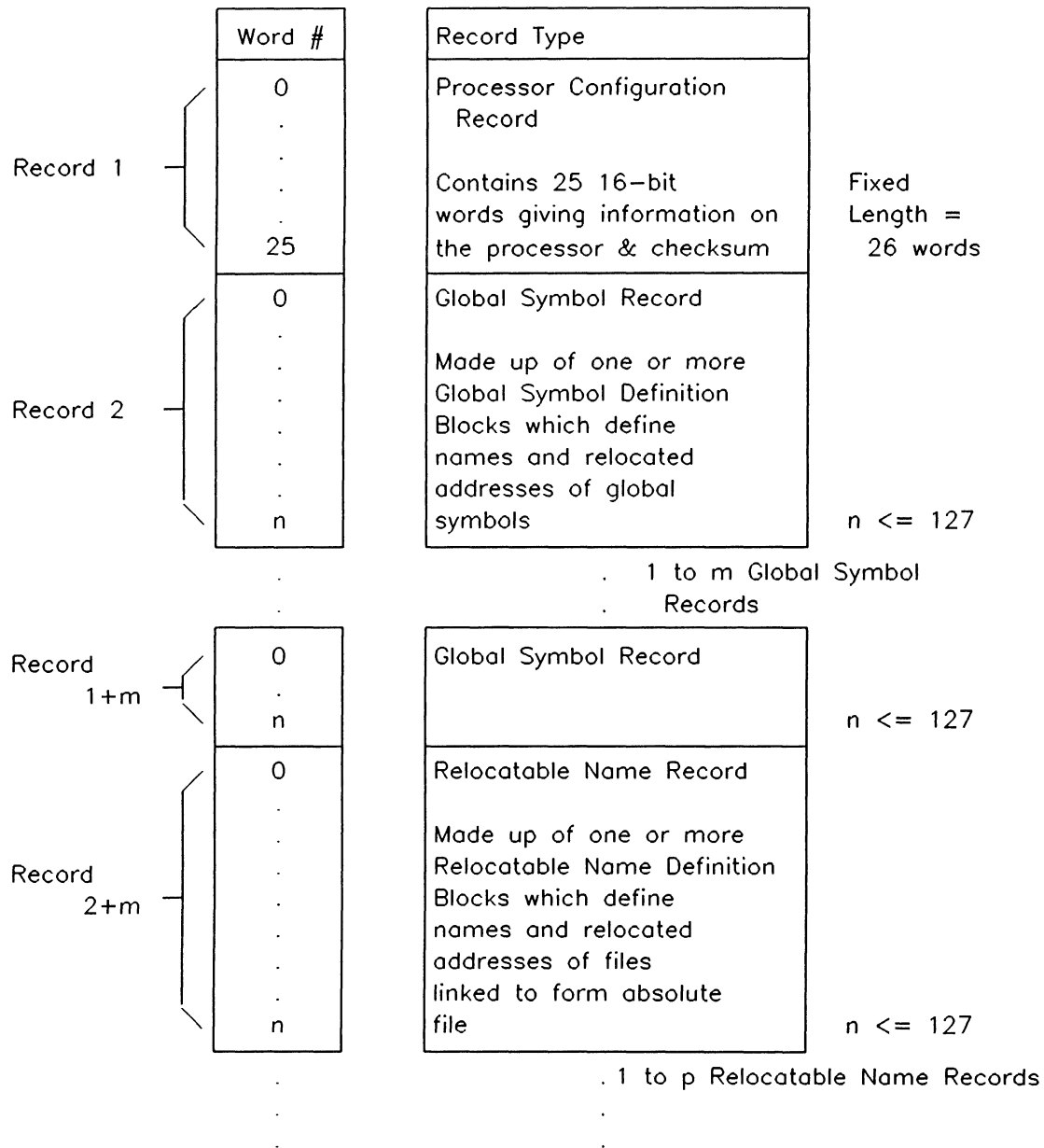

Figure 14-1. Linker Symbol File - Overall Structure
(Continued on next page)

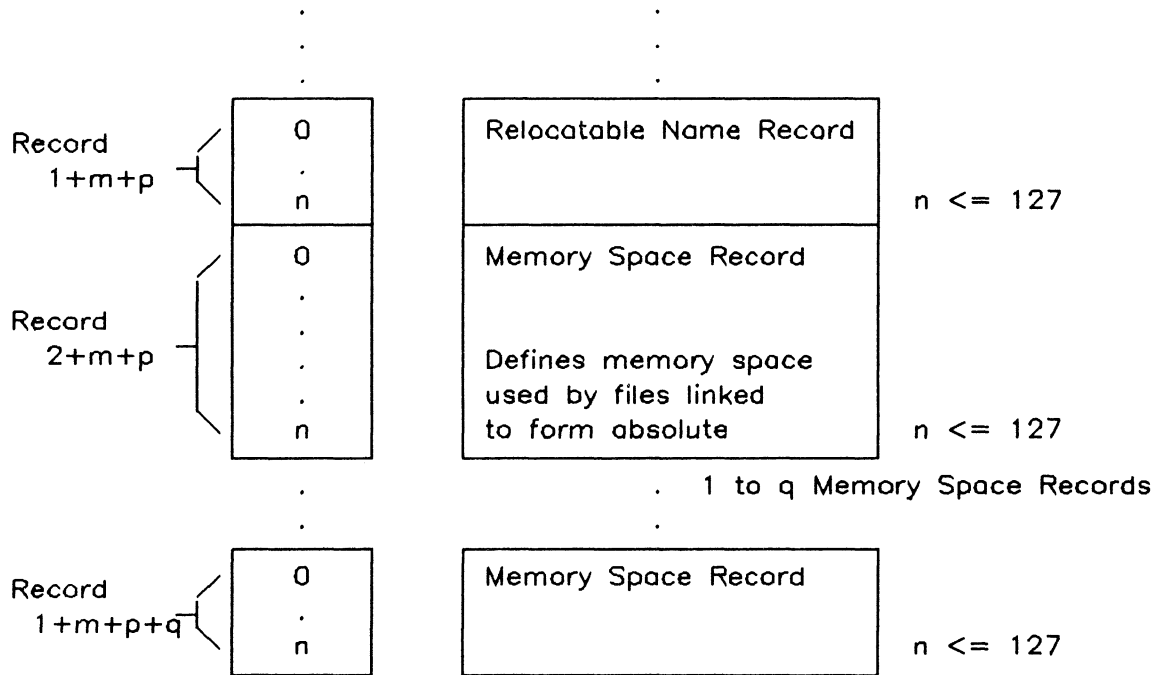

Figure 14-1. Linker Symbol File - Overall Structure (Cont'd)

PROCESSOR CONFIGURATION RECORD

WORD 0 - A Record ID of 1 is specified to indicate that this is a Processor Configuration Record. The Record ID is used internally to the linker symbol file and should not be confused with the 64000 System file type number, which is 13.

WORD 1-15 - These Pad Words containing all zeros are added so that Words 16-23 in this record match the corresponding words in the Name Records in 64000 System Relocatable files.

WORD 16-23 - This group of words is used to define the name of the linker table used to generate the corresponding absolute file. For a complete description of this block see Appendix C.

**File Format
Reference Manual**

WORD 24 - Hishift = a number of bits to be used as follows:

For conversion of 32-bit logical addresses consisting of a 16-bit segment and a 16-bit offset to physical addresses, the segment is loaded into the most significant 16 bits of a 32 bit register. It is then shifted RIGHT by the number of bits specified in Hishift and the resulting 32-bit number is added to the 16-bit offset value to obtain the physical address. (For the Intel 8086 and 8088 processors the value of Hishift is 12.)

Address Size is the number of words necessary to define microprocessor addresses. See Appendix A for a description of the number of address words needed for each processor. This field should always contain 1 or 2.

WORD 25 - The checksum word contains the arithmetic sum of the binary values of words 0 through 24.

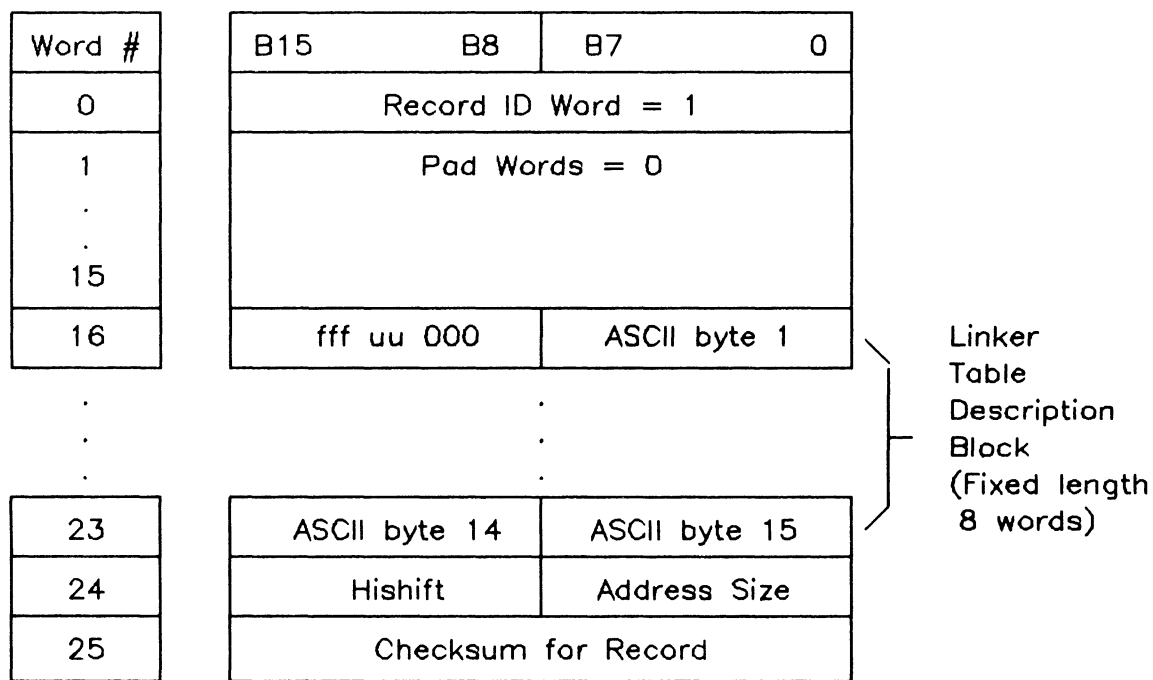

Figure 14-2. Linker Symbol File -Processor Configuration Record Format

GLOBAL SYMBOL RECORD

WORD 0 – A Record ID of 2 is specified to indicate that this is a Global Symbol Record. The Record ID is used internally to the linker symbol file and should not be confused with the 64000 System file type number, which is 13.

WORD 1 through $n-1$ make up the k Global Symbol Definition Blocks. These blocks describe the global symbols generated as part of the relocatable file. Each global symbol definition block has a variable length of from 2 to 10 words.

The structure of each Global Symbol Definition Block is:

WORD 0 through WORD sss (of a Global Symbol Definition Block) make up the Global Symbol Name Description Block. This block provides the name of the global symbol being defined. For a complete description of this block see Appendix D.

WORDS $sss+1$ and $sss+2$ (of a Global Symbol Definition Block) contain the value of the symbol. WORD $sss+2$ exists only in those processors which generate 2 words for each address (see Appendix A).

See the User-Definable Emulator Manual for more information about symbol usage in the UDE.

**File Format
Reference Manual**

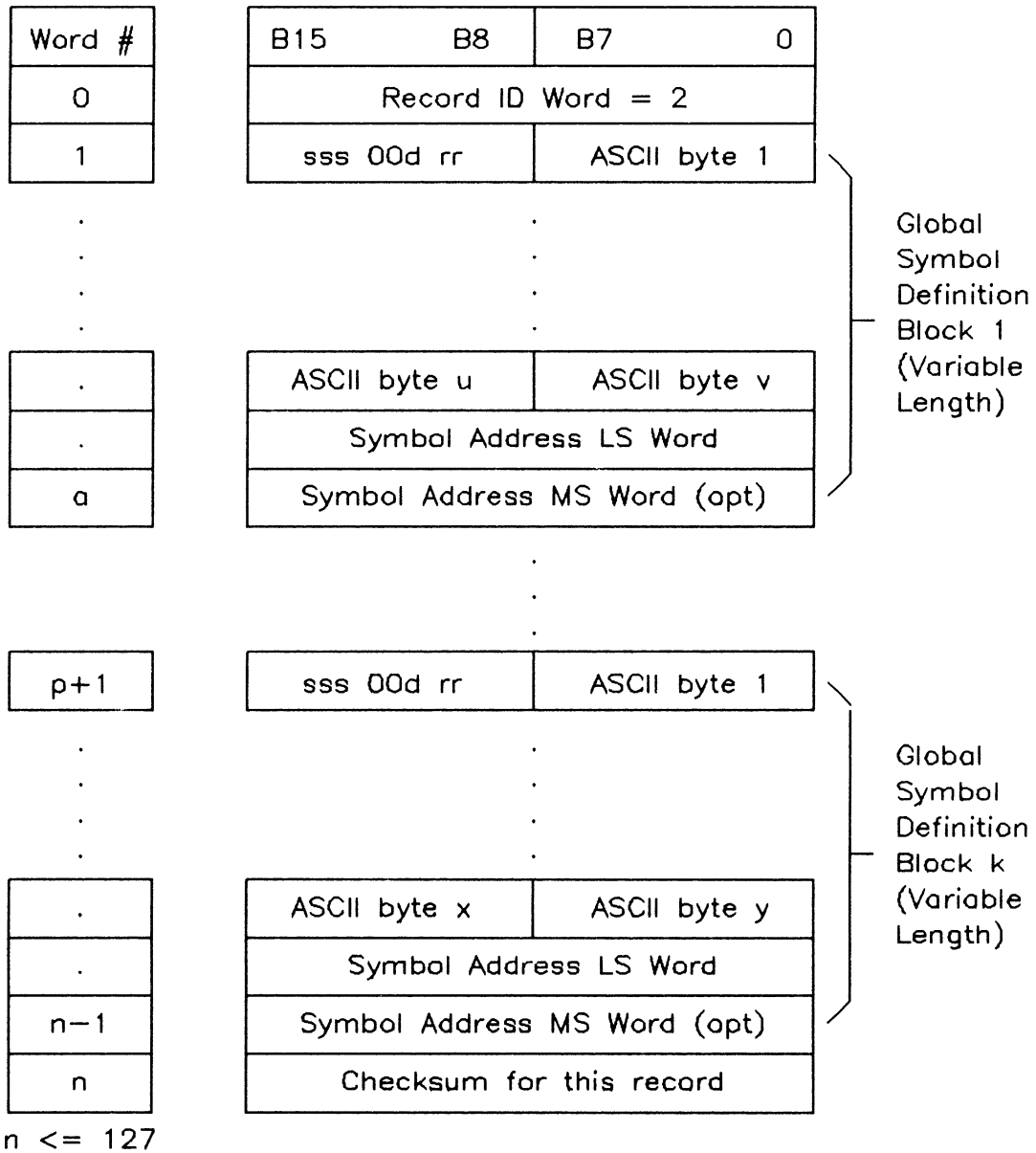

Figure 14-3. Linker Symbol File - Global Symbol Record Format

RELOCATABLE NAME RECORD

WORD 0 – A Record ID of 3 is specified to indicate that this is a Program Name Record. The Record ID is used internally to the linker symbol file and should not be confused with the 64000 System file type number, which is 13.

WORD 1 through n-1 make up the k Relocatable Name Definition Blocks. These blocks describe the relocatable files which generated the absolute files. Each relocatable name definition block has a fixed length of 14 words.

The structure of each Relocatable Name Definition Block is:

WORD 0 through WORD 7 make up the Relocatable Name Description Block. This block provides either the relocatable file name from which this absolute segment was generated or the file name of the library containing the relocatable code from which this absolute segment was created.

WORD 8-9 – The Program Load Address is the address in the microprocessor memory space into which the first byte of the code designated by the linker to reside in program space will be loaded. The remaining bytes of code will follow in subsequent memory locations. If the processor only requires one word of address (see Appendix A), the MSW should be filled with 0's.

WORD 10-11 – The Data Load Address is the address in the microprocessor memory space into which the first byte of the code designated by the linker to reside in data space will be loaded. The remaining bytes of code will follow in subsequent memory locations. If the processor only requires one word of address (see Appendix A), the MSW should be filled with 0's.

WORD 12-13 – The Common Load Address is the address in the microprocessor memory space into which the first byte of the code designated by the linker to reside in common space will be loaded. The remaining bytes of code will follow in subsequent memory locations. If the processor only requires one word of address (see Appendix A), the MSW should be filled with 0's.

**File Format
Reference Manual**

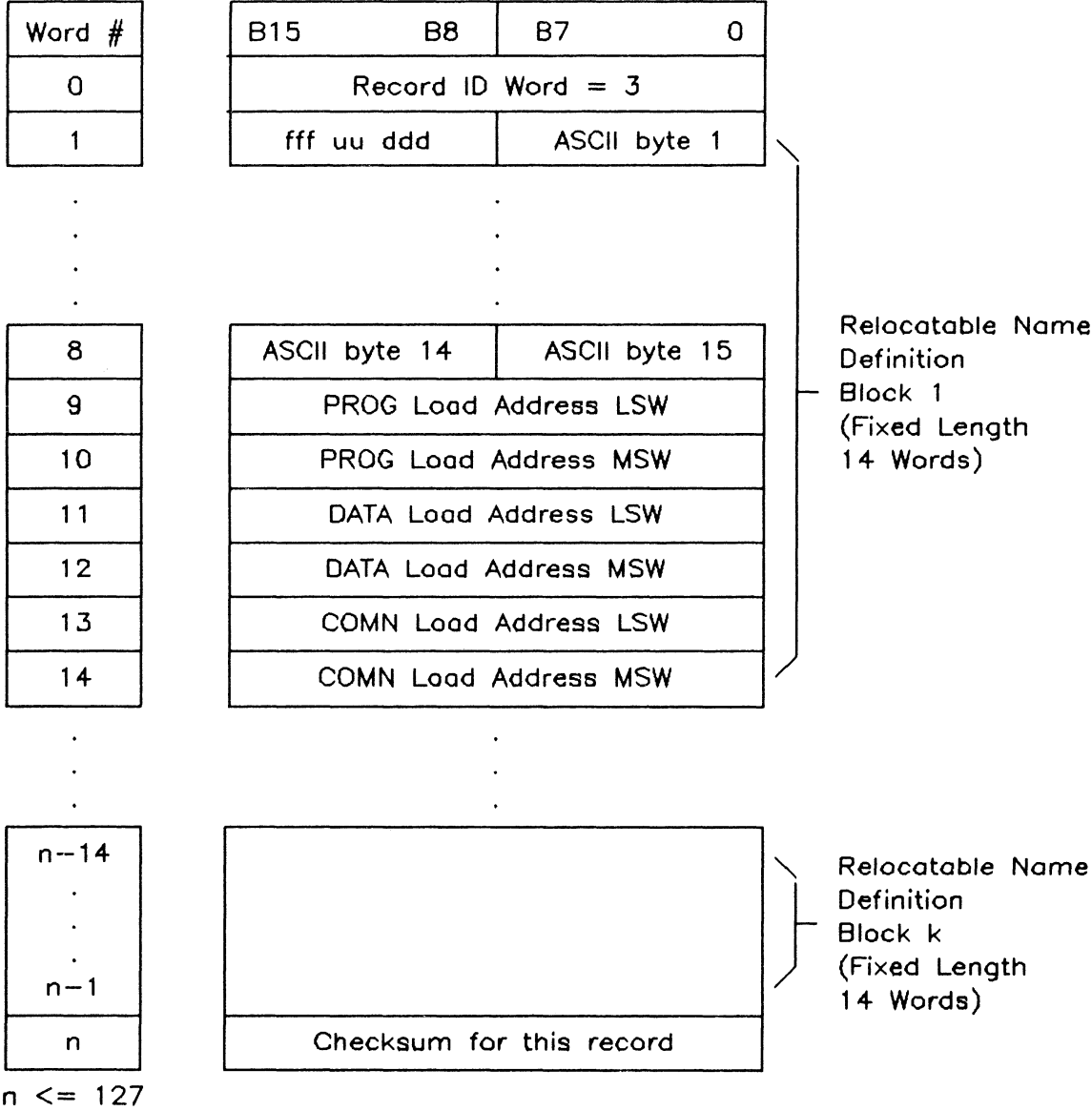

Figure 14-4. Linker Symbol File - Relocatable Name Record Format

MEMORY SPACE RECORD

There are one or more Memory Space Definition Blocks for each Relocatable Name Definition Block in the Linker Symbol File. If only Program space is occupied by the relocatable, then there will be one Memory Space Definition Block corresponding to the Relocatable Name Definition Block. If Program space and Data space are occupied, then there will be two Memory Space Definition Blocks for the Relocatable Name Definition Block, etc.

For absolute code, the Memory Space Definition Blocks contain the ORG'd addresses supplied in the Name Record of the 64000 System Relocatable File.

WORD 0 -A Record ID of 4 is specified to indicate that this is a Memory Space Record. The Record ID is used internally to the linker symbol file and should not be confused with the 64000 System file type number, which is 13.

WORD 1 through n-1 make up the k Memory Space Definition Blocks.

The structure of each Memory Space Definition Block is:

WORD 0-1 -The Low Bound Address is the Load Address as defined in the Relocatable Name Definition Block, or in the case of absolute code, the address as defined in the Absolute Code Segment Block of the Name Record in 64000 System Relocatable Files. It is keyed to either Program, Data, Common, or Absolute by the contents of the rr bits in WORD 4 of this block. If the processor only requires one word of address (see Appendix A), the MSW should be filled with 0's.

Memory Space Definition Blocks appear in the Memory Space Record in sorted order on the Low Bound Address, with the record with the smallest Low Bound Address appearing first, the next largest next, etc.

WORD 2-3 -The Hi Bound Address is the last address filled by the code which started at the Low Bound Address defined in WORD 1-2. If the processor only requires one word of address, the MSW should be filled with 0's.

**File Format
Reference Manual**

WORD 4 – The contents of Word 4 of each Memory Space Definition Blocks are broken down as follows:

Relocatable Index # – bits 15-2 – is obtained by numbering each of the Relocatable Name Definition Blocks in the Relocatable Name Record starting with the number 0. The Memory Space Definition Block is then tied to the Relocatable Name Definition Block by supplying its numerical order number in this field.

rr – bits 1,0 – a two bit field used to indicate the program counter with respect to which the code has been relocated. The meaning of the value is as follows:

- 00 – Absolute
- 01 – Program
- 10 – Data
- 11 – Common

WORD 5 through WORD 12 make up the Relocatable file Description Block. This block provides the name of the relocatable file from which this segment of the code was generated. For a complete description of this block see Appendix E.

WORD 13 – bits 14,13,12 (ddd) – contains the disc number where the file described in this block resides.

WORD 13 – All remaining bits are reserved for future use by the 64000 system and should contain 0's

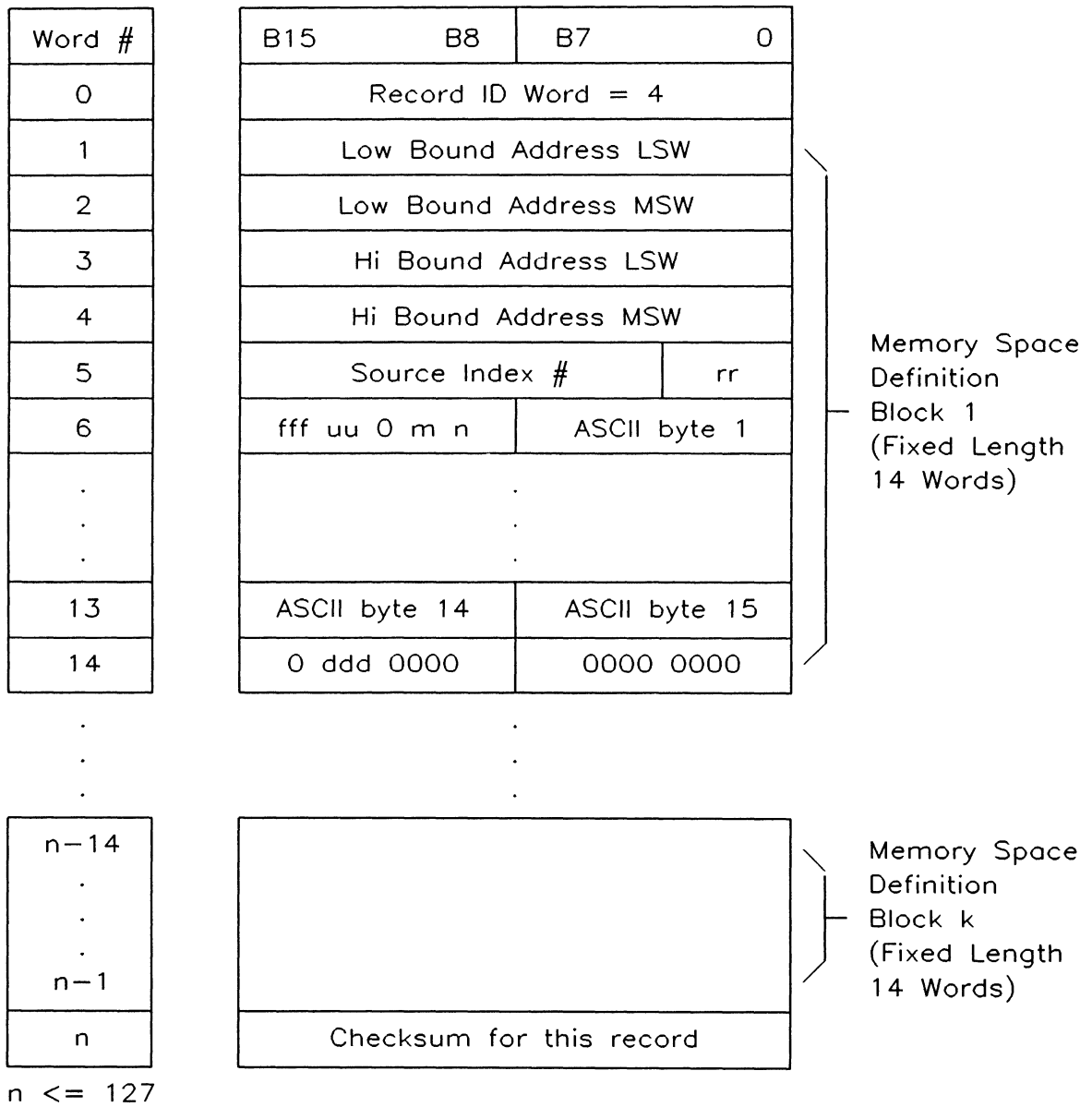

Figure 14-5. Linker Symbol File - Memory Space Record Format

80286 PROTECTED MODE LINKER RECORD TYPES

When you use the 80286 protected mode linker, three additional record types must be considered. These are record types 22, 222 and 33. |

Record types 22 and 222 are used in conjunction with Record Type 2 (Global Symbol Record). Record type 33 is used in conjunction with Record Type 3 (Relocatable Name Record). |

Examples on address calculations are included at the end of this chapter. |

Record type 22 contains all segments, gates, tables, and tasks (physical and virtual addresses) and appears as shown in Figure 14-6.

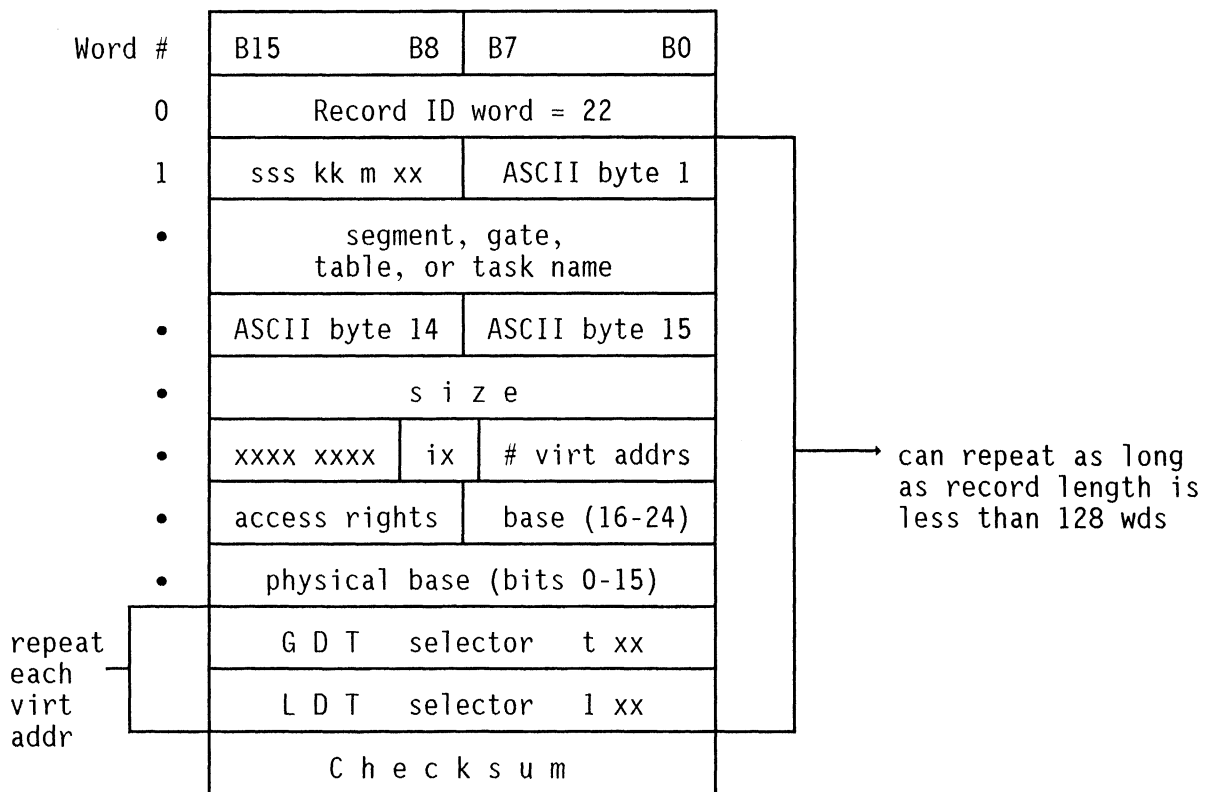

sss = size in words - 1

num virt addr = number of virtual addresses

m = 0 if segment in protected mode
1 if segment in real mode

kk : kind of symbol
00 = segment
01 = gate
10 = table
11 = task

t = table indicator
0 = GDT (LDT sel = 0)
1 = LDT (GDT sel = TSS)

xx = don't care -- ignore

i = is 80286 bit
0 = not 80286 file
1 = 80286 source file

Figure 14-6. Record Type 22 - 80286 Protected Mode Linker

**File Format
Reference Manual**

Record type 222 contains all public symbols and their physical and virtual addresses and will appear as shown in Figure 14-7.

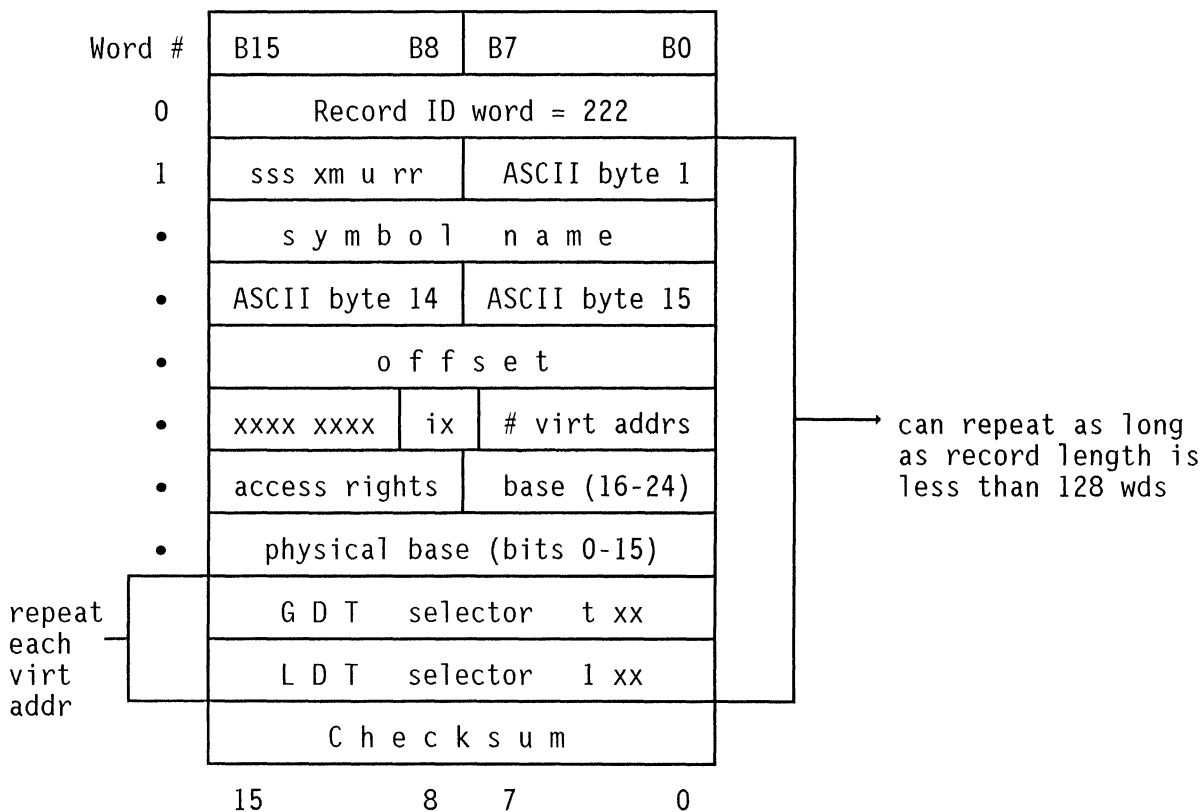

sss = size in words - 1

num virt addr = number of virtual addresses

u = 1 if undefined symbol

rr = relocation
 00 = absolute
 01 = prog
 10 = data
 11 = common

t = table indicator
 0 = GDT (LDT sel = 0)
 1 = LDT (GDT sel = TSS)

xx = don't care -- ignore

i = is 80286 bit
 0 = not 80286 file
 1 = 80286 source file

m = 0 if segment in prot. mode
 = 1 if segment in real mode

Figure 14-7. Record Type 222 - 80286 Protected Mode Linker

Record type 33 in the link_sym files contains all source names and their relocation addresses. The primary use for these records is to provide relocation addresses for the symbols in asmb_sym files (see figure 14-8).

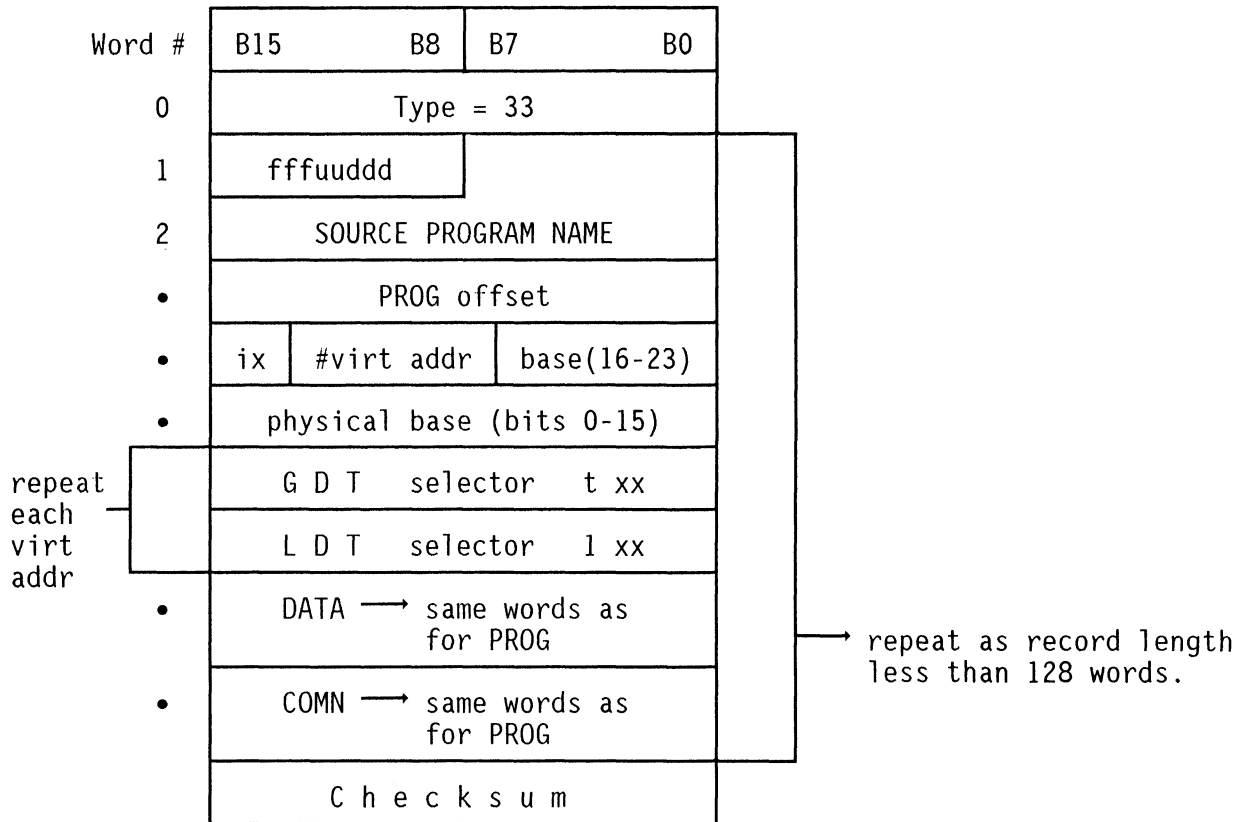

fff = wds in filename - 1

num virt addr = number of virtual addresses

uu = wds in uid - 1

t = table indicator

ddd = disc # of source

0 = GDT (LDT sel = 0)

1 = LDT (GDT sel = TSS)

xx = don't care -- ignore

i = is_80286 bit

0 = not 80286 file

1 = 80286 source file

Figure 14-8. Record Type 33 - 80286 Protected Mode Linker
(Continued on next page)

"fffuuddd" explanation:

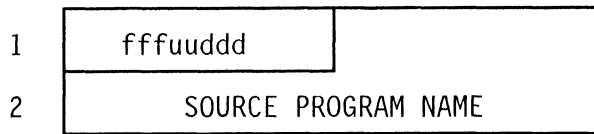

Where "fffuuddd" is indicated, a fixed-length HP 64000 name field is required.

The fixed-length format field is always 8 words. The first byte indicates the number of additional words. The second byte begins the NULL terminated string which is the name.

Figure 14-8. Record Type 33 - 80286 Protected Mode Linker (Cont'd)

Address Calculation Examples

GLOBAL SYMBOL. For global symbols, look at the link_sym file. Check all records with record type 222. When the symbol name is found, both the virtual address and physical address are present.

LOCAL SYMBOL. For local symbols, first look at the asmb_sym file. When you find the symbol name, look at the two relocation bits (rr). There are now two possibilities:

- A. rr indicates an absolute segment (record type 6, rr = 00):
This case has not changed at all. You have the complete address at your fingertips.
- B. rr indicates PROG, DATA, COMN (record type 6):
Index into the link_sym file searching record type 33's until you find the appropriate source file name. You now have the virtual address and physical base for the segment. This, along with the offset from the asmb_sym file and the offset from the current record (33), gives you the virtual and physical address of the symbol.

Chapter 15

TEMPORARY FILE FORMAT

TEMPORARY FILE (FILE TYPE 800H - 8FFH)

REGULAR TEMP FILES

Temporary files are created in several ways, but are rarely seen by the user. A temporary file will exist on a disc if someone is using one of the modules which uses a temporary file. In the normal course of events, that temp file will disappear when the process is finished. However, if the 64000 station is powered off, or a shift RESET is performed, the temporary files may remain on the disc. A temporary file is always associated with a System Bus address, so that in order to get rid of a temp file one must work at the station with that System Bus address.

SPECIAL TEMP FILES

scratch1N:HP, scratch2N:HP, Ndestfile:HP, Ntempfile:HP

One process that uses temporary files is the editor. Editor temporary files may have one of the following names, scratch1N:HP, scratch2N:HP, Ndestfile:HP, or Ntempfile:HP. In all these cases, N is the System Bus address of the station which created the file. If an editor temporary file remains on your disc, get into the editor, perform the action listed below and then end or RESET RESET out of the file. (NOTE: do NOT shift RESET) If the temporary file is a Ntempfile:HP you will need to do a copy or extract in the editor. If the temporary file is a scratchxN:HP, try merging a large file or paging back and forth in a large file.

sym__N:default userid

Emulation will use temporary files for sorting symbols. The file name associated with an emulation temp file is sym__N:HP where N is the System Bus address of the station. To get rid of this file, get into emulation and display local__symbols or display global__symbols. The file should be gone when you get out of emulation.

Chapter 16

DEVICE FILE FORMAT

DEVICE FILE (FILE TYPE 8000H-8FFFH)

Device files are dummy files used by the file manager system so that the printer, display, and HPIB input and output can be treated in the same manner as disc files. Information regarding the devices is kept in the file directory under a name selected for that device. File names for the devices are:

```
printer:HP  
display:HP  
hpibi:HP (HPIB input)  
hpibo:HP (HPIB output)
```

The device files `printer:HP` and `display:HP` can be accessed using Simulated I/O and the copy command. The files `hpibi:HP` and `hpibo:HP` can only be accessed using the copy command in a standalone system. For more information on accessing these files, see the System Software Reference Manual for information about the copy command, and any emulation manual for information about Simulated I/O.

Chapter 17

THE COMPILER DATABASE FILE

INTRODUCTION

The compiler database file is generated during a link with the option `comp_db` set. It contains information about all the high level language symbols defined within a given high level language source file. The linker will generate a compiler database file for each file it links that has a corresponding compiler symbol file.

The compiler database file is created from three separate sources:

1. The compiler symbol file which is written out to a disc file during pass 1 of a compile with option `comp_sym` set.
2. The assembler symbol file which is created by pass 3 of the compiler.
3. The linker symbol table file which is created by the linker.

The compiler database file is organized into 2 major components. The first is the index information which contains information about where the data for a particular procedure is located within the file. The second is the actual symbol information.

INDEX INFORMATION

The items that can be indexed are the program level symbols as well as the procedure and function information. The given procedure to be found can be located using the procedure name, the subroutine number, or a static address.

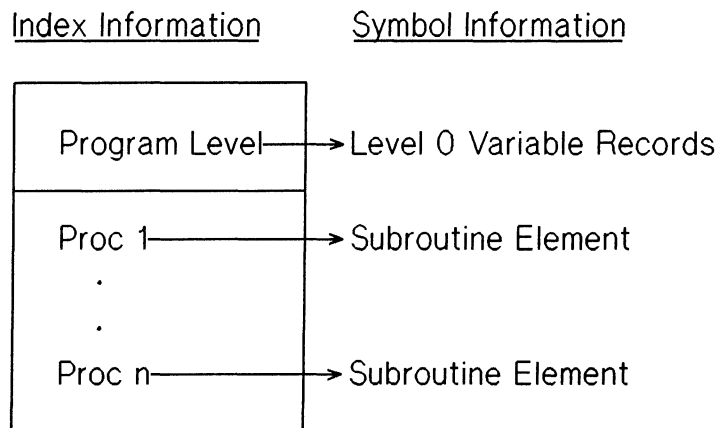
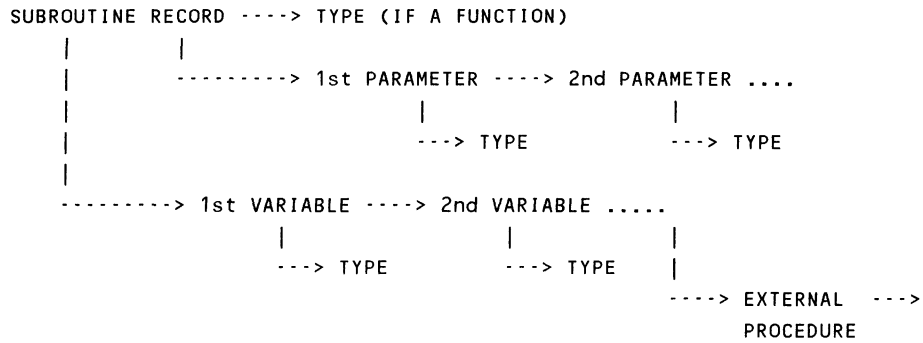

Figure 17-1. File Organization

SYMBOL INFORMATION

SUBROUTINE ELEMENT

Subroutine elements contain information for all the symbols defined within a procedure or function with the exception of labels, line numbers and interblock variables. The variables and parameters are sorted by physical address.



LEVEL 0 VARIABLE RECORDS

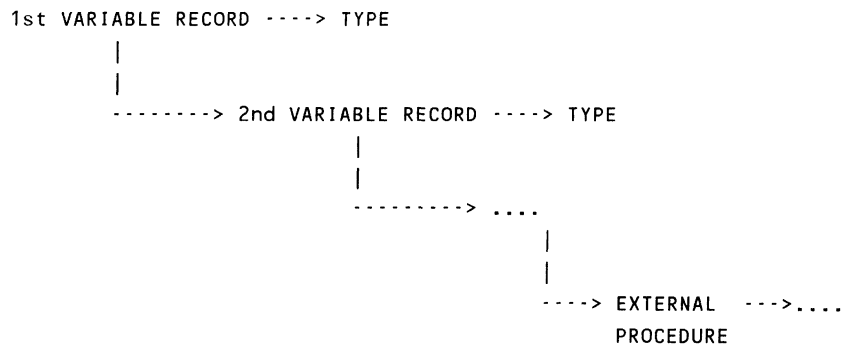

SPECIFIC RECORDS

ABSOLUTE FILE RECORD - this is the first record in the database. It indicates which absolute file the database file has been mapped to. It also indicates which software revision number was used to create the compiler database file.

Words 0 thru 7 - the absolute file used to build the comp_db file. A given compiler database file can only be mapped to one absolute file at a time. The filename is in standard HP 64000 filename format (the upper 3 bits are the length in words-1 of the file name and the next 2 bits are the length in words of the userid).

Word 8 - is the disc number of the absolute file.

Word 9 - is the revision number of the software that created the compiler database file. The current revision number = 1. This number will be incremented if the format of this file is modified.

Word #	Record Type
0	Absolute File Name (8 Words)
1	.
2	.
3	.
4	.
5	.
6	.
7	.
8	Absolute File Disc Number
9	Rev No

Figure 17-2. Absolute File Record

PROGRAM FILE RECORD - this contains global information about the program that was compiled.

- Word 0 - the size in words of the index table.
- Word 1 - used internally and always set to 0.
- Word 2 - the upper byte is processor code of the compiler. The following codes are currently supported:

PROCESSOR	ID CODE
80186/8	4
8086/8	12
68000/10/8	13

The lower byte is the disc number of the source file that the compiler database file was generated from.

- Word 3 - the language that the source file was written in, (0 = PASCAL, 1 = C).
- Words 4 and 5 - the starting address of the first opcode in the file.
- Words 6 and 7 - In PASCAL this is the smallest static variable address of variables defined at the program level. In C it is the smallest static variable address in the file.
- Words 8 and 9 - In PASCAL this is the largest static variable address of variables defined at the program level. In C it is the largest static variable address in the file.
- Words 10 and 11 - In PASCAL it is the main program's entry address. In C it is always zero.
- Words 12 and 13 - In PASCAL it is the main program's exit address. In C it is always zero.
- Words 14 to 21 - the name of the source file that the compiler database was generated for in standard HP 64000 filename format (always 8 words).
- Words 22 to 29 - In PASCAL this is the name of the main program. If the file has no main program or if it is a C program, then word 22 is 0020H.

Word #	Record Type	
0	Index Table Size	
1	Index Table PTR	
2	Processor ID	Disc No
3	Language No	
4	Prog Load Addr MSW	
5	Prog Load Addr LSW	
6	Min Static Var Addr MSW	
7	Min Static Var Addr LSW	
8	Max Static Var Addr MSW	
9	Max Static Var Addr LSW	
10	MSW Entry Address	
11	LSW Entry Address	
12	MSW Exit Address	
13	LSW Exit Address	
14	Name&UID Length	Char
	Char	Char
	.	
	.	
21	Char	Char
22	LEN-1	Char
	Char	Char
	.	
	.	
29	Char	Char

Figure 17-3. Program File Record

INDEX TABLE RECORDS - this set of records is the index into the rest of the file. The index table can span several records. Removing the record lengths at the start of each record and appending the records together will produce the image of the index shown below. The maximum size of the index is 3829 words [$(15 * 255) + 4$] since the compiler will support a maximum of 255 procedures in a given file. Words 4 - N are reproduced for each procedure/function defined within the file.

- Word 0 - the number of words in the index table.
- Word 1 - the disc record number in this file to position to. This word is used to find the symbol information about program level symbols in PASCAL. In C, it is also used to find the symbols that are defined outside of any function. The disc records are numbered starting with 1.
- Word 2 - the number of records that make up the program level symbols. Zero indicates that there are no program level symbols.
- Word 3 - unused, initialized to 0.
- Word 4 - the upper byte is the subroutine number of the procedure/function that the following words apply to. Each procedure/function has a unique number starting with 1. The lower byte is the number of words that this procedure/function entry occupies.
- Word 5 - the disc record number to position to. This word is used to find the procedure function symbol information, starting with 1.
- Word 6 - the number of words (starting from this word and not counting record length words), to where the parent procedure/function entry is in the index table. A negative number indicates that the offset words are in front of the current word, while a positive number indicates the offset words are following the current word. Zero indicates that this procedure is defined at the outer most level.
- Words 7 & 8 - the minimum static address of any variable defined within the procedure.
- Words 9 & 10 - the maximum static address of any variable defined within the procedure.
- Words 11 - N - the name of the procedure/function in standard HP 64000 format (length-1 in words in the most significant 3 bits).

Word #	Record Type	
0	Size of Index	
1	Vars Disc Loc	
2	Size (# of Records)	
3	Unused	
4	Subr Number	Entry Len
5	Disc Rec No	
6	Parent Offset	
7	Min Static MSW	
8	Min Static LSW	
9	Max Static MSW	
10	Max Static LSW	
11	LEN-1	Char
	Char	Char
	.	
	.	
	Char	Char
N	Next Procedure Name	
	.	

Figure 17-4. Index Table Record

SUBROUTINE RECORD - this is the header record for the symbols that are defined within a procedure/function. The header will always start on a disc record boundary.

Word 0 - the upper byte is the level number of the procedure/function with level 1 being the outermost level. A procedure nested within a level 1 procedure would be at level 2. The lower byte is the type of procedure. REC_TYPE = 0 implies a procedure and REC_TYPE = 1 implies a function.

Word 1 - consists of bit flags with the following definitions:

BIT NO	VALUE MAPPING	DESCRIPTION
0 =	static/recursive : 1/0	recursive if the option has been set
1 =	global/notglobal : 1/0	global option set
2 =	variable/fixed parms : 1/0	always 0 for PASCAL
3 =	static addr symbol = 0	procedure address is always static
4 =	interrupt/non interrupt: 1/0	if the procedure is an interrupt

BITS 13 - 15 APPLY ONLY TO CERTAIN PROCESSORS

BIT NO	VALUE MAPPING	DESCRIPTION
13 =	far proc/near proc 1/0	far proc if calls and returns must be
14 =	ptr size 32/ptr size 16 1/0	32 bits
15 =	align on/align off 1/0	

Word 2 - the unique subroutine number of this procedure (1 to 255). This is the same as for the index table.

Word 3 - the number of words (starting from this word and not counting record length words), to where the first parameter record begins. Zero indicates that the procedure/function has no parameters. A negative number indicates that the offset words are in front of the current word, while a positive number indicates the offset words are following the current word.

Word 4 - the offset to the record that defines the function return value type. This word is 0 for procedures.

Word 5 - the offset to the first variable defined within the procedure, or if no variables are defined, this word represents the first external procedure defined. If the procedure/function has no variables or external procedures, then the offset is 0.

Words 6 & 7 - the address of first opcode within the procedure.

Words 8 & 9 - the address of the start of the last opcode within the procedure.

Words 10 & 11 - the last address defined within the procedure.

Word 12 - the number of bytes of data allocated to the procedure.

Word 13 - processor and language specific value relating the base pointer location on the stack to the static link pointer.

- Word 14 - the offset in bytes from the first opcode address within the procedure to the first opcode address of user code within the procedure.
- Word 15 - the offset in bytes from the first non-user code at the end of the procedure to the start of the last opcode within the procedure.

Word #	B15	B8	B7	0
0	LEVEL		REC_TYPE	
1	F15 F14 F13		F3 F2 F1 F0	
2	Subroutine Number			
3	1st Parm Offset			
4	Func Type Offset			
5	1st Var Offset			
6	Entry Address MSW			
7	Entry Address LSW			
8	Exit Address MSW			
9	Exit Address LSW			
10	End Address MSW			
11	End Address LSW			
12	Data Size			
13	Static Link Offset			
14	Entry Offset			
15	Exit Offset			

Figure 17-5. Subroutine Record

VARIABLE RECORD - this record defines the start of a variable definition. It does not have to start on a disc record boundary and may cross disc record boundaries. This is also true for all the remaining records.

Word 0 - the upper byte is number of bytes contained within this record. the lower byte is the record type. REC_TYPE = 2 implies that th a variable. REC_TYPE = 6 implies that this record is for a parameter.

Word 1 - bits flags with the following meanings:

BIT NO	VALUES	DESCRIPTION
0 =	external/not external :1/0	
1 =	global/not global :1/0	
2 =	relocatable/absolute :1/0	
3 =	dynamically activated/not :1/0	it is dynamic if it is only created at run time
4 =	name refer/value refer :1/0	passed by value or by reference
5 =	subroutine/not :1/0	if the symbol is a parameter then it could be a subroutine
6 =	procedure/function :1/0	if the symbol is a subroutine then which type

Word 2 - if bit 5 is set in word 2 then this is the offset in words to find the first parameter, otherwise it is 0.

Words 3 & 4 - if the variable is not dynamic (bit 3 = 0) then this is the address of the location of the variable. If the variable is dynamic (bit 3 = 1) then this is the offset from the base pointer to the location of the variable on the stack. If the variable is a reference parameter (bit 4 = 1), then it is the address on the stack for locating the address.

Word 5 - the number of words from this location in the file to position to. This word is used to locate the record that describes the type of the variable.

Word 6 - the number of words to position to from this location in the file to get to the next variable record for this procedure. If no more variables exist, then it is an external procedure defined within the procedure. If there are no more variables or external procedures then this word is 0.

Words 7 & 8 - the size of the variable in number of bytes. If (bit 4 = 1) then it is the number of bytes that address takes up on the stack.

Words 9 - N - the name of the variable in HP 64000 standard format (length in words -1 in first 3 bits).

Word #	B15	B8	B7	0	REC TYPE:
0	REC SIZE		REC_TYPE		parameter = 6 variable = 2
1	F6 F5 F4 F3 F2 F1 F0				if parameter is a function (value of zero when not applicable)
2	Sub Param Offset				
3	Addr or Stack Offset (MSW)				
4	Addr or Stack Offset (LSW)				
5	Type Offset				
6	Next Offset				
7	Size (MSW)				
8	Size (LSW)				
9	LEN-1		Char		
	.				
N	Char		Char		

Figure 17-6. Variable Record

EXTERNAL PROCEDURE RECORD - these records are at the end of the chain of variable records. There is one for each external procedure defined within the procedure.

- Word 0 - the upper byte is the size in bytes of this record. The lower byte is the record type = 15.
- Word 1 - the number of words to position in the file to the beginning of the function return value type record. This word is 0 for an external procedure.
- Word 2 - the unique subroutine number (1 to 255).
- Word 3 - the number of words to position in the file to the first parameter defined for this procedure/function.
- Word 4 - the number of words to position in the file to the next external procedure record.
- Words 5 - N - the procedure name in standard HP 64000 format (length in words -1 in first 3 bits).

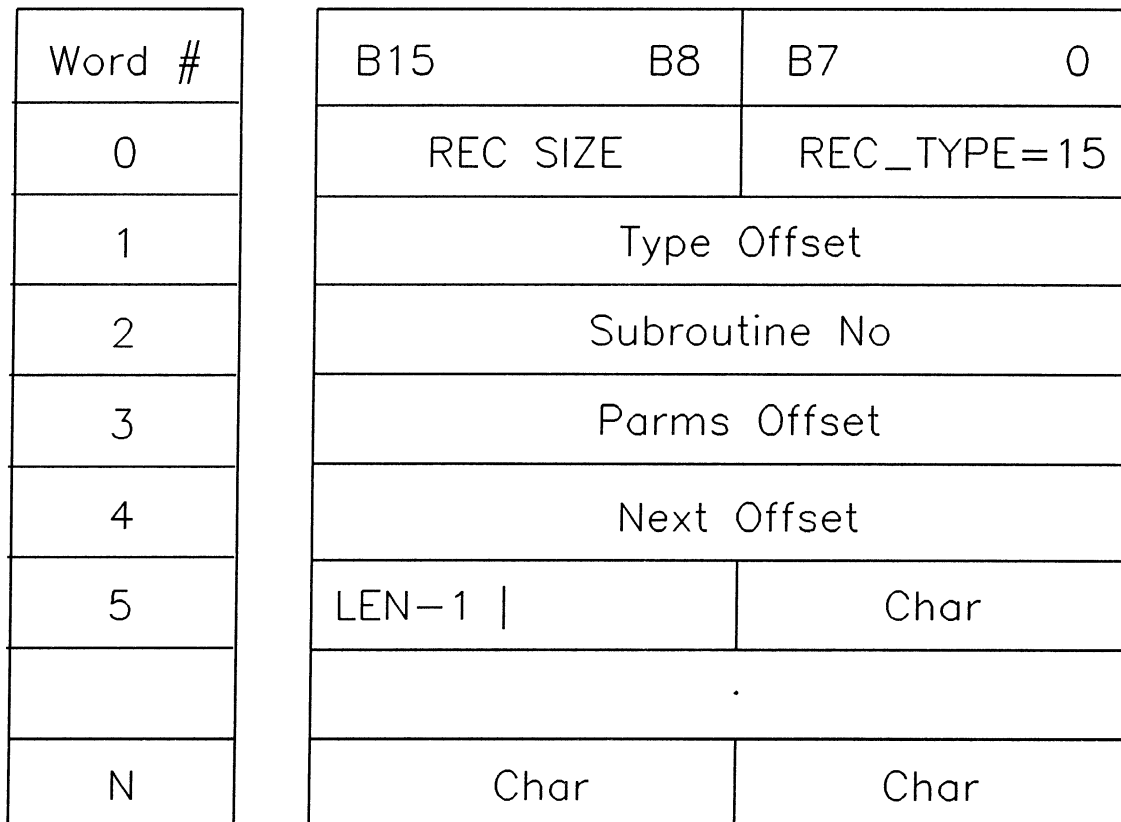

Figure 17-7. External Procedure Record

TYPE RECORDS (SCALAR) - this record defines a scalar type.

- Word 0 - the lower byte is the record type = 7.
- Word 1 - the size of this type in number of bytes.
- Word 2 - the size of this record in words.
- Words 3 & 4 - the value that corresponds to the first scalar.
- Words 5 thru N - the name corresponding to the above value in HP 64000 standard format (length in words -1 in first 3 bits).
- Words N+1 - N+2 - words 3 and 4 are repeated for each scalar value defined for the scalar type.
- Words N+3 thru M - words 5 through N are repeated for each scalar name defined for the scalar type.

Word #	B15	B8	B7	0
0			REC_TYPE=7	
1	Size of Structure			
2	Size of This Record			
3	First Scalar Value MSW			
4	First Scalar Value LSW			
5	LEN-1		Char	
	.			
	.			
N	Char		Char	
N+1	Second Scalar Value MSW			
N+2	Second Scalar Value LSW			
	LEN-1		Char	
	.			
	.			
M	.			

Figure 17-8. Type Record (Scalar)

TYPE RECORDS (SUBRANGE) - this record defines a subrange type.

- Word 0 - the upper byte indicates if the subrange is signed or not. 0 = unused (use integer sign value), 1 = signed, 2 = unsigned. The lower byte is the record type = 8.
- Word 1 - the size of this type in number of bytes.
- Word 2 - the number of words to position to the start of the subtype that this subrange consists of. Allowed subtypes are only scalar or integer types.
- Words 3 & 4 - the smallest value allowed in the subrange.
- Words 5 & 6 - the largest value allowed in the subrange.

Word #	B15	B8	B7	0
0	S/U		REC_TYPE=8	
1	Size of Structure			
2	Type Offset of Subrange			
3	Min MSW			
4	Min LSW			
5	Max MSW			
6	Max LSW			

Figure 17-9. Type Record (Subrange)

TYPE RECORD (POINTER) - This record defines a type that is a pointer to another type.

Word 0 - the lower byte is the record type = 9.

Word 1 - is the size of the pointer in bytes.

Word 2 - the number of words to position to in the file to find the start of the type that this pointer points to.

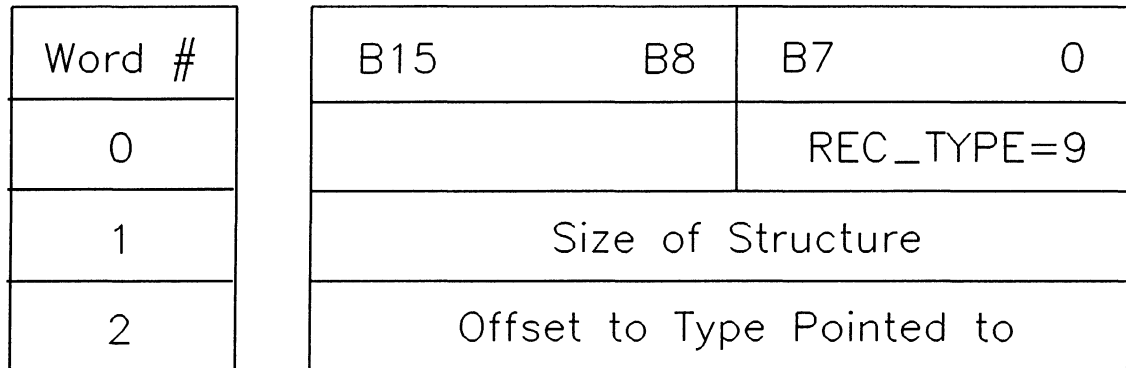

Figure 17-10. Type Record (Pointer)

TYPE RECORD (SET) - this is a PASCAL type referring to the PASCAL type of set.

Word 0 - the record type of a set = 10.

Word 1 - the size of the set in bytes.

Word 2 - the number of words to position to in the file to find the type of element that makes up this set.

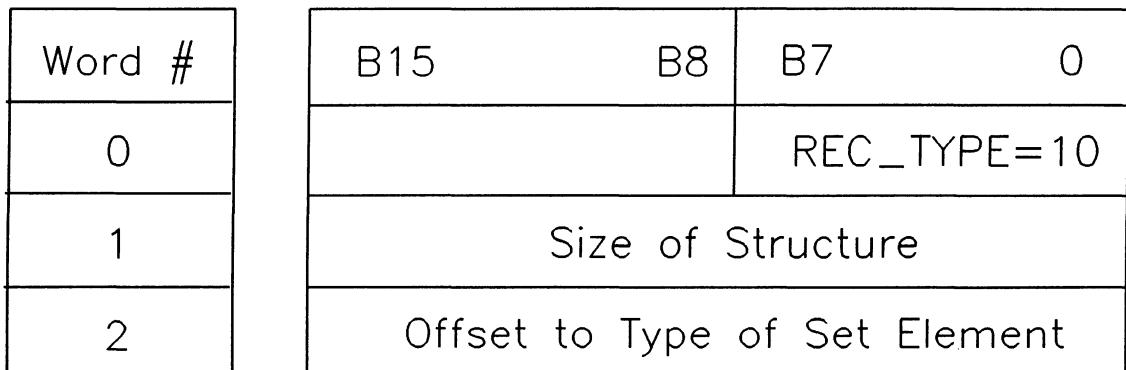

Figure 17-11. Type Record (Set)

TYPE RECORD (ARRAY) - This record defines the type array. It does not support packed arrays.

- Word 0 - this is the record type = 11.
- Word 1 - is the size of the array in bytes.
- Word 2 - is reserved for future use.
- Word 3 - is the number of words to position to in the file to find the type of the elements in the array.
- Word 4 - is the number of words to position to in the file to find the type of the index of the array.
- Words 5 & 6 - is the minimum value of the index. In C this is always 0.
- Words 7 & 8 - is the maximum value of the index.

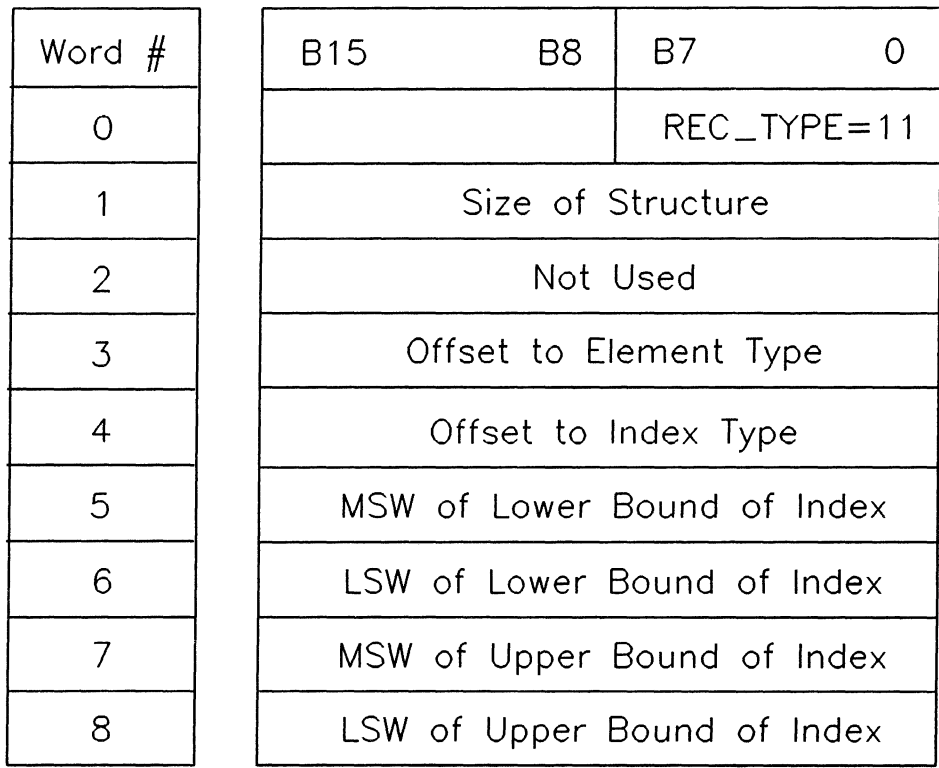

Figure 17-12. Type Record (Array)

TYPE RECORD (RECORD) - this record is always the first record pointed to when referring to a PASCAL record type, a C structure type, or a C bit field.

Word 0 - is the record type = 12.

Word 1 - is the size of the record or structure type in types.

Word 2 - is not used.

Word 3 - the number of words to position to in the file to find the first field record for this record.

Word #	B15	B8	B7	0
0	REC_TYPE=12			
1	Size of Structure			
2	Not Used			
3	1st Field Offset			

Figure 17-13. Type Record (Record)

TYPE RECORD (RECORD FIELD PTR) (MEMBER TYPE) - this record describes the individual field names of a record or the member names of a structure.

- Word 0 - the upper byte is the number of bytes in this record. The lower byte is the record type = 3.
- Words 1 & 2 - the number of bytes from the start of the record to the start of this field or member.
- Word 3 - the number of words to position to in this file to find the next field or member defined within this record. If this word is 0, then no more fields exist.
- Word 4 - the number of words to position in the this file to find the type of this field or member.
- Words 5 & N - the name of the field or member in standard HP 64000 format (length in words -1 in first 3 bits).

Word #	B15	B8	B7	0
0	REC SIZE		REC_TYPE=3	
1	MSW of Rec Offset			
2	LSW of Rec Offset			
3	Offset to Next Field			
4	Type Offset			
5	LEN-1		Char	
	.			
	.			
N	Char		Char	

Figure 17-14. Type Record (Field Names and Member Names)

TYPE RECORD (SELECTOR RECORD) (TAG) - This record indicates that different records have the same offset as in variant records in PASCAL or unions/bit fields in C. Each time multiple records are at the same location, a selector record will appear at the correct location in the field list. In PASCAL the selector record will be at the end of a field list. In C it is found where the union or bit field starts.

- Word 0 - bit 8 = 0 selector is for a union or variant record. Bit 8 = 1 indicates that the selector is for a C bit field. The lower byte is the record type = 13.
- Words 1 & 2 - the offset in bytes from the start of the record to the start of this selector (union,variant, or bit field).
- Word 3 - number of words to position in the file to find the next field record in the field list. A zero indicates no more fields follow.
- Word 4 - number of words to position in the file to find the start of the variant record.
- Word 5 - the tag field indicator. If this word = 0 then the last field was not a tag field for this selector. If this word = 1 then the last field was a tag field.
- Words 6 & 7 - used internally and will always appear as 0 in the file.

Word #	B15	B8	B7	0
0		X	REC_TYPE=13	
1	MSW of Rec Offset			
2	LSW of Rec Offset			
3	Offset to Next Field			
4	Variant Record Offset			
5	Tag Field Indicator			
6	Selector Flag			
7	Selector Value			

Figure 17-15. Type Record (Selector)

TYPE RECORD (RECORD VARIANT) - each selector record will have one or more variant records. They list the value choices for picking the correct variant for a given tag value. In C, bit fields and union values are in numerical order starting with one. In PASCAL the values are user defined.

Word 0 - is the record type = 14.

Word 1 - is not used.

Word 2 - is the value used to select this variant.

Word 3 - is the number of words to position to in the file to find the first field in this variant.

Word 4 - is the number of words to position to in the file to find the next variant for this selector.

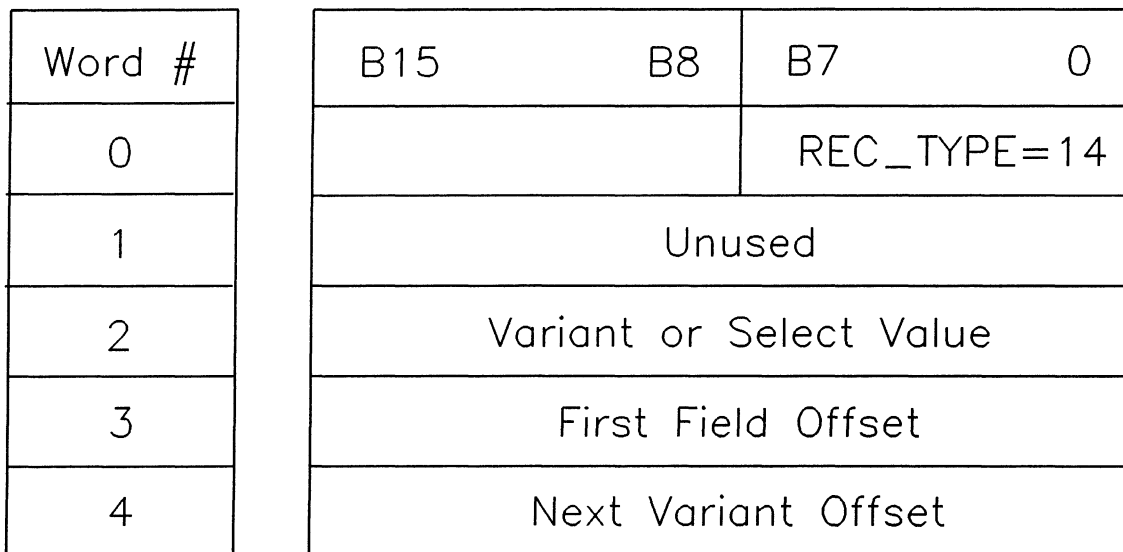

Figure 17-16. Type Record (Record Variant)

TYPE RECORD (REAL NUMBER) - this record defines the real number type.

Word 0 - is the record type = 16.

Word 1 - is the number of bytes defined for this type (4 or 8).

Word #	B15	B8	B7	0
0			REC_TYPE=16	
1	Size of Structure			

Figure 17-17. Type Record (Real Number)

TYPE RECORD (CHARACTER) - this record defines the type that is a character.

Word 0 - is the record type = 17.

Word 1 - is the number of bytes for this character. This word will always be 1.

Word #	B15	B8	B7	0
0			REC_TYPE=17	
1	Size of Structure			

Figure 17-18. Type Record (Character)

TYPE RECORD (FUNDAMENTAL INTEGER) - this record defines an integer type.

Word 0 - the upper byte indicates if the integer is signed. A zero = unused (use sub-range sign), 1 = unsigned, 2 = signed. The lower byte is the record type = 18.

Word 1 - the number of bytes that make up this integer.

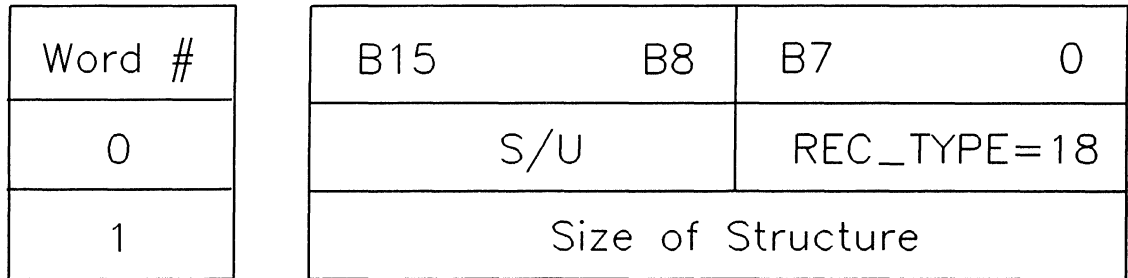

Figure 17-19. Type Record (Fundamental Integer)

TYPE RECORD (BIT FIELD) - this record is used in C only. It indicates if the type is a bit field.

Word 0 - is the record type = 19.

Word 1 - is the number of bytes in this field.

Word 2 - is the number of bits used for this particular field entry.

Word 3 - is the starting bit number of this field.

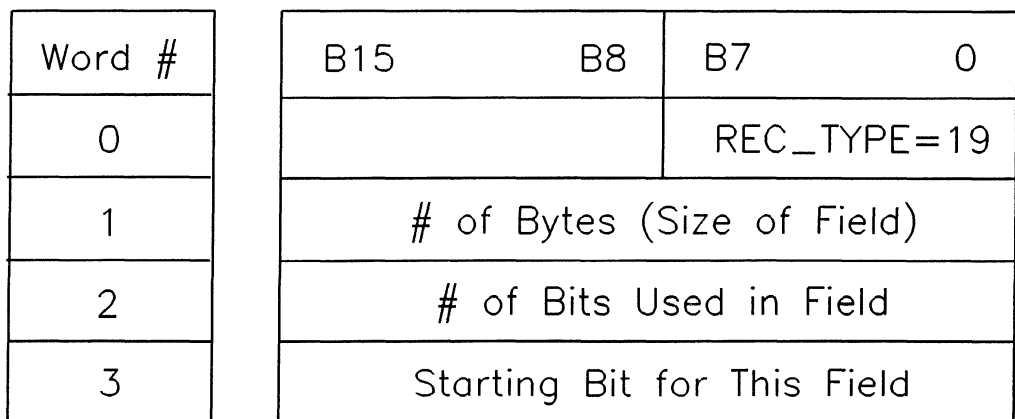
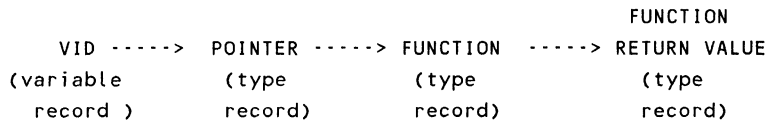

Figure 17-20. Type Record (Bit Field)

TYPE RECORD (FUNCTION TYPE) - this record is for C only. It indicates a function type.

This record is found when a C program has a pointer to a function. In this case, the data base records will be linked in this manner :



Word 0 - is the record type = 20.

Word 1 - is the number of words to position to in the file to find the type of the function.

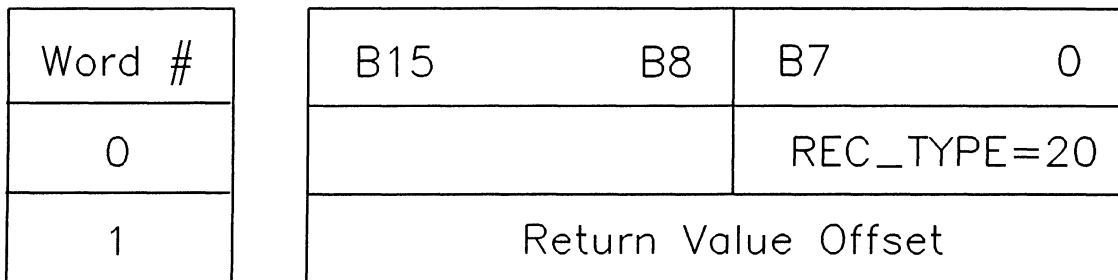

Figure 17-21. Type Record (Function Type)

TYPE RECORD (FILE TYPE) - this is only used in PASCAL, and indicates that the type is a file.

Word 0 - is the record type = 21

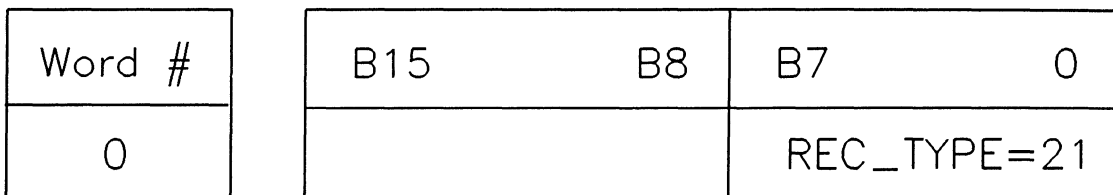

Figure 17-22. Type Record (File Type)

NOTES

Chapter 18

SIMULATED I/O FILE FORMAT

SIMULATED I/O FILE (all non-specified types)

Simulated I/O files are for your convenience. They are not used by the HP 64000 in a system capacity. They are created and accessed using Simulated I/O from an HP 64000 System Emulator or HOST Pascal. The system commands {copy, rename, directory, purge, and recover} will not work on files of type :sim_io. If you want to access files made by Simulated I/O or HOST Pascal using system commands, use file type = 10 (data files).

At some point, file type numbers which are currently unassigned may be assigned to new file types. It is suggested that user programs use files of type 10 (data), and not use other file types which are currently unassigned.

For a pictorial representation of the Simulated I/O file format, see Figures 18-1 and 18-2.

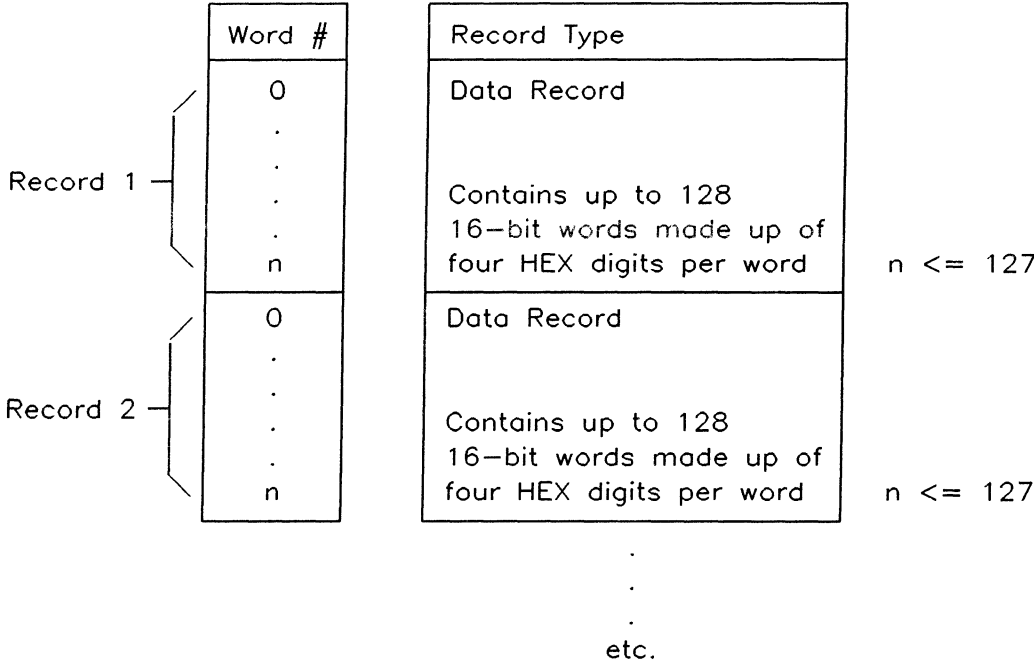

Figure 18-1. Simulated I/O Files - Overall Structure

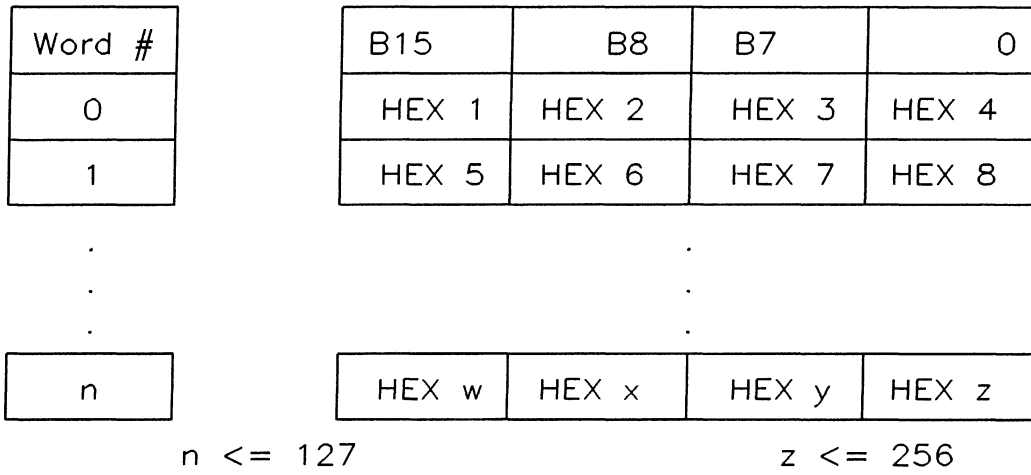

Figure 18-2. Data Record Format

Appendix A

SUPPORTED PROCESSORS AND FORMAT NUMBER DESCRIPTIONS

Supported microprocessors are listed below in Table A-1.

Table A-1. Supported Microprocessors

micro-processor	words used to define address	words used to define skeleton	processor data bus width	data width base
8080/85 Z80	1 word	1 word	8 bits	8 bits
6800/01/ 03/05/09	1 word	1 word	8 bits	8 bits
650x	1 word	1 word	8 bits	8 bits
68000/08/10	2 words	2 words	16 bits	8 bits
8021/22 /41/48	1 word	1 word	8 bits	8 bits
9900/40/ 85/89/99	1 word	1 word	16 bits	8 bits
9980	1 word	1 word	8 bits	8 bits
99xxx	1 word	1 word	16 bits	16 bits
1802	1 word	1 word	8 bits	8 bits
F8	1 word	1 word	8 bits	8 bits
Z8	1 word	1 word	8 bits	8 bits
8086/88/89/ 186/188/286	2 words	2 words	16 bits	8 bits
Z8001/2	2 words	2 words	16 bits	8 bits
8051	1 word	1 word	8 bits	8 bits
1750A	1 word	1 word	16 bits	16 bits
TMS320	2 words	2 words	16 bits	16 bits
8096	1 word	1 word	16 bits	8 bits

FORMAT NUMBERS AND SKELETON REQUIREMENTS

8080/85 and Z80

Uses linker table I8085_Z80:HP

The first step in all cases is to read the 16-bit address/displacement field passed by the assembler and add to it the value of the relocation counter or external symbol specified. This quantity will be referred to as the address in the definitions listed in Table A-2. All output is to the absolute file.

Table A-2. Format Number Descriptions for 8080/85, Z80

Format #	words of skeleton	Definition
0	0	Write address – high byte, low byte
1	0	Write address – low byte, high byte
2	0	Write low byte of address
3	0	Write high byte of address
4	0	Write low byte of address Check address in range 0 to 255
5	0	Write low byte of address Check address in range –128 to 127
6	0	Write low byte of address Check address in range –126 to 129

6800/01/02/03/05/09

Uses linker table I68XX:HP

The first step in all cases is to read the 16-bit address/displacement field passed by the assembler and add to it the value of the relocation counter or external symbol specified. This quantity will be referred to as the address in the definitions shown in Table A-3. All output is to the absolute file.

Table A-3. Format Number Descriptions for 6800/01/02/03/05/09

Format #	words of skeleton	Definition
0	0	Write address – high byte, low byte
1	0	offset = current PC – address – 1 Write low byte of offset Check offset in range –128 to 127
2	0	Write low byte of address Check address in range –128 to 255
3	0	offset = current PC – address – 2 Write offset – high byte, low byte
4	1	6808 only. Skeleton has value of DP register. offset = address – skeleton Write low byte of offset. Check for offset in range 0 to 255

650X

Uses linker table I650X:HP

The first step in all cases is to read the 16-bit address/displacement field passed by the assembler and add to it the value of the relocation counter or external symbol specified. This quantity will be referred to as the address in the definitions shown in Table A-4. All output is to the absolute file.

Table A-4. Format Number Descriptions for 650X

Format #	words of skeleton	Definition
0	0	Write address – low byte, high byte
1	0	offset = current PC – address – 1 Write low byte of offset Check offset in range –128 to 127
2	0	Write low byte of address Check address in range 0 to 255
3	0	Write low byte of address
4	0	Write low byte of address Check address in range –128 to 255

68000/08/10

Uses linker table I68000:HP

The first step in all cases is to read the 32-bit address/displacement field passed by the assembler and add to it the value of the relocation counter or external symbol specified. This quantity will be referred to as the address in the definitions listed in Table A-5. All output is to the absolute file.

Table A-5. Format Number Descriptions for 68000/08/10

Format #	Words of Skeleton	Definition
0	0	Write low byte of address Check address in range -128 to 255
1	0	Write address - high byte, low byte Check address in range -32768 to 65535
2	0	Write address - high word: high byte, low byte, low word: high byte, low byte
3	0	offset = address - current PC Write offset - high byte, low byte Check offset in range -32768 to 32767
4	0	Offset = address - current PC - 1 If offset is odd, add 1 to put on even boundary. Write low byte of offset Check offset in range -128 to 127
5	0	Offset = address - current PC - 1 Write low byte of offset Check offset in range -128 to 127
6	0	Write address - high byte, low byte Check address in range -32768 to 32767
7	0	Write low byte of address Check address in range -128 to 127
8	0	offset = address - current PC Write offset - high word: high byte, low byte, low word: high byte, low byte
9	0	Offset = address - current PC - 1 If offset is odd, add 1 to put on even boundary. Write low byte of offset Check offset in range -126 to 129
10	2	Skeleton bits 7,6,5,4 contain object code. Check address in range 0 - 16 Output byte consisting of bits 7,6,5,4 from the skeleton and bits 3,2,1,0 from the address.
11	1	WORD_ABS - 16-bit Base Page address (address must be in the range of FF8000-007FFF).
12	1	A5_REL - 16-bit displacement of A5 used by compilers.

8021/22/41/48

Uses linker table I8048:HP

The first step in all cases is to read the 16-bit address/displacement field passed by the assembler and add to it the value of the relocation counter or external symbol specified. This quantity will be referred to as the address in the definitions shown in Table A-6. All output is to the absolute file.

Table A-6. Format Number Descriptions for 8021/22/41/48

Format #	words of skeleton	Definition
0	0	Write low byte of address Check address in range of current page
1	0	Write low byte of address
2	1	8048 only. Check address in range 0 to 4096 Write byte consisting of bits 10,9,8 of address, and bits 4,3,2,1,0 of skeleton Then write low byte of address
3	0	Write address – high byte, low byte
4	0	Write high byte of address
5	1	8021/41 only Check address in range 0 to 1024 Write byte consisting of bits 10,9,8 of address, and bits 4,3,2,1,0 of skeleton Then write low byte of address

9900/40/85/89/99

Uses linker table 199XX:HP

The first step in all cases is to read the 16-bit address/displacement field passed by the assembler and add to it the value of the relocation counter or external symbol specified. This quantity will be referred to as the address in the definitions shown in Tables A-7 and A-8. All output is to the absolute file.

Table A-7. Format Number Descriptions for 9900/40/85/89/99

Format #	words of skeleton	Definition
0	0	Write low byte of address Check address in range -128 to 127
1	0	Write address - high byte, low byte
2	0	offset = address - current PC -1 Write low byte of offset Check offset in range -128 to 127
3	0	Write low byte of address

Table A-8. Format Number Descriptions for 9980

Format #	words of skeleton	Definition
0	0	Write low byte of address Check address in range -128 to 127
1	0	Write address - high byte, low byte
2	0	offset = address - current PC -1 Write low byte of offset Check offset in range -128 to 127
3	0	Write low byte of address

99XXX

Uses linker table 199XXX:HP

The first step in all cases is to read the 16-bit address/displacement field passed by the assembler and add to it the value of the relocation counter or external symbol specified. This quantity will be referred to as the address in the definitions shown in Table A-9. All output is to the absolute file.

Table A-9 Format Number Descriptions for 99XXX

Format #	words of skeleton	Definition
0	0	Write low byte of address Check address in range -128 to 127
1	0	Write address - high byte, low byte
2	0	offset = address - current PC - 1 Write low byte of offset Check offset in range -128 to 127
3	0	Write low byte of address

1802

Uses linker table 11802:HP

The first step in all cases is to read the 16-bit address/displacement field passed by the assembler and add to it the value of the relocation counter or external symbol specified. This quantity will be referred to as the address in the definitions shown in Table A-10. All output is to the absolute file.

Table A-10. Format Number Descriptions for 1802

Format #	words of skeleton	Definition
0	0	Write address – high byte, low byte
1	0	Write low byte of address
2	0	Write high byte of address
3	0	Offset = address – current page Write low byte of offset Check offset in range of current page

F8

Uses linker table IF8:HP

The first step in all cases is to read the 16-bit address/displacement field passed by the assembler and add to it the value of the relocation counter or external symbol specified. This quantity will be referred to as the address in the definitions shown in Table A-11. All output is to the absolute file.

Table A-11. Format Number Descriptions for F8

Format #	words of skeleton	Definition
0	0	offset = address - current PC Write low byte of offset Check offset in range -128 to 127
1	0	Write address - high byte, low byte
2	0	Write low byte of address Check address in range 0 to 255
3	1	Write byte consisting of skeleton bits 7,6,5,4 and address bits 3,2,1,0 Check address in range 0 to 15
4	1	Write byte consisting of skeleton bits 7,6,5,4,3 and address bits 2,1,0 Check address in range 0 to 7

Z8

Uses linker table IZ8:HP

The first step in all cases is to read the 16-bit address/displacement field passed by the assembler and add to it the value of the relocation counter or external symbol specified. This quantity will be referred to as the address in the definitions shown in Table A-12. All output is to the absolute file.

Table A-12. Format Number Descriptions for Z8

Format #	words of skeleton	Definition
0	0	Write low byte of address Check address in register range: 0 to 128, 240 to 255
1	0	Write low byte of address Check address is even and in register range: 0 to 128, 240 to 255
2	0	Write low byte of address Check address in range 0 to 255
3	0	Offset = address - current PC - 1 Write low byte of offset Check offset in range -128 to 127
4	0	Write address - high byte, low byte
5	0	Write low byte of address
6	0	Write high byte of address

8086/88/89/186/188/286

Uses linker table 18086:HP for 8086, 8089, or 80186

Uses linker table 18088:HP for 8088, 8089, or 80188

Uses linker table 180286:HP for 80286

The first step in all cases is to read the 32 bit address/displacement field passed by the assembler and add to it the value of the relocation counter or external symbol specified. This quantity will be referred to as the address in the definitions shown in Table A-13. All output is to the absolute file.

Table A-13. Format Number Descriptions for 8086/88/89/186/188/286

Format #	words of skeleton	Description
0	0	Write low byte of address (low word) Check address in range -128 to 127
1	0	Write low byte of address (low word) Check address in range -256 to 255
2	0	Write low byte of address (low word)
3	0	Write high byte of address (low word)
4	0	Write address - low word: high byte, low byte
5	0	Write address - low word: low byte, high byte
6	0	Write address - high word: low byte, high byte
7	0	Write address - low word: low byte, high byte high word: low byte, high byte
8	0	offset = address - current PC -1 Write low byte of offset (low word) Check offset in range -128 to 127
9	0	offset = address - current PC -2 Write offset low word - high byte, low byte Check offset in range -32768 to 32767
10	0	Writes NOP; increments current module number
11	0	Writes current module number
12	0	Write low byte of address (low word) Check address in range 0 to 255
13	0	Write address - low word: low byte, high byte, high word: low byte

Z8001/2

Uses linker table IZ8000:HP

The first step in all cases is to read the 32 bit address/displacement field passed by the assembler and add to it the value of the relocation counter or external symbol specified. This quantity will be referred to as the address in the definitions shown in Table A-14. All output is to the absolute file.

Table A-14. Format Number Descriptions for Z8001/2

Format #	words of skeleton	Definition
0	0	Write byte consisting of 0 followed by low 7 bits of high word of address. Then write Low byte of low word of address. Check for high byte of low word of address = 0
1	0	Write byte consisting of 1 followed by low 7 bits of high word of address. Then write a byte of 0's.
2	0	Write byte consisting of 0 followed by low 7 bits of low word of address
3	0	Write low byte of low word of address. Check upper byte of low word = 0
4	2	Write high byte of low word of skeleton Write byte consisting of bit 7 of the low word of skeleton and bits 6,5,4,3, 2,1,0 of the low byte of the low word of the address. Check for upper 9 bits of low word of address = 0. Check for high word of address = legal segment
5	2	Write high byte of low word of skeleton Write low byte of low word of address. Check for upper byte of address = 0 Check for high word of address to be legal segment

Table A-14. Format Number Descriptions for Z8001/2 (Cont'd)

6	2	Write byte consisting of bits 15,14,13, 12 of the low word of skeleton followed by bits 11,10,9,8 of the low word of address. Then write low byte of low word of address. Check for upper 4 bits of low word of address = 0. Check for high word of address = legal segment
7	0	offset = address - current PC -2 Write low word of offset - high byte low byte. Check for high word of address to be legal segment.
8	0	Write low byte of low word of address
9	0	Write low byte of low word of address twice. Check high byte of low word = 0
10	2	offset = address - 1 Write high byte of low word of skeleton Write byte consisting of bits 7,6,5,4 of low word of skeleton followed by bits 3,2,1,0 of low word of offset. Check bits 15 to 4 of offset = 0
11	2	Write high byte of low word of skeleton Write byte consisting of bits 7,6,5,4 of low word of skeleton followed by bits 3,2,1,0 of low word of address. Check bits 15 to 4 of address = 0

Table A-14. Format Number Descriptions for Z8001/2 (Cont'd)

12	2	Write high byte of low word of skeleton Write byte consisting of bits 7,6,5,4,3 of low word of skeleton followed by bits 2,1,0 of low word of address. Check bits 15 to 3 of address = 0
13	2	Write high byte of low word of skeleton Write low byte of low word of address. Check for upper byte of address = 0
14	2	Write high byte of low word of skeleton If address = 2, offset = 2 If address = 1, offset = 0 Otherwise ERROR. Write byte consisting of bits 7,6,5,4, 3,2,of low word of skeleton, followed by bits 1,0 of low word of offset.
15	0	If address >32 then offset = 32 Otherwise offset = address Write low word of offset – high byte low byte
16	0	If address >16 then offset = 16 Otherwise offset = address Write low word of offset – high byte low byte

Table A-14. Format Number Descriptions for Z8001/2 (Cont'd)

17	0	If address > 8 then offset = 8 Otherwise offset = address Write low word of offset – high byte low byte
18	0	If address >32 then offset = –32 Otherwise offset = twos complement of address. Write low word of offset – high byte low byte
19	0	If address >16 then offset = –16 Otherwise offset = twos complement of address. Write low word of offset – high byte low byte
20	0	If address >8 then offset = –8 Otherwise offset = twos complement of address. Write low word of offset – high byte low byte
21	0	Write low word of address – high byte, low byte. Check upper word = 0.

Table A-14. Format Number Descriptions for Z8001/2 (Cont'd)

22	0	Write low word of address – high byte low byte
23	0	Write byte consisting of 1 followed by low 7 bits of low word of address. Then write a byte of 0's.
24	0	Write low word of address – high byte, low byte
25	0	Write address – high word: high byte, low byte, low word: high byte, low byte
26	0	Write byte consisting of 1 followed by low 7 bits of high word of address. Then write a byte of 0's. Then write the low word of address – high byte, low byte.
27	2	Write high byte of low word of skeleton Write low byte of low word of address Check address in range –128 to 255
28	0	Write low word of address – high byte, low byte. Check address in range –32768 to 65535
29	0	Write low byte of low word of address twice. Check address in range –128 to 255.

8051

Uses linker table **l8051:HP**

The first step in all cases is to read the 16-bit address/displacement field passed by the assembler and add to it the value of the relocation counter or external symbol specified. This quantity will be referred to as the address in the definitions shown in Table A-15. All output is to the absolute file.

Table A-15. Format Number Descriptions for 8051

Format #	words of skeleton	Definition
0	0	offset = address - current PC - 1 Write low byte of offset Check offset in range -127 to 128
1	0	Write low byte of address Check address in range -256 to 255
2	1	Check address in range 0 to 2048 Write byte consisting of bits 10,9,8, of address, and bits 4,3,2,1,0 of skeleton Then write low byte of address
3	0	Write address - high byte, low byte
4	0	Write high byte of address
5	0	Write low byte of address
6	0	Write low byte of address Check address in range 0 to 255

1750A

Uses linker table I1750A:HP

The first step in all cases is to read the 32 bit address/displacement field passed by the assembler and add to it the value of the relocation counter or external symbol specified. This quantity will be referred to as the address in the definitions shown in Table A-16. All output is to the absolute file.

Table A-16. Format Number Descriptions for 1750A

Format #	words of skeleton	Description
0	0	Write low word of address high byte, low byte
1	0	offset = address - current PC write low byte of offset check offset in range -128 to 127
2	0	Write address high word - high byte, low byte; low word - high byte, low byte

TMS320

Uses linker table ITMS320:HP

The first step in all cases is to read the 32 bit address/displacement field passed by the assembler and add to it the value of the relocation counter or external symbol specified. This quantity will be referred to as the address in the definitions shown in Table A-17. All output is to the absolute file.

Table A-17. Format Number Descriptions for TMS320

Format #	words of skeleton	Description
0	0	output low byte of address, check for <256
1	0	output low byte of address, check for <128
2	2	OR skeleton with bits 3,2,1,0 of address. Output low byte, check address <16
3	2	OR skeleton with bits 2,1,0 of address. Output low byte, check address <8
4	0	Write low word of address high byte, low byte, check address <4096
5	2	OR bits 15,14,13 of skeleton with bits 12-0 of address. Write high byte, low byte
6	2	Write low byte of skeleton. Check for skeleton =0
7	2	OR skeleton with address - output low byte. Check address = 0,1 or 4.
8	2	OR low bit of address with skeleton Write low byte, check address <=1
9	0	Write low word of address high byte, low byte. Check address <=65535 >=-32767
10	0	Output 32 bit address high word: high byte, low byte, low word: high byte, low byte

8096

Uses linker table I8096:HP

The first step in all cases is to read the 16-bit address/displacement field passed by the assembler and add to it the value of the relocation counter or external symbol specified. This quantity will be referred to as the address in the definitions shown in Table A-18. All output is to the absolute file.

Table A-18. Format Number Definitions For 8096

Format #	Words of Skeleton	Definition
0	0	8 bit offset (sign extended to 16 bits). Check to see if destination address is within -128 to 127 bytes of the starting address of the next instruction.
1	1	Bits 15 - 11 of skeleton are the basic opcode for a short displacement call or branch. The 11-bit displacement (sign-extended to 16 bits) is tested to determine if the destination address is within -1024 to 1023 bytes of the starting address of the next instruction.
2	0	Two bytes containing the relative offset between the starting address of the next instruction and the destination address. The least two significant bytes of the address will occur in the lowest byte of the word (for example: bytes are swapped within the word).
3	0	Two byte address with bytes swapped as in Format #2.
4	0	Byte aligned register that can be relocated 01AH-OFFM. Attempts to relocate registers outside this range will be flagged as errors.
5	1	Word aligned register that can be relocated within the address range 01AH-OFFH. The skeleton will contain the value 0 in the case of short indexed or indirectly addressed instructions. The value 1 will be found in the case of long indexed or indirectly addressed instructions with autoincrement. The default value for Skeleton will be 0 in all other cases. Values that do not lie on word boundaries will be flagged as errors.
6	1	Same as format #5, but alignment must occur on double word boundaries.

NOTES

Appendix B

FILE NAME DESCRIPTION - FIXED LENGTH

WORD 0 - The contents of Word 0 (see Figure B-1) is broken down as follows:

fff - bits 15,14,13 - contain the number of 16-bit words necessary to define the file name. The file name is packed two characters per word, with the first character stored in the last byte of word 1. This number is calculated as follows: Take the number of characters in the file name and subtract one. Divide this number by two and round up. For example, the file name START1 consists of 6 ASCII characters. This would require 3 words in addition to word 1 in which to fit all the characters of the name. $(6-1) / 2 = 2.5$ which rounds up to 3. If the last character of the file name is stored in the upper byte of a word, the lower byte must contain a blank (20H).

uu - bits 12,11 - contain the number of 16-bit words necessary to define the userid associated with the file name. The userid is packed, two characters per word, starting in the word after the one containing the last byte of the file name. For example the userid HP is two characters which will fit into one 16-bit word; the number appearing in location uu will be 1. If the last character of the userid is in the upper byte of a word, the lower byte must contain a blank (20H). If the field uu contains zero, the current userid is used. To express the blank userid, the field uu contains one, and the both bytes of that word contain blanks (20H).

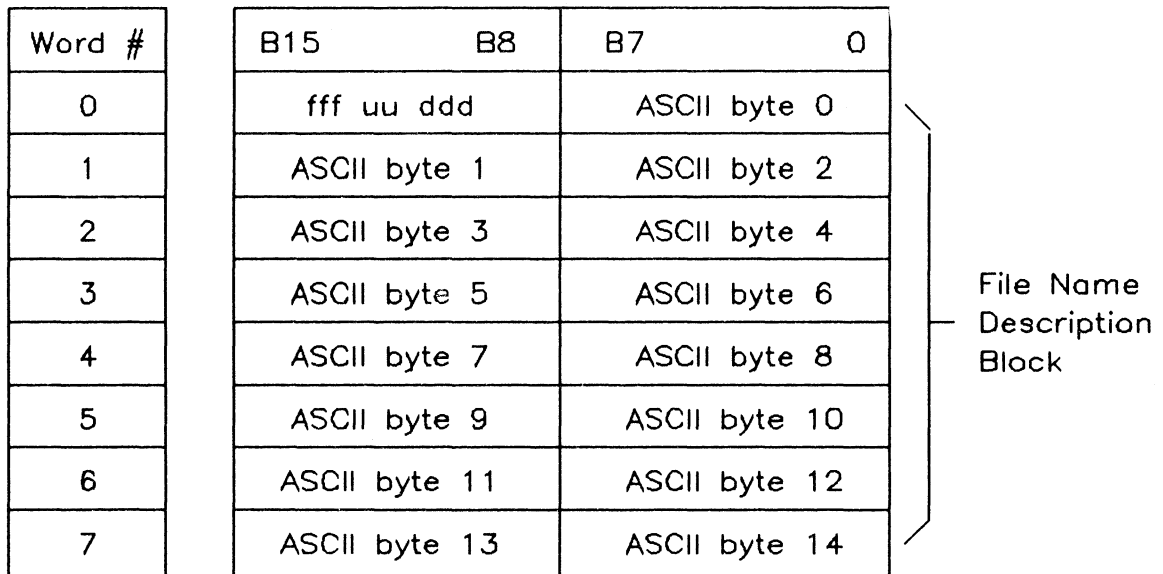

Figure B-1. File Name Description Block

**File Format
Reference Manual**

ddd - bits 10,9,8 - contains the disc number where the source file corresponding to this relocatable file resides.

ASCII byte 0 - bits 7-0 - contain the first character of the file name. (All file names are made up of at least one character.)

WORD 1-7 - The remaining characters in the file name and the characters making up the files' userid appear in words 1-7 of the Name record. The userid characters start in the word immediately following the word containing the last character of the file name. The words following the one in which the last character of the userid is stored are not used. The linker does not care what values these words hold.

The example described above file = START1:HP:0 would be stored as shown in Figure B-2.

0	011 01 000	S (53H)
1	T (54H)	A (41H)
2	R (52H)	T (54H)
3	1 (31H)	(20H)
4	H (48H)	P (50H)
5	xxxxxxxx	xxxxxxxx
6	xxxxxxxx	xxxxxxxx
7	xxxxxxxx	xxxxxxxx

Figure B-2. File Name Description Example

Appendix C

LINKER TABLE DESCRIPTION - FIXED LENGTH

WORD 0 - The contents of Word 0 (see Figure C-1) is broken down as follows:

fff - bits 15,14,13 - contain the number of 16-bit words necessary to define the file name of the linker. The file name is packed two characters per word with the first character stored in the last byte of word 1. This number is calculated as follows: Take the number of characters in the file name and subtract one. Divide this number by two and round up. For example, the file name I68000 consists of 6 ASCII characters. This would require 3 words in addition to word 1 in which to fit all the characters of the name. $(6-1) / 2 = 2.5$ which rounds up to 3. If the last character of the file name is stored in the upper byte of a word, the lower byte must contain a blank (20H).

uu - bits 12,11 - contain the number of 16-bit words necessary to define the userid associated with the file name. The userid is packed, two characters per word, starting in the word after the one containing the last byte of the file name. For example the userid HP is two characters which will fit into one 16-bit word; the number appearing in location uu will be 1. If the last character of the userid is in the upper byte of a word, the lower byte must contain a blank (20H). If the field uu contains zero, the current userid is used. To express the blank userid, the field uu contains one, and the both bytes of that word contain blanks (20H).

Word #	B15	B8	B7	0
0	fff uu ddd		ASCII byte 0	
1	ASCII byte 1		ASCII byte 2	
2	ASCII byte 3		ASCII byte 4	
3	ASCII byte 5		ASCII byte 6	
4	ASCII byte 7		ASCII byte 8	
5	ASCII byte 9		ASCII byte 10	
6	ASCII byte 11		ASCII byte 12	
7	ASCII byte 13		ASCII byte 14	

Linker
Table
Description
Block
(Fixed length
8 words)

Figure C-1. Linker Table Description Block

**File Format
Reference Manual**

ddd - bits 10,9,8 - contains the disc number where the source file corresponding to this relocatable file resides.

ASCII byte 1 - bits 7-0 - contain the first character of the file name. (All file names are made up of at least one character.)

WORD 1 through 7 - The remaining characters in the file name and the characters making up the files' userid appear in words 1-7 of the Name record. The userid characters start in the word immediately follow the word containing the last character of the file name. The words following the one in which the last character of the userid is stored are not used. The linker does not care what values the words hold.

The standard linker table names are:

11000	18048	18088	128000
11802	18051	19980	1LINK (used to link
1650X	18080	199XX	the User-Definable
168000	18085_z80	1F8	Linker)
168XX	18086	1Z8	

Other linker table names may have been defined using the User-Definable Assembler/Linker, and those names will also appear in this record.

The example described above file = 168000:HP:1 would be stored as:

0	011 01 001	1 (6CH)
1	6 (36H)	8 (38H)
2	0 (30H)	0 (30H)
3	0 (30H)	0 (30H)
4	H (48H)	P (50H)
5	xxxxxxxx	xxxxxxxx
6	xxxxxxxx	xxxxxxxx
7	xxxxxxxx	xxxxxxxx

Figure C-2. Linker Table Description Example

Appendix D

SYMBOL NAME DESCRIPTION - VARIABLE LENGTH

WORD 0 - The contents of Word 0 (see Figure D-1) is broken down as follows:

sss - bits 15,14,13 - contain the number of 16-bit words necessary to define the symbol name. The symbol name is packed two characters per word, with the first character stored in the last byte of word 1. This number is calculated as follows: Take the number of characters in the symbol name and subtract one. Divide this number by two and round up. For example, the symbol name ASSEMBLER1 consists of 10 ASCII characters. This would require 5 words in addition to word 1 to fit all the characters of the name. $(10-1) / 2 = 4.5$, which rounds up to 5. If the last character of the symbol name is stored in the upper byte of a word, the lower byte must contain a blank (20H).

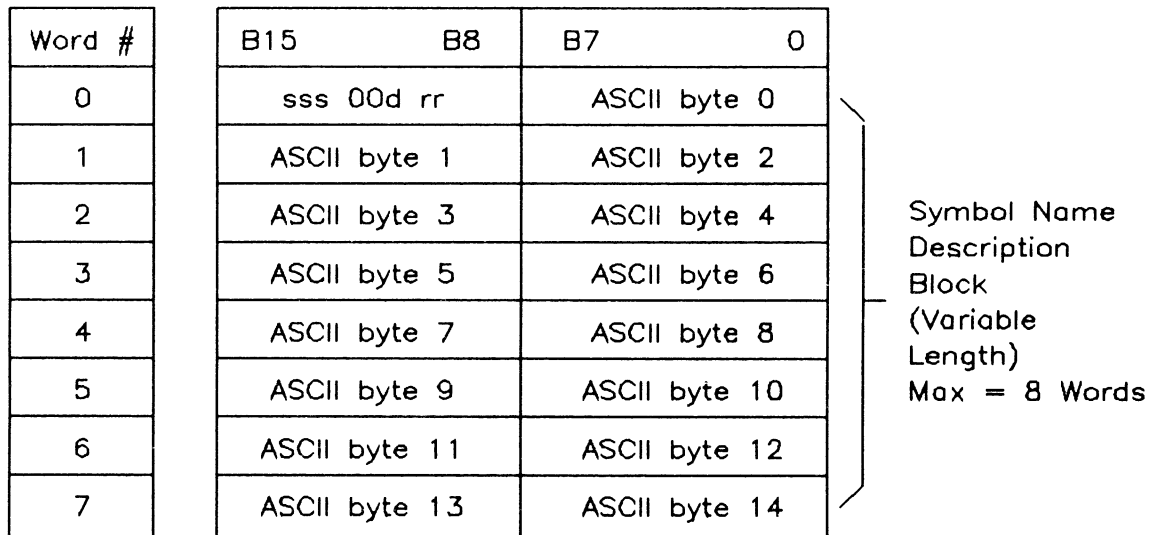

Figure D-1. Symbol Name Description Block

**File Format
Reference Manual**

d - This bit is 0 in all file types except link__sym. In a link__sym file, this bit indicates whether the symbol was defined. A 1 in this bit indicated that the reference to this symbol was not resolved.

rr -bits 9,8 -contain a code describing which relocation counter to use in relocating this symbol.

- 00 = absolute (no relocation)
- 01 = PROG
- 10 = DATA
- 11 = COMN

ASCII byte 0 - bits 7-0 - contains the first character of the symbol name. (All symbol names are made up of at least one character.)

Up to WORD sss+1 - Additional characters in symbol name. Note that for a one character symbol name, sss = 0, so there are no additional words used.

The example described above symbol = ASSEMBLER relocatable wrt DATA counter would be stored as shown in Figure D-2.

0	101 000 10	A (41H)
1	S (53H)	S (53H)
2	E (45H)	M (4DH)
3	B (42H)	L (4CH)
4	E (45H)	R (52H)
5	1 (31H)	(20H)

Figure D-2. Symbol Name Description Example

Appendix E

MEMORY SPACE RECORD - SOURCE NAME DESCRIPTION - FIXED LENGTH

WORD 1 - The contents of Word 1 (see Figure D-1) is broken down as follows:

fff - bits 15,14,13 - contain the number of 16-bit words necessary to define the file name. The file name is packed two characters per word, with the first character stored in the last byte of word 1. This number is calculated as follows: Take the number of characters in the file name and subtract one. Divide this number by two and round up. For example, the file name START1 consists of 6 ASCII characters. This would require 3 words in addition to word 1 in which to fit all the characters of the name. $(6-1) / 2 = 2.5$ which rounds up to 3. If the last character of the file name is stored in the upper byte of a word, the lower byte must contain a blank (20H).

uu - bits 12,11 - contain the number of 16-bit words necessary to define the userid associated with the file name. The userid is packed, two characters per word, starting in the word after the one containing the last byte of the file name. For example the userid HP is two characters which will fit into one 16-bit word; the number appearing in location uu will be 1. If the last character of the userid is in the upper byte of a word, the lower byte must contain a blank (20H). If the field uu contains zero, the current userid is used. To express the blank userid, the field uu contains one, and the both bytes of that word contain blanks (20H).

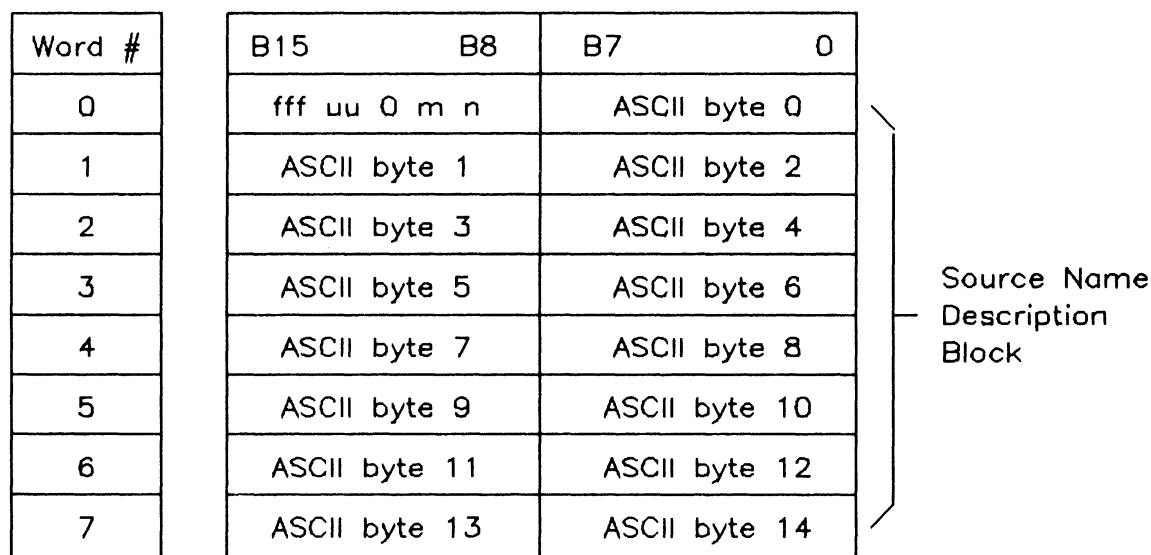

Figure E-1. Memory Space Record - Source Name Description Block

**File Format
Reference Manual**

0 - bit 10 - is reserved for future use by the 64000 system and should contain 0's.

m - bit 9 - contains a 1 if and only if multiple relocatables are collected under one File Name (as for a library) or if the Program Name Definition Block for the relocatable in the link_sym file is not the same name as the Source file from which the relocatable was obtained. Otherwise, this bit contains a 0.

n - bit 8 - contains a 1 if and only if this file was no-loaded. Otherwise, this bit contains a 0.

ASCII byte 0 - bits 7-0 - contain the first character of the file name. (All file names are made up of at least one character.)

WORD 1-7 - The remaining characters in the file name and the characters making up the files' userid appear in words 1-7 of the Name record. The userid characters start in the word immediately following the word containing the last character of the file name. The words following the one in which the last character of the userid is stored are not used. The linker does not care what values these words hold.

The example described above file = START1:HP would be stored as:

0	011 01 000	S (53H)
1	T (54H)	A (41H)
2	R (52H)	T (54H)
3	1 (31H)	(20H)
4	H (48H)	P (50H)
5	xxxxxxxx	xxxxxxxx
6	xxxxxxxx	xxxxxxxx
7	xxxxxxxx	xxxxxxxx

Figure E-2. Memory Space Record - Source Name Description Example

INDEX

a

absolute	2-5
absolute file format	6-1
absolute file record.	17-3
analyzer	2-8
ascii characters	D-1
ascii records.	4-1
asmb_db file	2-9
asmb_sym file	2-5
assembler symbol file.	17-1
assembler symbol file format	13-1
assemblers.	2-1

b

binary object file.	6-1
blank userid	C-1

c

c compilers	2-1
command file	2-6, 2-7
common load address	14-7
comn	2-5
comp_db option	17-1
compiler database file	17-1
compiler symbol file.	17-1
configuration information.	9-3
copy.	18-1
copy command	2-8, 2-9, 16-1

d

data	2-5
data bus width	6-2
data file format.	11-1
data files.	11-1
data header record format	9-14
data label	2-3, 2-4
data load address.	14-7
data record.	6-2
data record format	18-1
data width base	6-2, A-1
device file format	16-1
directory.	18-1
display	16-1

**File Format
Reference Manual**

display global_symbols15-1
display local_symbols15-1
display spec record format.....9-19
double record..... 5-1
dummy files16-1

e

editor 2-1
editor temporary files15-1
emul_com file 2-6
emul_com files 7-1
emulation command file format 7-1
emulation with internal analysis9-17
emulators 2-6
end label 2-3, 2-4
end record 5-1
event_array 9-3, 9-4
expression record format9-12
external procedure record17-12
external symbol record..... 5-1

f

file format..... 3-1
file generation 2-1
file lock 9-3
file name description - fixed length B-1
file organization17-1
file types..... 1-1
file usage 2-1
fixed configuration dump record format.....9-11
format number descriptions..... A-1
format numbers and skeleton requirements..... A-2
function entry label 2-4

g

generated symbols..... 2-3, 2-4
global symbol record 5-1
global symbols..... 2-4, 2-6

h

header record format12-2
hi bound address14-9

i

identification record	9-1
index information	17-1
index table records	17-6
internal analysis	9-18
inverse assembler	9-13

l

labels	2-3
last configuration dump record format	9-12
library command	5-1
library of relocatable files	5-2
line number symbol record	12-7
link_com file	8-1
link_sym file	2-5, 2-6
linker	5-1
linker command file format	8-1
linker protected mode (80286)	14-1, 14-12
linker symbol file	2-5, 17-1
linker symbol file format	14-1
linker table description block	C-1
linker table description - fixed length	C-1
linker tables	A-2 through A-20
linkers	2-4
listing output	2-5
load address	6-2
local symbols	2-5
logical sequencer state	9-16
low bound address	14-9

m

maximum static address	17-6
measurement system	9-20
memory space definition blocks	14-9
memory space record - source name description	E-1
memory space records	14-1
micro count reset flag	9-16
microprocessor software generation activities	2-2
microprocessors	A-1
minimum static address	17-6

n

name record	5-1
name record format	5-3

o

optional data header record format	9-13
optional overview data record format	9-15
optional tracelist data record format	9-16
overview data record format	9-15

p

pad words	14-3
pascal compilers	2-1
preprocessor	9-13
printer	16-1
procedure entry label	2-3
processor configuration record	14-1
processor data bus width	A-1
processor information record	6-2
product descriptions	9-3
prog	2-5
program file record	17-4
program load address	14-7
program range record	12-4
prom file format	10-1
prom files	10-1
protected mode linker (80286)	14-1, 14-12
purge	18-1

r

recover	18-1
regular temporary files	15-1
relocatable addresses	2-1
relocatable file format	5-1
relocatable names	14-1
rename	18-1
return label	2-3, 2-4

s

sequence occurrence flag	9-16
sequence resource	9-16
sim I/O	11-1
simulated I/O	16-1
simulated I/O file format	18-1
skeleton requirements	A-2
software performance analyzer	2-8, 9-3
software revision number	17-3
sorting symbols	15-1
source and listing file formats	4-1
source and listing files	4-2
source name	5-1

special emul_com files	7-1
special trace files	9-20
specific records	17-3
state analyzer database file format	12-1
state/software analyzer	2-9, 9-8
statistical analysis	2-8
subroutine element	17-2
subroutine record	17-8
supported processors	A-1
symbol definitions	2-5
symbol information	17-1
symbol look-up	2-6
symbol name description block	D-1
symbol name description - variable length	D-1
symbol record	12-5
symbol table record format	9-12
symbols	2-3
system bus address	2-7
system file format	3-1
system files	1-1
system software generation	2-1

t

t parameters	5-12
temporary file format	15-1
time event boundary definition	9-6
timing analyzer	2-9, 9-6
trace file format	9-1
trace files	2-8, 9-17
trace status record format	9-19
tracelist data record format	9-16
transfer address	6-2
type record (array)	17-16
type record (bit field)	17-22
type record (character)	17-21
type record (file type)	17-23
type record (function type)	17-23
type record (fundamental integer)	17-22
type record (pointer)	17-15
type record (real number)	17-21
type record (record)	17-17
type record (record field ptr)	17-18
type record (record variant)	17-20
type record (selector record)	17-19
type record (set)	17-15
type records (scalar)	17-13
type records (subrange)	17-14

U

user-definable assembler/linker C-2
user-definable emulator 13-2

V

variable record 17-10
variable records 17-2

W

window enable flag 9-16
words 4-1
words that make up assembler symbol record 13-2
words that make up data files 11-1
words that make up data record 6-2
words that make up database file format 12-1
words that make up double record format 5-9
words that make up end record format 5-15
words that make up external procedure record 17-12
words that make up external record format 5-8
words that make up global record format 5-6
words that make up global symbol record 14-5
words that make up identification record 9-2
words that make up index table record 17-6
words that make up name record format 5-3
words that make up processor configuration record 14-3
words that make up program file record 17-4
words that make up relocatable name record 14-7
words that make up subroutine record 17-8
words that make up t parameters 5-13
words that make up trace file format 9-6, 9-7
words that make up type record (array) 17-16
words that make up type record (bit field) 17-22
words that make up type record (character) 17-21
words that make up type record (file type) 17-23
words that make up type record (fundamental integer) 17-22
words that make up type record (function type) 17-23
words that make up type record (pointer) 17-15
words that make up type record (real number) 17-21
words that make up type record (record) 17-17
words that make up type record (record field ptr) 17-18
words that make up type record (record variant) 17-20
words that make up type record (scalar) 17-13
words that make up type record (selector record) 17-19
words that make up type record (set) 17-15
words that make up type record (subrange) 17-14
words that make up variable record 17-10
words used to define address A-1
words used to define skeleton A-1

