

FACIT

PAPER TAPE READER **SPARE PARTS**

PE 1000

ÅTVIDABERGS

FACIT electronics

FACK SOLNA 1 • SWEDEN



CONTENTS

1	GENERAL
2	FRAME AND HOODS
3	READING UNIT
3.1	Lid
3.2	Platform
3.3	Motor
3.4	Trimmer unit
3.5	Oscillator unit
4	REEL HOLDER
5	POWER UNIT
5.1	Cable harness and switches
5.2	Diode and choke unit
5.3	Resistor unit
5.4	Capacitor unit
6	CIRCUIT BOARD UNIT
6.1	Board holders and connectors
6.2	Circuit boards
6.2.1	Board No. 1
6.2.2	Board No. 2
6.2.3	Board No. 3
6.2.4	Board No. 4
6.2.5	Board No. 5
6.2.6	Board No. 6
6.2.7	Board No. 7
7	ACCESSORIES

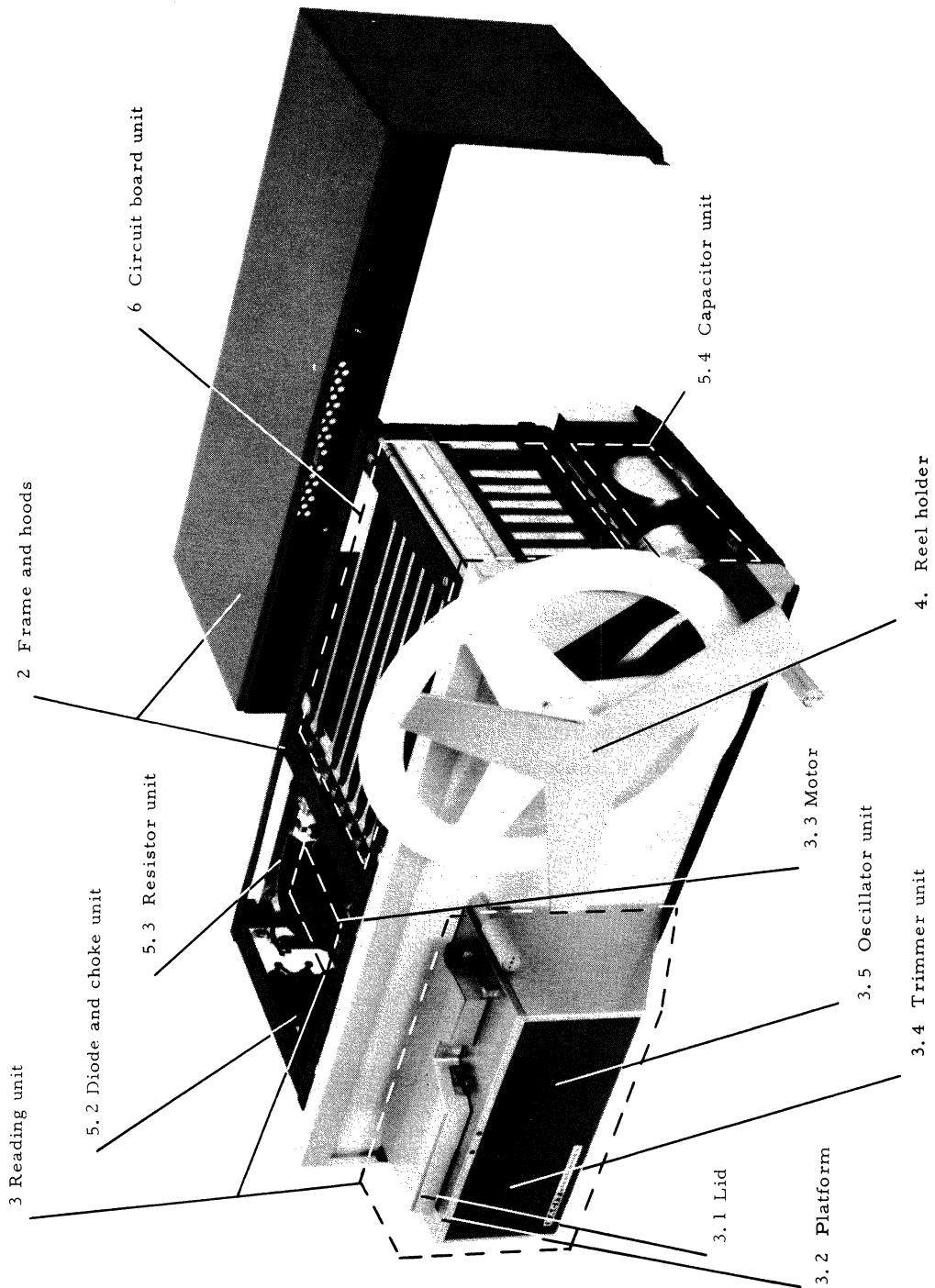

Paper tape reader FACIT PE 1000

Models	Mains voltage	Mains frequency
FACIT PE 1001	220 V, single phase	50 c/s
FACIT PE 1002	115 V, single phase	50 c/s
FACIT PE 1003	220 V, single phase	60 c/s
FACIT PE 1004	115 V, single phase	60 c/s

I GENERAL

This parts list designates parts for the following models of the paper tape reader FACIT PE 1000.

Models: PE 1001, 1002, 1003 and 1004.

The disassembly, assembly and change of most mechanical parts should only be undertaken according to special instructions. These will be available when contacting our service department.

Screws, washers and nuts which are not of special design are designated according to Swedish SIS standards. They are bound to their corresponding details by brackets in this parts list.

All semi-conductors should be submitted to our test instructions.

The reel holder, chapter 4, is an accessory item for tape handling at 500 ch/s. In this book anyhow it is dealt with as a part of the equipment.



2 FRAME AND HOODS

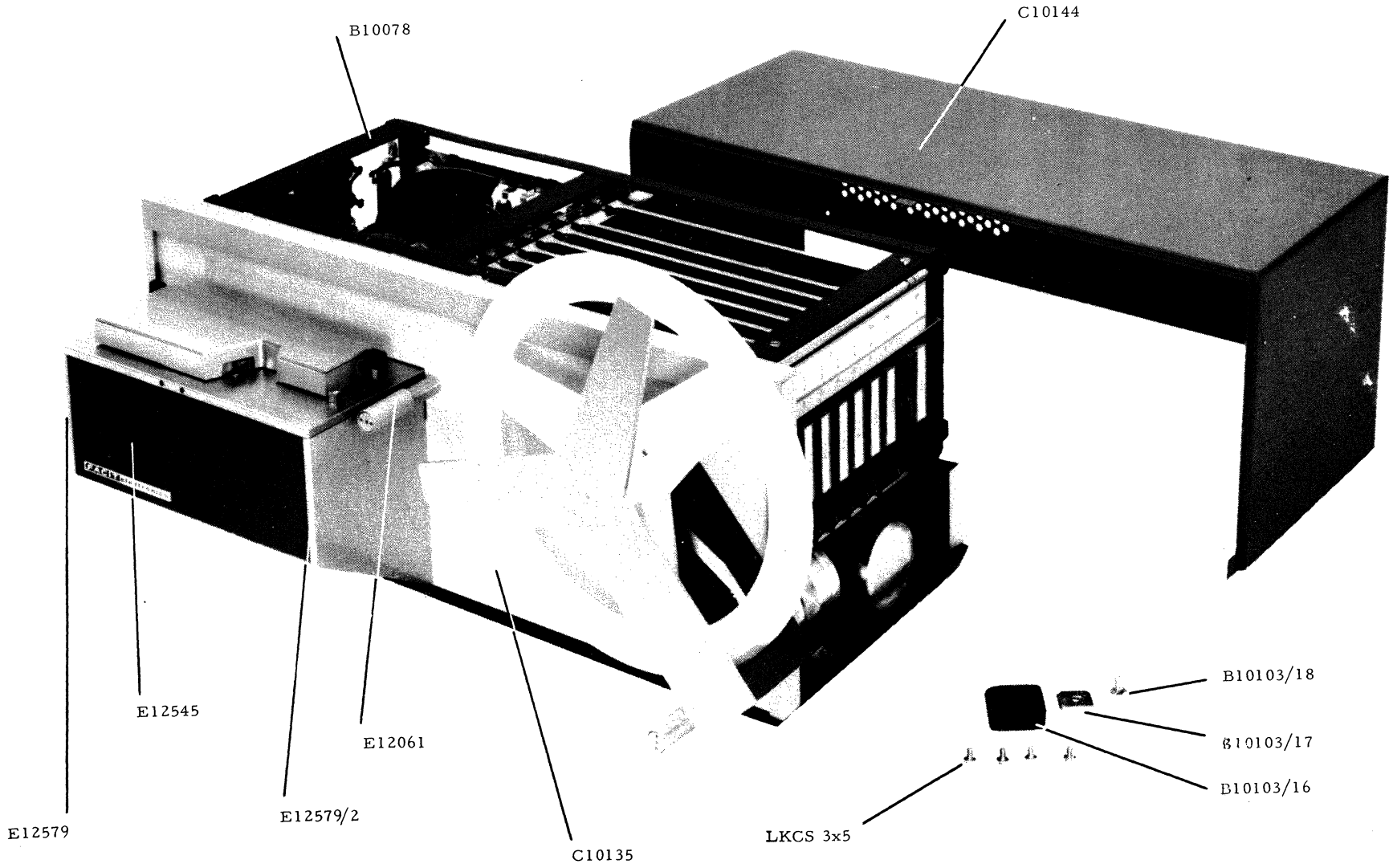

UP 63 10 01
I 1.10.63

2 FRAME AND HOODS

Part No.	Description		
B10078	Frame		
ECS 3x4	Screw		(2 off)
B10103/16	Rubber foot	Åtvidaberg-Facit, B-1595	(4 off)
B10103/17	Washer	Åtvidaberg-Facit, A-1024-3	(4 off)
B10103/18	Screw	Åtvidaberg-Facit, A-884	(4 off)
C10135	Mirror plate		
ECS 3x6	Screw		(2 off)
LKCS 3x5	Screw		
LB6LM 3	Nut		(2 off)
C10144	Hood		
LKCS 3x5	Screw		(4 off)
E12061	Roller		
LB6LM 3	Nut		
E12545	Cover		
ECS 3x4	Screw		(2 off)
E12579	End plate, left		
ECS 3x12	Screw		
E12579/2	End plate, right		
ECS 3x12	Screw		

3
3:1
LID
READING UNIT

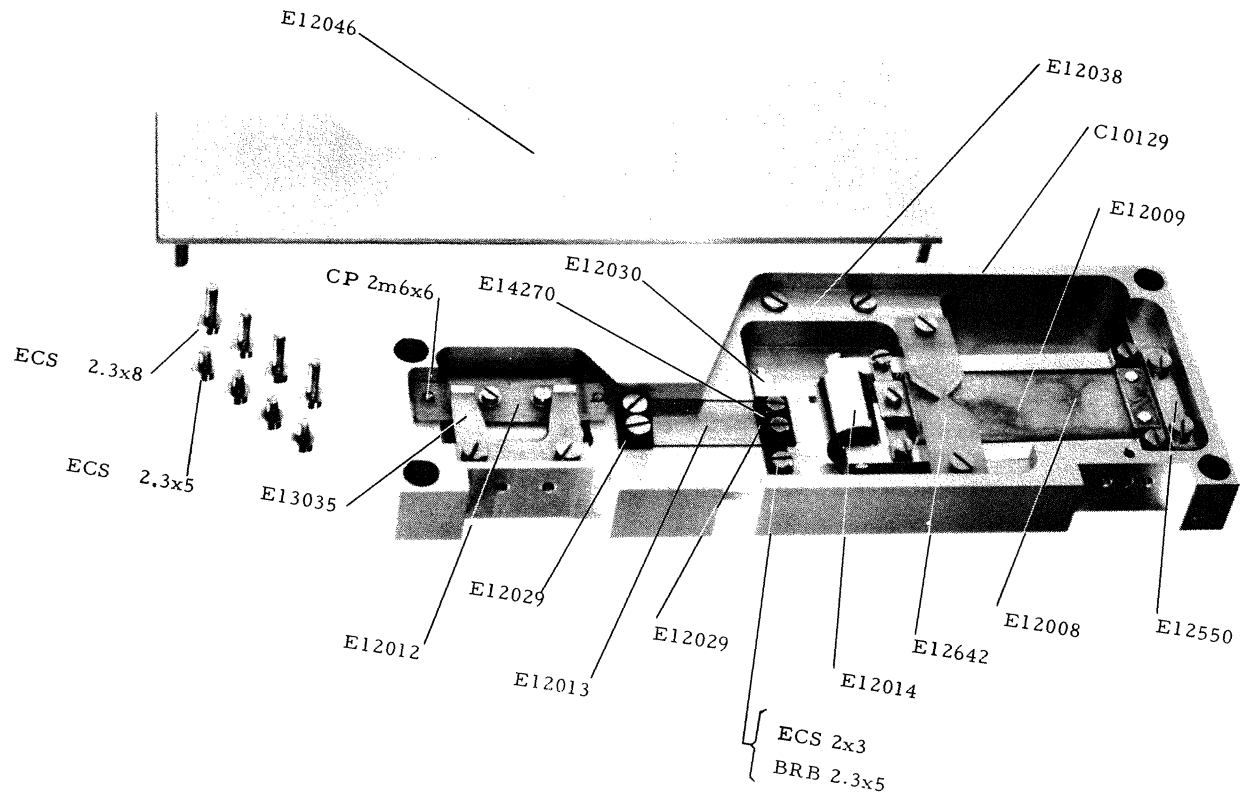

UP 63 10 01
I 1.10.63

3.1 LID

Part No.	Description	
D10507	Lid, complete	
ECS 2.3x8	Screw	(4 off)
C10129	Lid	
E12008	Feed armature, complete	
E12550	Plate	
ECS 2.3x5	Screw	(2 off)
E12009	Armature	
E12014	Roller	
E12016	Shaft	
RMB RF 258	Ball bearing	(2 off)
KS 643-2	Washer	(4 off)
LB6LM 2	Nut	(2 off)
E12642	Stop bar	
ECS 2.3x5	Screw	(2 off)
E12020	Brake armature, complete	
E12012	Holder	
ECS 1.7x3	Screw	(2 off)
BRB 1.8x4	Washer	(2 off)
CP2m 6x6	Cylindrical pin	(2 off)
E13035	Leaf spring	
ECS 2.3x5	Screw	(2 off)
E12038	Armature	
ECS 2.3x5	Screw	(2 off)
E14270	Main electrode, complete	
ECS 2.3x5	Screw	(2 off)
E12029	Insulating plate	
ECS 2x3	Screw	
BRB 2.3x5	Washer	
E12013	Leaf spring	
E12029	Insulating plate	
E12030	Main electrode	
E12031	Insulating bushing	(2 off)
ECS 2x6	Screw	(2 off)
E12046	Cover plate	
ECS 2.3x5	Screw	(4 off)

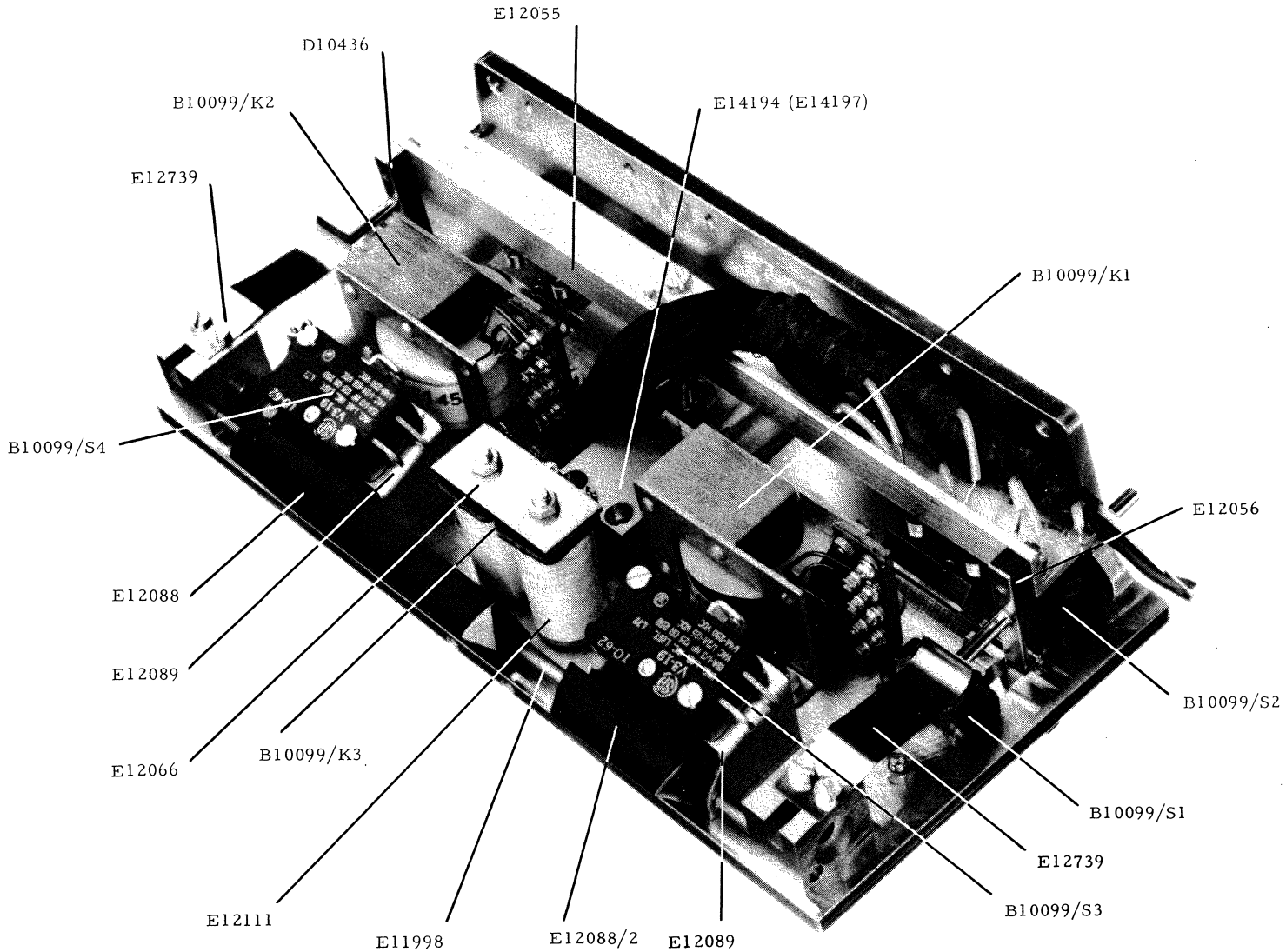

Platform, bottom view

UP 63 10 01
I 1.10.63

3.2 PLATFORM

Part No.	Description	
_____	Platform (not available complete)	
ECS 3x8	Screw	(4 off)
E14194	Capstan for PE1001 and PE1002, 50 c/s	
E14197	Capstan for PE1003 and PE1004, 60 c/s	
ECS 2.3x12	Screw	(4 off)
B10099/K1	Feed solenoid E14505	
ECS 2,3x4	Screw	(4 off)
BR 2.6x8x0.1	Washer Original-Odhner	(4 off)
B10099/K2	Brake solenoid E14506	
ECS 2.3x4	Screw	(4 off)
BR 2.6x8x0.1	Washer Original-Odhner	(4 off)
B10099/K3	Lid-latch solenoid E12063	
P6SS 3x6	Screw	(2 off)
E12111	Coil	(2 off)
E12066	Bar	
LB6LM 3	Nut	(2 off)
B10099/S1	Switch Honeywell 1SM1-T	
ECS 2.3x8	Screw	(2 off)
B10099/S2	Switch Honeywell 1SM1-T	
ECS 2.3x8	Screw	(2 off)
E11998	Shaft	
E12088/2	Knob	
E12089	Bracket	
B10099/S3	Switch Honeywell V3-19	
ECS 2.3x12	Screw	(2 off)
E12088	Knob	
E10001/27	Spacer	
E12089	Bracket	
B10099/S4	Switch Honeywell V3-19	
ECS 2.3x12	Screw	(2 off)
E12739	Leaf spring	(2 off)
ECS 2.3x4	Screw	(4 off)
D10436	Tape guide	
E12498	Handle	(2 off)
E12055	Bar	
E12056	Guide	(2 off)
E12059	Guide holder	
E12060	Guide head	
BRB 2.5x5	Washer	
ECS 3x5	Screw	(4 off)
ECS 2.3x5	Screw	

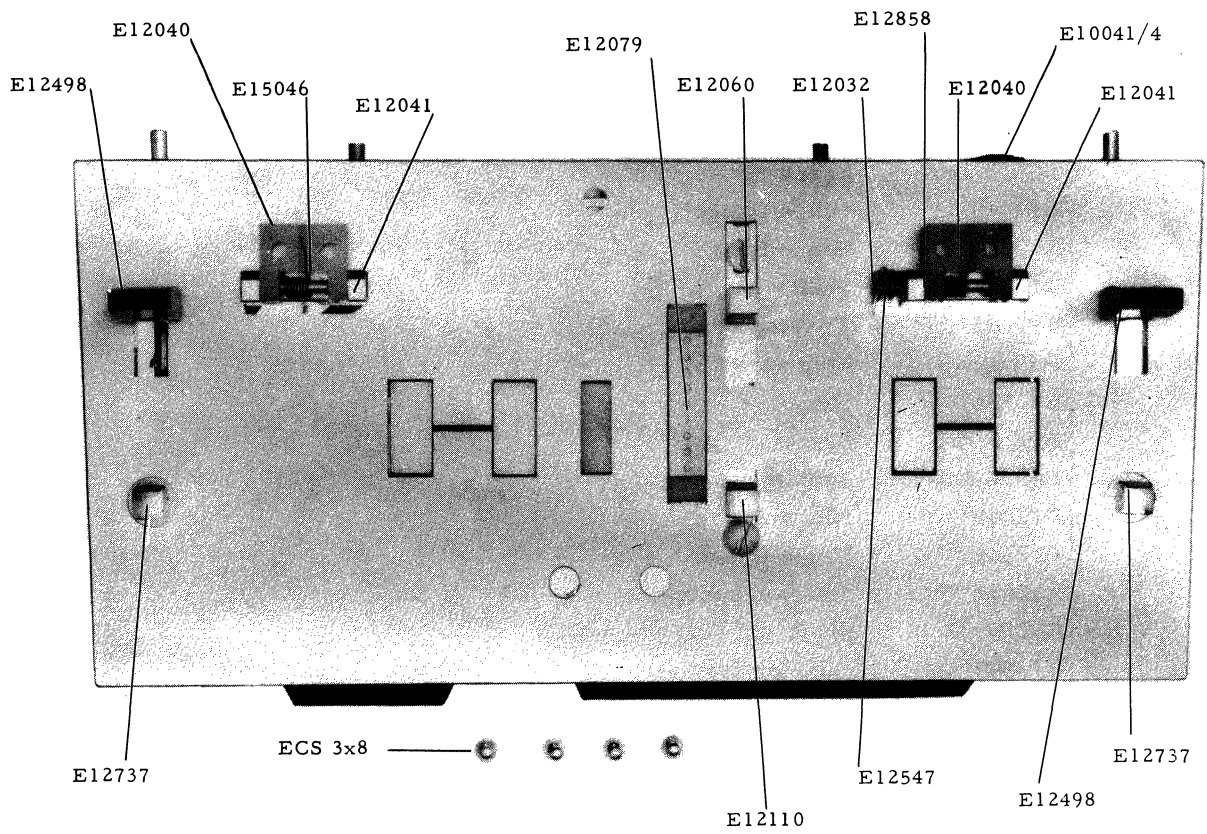

Platform, top view

UP 63 10 01
I 1.10.63

Part No.	Description	
E12079	Reading head	
ECS 2.3x4	Screw	
ECS 2.3x10	Screw	
E11203/2	Compression spring	
BRB 2.5x5	Washer	(2 off)
E12110	Guide head	
ECS 3x8	Screw	
E12737	Guide head	(2 off)
LB6LM 3	Nut	(2 off)
E12060	Guide head	
E15046	Hinge	
ECS 2.3x6	Screw	(2 off)
E12040	Hinge flange	
E12041	Hinge flange	
E12859	Shaft	
E15045	Torsion spring	
PSS 2.3x6	Stop screw	
E12858	Hinge	
ECS 2.3x6	Screw	(2 off)
PSS 2.3x5	Screw	
E12040	Hinge flange	
E12041	Hinge flange	
E12517	Torsion spring	
E12859/2	Shaft	
E12547	Bushing insulator	(2 off)
E12032	Torsion spring	
E10002/2	Washer	
E11498	Screw	
B10099/20	Solder tag	Göfarp 612-3.2
E10041/4	Bushing insulator	
E12498	Handle	(2 off)
D10436	Tape guide	

3.3 MOTOR

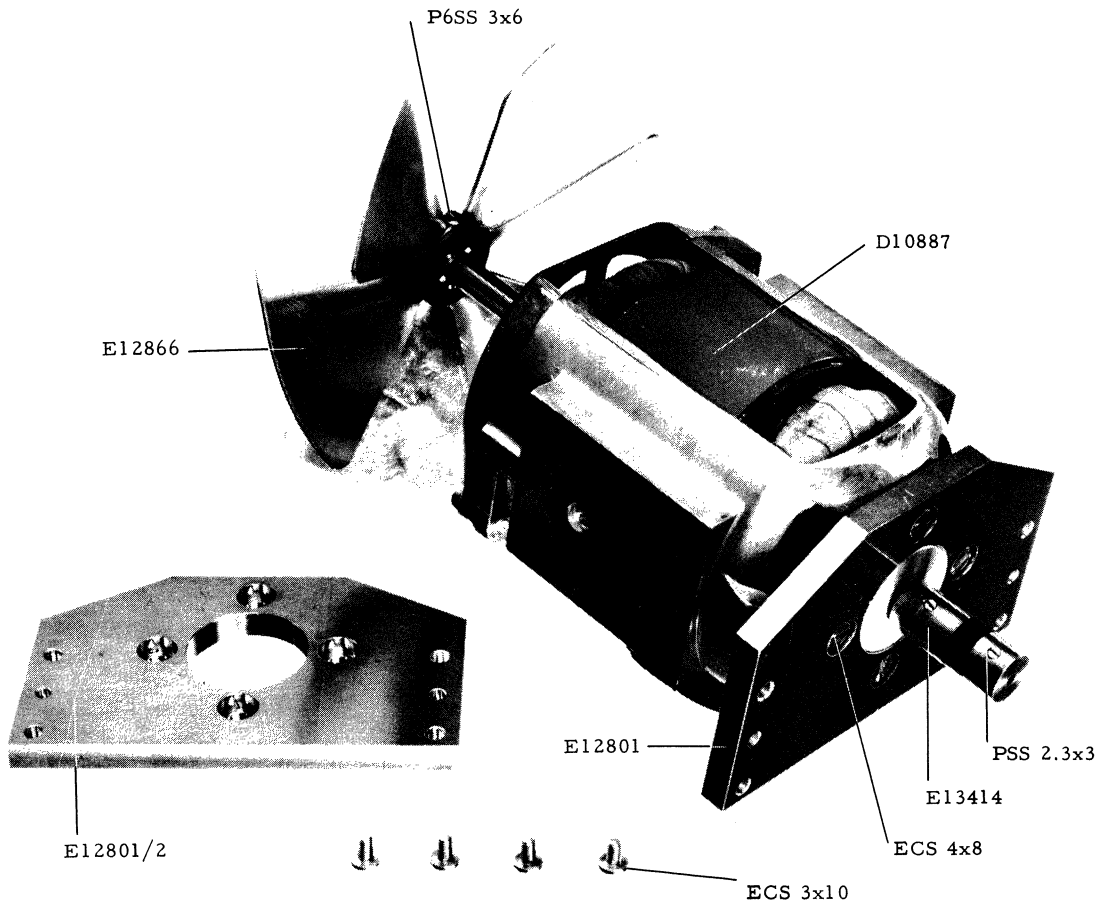

Part No.	Description	
D10887	Motor	
ECS 4x8	Screw	(4 off)
E12801	Attachment plate for PE1001 and PE1002	
E12801/2	Attachment plate for PE 1003 and PE1004	
ECS 3x10	Screw	(4 off)
E12866	Propeller	
P6SS 3x6	Screw	
E13414	Shaft coupling	
PSS 2.3x3	Screw	(4 off)

3.4 TRIMMER UNIT

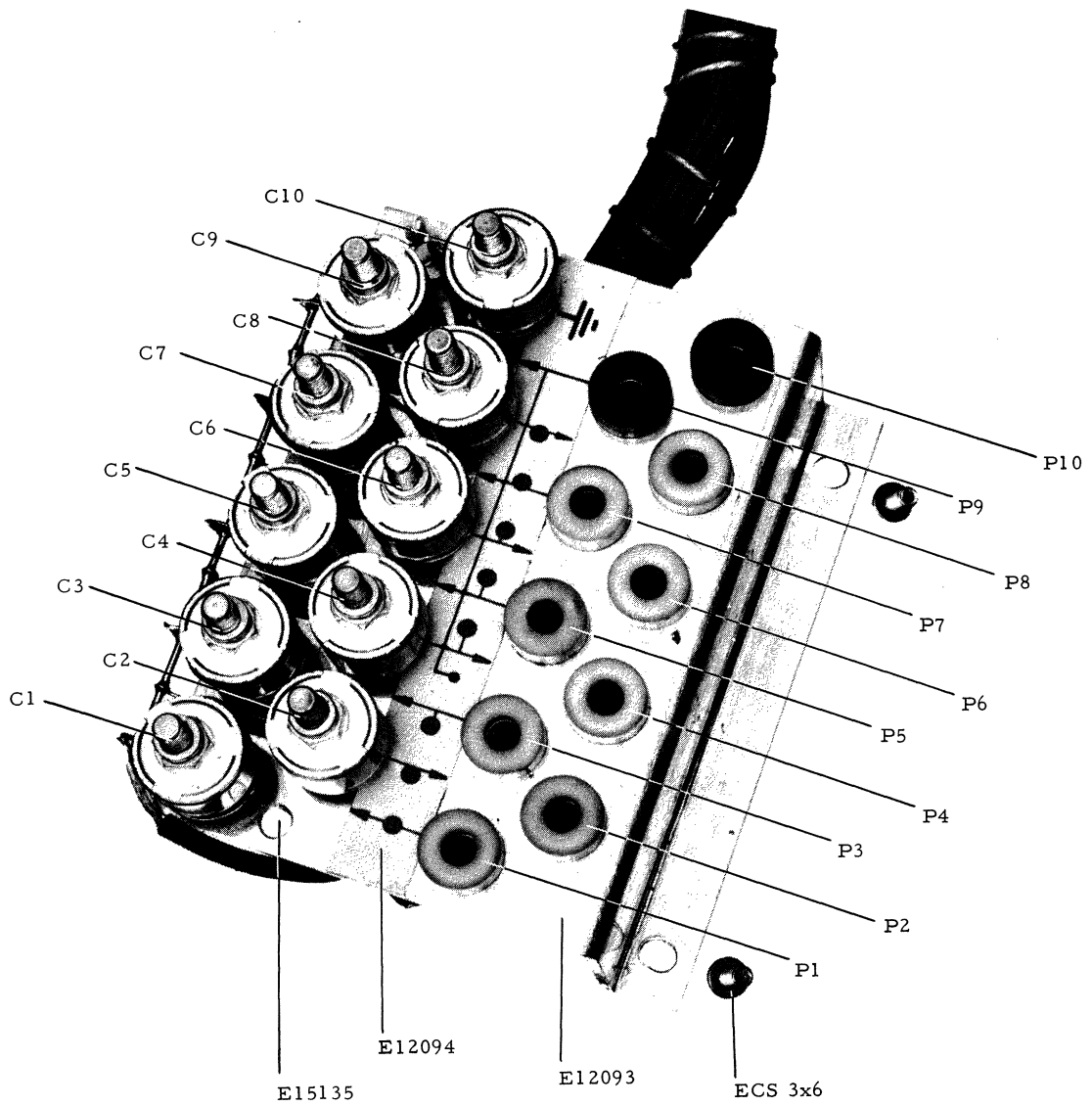

3.4 TRIMMER UNIT

Part No.	Description	
E12092	Trimmer unit, complete	
ECS 3x6	Screw	(2 off)
E12092/C1	Capacitor 4-25 pF	Philips C005AA/25E
E12092/C2	Capacitor 4-25 pF	Philips C005AA/25E
E12092/C3	Capacitor 4-25 pF	Philips C005AA/25E
E12092/C4	Capacitor 4-25 pF	Philips C005AA/25E
E12092/C5	Capacitor 4-25 pF	Philips C005AA/25E
E12092/C6	Capacitor 4-25 pF	Philips C005AA/25E
E12092/C7	Capacitor 4-25 pF	Philips C005AA/25E
E12092/C8	Capacitor 4-25 pF	Philips C005AA/25E
E12092/C9	Capacitor 4-25 pF	Philips C005AA/25E
E12092/C10	Capacitor 4-25 pF	Philips C005AA/25E
E12813	Protecting tube	(10)
E12092/P1	Jack bush	Elfa, J1085 yellow
E12092/P2	Jack bush	Elfa, J1085 yellow
E12092/P3	Jack bush	Elfa, J1085 yellow
E12092/P4	Jack bush	Elfa, J1085 yellow
E12092/P5	Jack bush	Elfa, J1085 yellow
E12092/P6	Jack bush	Elfa, J1085 yellow
E12092/P7	Jack bush	Elfa, J1085 yellow
E12092/P8	Jack bush	Elfa, J1085 yellow
E12092/P9	Jack bush	Elfa, J1085 red
E12092/P10	Jack bush	Elfa, J1085 black
E12093	Bracket	
E12094	Label	
E15135	Solder tag	(2 off)
ECS 3x6	Screw	
LB6LM 3	Nut	
E13548/8	Cable clip	
ECS 3x6	Screw	
LB6LM 3	Nut	
BRB 3.2x6	Washer	

3.5 OSCILLATOR UNIT

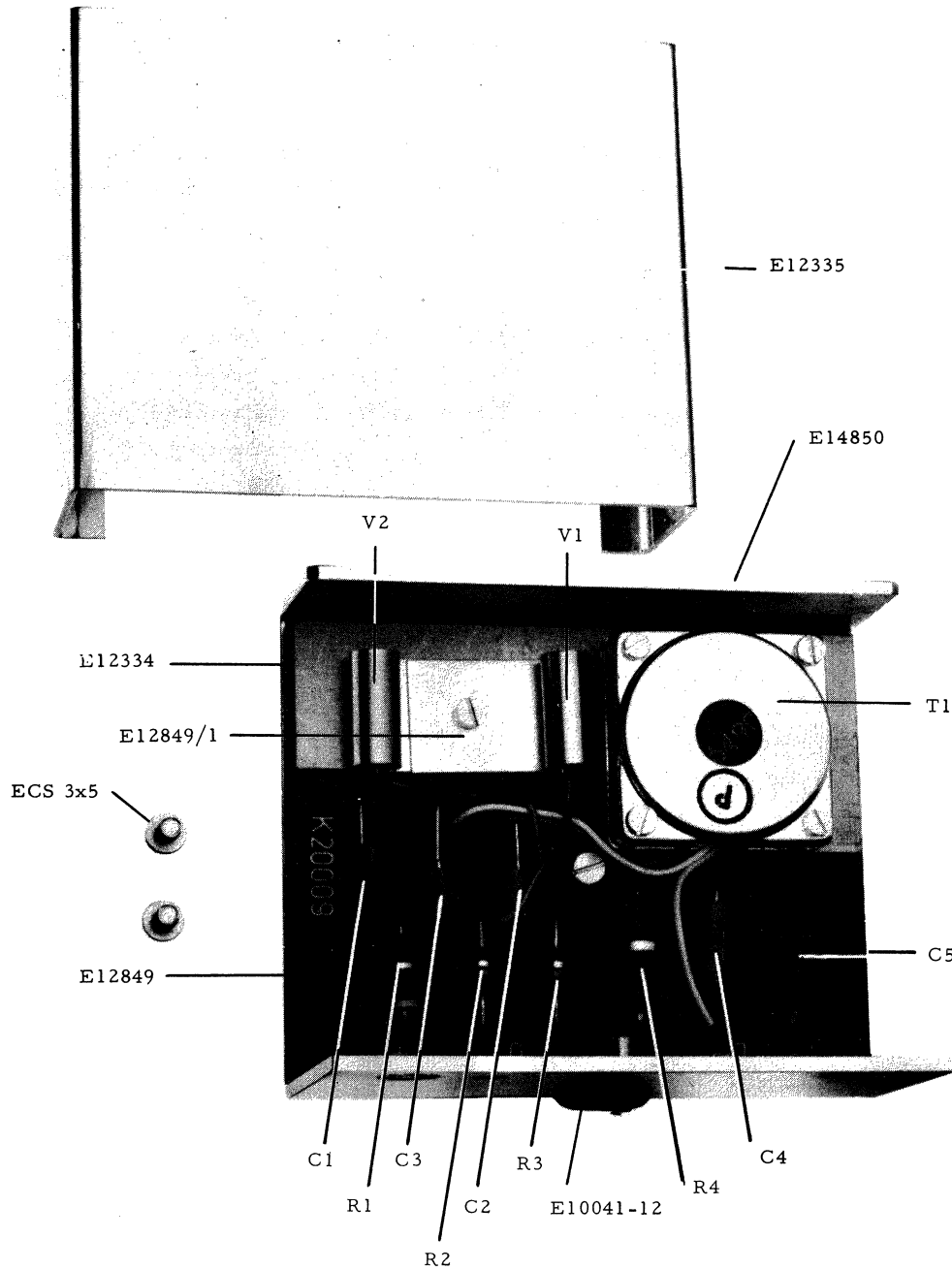

3.5 OSCILLATOR UNIT

Part No.	Description	
E12792	Oscillator unit, complete	
ECS 3x5	Screw	(2 off)
E14850	Bracket	
E10041-12	Bushing insulator	
E12334	Isolating plate	
E12335	Cover	
E12849	Oscillator board, complete	
E12794	Spacer	
ECS 2.3x6	Screw	
E12849/C1	Capacitor 4700 pF	Sprague Cer. 55C33 \pm 20 %
E12849/C2	Capacitor 1000 pF	Sprague Cer. 40C258 \pm 10 %
E12849/C3	Capacitor 1000 pF	Sprague Cer. 40C258 \pm 10 %
E12849/C4	Capacitor 1 μ F	Sprague Dry El. 105x0035
E12849/C5	Capacitor 47 pF	Dubilier SM22
E12849/R1	Resistor 470 ohm 1/2 W 10 %	Allen Bradley EB
E12849/R2	Resistor 10 kohm 1/4 W 10 %	Allen Bradley CB
E12849/R3	Resistor 10 kohm 1/4 W 10 %	Allen Bradley CB
E12849/R4	Resistor 22 ohm 1 W 10 %	Allen Bradley GB
E12849/T1	Transformer	E15122
LB6LM 2	Nut	(2 off)
E12849/V1	Transistor	Mullard OC83
E12849/V2	Transistor	Mullard OC83
E12849/1	Cooler	(2 off)
ECS 2x4	Screw	
LB6LM 2	Nut	

4 REEL HOLDER

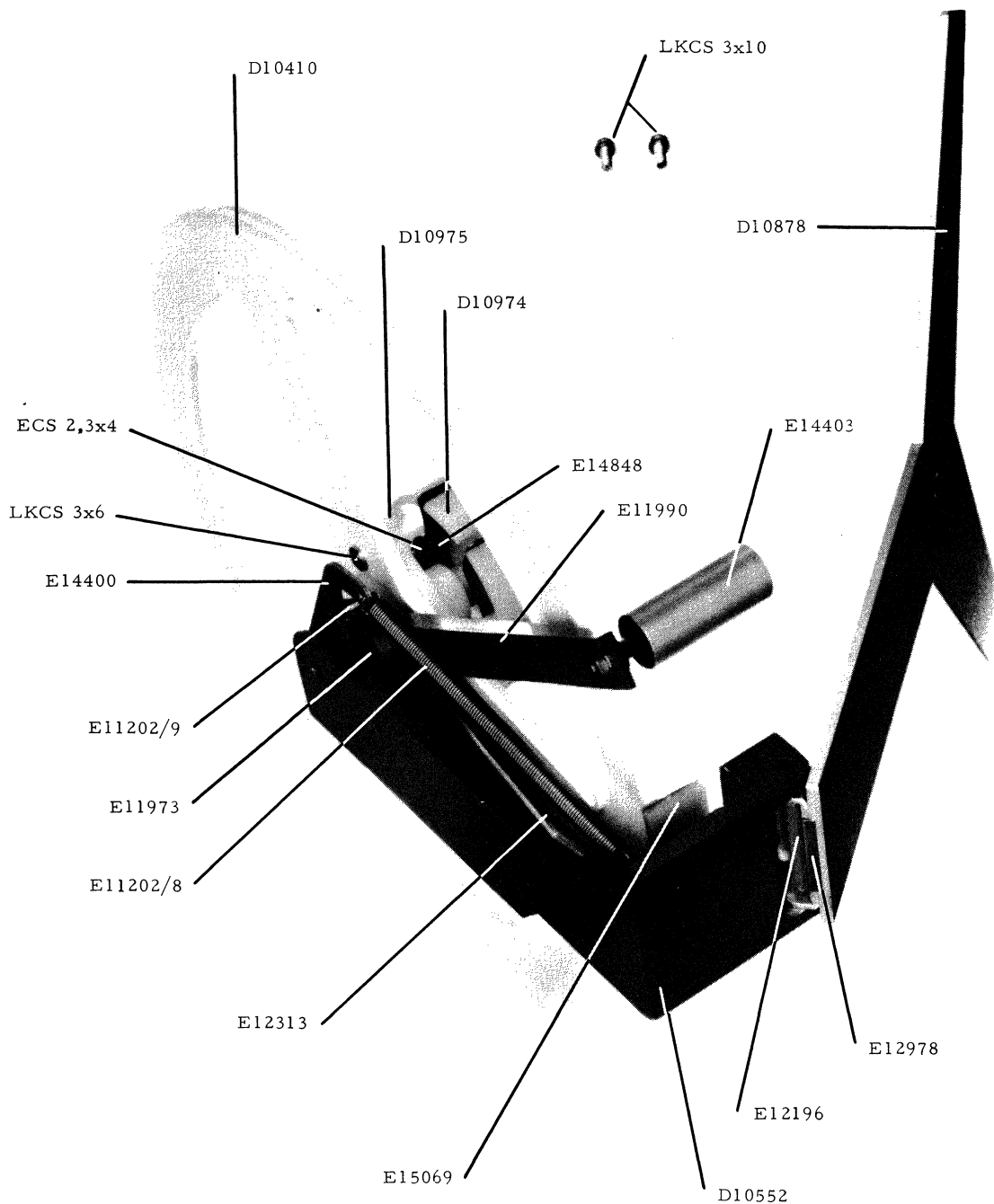

4 REEL HOLDER

Part No.	Description	
D10551	Reel holder	
LKCS 3x10	Screw	(2 off)
D10552	Bracket	
E11973	Shaft	
LKCS 2.3x5	Screw	
FS 2.3x6	Screw	
BRB 3.2x6x0.5 msg.	Washer	
E11976	Washer	
E14400	Arm	
E11202/9	Tension spring	
E11202/8	Tension spring	
E11990	Take-up arm	
E14403	Roller	
LB6LM 3	Nut	
BRB 3.2x6	Washer	
D10371	Hub, complete	
D10410	End plate	
D10974	Tape reel holder	
D10975	Boss	
LKCS 3x6	Screw	(3 off)
E14848	Leaf spring	(2 off)
ECS 2.3x4	Screw	(2 off)
E12313	Arm	
E15040	Shaft	
SMS1583 3.2	Circlip	(2 off)
E15069	Brake lip	
D10878	End plate	
E12196	Shaft	
SMS1583 1.9	Circlip	(2 off)
E12978	Leaf spring	
ECS 2.3x4	Screw	(2 off)
BRB 2.5x5	Washer	(2 off)

5 POWER UNIT

5.1 CABLE HARNESS AND SWITCHES

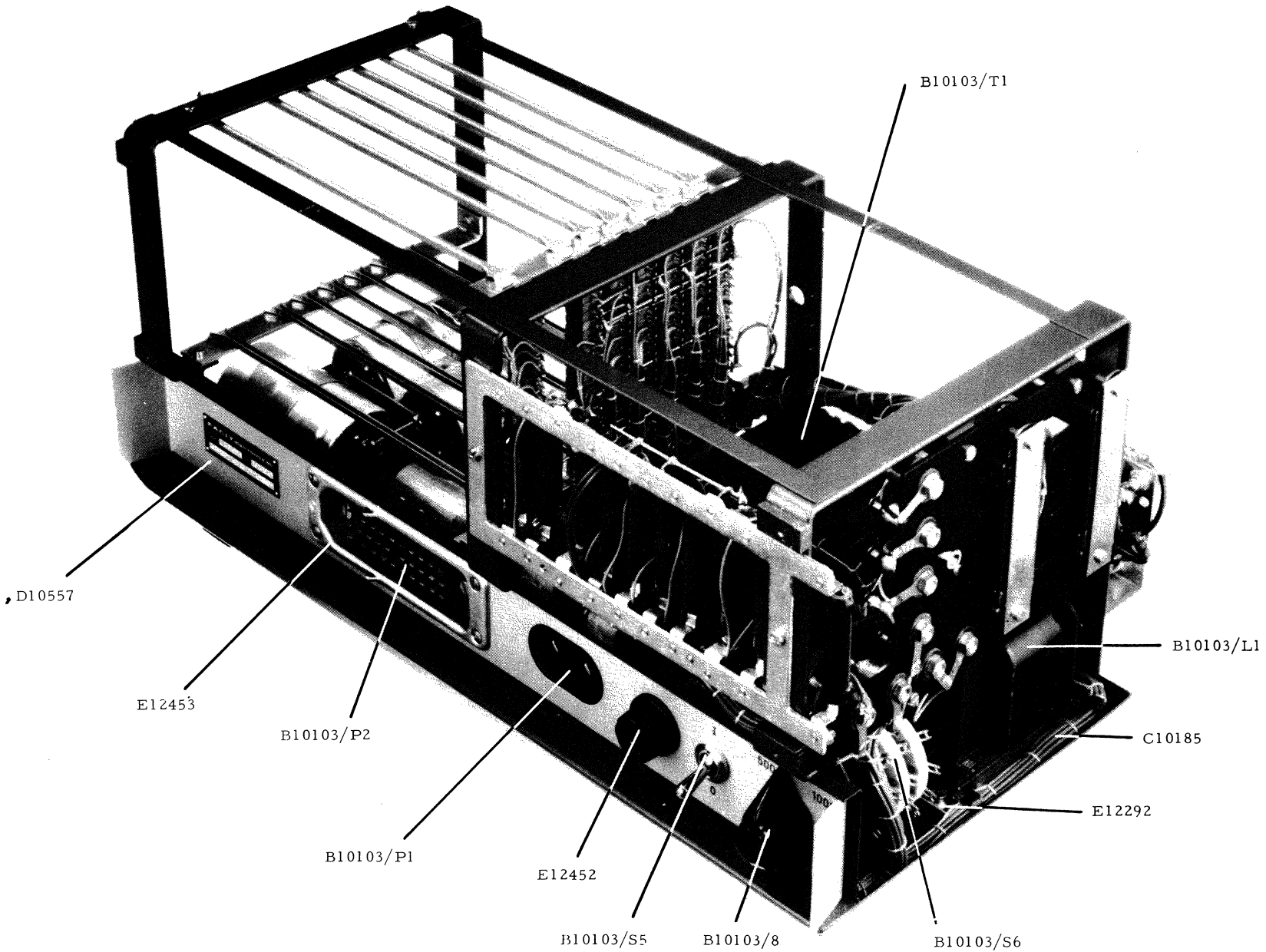

UP 63 10 01
I 1.10.63

5.1 CABLE HARNESS AND SWITCHES

Part No.	Description		
D10557	Cover border		
B10103/S6	Switch	E13031	
B10103/8	Knob	Philips CA/40 x 1/4"	
B10103/S5	Switch	E12485	
E12452	Fuse holder		
B10103/F1	Fuse 2A	Svensk Finsäkring 5x20 mm. (Glass fuse, 3/4 in.)	
B10103/P1	Inlet socket	KS 986-2	
E13673	Spacer		
ECS 4x30	Screw		
LB6LM 4	Nut		
B10103/P2	Socket	E12455	
ECS 4x10	Screw		(2 off)
LB6LM 4	Nut		(2 off)
E12453	Hood		
KFS 3x8	Screw		(4 off)
LB6LM 3	Nut		(4 off)
B10103/T1	Transformer	E14528	
PB6M 3/16"	Nut		(8 off)
E12292	Bar		(2 off)
ECS 4x6	Screw		(4 off)
B10103/L1	Choke	E14529	
ECS 3x4	Screw		(4 off)
C10185	Cable harness		
E13548	Cable clip		
E13548/2	Cable clip		(7 off)
E13548/6	Cable clip		
E13548/7	Cable clip		(2 off)
Standard parts for cable clips:			
ECS 3x6	Screw		(8 off)
ECS 3x8	Screw		(2 off)
FS 3x6	Screw		
LB6LM 3	Nut		(3 off)
BRB 3.2x6	Washer		(11 off)

5.2 DIODE AND CHOKE UNIT

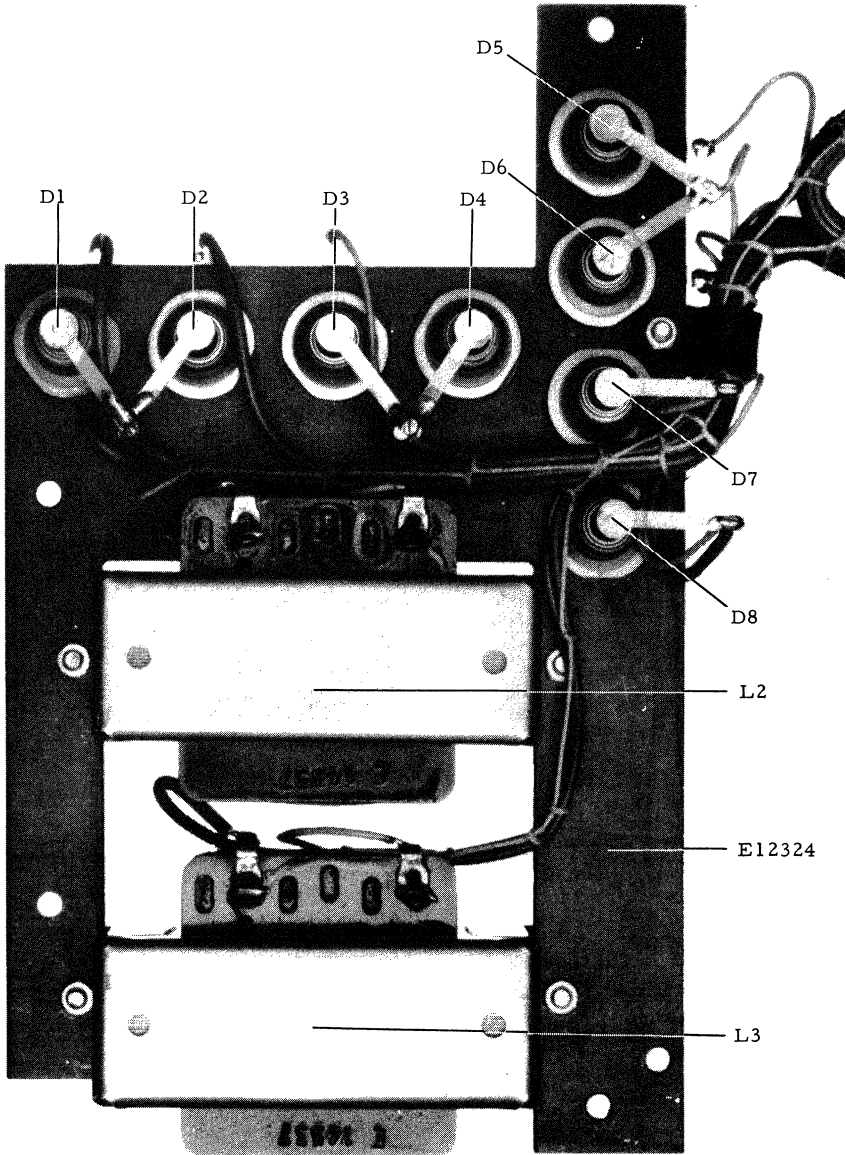

5.2 DIODE AND CHOKE UNIT

Part No.	Description		
E13024	Diode and choke unit, complete		
ECS 3x6	Screw		(4 off)
E12324	Mounting plate		
E13024/D1	Diode	Philips OA31	
E13024/D2	Diode	Philips OA31	
E13024/D3	Diode	Philips OA31	
E13024/D4	Diode	Philips OA31	
E13024/D5	Diode	Philips OA31	
E13024/D6	Diode	Philips OA31	
E13024/D7	Diode	Philips OA31	
E13024/D8	Diode	Philips OA31	
E11651	Mounting kit for D1-D8		(8 off)
E13024/L2	Choke	E14337	
E13024/L3	Choke	E14337	
ECS 3x12	Screw		(4 off)
LB6LM 3	Nut		(4 off)
E14017	Rod		(2 off)
E10001/24	Spacer		(4 off)

6 CIRCUIT BOARD UNIT

6.1 BOARD HOLDERS AND CONNECTORS

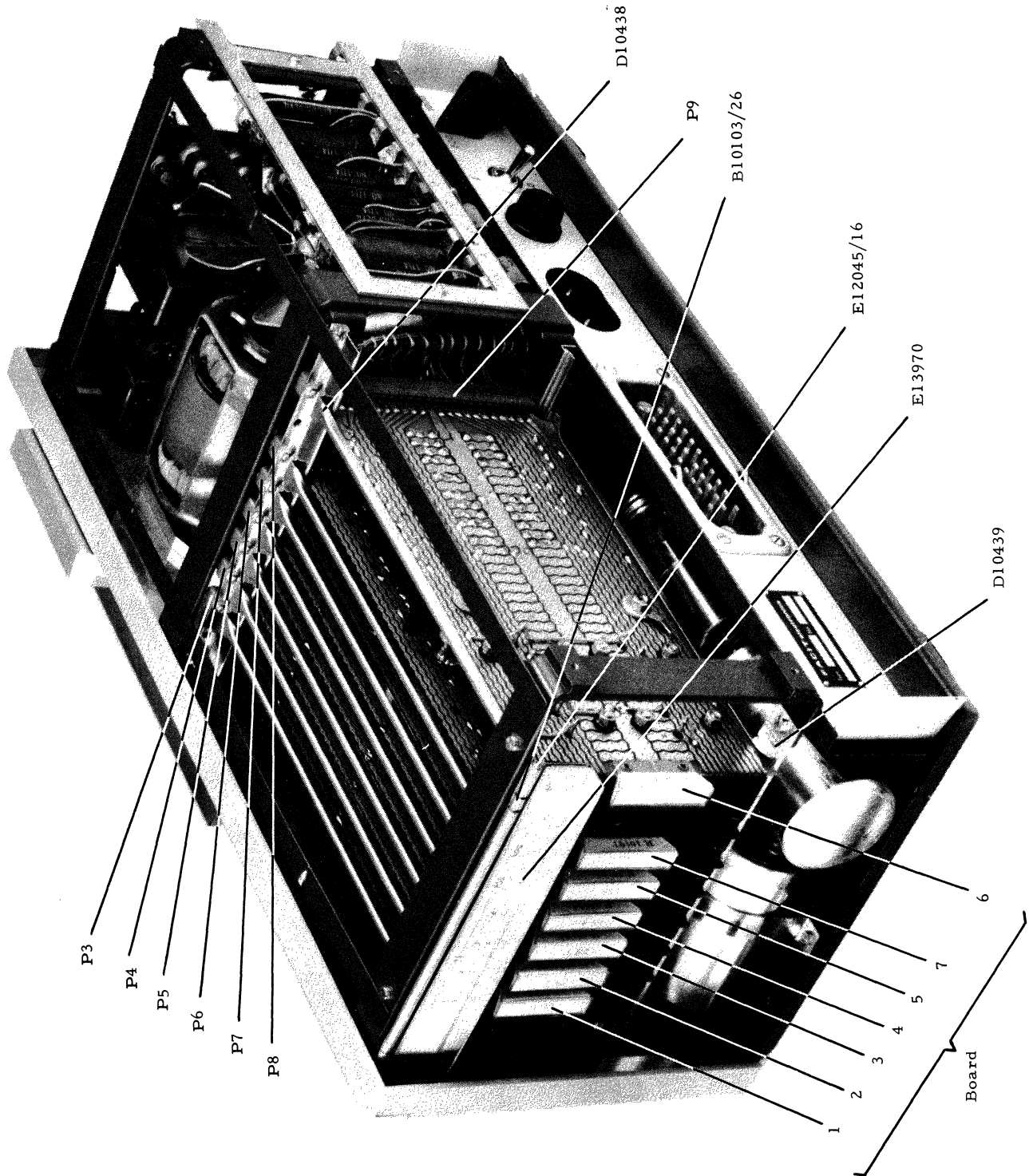

6.1 BOARD HOLDERS AND CONNECTORS

Part No.	Description		
B10103/P3	Board connector	Viking 2VH22/1AK5 with 0.375" pitch	
B10103/P4	Board connector	Viking 2VH22/1AK5 with 0.375" pitch	
B10103/P5	Board connector	Viking 2VH22/1AK5 with 0.375" pitch	
B10103/P6	Board connector	Viking 2VH22/1AK5 with 0.375" pitch	
B10103/P7	Board connector	Viking 2VH22/1AK5 with 0.375" pitch	
B10103/P8	Board connector	Viking 2VH22/1AK5 with 0.375" pitch	
B10103/P9	Board connector	Viking 2VH22/1AK5 with 0.375" pitch	
ECS 3x10	Screw		(14 off)
LB6LM 3	Nut		(14 off)
D10438	Card support, top		
ECS 3x6	Screw		(2 off)
ECS 3x8	Screw		(2 off)
LB6LM 3	Nut		(4 off)
D10439	Card support, bottom		
ECS 3x4	Screw		(2 off)
ECS 3x8	Screw		(2 off)
LB6LM 3	Nut		(2 off)
E13970	Bar		
E12045/16	Shaft		
B10103/26	Gri	Harry Stickler G 2.5x0.6	(2 off)

6.2 CIRCUIT BOARDS

6.2.1 BOARD No. 1

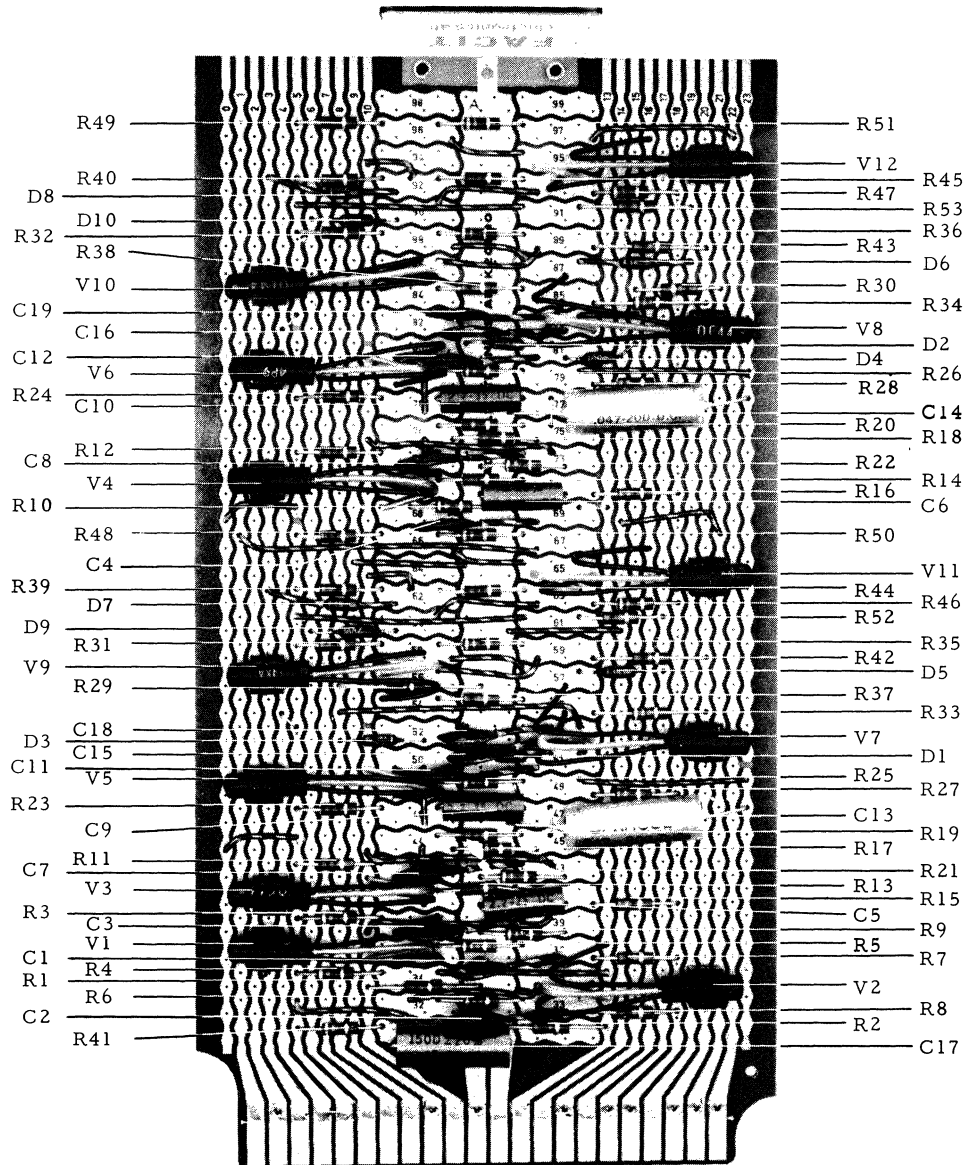

6.2.1 BOARD No. 1

Part No.	Description	
H10194	Circuit board No. 1, complete	
H10194/V1	Transistor Philips OC44	
H10194/V2	Transistor Philips OC44	
H10194/V3	Transistor Philips OC44	
H10194/V4	Transistor Philips OC44	
H10194/V5	Transistor Philips OC44	
H10194/V6	Transistor Philips OC44	
H10194/V7	Transistor Philips OC44	
H10194/V8	Transistor Philips OC44	
H10194/V9	Transistor Philips OC44	
H10194/V10	Transistor Philips OC44	
H10194/V11	Transistor Philips OC44	
H10194/V12	Transistor Philips OC44	
E12105	Transistor Mounting Clip	
H10194/D1	Diode Philips AAZ15	
H10194/D2	Diode Philips AAZ15	
H10194/D3	Diode Philips AAZ15	
H10194/D4	Diode Philips AAZ15	
H10194/D5	Diode Philips AAZ15	
H10194/D6	Diode Philips AAZ15	
H10194/D7	Diode Philips AAZ15	
H10194/D8	Diode Philips AAZ15	
H10194/D9	Diode Philips AAZ15	
H10194/D10	Diode Philips AAZ15	
H10194/R1	Resistor 10 kohm 1/4 W 10 %	Allen Bradley CB
H10194/R2	Resistor 10 kohm 1/4 W 10 %	Allen Bradley CB
H10194/R3	Resistor 4.7 kohm 1/4 W 10 %	Allen Bradley CB
H10194/R4	Resistor 4.7 kohm 1/4 W 10 %	Allen Bradley CB
H10194/R5	Resistor 470 ohm 1/4 W 10 %	Allen Bradley CB
H10194/R6	Resistor 470 ohm 1/4 W 10 %	Allen Bradley CB
H10194/R7	Resistor 10 kohm 1/4 W 10 %	Allen Bradley CB
H10194/R8	Resistor 10 kohm 1/4 W 10 %	Allen Bradley CB
H10194/R9	Resistor 4.7 kohm 1/4 W 10 %	Allen Bradley CB
H10194/R10	Resistor 4.7 kohm 1/4 W 10 %	Allen Bradley CB
H10194/R11	Resistor 2.2 kohm 1/4 W 10 %	Allen Bradley CB
H10194/R12	Resistor 2.2 kohm 1/4 W 10 %	Allen Bradley CB
H10194/R13	Resistor 22 ohm 1/4 W 10 %	Allen Bradley CB
H10194/R14	Resistor 22 ohm 1/4 W 10 %	Allen Bradley CB
H10194/R15	Resistor 3.3 kohm 1/4 W 10 %	Allen Bradley CB
H10194/R16	Resistor 3.3 kohm 1/4 W 10 %	Allen Bradley CB

(12)

Part No.	Description	
H10194/R17	Resistor 2.2 kohm 1/4 W 10 %	Allen Bradley CB
H10194/R18	Resistor 2.2 kohm 1/4 W 10 %	Allen Bradley CB
H10194/R19	Resistor, selected after test	
H10194/R20	Resistor, selected after test	
H10194/R21	Resistor 4.7 kohm 1/4 W 10 %	Allen Bradley CB
H10194/R22	Resistor 4.7 kohm 1/4 W 10 %	Allen Bradley CB
H10194/R23	Resistor 2.2 kohm 1/4 W 10 %	Allen Bradley CB
H10194/R24	Resistor 2.2 kohm 1/4 W 10 %	Allen Bradley CB
H10194/R25	Resistor 47 ohm 1/4 W 10 %	Allen Bradley CB
H10194/R26	Resistor 47 ohm 1/4 W 10 %	Allen Bradley CB
H10194/R27	Resistor 3.3 kohm 1/4 W 10 %	Allen Bradley CB
H10194/R28	Resistor 3.3 kohm 1/4 W 10 %	Allen Bradley CB
H10194/R29	Resistor 10 kohm 1/4 W 10 %	Allen Bradley CB
H10194/R30	Resistor 10 kohm 1/4 W 10 %	Allen Bradley CB
H10194/R31	Resistor 1.5 kohm 1/4 W 10 %	Allen Bradley CB
H10194/R32	Resistor 1.5 kohm 1/4 W 10 %	Allen Bradley CB
H10194/R33	Resistor 470 ohm 1/4 W 10 %	Allen Bradley CB
H10194/R34	Resistor 470 ohm 1/4 W 10 %	Allen Bradley CB
H10194/R35	Resistor 4.7 kohm 1/4 W 10 %	Allen Bradley CB
H10194/R36	Resistor 4.7 kohm 1/4 W 10 %	Allen Bradley CB
H10194/R37	Resistor 100 ohm 1/4 W 10 %	Allen Bradley CB
H10194/R38	Resistor 100 ohm 1/4 W 10 %	Allen Bradley CB
H10194/R39	Resistor 1.5 kohm 1/4 W 10 %	Allen Bradley CB
H10194/R40	Resistor 1.5 kohm 1/4 W 10 %	Allen Bradley CB
H10194/R41	Resistor 47 ohm 1/4 W 10 %	Allen Bradley CB
H10194/R42	Resistor 10 kohm 1/4 W 10 %	Allen Bradley CB
H10194/R43	Resistor 10 kohm 1/4 W 10 %	Allen Bradley CB
H10194/R44	Resistor 2.2 kohm 1/4 W 10 %	Allen Bradley CB
H10194/R45	Resistor 2.2 kohm 1/4 W 10 %	Allen Bradley CB
H10194/R46	Resistor 4.7 kohm 1/4 W 10 %	Allen Bradley CB
H10194/R47	Resistor 4.7 kohm 1/4 W 10 %	Allen Bradley CB
H10194/R48	Resistor 1 kohm 1/4 W 10 %	Allen Bradley CB
H10194/R49	Resistor 1 kohm 1/4 W 10 %	Allen Bradley CB
H10194/R50	Resistor 47 ohm 1/4 W 10 %	Allen Bradley CB
H10194/R51	Resistor 47 ohm 1/4 W 10 %	Allen Bradley CB
H10194/R52	Resistor 10 kohm 1/4 W 10 %	Allen Bradley CB
H10194/R53	Resistor 10 kohm 1/4 W 10 %	Allen Bradley CB
H10194/C1	Capacitor 4700 pF	Sprague Cer. 55C33 ± 20 %
H10194/C2	Capacitor 4700 pF	Sprague Cer. 55C33 ± 20 %
H10194/C3	Capacitor 4700 pF	Sprague Cer. 55C33 ± 20 %

Part No.	Description	
H10194/C4	Capacitor 4700 pF	Sprague Cer. 55C33 \pm 20 %
H10194/C5	Capacitor 2.2 μ F	Sprague Dry El. 225x0035
H10194/C6	Capacitor 2.2 μ F	Sprague Dry El. 225x0035
H10194/C7	Capacitor 4700 pF	Sprague Cer. 55C33 \pm 20 %
H10194/C8	Capacitor 4700 pF	Sprague Cer. 55C33 \pm 20 %
H10194/C9	Capacitor 2.2 μ F	Sprague Dry El. 225x0035
H10194/C10	Capacitor 2.2 μ F	Sprague Dry El. 225x0035
H10194/C11	Capacitor 4700 pF	Sprague Cer. 55C33 \pm 20 %
H10194/C12	Capacitor 4700 pF	Sprague Cer. 55C33 \pm 20 %
H10194/C13	Capacitor 0.047 μ F	Sprague MP 118P S4
H10194/C14	Capacitor 0.047 μ F	Sprague MP 118P S4
H10194/C15	Capacitor 4700 pF	Sprague Cer. 55C33 \pm 20 %
H10194/C16	Capacitor 4700 pF	Sprague Cer. 55C33 \pm 20 %
H10194/C17	Capacitor 47 μ F	Sprague Dry El. 476x0020
H10194/C18	Capacitor 4700 pF	Sprague Cer. 55C33 \pm 20 %
H10194/C19	Capacitor 4700 pF	Sprague Cer. 55C33 \pm 20 %
E13250	Label	

6.2.2 BOARD No. 2

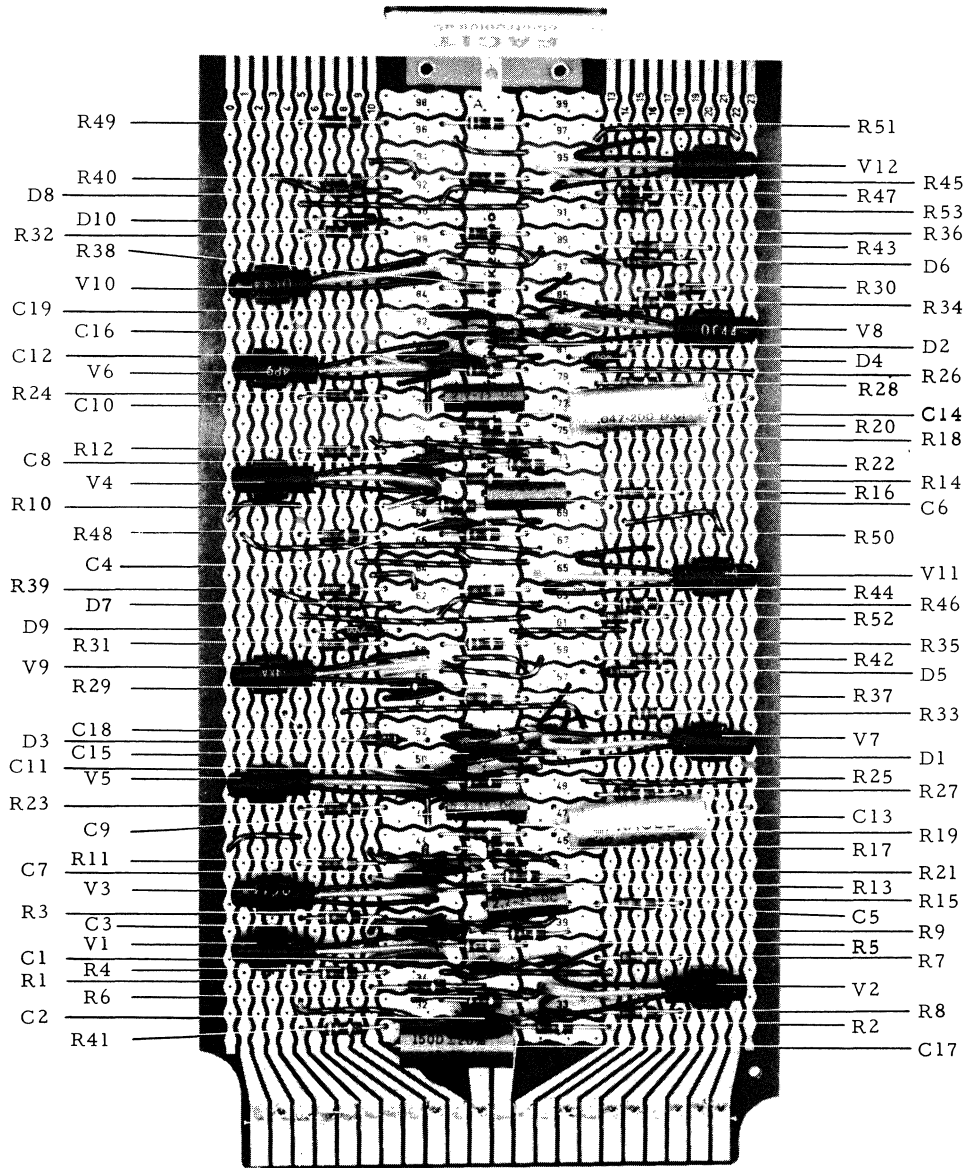

6.2.2 BOARD No. 2

Part No.	Description	
H10194	Circuit board No. 2, complete	
H10194/V1	Transistor Philips OC44	
H10194/V2	Transistor Philips OC44	
H10194/V3	Transistor Philips OC44	
H10194/V4	Transistor Philips OC44	
H10194/V5	Transistor Philips OC44	
H10194/V6	Transistor Philips OC44	
H10194/V7	Transistor Philips OC44	
H10194/V8	Transistor Philips OC44	
H10194/V9	Transistor Philips OC44	
H10194/V10	Transistor Philips OC44	
H10194/V11	Transistor Philips OC44	
H10194/V12	Transistor Philips OC44	
E12105	Transistor Mounting Clip	
H10194/D1	Diode Philips AAZ15	
H10194/D2	Diode Philips AAZ15	
H10194/D3	Diode Philips AAZ15	
H10194/D4	Diode Philips AAZ15	
H10194/D5	Diode Philips AAZ15	
H10194/D6	Diode Philips AAZ15	
H10194/D7	Diode Philips AAZ15	
H10194/D8	Diode Philips AAZ15	
H10194/D9	Diode Philips AAZ15	
H10194/D10	Diode Philips AAZ15	
H10194/R1	Resistor 10 kohm 1/4 W 10 %	Allen Bradley CB
H10194/R2	Resistor 10 kohm 1/4 W 10 %	Allen Bradley CB
H10194/R3	Resistor 4.7 kohm 1/4 W 10 %	Allen Bradley CB
H10194/R4	Resistor 4.7 kohm 1/4 W 10 %	Allen Bradley CB
H10194/R5	Resistor 470 ohm 1/4 W 10 %	Allen Bradley CB
H10194/R6	Resistor 470 ohm 1/4 W 10 %	Allen Bradley CB
H10194/R7	Resistor 10 kohm 1/4 W 10 %	Allen Bradley CB
H10194/R8	Resistor 10 kohm 1/4 W 10 %	Allen Bradley CB
H10194/R9	Resistor 4.7 kohm 1/4 W 10 %	Allen Bradley CB
H10194/R10	Resistor 4.7 kohm 1/4 W 10 %	Allen Bradley CB
H10194/R11	Resistor 2.2 kohm 1/4 W 10 %	Allen Bradley CB
H10194/R12	Resistor 2.2 kohm 1/4 W 10 %	Allen Bradley CB
H10194/R13	Resistor 22 ohm 1/4 W 10 %	Allen Bradley CB
H10194/R14	Resistor 22 ohm 1/4 W 10 %	Allen Bradley CB
H10194/R15	Resistor 3.3 kohm 1/4 W 10 %	Allen Bradley CB
H10194/R16	Resistor 3.3 kohm 1/4 W 10 %	Allen Bradley CB

(12 out)

Part No.	Description	
H10194/R17	Resistor 2.2 kohm 1/4 W 10 %	Allen Bradley CB
H10194/R18	Resistor 2.2 kohm 1/4 W 10 %	Allen Bradley CB
H10194/R19	Resistor, selected after test	
H10194/R20	Resistor, selected after test	
H10194/R21	Resistor 4.7 kohm 1/4 W 10 %	Allen Bradley CB
H10194/R22	Resistor 4.7 kohm 1/4 W 10 %	Allen Bradley CB
H10194/R23	Resistor 2.2 kohm 1/4 W 10 %	Allen Bradley CB
H10194/R24	Resistor 2.2 kohm 1/4 W 10 %	Allen Bradley CB
H10194/R25	Resistor 47 ohm 1/4 W 10 %	Allen Bradley CB
H10194/R26	Resistor 47 ohm 1/4 W 10 %	Allen Bradley CB
H10194/R27	Resistor 3.3 kohm 1/4 W 10 %	Allen Bradley CB
H10194/R28	Resistor 3.3 kohm 1/4 W 10 %	Allen Bradley CB
H10194/R29	Resistor 10 kohm 1/4 W 10 %	Allen Bradley CB
H10194/R30	Resistor 10 kohm 1/4 W 10 %	Allen Bradley CB
H10194/R31	Resistor 1.5 kohm 1/4 W 10 %	Allen Bradley CB
H10194/R32	Resistor 1.5 kohm 1/4 W 10 %	Allen Bradley CB
H10194/R33	Resistor 470 ohm 1/4 W 10 %	Allen Bradley CB
H10194/R34	Resistor 470 ohm 1/4 W 10 %	Allen Bradley CB
H10194/R35	Resistor 4.7 kohm 1/4 W 10 %	Allen Bradley CB
H10194/R36	Resistor 4.7 kohm 1/4 W 10 %	Allen Bradley CB
H10194/R37	Resistor 100 ohm 1/4 W 10 %	Allen Bradley CB
H10194/R38	Resistor 100 ohm 1/4 W 10 %	Allen Bradley CB
H10194/R39	Resistor 1.5 kohm 1/4 W 10 %	Allen Bradley CB
H10194/R40	Resistor 1.5 kohm 1/4 W 10 %	Allen Bradley CB
H10194/R41	Resistor 47 ohm 1/4 W 10 %	Allen Bradley CB
H10194/R42	Resistor 10 kohm 1/4 W 10 %	Allen Bradley CB
H10194/R43	Resistor 10 kohm 1/4 W 10 %	Allen Bradley CB
H10194/R44	Resistor 2.2 kohm 1/4 W 10 %	Allen Bradley CB
H10194/R45	Resistor 2.2 kohm 1/4 W 10 %	Allen Bradley CB
H10194/R46	Resistor 4.7 kohm 1/4 W 10 %	Allen Bradley CB
H10194/R47	Resistor 4.7 kohm 1/4 W 10 %	Allen Bradley CB
H10194/R48	Resistor 1 kohm 1/4 W 10 %	Allen Bradley CB
H10194/R49	Resistor 1 kohm 1/4 W 10 %	Allen Bradley CB
H10194/R50	Resistor 47 ohm 1/4 W 10 %	Allen Bradley CB
H10194/R51	Resistor 47 ohm 1/4 W 10 %	Allen Bradley CB
H10194/R52	Resistor 10 kohm 1/4 W 10 %	Allen Bradley CB
H10194/R53	Resistor 10 kohm 1/4 W 10 %	Allen Bradley CB
H10194/C1	Capacitor 4700 pF	Sprague Cer. 55C33 ± 20 %
H10194/C2	Capacitor 4700 pF	Sprague Cer. 55C33 ± 20 %
H10194/C3	Capacitor 4700 pF	Sprague Cer. 55C33 ± 20 %

Part No.	Description	
H10194/C4	Capacitor 4700 pF	Sprague Cer. 55C33 \pm 20 %
H10194/C5	Capacitor 2.2 μ F	Sprague Dry El. 225x0035
H10194/C6	Capacitor 2.2 μ F	Sprague Dry El. 225x0035
H10194/C7	Capacitor 4700 pF	Sprague Cer. 55C33 \pm 20 %
H10194/C8	Capacitor 4700 pF	Sprague Cer. 55C33 \pm 20 %
H10194/C9	Capacitor 2.2 μ F	Sprague Dry El. 225x0035
H10194/C10	Capacitor 2.2 μ F	Sprague Dry El. 225x0035
H10194/C11	Capacitor 4700 pF	Sprague Cer. 55C33 \pm 20 %
H10194/C12	Capacitor 4700 pF	Sprague Cer. 55C33 \pm 20 %
H10194/C13	Capacitor 0.047 μ F	Sprague MP 118P S4
H10194/C14	Capacitor 0.047 μ F	Sprague MP 118P S4
H10194/C15	Capacitor 4700 pF	Sprague Cer. 55C33 \pm 20 %
H10194/C16	Capacitor 4700 pF	Sprague Cer. 55C33 \pm 20 %
H10194/C17	Capacitor 47 μ F	Sprague Dry El. 476x0020
H10194/C18	Capacitor 4700 pF	Sprague Cer. 55C33 \pm 20 %
H10194/C19	Capacitor 4700 pF	Sprague Cer. 55C33 \pm 20 %
E13250	Label	

6.2.3 BOARD No. 3

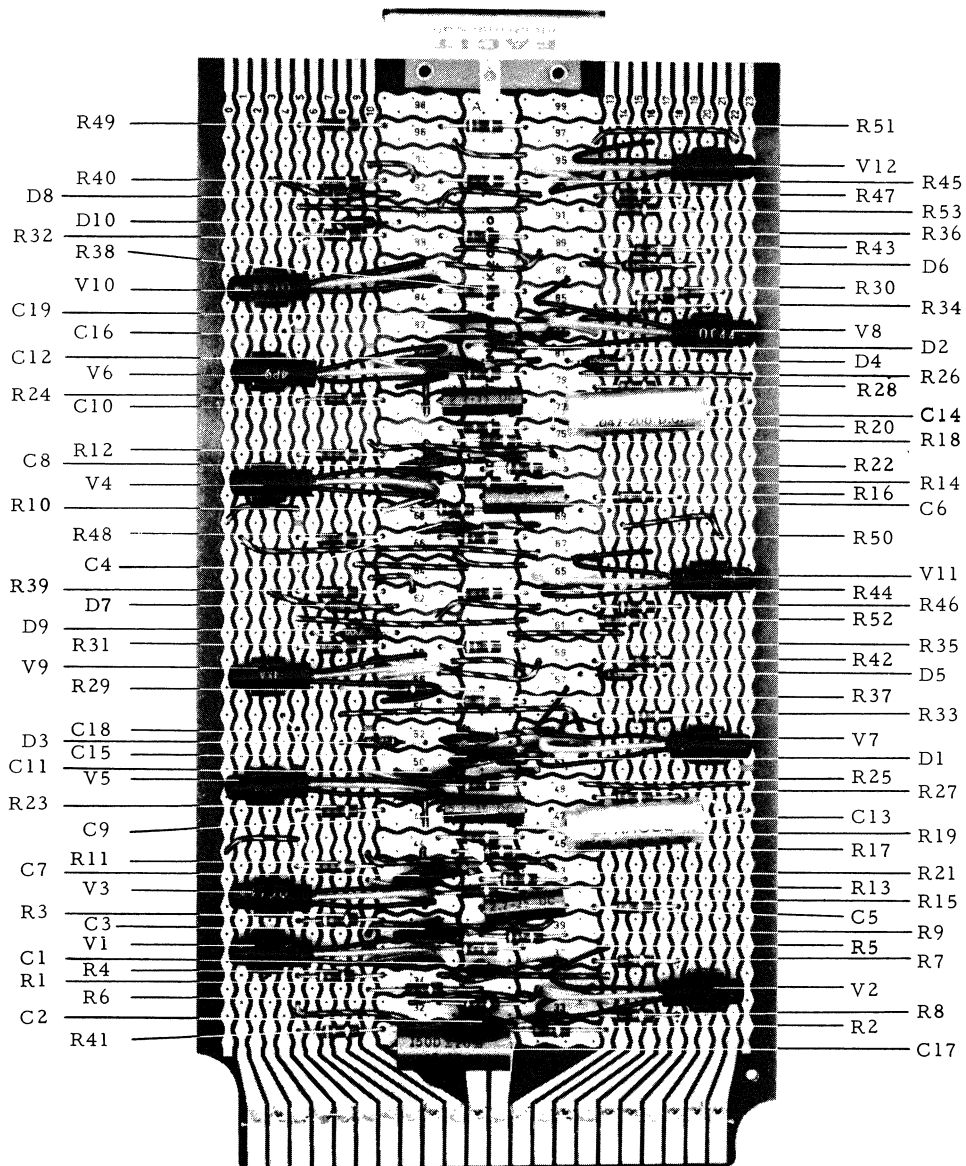

6.2.3 BOARD No. 3

Part No.	Description	
H10194	Circuit board No. 3, complete	
H10194/V1	Transistor Philips OC44	
H10194/V2	Transistor Philips OC44	
H10194/V3	Transistor Philips OC44	
H10194/V4	Transistor Philips OC44	
H10194/V5	Transistor Philips OC44	
H10194/V6	Transistor Philips OC44	
H10194/V7	Transistor Philips OC44	
H10194/V8	Transistor Philips OC44	
H10194/V9	Transistor Philips OC44	
H10194/V10	Transistor Philips OC44	
H10194/V11	Transistor Philips OC44	
H10194/V12	Transistor Philips OC44	
E12105	Transistor Mounting Clip	(12 ...)
H10194/D1	Diode Philips AAZ15	
H10194/D2	Diode Philips AAZ15	
H10194/D3	Diode Philips AAZ15	
H10194/D4	Diode Philips AAZ15	
H10194/D5	Diode Philips AAZ15	
H10194/D6	Diode Philips AAZ15	
H10194/D7	Diode Philips AAZ15	
H10194/D8	Diode Philips AAZ15	
H10194/D9	Diode Philips AAZ15	
H10194/D10	Diode Philips AAZ15	
H10194/R1	Resistor 10 kohm 1/4 W 10 %	Allen Bradley CB
H10194/R2	Resistor 10 kohm 1/4 W 10 %	Allen Bradley CB
H10194/R3	Resistor 4.7 kohm 1/4 W 10 %	Allen Bradley CB
H10194/R4	Resistor 4.7 kohm 1/4 W 10 %	Allen Bradley CB
H10194/R5	Resistor 470 ohm 1/4 W 10 %	Allen Bradley CB
H10194/R6	Resistor 470 ohm 1/4 W 10 %	Allen Bradley CB
H10194/R7	Resistor 10 kohm 1/4 W 10 %	Allen Bradley CB
H10194/R8	Resistor 10 kohm 1/4 W 10 %	Allen Bradley CB
H10194/R9	Resistor 4.7 kohm 1/4 W 10 %	Allen Bradley CB
H10194/R10	Resistor 4.7 kohm 1/4 W 10 %	Allen Bradley CB
H10194/R11	Resistor 2.2 kohm 1/4 W 10 %	Allen Bradley CB
H10194/R12	Resistor 2.2 kohm 1/4 W 10 %	Allen Bradley CB
H10194/R13	Resistor 22 ohm 1/4 W 10 %	Allen Bradley CB
H10194/R14	Resistor 22 ohm 1/4 W 10 %	Allen Bradley CB
H10194/R15	Resistor 3.3 kohm 1/4 W 10 %	Allen Bradley CB
H10194/R16	Resistor 3.3 kohm 1/4 W 10 %	Allen Bradley CB

Part No.	Description	
H10194/R17	Resistor 2.2 kohm 1/4 W 10 %	Allen Bradley CB
H10194/R18	Resistor 2.2 kohm 1/4 W 10 %	Allen Bradley CB
H10194/R19	Resistor, selected after test	
H10194/R20	Resistor, selected after test	
H10194/R21	Resistor 4.7 kohm 1/4 W 10 %	Allen Bradley CB
H10194/R22	Resistor 4.7 kohm 1/4 W 10 %	Allen Bradley CB
H10194/R23	Resistor 2.2 kohm 1/4 W 10 %	Allen Bradley CB
H10194/R24	Resistor 2.2 kohm 1/4 W 10 %	Allen Bradley CB
H10194/R25	Resistor 47 ohm 1/4 W 10 %	Allen Bradley CB
H10194/R26	Resistor 47 ohm 1/4 W 10 %	Allen Bradley CB
H10194/R27	Resistor 3.3 kohm 1/4 W 10 %	Allen Bradley CB
H10194/R28	Resistor 3.3 kohm 1/4 W 10 %	Allen Bradley CB
H10194/R29	Resistor 10 kohm 1/4 W 10 %	Allen Bradley CB
H10194/R30	Resistor 10 kohm 1/4 W 10 %	Allen Bradley CB
H10194/R31	Resistor 1.5 kohm 1/4 W 10 %	Allen Bradley CB
H10194/R32	Resistor 1.5 kohm 1/4 W 10 %	Allen Bradley CB
H10194/R33	Resistor 470 ohm 1/4 W 10 %	Allen Bradley CB
H10194/R34	Resistor 470 ohm 1/4 W 10 %	Allen Bradley CB
H10194/R35	Resistor 4.7 kohm 1/4 W 10 %	Allen Bradley CB
H10194/R36	Resistor 4.7 kohm 1/4 W 10 %	Allen Bradley CB
H10194/R37	Resistor 100 ohm 1/4 W 10 %	Allen Bradley CB
H10194/R38	Resistor 100 ohm 1/4 W 10 %	Allen Bradley CB
H10194/R39	Resistor 1.5 kohm 1/4 W 10 %	Allen Bradley CB
H10194/R40	Resistor 1.5 kohm 1/4 W 10 %	Allen Bradley CB
H10194/R41	Resistor 47 ohm 1/4 W 10 %	Allen Bradley CB
H10194/R42	Resistor 10 kohm 1/4 W 10 %	Allen Bradley CB
H10194/R43	Resistor 10 kohm 1/4 W 10 %	Allen Bradley CB
H10194/R44	Resistor 2.2 kohm 1/4 W 10 %	Allen Bradley CB
H10194/R45	Resistor 2.2 kohm 1/4 W 10 %	Allen Bradley CB
H10194/R46	Resistor 4.7 kohm 1/4 W 10 %	Allen Bradley CB
H10194/R47	Resistor 4.7 kohm 1/4 W 10 %	Allen Bradley CB
H10194/R48	Resistor 1 kohm 1/4 W 10 %	Allen Bradley CB
H10194/R49	Resistor 1 kohm 1/4 W 10 %	Allen Bradley CB
H10194/R50	Resistor 47 ohm 1/4 W 10 %	Allen Bradley CB
H10194/R51	Resistor 47 ohm 1/4 W 10 %	Allen Bradley CB
H10194/R52	Resistor 10 kohm 1/4 W 10 %	Allen Bradley CB
H10194/R53	Resistor 10 kohm 1/4 W 10 %	Allen Bradley CB
H10194/C1	Capacitor 4700 pF	Sprague Cer. 55C33 ± 20 %
H10194/C2	Capacitor 4700 pF	Sprague Cer. 55C33 ± 20 %
H10194/C3	Capacitor 4700 pF	Sprague Cer. 55C33 ± 20 %

Part No.	Description	
H10194/C4	Capacitor 4700 pF	Sprague Cer. 55C33 \pm 20 %
H10194/C5	Capacitor 2.2 μ F	Sprague Dry El. 225x0035
H10194/C6	Capacitor 2.2 μ F	Sprague Dry El. 225x0035
H10194/C7	Capacitor 4700 pF	Sprague Cer. 55C33 \pm 20 %
H10194/C8	Capacitor 4700 pF	Sprague Cer. 55C33 \pm 20 %
H10194/C9	Capacitor 2.2 μ F	Sprague Dry El. 225x0035
H10194/C10	Capacitor 2.2 μ F	Sprague Dry El. 225x0035
H10194/C11	Capacitor 4700 pF	Sprague Cer. 55C33 \pm 20 %
H10194/C12	Capacitor 4700 pF	Sprague Cer. 55C33 \pm 20 %
H10194/C13	Capacitor 0.047 μ F	Sprague MP 118P S4
H10194/C14	Capacitor 0.047 μ F	Sprague MP 118P S4
H10194/C15	Capacitor 4700 pF	Sprague Cer. 55C33 \pm 20 %
H10194/C16	Capacitor 4700 pF	Sprague Cer. 55C33 \pm 20 %
H10194/C17	Capacitor 47 μ F	Sprague Dry El. 476x0020
H10194/C18	Capacitor 4700 pF	Sprague Cer. 55C33 \pm 20 %
H10194/C19	Capacitor 4700 pF	Sprague Cer. 55C33 \pm 20 %
E13250	Label	

6.2.4 BOARD No. 4

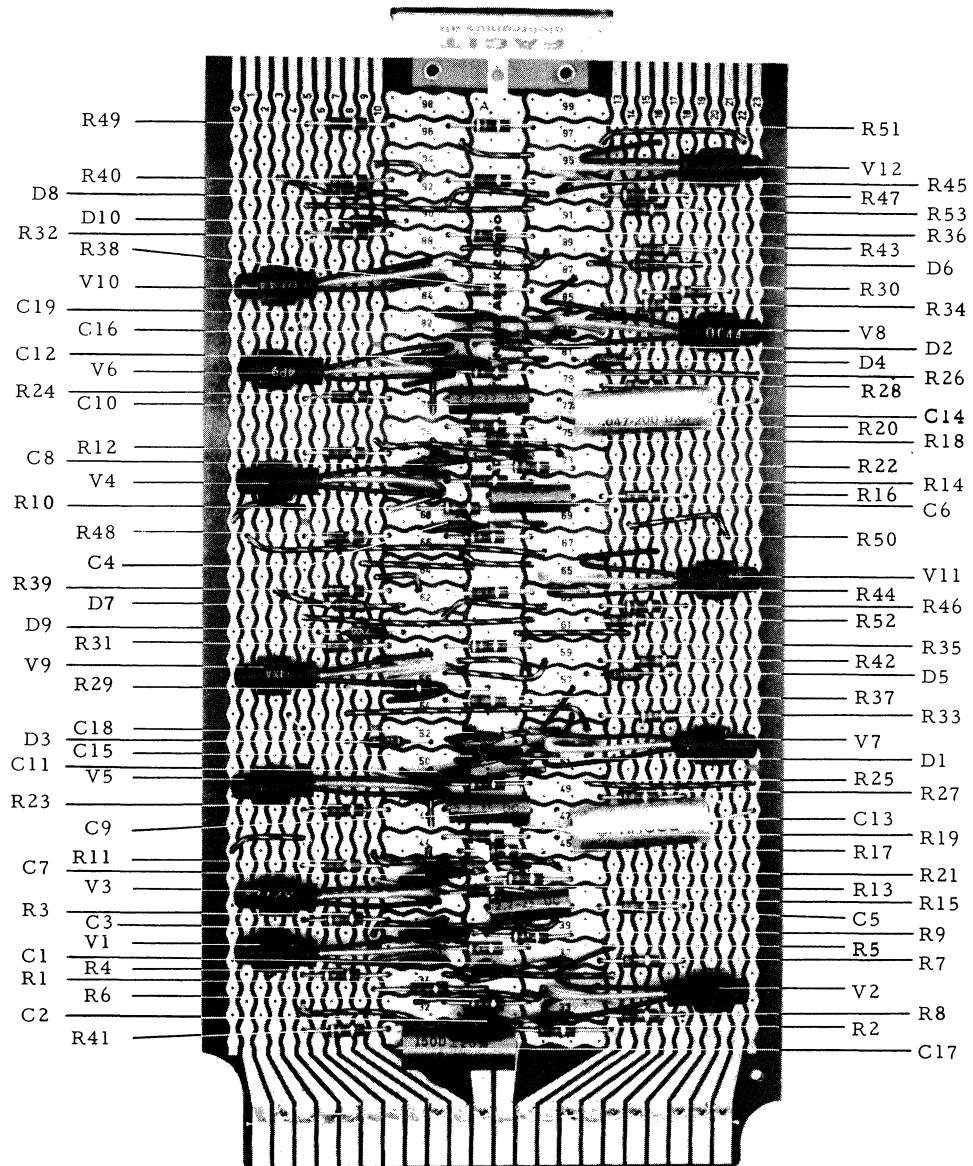

- | | |
|-----|-----|
| R49 | R51 |
| R40 | V12 |
| D8 | R47 |
| D10 | R45 |
| R32 | R53 |
| R38 | R36 |
| V10 | D6 |
| C19 | R30 |
| C16 | R34 |
| C12 | V8 |
| V6 | D4 |
| R24 | R28 |
| C10 | R26 |
| R12 | C14 |
| C8 | R22 |
| V4 | R18 |
| R10 | R16 |
| R48 | R14 |
| C4 | C6 |
| R39 | R50 |
| D7 | V11 |
| D9 | R44 |
| R31 | R46 |
| V9 | R52 |
| R29 | R42 |
| C18 | R35 |
| C15 | D5 |
| V5 | R37 |
| R23 | R33 |
| C9 | V7 |
| R11 | D1 |
| V3 | R25 |
| R3 | R27 |
| C3 | C13 |
| V1 | R19 |
| R4 | R17 |
| R6 | R21 |
| R1 | R13 |
| C2 | R15 |
| R41 | C5 |
| | R9 |
| | R5 |
| | R7 |
| | V2 |
| | R8 |
| | R2 |
| | C17 |

6.2.4 BOARD No. 4

Part No.	Description	
H10194	Circuit board No. 4, complete	
H10194/V1	Transistor Philips OC44	
H10194/V2	Transistor Philips OC44	
H10194/V3	Transistor Philips OC44	
H10194/V4	Transistor Philips OC44	
H10194/V5	Transistor Philips OC44	
H10194/V6	Transistor Philips OC44	
H10194/V7	Transistor Philips OC44	
H10194/V8	Transistor Philips OC44	
H10194/V9	Transistor Philips OC44	
H10194/V10	Transistor Philips OC44	
H10194/V11	Transistor Philips OC44	
H10194/V12	Transistor Philips OC44	
E12105	Transistor Mounting Clip	
H10194/D1	Diode Philips AAZ15	
H10194/D2	Diode Philips AAZ15	
H10194/D3	Diode Philips AAZ15	
H10194/D4	Diode Philips AAZ15	
H10194/D5	Diode Philips AAZ15	
H10194/D6	Diode Philips AAZ15	
H10194/D7	Diode Philips AAZ15	
H10194/D8	Diode Philips AAZ15	
H10194/D9	Diode Philips AAZ15	
H10194/D10	Diode Philips AAZ15	
H10194/R1	Resistor 10 kohm 1/4 W 10 %	Allen Bradley CB
H10194/R2	Resistor 10 kohm 1/4 W 10 %	Allen Bradley CB
H10194/R3	Resistor 4.7 kohm 1/4 W 10 %	Allen Bradley CB
H10194/R4	Resistor 4.7 kohm 1/4 W 10 %	Allen Bradley CB
H10194/R5	Resistor 470 ohm 1/4 W 10 %	Allen Bradley CB
H10194/R6	Resistor 470 ohm 1/4 W 10 %	Allen Bradley CB
H10194/R7	Resistor 10 kohm 1/4 W 10 %	Allen Bradley CB
H10194/R8	Resistor 10 kohm 1/4 W 10 %	Allen Bradley CB
H10194/R9	Resistor 4.7 kohm 1/4 W 10 %	Allen Bradley CB
H10194/R10	Resistor 4.7 kohm 1/4 W 10 %	Allen Bradley CB
H10194/R11	Resistor 2.2 kohm 1/4 W 10 %	Allen Bradley CB
H10194/R12	Resistor 2.2 kohm 1/4 W 10 %	Allen Bradley CB
H10194/R13	Resistor 22 ohm 1/4 W 10 %	Allen Bradley CB
H10194/R14	Resistor 22 ohm 1/4 W 10 %	Allen Bradley CB
H10194/R15	Resistor 3.3 kohm 1/4 W 10 %	Allen Bradley CB
H10194/R16	Resistor 3.3 kohm 1/4 W 10 %	Allen Bradley CB

(12 011)

Part No.	Description	
H10194/R17	Resistor 2.2 kohm 1/4 W 10 %	Allen Bradley CB
H10194/R18	Resistor 2.2 kohm 1/4 W 10 %	Allen Bradley CB
H10194/R19	Resistor, selected after test	
H10194/R20	Resistor, selected after test	
H10194/R21	Resistor 4.7 kohm 1/4 W 10 %	Allen Bradley CB
H10194/R22	Resistor 4.7 kohm 1/4 W 10 %	Allen Bradley CB
H10194/R23	Resistor 2.2 kohm 1/4 W 10 %	Allen Bradley CB
H10194/R24	Resistor 2.2 kohm 1/4 W 10 %	Allen Bradley CB
H10194/R25	Resistor 47 ohm 1/4 W 10 %	Allen Bradley CB
H10194/R26	Resistor 47 ohm 1/4 W 10 %	Allen Bradley CB
H10194/R27	Resistor 3.3 kohm 1/4 W 10 %	Allen Bradley CB
H10194/R28	Resistor 3.3 kohm 1/4 W 10 %	Allen Bradley CB
H10194/R29	Resistor 10 kohm 1/4 W 10 %	Allen Bradley CB
H10194/R30	Resistor 10 kohm 1/4 W 10 %	Allen Bradley CB
H10194/R31	Resistor 1.5 kohm 1/4 W 10 %	Allen Bradley CB
H10194/R32	Resistor 1.5 kohm 1/4 W 10 %	Allen Bradley CB
H10194/R33	Resistor 470 ohm 1/4 W 10 %	Allen Bradley CB
H10194/R34	Resistor 470 ohm 1/4 W 10 %	Allen Bradley CB
H10194/R35	Resistor 4.7 kohm 1/4 W 10 %	Allen Bradley CB
H10194/R36	Resistor 4.7 kohm 1/4 W 10 %	Allen Bradley CB
H10194/R37	Resistor 100 ohm 1/4 W 10 %	Allen Bradley CB
H10194/R38	Resistor 100 ohm 1/4 W 10 %	Allen Bradley CB
H10194/R39	Resistor 1.5 kohm 1/4 W 10 %	Allen Bradley CB
H10194/R40	Resistor 1.5 kohm 1/4 W 10 %	Allen Bradley CB
H10194/R41	Resistor 47 ohm 1/4 W 10 %	Allen Bradley CB
H10194/R42	Resistor 10 kohm 1/4 W 10 %	Allen Bradley CB
H10194/R43	Resistor 10 kohm 1/4 W 10 %	Allen Bradley CB
H10194/R44	Resistor 2.2 kohm 1/4 W 10 %	Allen Bradley CB
H10194/R45	Resistor 2.2 kohm 1/4 W 10 %	Allen Bradley CB
H10194/R46	Resistor 4.7 kohm 1/4 W 10 %	Allen Bradley CB
H10194/R47	Resistor 4.7 kohm 1/4 W 10 %	Allen Bradley CB
H10194/R48	Resistor 1 kohm 1/4 W 10 %	Allen Bradley CB
H10194/R49	Resistor 1 kohm 1/4 W 10 %	Allen Bradley CB
H10194/R50	Resistor 47 ohm 1/4 W 10 %	Allen Bradley CB
H10194/R51	Resistor 47 ohm 1/4 W 10 %	Allen Bradley CB
H10194/R52	Resistor 10 kohm 1/4 W 10 %	Allen Bradley CB
H10194/R53	Resistor 10 kohm 1/4 W 10 %	Allen Bradley CB
H10194/C1	Capacitor 4700 pF	Sprague Cer. 55C33 ± 20 %
H10194/C2	Capacitor 4700 pF	Sprague Cer. 55C33 ± 20 %
H10194/C3	Capacitor 4700 pF	Sprague Cer. 55C33 ± 20 %

Part No.	Description	
H10194/C4	Capacitor 4700 pF	Sprague Cer. 55C33 \pm 20 %
H10194/C5	Capacitor 2.2 μ F	Sprague Dry El. 225x0035
H10194/C6	Capacitor 2.2 μ F	Sprague Dry El. 225x0035
H10194/C7	Capacitor 4700 pF	Sprague Cer. 55C33 \pm 20 %
H10194/C8	Capacitor 4700 pF	Sprague Cer. 55C33 \pm 20 %
H10194/C9	Capacitor 2.2 μ F	Sprague Dry El. 225x0035
H10194/C10	Capacitor 2.2 μ F	Sprague Dry El. 225x0035
H10194/C11	Capacitor 4700 pF	Sprague Cer. 55C33 \pm 20 %
H10194/C12	Capacitor 4700 pF	Sprague Cer. 55C33 \pm 20 %
H10194/C13	Capacitor 0.047 μ F	Sprague MP 118P S4
H10194/C14	Capacitor 0.047 μ F	Sprague MP 118P S4
H10194/C15	Capacitor 4700 pF	Sprague Cer. 55C33 \pm 20 %
H10194/C16	Capacitor 4700 pF	Sprague Cer. 55C33 \pm 20 %
H10194/C17	Capacitor 47 μ F	Sprague Dry El. 476x0020
H10194/C18	Capacitor 4700 pF	Sprague Cer. 55C33 \pm 20 %
H10194/C19	Capacitor 4700 pF	Sprague Cer. 55C33 \pm 20 %
E13250	Label	

6.2.5 BOARD No. 5

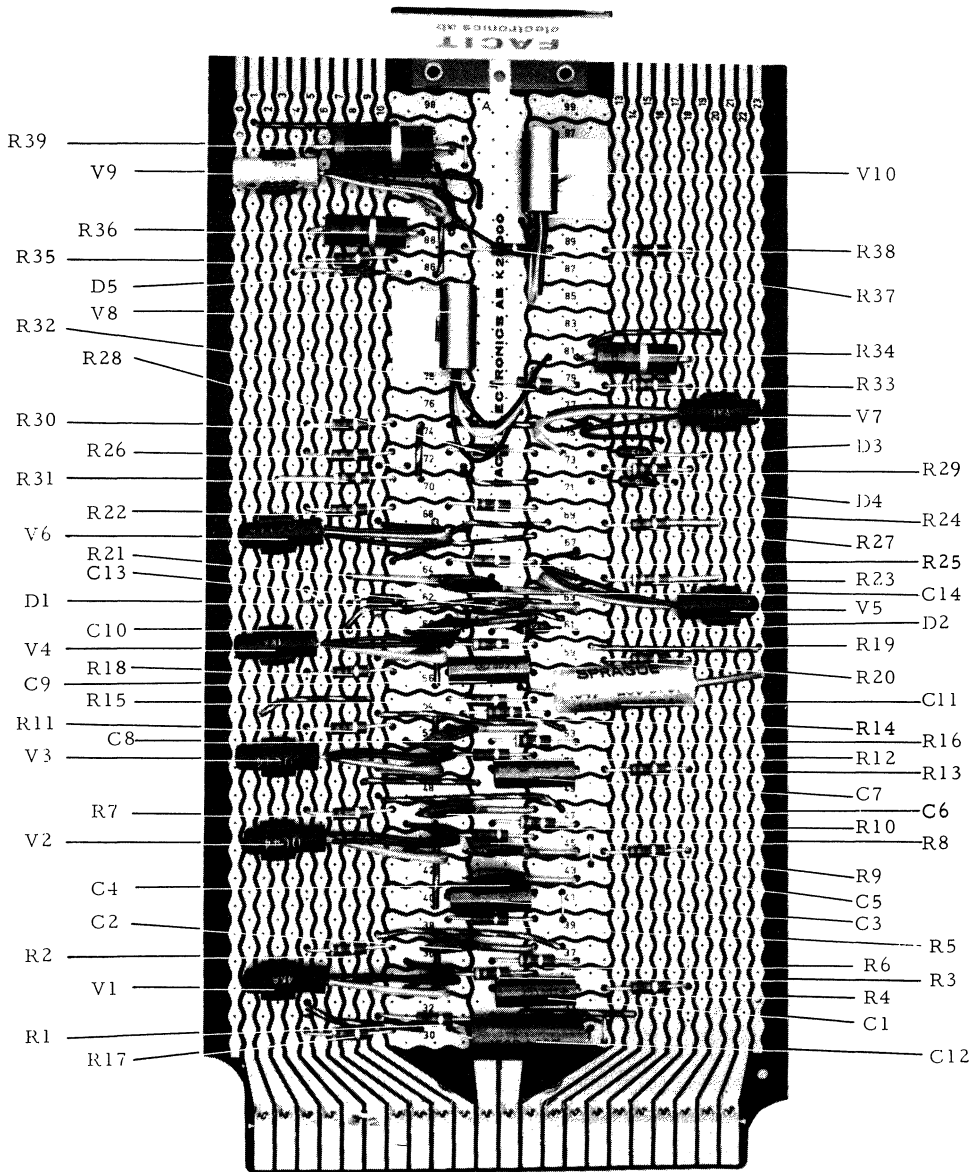

6.2.5 BOARD No. 5

Part No.	Description		
H10195	Circuit board No. 5, complete		
H10195/V1	Transistor	Philips OC44	
H10195/V2	Transistor	Philips OC44	
H10195/V3	Transistor	Philips OC44	
H10195/V4	Transistor	Philips OC44	
H10195/V5	Transistor	Philips OC44	
H10195/V6	Transistor	Philips OC44	
H10195/V7	Transistor	Philips OC44	
H10195/V8	Transistor	Mullard OC83	
H10195/V9	Transistor	Mullard OC83	
H10195/V10	Transistor	Mullard OC83	
E12105	Transistor mounting clip		(8 off)
H10195/6	Transistor cooler	Philips 56200	(2 off)
H10195/D1	Diode	Philips AAZ15	
H10195/D2	Diode	Philips AAZ15	
H10195/D3	Diode	Philips AAZ15	
H10195/D4	Diode	Philips AAZ15	
H10195/D5	Diode	Philips AAZ15	
H10195/R1	Resistor 10 kohm 1/4 W 10 %	Allen Bradley CB	
H10195/R2	Resistor 4.7 kohm 1/4 W 10 %	Allen Bradley CB	
H10195/R3	Resistor 47 ohm 1/4 W 10 %	Allen Bradley CB	
H10195/R4	Resistor 10 kohm 1/4 W 10 %	Allen Bradley CB	
H10195/R5	Resistor 1 kohm 1/4 W 10 %	Allen Bradley CB	
H10195/R6	Resistor 4.7 kohm 1/4 W 10 %	Allen Bradley CB	
H10195/R7	Resistor 2.2 kohm 1/4 W 10 %	Allen Bradley CB	
H10195/R8	Resistor 220 ohm 1/4 W 10 %	Allen Bradley CB	
H10195/R9	Resistor 3.3 kohm 1/4 W 10 %	Allen Bradley CB	
H10195/R10	Resistor 4.7 kohm 1/4 W 10 %	Allen Bradley CB	
H10195/R11	Resistor 2.2 kohm 1/4 W 10 %	Allen Bradley CB	
H10195/R12	Resistor 22 ohm 1/4 W 10 %	Allen Bradley CB	
H10195/R13	Resistor 3.3 kohm 1/4 W 10 %	Allen Bradley CB	
H10195/R14	Resistor 2.2 kohm 1/4 W 10 %	Allen Bradley CB	
H10195/R15	Resistor, selected after test		
H10195/R16	Resistor 4.7 kohm 1/4 W 10 %	Allen Bradley CB	
H10195/R17	Resistor 47 ohm 1/4 W 10 %	Allen Bradley CB	
H10195/R18	Resistor 2.2 kohm 1/4 W 10 %	Allen Bradley CB	
H10195/R19	Resistor 47 ohm 1/4 W 10 %	Allen Bradley CB	
H10195/R20	Resistor 3.3 kohm 1/4 W 10 %	Allen Bradley CB	
H10195/R21	Resistor 10 kohm 1/4 W 10 %	Allen Bradley CB	
H10195/R22	Resistor 1.5 kohm 1/4 W 10 %	Allen Bradley CB	

Part No.	Description	
H10195/R23	Resistor 470 ohm 1/4 W 10 %	Allen Bradley CB
H10195/R24	Resistor 4.7 kohm 1/4 W 10 %	Allen Bradley CB
H10195/R25	Resistor 100 ohm 1/4 W 10 %	Allen Bradley CB
H10195/R26	Resistor 1.5 kohm 1/4 W 10 %	Allen Bradley CB
H10195/R27	Resistor 10 kohm 1/4 W 10 %	Allen Bradley CB
H10195/R28	Resistor 2.2 kohm 1/4 W 10 %	Allen Bradley CB
H10195/R29	Resistor 4.7 kohm 1/4 W 10 %	Allen Bradley CB
H10195/R30	Resistor 1 kohm 1/4 W 10 %	Allen Bradley CB
H10195/R31	Resistor 47 ohm 1/4 W 10 %	Allen Bradley CB
H10195/R32	Resistor 100 ohm 1/4 W 10 %	Allen Bradley CB
H10195/R33	Resistor 470 ohm 1/4 W 10 %	Allen Bradley CB
H10195/R34	Resistor 100 ohm 1 W 10 %	Allen Bradley GB
H10195/R35	Resistor 2.2 kohm 1/4 W 10 %	Allen Bradley CB
H10195/R36	Resistor 220 ohm 1 W 10 %	Allen Bradley GB
H10195/R37	Resistor 220 ohm 1/4 W 10 %	Allen Bradley CB
H10195/R38	Resistor 1 kohm 1/4 W 10 %	Allen Bradley CB
H10195/R39	Resistor 82 ohm 2 W 10 %	Allen Bradley HB
H10195/C1	Capacitor 2.2 μ F	Sprague Dry El. 225x0035
H10195/C2	Capacitor 4700 pF	Sprague Cer. 55C33 \pm 20 %
H10195/C3	Capacitor 2.2 μ F	Sprague Dry El. 225x0035
H10195/C4	Capacitor 4700 pF	Sprague Cer. 55C33 \pm 20 %
H10195/C5	Capacitor 4700 pF	Sprague Cer. 55C33 \pm 20 %
H10195/C6	Capacitor 4700 pF	Sprague Cer. 55C33 \pm 20 %
H10195/C7	Capacitor 2.2 μ F	Sprague Dry El. 225x0035
H10195/C8	Capacitor 4700 pF	Sprague Cer. 55C33 \pm 20 %
H10195/C9	Capacitor 2.2 μ F	Sprague Dry El. 225x0035
H10195/C10	Capacitor 4700 pF	Sprague Cer. 55C33 \pm 20 %
H10195/C11	Capacitor 0.047 μ F	Sprague MP 118P S4
H10195/C12	Capacitor 47 μ F	Sprague Dry El. 476x0020
H10195/C13	Capacitor 4700 pF	Sprague Cer. 55C33 \pm 20 %
H10195/C14	Capacitor 4700 pF	Sprague Cer. 55C33 \pm 20 %
E13250/2	Label	

6.2.6 BOARD No. 6

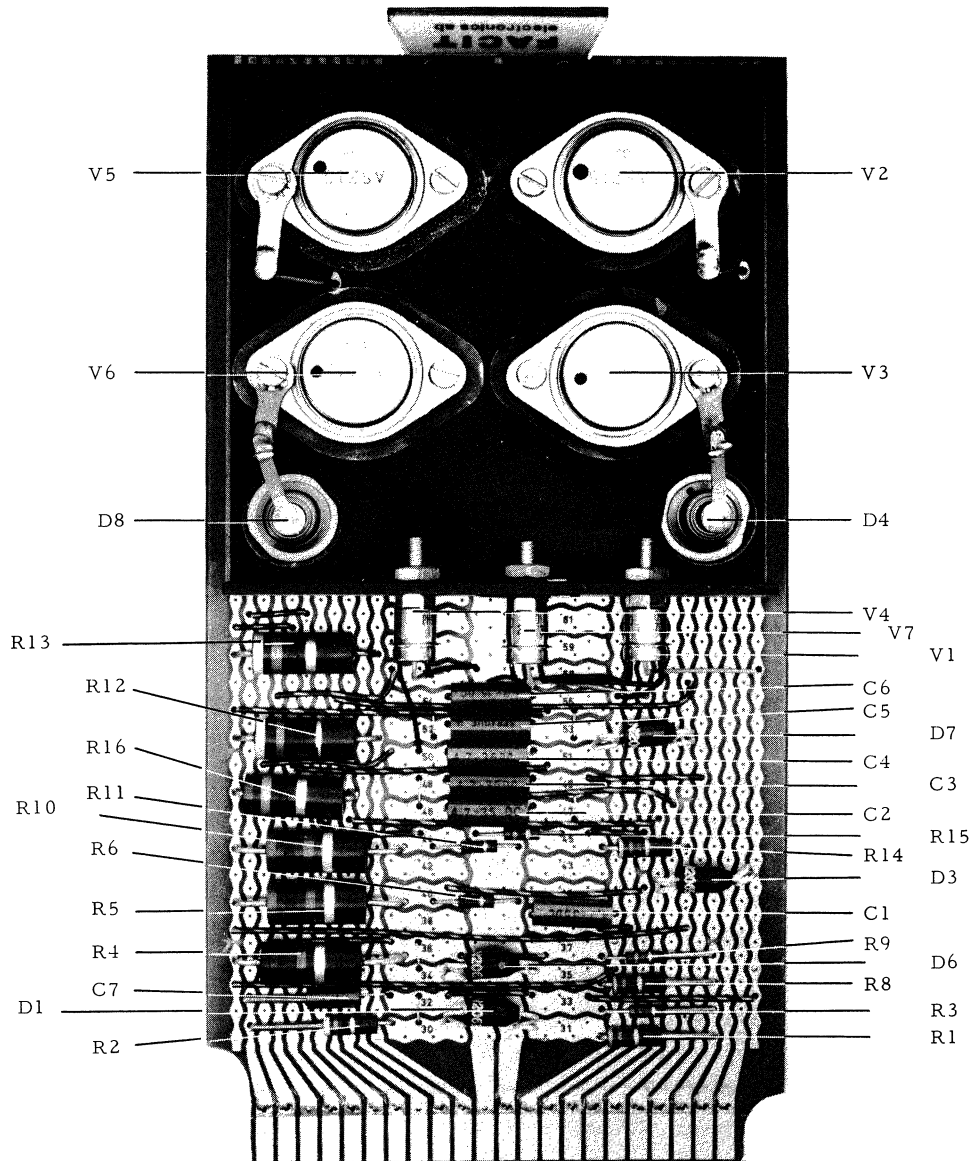

6.2.6 BOARD No. 6

Part No.	Description	
H10196	Circuit board No. 6, complete	
H10196/V1	Transistor	Philco 2N673
H10196/V2	Transistor	Philips ASZ15
H10196/V3	Transistor	Philips ASZ15
H10196/V4	Transistor	Philco 2N673
H10196/V5	Transistor	Philips ASZ15
H10196/V6	Transistor	Philips ASZ15
H10196/V7	Transistor	Philco 2N673
E12994	Cooler	
E14774	Cooler Insulator	
E14547	Mounting Kit for V1	
E11688	Mounting Kit for V2	
E11688	Mounting Kit for V3	
E14547	Mounting Kit for V4	
E11688	Mounting Kit for V5	
E11688	Mounting Kit for V6	
E14689	Mounting Kit for V7	
H10196/D1	Diode	Transitron 1N 2069
H10196/D3	Diode	Transitron 1N 2069
H10196/D4	Diode	Philips OA31
H10196/D6	Diode	Transitron 1N 2069
H10196/D7	Diode	Transitron 1N 2069
H10196/D8	Diode	Philips OA31
E12145	Mounting Kit for D4	
E12145	Mounting Kit for D8	
H10196/R1	Resistor 68 ohm 1/2 W 10 %	Allen Bradley EB
H10196/R2	Resistor 47 ohm 1/2 W 10 %	Allen Bradley EB
H10196/R3	Resistor 330 ohm 1/4 W 10 %	Allen Bradley CB
H10196/R4	Resistor 220 ohm 2 W 10 %	Allen Bradley HB
H10196/R5	Resistor 100 ohm 2 W 10 %	Allen Bradley HB
H10196/R6	Resistor 22 ohm 1/4 W 10 %	Allen Bradley CB
H10196/R8	Resistor 68 ohm 1/2 W 10 %	Allen Bradley EB
H10196/R9	Resistor 560 ohm 1/4 W 10 %	Allen Bradley CB
H10196/R10	Resistor 100 ohm 2 W 10 %	Allen Bradley HB
H10196/R11	Resistor 22 ohm 1/4 W 10 %	Allen Bradley CB
H10196/R12	Resistor 47 ohm 2 W 10 %	Allen Bradley HB
H10196/R13	Resistor 47 ohm 2 W 10 %	Allen Bradley HB
H10196/R14	Resistor 470 ohm 1/2 W 10 %	Allen Bradley EB
H10196/R15	Resistor 56 ohm 1/4 W 10 %	Allen Bradley CB
H10196/R16	Resistor 56 ohm 2 W 10 %	Allen Bradley HB

Part No.	Description	
H10196/C1	Capacitor 4.7 μ F	Sprague Dry El. 475x0035
H10196/C2	Capacitor 4.7 μ F	Sprague Dry El. 475x0035
H10196/C3	Capacitor 4.7 μ F	Sprague Dry El. 475x0035
H10196/C4	Capacitor 4.7 μ F	Sprague Dry El. 475x0035
H10196/C5	Capacitor 2.2 μ F	Sprague Dry El. 225x0035
H10196/C6	Capacitor 2.2 μ F	Sprague Dry El. 225x0035
H10196/C7	Capacitor 1 μ F	Sprague Dry El. 105x0035
E13250/4	Label	

5.3 RESISTOR UNIT

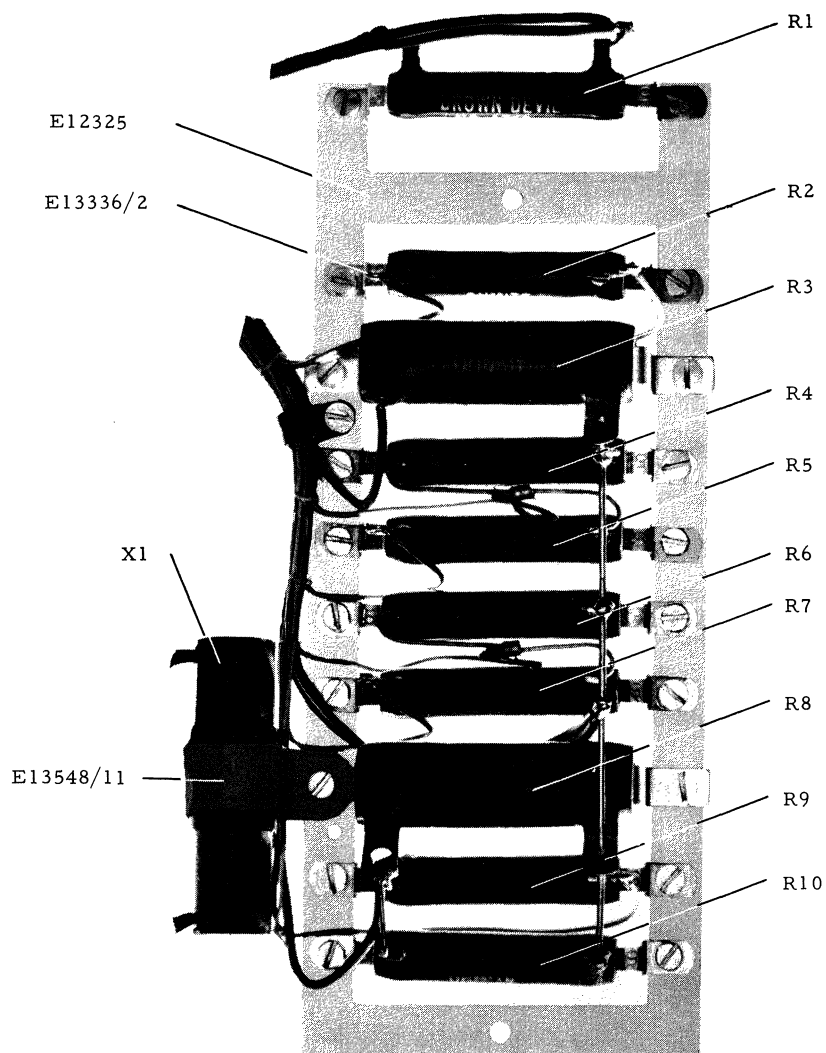

5.3 RESISTOR UNIT

Part No.	Description		
E13336	Resistor unit, complete		
ECS 3x6	Screw		(2 off)
E13336/R1	Resistor 50 ohm 10 W \pm 5 %	Ohmite 1718	
E13336/R2	Resistor 50 ohm 10 W \pm 5 %	Ohmite 1718	
E13336/R3	Resistor 5 ohm 25 W \pm 5 %	Ohmite 0200A, bracket included	
E13336/R4	Resistor 25 ohm 10 W \pm 5 %	Ohmite 1714	
E13336/R5	Resistor 25 ohm 10 W \pm 5 %	Ohmite 1714	
E13336/R6	Resistor 25 ohm 10 W \pm 5 %	Ohmite 1714	
E13336/R7	Resistor 25 ohm 10 W \pm 5 %	Ohmite 1714	
E13336/R8	Resistor 3 ohm 25 W \pm 5 %	Ohmite 0200L, bracket included	
E13336/R9	Resistor 25 ohm 10 W \pm 5 %	Ohmite 1714	
E13336/R10	Resistor 10 ohm 10 W \pm 5 %	Ohmite 1710	
ECS 3x3	Screw for R1-R7 and R9-R10		(18
ECS 3x3	Screw for R8		
ECS 3x5	Screw for R8		
E13336/X1	Noise filter 0,1 μ F + 0,005 μ F	Rifa PZB 1013	
E95046	Solder tag		
E12325	Bracket		
E13336/2	Bracket	Ohmite 5S	(16 off)
E13548/11	Cable clip		

5.4 CAPACITOR UNIT

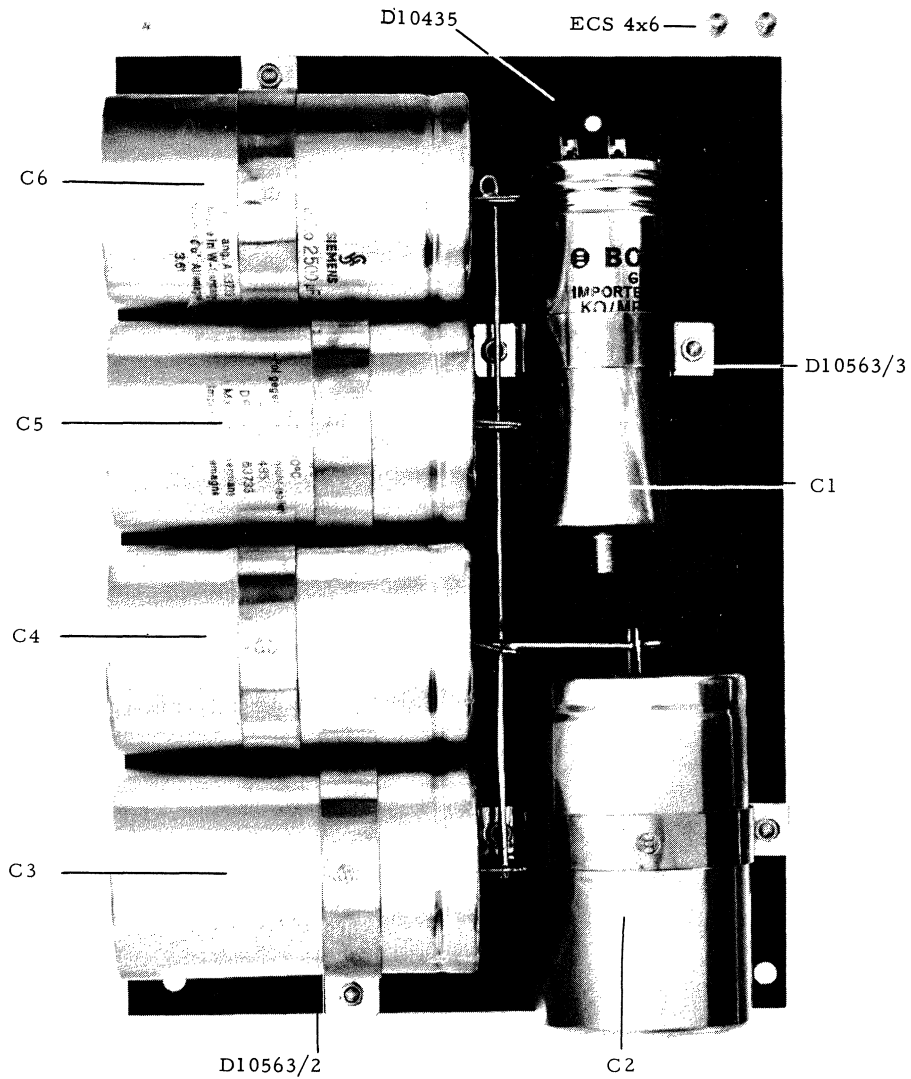

5.4 CAPACITOR UNIT

Part No.	Description		
D10563	Capacitor unit, complete		
ECS 4x6	Screw		(2 off)
D10435	Mounting plate		
D10563/C1	Capacitor 3 μ F	Bosch MP30/3 G630/1	
D10563/C2	Capacitor 2500 μ F	Siemens 2500/35 Ko Bv 43485	
D10563/C3	Capacitor 2500 μ F	Siemens 2500/35 Ko Bv 43485	
D10563/C4	Capacitor 2500 μ F	Siemens 2500/35 Ko Bv 43485	
D10563/C5	Capacitor 2500 μ F	Siemens 2500/35 Ko Bv 43485	
D10563/C6	Capacitor 2500 μ F	Siemens 2500/35 Ko Bv 43485*	
D10563/2	Strap	Bosch WBE 21Z7X	(5 off)
FS 3x6	Screw		(10 off)
LB6LM 3	Nut		(10 off)
D10563/3	Strap	Bosch WBE 21Z4X	
FS 3x6	Screw		(2 off)
LB6LM 3	Nut		(2 off)

6.2.7 BOARD No. 7

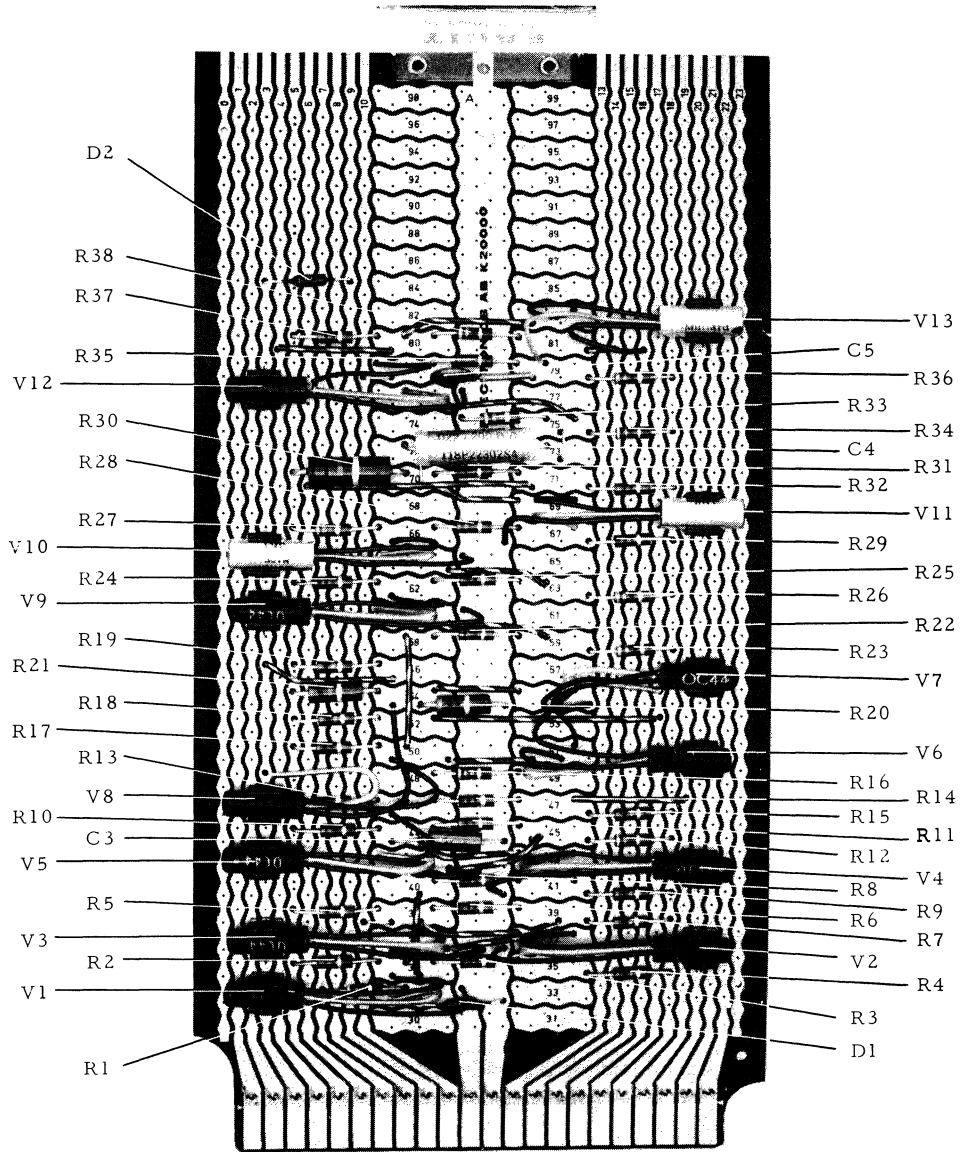

6.2.7 BOARD No. 7

Part No.	Description	
H10197	Circuit board No. 7, complete	
H10197/V1	Transistor	Philips OC44
H10197/V2	Transistor	Philips OC44
H10197/V3	Transistor	Philips OC44
H10197/V4	Transistor	Philips OC44
H10197/V5	Transistor	Philips OC44
H10197/V6	Transistor	Philips OC44
H10197/V7	Transistor	Philips OC44
H10197/V8	Transistor	Philips OC44
H10197/V9	Transistor	Philips OC44
H10197/V10	Transistor	Mullard OC83
H10197/V11	Transistor	Mullard OC83
H10197/V12	Transistor	Philips OC44
H10197/V13	Transistor	Mullard OC83
E12105	Transistor mounting clip	
H10197/D1	Diode	Philips AAZ15
H10197/D2	Diode	Philips AAZ15
H10197/R1	Resistor 4.7 kohm 1/4 W 10 %	Allen Bradley CB
H10197/R2	Resistor 1 kohm 1/4 W 10 %	Allen Bradley CB
H10197/R3	Resistor 2.2 kohm 1/4 W 10 %	Allen Bradley CB
H10197/R4	Resistor 10 kohm 1/4 W 10 %	Allen Bradley CB
H10197/R5	Resistor 1 kohm 1/4 W 10 %	Allen Bradley CB
H10197/R6	Resistor 2.2 kohm 1/4 W 10 %	Allen Bradley CB
H10197/R7	Resistor 10 kohm 1/4 W 10 %	Allen Bradley CB
H10197/R8	Resistor 2.2 kohm 1/4 W 10 %	Allen Bradley CB
H10197/R9	Resistor 10 kohm 1/4 W 10 %	Allen Bradley CB
H10197/R10	Resistor 1.5 kohm 1/4 W 10 %	Allen Bradley CB
H10197/R11	Resistor 1 kohm 1/4 W 10 %	Allen Bradley CB
H10197/R12	Resistor 4.7 kohm 1/4 W 10 %	Allen Bradley CB
H10197/R13	Resistor 1 kohm 1/4 W 10 %	Allen Bradley CB
H10197/R14	Resistor 2.2 kohm 1/4 W 10 %	Allen Bradley CB
H10197/R15	Resistor 10 kohm 1/4 W 10 %	Allen Bradley CB
H10197/R16	Resistor 680 ohm 1/4 W 10 %	Allen Bradley CB
H10197/R17	Resistor 1 kohm 1/4 W 10 %	Allen Bradley CB
H10197/R18	Resistor 10 kohm 1/4 W 10 %	Allen Bradley CB
H10197/R19	Resistor 10 kohm 1/4 W 10 %	Allen Bradley CB
H10197/R20	Resistor 82 ohm 1/2 W 10 %	Allen Bradley EB
H10197/R21	Resistor 120 ohm 1/2 W 10 %	Allen Bradley EB
H10197/R22	Resistor 3.3 kohm 1/4 W 10 %	Allen Bradley CB
H10197/R23	Resistor 6.8 kohm 1/4 W 10 %	Allen Bradley CB

(13 off)

Part No.	Description	
H10197/R24	Resistor 2.2 kohm 1/4 W 10 %	Allen Bradley CB
H10197/R25	Resistor 1 kohm 1/4 W 10 %	Allen Bradley CB
H10197/R26	Resistor 6.8 kohm 1/4 W 10 %	Allen Bradley CB
H10197/R27	Resistor 680 ohm 1/4 W 10 %	Allen Bradley CB
H10197/R28	Resistor 330 ohm 1/4 W 10 %	Allen Bradley CB
H10197/R29	Resistor 2.2 kohm 1/4 W 10 %	Allen Bradley CB
H10197/R30	Resistor 220 ohm 1 W 10 %	Allen Bradley GB
H10197/R31	Resistor 220 ohm 1/4 W 10 %	Allen Bradley CB
H10197/R32	Resistor 1 kohm 1/4 W 10 %	Allen Bradley CB
H10197/R33	Resistor 470 ohm 1/4 W 10 %	Allen Bradley CB
H10197/R34	Resistor 4.7 kohm 1/4 W 10 %	Allen Bradley CB
H10197/R35	Resistor 1.5 kohm 1/4 W 10 %	Allen Bradley CB
H10197/R36	Resistor 6.8 kohm 1/4 W 10 %	Allen Bradley CB
H10197/R37	Resistor 1 kohm 1/4 W 10 %	Allen Bradley CB
H10197/R38	Resistor 47 ohm 1/4 W 10 %	Allen Bradley CB
H10197/C3	Capacitor 0.47 μ F	Sprague Dry El. 474x0035
H10197/C4	Capacitor 0.022 μ F	Sprague MP 118P S4
H10197/C5	Capacitor 2200 pF	Sprague Cer. 19C250 \pm 10 %
E13250/3	Label	



7 ACCESSORIES

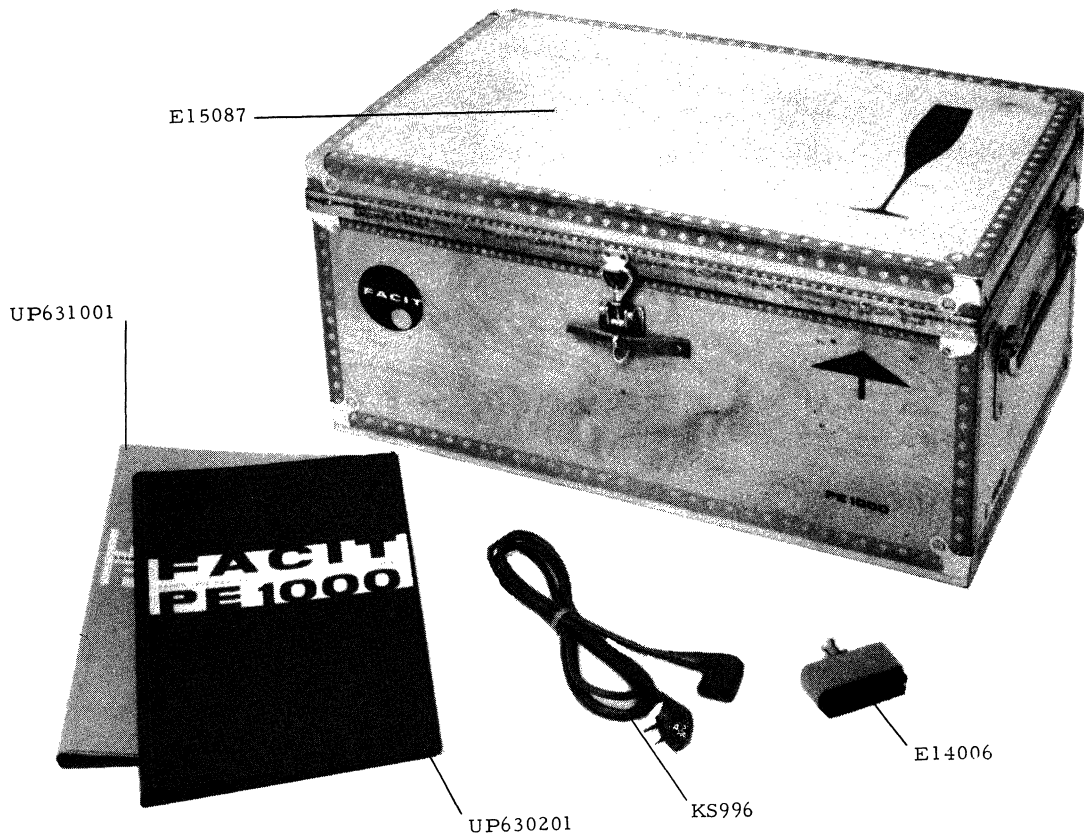

Part No.	Description
E15087	Packing case
UP630201	Manual
UP631001	Spare parts catalog
KS994	Mains cable, German type
KS996	Mains cable, Swedish type
KS998	Mains cable, American type
E14006	Connector

} Only one is delivered

