

DOCUMENT DTI-UM-4020-0

PRICE: \$25.00

USER MANUAL

FOR

DATA TRANSLATION, INC.

LAB-DATAX SERIES

DT4021
DT4022
DT4023

DT4024
DT4025

COPYRIGHT

DATA TRANSLATION

4 STRATHMORE ROAD
NATICK, MASSACHUSETTS 01760.

ALL RIGHT RESERVED. NO PART OF THIS PUBLICATION MAY BE REPRODUCED, STORED IN A RETRIEVAL SYSTEM, OR TRANSMITTED, IN ANY FORM BY ANY MEANS, ELECTRONIC, MECHANICAL, PHOTOCOPYING, RECORDING, OR OTHERWISE, WITHOUT THE PRIOR WRITTEN PERMISSION OF DATA TRANSLATION, INC.

TABLE OF CONTENTS

Chapter 1	Introduction	
1.1	General	1 - 1
1.2	Organization	1 - 2
1.3	Backplane Assembly	1 - 3
1.3	LAB-DATAX Backplane Priority	1 - 4
1.3.1	Backplane Pin Assignments	1 - 5
1.4	LAB-DATAX Power Supply	1 - 6
1.4.1	General Description	1 - 6
1.4.2	Specifications	1 - 6
Chapter 2	Unpacking, Installation and Operation	
2.1	Unpacking	2 - 1
2.2	Installation	2 - 1
2.2.1	A.C. Power Requirement	2 - 1
2.2.2	Module Insertion and Removal	2 - 1
2.2.3	Module Installation	2 - 2
2.3	Mounting the LAB-DATAX Box in an Equipment Rack	2 - 3
2.4	Power Connections	2 - 3
2.5	Operation	2 - 3
2.4	Power Connections & Controls Rear Panel	2 - 4
2.5	LAB-DATAX Power Panel	2 - 5
2.5	LAB-DATAX Front Panel Switches & Indicators	2 - 6
2.5.1	Line Time Clock	2 - 7
2.5.2	Programming the LTC	2 - 7
2.5.3	Bus Terminations	2 - 8
Chapter 3	LAB-DATAX Configuration	
3.1	General	3 - 1
3.2	Basic System DT4025	3 - 2
3.3	LAB-DATAX Analog I/O and Digital Peripherals	3 - 2
3.3	LDT2766, LDT2771, LDT2782, LDT2784 LDT2772 & LDT2774	3 - 3
3.4	LAB-DATAX Standard Configurations	3 - 4
3.4.1	DT4024 & DT4025	3 - 5
3.5	Front Panel Configurations	3 - 6
3.7	Point Plotter	3 - 7
3.8	Channel D/A Outputs	3 - 8
3.9	8 Differential Analog Inputs	3 - 9
3.10	16 Single Ended Analog Inputs	3 - 10
3.11	Real Time Clock Panel	3 - 11
	Appendix A - Power Requirements	A - 1

1.1 General

The LAB-DATAX Mounting Box can be installed in a standard 48.3 cm (19 in) equipment rack. The box is 48.3 cm (19 in) wide, approximately 12.7 cm (5 in) high, and 56.52 cm (22 1/4 in) deep. It contains cooling fans, ac input unit, power supply and a 8-slot backplane that accepts LSI-11 double-height and quad-height modules. The LAB-DATAX Mounting Box has a front panel/bezel that is equipped with operating switches and status indicators. It also has provision for mounting the LAB-DATAX connection panels for ease of connection to the analog I/O peripherals. The LAB-DATAX Mounting Box is specifically designed to provide the laboratory user a convenient access to his analog I/O signal connection, thus eliminating ground loops and analog noise problem.

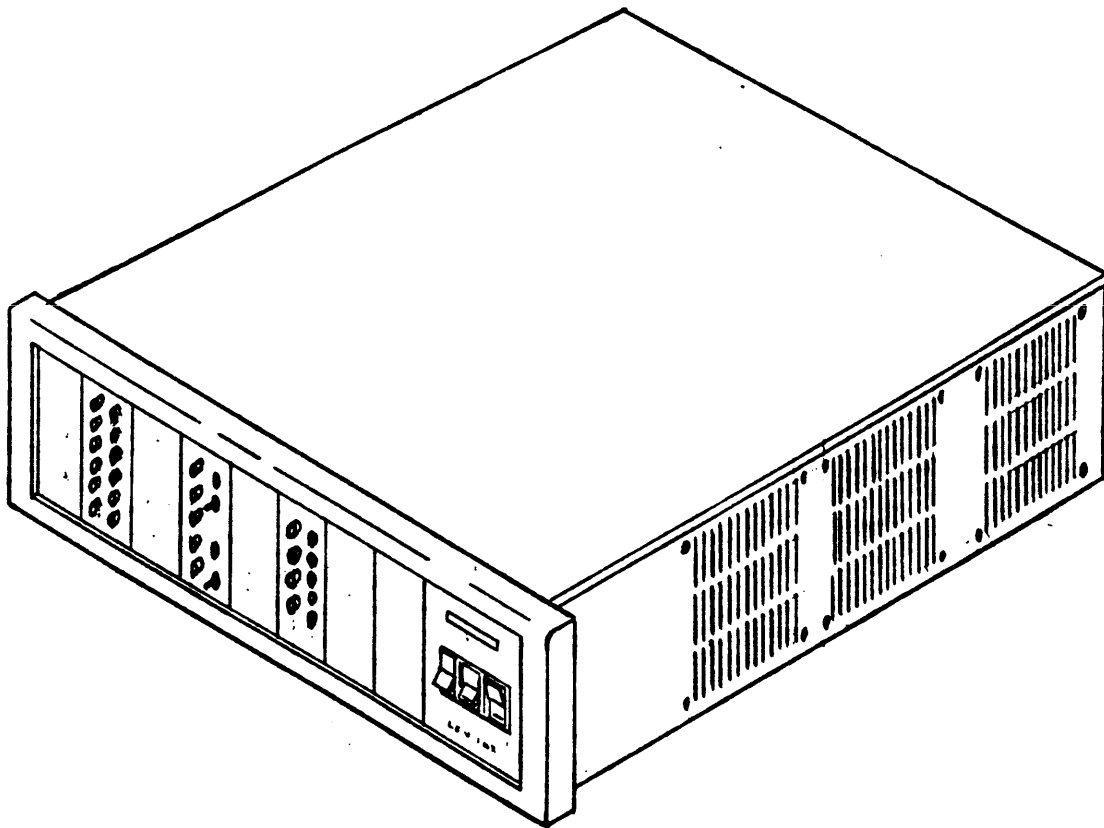
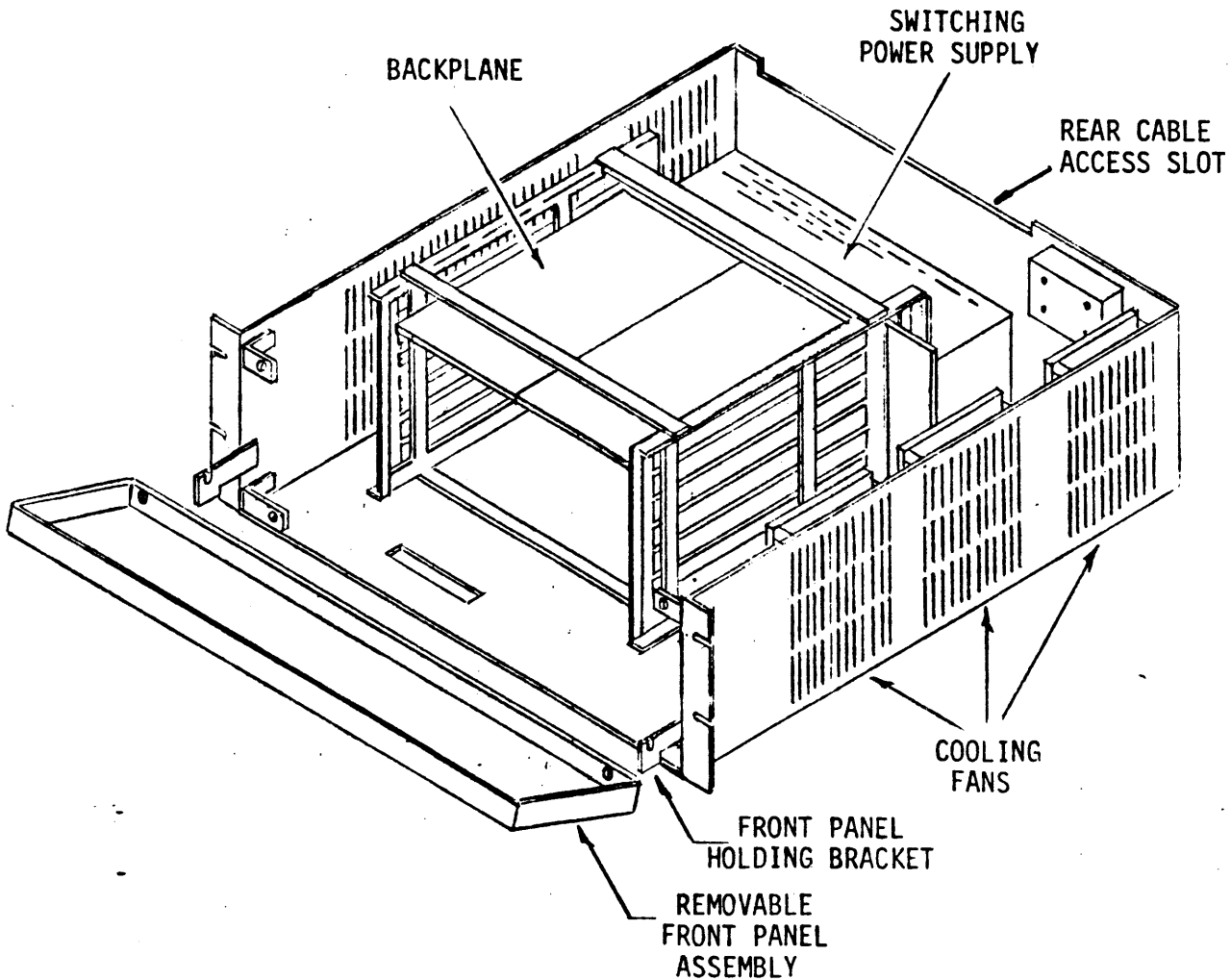

FIGURE 1-1 LAB-DATAX WITH FRONT PANEL

1.2 ORGANIZATION

Figure 1-2 shows the LAB-DATAX box with top cover removed and the removable front panel assembly. The backplane assembly faces forward and allows short connection cables to the modular front panels. All connection to non-analog peripherals is accomplished via a rear access cable slot. Thus, sensitive analog signals are totally integrated from noise inducing logic signals. Terminal cables, floppy disk cables and digital I/O cables are routed to the rear of the box for connection to the appropriate hardware. The switching power supply is mounted at the rear of the box and is completely enclosed for both electrical shielding and mechanical protection. Cooling is accomplished via 3 very low noise fans. Two fans are used for cooling the backplane assembly and its complement of modules. The third fan is dedicated for cooling the power supply. All subsections i.e. backplane, power supply and front panel assembly may be removed in a matter of minutes since each is connected to a main wiring harness via a quick disconnect connector.



VIEW IS FROM MODULE SIDE OF CONNECTORS

1.3 BACKPLANE ASSEMBLY

The LAB-DATAX backplane assembly consists of a frame with card guides for mechanical rigidity of the inserted modules and of a printed circuit board containing the LSI-11 Q-Bus connection and connectors. The connectors that comprise this backplane are arranged on an etched circuit board in four rows, each row containing two 72-pin connectors. A connector has two slots, each of which contains 36 pins, 18 on either side of the slot. Most of the pins of slot A, row 1, are etch-connected to corresponding pins not only in slot C, row 1, but also in slots A and C or rows 2, 3, and 4. For example, pin D, slot A, row 1, is common with pin D, slot C, row 1, as well as with pin D in slots A and C of rows 2, 3 and 4. Most of the pins of slots B and D are interconnected (bused) in the same way.

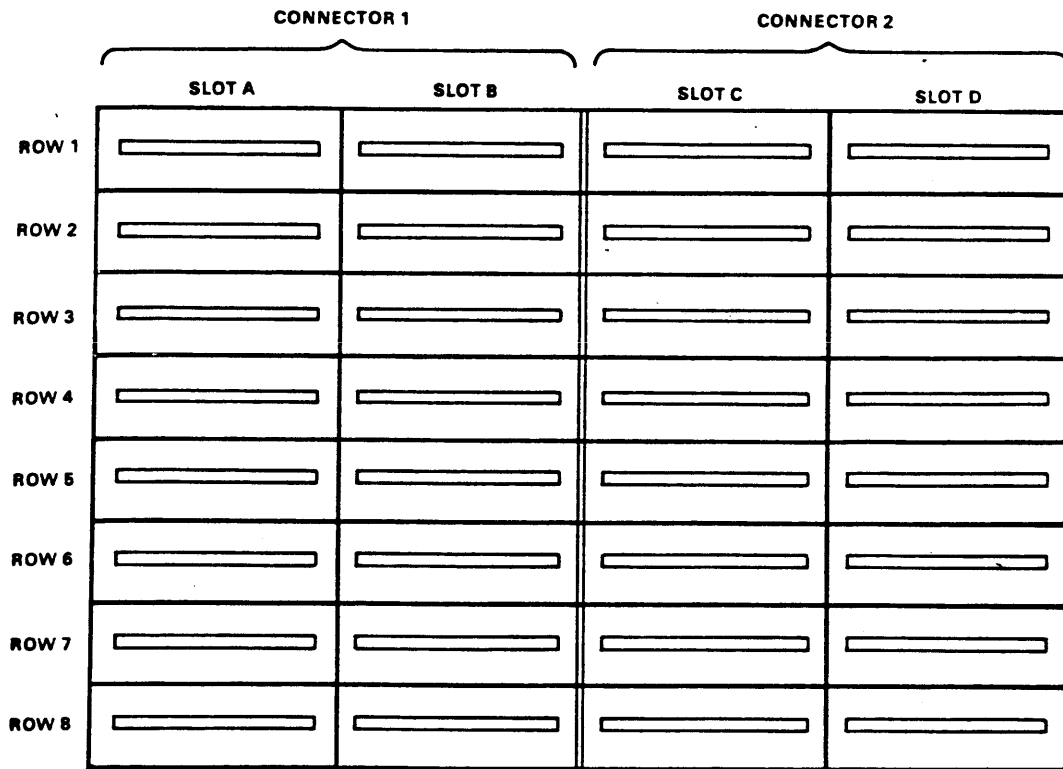

View is from Module side of Connectors

LSI-11 modules are mounted in the backplane by inserting the module finger connectors into the backplane slots. If the module is double height, module connector A (the right-most connector when viewing the component side of the module with the module fingers pointing down) is inserted in slot A or C of the backplane, and module connector B is inserted in slot B or D. A quad-height module has its A through D connectors inserted in slots A through D, respectively. The LSI-11 bus signals are present on the pins of slots A and B; the same set of bus signals is present on the pins of slots C and D. However, priority considerations and the fact that some connector pins are not bused result in certain restrictions on module placement. In general, modules should be installed in the backplane as illustrated in Figure 1-3. That is, the CPU module must be placed in the top row and the options must be placed to reflect their assigned priorities (option 1 has the highest priority). There must be no empty option locations between the CPU and options that use either the interrupt acknowledge signals or the direct memory access (DMA) grant signals of the LSI-11 bus.

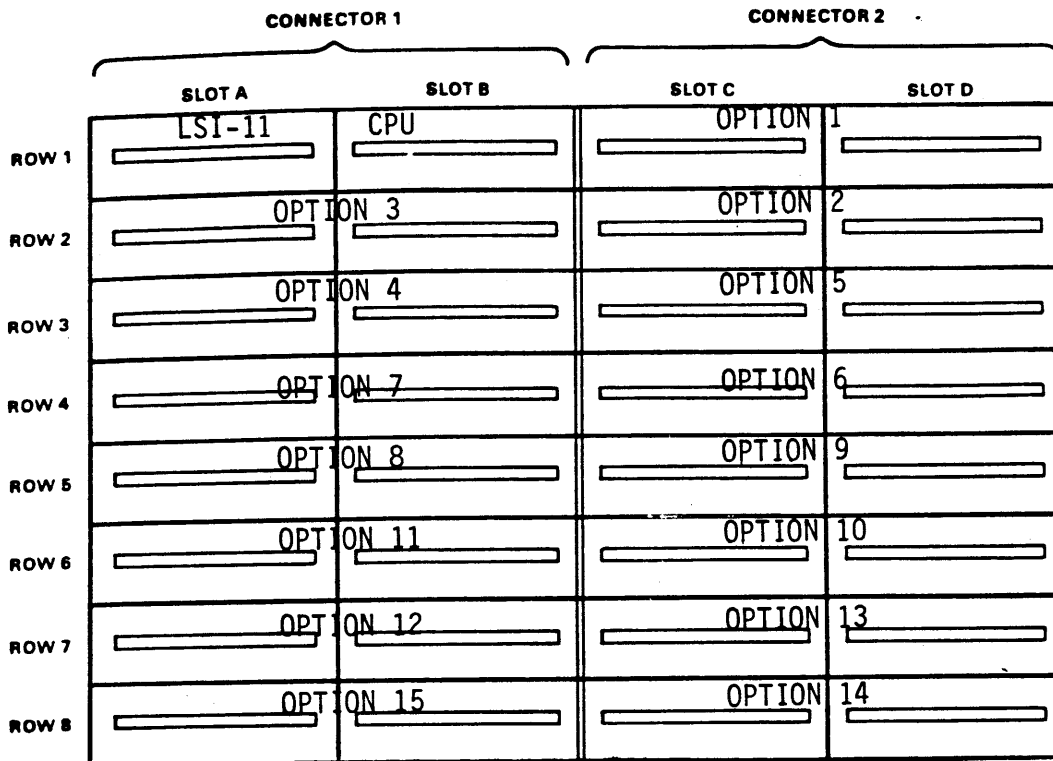

Option numbers by priority

View from Module side of Connector

FIGURE 1-3 LAB-DATA BACKPLANE PRIORITY

1.3.1 BACKPLANE PIN ASSIGNMENTS

BUS SIGNAL/PIN ASSIGNMENT

Module Side 1 (Component Side)				Module Side 2 (Solder Side)			
Row \bar{A} and Row C		Row B and Row D		Row A and Row C		Row B and Row D	
AA1	BSPARE1	BA1	BDCOKH	AA2	+5	BA2	+5
AB1	BSPARE2	BB1	BPOKH	AB2	-12	BB2	-12
AC1	BSPARE3	BC1	SSPARE4	AC2	GND	BC2	GND
AD1	BSPARE4	BD1	SSPARE5	AD2	+12	BD2	+12
AE1	SSPARE1	BE1	SSPARE6	AE2	BDOUTL	BE2	BDAL2L
AF1	SSPARE2	BF1	SSPARE7	AF2	BRPLYL	BF2	BDAL3L
AH1	SSPARE3	BH1	SSPARE8	AH2	BDINL	BH2	BDAL4L
AJ1	GND	BJ1	GND	AJ2	BSYNCL	BJ2	BDAL5L
AK1	MSPAREA	BK1	MSPAREB	AK2	BWTBTL	BK2	BDAL6L
AL1	MSPAREA	BL1	MSPAREB	AL2	BIRQL	BL2	BDAL7L
AM1	GND	EM1	GND	AM2	BIAKIL	BM2	BDAL8L
AN1	BDMRL	EN1	BSACKL	AN2	BIAKOL	BN2	BDAL9L
AP1	BHALTL	BP1	BSPARE6	AP2	BBS7L	BP2	BDAL10L
AR1	BREFL	BR1	BEVNTL	AR2	BDMGIL	BR2	BDAL11L
AS1	PSPARE3	BS1	PSPARE4	AS2	BDMGOL	BS2	BDAL12L
AT1	GND	BT1	GND	AT2	BINITL	BT2	BDAL13L
AU1	PSPARE1	BU1	PSPARE2	AU2	BDALOL	BU2	BDAL14L
AV1	+5B	BV1	+5	AV2	BDAL1L	BV2	BDAL15L

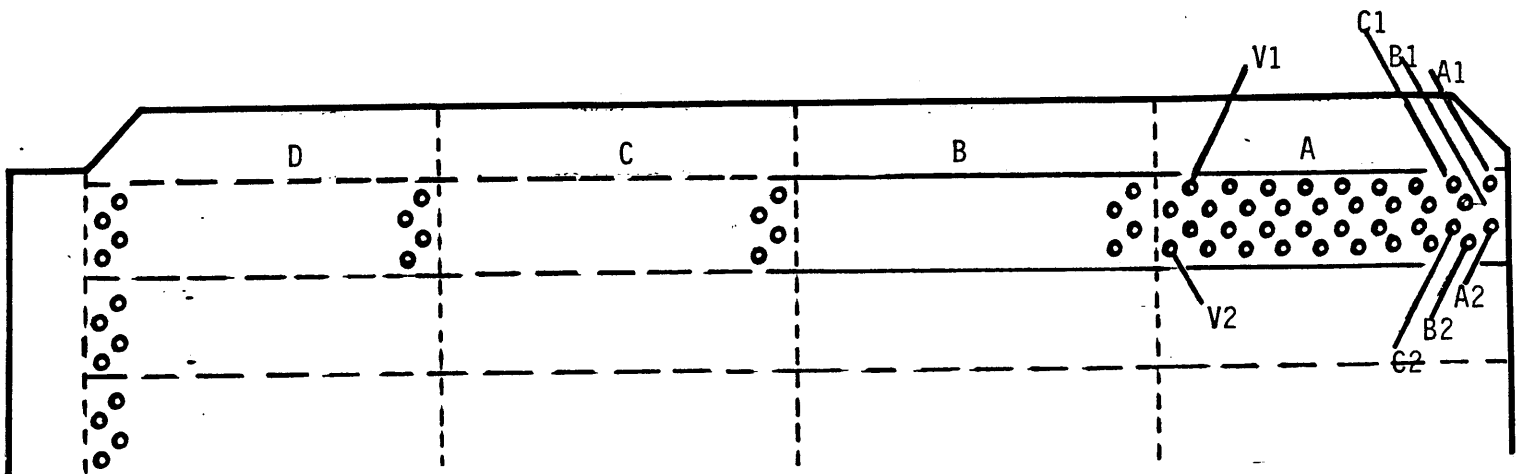

FIGURE 1-4 LAB-DATAX BACKPLANE (WIRE WRAP SIDE)

1.4 LAB-DATAX POWER SUPPLY

The LAB-DATAX Switching Power Supply is specifically designed for computer applications. The light weight, power supply provides two outputs, the combined wattage of all out-puts must not exceed 150 watts. A minimum load of 2.5A is required on the main output (5V) to maintain regulation on the auxiliary outputs.

1.4.1 GENERAL DESCRIPTION

The main output of the LAB-DATAX Switching Power Supply is a pulse-width modulated chopper converter.

The AC input is rectified, doubled and filtered to 300 VDC in the 115VAC input power supply. The AC input is rectified and filtered to 300VDC in the 230VAC input power supply. The 300VDC is then chopped and transformed to a lower voltage using a half-bridge-converter.

The transformer secondary output (consisting of a quasi-square wave) is rectified and filtered to the final DC output value.

The output is sensed and the error signal voltage is amplified and used to control the pulse width of the chopper, thus regulating the output voltage within narrow limits under all conditions of the input line and the output load.

The output and all control circuitry are isolated from AC input line.

This power supply has input undervoltage sense, soft start control, output current limiting and output overvoltage protection.

1.4.2 SPECIFICATIONS

Input Voltage: 115VAC, 92-130VAC, 47-450Hz @ 1.7A.
230VAC, 184-260VAC, 47-450Hz @ 0.85A.

Output Voltages: +5V @ 25A
+12V @ 5A

NOTE: A minimum load of 2.5A is required on the main output (V1) to maintain voltage on the auxiliary outputs.

Line Regulation: 0.4% on main output over entire range.
0.4% on 2nd and 3rd.

Load Regulation: 0.4% for no load to full load for main,
2nd and 3rd outputs.

Interaction: 0.1% maximum (static).

Ripple and Noise: 50mV P-P (maximum) for all outputs less than
12 volts.
100mV (maximum) for all outputs 12 volts or greater.

Overvoltage Protection: Standard for main output.
Optional on 2nd and 3rd outputs.
Factory set at 125+5%.

Overshoots and Undershoots: 2% Peak deviation for a 25% load change at 5A/us.

Response Time: 200us to 1% after a 25% load change at 5A/us for
main output. 50us to 1% after a 25% load change
at 5A/us for 2nd and 3rd outputs.

Holdup Time: Outputs remain in regulation for a minimum of 20Ms
after loss of nominal AC power.

Operating Temperature: Full load 0°C to 50°C with natural convection.
Derated to 50% of nominal power at 70°C.

Efficiency: 70% nominal

Reverse Voltage Protection: Main output has reverse voltage protection up to
100% of rated current. 3A average on all other
outputs.

Current Limit: All outputs have foldback current limit with
automatic recovery after overload is removed.

Temperature Coefficient: +0.02%/°C.

Storage Temperature: -55°C to +85°C.

CHAPTER 2
UNPACKING, INSTALLATION AND OPERATION

2.1 UNPACKING

The LAB-DATAX is shipped in a protective box. Remove the LAB-DATAX from the box and visually inspect for damage. Save the shipping cartons and packaging materials in case it is necessary to return the unit for service.

NOTE:

The front panel assembly of LAB-DATAX is designed to pull off so the user can access his modules and analog adjustments. Thus, the box should never be pulled from the front panel.

2.2 INSTALLATION

LAB-DATAX is shipped with modules installed and ready for operation.

2.2.1 A.C. POWER REQUIREMENT

Power cables are shipped with LAB-DATAX for connection to the A.C. line voltage of either 115Vac or 230Vac. The user should check the rear of the box for the label specifying the power configuration of his particular LAB-DATAX. A switched power receptacle is available for use to operate another peripheral. This is especially useful for operation of the floppy disk peripheral.

2.2.2 MODULE INSERTION AND REMOVAL

Modules must be inserted and removed only when the power is turned off. Use the front panel DC ON/OFF switch or the ON/OFF switch on the rear of the ac input box to turn off the power (refer to Paragraph 2.3 for a description of each of these switches).

Some quad modules are equipped with metal extractor-type handles that facilitate module insertion and removal. When inserting such a module into the backplane, begin by sliding the module, component side up, into the card guides. Slide the module all the way in and just start the module connector fingers into the backplane connectors. Fit the prongs of the handles into the holes in the card frame, as show in Figure 2-4. Press in on both handles simultaneously to fully insert the fingers in the backplane connector.

To remove a module, pull both handles out simultaneously until the prongs of the handle are clear of the holes in the card frame. The module fingers will now be nearly free of the backplane connector and the module can be removed easily.

CAUTION

Modules and/or the backplane assembly might be damaged if modules are inserted and removed with the power on, or if the modules are inserted upside down.

2.2.3 MODULE INSTALLATION

The equipment is shipped from the factory with the modules installed. Bus cables and communication cables must be connected to the modules, if not already in place. When removing modules to connect cables, or when installing new modules in an existing installation, follow these guidelines:

1. Ensure that double-size modules are inserted correctly in the backplane; i.e., LSI-11 bus modules plug into slots A and B (the two left-most slots), CD bus modules plug into slots C and D, and both types must be inserted right-side up.
2. The CPU can be inserted only in bus position 1 of the LAB-DATAX backplane ("bus positions" are defined in the backplane selector charts, Figures A-1 and A-2).
3. An M8016YB module (KPV-11A) must be inserted only in the last bus position.
4. If a module uses the LSI-11 bus grant and interrupt signals (BDMGI L/BDMGO L and BIAKI L/BIAKO L, respectively), there must be no empty LSI-11 bus positions between the module and the CPU, although empty CD bus positions are permitted.
5. Always ensure that modules are seated firmly and securely in the backplane.
6. The +5 Vdc regulated voltage is rated at 25A, full load, while the +12 Vdc regulated voltage is rated at 5A, full load. When installing new modules in a system backplane, take care not to exceed the full-load limits. See Appendix.

2.3 MOUNTING THE LAB-DATAX BOX IN AN EQUIPMENT RACK

Figure 2- shows the mounting dimensions and illustrates how the LAB-DATAX can be mounted in an equipment rack. This is accomplished by the use of a mounting bracket kit DTI Part #MA-083.

2.4 POWER CONNECTIONS

The LAB-DATAX box contains a circuit breaker at the rear for use as an ON/OFF switch. This circuit breaker switch will also switch an expansion outlet so that either an expansion box or a mating peripheral may be switched.

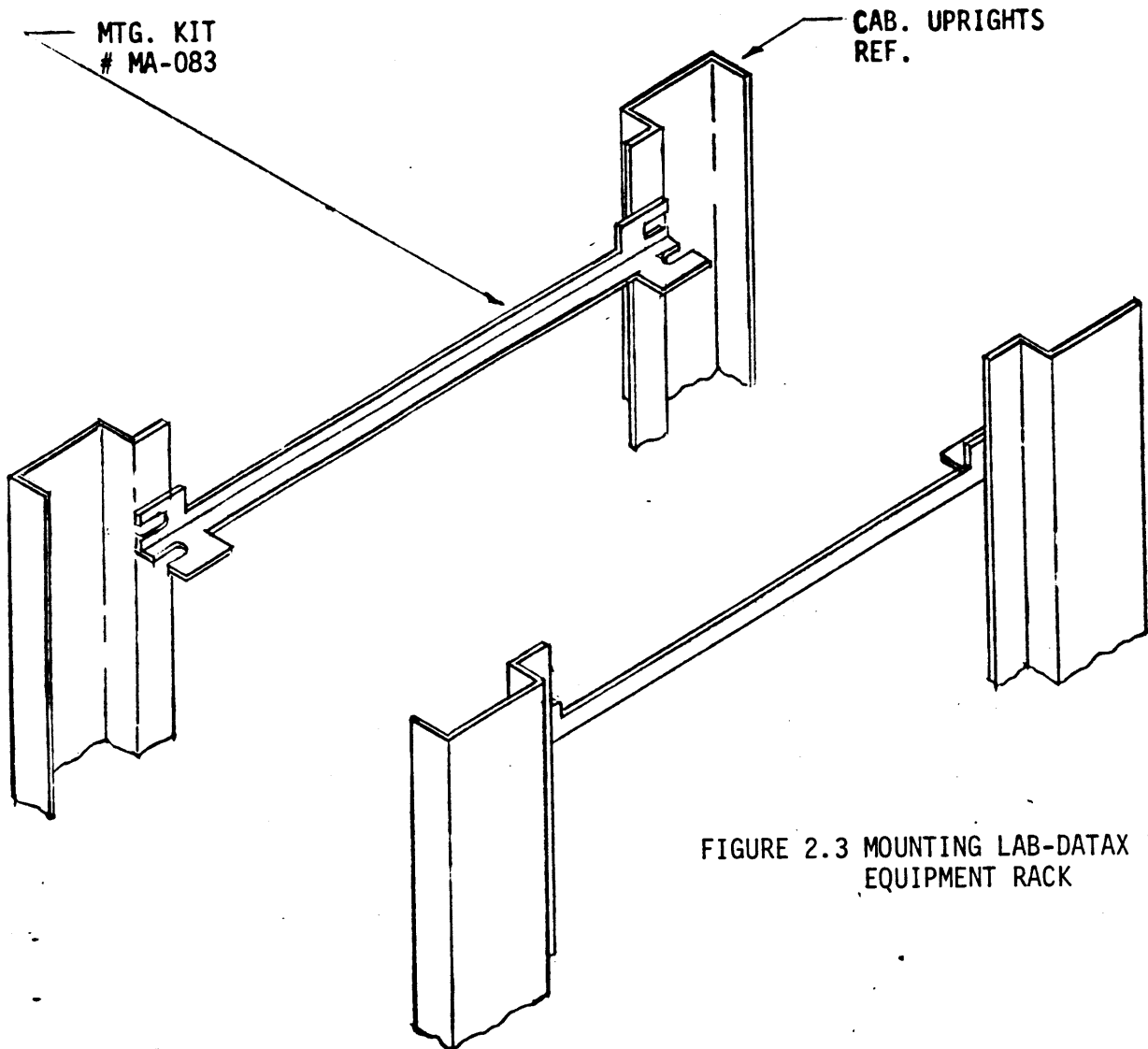

FIGURE 2.3 MOUNTING LAB-DATAX IN AN EQUIPMENT RACK

2.5 OPERATION

Each LAB-DATAX is equipped with a power panel containing three switches and two indicators. Figure 2-5 shows the placement of the switches and indicators and Table 2-5 provides a description of each.

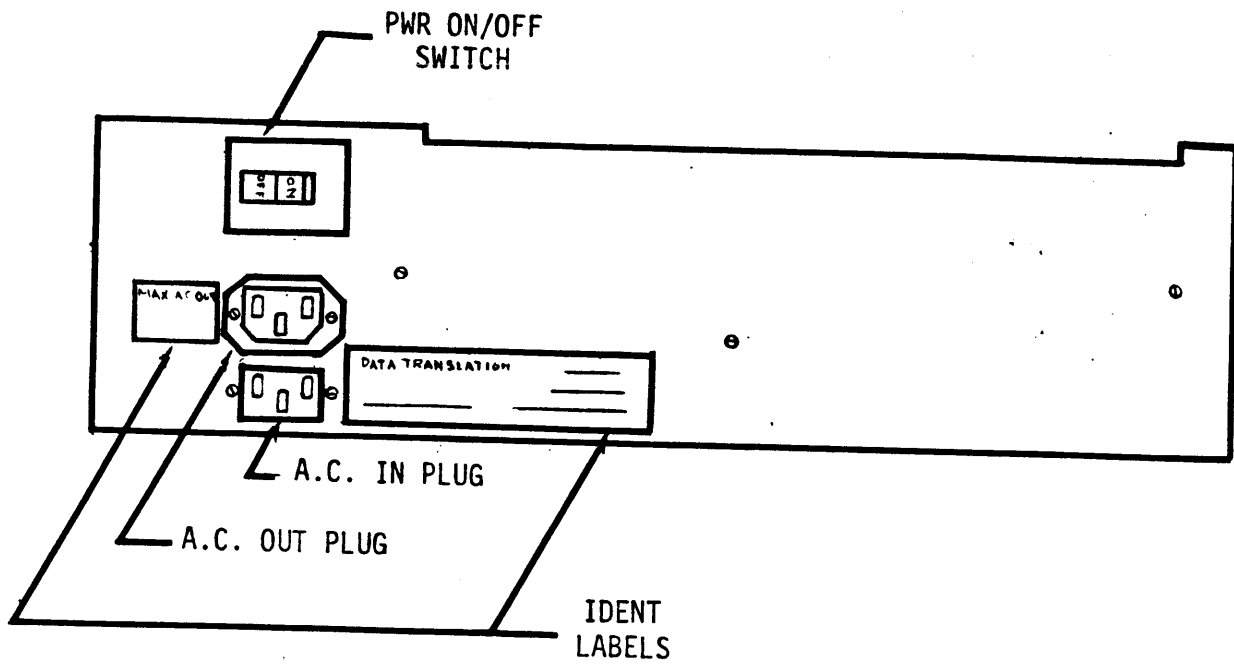

FIGURE 2-4 POWER CONNECTIONS & CONTROLS REAR PANEL

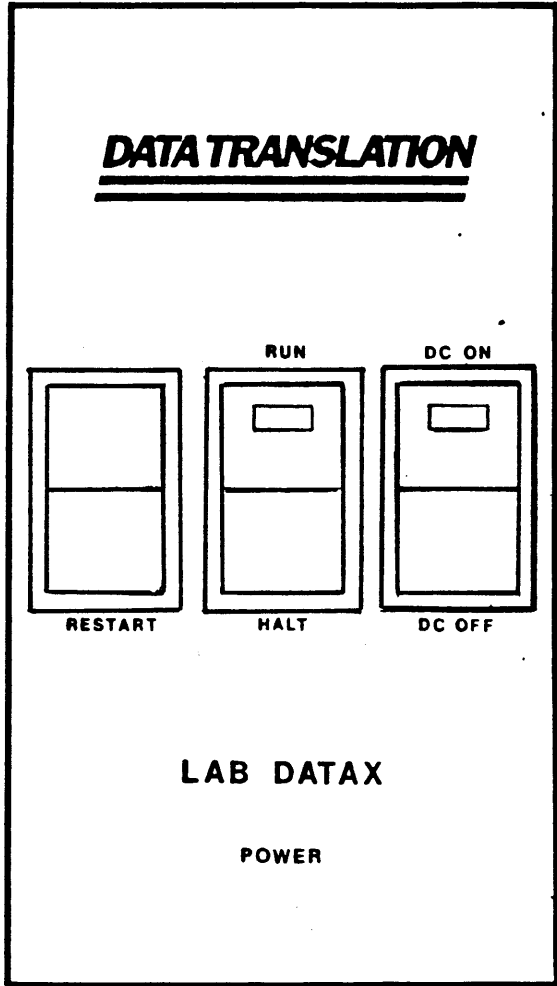

FIGURE 2-5 LAB-DATA X POWER PANEL

TABLE 2-5 LAB-DATAX

FRONT PANEL SWITCHES AND INDICATORS

SWITCH	INDICATOR	FUNCTION
DC ON/DC OFF	DC ON	<p>This switch will control D.C. power to the backplane.</p> <p>Indicates backplane D.C. power is on.</p>
RUN/HALT		<p>In the HALT position the switch forces the LSI-11 CPU to suspend normal program execution, enables console ODT microcode operation, and permits single-instruction execution. To resume program execution, return the switch to the RUN position and enter a "P" command from the terminal (providing the contents of R7 were left unchanged).</p>
RESTART	RUN	<p>Indicates CPU is executing programs.</p> <p>When the momentary RESTART switch is activated, the LSI-11 CPU automatically carries out a power up sequence; thus, the LSI-11 CPU can be rebooted at any time from the front panel</p>

2.5.1 LINE TIME CLOCK

Each LAB-DATAX system comes equipped with a programmable line time clock. This line signal is provided from a transformer mounted on the power control board to the right of the backplane assembly. This 24VAC line signal is fed to the KPU11-B option to provide the programmable LTC function.

2.5.2 PROGRAMMING THE LTC

The LTC function normally divides time into 16-2/3 ms or 20 ms intervals determined by the line frequency source (60Hz or 50Hz, respectively). The program communicates with the LTC function via the LKS register (Figure) contained in the KPV11 logic circuits. The LKS register's device address is normally configured to 177546 for system software compatibility.

LKS (177546)

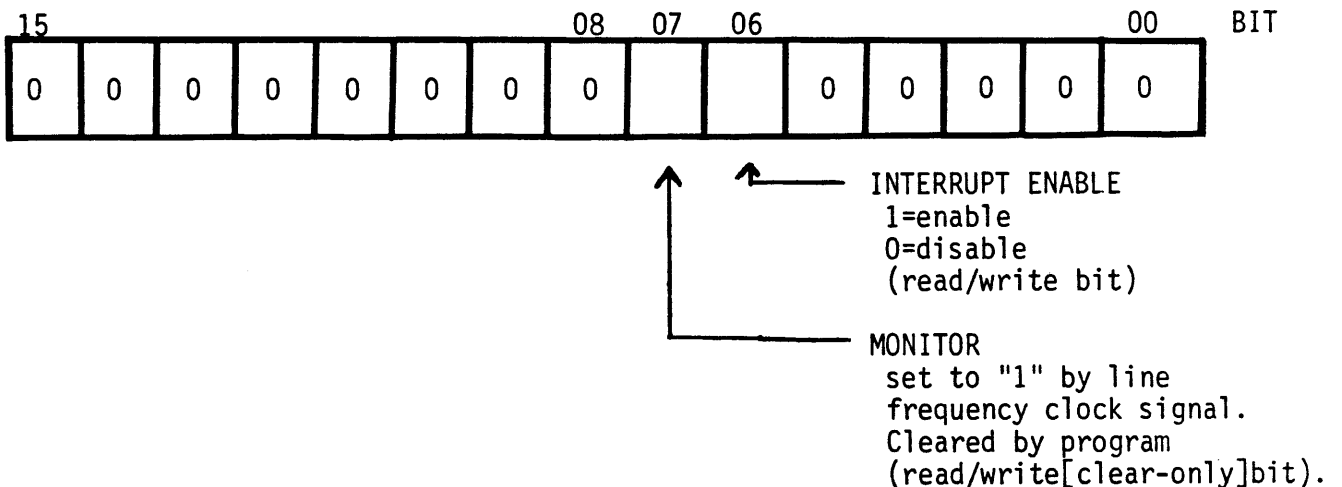
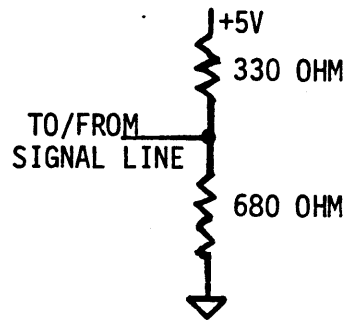

FIGURE LINE TIME CLOCK STATUS REGISTER (LKS)

LTC interrupts, when enable (LKS bit 6 = 1), occur as in interrupt request (bus low assertion) on the BEVNT L signal line. This causes the processor to execute a service routine via vector address 100. Memory location 100 must contain the PC (starting address) for the LTC service routine; similarly, memory location 102 must contain the PS (processor status word) for the service routine. As with all "external" interrupts, the processor will recognize the LTC interrupt request only when current PS bit 7 is cleared. When PS bit 7 = 1, external interrupts, including the LTC interrupt, are ignored. The LTC interrupt has highest priority of all external interrupts and does not require a vector address bus transfer. An interrupt request via the BEVNT L bus signal line, as previously stated, always results in access to the service routine via vector address 100.

2.5.3 BUS TERMINATIONS

The KPV11-B provides 220 ohm bus termination, each bus signal line terminator includes two resistors as shown.



Termination resistors are contained in 16 pin DIP packages. Each package contains 14 terminations. Daisy-chained grant signals are jumpered but are not terminated. BIAKL is jumpered to BIAKOL and BDBMGIL is jumpered to BDMGOL.

3.1 GENERAL

LAB-DATAX systems are provided in five standard configuration for a wide variety of applications. The five standard systems are listed below:

DT4021 LAB-DATAX

- 16 Analog Inputs, 12-bit, 35KHz A/D, 10KHz throughput into Memory
- Programmable Gain Amplifier
- 4 Channel D/A Output
- Programmable Real-Time Clock
- Digital I/O-16 Points

DT4022 LAB-DATAX EXPANDED

- 64 Analog Inputs, 12-bit, 35KHz A/D, 10KHz Throughput into Memory
- Programmable Gain Amplifier
- 16 Channel D/A Output
- Programmable Real-Time Clock
- Digital I/O-32 Points

DT4023 HIGH-THROUGHPUT LAB-DATAX

- 16 Analog Inputs, 12-bit A/D, DMA, 100KHz Throughput into Memory
- 2 Channel 12-bit D/A Converters with Point Plotting Capability and High Throughput DMA Interface
- Programmable Real-Time Clock
- Digital I/O-16 Points

DT4024 HIGH-THROUGHPUT LAB-DATAX EXPANDED

- 2 Sets of 16-Channel Analog Inputs, 12-bit A/D, DMA, 100 KHz Throughput into Memory
- 2 Sets of 2 Channel 12-bit D/A Converters with Point Plotting Capability and High Throughput DMA Interface
- 2 Programmable Real-Time Clocks
- Digital I/O-32 Points

DT4025 USER CONFIGURABLE LAB-DATAX

- Choose from Wide Variety of Data Translation Analog and Digital I/O Peripherals to Configure a System to Meet Your Demanding Needs

3.2 BASIC SYSTEM DT4025

Each LAB-DATAX configuration starts with a basic system which includes the following components:

1. 19" Rack Mountable Enclosure with Front Panel, Backplane and Power Supply.
2. LSI-11/2 CPU with Extended Arithmetic/Floating Point Instructions.
3. 32K Words of MOS RAM Memory.
4. DLVII Type Serial Line Unit.
5. Programmable Line Time Clock and Bus Terminations.
6. RT-11 V3B Operating System.
7. RT-11 Fortran IV.
8. DTLIB - Fortran Available Subroutines for all Analog I/O Functions.

3.3 LAB-DATAX ANALOG I/O AND DIGITAL PERIPHERALS

High Level A/D
(XX: Specify SE or DI configuration)

LDT2762-XX Analog Input System for high level inputs 16SE or 8DI, 12-bit A/D converter (ADVII-A Type)

OPTIONS for LDT2762
.Programmable Gain (-PG)
Gains of 1,2,4 & 8

High Resolution Options for LDT2762
.14-bit accuracy @ 10KHz (DT5714-XX-X)
.16-bit accuracy @ 2.5KHz (DT5716-XX-X)
.High Level Programmable Gain with gains of 1,2,4 & 8 (-PGH)

Low Level Wide Range A/D

LDT2764 Analog Input System for low level inputs, 10mV range, 16SE or 8DI, 12-bit A/D converter

OPTIONS for LDT2764
.Precision Resistor Gain Selection Kit (DT12-10501-2) for 12-bit systems
.14-bit resolution with selectable full scale from 5mV to 10V (DT5714-XX-X)
.16-bit resolution with selectable full scale from 5mV to 10V (DT5716-XX-X)
-Low Level Programmable Gain with gains of 1,10,100 & 500 for 14 & 16-bit systems only (-PGL)
.Precision Resistor Gain Selection Kit (DT13-10501-4) for 14 & 16-bit systems

D/A Outputs

LDT2766 Analog Output System with 4 D/A converter outputs and 4 digital outputs, 12-bit resolution (AAV11-A Type)

LDT2771 Direct Memory Access (DMA) Analog Output System for point plotting, 2 channel 12-bit D/A converters with power amplifier output and Z-axis control, for high speed outputs such as graphics and display applications.

High Throughput

(XX: Specify SE or DI Configuration)

LDT2782-XX Direct Memory Access (DMA) Analog Input System for high level inputs, 45KHz data throughput* into memory 16SE or 8DI, 12-bit A/D converter.

OPTIONS for LDT2782

.100KHz throughput* into memory (-C)

.135KHz throughput* into memory (-A) (*Single Channel)

High Resolution Options for DT2782

.14-bit accuracy @ 10KHz (DT5714-XX-X)

.16-bit accuracy @ 2.5KHz (DT5716-XX-X)

.High Level Programmable Gain with gains of 1,2,4 & 8 (-PGH)

LDT2784-XX Direct Memory Access (DMA) Low Level Wide Range Analog Input System for signal input ranges from 10mV to 10V, 35KHz data throughput into memory (Gain=1), 16SE or 8DI, 12-bit A/D converter

OPTIONS for LDT2784

.DT12-10501-2 Precision Resistor Gain Selection Kit for 12-bit systems

.14-bit resolution @ 10KHz (Gain=1) with selectable full scale from 5mV (DT5714-XX-X)

.16-bit resolution @ 2.5KHz (Gain=1) with selectable full scale from 5mV to 10V (DT5716-XX-X)

.Low Level Programmable Gain with gains of 1,10,100 & 500 for only 14 & 16-bit systems (-PGL)

.Precision Resistor Gain Selection Kit (DT13-10501-4) for 14 & 16-bit systems

Multiplexer Channel Expansion (Connection via DT701 Screw Terminal Panel)
(XX:Specify SE or DI Configuration - plus total channels)

LDT2772-XX Analog Input Expansion plus cables for high level inputs, works with analog input model LDT2762 (Total of 64SE or 32DI)

LDT2774 Analog Input Expansion plus cables for low level, wide range, works with analog input model LDT2764, gives total of 64SE or 32DI

LDT2775 Isolated Input Expansion plus cables for expansion in 8DI channel segments, works with isolated analog input model LDT2765

Digital Peripheral Control Boards

LDT2768 Parallel digital I/O plus cables (DEC DRV11 equivalent)

LDT2768-I Isolated parallel digital I/O plus cables, 16 inputs/16 outputs

LDT2769 Programmable Real-Time Clock Board (DEC KV11-A equivalent)

CONNECTION PANELS

DT701-XX Universal Screw Terminal and Signal Conditioning Panel mates with all analog I/O interface boards (XX: Specify 50,40 or 20 pin cable connector(s))

Options for DT701

- .Thermocouple cold junction compensation (-T)
- .Enclosed rack mounting assembly with plexiglass cover (-MA)

"L" Prefix designates analog interface board plus LAB-DATAX front panel with connectors and cable assembly.

3.4 LAB-DATAX Standard Configurations

<u>MODEL</u>	<u>SLOTS USED/SLOTS AVAILABLE</u>	<u>DESCRIPTION</u>
DT4021	9/7	LAB-DATAX Base System LDT2762-XX-PG LDT2766 LDT2769 LDT2768
DT4022	14/2	LAB-DATAX EXPANDED Base System LDT2762-XX-PG LDT2772-XX + DT701 4 Units LDT2766 LDT2769 2 Units LDT2768
DT4023	9/7	HIGH THROUGHPUT LAB-DATAX Base System LDT2782-SE-C LDT2771 LDT2769 LDT2768

<u>MODEL</u>	<u>SLOTS USED/SLOTS AVAILABLE</u>	<u>DESCRIPTION</u>
DT4024	13/3	HIGH THROUGHPUT LAB-DATAX EXPANDED Base System 2 Units LDT2782-SE-C 2 Units LDT2771 2 Units LDT2769 2 Units LDT2768
DT4025	5/11	USER CONFIGURABLE LAB-DATAX Base System User Selections

3.5 FRONT PANEL CONFIGURATIONS

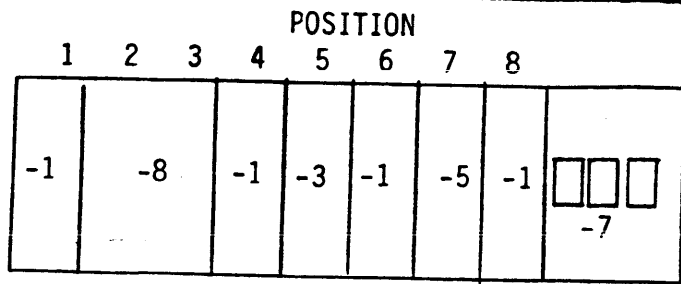

DT4021-SE

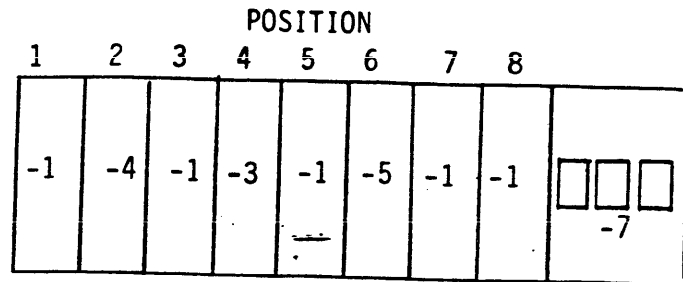

DT4021-DI

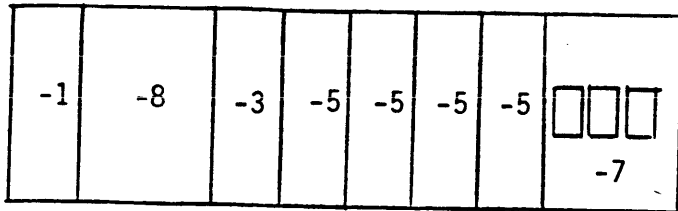

DT4022-SE

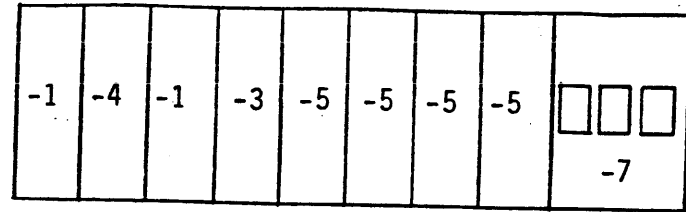

DT4022-DI

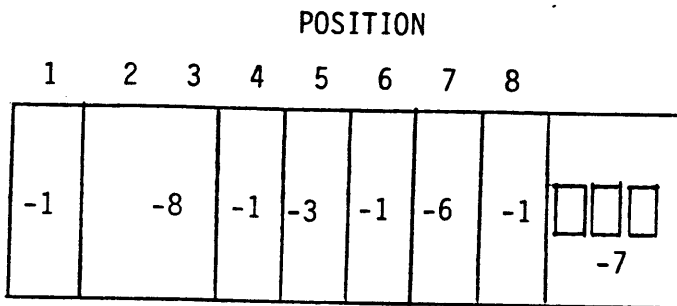

DT4023-SE

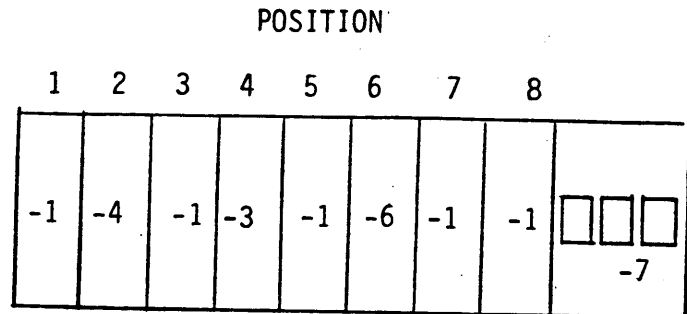

DT4023-DI

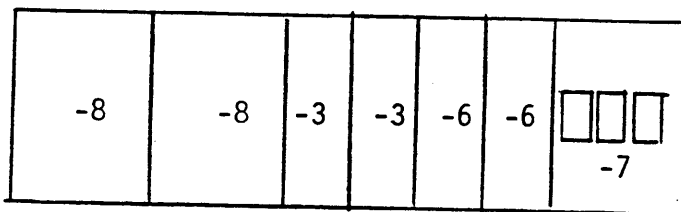

DT4024-SE

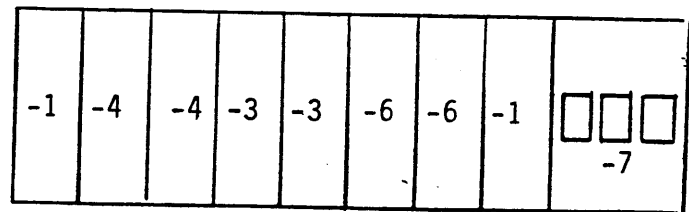

DT4024-DI

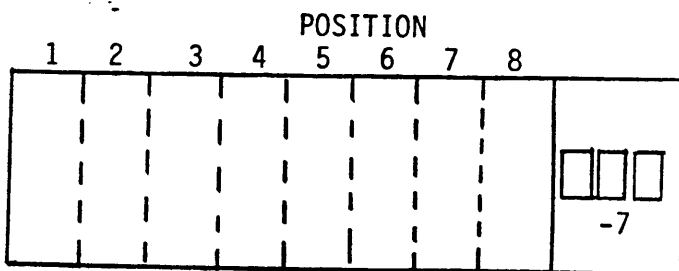

DT4025

USER CONFIGURED

INTERFACE BOARD TYPE	PANEL NO.
LDT2762-SE	MP083-8
LDT2782-SE	MP083-8
LDT2764-SE	MP083-8
LDT2784-SE	MP083-8
LDT2762-DI	MP083-4
LDT2782-DI	MP083-4
LDT2784-DI	MP083-4
LDT2764-DI	MP083-4
LDT2766	MP083-5
LDT2769	MP083-3
LDT2771	MP083-6
Plank Filler Panel	MP083-1
Power Panel	MP083-7

POINT PLOTTER

DTI# MP083-6

Compatible with: LDT2771

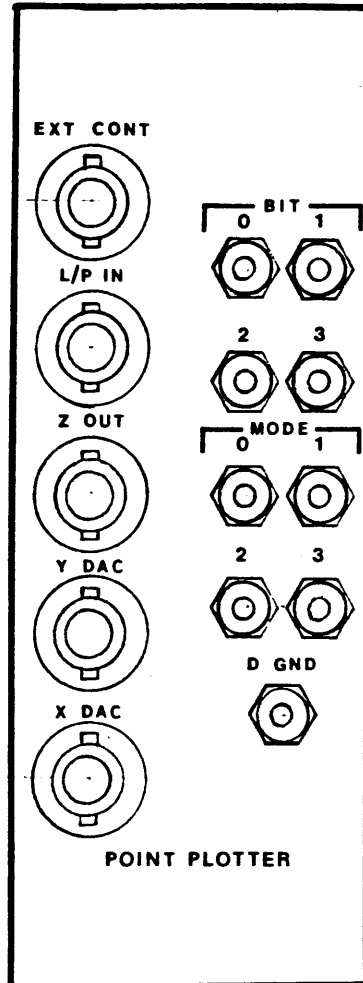

4 CHANNEL D/A OUTPUTS

Compatible with: LDT2766

DTI# MP083-5

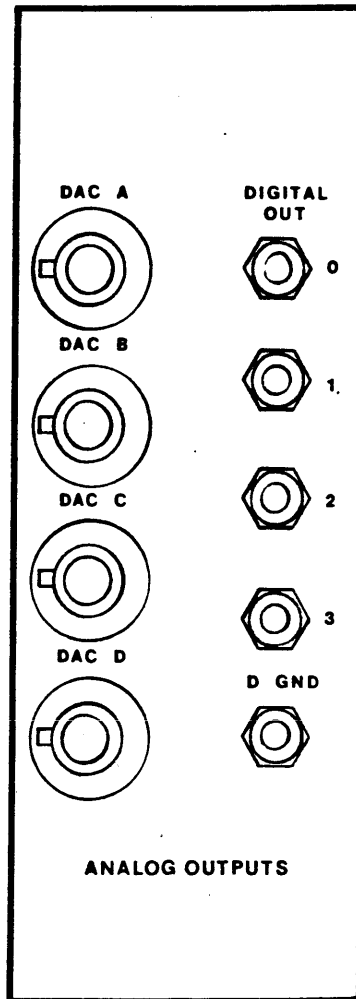

8 DIFFERENTIAL ANALOG INPUTS

DTI# MP083-4

Compatible with: LDT2762-DI
LDT2782-DI
LDT2764 (DI Selected)
LDT2784 (DI Selected)

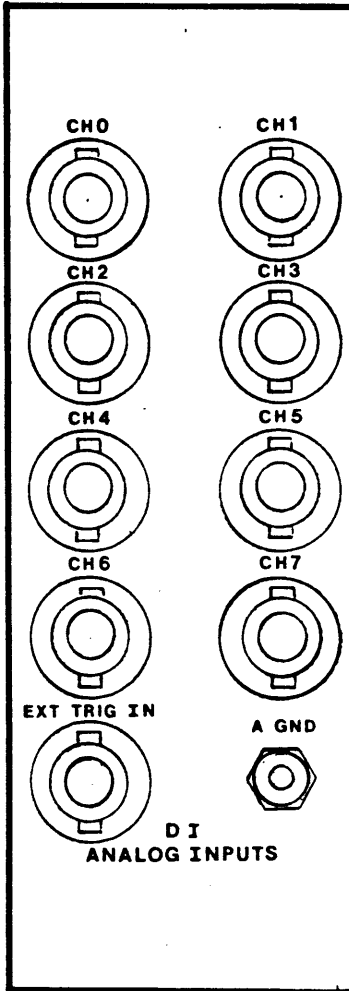

16 SINGLE ENDED ANALOG INPUTS

DTI# MP083-8

Compatible with: LDT2762-SE
LDT2782-SE
LDT2764 (SE Selected)
LDT2784 (SE Selected)

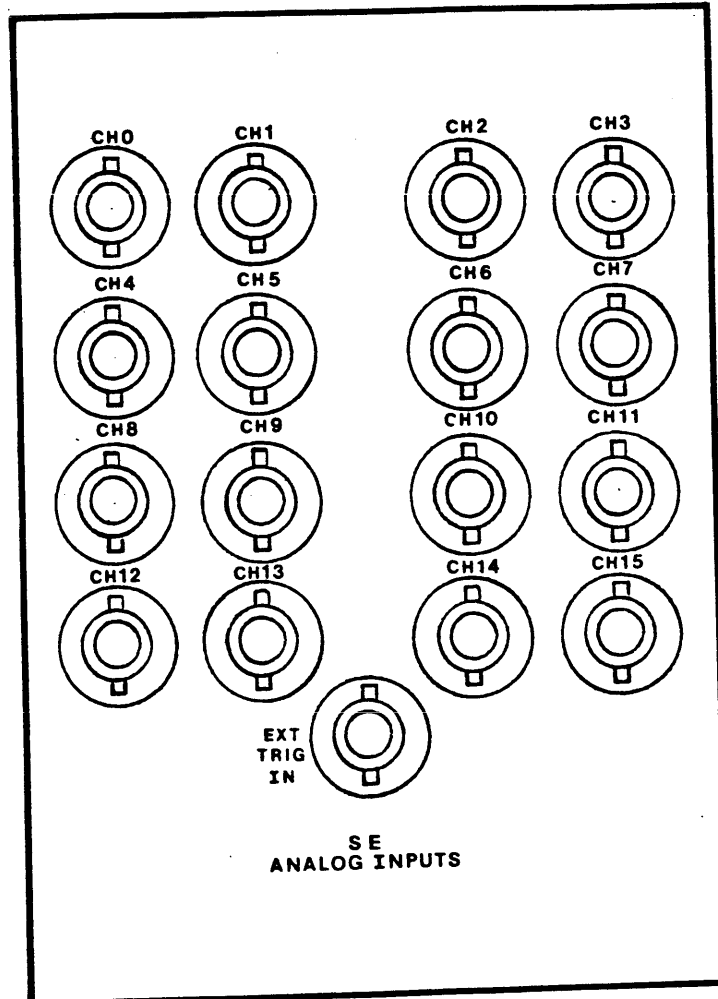

REAL TIME CLOCK PANEL

Compatible with: LDT2769

DTI# MP083-3

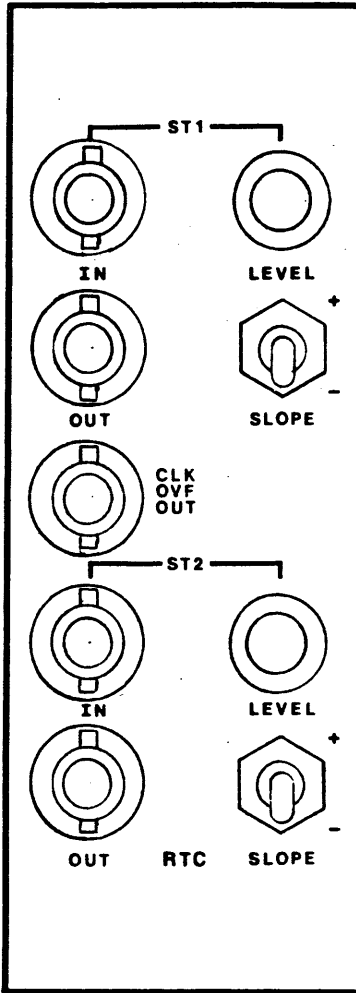

DATA TRANSLATION

INC

4 Strathmore Rd., Natick MA 01760

(617) 655-5300

Telex 948474