



**CYBER INITIALIZATION PACKAGE (CIP)
USER'S HANDBOOK**

CDC® COMPUTER SYSTEMS:

CYBER 180

CYBER 170

CYBER 170M

CYBER 70

MODELS 71, 72, 73, 74

6000

Manual History

Manual released at revision N in May 1989.

Revision	System Version	CIP Level	Date
A			February 1984
B		L002	May 1984
C		L003	December 1984
D		L004	May 1985
E		L005	December 1985
F		CV006	July 1986
G		CV007	April 1987
H		CV008	September 1987
J		V9 L700	April 1988
K		V9 L704	July 1988
L		V9 L710	September 1988
M		V10 L716	November 1988
N	NOS 2.7.2; NOS/VE 1.4.2	V10 L727	May 1989

Revision N of this manual incorporates changes at CIP level 727. Changes include miscellaneous updates.

©1988, 1989 by Control Data Corporation
All rights reserved.
Printed in the United States of America.

Contents

About This Manual	9	CIP Procedures, Displays, and Options for Non-Model 800 Computer Systems	4-1
Organization	9	CIP Installation, Non-800 Computer Systems	4-3
Audience	9	OS Deadstart, Non-800 Computer Systems	4-5
Conventions	9	Disk/OS Tape Deadstart Displays, Non-800 Computer Systems	4-7
Related Publications	12	CIP Tape Deadstart Displays, Non-800 Computer Systems	4-23
Ordering Manuals	13		
Submitting Comments	13		
Disclaimer	13		
Introduction	1-1	Deadstart Procedure Summaries ..	5-1
CIP Features	1-2	Coldstart Procedures	5-9
Considerations for Sites with Non-Model 800 Computer Systems	1-4	Warmstart Procedures	5-9
		Setting Word 12	5-55
		Setting Word 13	5-56
CIP Procedures, Displays, and Options for I1n, I2n, I4n, and I4Cn Class Systems	2-1	General CIP Procedures	6-1
CIP Installation, I1n and All Single IOU I4n Class Systems	2-3	Emergency CIP Repair	6-3
CIP Installation, Dual IOU I4n Class Systems	2-8	CIP Utility Procedures	6-7
CIP Installation, I4Cn Class Systems	2-8.3	Loading and Installing Disk Subsystem Microcode from Tape ..	6-28
CIP Installation, I2n Class Systems	2-10	Operator Intervention Procedures ..	6-31
OS Deadstart, I1n, I2n, I4Cn, and All I4n Class Systems	2-13	Build Deadstart Disk Operations (All Systems, Excluding I4Cn Class Systems)	6-35
Deadstart From Disk Displays, I1n, I2n, I4Cn, and All I4n Class Systems	2-17	Install-Update CIP System Console Utility (IUC)	6-40
CIP Tape Deadstart Displays, I1n, I2n, and All I4n Class Systems	2-53	Special Keys and Descriptive Messages Utilized by IUC	6-53
CIP Tape-Related Deadstart Displays, I4Cn Class Systems	2-74		
CIP Procedures, Displays, and Options for CYBER 170/170M Models 865	3-1	Monitor Display Driver (MDD)	7-1
CIP Installation, Models 865 and 875	3-3	MDD Terminal Control	7-1
OS Deadstart, Models 865 and 875	3-5	Command Syntax	7-1
Disk Deadstart Displays, Models 865 and 875	3-7	MDD Initialization	7-2
CIP Tape Deadstart Displays, Models 865 - 875	3-25	Conventions	7-3
		Central Memory Display Commands	7-4
		Central Memory Change Commands	7-8
		Maintenance Register Display Commands	7-9
		DFT Commands	7-15
		Control Store Commands	7-22
		Miscellaneous Commands	7-26

Other Messages to the Terminal	7-28	Mainframe Reconfiguration	G-1
Error Log/Dayfile Messages	7-31	PP Reconfiguration	G-1
Examples of MDD Command		Turning Off PPs	G-3
Usage	7-32	CYBER 70/6000 Computer	
Registers Displayed by MDD	7-37	Systems PP Reconfiguration	G-3
Glossary	A-1	CYBER 170 Computer Systems	
CIP Error and Informative		(Except Models 815, 825, 835,	
Messages	B-1	845, and 855) PP	
Field Change Announcement		Reconfiguration	G-6
(FCA) Interpretation for Model		Models 835 through 860 PP	
800 Computer Systems	C-1	Reconfiguration	G-9
Problem Reporting	D-1	Models 810, 815, 825, 830, and	
Hardware Initialization		990 PP Reconfiguration	G-11
Verification Software (HIVS)		CM Reconfiguration for CYBER	
Tests	E-1	170 Computer Systems (Except	
Peripheral Processor (PP)		Models 815, 825, 835, 845, and	
Configurations	F-1	855)	G-14
		CM Reconfiguration for Models	
		810 and 830	G-20
		CM Reconfiguration for Models	
		815, 825, 835, 840, 845, 850,	
		855, 860 and 990	G-21
		CC634B Console Initialization	H-1

Figures

2-1. Overview of Displays for I1n		2-13. Dump to Printer Options for	
Class Systems, Deadstart From		I4n 990 Class Systems, Disk	2-45
Disk	2-19	2-14. Dump to Printer Options for	
2-2. Overview of Displays for I2n		All CYBER Systems Except I4n	
Class Systems, Deadstart From		990 Class Systems, Disk	2-45
Disk	2-21	2-15. Alternate Deadstart	2-48
2-3. Overview of Displays for I4n		2-16. MDD Parameters	2-50
Class Systems, Deadstart From		2-17. Path Select Display	2-51
Disk	2-23	2-18. Overview of Displays for I1n	
2-4. Initial Options From CIP		Class Systems, Deadstart From	
Device for I1n, I2n, and All I4n		Tape	2-55
Class Systems	2-25	2-19. Overview of Displays for I2n	
2-5. Operator Intervention	2-29	Class Systems, Deadstart From	
2-6. Hardware Reconfiguration	2-30	Tape	2-57
2-7. Reconfigure CPU Elements for		2-20. Overview of Displays for I4n	
I1n, I2n, and All I4n Class		Class Systems, Deadstart From	
Systems	2-31	Tape	2-59
2-8. Deadstart Panel Parameters for		2-21. Initial Options From CIP	
NOS or NOS/BE	2-36	Tape	2-61
2-9. Deadstart Panel Parameters for		2-22. Build Deadstart Disk for I1n	
NOS/VE	2-37	Class Systems	2-63
2-10. Deadstart Device	2-39	2-23. Build Deadstart Disk for I2n	
2-11. Load MDD	2-40	and All I4n Class Systems	2-63
2-12. Utilities, Disk Deadstart	2-44	2-24. Manual Operations	2-65

2-25. Replace CTI/MSL Disk Area Module.....	2-66	4-1. Overview of Displays and Options for Deadstart From Disk (Non-Model 800 Computer Systems).....	4-9
2-26. Utilities, Tape Deadstart	2-67	4-2. Initial Options From Disk or From OS Tape.....	4-11
2-27. Dump to Printer Options for I4n 990 Class Systems, Tape.....	2-68	4-3. Operator Intervention	4-13
2-28. Dump to Printer Options for All CYBER Systems Except I4n 990 Class Systems, Tape.....	2-68	4-4. Hardware Reconfiguration	4-14
2-29. Alternate Deadstart	2-71	4-5. Deadstart Panel Parameters ...	4-16
2-30. Overview of Displays for Single IOU I4Cn Class Systems, CIP Tape-Related Deadstart Displays.....	2-77	4-6. Deadstart Device	4-18
2-31. Overview of Displays for Dual IOU I4Cn Class Systems, CIP Tape-Related Deadstart Displays ...	2-78	4-7. Utilities, Disk Deadstart	4-19
2-32. Maintenance Options - Single IOU.....	2-79	4-8. Dump to Printer Options	4-20
2-33. Maintenance Options - Dual IOU.....	2-79	4-9. Alternate Deadstart.....	4-21
2-34. Maintenance Options (System Load With LDS).....	2-81	4-10. Overview of Displays and Options for Deadstart From CIP Tape (Non-Model-800 Computer Systems).....	4-25
2-35. Maintenance Options - IOU0 ..	2-81	4-11. Initial Options From CIP Tape.....	4-27
2-36. Select CIP Partition	2-82	4-12. Build Deadstart Disk	4-28
2-37. Intermediate IUC Display	2-82	4-13. Manual Operations	4-29
2-38. CIP Installation	2-83	4-14. Utilities, Tape Deadstart.....	4-30
2-39. Manual Operations	2-84	4-15. Dump to Printer Options	4-31
2-40. Replace MSL	2-85	4-16. Alternate Deadstart	4-32
2-41. Replace Common Disk Area ..	2-86	5-1. Deadstart Options Menu	5-2
2-42. IOU/Peripheral Tests	2-87	5-2. Console Main Menu (CC598B Console).....	5-4
3-1. Overview of Displays and Options for Deadstart from Disk (Models 865 and 875).....	3-9	5-3. System Load Options Warning (CC598B Console).....	5-4
3-2. Initial Options From Disk	3-11	5-4. Maintenance Options Menu (CC598B Console - Dual IOU System).....	5-5
3-3. Operator Intervention	3-13	5-5. Maintenance Options - IOUn Display (CC598B Console).....	5-5
3-4. Hardware Reconfiguration	3-14	5-6. Console Main Menu (CC598A Console).....	5-6
3-5. Deadstart Panel Parameters ...	3-16	5-7. System Load Options Warning (CC598A Console).....	5-7
3-6. Deadstart Device	3-19	5-8. Maintenance Options Menu (CC598A Console, Single IOU System).....	5-7
3-7. Utilities, Disk Deadstart	3-20	5-9. Maintenance Options Menu (CC598A Console, Dual IOU System).....	5-8
3-8. Dump to Printer Options	3-21	5-10. Maintenance Options - IOUn Display (CC598A Console).....	5-8
3-9. Alternate Deadstart	3-22	5-11. Warmstart	5-11
3-10. Overview of Displays and Options for Deadstart From CIP Tape (Models 865 and 875).....	3-27	5-12. Maintenance Options Display for I1n and Single IOU I4n Class Systems.....	5-13
3-11. Initial Options From CIP Tape.....	3-29	5-13. CYBER 170 Computer Systems Deadstart Panel.....	5-18
3-12. Build Deadstart Disk	3-31		
3-13. Manual Operations	3-32		
3-14. Utilities, Tape Deadstart	3-33		
3-15. Dump to Printer Options	3-34		
3-16. Alternate Deadstart	3-35		

5-14. CYBER 70/6000 Computer Systems Deadstart Panel.....	5-19	Systems) on a Channel Without a PP/Coldstart of 698 Tape Units From CIP Device (I4Cn C	
5-15. I2n Class Systems Deadstart Panel.....	5-20	5-31. Setting Word 12 Switches.....	5-55
5-16. CYBER 170 and I1n, I2n, and All I4n Class Systems Panel/Program Settings for Warmstarts from a Channel with a PP (For Example, Channel 1, 2,		5-32. Setting Word 13 Switches.....	5-56
5-17. CYBER 70 and 6000 Computer Systems Panel Settings for Warmstarts from a Channel with a PP (For Example, Channel 1, 2, or 11).....	5-25	5-33. Setting Word 13, NOS Deadstart.....	5-57
5-18. CYBER 70 and 6000 Computer Systems Panel Settings for Warmstarts from a Channel with No PP (For Example, Channel 0, 12, or 13).....	5-25	5-34. Setting Word 13, NOS/BE Deadstart.....	5-60
5-19. Coldstart of 7021/7152 Tape Controller From Card Reader.....	5-29	5-35. Setting Word 13, Deadstart Parameters.....	5-62
5-20. Coldstart of 7152 Tape Controller From Tape Unit.....	5-31	5-36. Setting Word 13, CMRDECK .	5-63
5-21. Coldstart of Disk Controller From Card Reader.....	5-33	5-37. Setting Word 13, CMR	5-64
5-22. Coldstart of 7152/7155/7165 Disk Controller From Disk Unit (CYBER 70/6000 Systems).....	5-36	5-38. Setting Word 13, DCFILE	5-64
5-23. Coldstart of 7152/7155/7165 Disk Controller From Disk Unit, With No PP on Disk Channel (I1n, I2n, and All I4n Class Systems).....	5-37	C-1. How to Read the FCA Chart ...	C-2
5-24. Coldstart of 7152/7155/7165 Disk Controller From Disk Unit, With a PP on Disk Channel (I1n, I2n, and All I4n Class Systems)....	5-38	G-1. Sample Reconfiguration	G-2
5-25. Coldstart/Warmstart of 834/836 Disks From a Disk Unit, With No PP on Disk Channel.....	5-41	G-2. Sample Reconfiguration for a Bad PP.....	G-4
5-26. Coldstart/Warmstart of 834/836 Disks From a Disk Unit, With PP on Disk Channel.....	5-41	G-3. PP MEMORY SELECT Switches	G-6
5-27. Coldstart of 639 Tape Units From Tape on a Channel With a PP.....	5-47	G-4. Reconfiguration of Barrel 0 for CYBER 170 Computer Systems.....	G-7
5-28. Coldstart of 639 Tape Units From Tape on a Channel With No PP.....	5-48	G-5. Sample Reconfiguration Using the PP MEMORY SELECT Switches for CYBER 170 Computer Systems (Except Models 815, 825, 835, 845, and 855).....	G-6
5-29. Coldstart of 698 Tape Units From Tape (I1n, I4n Class Systems) on a Channel With a PP/Coldstart of 698 Tape Units From CIP Device (I4Cn Clas		G-6. Sample Model 835 Through 860 PP Reconfiguration.....	G-9
5-30. Coldstart of 698 Tape Units From Tape (I1n, I4n Class		G-7. PPM Switches	G-10
		G-8. Sample Model 835 Through 860 Reconfiguration Using PPM Switches	G-10
		G-9. Sample Reconfiguration for Models 815 and 825 With 15 PPs..	G-12
		G-10. Sample Reconfiguration for Models 810, 815, 825, 830, and 990 With 20 PPs.....	G-13
		G-11. Switch Numbering Scheme for CYBER 170 Computer Systems Models 171, 172, 173, 174, 720, and 730.....	G-19
		G-12. Switch Numbering Scheme for CYBER 170 Computer Systems Models 175, 176, 740, 750, 760, 865, and 875.....	G-19
		G-13. Switch Numbering Scheme for Models 815 and 825 Without Memory Upgrade Option.....	G-23
		G-14. Switch Numbering Scheme for Models 815 and 825 with Memory Upgrade Option.....	G-25

G-15. Switch Numbering Scheme for Models 835, 845, and 855 Without Memory Upgrade Option.....	G-27	Upgrade Option and for Models 840, 850, and 860	G-29
G-16. Switch Numbering Scheme for Models 845 and 855 With Memory		G-17. Switch Numbering Scheme for Model 990.....	G-30
		H-1. Mode Installation Parameters ...	H-4

Tables

1-1. Disk Space Requirements for CYBER Mainframes	1-3	5-1. Deadstart Parameters Switch Settings.....	5-62
2-1. Hardware Reconfiguration Entries.....	2-32	6-1. Locations Affected by EDD	6-8
2-2. Keyboard Entries for the Deadstart Panel Parameters Display for NOS or NOS/BE.....	2-36	6-2. Replace MSL Options	6-45
2-3. Keyboard Entries for the Deadstart Panel Parameters Display for NOS/VE.....	2-37	6-3. Replace CDA Module Options ..	6-51
2-4. Keyboard Entries for a Printer Dump, I1n, I2n, and All I4n Class Systems, Disk Deadstart.....	2-46	6-4. IUC Special Keys	6-53
2-5. Keyboard Entries for a Printer Dump, I1n, I2n, and All I4n Class Systems, Tape Deadstart.....	2-69	6-5. IUC Informative Messages	6-54
3-1. Hardware Reconfiguration Entries, Models 865 and 875.....	3-15	6-6. IUC Error Messages	6-55
3-2. Keyboard Entries for the Deadstart Panel Parameters Display, Models 865 and 875.....	3-17	F-1. Channels That Are Not Connected to an Active PP.....	F-1
3-3. Keyboard Entries for a Printer Dump, Models 865 and 875, Disk ..	3-21	G-1. Deadstart PP Reconfiguration ...	G-5
3-4. Keyboard Entries for a Printer Dump, Models 865 and 875.....	3-34	G-2. CM Reconfiguration for Models 171, 172, 173, and 174	G-15
4-1. HIVS Tests by Computer System.....	4-14	G-3. CM Reconfiguration for Model 175	G-16
4-2. Hardware Reconfiguration Entries, Non-Model-800 Computer Systems.....	4-15	G-4. CM Reconfiguration for Models 176, 740, 750, and 760.....	G-17
4-3. Keyboard Entries for the Deadstart Panel Parameters Display, Non-Model-800 Computer Systems.....	4-17	G-5. CM Reconfiguration for Models 720 and 730.....	G-17
4-4. Keyboard Entries for a Printer Dump, Non-Model-800 Computer Systems, Disk	4-20	G-6. CM Reconfiguration for Models 865 and 875.....	G-18
4-5. Keyboard Entries for a Printer Dump, Non-Model-800 Computer Systems, Tape.....	4-31	G-7. CM Reconfiguration for Models 810 and 830 Without Memory Upgrade Option	G-22
		G-8. CM Reconfiguration for Models 815 and 825 Without Memory Upgrade Option	G-24
		G-9. CM Reconfiguration for Models 810, 815, 825, and 830 With Memory Upgrade Option.....	G-25
		G-10. CM Reconfiguration for Models 835, 845, and 855 Without Memory Upgrade Option.....	G-26
		G-11. CM Reconfiguration Switch Settings for Models 845 and 855 With Memory Upgrade Option and for Models 840, 850, and 860	G-28
		G-12. CM Reconfiguration for Model 990	G-30

About This Manual

The CYBER Initialization Package (CIP) Reference Manual includes information on how to install and use CIP on CDC® CYBER 180 computer systems models 810, 830, 835, 840, 840A, 845, 850, 850A, 855, 860, 860A, 870A, and 990; CDC CYBER computer systems 810A, 830A, 960, 962, 990E, 992, 994, 995E; CDC CYBER 170 computer systems models 171, 172, 173, 174, 175, 176, 720, 730, 740, 750, 760, 815, 825, 835, 845, 855, 865, and 875; CDC CYBER 170M computer system model 875; CDC CYBER 70 computer systems models 71, 72, 73, and 74; and 6000 computer systems.

Organization

This manual is organized into seven sections and nine appendixes. Section 1 introduces CIP, noting its advantages and implications. Since many CIP features are model dependent, sections 2 through 4 provide model-dependent procedures and displays. These sections include procedures for installing CIP and for performing an operating system deadstart, and describe the various deadstart displays and the options offered.

Sections 5 and 6 provide procedural summaries and overviews that are applicable to several models of computers. Section 5 provides deadstart procedure summaries, coldstart procedures, and deadstart programs. Section 6 provides general procedures that are applicable to most or all of the computer systems.

Section 7 provides reference information for the monitor display driver (MDD).

The appendixes include a glossary of terms, a directory of error messages, a directory of HIVS tests, and CIP installation and maintenance information oriented toward the customer engineer (CE).

Audience

This manual is directed to CEs, operators, and site analysts responsible for installing and maintaining CIP on any of the previously mentioned Control Data computer system.

Conventions

This manual includes many procedures you work through at the system operator console. In describing the entries you make at your console keyboard, one of the phrases used is "press the carriage return key" to describe how to terminate an entry. The specific key you press to terminate an entry varies depending on the type of operator console you are using; CC545, CC634B, CC598A, or CC598B.

Applying power to the CC598A or CC598B system console or simultaneously pressing the Ctrl, Alt, and Del keys on the CC598A or CC598B is referred to as console initialization. Simultaneously pressing the Ctrl and F2 keys on a CC598A or CC598B console will bring up a CONSOLE MAIN MENU.

The method of initiating a deadstart is not only dependent upon the type of computer system, but it is also dependent upon the type of operator console used to perform the deadstart. To deadstart an I2n Class¹ system using the CC545, you simply press the DEADSTART button on the console. However, when using a CC545 to deadstart an I1n¹ or an I4n Class¹ system, pressing the DEADSTART button will only bring up the initial deadstart display on the console screen. In the latter case, a deadstart will only be executed after a deadstart option has been selected from a CC545 console display.

When deadstarting from a CC634B, you must perform a CTRL-G, CTRL-R sequence to initiate the deadstart process. This sequence is described for specific computer system models elsewhere in this manual. Once again, this procedure does not execute an actual deadstart; it simply brings up the initial deadstart display on the console screen.

Similarly, when deadstarting from a CC598A or CC598B system console, a deadstart is executed only after a deadstart option has been selected from a CC598A/B console display; pressing Ctrl, Alt, and Del simultaneously or pressing Ctrl and F2 simultaneously does not initiate a deadstart. Refer to section 5 for the specifics of deadstarting from a CC598A or CC598B system console.

NOTE

If for any reason, simultaneously pressing Ctrl and F2 does not bring up the CONSOLE MAIN MENU on a CC598A or CC598B system console, press Ctrl, Alt, and Del simultaneously to reinitialize the console (and to display the CONSOLE MAIN MENU). If the Ctrl-Alt-Del sequence has no effect, power down the CC598A/CC598B console, wait five seconds, and then power the unit back up.

New features, as well as technical changes, deletions, and additions in this manual, are indicated by vertical bars in the margin.

Technical changes and additions are indicated by change bars and are correlated with the revision of the page on which they occur. Other changes, such as editorial and pagination, are not identified by change bars but may be included as part of a revision.

1. Refer to Model Classification by IOU Configuration and Upgrade.

Model Classification by IOU Configuration and Upgrade

The categories used in sections 1, 2, 5, and 6 in this manual are based on IOU Models, that is, "I1n Class Systems" refers to the Models 10, 11, 12, 13, and 14 single IOU configurations used in CYBER 180 Models 810/830/815/825 and CYBER 810A/830A computer systems. The "Class Systems" and the equipment to which they apply are listed in the following table. Sections 3 and 4 continue to use CDC computer system model designations.

Class of System	Equipment
I1n Class Systems	CYBER 180 Models 810/830, 815/825 CYBER 810A/830A
I2n Class Systems	CYBER 180 Models 835, 845/855, 840/850/860
I4n Class Systems	CYBER 180 Models 840A/850A/860A/870A CYBER 960
I4n Upgrade Class Systems	CYBER 180 Models 845/855, 840/850/860
I4n CYBER 990 Systems	CYBER 180 Models 990 CYBER 990E/995E/994
I4Cn Class Systems	CYBER 962, 992

NOTE

I4n and I4Cn Class systems are two separate entities. Therefore, if a certain procedure within this manual is titled as a procedure for an I4n Class system, it does not pertain to I4Cn Class systems (and vice-versa).

Related Publications

Procedures and descriptions within this manual may refer you to information in the following related Control Data publications.

Control Data Publication	Publication Number
NOS Version 2 Administration Handbook	60459840
NOS Version 2 Analysis Handbook	60459300
NOS Version 2 Installation Handbook	60459320
NOS Version 2 Operations Handbook	60459310
NOS/BE Installation Handbook	60494300
NOS/BE Operator's Guide	60493900
NOS/BE System Programmer's Reference Manual, Volume 1	60494100
CYBER 170 Computer Systems Models 815 and 825 Hardware Operator's Guide	60469370
CYBER 170 System Models 835, 845, and 855 Hardware Operator's Guide	60458390
CYBER 180 Computer Systems Models 810 and 830 Hardware Operator's Guide	60469440
MSL 140 Off-Line Maintenance Software Library Reference Manual	60459860
MSL 15X Off-Line Maintenance Software Library Reference Manual	60456530
MSL 153/155, CYBER 96X Maintenance Software Reference Manual Test Descriptions	60461920
MSL 153/155, CYBER 96X Maintenance Software Reference Manual Test Procedures	60461110
19003 System Console (CC598-A/B) Operations and Maintenance Guide	60463610
721-21/31 Owner's Manual	62950101
NOS/VE Operations Manual	60463914
NOS/VE Installation and Upgrade Manual	60463913
CYBER Systems Peripheral Diagnostics Reference Manual	60000144

Ordering Manuals

You can order printed manuals from:

Control Data
Literature and Distribution Services
308 North Dale Street
St. Paul, Minnesota 55103-2495

Submitting Comments

Address comments concerning this manual to:

Control Data
Technical Publications Division
4201 North Lexington Avenue
St. Paul, Minnesota 55126-6198

Disclaimer

This product is intended for use only as described in this document. Control Data cannot be responsible for the proper functioning of undescribed features or parameters.

The CYBER Initialization Package (CIP) provides a simple process for distributing and/or installing the following hardware/software interface modules.

- Common Test and Initialization (CTI)
- Environment Interface (EI)
- Express Deadstart Dump (EDD)
- Hardware Initialization and Verification Software (HIVS)/Maintenance Software Library (MSL)
- Microcode
- Monitor Display Driver (MDD)
- System Console Driver (SCD)
- Dedicated Fault Tolerance (DFT)
- NOS/VE Boot Environment Programs
- System Console Interface (SCI)

CIP module combinations for individual computer systems follow:

- CIP contains CTI, EI, MDD, microcode, MSL, DFT, SCD, and SCI for:
 - CYBER 810A/830A, 960, 962, 990E/995E, 992, 994
 - CYBER 180 Models 810/830, 814/825, 835, 845/855, 840/850/860, 840A/850A/860A/870A, 990

NOTE

In this manual, these CYBER computer systems are categorized by IOU configuration and upgrade status. See Model Classification by IOU Configuration and Upgrade in About This Manual.

- CIP contains CTI and MSL for CYBER 170 models 865 and 875.
- CIP contains CTI and HIVS for CYBER 170 models 170 and 700; CYBER 70 models 71, 72, 73, and 74; and 6000 computer systems.

CIP Features

Installation can be performed either in initialize or update mode. Initialize mode initializes the CIP device and installs CIP, preserving no other information. Update mode installs CIP to the CIP device and preserves operating system information on the disk, including permanent files.

NOTE

The options used to install CIP modules individually are provided for emergency CIP repair only.

CIP Release and Distribution

CIP is released when a change (either a new feature or a correction) is made to one of the CIP modules. A CIP release is planned to occur when a software release to each CDC operating system (NOS, NOS/BE, NOS/VE) is scheduled to occur. A critical problem that must be fixed between planned releases will cause a CIP Batch Corrective Update (BCU) release.

CIP is released on SCOPE Internal (SI) format magnetic tape [recorded in phase-encoded (PE) mode] and is distributed with the operating system to model 800 computer system sites.

The customer informs you that CIP has been received and you recommend installation of the CIP, based on the Field Change Announcement (FCA) data distributed with the release. If the CIP is to be installed, the installation should be a joint effort between the customer and the CE. The actual installation requires approximately 10 to 20 minutes of dedicated machine time.

Disk Space Requirements

CIP must be installed to disk (the CIP device). When CIP is installed, disk space is reserved automatically for MSL, which provides the off-line diagnostics. Disk residence of MSL in the production environment facilitates hardware preventive maintenance and reduces problem reaction time. Table 1-1 shows disk space requirements for CYBER mainframes. The CIP device for I4Cn Class systems is a CDC® Wren hard disk located within the CC598A console.

Table 1-1. Disk Space Requirements for CYBER Mainframes

Disk	Models 810-830		Others
	Full	Short	
844-21	28.0%	17.3%	28.0%
844-4X	14.0%	8.6%	14.0%
885	4.8%	3.1%	4.8%
895	N/A	N/A	8.2%
834	20.0%	12.1%	N/A
836	6.7%	4.1%	N/A

Tailored CIP

The CIP tape is tailored for each model 800 computer system. For example, an 835 CIP contains microcode and an MSL unique to the CYBER 170 or CYBER 180 model 835.

CIP Device Access by the Host

When running NOS/VE in dual state, the CIP device must be accessible by the host operating system (NOS or NOS/BE). It cannot be on an exclusive NOS/VE channel because the CIP device is accessed through the host system in dual state.

NOTE

Sites may use a NOS or NOS/BE deadstart tape containing CTI as the operating system load file. However, the CTI on the deadstart tape cannot be used to initialize the mainframe; no operating system tape deadstart capability is provided.

Sites Without a Maintenance Contract

CYBER computer systems installed at sites without a maintenance contract will receive a CIP tape containing HIVS instead of MSL (HIVS is a subset of MSL) upon receipt of the computer system. To order a new CIP after that, the marketing representative must send LDS Data Form #AA5570 to Software Manufacturing and Distribution, ARH 230, 4201 N. Lexington, Arden Hills, MN, specifying the mainframe type.

Considerations for Sites with Non-Model 800 Computer Systems

The CIP tape replaces the HIVS tape. CIP content and function are the same as HIVS in that the CIP tape:

- Contains CTI and HIVS modules.
- Is distributed with an operating system order (not as an FCO).
- Provides hardware verification sequencer and deadstart utilities.
- Provides disk deadstart capability if installed to disk.

NOTE

Disk residence of CIP is not a requirement.

To order CIP, the CDC marketing representative must send LDS Data Form #AA5570 to Software Manufacturing and Development, ARH 230, 4201 N. Lexington, Arden Hills, MN, specifying the mainframe type.

CIP Procedures, Displays, and Options for I1n, I2n, I4n, and I4Cn Class Systems 2

CIP Installation, I1n and All Single IOU I4n Class Systems	2-3
NOS/VE Boot Program Installation	2-7
CIP Installation, Dual IOU I4n Class Systems	2-8
NOS/VE Boot Program Installation	2-8.2
CIP Installation, I4Cn Class Systems	2-8.3
NOS/VE Boot Program Installation, I4Cn Class systems	2-9
CIP Installation, I2n Class Systems	2-10
NOS/VE Boot Program Installation	2-12
OS Deadstart, I1n, I2n, I4Cn, and All I4n Class Systems	2-13
Disk Deadstart	2-13
Operating System File on Disk for I1n, I4n, I4n Upgrade, and I4n 990 Class Systems	2-13
Operating System File on CIP Device, I4Cn Class Systems	2-14
Operating System File on Tape or Alternate Disk for I1n, I4n, I4n Upgrade, I4n 990, and I4Cn Class Systems	2-15
Operating System File on Tape or Alternate Disk I2n Class Systems	2-16
Deadstart From Disk Displays, I1n, I2n, I4Cn, and All I4n Class Systems	2-17
Overview	2-17
Initial Options Display	2-25
Operator Intervention Display	2-29
Utilities Display	2-44
CIP Tape Deadstart Displays, I1n, I2n, and All I4n Class Systems	2-53
Overview	2-53
Initial Options Display	2-61
Build Deadstart Disk Display	2-63
Manual Operations Display	2-65
Utilities Display	2-66
CIP Tape-Related Deadstart Displays, I4Cn Class Systems	2-74
Overview	2-74
Maintenance Options Display	2-79

CIP Procedures, Displays, and Options for I1n, I2n, I4n, and I4Cn Class Systems 2

This section includes CIP automatic installation procedures, operating system procedures, and descriptions of CIP displays and options available to users of the following CDC® computer systems. The categories used in this section are based on IOU models, that is, "I1n Class Systems" refers to the Models 10, 11, 12, 13, and 14 single IOU configurations used in CYBER 180 Models 810/830, 815/825, and CYBER 810A/830A computer systems. The "Class Systems" and equipment to which they apply are listed in the following table.

Class of System	Equipment
I1n Class Systems	CYBER 180 Models 810/830, 815/825 CYBER 810A/830A
I2n Class Systems	CYBER 180 Models 835, 845/855, 840/850/860
I4n Class Systems	CYBER 180 Models 840A/850A/860A/870A CYBER 960
I4n Upgrade Class Systems	CYBER 180 Models 845/855, 840/850/860
I4n CYBER 990 Systems	CYBER 180 Models 990 CYBER 990E/995E/994
I4Cn Class Systems	CYBER 962, 992

NOTE

I4n and I4Cn Class systems are two separate entities. Therefore, if a certain procedure within this manual is titled as a procedure for an I4n Class system, it does not pertain to I4Cn Class systems (and vice-versa).

CAUTION

For CYBER 170/180 systems using a NOS/VE version previous to 1.2.1, CIP should not be installed on a NOS/VE device. NOS/VE does not recognize CIP as a read-only disk area and will write over it.

NOTE

If the tape does not move or if it fails to rewind after moving forward, refer to the 698 CYBER Magnetic Tape Subsystem (CMTS) Users Guide, publication number 60000009, section 5, Troubleshooting.

Beginning with the CIP V10 L716 release, VE boot programs will no longer reside on the CIP tape, but rather, they will reside on a separate NOS/VE tape which is referred to as the NOS/VE deadstart tape. This feature eliminates the need to re-release CIP each time NOS/VE is released. It also eliminates the need for a customer to build special CIP tapes when updating the level of CIP, but when retaining the current level of NOS/VE.

CIP Installation, I1n and All Single IOU I4n Class Systems

The CIP modules must be installed to the CIP device for I1n and all I4n Class systems. Select a disk unit in your configuration to be the CIP device. The installation process installs the CIP modules to the CIP device so that operating system information can also reside on the disk.

NOTE

The CIP device *must not* be shared by any other mainframe.

Complete the following procedure to install CIP onto the CIP device or to update CIP on the CIP device. The installation procedure requires dedicated machine time. At least one tape drive and one disk unit must be available. The procedure assumes that controlware has been loaded into the peripheral controller(s). If the controlware is not loaded, refer to section 5 of this handbook for coldstart instructions.

- ___ 1. Mount the CIP tape on a tape drive.
- ___ 2. Perform the following steps to bring up the DEADSTART OPTIONS display¹ or the CONSOLE MAIN MENU display.
 - If a CC545 is the primary console:
 - ___ a. Press the DEADSTART button. The DEADSTART OPTIONS display will appear.
 - If a CC634B is the primary console:
 - ___ a. Press the RESET button to reinitialize the console.
 - ___ b. Hold down the CTRL key while pressing the G key.
 - ___ c. When the message *OPERATOR ACCESS ENABLED* appears on the screen, hold down the CTRL key while pressing the R key. The DEADSTART OPTIONS display will appear.
 - If a CC598B is the primary console and if the console is already initialized, but the CONSOLE MAIN MENU is not currently being displayed:
 - ___ a. Simultaneously press the CTRL and F2 keys. The CONSOLE MAIN MENU will appear.
 - If a CC598B is the primary console and if the console is not initialized:
 - ___ a. Simultaneously press the CTRL, ALT, and DEL keys. The CDC logo will appear. Approximately ten seconds thereafter, the CONSOLE MAIN MENU will appear.
- ___ 3. Enter an S to select the SYSTEM LOAD option if the deadstart program selected is for deadstart from CIP tape.
 - If the deadstart program selected is not for deadstart from CIP tape, perform the following steps.
 - ___ a. Enter an M to select the MAINTENANCE OPTIONS display.

1. For models 815/825, the MAINTENANCE OPTION display will appear.

- ___ b. Enter or retrieve the deadstart program from CIP tape program as described under Warmstart Procedure Summary for I1n and All I4n Class Systems in section 5.
 - ___ c. Enter an S to select the short deadstart sequence. The INITIAL OPTIONS display appears.
- ___ 4. Press the carriage return key to select the default option. The BUILD DEADSTART DISK display appears.

NOTE

For the CYBER mainframe sites without a maintenance contract, enter an I (I4n Class system option), INITIAL INSTALLATION option to initialize the disk and install CTI and HIVS. Although the CIP tape for such sites contains no off-line maintenance diagnostics, it must be installed to the deadstart disk.

CAUTION

Do not proceed until you have read all the instructions for step 5.

- ___ 5. For first time installation of CIP, perform one of the following steps.
- ___ a. For first time installation of the CIP for single I4n, I4n Upgrade, and I4n 990 Class systems, enter I, INITIAL INSTALLATION option.
 - ___ b. For first time installation of CIP for I1n Class systems, enter either S to select the SHORT INSTALLATION option, or enter F to select the FULL INSTALLATION option, based on the following information.

WARNING

The INITIAL INSTALLATION, SHORT INSTALLATION, and FULL INSTALLATION options destroy all information on the deadstart disk, except for the disk microcode, prior to installing CIP. Before executing either the short or full option, be sure you have a backup copy of any information on the deadstart disk that you want to preserve, including operating system permanent files and CE command buffers.

After executing the initial, short, or full option, you must perform an operating system initialization of the disk.

- S The SHORT INSTALLATION option initializes the deadstart disk and installs most of CIP. The CIP tape contains off-line maintenance diagnostics that you use to execute mainframe tests for preventive maintenance or to diagnose a hardware error. The SHORT INSTALLATION option installs a predefined set of diagnostics (diagnostics you use frequently). Those used infrequently can be loaded and executed from the CIP tape when needed. The SHORT INSTALLATION option reserves 15 megabytes of disk storage for the CIP.
- F The FULL INSTALLATION option initializes the deadstart disk and installs all of CIP. The FULL INSTALLATION option reserves 25 megabytes of disk storage for CIP.

- ___ 6. For reinstallation of CIP for all CYBER systems some time after the initial installation, enter U to select the UPDATE option.

U The UPDATE option replaces CIP on the deadstart disk and preserves operating system information on the deadstart disk, including permanent files. The UPDATE option replaces CIP in the same mode, short or full, that was used when the deadstart disk was initialized.

The CIP modules replaced during an update are:

CTI (Common Test and Initialization)
 EDD (Express Deadstart Dump)
 EI (Environmental Interface)
 MSL (Maintenance Software Library) (includes command buffers)
 Microcode (Peripheral and Mainframe)
 MDD (Monitor Display Driver)
 SCD (System Console Driver)
 DFT (Dedicated Fault Tolerance)
 SCI (System Console Interface)²

Information saved during an update includes:

DEL (Deadstart Error Log)
 DPB (Default Parameter Block)
 Operating system pointers and permanent files
 NOS/VE system file pointers
 MRT (Mainframe Reconfiguration Table)
 CFT (Central Memory Flaw Table)

- ___ 7. Enter the channel, equipment, and unit numbers of the deadstart disk when prompted. Follow each entry by pressing the carriage return key. Press only the carriage return key without entering any values to select the displayed default value.

With respect to entry of the unit numbers for 834/836 disk drives, the default value 00 is interpreted as cu, where c = control module number, and u = unit number. Press the carriage return key to accept control module 0, unit 0, or enter alternate values, then press the carriage return key.

For 844 drives, unit number must be in the range 00 through 07. Press the carriage return key to accept unit 00, or enter an alternate unit number, then press the carriage return key.

For 885 drives, unit number must be in the range 40 through 57. Enter a valid unit number, then press the carriage return key.

For 895 disk drives, 00 is interpreted as su, where s = storage director number, and u = unit number. Press the carriage return key to accept storage director 0, unit 0, or enter alternate values, then press the carriage return key.

- ___ 8. CIP installation is complete when the message INSTALLATION COMPLETE appears.

² This module is replaced only if the NOS/VE boot programs are not installed in the system.

NOTE

Effective with CIP V10 Level 716, installation of CIP components for NOS/VE systems is a process which requires two tapes. Hardware related components must be read from the CIP tape, while current release NOS/VE boot programs must be read from the NOS/VE deadstart tape.

NOS/VE Boot Program Installation

NOS/VE boot program installation must be performed during a deadstart from disk; use the following procedures.

- ___ 1. Mount the tape containing the NOS/VE boot programs that are at the same PSR level as the NOS/VE system to be supported. This tape is either a NOS/VE deadstart tape (NOS/VE 1.4.1 or later), or a CIP tape released prior to the V10 L716 CIP tape.
- ___ 2. Warmstart the disk unit on which the NOS/VE boot programs are to be installed (refer to section 5).
- ___ 3. From the DEADSTART OPTIONS display or from the CONSOLE MAIN MENU display, enter an S for the INITIAL OPTIONS display.
- ___ 4. From the INITIAL OPTIONS display, enter a U for the UTILITIES display.
- ___ 5. From the UTILITIES display, select the V option, INSTALL NOS/VE BOOT PROGRAMS.
- ___ 6. CTI prompts for the tape equipment, channel, and unit number of the tape drive used for reading NOS/VE boot programs. CTI dynamically determines if it is reading a CIP tape or a NOS/VE deadstart tape, and installs the NOS/VE boot programs from the tape to the group two area of the Common Disk Area (CDA). If CTI cannot identify the tape as either a CIP tape or a NOS/VE deadstart tape, it will display the following message:

TAPE ON UNIT nn NOT RECOGNIZED

ENTER (CR) TO CONTINUE

If you press the carriage return key (CR) at this point, CTI will allow you to mount the correct tape and/or specify the correct path.

CTI automatically installs the NOS/VE boot programs to the appropriate section of the Common Disk Area (CDA) and then sets the "NOS/VE Boot Programs Installed" flag in the deadstart sector of the CIP device. After a successful install, the UTILITIES display will reappear.

You can then perform an operating system load, off-line maintenance, default deadstart device definition, or other deadstart utility operations. Refer to section 6.

CIP Installation, Dual IOU I4n Class Systems

- ___ 1. Mount the CIP tape on a tape drive.
- ___ 2. In a DUAL IOU environment with an I4n IOU as the primary IOU, use the CC598B as the primary console, and complete the following steps to bring up the CONSOLE MAIN MENU.

If the console has been initialized, but the CONSOLE MAIN MENU is not currently being displayed:

- ___ a. Press the CTRL and F2 keys simultaneously. The CONSOLE MAIN MENU will appear.

If the console has not been initialized:

- ___ a. Press the CTRL, ALT, and DEL keys simultaneously to reinitialize the console. The CDC logo will appear. Approximately ten seconds thereafter, the CONSOLE MAIN MENU will appear.

- ___ 3. Enter S or press the Enter/Return key to select the SYSTEM LOAD option if the deadstart program selected is for deadstart from CIP tape. After selecting the SYSTEM LOAD option, a warning display will appear. Press the Enter/Return key to continue.

Otherwise, if the deadstart program is not for deadstart from CIP tape, perform the following steps.

- ___ a. Enter M to select the MAINTENANCE OPTIONS display.
- ___ b. Press 0 to select MAINTENANCE OPTIONS - IOU-0 and then enter or retrieve the deadstart program from CIP tape as described under Warmstart Procedure Summary for All I4n Class Systems in section 5.
- ___ c. Enter S to select the short deadstart sequence.

- ___ 4. Press the Enter/Return key to select the default option. The BUILD DEADSTART DISK display appears.

CAUTION

Do not proceed until you have read all the instructions for step 5.

- ___ 5. For first time installation of CIP, enter I, INITIAL INSTALLATION option.

WARNING

The INITIAL INSTALLATION option destroys all information on the deadstart disk, except for the disk microcode, prior to installing CIP. Before executing this option be sure you have a backup copy of any information on the deadstart disk that you wish to preserve, including operating system permanent files and CE command buffers.

- ___ 6. For reinstallation of CIP, enter U to select the UPDATE option.

The UPDATE option replaces CIP on the deadstart disk and preserves operating system information on the deadstart disk, including permanent files. The UPDATE option replaces CIP in the same mode that was used when the deadstart disk was initialized.

The CIP modules replaced during an update are:

- CTI (Common Test and Initialization)
- EDD (Express Deadstart Dump)
- EI (Environmental Interface)
- MSL (Maintenance Software Library) (includes command buffers)
- Microcode (Peripheral and Mainframe)
- MDD (Monitor Display Driver)
- SCD (System Console Driver)
- DFT (Dedicated Fault Tolerance)
- SCI (System Console Interface)³

Information saved during an update includes:

- DEL (Deadstart Error Log)
- DPB (Default Parameter Block)
- Operating system pointers and system files
- NOS/VE system file pointers
- MRT (Mainframe Reconfiguration Table)
- CFT (Central Memory Flaw Table)

- ___ 7. Enter the channel, equipment, and unit number of the deadstart disk when prompted. Follow each entry with a carriage return (CR). Press only the carriage return key (CR) to select the displayed default value.

With respect to entry of the unit numbers for 834/836 disk drives, the default value 00 is interpreted as cu, where c = control module number, and u = unit number. Press the carriage return key to accept control module 0, unit 0, or enter alternate values, then press the carriage return key.

For 844 drives, unit number must be in the range 00 through 07. Press the carriage return key to accept unit 00, or enter an alternate unit number, then press the carriage return key.

For 885 drives, unit number must be in the range 40 through 57. Enter a valid unit number, then press the carriage return key.

For 895 disk drives, 00 is interpreted as su, where s = storage director number, and u = unit number. Press the carriage return key to accept storage director 0, unit 0, or enter alternate values, then press the carriage return key.

- ___ 8. CIP installation is complete when the message INSTALLATION COMPLETE appears.

NOTE

Effective with CIP V10 Level 716, installation of CIP components for NOS/VE systems is a process which requires two tapes. Hardware related components must be read from the CIP tape, while current release NOS/VE boot programs must be read from the NOS/VE deadstart tape.

3. This module is replaced only if the NOS/VE boot programs are not installed in the system.

NOS/VE Boot Program Installation

NOS/VE boot program installation must be performed during a deadstart from disk; use the following procedures.

- 1. Mount the tape containing the NOS/VE boot programs that are at the same PSR level as the NOS/VE system to be supported. This tape is either a NOS/VE deadstart tape (NOS/VE 1.4.1 or later), or a CIP tape released prior to the V10 L716 CIP tape.
- 2. Warmstart the disk unit on which the NOS/VE boot programs are to be installed (refer to section 5).
- 3. From the CONSOLE MAIN MENU display, enter an S for the INITIAL OPTIONS display.
- 4. From the INITIAL OPTIONS display, enter a U for the UTILITIES display.
- 5. From the UTILITIES display, select the V option, INSTALL NOS/VE BOOT PROGRAMS.
- 6. CTI prompts for the tape equipment, channel, and unit number of the tape drive used for reading NOS/VE boot programs. CTI dynamically determines if it is reading a CIP tape or a NOS/VE deadstart tape, and installs the NOS/VE boot programs from the tape to the group two area of the Common Disk Area (CDA). If CTI cannot identify the tape as either a CIP tape or a NOS/VE deadstart tape, it will display the following message:

TAPE ON UNIT nn NOT RECOGNIZED

ENTER (CR) TO CONTINUE

If you press the carriage return key (CR) at this point, CTI will allow you to mount the correct tape and/or specify the correct path.

CTI automatically installs the NOS/VE boot programs to the appropriate section of the Common Disk Area (CDA) and then sets the "NOS/VE Boot Programs Installed" flag in the deadstart sector of the CIP device. After a successful install, the UTILITIES display will reappear.

You can then perform an operating system load, off-line maintenance, default deadstart device definition, or other deadstart utility operations. Refer to section 6.

CIP Installation, I4Cn Class Systems

CIP modules must be installed onto the CIP device of I4Cn Class systems via the Install-Update CIP (IUC) system console utility. Install or update CIP components to the CIP device by utilizing the following procedures.

NOTE

Prior to shipment of a new I4Cn Class system, at the factory CIP is installed onto the internal hard drive of the CC598A console (the I4Cn CIP device). Therefore, you do not need to perform an initial installation of CIP from tape. However, if reinstallation of CIP is necessary, the CIP tape drive and the I4Cn CIP device must both operate on Cluster 0 of the IOU.

- ___ 1. Mount the CIP tape on a tape drive.
- ___ 2. Perform the following steps to bring up the CONSOLE MAIN MENU.
If the CC598A console is already initialized, but the CONSOLE MAIN MENU is not currently being displayed:
 - ___ a. Simultaneously press the Ctrl and F2 keys. The CONSOLE MAIN MENU will appear.
 If a CC598A console is not initialized:
 - ___ a. Simultaneously press the Ctrl, Alt, and Del keys. The CDC logo will appear. Approximately ten seconds thereafter, the CONSOLE MAIN MENU will appear.
- ___ 3. Enter M, followed by the Enter/Return key. The MAINTENANCE OPTIONS display appears.
- ___ 4. Enter I to select the INSTALL/UPDATE CIP option; the following will appear:

INSTALL/UPDATE CIP

CIP Partition n is currently selected.

The option to install/update CIP has been selected.
This utility requires dedicated access to the mainframe.

Current system activity will be terminated by proceeding
with this option.

Enter: LOAD UTILITY
Esc: RETURN TO MAINTENANCE OPTIONS DISPLAY.

The line CIP Partition n is currently selected indicates which partition of the CIP device is currently being accessed, where allowable values for n are 1, 2, or 3. If the CIP partition must be changed, press the ESC key to bring up the MAINTENANCE OPTIONS menu, then select S to bring up the SELECT CIP PARTITION display. From the SELECT CIP PARTITION display, change the CIP partition by entering 1, 2, or 3 to select partition 1, partition 2, or partition 3, respectively. Press ESC to return to the MAINTENANCE OPTIONS menu and repeat step 4.

NOTE

Once a CIP partition is selected, that selection will be maintained until explicitly changed or until the TPM board is removed (after the CC598A has been powered down).

If the desired CIP partition is selected, press the Enter/Return key; the TAPE SYSTEM INFORMATION message will appear:

TAPE SYSTEM INFORMATION
(01=ATS, 02=IPI)

If your tape system type differs from the default value as shown in the initial display, enter the proper tape type. The following line is then added:

CHANNEL 04

If the channel displayed is not the correct channel, enter the proper tape channel (4-6). The tape equipment default number will then appear:

EQUIPMENT 00

Enter the proper tape equipment number, if different from the default value. The TAPE UNIT default number will then appear.

UNIT 00

Enter the proper tape number, if different from the default value.

If your tape subsystem is an IPI system, the following line is then added:

PORT(0=A, 1=B) 00

If the port displayed is not correct, enter the proper port (0 or 1).

When all proper values are successfully entered, IUC then proceeds to the CIP INSTALLATION display. Go to step 5.

If an illegal parameter is entered in response to either the CHANNEL, EQUIPMENT, or TAPE UNIT prompt, IUC displays the message:

ILLEGAL ENTRY

Depressing the space bar will then allow the parameter to be re-entered.

After tape parameters are entered, IUC attempts to connect to the tape drive. If connection to the unit is unsuccessful, IUC displays the message:

TAPE UNIT NOT CONNECTED

Entry of a space bar prompts IUC to re-attempt the connection to the tape drive.

After all device parameters have been successfully entered, the CIP INSTALLATION display will appear.

- 5. For first time installation of CIP, select option I, INITIAL INSTALLATION. The INITIAL INSTALLATION option installs the entire contents of the CIP tape onto the CIP device.

WARNING

The INITIAL INSTALLATION option destroys the contents of all four CIP directories on the CIP device.

- ___ 6. For an update installation of CIP, select option U, UPDATE INSTALLATION. The UPDATE INSTALLATION option installs the entire contents of the CIP tape onto the CIP device, excluding programs in the CDA directory which must be carried over when performing an update operation.

WARNING

The UPDATE INSTALLATION option destroys the contents of the CTI, MSL, and CB directories on the CIP device; partial contents of the CDA directory are preserved.

- ___ 7. If you wish to manually alter the contents of any of the four CIP device directories, select option M, MANUAL INSTALLATION.

The MANUAL INSTALLATION option permits any of the following:

- Replacement of the MSL directory contents.
- Replacement of the CTI directory contents.
- Replacement of the CB directory contents.
- Addition or replacement of programs in the CDA directory.
- Addition or replacement of programs in the MSL directory.
- Addition or replacement of programs in the CB directory.
- Manual addition or replacement of programs in the CDA directory.
- Manual installation of VE boot programs in the CDA directory.
- Copying of MSL programs to tape.
- Copying of command buffers to tape.



NOS/VE Boot Program Installation, I4Cn Class systems

NOS/VE boot program installation must be performed using the following procedures.

- ___ 1. Mount the tape containing the NOS/VE boot programs that are at the same PSR level as the NOS/VE system to be supported. This tape is either a NOS/VE deadstart tape (NOS/VE 1.4.1 or later), or a CIP tape released prior to the V10 L716 CIP tape.
- ___ 2. Ensure that the correct CIP partition is selected.
- ___ 3. Perform the following steps on the CC598A system console to bring up the CONSOLE MAIN MENU display.
If the console is already initialized, but the CONSOLE MAIN MENU is not currently being displayed:
 - ___ a. Simultaneously press the Ctrl and F2 keys. The CONSOLE MAIN MENU will appear.
 If the console is not initialized:
 - ___ a. Simultaneously press the Ctrl, Alt, and Del keys. The CDC logo will appear. Approximately ten seconds thereafter, the CONSOLE MAIN MENU will appear.
- ___ 4. From the CONSOLE MAIN MENU select M, MAINTENANCE OPTIONS.
- ___ 5. From the MAINTENANCE OPTIONS menu select I, INSTALL/UPDATE CIP.
- ___ 6. From the INSTALL/UPDATE CIP message, press the Enter/Return key to load the INSTALL/UPDATE CIP (IUC) utility and then reply to the TAPE SYSTEM INFORMATION queries, which will follow.
- ___ 7. From the INSTALL/UPDATE CIP menu select M, MANUAL INSTALLATION.
- ___ 8. From the MANUAL INSTALLATION menu select D, REPLACE COMMON DISK AREA.
- ___ 9. From the REPLACE COMMON DISK AREA menu select G, OS BOOTS; the following message is displayed:

```

      ENTER THE TAPE TYPE CONTAINING THE BOOTS
      O - O.S. DEADSTART TAPE
      C - CIP TAPE
      
```
- ___ 10. Enter the correct character (O or C) for the tape which you are using.
The install-update CIP (IUC) system console utility installs the NOS/VE boot programs onto the CIP device: during the file transfer, names of the programs being installed are displayed. Upon completion of the NOS/VE boot program installation, the REPLACE COMMON DISK AREA menu is once again displayed. At this point, you may simultaneously press the Ctrl and F2 keys to bring up the CONSOLE MAIN MENU.

CIP Installation, I2n Class Systems

The CIP modules must be installed to disk for I2n Class systems. Select a disk unit in your configuration to be the deadstart disk. The installation process installs the CIP modules to the deadstart disk so that operating system information may also reside on the disk.

Install CIP to the deadstart disk or update CIP on the deadstart disk using the following procedure. The installation procedure requires dedicated machine time. At least one tape drive and one disk unit must be available. The procedure assumes that controlware has been loaded into the peripheral controller(s). If the controlware is not loaded, refer to section 5 for coldstart instructions.

- ___ 1. Mount the CIP tape on a tape drive.
- ___ 2. Set the deadstart program for a deadstart from the CIP tape. Refer to section 5.
- ___ 3. Press the DEADSTART button (NOS or NOS/BE with a CC545 terminal). The BUILD DEADSTART DISK display appears.

NOTE

Deadstart from a CC634B terminal (required for NOS/VE standalone) is not normally supported for I2n Class systems.

Under certain conditions, users with both CC545 and CC634B consoles can initiate a deadstart by pressing the DEADSTART button on the CC545 or using the switch on the deadstart panel and have the displays appear on the CC634B console. For NOS/VE standalone, a CC634B terminal with option GK427A installed is required. This installs a DEADSTART button on the CC634B terminal. For details, refer to Deadstart Procedure Summaries and Setting Word 12 in section 5.

- ___ 4. Press the carriage return key to select the default option, BUILD DEADSTART DISK. The BUILD DEADSTART DISK display appears.

CAUTION

D^o not proceed until you have read all the instructions for step 5.

- ___ 5. For first time installation of CIP tape select I, INITIAL INSTALLATION option, which initializes the deadstart disk and installs CIP. The INITIAL INSTALLATION option reserves 25 megabytes of disk storage for CIP.

WARNING

The INITIAL INSTALLATION option destroys all information on the deadstart disk, except the disk microcode, prior to installing CIP. Before executing the INITIAL INSTALLATION option, be sure you have a backup copy of any information on the deadstart disk that you want to preserve, including operating system permanent files and CE command buffers.

After executing the INITIAL INSTALLATION option, you must perform an operating system initialization of the disk.

For installation of CIP some time after the initial installation, enter U to select the UPDATE option. The UPDATE option replaces CIP on the deadstart disk and preserves operating system information on the deadstart disk, including permanent files.

The CIP modules replaced during an Update are:

- CTI (Common Test and Initialization)
- EDD (Express Deadstart Dump)
- EI (Environmental Interface)
- MSL (Maintenance Software Library) (includes command buffers)
- Microcode (Peripheral and Mainframe)
- MDD (Monitor Display Driver)
- SCD System Console Driver)
- DFT (Dedicated Fault Tolerance)
- SCI (System Console Interface)⁴

Information saved during an update includes:

- DEL (Deadstart Error Log)
- DPB (Default Parameter Block)
- Operating system pointers and permanent files
- NOS/VE system file pointers
- MRT (Mainframe Reconfiguration Table)
- CFT (Central Memory Flaw Table)

- 6. Enter the channel, equipment, and unit numbers of the deadstart disk when prompted. Follow each by pressing the carriage return key. Press only the carriage return key to select the displayed default value.

With respect to entry of the unit numbers for 834/836 disk drives, the default value 00 is interpreted as cu, where c = control module number, and u = unit number. Press the carriage return key to accept control module 0, unit 0, or enter alternate values, then press the carriage return key.

For 844 drives, unit number must be in the range 00 through 07. Press the carriage return key to accept unit 00, or enter an alternate unit number, then press the carriage return key.

For 885 drives, unit number must be in the range 40 through 57. Enter a valid unit number, then press the carriage return key.

For 895 disk drives, 00 is interpreted as su, where s = storage director number, and u = unit number. Press the carriage return key to accept storage director 0, unit 0, or enter alternate values, then press the carriage return key.

- 7. CIP installation is complete when the message INSTALLATION COMPLETE appears.

WARNING

Effective with CIP V10 Level 716, installation of CIP components for NOS/VE systems is a process which requires two tapes. Hardware related components must be read from the CIP tape, while current release NOS/VE boot programs must be read from the NOS/VE deadstart tape.

⁴ This module is replaced only if the NOS/VE boot programs are not installed in the system.

NOS/VE Boot Program Installation

NOS/VE boot program installation must be performed during a deadstart from disk; use the following procedures.

- ___ 1. Mount the tape containing the NOS/VE boot programs that are at the same PSR level as the NOS/VE system to be supported. This tape is either a NOS/VE deadstart tape (NOS/VE 1.4.1 or later), or a CIP tape released prior to the V10 L716 CIP tape.
- ___ 2. Warmstart the disk unit on which the NOS/VE boot programs are to be installed (refer to section 5).
- ___ 3. From the INITIAL OPTIONS display, enter a U for the UTILITIES display.
- ___ 4. From the UTILITIES display, select the V option, INSTALL NOS/VE BOOT PROGRAMS.
- ___ 5. CTI prompts for the tape equipment, channel, and unit number of the tape drive used for reading NOS/VE boot programs. CTI dynamically determines if it is reading a CIP tape or a NOS/VE deadstart tape, and installs the NOS/VE boot programs from the tape to the group two area of the Common Disk Area (CDA). If CTI cannot identify the tape as either a CIP tape or a NOS/VE deadstart tape, it will display the following message:

TAPE ON UNIT nn NOT RECOGNIZED

ENTER (CR) TO CONTINUE

If you press the carriage return key (CR) at this point, CTI will allow you to mount the correct tape and/or specify the correct path.

CTI automatically installs the NOS/VE boot programs to the appropriate section of the Common Disk Area (CDA) and then sets the "NOS/VE Boot Programs Installed" flag in the deadstart sector of the CIP device. After a successful install, the UTILITIES display will reappear.

You can then perform an operating system load, off-line maintenance, default deadstart device definition, or other deadstart utility operations. Refer to section 6.

OS Deadstart, I1n, I2n, I4Cn, and All I4n Class Systems

An operating system deadstart can be performed on I1n, I2n, I4Cn, and all I4n Class systems only when CIP has been installed on disk/CIP device. Operating system load from a tape file is supported for I1n, I2n, and all I4n Class computer systems through the disk deadstart process.

The operating system deadstart procedures require at least one disk unit and, when the operating system file is on tape, one tape unit. The procedures assume that controlware has been loaded into the peripheral controller(s). If the controlware is not loaded, refer to section 5 for coldstart instructions.

Disk Deadstart

This procedure assumes that:

- The deadstart program shown on the DEADSTART OPTION display or on the CONSOLE MAIN MENU display is set for deadstart from disk.
- CIP has been installed to the CIP device. Refer to CIP Installation earlier in this section.

If the operating system file has also been installed to disk, a complete disk deadstart can be performed. Refer to the NOS 2 Analysis Handbook, INSTALL command, to find out how to install the NOS file to disk. The NOS/BE level 0 deadstart process automatically installs the NOS/BE file on disk for use on following deadstarts. For NOS/VE standalone, refer to the NOS/VE Software Release Bulletin (SRB) for procedures to install NOS/VE to disk.

Operating System File on Disk for I1n, I4n, I4n Upgrade, and I4n 990 Class Systems

- ___ 1. Perform the following steps to bring up the DEADSTART OPTIONS display⁵ or the CONSOLE MAIN MENU display.

If a CC545 is the primary console:

- ___ a. Press the DEADSTART button. The DEADSTART OPTIONS display appears.

If a CC634B is the primary console:

- ___ a. Press the RESET button to reinitialize the console.
- ___ b. Hold down the CTRL key while pressing the G key.
- ___ c. When the message *OPERATOR ACCESS ENABLED* appears on the screen, hold down the CTRL key while pressing the R key. The DEADSTART OPTIONS display appears.

5. For models 815/825, the MAINTENANCE OPTIONS display will appear

If a CC598B is the primary console and if the console is already initialized, but the CONSOLE MAIN MENU is not currently being displayed:

- ___ a. Simultaneously press the Ctrl and F2 keys. The CONSOLE MAIN MENU will appear.

If a CC598B is the primary console and if the console is not initialized:

- ___ a. Simultaneously press the Ctrl, Alt, and Del keys. The CDC logo will appear. Approximately ten seconds thereafter, the CONSOLE MAIN MENU will appear.

- ___ 2. Enter S, or press the Enter/Return key. The INITIAL OPTIONS display appears.

NOTE

If a CC598B is the primary console, a warning display will appear in place of the INITIAL OPTIONS display. Press the Enter/Return key while the warning is displayed to proceed to the INITIAL OPTIONS display.

- ___ 3. Press the Enter/Return key to select the default option, AUTOMATIC OS LOAD. This option assumes that the deadstart program is set correctly for deadstart level (0, 1, 2, 3) and for CMRDECK selection (NOS), or for CMR selection (NOS/BE), or for DCFILE selection (NOS/VE).

If the deadstart program is set correctly, operating system deadstart is initiated.

- ___ 4. If the deadstart program is not set correctly for these selections, enter O to select the OPERATOR INTERVENTION option. Operator intervention also allows reconfiguration of mainframe hardware components and execution of the hardware verification sequences. For specific information regarding operator intervention options, refer to displays and options for deadstart from disk later in this section.

Operating System File on CIP Device, I4Cn Class Systems

- ___ 1. Perform the following steps on the CC598A system console to bring up the CONSOLE MAIN MENU display.

If the console is already initialized, but the CONSOLE MAIN MENU is not currently being displayed:

- ___ a. Simultaneously press the Ctrl and F2 keys. The CONSOLE MAIN MENU will appear.

If the console is not initialized:

- ___ a. Simultaneously press the Ctrl, Alt, and Del keys. The CDC logo will appear. Approximately ten seconds thereafter, the CONSOLE MAIN MENU will appear.

- ___ 2. Enter S, or press the Enter/Return key. After selecting the SYSTEM LOAD option, a warning display will appear. Press the Enter/Return key to continue; the INITIAL OPTIONS display will appear.

- ___ 3. Press the Enter/Return key to select the default option, AUTOMATIC OS LOAD. This option assumes that the deadstart program is set correctly for deadstart level (0, 1, 2, 3) and for the DCFILE selection.
If the deadstart program is set correctly, the operating system deadstart is initiated.
- ___ 4. If the deadstart program is not set correctly for these selections, enter O to select the OPERATOR INTERVENTION option. Operator intervention also allows reconfiguration of mainframe hardware components; for specific information regarding operator intervention options, refer to displays and options for deadstart from CC598A system console disk later in this section.

Operating System File on Tape or Alternate Disk for I1n, I4n, I4n Upgrade, I4n 990, and I4Cn Class Systems

- ___ 1. To initiate an operating system deadstart from tape or alternate disk, perform the following steps to bring up the DEADSTART OPTIONS display⁶ or the CONSOLE MAIN MENU display.
If a CC545 is the primary console:
 - ___ a. Press the DEADSTART button. The DEADSTART OPTIONS display appears.
 If a CC634B is the primary console:
 - ___ a. Press the RESET button to reinitialize the console.
 - ___ b. Hold down the CTRL key while pressing the G key.
 - ___ c. When the message *OPERATOR ACCESS ENABLED* appears on the screen, hold down the CTRL key while pressing the R key. The DEADSTART OPTIONS display appears.
 If a CC598A or CC598B is the primary console and if the console is already initialized, but the CONSOLE MAIN MENU is not currently being displayed:
 - ___ a. Simultaneously press the Ctrl and F2 keys. The CONSOLE MAIN MENU will appear.
 If a CC598A or CC598B is the primary console and if the console is not initialized:
 - ___ a. Simultaneously press the Ctrl, Alt, and Del keys. The CDC logo will appear. Approximately ten seconds thereafter, the CONSOLE MAIN MENU will appear.
- ___ 2. Enter S or press the Enter/Return key. The INITIAL OPTIONS display appears.

NOTE

If a CC598B is the primary console, a warning display will appear in place of the INITIAL OPTIONS display. Press the Enter/Return key while the warning is displayed to proceed to the INITIAL OPTIONS display.

6. For models 815/825, the MAINTENANCE OPTIONS display will appear

- ___ 3. Enter O to select the operator intervention option. The OPERATOR INTERVENTION display appears.
- ___ 4. If the deadstart program is not set correctly for deadstart level and for CMRDECK selection (NOS), CMR selection (NOS/BE), or DCFILE selection (NOS/VE), before proceeding, enter P to select the deadstart parameters option. Operator intervention also allows reconfiguration of the mainframe hardware components and execution of hardware verification sequences. For specific information regarding operator intervention options, refer to the displays and options for deadstart from disk, later in this section.
- ___ 5. Enter S to select tape or alternate disk deadstart.
 - a. Tape Deadstart
 - 1) Enter T to deadstart using a tape.
 - 2) Enter tape type, channel, equipment, and unit when prompted.⁷
 - b. Alternate Disk Deadstart
 - 1) Enter D to select alternate disk deadstart.
 - 2) Enter disk channel, equipment, and unit when prompted.⁷
- ___ 6. Press the Enter/Return key. Operating system deadstart is initiated.⁷
- ___ 7. You will see messages showing that NOS or NOS/BE is loading programs and running tests.

Operating System File on Tape or Alternate Disk I2n Class Systems

- ___ 1. Press the DEADSTART button to initiate deadstart. The INITIAL OPTIONS display appears.

NOTE

Deadstart from a CC634B console (required for NOS/VE standalone) is not normally supported for I2n Class systems.

Under certain conditions, users with both CC545 and CC634B consoles can initiate a deadstart by pressing the DEADSTART button on the CC545 or using the switch on the deadstart panel and have the displays appear on the CC634B console. For NOS/VE standalone, a CC634B console with option GK427A installed is required. This installs a DEADSTART button on the CC634B console. For details, refer to deadstart procedure summaries and Setting Word 12 in section 5.

⁷ Applicable for NOS and NOS/BE deadstarts only. For NOS/VE deadstarts, the operating system deadstart sequence is initiated upon selecting the D or T option. (Reference the NOS/VE Operations Manual for more information on NOS/VE Deadstarts.)

- ___ 2. Enter O to select the OS LOAD WITH INTERVENTION option. The OPERATOR INTERVENTION display appears.
- ___ 3. If the deadstart program is not set correctly for deadstart level and for CMRDECK selection (NOS) or CMR selection (NOS/BE), or DCFILE selection (NOS/VE), before proceeding, enter P to select the DEADSTART PANEL PARAMETERS option. Operator intervention also allows reconfiguration of the mainframe hardware components and execution of hardware verification sequences. For specific information regarding operator intervention, refer to the displays and options for deadstart from disk later in this section.
- ___ 4. Enter S to select tape or alternate disk deadstart.
 - a. Tape Deadstart
 - 1) Enter T to deadstart using a tape.
 - 2) Enter tape type, channel, equipment, and unit when prompted.⁸
 - b. Alternate Disk Deadstart
 - 1) Enter D to select alternate disk deadstart.
 - 2) Enter disk channel, equipment, and unit when prompted.⁸
- ___ 5. Press the carriage return key. Operating system deadstart is initiated.⁸
- ___ 6. You will see messages indicating that NOS or NOS/BE is loading programs and running tests.

⁸ Applicable for NOS and NOS/BE deadstarts only. For NOS/VE deadstarts, the operating System deadstart sequence is initiated upon selecting the D or T option. (Reference the NOS/VE Operations Manual for more information on NOS/VE Deadstarts.)

Deadstart From Disk Displays, I1n, I2n, I4Cn, and All I4n Class Systems

The CIP deadstart from disk displays and options included in this section incorporate the following conventions.

- The first option listed on a menu display is the default option. The option can be selected automatically by pressing the carriage return key.
- Pressing the backspace key allows you to return to the previous display.

Additionally, help information is provided for the INITIAL OPTIONS display on I1n, I2n, and all I4n Class systems. The HELP display supplies brief information about the options. More detailed option information is given where the HELP option is described in this section.

Overview

Figures 2-1, 2-2, and 2-3 provide overviews of the displays available during a deadstart from disk on I1n, I2n, all I4n Class systems, respectively. Figures 2-3a, 2-3b, 2-3c, and 2-3d provide an overview of CC598B and CC598A system console displays. The CC598B system console is used on systems with an I4A IOU as the primary IOU, while the CC598A console is used on systems with an I4C IOU as the primary IOU.

Initial Options Display

The INITIAL OPTIONS display, figure 2-4, is the first screen that appears after deadstart is initiated.

The INITIAL OPTIONS display provides operating system load, execution of off-line maintenance, and deadstart utilities when the deadstart program is set for deadstart from disk.

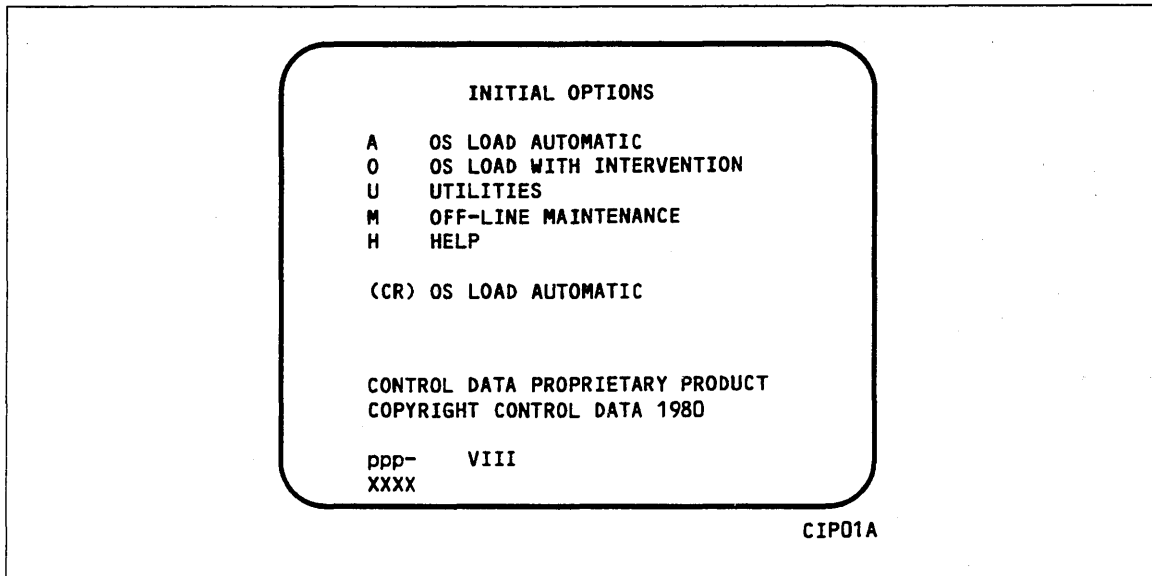

Figure 2-4. Initial Options From Disk for I1n, I2n, and All I4n Class Systems

Option	Description
--------	-------------

(CR) or A	OS LOAD AUTOMATIC. The system initialization software assumes that CIP has been installed to the deadstart disk. The system loads modules from the deadstart disk into memory and the central processor to establish the operating environment. Then, confidence tests verify the ability of PP memory to hold simple data patterns and preset PP memory contents to all ones.
-----------	--

If the system detects a fatal error during confidence testing, CTI records the errors in the DEL, if it is empty, for later processing by the operating system, then automatically attempts to retry the initialization. The following information appears on the left screen, if the DEL is full.

```

ERRORS WERE CLEARED BUT NOT LOGGED
DEADSTART ABORTED - FATAL ERROR

eeee-nn  rrrr      =cc cc cc cc cc cc cc cc
          rrrr      =cc cc cc cc cc cc cc cc
          rrrr      =cc cc cc cc cc cc cc cc
    
```

Option	Description
eeee-nn	Name and logical number of the hardware that has the error.
	IOU-00 Input/output unit.
	MEM-00 Central memory.
	PROC-0n Central processing unit. n=logical number.
rrrr	Register name.
cc	Register content in hexadecimal notation.

Inform a CE when a fatal error occurs.

The ENTER DATE and ENTER TIME prompts are displayed on the different systems under the following conditions.

1. The operator has selected mainframe initialization on an I2n Class and either:
 - a. NOS/VE load was selected, or
 - b. the operating system being loaded supports CTI as primary source of current date and time.
2. The Two Port Mux wall clock data on an I1n, I4Cn, or any I4n Class system is invalid and either 1a or 1b is true.

NOTE

The smallest unit of time that can be written to the Two Port Mux is minutes. If clock accuracy to within 1 second is desired, the operator should enter the desired seconds. However, this causes CTI to delay to the next minute before writing the clock and continuing the deadstart.

If clock accuracy to within 1 minute is sufficient, the operator can enter 00 seconds and CTI writes the clock without delaying the deadstart. Anytime the time entry is hh hours, 59 minutes, ss seconds, CTI writes the clock as hh:59:00.

Since I2 systems do not have a wall clock present in the Two Port Mux, any valid time entry is permitted and will be saved on the CIP deadstart device as entered without delaying the deadstart.

Option	Description
O	<p data-bbox="431 226 1166 254">OS LOAD WITH INTERVENTION. Select this option to:</p> <ul data-bbox="431 281 1414 789" style="list-style-type: none"> <li data-bbox="431 281 997 308">● Execute hardware verification sequence.⁹ <li data-bbox="431 342 1062 369">● Reconfigure mainframe hardware components. <li data-bbox="431 403 1393 491">● Change the operating system deadstart level or CMRDECK selection (NOS), or CMR selection (NOS/BE), or DCFILE selection (NOS/VE), as specified in the deadstart program. <li data-bbox="431 525 938 552">● Select an alternate deadstart device. <li data-bbox="431 585 618 613">● Load MDD. <li data-bbox="431 646 1393 701">● Toggle OS LOAD STATE (that is, select operating system to be loaded [NOS-NOS/VE, or NOS/VE]).¹⁰ <li data-bbox="431 735 1414 789">● Reload CM from EDD tape (option will not be displayed if MRT on disk is not valid). <p data-bbox="431 823 1393 877">Refer to the Operator Intervention display, figure 2-3, later in this section for more information.</p>
U	<p data-bbox="431 911 857 938">UTILITIES. Select this option to:</p> <ul data-bbox="431 966 1414 1663" style="list-style-type: none"> <li data-bbox="431 966 656 993">● Perform EDD. <li data-bbox="431 1026 818 1054">● Perform a printer dump.¹⁰ <li data-bbox="431 1087 997 1115">● Deadstart CTI from a different device.¹⁰ <li data-bbox="431 1148 1062 1176">● Define and display default device parameters. <li data-bbox="431 1209 862 1236">● Display CIP component levels. <li data-bbox="431 1270 1317 1325">● Initialize the mainframe after power interruption or maintenance activity. <li data-bbox="431 1358 618 1386">● Clear DEL. <li data-bbox="431 1419 932 1446">● Load the MDD in standalone mode. <li data-bbox="431 1480 954 1507">● Clear the central memory flaw table. <li data-bbox="431 1541 675 1568">● Clear the MRT. <li data-bbox="431 1602 1013 1629">● Perform disk subsystem microcode load.¹⁰ <li data-bbox="431 1663 899 1690">● Install NOS/VE boot programs.¹⁰ <p data-bbox="431 1724 1393 1745">Refer to the UTILITIES display, figure 2-16, later in this section for more information.</p>

9. Option not available on CYBER 960 or on any I4Cn Class system.

10. Option not available on I4Cn Class systems.

Option	Description
---------------	--------------------

M	<p>OFF-LINE MAINTENANCE. This option enables you to execute hardware tests for preventive maintenance or hardware error diagnosis. Information about the option is included in the MSL 15X Reference manual.</p> <p>The contents of word 12 of the deadstart program also affect the M option. Refer to Setting Word 12 in section 5 of this manual.</p>
----------	--

NOTE

After executing this option, it will be necessary to select the INITIALIZE MAINFRAME option in the UTILITIES display for proper OS loading to occur, if an I1n or I2n IOU is present. Initialization is automatically selected with an I4n or I4Cn IOU.

H	<p>HELP for INITIAL OPTIONS display.</p> <p>When the CC634B console is being used, press H or the HELP key for a description of the initial options.</p>
----------	--

The CIP version number, ppp- VIII, is displayed at the bottom of the INITIAL OPTIONS display: ppp is mainframe type and III is the CIP release level. At the very bottom of the display, xxxx is the PSR level.

Operator Intervention Display

The OPERATOR INTERVENTION display, figure 2-5, appears when you select option O, OPERATOR INTERVENTION, from the INITIAL OPTIONS display.

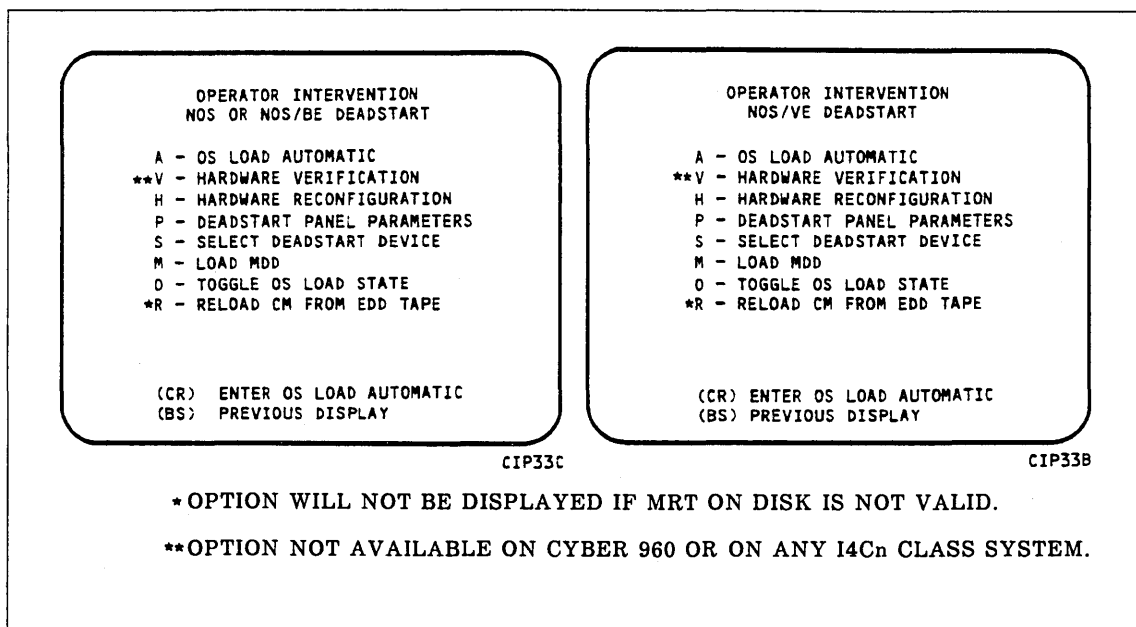

Figure 2-5. Operator Intervention

Option	Description
(CR) or A	CONTINUE OS LOAD. Select this option to perform an operating system load. Refer to the description of the OS LOAD AUTOMATIC option on the INITIAL OPTIONS display for more information.
V	HARDWARE VERIFICATION sequence. ¹¹ Select this option to execute PP, CM, and CPU confidence tests. Central memory contents are changed when you execute this option. The V option cannot be executed if a level 3 NOS or NOS/BE deadstart is selected. For NOS/VE a recovery deadstart will not be possible after this option has been executed.
NOTE	
After executing this option, it will be necessary to select the INITIALIZE MAINFRAME option in the UTILITIES display for proper OS loading to occur, if an I1n or I2n IOU is present. Initialization is automatically selected with an I4 IOU.	

11. Option not available on CYBER 960 or on any I4Cn Class system.

Option Description

You cannot test hardware that has been turned off via option H, HARDWARE RECONFIGURATION.

The names of the tests executed are: PCX, CMC, CT8, EJP, and MY1. Appendix E includes a brief description of each test.

If an error condition occurs, one of the following messages appears.

```

ERROR PP xx
ERROR CM
ERROR CPU xx
ERROR REG
    
```

xx indicates the PP or CPU in error. Inform a CE.

Upon successful test completion, the system displays:

```

TESTING COMPLETE-DEADSTART
    
```

Initiate deadstart after testing to ensure that the system is returned to initial deadstart condition prior to system loading.

H HARDWARE RECONFIGURATION. Select this option to alter the mainframe hardware configuration. When selected, figure 2-6 appears.

HARDWARE RECONFIGURATION

(CR) - CONTINUE OS LOAD
 (BS) - PREVIOUS DISPLAY
 R - RECONFIGURE CPU ELEMENTS

*CM = †
 *PS = 4KB PAGE SIZE (10)
 *PE = 4 ENTRIES PER PAGE
 IOU = 0 ††

OFF ELEMENTS

PPnn
 .CPUn
 CPPnn ††

CIPX

† VALUES CANNOT BE MODIFIED UNLESS INITIALIZE MAINFRAME MEMORY HAS BEEN SELECTED ON THE UTILITIES DISPLAY. IF NOS/VE DEADSTART, CM=MB CM SIZE (10); IF NOS OR NOS/VE DEADSTART, CM=CM WORDS/100B.

†† I4n CLASS SYSTEMS ONLY.

††† DISPLAYED FOR MULTIPLE IOU CONFIGUATIONS ONLY.

Figure 2-6. Hardware Reconfiguration

Option	Description
--------	-------------

The HARDWARE RECONFIGURATION display permits you to reconfigure central memory elements. To reconfigure CPU elements, enter an R while displaying the HARDWARE RECONFIGURATION display to select the RECONFIGURE CPU ELEMENTS display. The RECONFIGURE CPU ELEMENTS display shown in figure 2-8 permits you to reconfigure CPU elements.

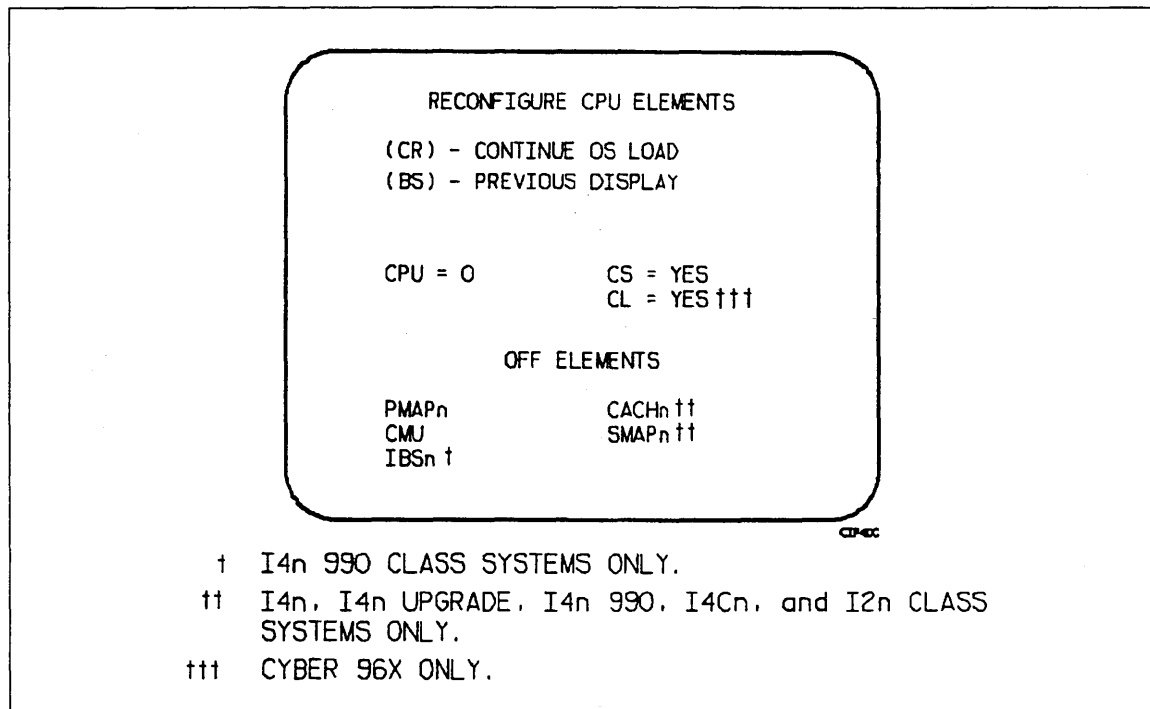

Figure 2-7. Reconfigure CPU Elements for I1n, I2n, and All I4n Class Systems

The default hardware configuration includes every hardware element available for use. To change the hardware configuration, enter the appropriate entry on the HARDWARE RECONFIGURATION or RECONFIGURE CPU ELEMENTS display as described in table 2-1. When you turn off an element, its identifier is added to the OFF ELEMENTS list on the display. Entries are in the form keyword=option.

Table 2-1. Hardware Reconfiguration Entries

Keyword	Option	Display ¹	Function																																																				
CM= ²	nnnnnnn	*1	Specifies the size, in octal (for NOS or NOS/BE), of central memory in hundreds of words or in decimal (for NOS/VE). The following examples show the value you enter for nnnnnnn, given the central memory size for NOS, NOS/BE, or NOS/VE.																																																				
			<table border="1"> <thead> <tr> <th>Central Memory Size in Decimal</th> <th>Words</th> <th>Central Memory Size in Megabytes</th> <th>nnnnnnn</th> </tr> </thead> <tbody> <tr><td>131K</td><td></td><td>1</td><td>4000</td></tr> <tr><td>262K</td><td></td><td>2</td><td>10000</td></tr> <tr><td>524K</td><td></td><td>4</td><td>20000</td></tr> <tr><td>1048K</td><td></td><td>8</td><td>40000</td></tr> <tr><td>2097K</td><td></td><td>16</td><td>100000</td></tr> <tr><td>4195K</td><td></td><td>32</td><td>200000</td></tr> <tr><td>8390K</td><td></td><td>64</td><td>400000</td></tr> <tr><td>16780K</td><td></td><td>128</td><td>1000000</td></tr> <tr><td>33560K</td><td></td><td>256</td><td>2000000</td></tr> <tr><td>67120K</td><td></td><td>512</td><td>4000000</td></tr> <tr><td>134240K</td><td></td><td>1024</td><td>10000000</td></tr> <tr><td>268480K</td><td></td><td>2048</td><td>20000000</td></tr> </tbody> </table>	Central Memory Size in Decimal	Words	Central Memory Size in Megabytes	nnnnnnn	131K		1	4000	262K		2	10000	524K		4	20000	1048K		8	40000	2097K		16	100000	4195K		32	200000	8390K		64	400000	16780K		128	1000000	33560K		256	2000000	67120K		512	4000000	134240K		1024	10000000	268480K		2048	20000000
Central Memory Size in Decimal	Words	Central Memory Size in Megabytes	nnnnnnn																																																				
131K		1	4000																																																				
262K		2	10000																																																				
524K		4	20000																																																				
1048K		8	40000																																																				
2097K		16	100000																																																				
4195K		32	200000																																																				
8390K		64	400000																																																				
16780K		128	1000000																																																				
33560K		256	2000000																																																				
67120K		512	4000000																																																				
134240K		1024	10000000																																																				
268480K		2048	20000000																																																				

If you enter CM=0 or do not enter the CM=nnnnnnn parameter, the system sets it to the maximum central memory size available.

If you specify a value for nnnnnnn that exceeds the amount of physical memory, the system sends the following message:

UNAVAILABLE

If you specify a central memory size that is not large enough for a system deadstart, the system sets the maximum central memory size and the following message appears.

INVALID ENTRY

1. *1 = HARDWARE RECONFIGURATION display; *2 = RECONFIGURE CPU ELEMENTS display.

2. These values are saved for all deadstarts until changed in the mainframe reconfiguration table for CYBER 180 mainframes. Changing these values also requires selecting INITIALIZE MAINFRAME if not the first OS deadstart.

(Continued)

Table 2-1. Hardware Reconfiguration Entries (Continued)

Keyword	Option	Display¹	Function
CPU _n = ²	OFF/ON	*1	Specifies the logical status of each available CPU. Values for n can be 0 or 1. On a two-CPU system, at least one must be ON. If you enter CPU0=OFF on a one-CPU system, the entry is ignored; the system uses the CPU.
CPU=	n	*2	Specifies the CPU for which you are to reconfigure elements.
PP _{nn} = ²	OFF/ON	*1	Logically turns OFF/ON one or more peripheral processors. Acceptable values for nn are 3 through 11 (excluding 10) and, if you have them, 20 through 31. Ranges may be specified. For example, PP5-7=OFF.
CPP _{nn} = ²	OFF/ON	*1	Logically turns OFF/ON one or more I4 CIO peripheral processors. Acceptable values for nn are 0 through 11B. Ranges may be specified. For example, CPP5-7=OFF. If the IOU installed is not an I4, the system displays the following message: INVALID ENTRY If the IOU is an I4, but no CIO PPs are installed, the system displays: UNAVAILABLE
IBS _n = ²	OFF/ON	*2	Specifies the logical status of each set of the central processor instruction buffer stack. The value for n can be any number from 0-3 or in the form a-b (a less than b). At least 1 set must be present or INVALID ENTRY will be displayed. (Valid for I4n 990 Class systems.)

1. *1 = HARDWARE RECONFIGURATION display; *2 = RECONFIGURE CPU ELEMENTS display.

2. These values are saved for all deadstarts until changed in the mainframe reconfiguration table for CYBER 180 mainframes. Changing these values also requires selecting INITIALIZE MAINFRAME if not the first OS deadstart.

(Continued)

Table 2-1. Hardware Reconfiguration Entries (Continued)

Keyword	Option	Display¹	Function
PMAPn= ²	OFF/ON	*2	<p>Specifies the logical status of each unit of the central processor page map. The value for n can be any number from 0 to 3. The value for n also can be in the form a-b (a through b); a and b can be any number from 0 to 3, and a is less than b.</p> <p>Turn OFF a page map unit only in the event of a hardware error. System performance degrades when a map unit is turned OFF.</p>
CACHn= ²	OFF/ON	*2	<p>Specifies logical status of each central processor cache unit. Acceptable values for n are 0 through 3. Ranges may be specified. For example, CACH0-1=OFF.</p> <p>Turn OFF a cache unit only in the event of a hardware error. System performance degrades when a cache unit is turned OFF. Used on I2n, I4Cn, and all I4n Class systems only.</p>
SMAPn= ²	OFF/ON	*2	<p>Specifies logical status of each central processor segment map unit. Acceptable values for n are 0, 1, or 0-1. For example, SMAP0-1=OFF. Used on I2n, I4Cn, and all I4n Class systems only.</p> <p>Turn OFF a segment map unit only in the event of a hardware error. When a segment map unit is turned off, system performance degrades.</p>
PS= ²	xx	*1	<p>Specifies the NOS/VE page size for standalone or dual state deadstarts. The allowable page sizes³ in decimal kilobytes are 2, 4, 8, and 16 (default=4).</p>
PE= ²	x	*1	<p>Specifies the NOS/VE entries per page table page for standalone or dual state deadstarts. The allowable values are 2, 4, and 8 (default=4).</p>

1. *1 = HARDWARE RECONFIGURATION display; *2 = RECONFIGURE CPU ELEMENTS display.

2. These values are saved for all deadstarts until changed in the mainframe reconfiguration table for CYBER 180 mainframes. Changing these values also requires selecting INITIALIZE MAINFRAME if not the first OS deadstart.

3. In respect to CM size, the minimum page sizes are 2K (if CM ≤ 128MB), 4K (if CM > 128MB or if CYBER 990-X), or 8K (if CM ≥ 256 MB).

(Continued)

Table 2-1. Hardware Reconfiguration Entries (Continued)

Keyword	Option	Display¹	Function
IOUn= ²	ON/OFF	*1	Specifies the logical status of each available IOU. Values for n can be 0 or 1. If you enter IOU0 = OFF you will receive the message: INVALID ENTRY This applies to multiple IOUs only. The entry is invalid for single IOU systems.
IOU = n	0/1	*1	Specifies the IOU for which you are to reconfigure elements. This applies to multiple IOUs only. The entry is invalid for single IOU systems.
CS = ²	YES/NO	*2	Specifies whether the system should load the central processor microcode into control store memory. The default is YES for all levels of deadstart. If NO is specified, the system does not load microcode from the deadstart disk into control store; whatever is there is used.
CL = ²	YES/NO		Pertains to CYBER 96X only. Specifies whether the system should initialize the CPU clock system on an initialize mainframe deadstart. The default is YES. If CL=NO, or if utilizing a recovery type deadstart, the clock system will not be initialized.

1. *1 = HARDWARE RECONFIGURATION display; *2 = RECONFIGURE CPU ELEMENTS display.

2. These values are saved for all deadstarts until changed in the mainframe reconfiguration table for CYBER 180 mainframes. Changing the values of PS, PE, or CM also requires selecting INITIALIZE MAINFRAME if not the first OS deadstart.

Option	Description
P (NOS or NOS/BE)	DEADSTART PANEL PARAMETERS for NOS or NOS/BE. Select this option to change any of the following: the deadstart level, the CMRDECK, or deadstart program words 12 and 14. The DEADSTART PANEL PARAMETERS display, figure 2-8, appears. Table 2-2 lists the keyboard entries that you can make to change the deadstart panel program. The NOS-NOS/BE option does not exist on I4Cn Class systems.

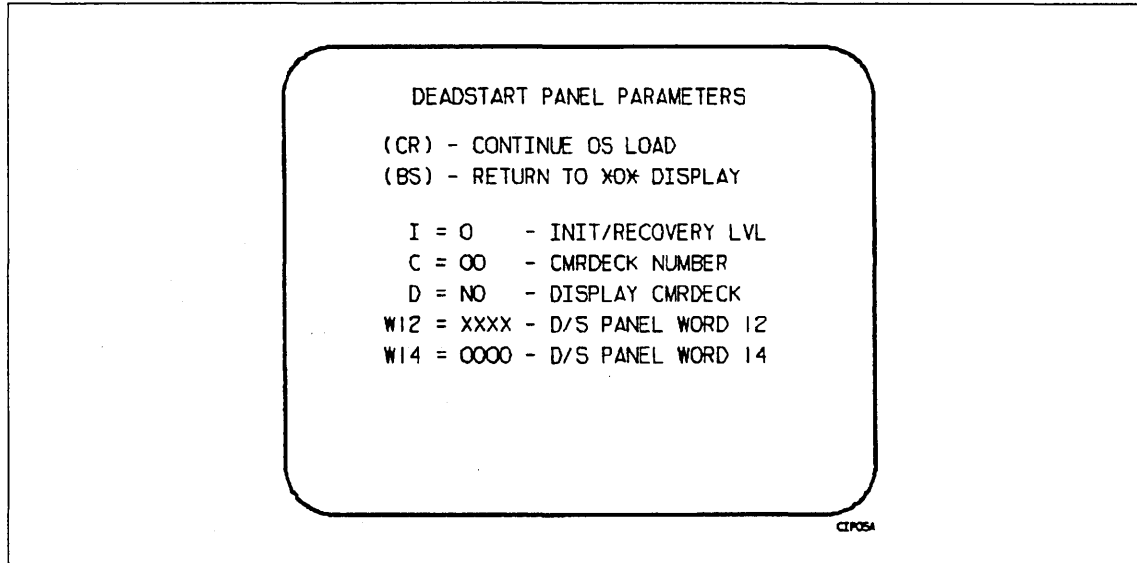

Figure 2-8. Deadstart Panel Parameters for NOS or NOS/BE

Press the carriage return key to cause system deadstart processing to continue with no further intervention on your part. Press the backspace key to return to the OPERATOR INTERVENTION display.

Table 2-2. Keyboard Entries for the Deadstart Panel Parameters Display for NOS or NOS/BE

Keyword	Function
I=x	Specifies the level of deadstart. The value of x can be 0, 1, 2, or 3.
C=xx	Specifies the CMRDECK (CMR for NOS/BE) number. The value of xx can be any number from 0 to 77 octal. Refer to the section 5 for information about CMRDECK/CMR selection.
D=xxx	Entry is not used by NOS/BE. For NOS, specifies whether the CMRDECK is to be displayed. The value of xxx can be YES for display CMRDECK, NO for do not display CMRDECK.
W12=xxxx	Specifies the value for deadstart program word 12. Refer to the section 5 for the proper setting.
W14=xxxx	Specifies the value for deadstart program word 14. Word 14 is reserved for the operating system or maintenance system.

Option	Description
P (NOS/VE)	DEADSTART PANEL PARAMETERS for NOS/VE. Select this option to change the DCFILE or the operator pause entry. The display shown in figure 2-9 appears.

Table 2-3 list the keyboard entries that you can make to change deadstart panel (program) parameters for NOS/VE.

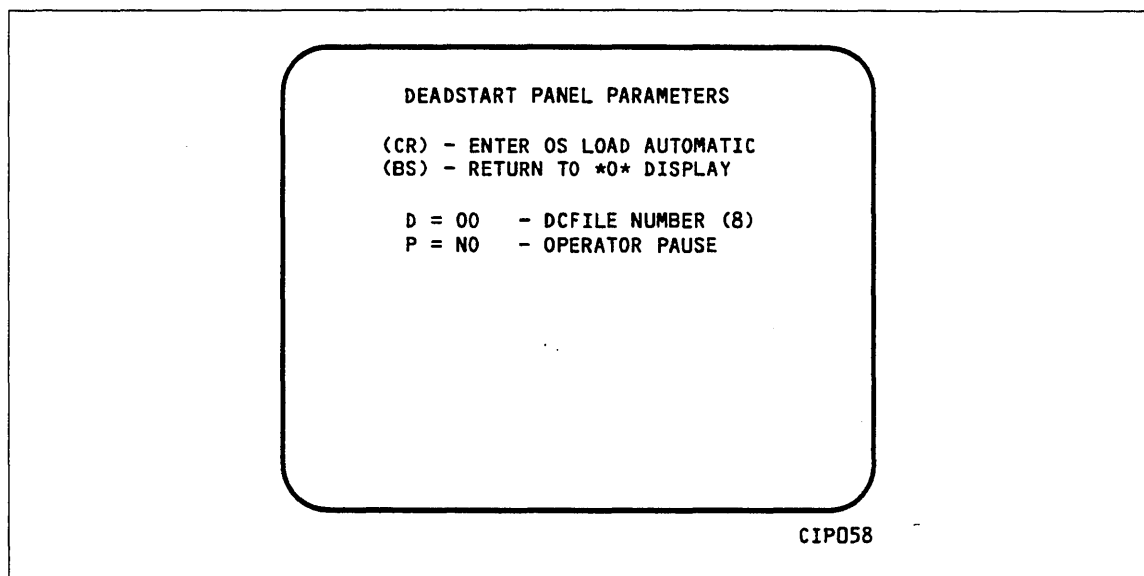

Figure 2-9. Deadstart Panel Parameters for NOS/VE

Table 2-3. Keyboard Entries for the Deadstart Panel Parameters Display for NOS/VE

Keyword	Function
D=xx	Specifies the DCFILE number. The value of xx can be any number from 0 to 77 octal.
P=xxx	Specifies whether a pause will be initiated for operator entries at the NOS/VE Deadstart and Systems Device Configuration Selections menu. The value of xxx can be: YES for Operator Pause NO for Do Not Pause

Option	Description
--------	-------------

S	SELECT OS DEADSTART DEVICE. Select this option to specify an alternate disk or a tape device as the OS Load Device (figure 2-10).
---	---

Press the carriage return key to cause system deadstart processing to continue with no further intervention on your part. You cannot select additional options after this entry. The CIP disk device is therefore the OS device.

Press the backspace key to return to the OPERATOR INTERVENTION display.

Entry	Description
-------	-------------

T	TAPE DEADSTART. Select this option for OS load from tape rather than from disk. For NOS or NOS/BE deadstarts, the system prompts you for tape device type, channel, equipment, and unit. For NOS/VE deadstarts, the OS load initiates upon selecting this option.
---	---

D	ALTERNATE DISK DEADSTART. Select this option to choose an alternate disk device for the OS load device. For NOS or NOS/BE deadstarts, the system prompts you for the disk channel, equipment, and unit. For NOS/VE deadstarts, the OS load initiates upon selecting this option.
---	--

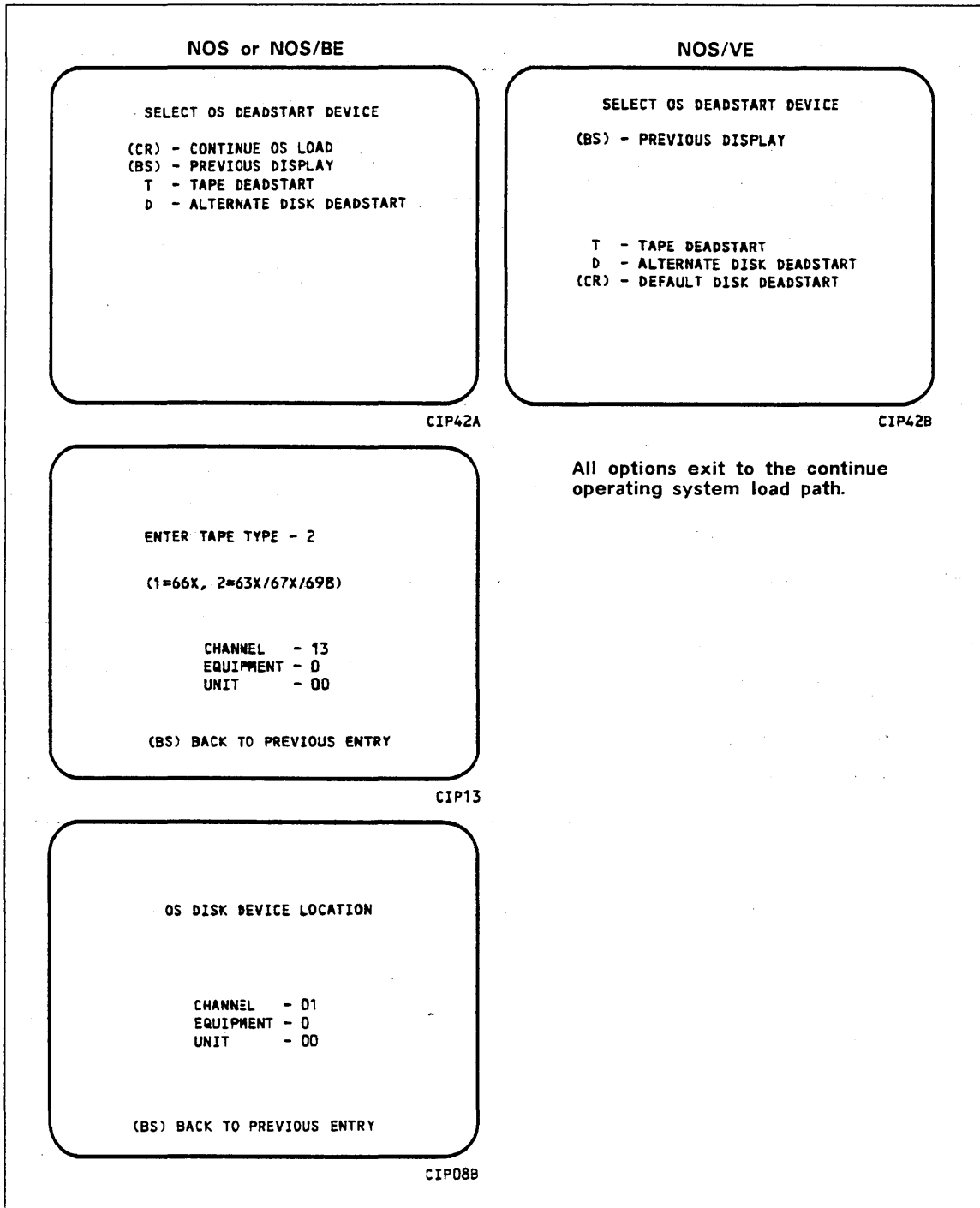

Figure 2-10. Deadstart Device

Option	Description
M	LOAD MDD. This value is saved in MRT for all I1n, I2n, and all I4n Class systems. Select this option to load MDD. The display shown in figure 2-11 appears.

MDD = monitor display driver

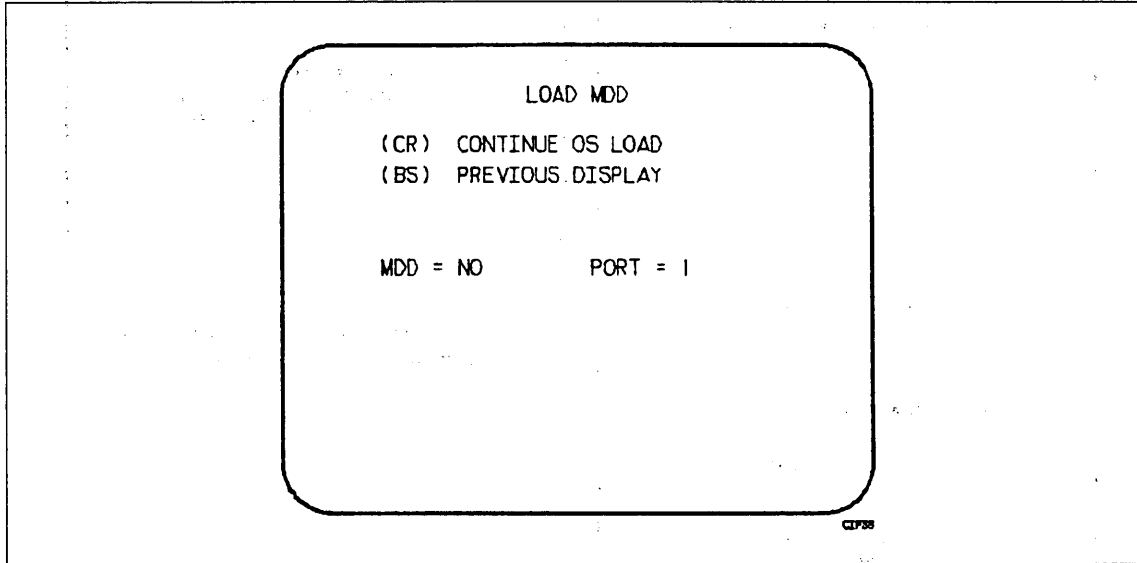

Figure 2-11. Load MDD

Direct the system to load MDD by entering:

MDD=YES

Select the port number of the two-port multiplexer that MDD uses by entering:

PORT = n

Parameter n is 0 or 1. The default port number is 0.

NOTE

1. Be sure the baud rate of the specified port of the two-port multiplexer is set properly for the communications being used.
2. Turning on MDD at this time will permanently lock MDD into a PP. The MDD BYE command will have no effect when MDD is loaded via CTL.

Press the carriage return key to cause system deadstart processing to continue with no further intervention on your part.

Press the backspace key to return to the OPERATOR INTERVENTION display.

Option	Description
--------	-------------

O ¹²	TOGGLE OS LOAD STATE to either a NOS/VE deadstart or a NOS or NOS/BE deadstart. The selected load state is displayed below the OPERATOR INTERVENTION display header. This value is saved in MRT for all I1n, I2n, I4n mainframes. This option is displayed only if a U,I deadstart is being performed (the INITIALIZE MAINFRAME option has been selected from the UTILITIES display).
-----------------	---

Press the carriage return key to continue system deadstart processing with no further intervention on your part. Press the backspace key to return to the OPERATOR INTERVENTION display.

R	Reload CM/ESM from the specified EDD tape. This allows a recovery/continuation deadstart after any type of maintenance action including a power off, provided that:
---	---

- An EDD dump was taken prior to the maintenance action.
- The MRT is valid.
- No logical (MRT) or physical reconfiguration was done since the EDD dump was taken.
- A level 3 recovery has been selected for NOS or NOS/BE or continuation deadstart for NOS/VE.

The EDD tape should be mounted on the tape unit and the tape unit should be ready.

1. The console displays:

```
ENTER RELOAD OPTION
```

```
E - RELOAD ESM ONLY
```

```
C - RELOAD CM ONLY
```

```
B - RELOAD CM AND ESM
```

E	Select this option to reload ESM only. (NOS or NOS/BE) A non-zero level deadstart is required. The system will then prompt you to:
---	--

```
ENTER ESM CHANNEL
```

```
CHANNEL cc
```

The value cc is the channel specified in the default parameter block in the CTI/MSL disk area. After the channel has been entered, the system will prompt the operator for the EDD tape parameters.

C	Select this option to reload CM only. For NOS or NOS/BE A level 3 deadstart is required. The system will then prompt for the EDD tape parameters.
---	---

B	Select this option to reload CM and ESM from the EDD tape. For NOS or NOS/BE a level 3 deadstart is required. The operator will be prompted for the ESM channel and then the EDD tape parameters.
---	---

12. Option not available on any I4Cn Class system and not available if the INITIALIZE MAINFRAME option has not been selected.

Option	Description
--------	-------------

2. EDD tape parameters

The console displays:

CM/ESM RELOAD DEVICE TYPE-m

1=667, 669 (800 BPI)
 2=667 (800 BPI)
 639, 679, 698 (1600 BPI)
 3=639, 679, 698 (6250 BPI)

The value m is the device type specified in the default parameter block of the CTI/MSL disk area. If the default parameter block is not present, zeros are displayed.

3. Press the carriage return key to use the device type being displayed or enter a 1, 2, or 3 and then press the carriage return key to specify an alternate device. The console displays:

CM/ESM RELOAD DEVICE TYPE-m

CHANNEL-cc

(BS) - BACK TO PREVIOUS ENTRY

The value cc is the channel specified in the default parameter block in the CTI/MSL disk area. If the parameter block is not present, zeros are displayed.

4. Press carriage return key to use the channel being displayed or enter the two-digit channel number of the tape unit from which memory is to be reloaded and press the carriage return key. The console displays:

CM RELOAD DEVICE TYPE-m

CHANNEL-cc

EQUIPMENT-e

(BS) - BACK TO PREVIOUS ENTRY

The value e is the equipment number specified in the default parameter block in the CTI/MSL disk area. If the default parameter block is not present, zeros are displayed.

Option	Description
--------	-------------

5. Press the carriage return key to use the equipment number displayed or enter the equipment number and press the carriage return key. The console displays:

```
CM RELOAD DEVICE TYPE-m
CHANNEL-cc
EQUIPMENT-e
UNIT-uu
```

(BS) - BACK TO PREVIOUS ENTRY

The value uu is the unit number specified in the default parameter block of the CTI/MSL disk area. If the default parameter block is not present, zeros are displayed.

6. Press the carriage return key to use the unit number displayed or enter the two-digit unit number and press the carriage return key. CTI will return to the OPERATOR INTERVENTION display, figure 2-5, appending the appropriate message to the bottom of the display:

```
CM WILL BE RELOADED FROM EDD TAPE
```

```
ESM WILL BE RELOADED FROM EDD TAPE
```

```
CM AND ESM WILL BE RELOADED FROM EDD TAPE
```

Utilities Display

Selecting the U option from the INITIAL OPTIONS display causes the UTILITIES display, figure 2-12, to appear.

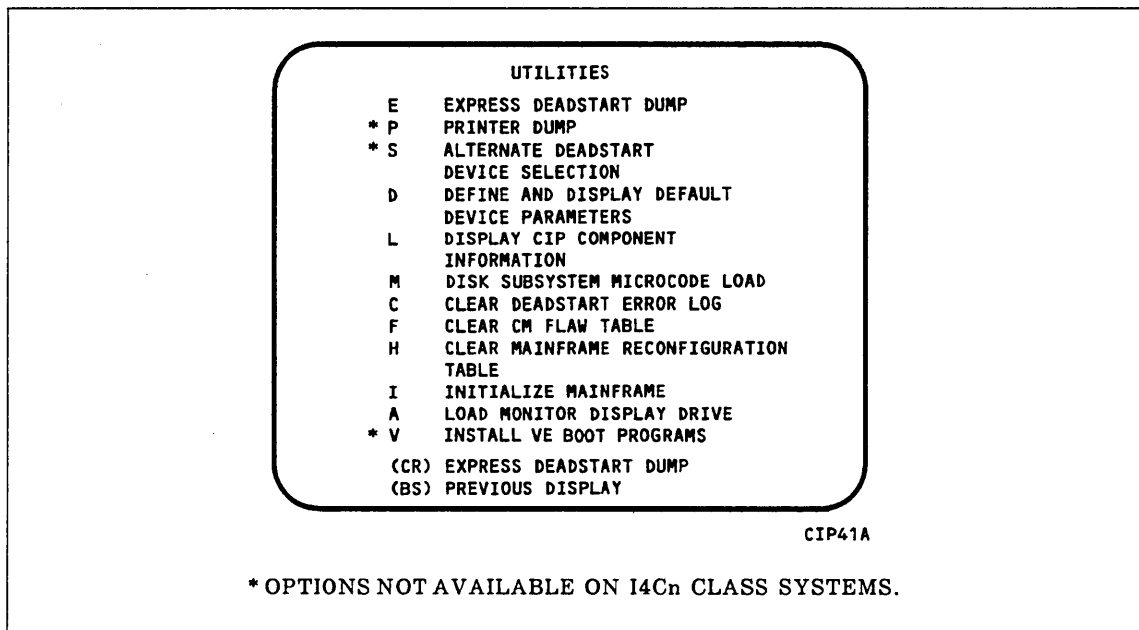

Figure 2-12. Utilities, Disk Deadstart

Option	Description
(CR) or E	EXPRESS DEADSTART DUMP. Select this option to dump to magnetic tape the contents of PP memories, central memory, unified extended memory, CPU hardware registers, maintenance registers, processor control store memories, and the tape and disk controlware. Refer to Performing an Express Deadstart Dump in section 6 for procedures and further information.
P ¹³	PRINTER DUMP. Select this option to dump central memory, PP memory, or maintenance register contents to a line printer. When you specify P, the appropriate DUMP TO PRINTER OPTIONS display, figure 2-13 or 14 appears. You cannot return to the UTILITIES display from this display. You must redeadstart the system. Table 2-4 is an alphabetic list of the keyboard entries for performing a printer dump. Refer to Performing a Printer Dump in section 6 for procedures and further information.

NOTE

When the E or P options are selected, CTI will check the error status of all the system elements. If errors are encountered, CTI will log the errors in the DEL. If the DEL is full, CTI will display the errors before allowing the deadstart to continue.

13. Option not available on any I4Cn Class system.

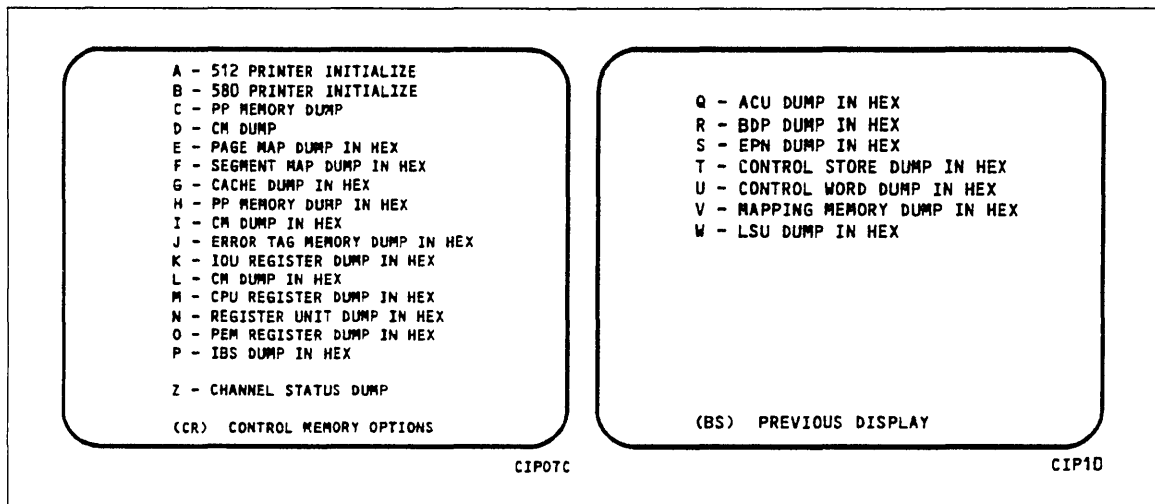

Figure 2-13. Dump to Printer Options for I4n 990 Class Systems, Disk

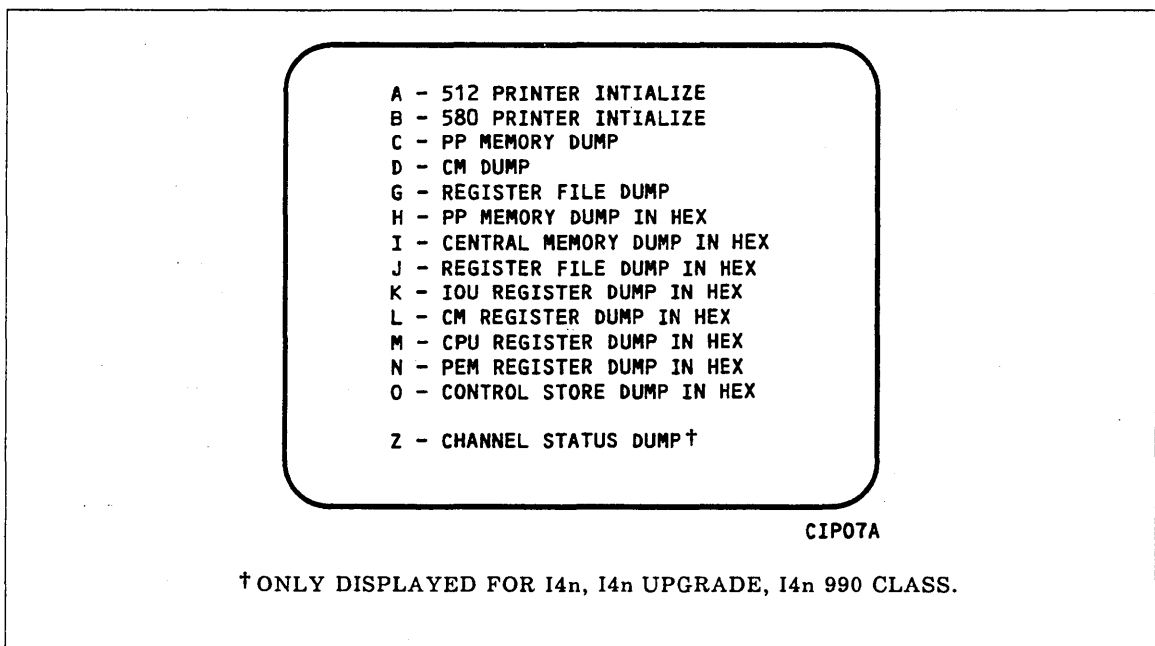

Figure 2-14. Dump to Printer Options for All CYBER Systems Except I4n 990 Class Systems, Disk

Table 2-4. Keyboard Entries for a Printer Dump, I1n, I2n, and All I4n Class Systems, Disk Deadstart

Entry	Function
A	512 PRINTER INITIALIZE. This option initializes the 512 printer image with the data necessary to print with a 512-1 print train.
B	580 PRINTER INITIALIZE. This option initializes the 580 printer buffer image and format buffer image memories.
C ¹	PP MEMORY DUMP. This option provides an octal dump to printer of 12-bit PP memories and 16-bit PP memories with their associated R registers. If the IOU is an I4, the associated P, Q, K, and A register values will also be dumped.
D	CM DUMP. This option provides an octal dump to printer of a selected area of central memory.
E	PAGE MAP DUMP IN HEX. This option provides a hexadecimal dump to the printer of the CPU Page Map.
F	SEGMENT MAP DUMP IN HEX. This option provides a hexadecimal dump to the printer of the CPU Segment Map.
G	CACHE DUMP IN HEX. This option provides a hexadecimal dump to the printer of the CPU Cache.
H	PP MEMORY DUMP IN HEX. This option provides a hexadecimal dump to the printer of the PP memories. If the IOU is an I4, the associated P, Q, K, and A register values will also be dumped.
I	CM DUMP IN HEX. This option provides a hexadecimal dump to the printer of a selected area of central memory.
J	REGISTER FILE DUMP IN HEX. This option provides a hexadecimal dump to the printer of the CPU register file contents.
J ²	ERROR TAG MEMORY DUMP IN HEX. This option provides a hexadecimal dump to the printer of the CPU Error Tag Memory contents.
K ¹	IOU REGISTER FILE DUMP IN HEX. This option provides a hexadecimal dump to the printer of the IOU maintenance register contents. If the IOU is an I4, the CIO registers will also be dumped, if installed.
L	CM REGISTER DUMP IN HEX. This option provides a hexadecimal dump to the printer of the contents of the central memory maintenance registers.

1. On multiple IOU systems, IOU0 only is supported.

2. I4n 990 Class systems only.

(Continued)

Table 2-4. Keyboard Entries for a Printer Dump, I1n, I2n, and All I4n Class Systems, Disk Deadstart (Continued)

Entry	Function
M	CPU REGISTER DUMP IN HEX. This option provides a hexadecimal dump to the printer of the contents of the CPU maintenance registers. Respond to the message CPU NO = by entering the number of the CPU for which registers are to be dumped. If microcode is not executing, the program dumps only the hardware maintenance registers. In place of the software registers, the following message appears on the printer dump: MICROCODE HUNG
N	PEM REGISTER DUMP IN HEX. This option provides a hexadecimal dump of the contents of the PEM registers.
N ¹	REGISTER UNIT DUMP IN HEX. This option provides a hexadecimal dump of the contents of the associated registers.
O	CONTROL STORE DUMP IN HEX. This option provides a hexadecimal dump to the printer of the contents of control store. Respond to the message CPU NO = by entering the number of the CPU for which control store is to be dumped.
O ¹	PEM REGISTER DUMP IN HEX. This option provides a hexadecimal dump of the contents of the PEM registers.
P	IBS DUMP IN HEX. This option provides a hexadecimal dump to the printer of the CPU IBS contents.
Q	ACU DUMP IN HEX. This option provides a hexadecimal dump to the printer of the CPU ACU contents.
R	BDP DUMP IN HEX. This option provides a hexadecimal dump to the printer of the CPU BDP contents.
S	EPN DUMP IN HEX. This option provides a hexadecimal dump to the printer of the CPU EPN contents.
T	CONTROL STORE DUMP IN HEX. This option provides a hexadecimal dump to the printer of the contents of control store followed by a dump of shadow memory, if available.
U ¹	CONTROL WORD DUMP IN HEX. This option provides a hexadecimal dump to the printer of CPU Control Word contents.

NOTE

For any of the CPU DUMP options respond to the message CPU NO = by entering the number of the CPU for which registers are to be dumped.

1. I4n 990 Class systems only.

(Continued)

Table 2-4. Keyboard Entries for a Printer Dump, I1n, I2n, and All I4n Class Systems, Disk Deadstart (Continued)

Entry	Function
V	MAPPING MEMORY DUMP IN HEX. This option provides a hexadecimal dump to the printer of the CPU Mapping Memory control memory contents.
W	LSU DUMP IN HEX. This option provides a hexadecimal dump to the printer of the CPU LSU control memory contents.
Z	CHANNEL STATUS DUMP. This option, available on I4 IOUs only, dumps the status of Parity Error Disable, Active, Full, Channel Flag, and Channel Error for NIO channels 00-31B and, if installed, CIO channels 00-11B. A "0" in the resulting output indicates the corresponding status flag is clear and a "1" indicates the status flag is set.

Option	Description
S	ALTERNATE DEADSTART. Select this option to specify an alternate CIP tape unit or disk device from which to deadstart. The ALTERNATE DEADSTART display, figure 2-15, appears. This option not available on I4Cn Class systems.

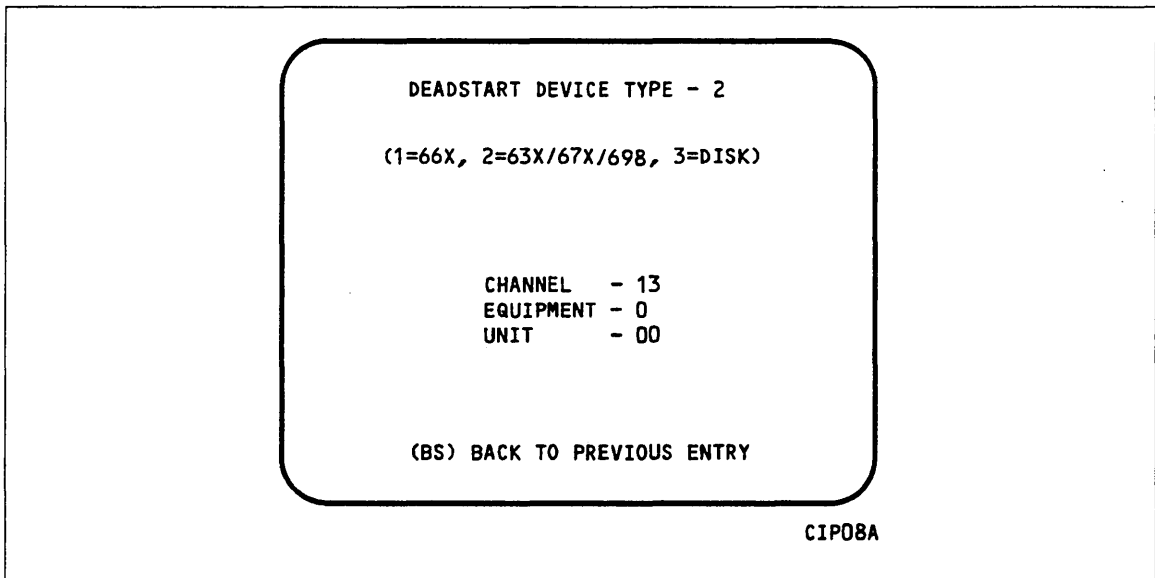

Figure 2-15. Alternate Deadstart

Enter the device type and press the carriage return key. The system then prompts you for channel, equipment, and unit numbers.

Default values are provided for the device parameters. The values are those specified in the default parameter block. The default parameter block is defined through option D, DEFINE AND DISPLAY DEFAULT DEVICE PARAMETERS.

Option	Description
	After the device information is entered, press the carriage return key to deadstart from the alternate device.
	NOTE
	Alternate deadstart from operating system deadstart tapes is not supported for I1n, I2n, I4Cn, and all I4n Class computer systems. To load the operating system from a tape file, select option T, OPERATING SYSTEM FILE ON TAPE, from the OPERATOR INTERVENTION display.
D	DEFINE AND DISPLAY DEFAULT DEVICE PARAMETERS. Select this option to assign default values to the channel, equipment, and unit numbers of a CIP tape deadstart device, disk deadstart device, alternate disk deadstart device, tape dump (EDD) device, ESM channel, or printer dump device. Default values are initially assigned to the device parameters when CIP is installed.
L	DISPLAY CIP COMPONENT INFORMATION. Select this option to display the release levels of the CIP components: microcode, EI, SCD, DFT, MDD, DFT, VE programs, and the valid or invalid status of the DEL, CFT, VCU, SCI, and MRT. An asterisk identifies components that have been installed manually.
I	INITIALIZE MAINFRAME. Select this option to initialize the mainframe after power interruption or maintenance activity. The INITIAL OPTIONS display reappears with the following message on the bottom of the display:
	ALL MAINFRAME MEMORIES WILL BE INITIALIZED FOR MSL/OS LOADS
	Mainframe initialization, including initialization of central memory, PP memory, and maintenance registers, occurs when you select this option and then perform either an operating system load on a level 0, 1, or 2 (not 3) deadstart or select the off-line maintenance option. Refer to section 6 for procedures and additional information about this option.
M ¹⁴	DISK SUBSYSTEM MICROCODE LOAD. Select this option to load peripheral microcode into the 834/836, 844, 885, or 895 disk adapter and control module memory and install peripheral microcode onto specified drives. Refer to Loading and Installing Disk Subsystem Microcode in section 6 for procedures and additional information about this option.
C	CLEAR DEADSTART ERROR LOG. Select this option to clear the data in the DEL.
F	CLEAR CM FLAW TABLE. Select this option to clear the data in the CM flaw table.

14. Option not available on I4Cn Class systems.

Option	Description
--------	-------------

H	CLEAR MAINFRAME RECONFIGURATION TABLE. Select this option to clear the mainframe reconfiguration table data stored on disk. When you specify H, the following warning appears:
---	---

CLEARING THE MRT WILL CAUSE THE FOLLOWING ITEMS ON THE NEXT DEADSTART,

ALL MAINFRAME MEMORIES WILL
BE INITIALIZED FOR OS LOADS

CM/ESM RELOAD FROM EDD TAPE OPTION
WILL NOT BE AVAILABLE.

(CR) TO CONTINUE
(BS) BACKSPACE TO PREVIOUS DISPLAY

NOTE

Beginning with CIP Version 7, clearing the MRT forces a memory initialization by CTI. This was made necessary because with CM reload, CTI no longer writes CM (EI and the CIP Directory) on recovery deadstarts. This requires that the first word address (FWA) of the CIP buffer be maintained in the MRT.

A	LOAD THE MONITOR DISPLAY DRIVER. Select this option to execute MDD in a standalone mode (not concurrent with the operating system). When you specify A, the MDD PARAMETERS display, figure 2-16, appears.
---	---

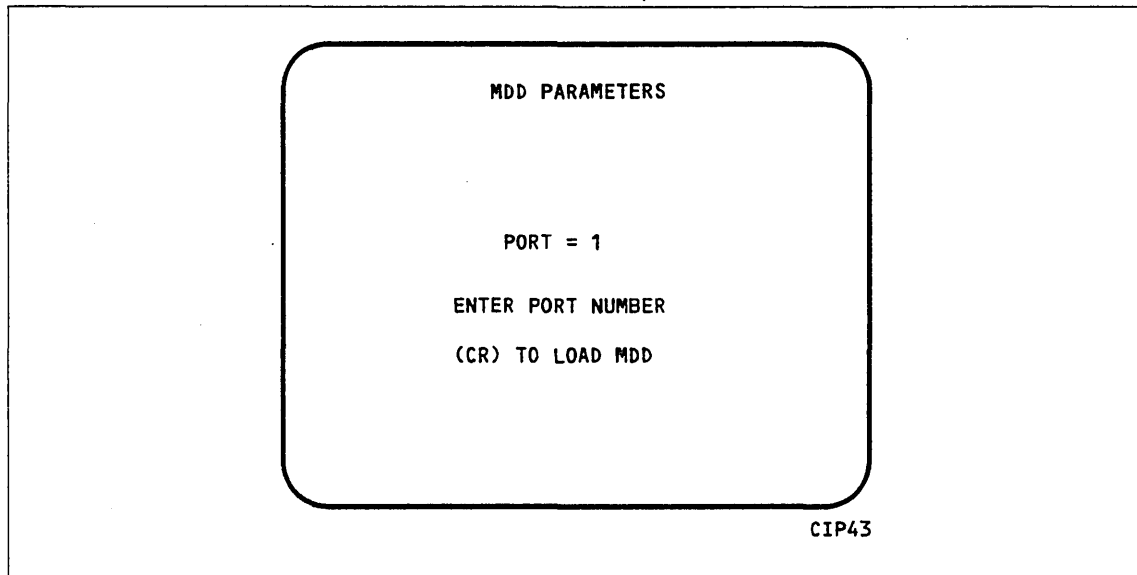

Figure 2-16. MDD Parameters

Option	Description
--------	-------------

Enter the port number if different than the one displayed. Press the carriage return key to cause MDD to load. When you have finished using MDD, a deadstart is required. Refer to section 7 for the uses of MDD.

This option is used to support the analysis of the state of a mainframe after encountering a system interrupt. It should only be selected after an operating system has been previously loaded. CTI loads MDD out of central memory (stored there on a system load) and issues the following message, if a checksum of the MDD program from central memory fails.

UNABLE TO LOAD MDD.

THE INTEGRITY OF CENTRAL MEMORY
HAS BEEN COMPROMISED.

V¹⁴

INSTALL NOS/VE BOOT PROGRAMS. Select this option to install or replace the VE boot programs to the CDA on the CIP device. When you specify the V option, figure 2-17 appears. You must then indicate the path to the tape device, from which the VE boot programs are coming from.

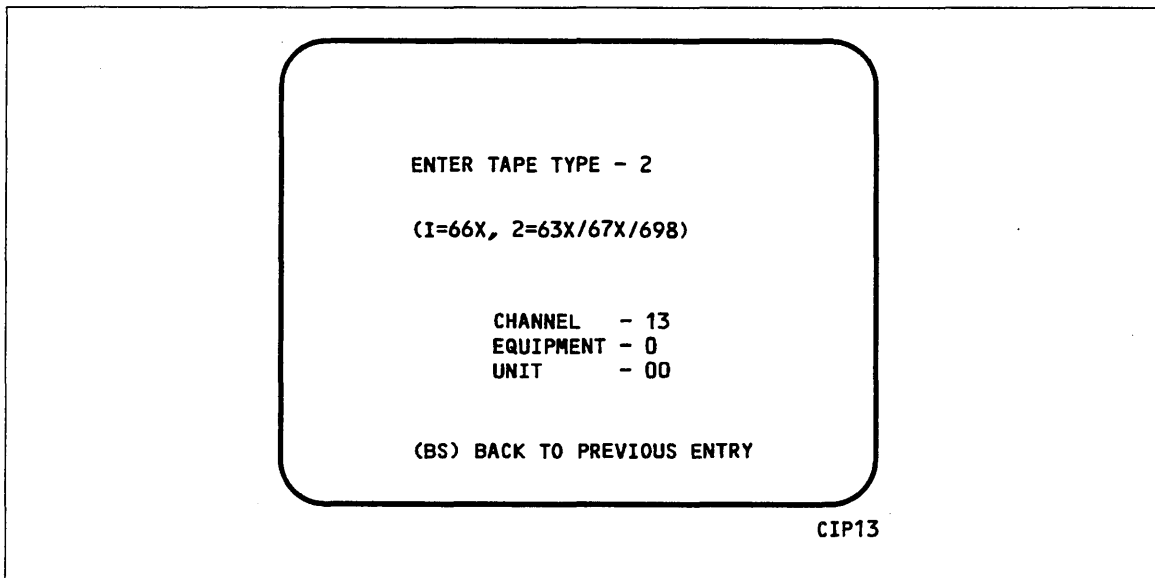

Figure 2-17. Path Select Display

14. This option is not available on I4Cn Class systems.

CIP Tape Deadstart Displays, I1n, I2n, and All I4n Class Systems

The CIP tape deadstart displays and options included in this subsection incorporate the following conventions.

- The first option listed on a menu display is the default option. The option can be selected automatically by pressing the carriage return key.
- Help information is provided for the INITIAL OPTIONS display. The HELP display supplies brief information about the options. More detailed option information is given elsewhere in this section.
- Pressing the backspace key allows you to return to the previous display.
- Simultaneously pressing the CTRL and F2 keys on the CC598B system console will return you to the CONSOLE MAIN MENU display.

Overview

Figures 2-18, 2-19, and 2-20 provide overviews of the displays and options available during a deadstart from CIP tape on I1n, I2n, and all I4n Class systems. Figure 2-20a provides an overview of displays for single IOU I4n Class systems, deadstart from tape on a CC598B system console. Figure 2-20b provides an overview of displays for dual IOU I4n Class systems, deadstart from tape on a CC598B system console.

Initial Options Display

The INITIAL OPTIONS display, figure 2-21, is the first screen that appears after the deadstart program is initiated. When the deadstart program is set for deadstart from the CIP tape, the INITIAL OPTIONS display provides utilities to install the CIP to the CIP device. A CIP tape deadstart also allows execution of several utilities from tape should the deadstart disk be unusable.

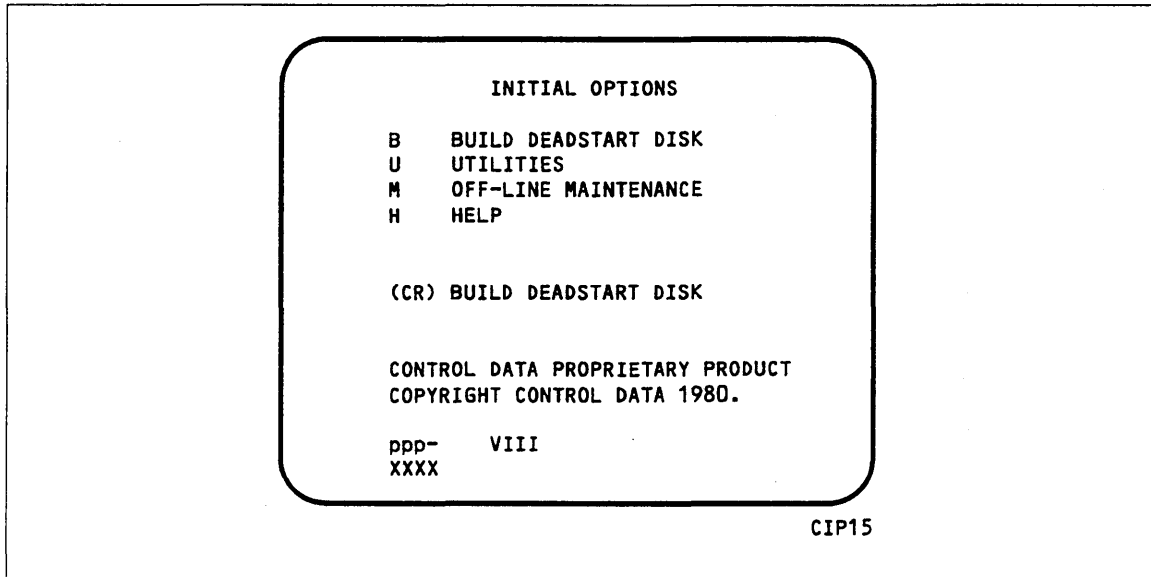

Figure 2-21. Initial Options From CIP Tape

Option	Description
(CR) or B	BUILD DEADSTART DISK. This option allows you to install CIP to the CIP device. The CIP modules must reside on the CIP device before an operating system deadstart can be performed. CIP modules are used to initialize the mainframe and establish the operating environment.

Refer to CIP Installation earlier in this section.

Option	Description
U	<p>UTILITIES. Select this option to:</p> <ul style="list-style-type: none"> • Perform EDD. • Perform a printer dump. • Deadstart from a different device. • Define and display default device parameters. • Display CIP component levels. • Initialize the mainframe after power interruption or maintenance activity. • Clear DEL. • Load the MDD in standalone mode. • Clear the central memory flaw table. • Clear the MRT. • Perform subsystem microcode load.

M OFF-LINE MAINTENANCE. This option is provided to enable you to execute hardware tests for preventive maintenance or hardware error diagnosis. Information about the option is included in the MSL 15X Reference manual.

The contents of word 12 of the deadstart program also affect the M option. Refer to Setting Word 12 in section 5 of this manual.

Execution of the hardware diagnostics from tape is much slower than from the CIP device. Use tape only when your deadstart disk is not usable.

NOTE

After executing this option, it will be necessary to select the INITIALIZE MAINFRAME in the UTILITIES display for proper OS loading to occur; if I1, I1CR or I2 IOU is present. Initialization is automatically selected with an I4 IOU.

H HELP for INITIAL OPTIONS display.

When the CC634B console is being used, press H or the HELP key for a description of the initial options.

The CIP version number, ppp- VIII, is displayed at the bottom of the INITIAL OPTIONS display, where ppp is mainframe type and III is CIP release level. At the very bottom of the display, xxxx is the PSR level.

Build Deadstart Disk Display

The BUILD DEADSTART DISK display, figure 2-22, for I1n Class systems and figure 2-23 for all other models appears when you select option B, BUILD DEADSTART DISK, from the INITIAL OPTIONS display. The BUILD DEADSTART DISK display is available only when you deadstart from the CIP tape. This display provides the options that install the CIP to the CIP device. Refer to CIP Installation, earlier in this section, for CIP installation procedures and displays.

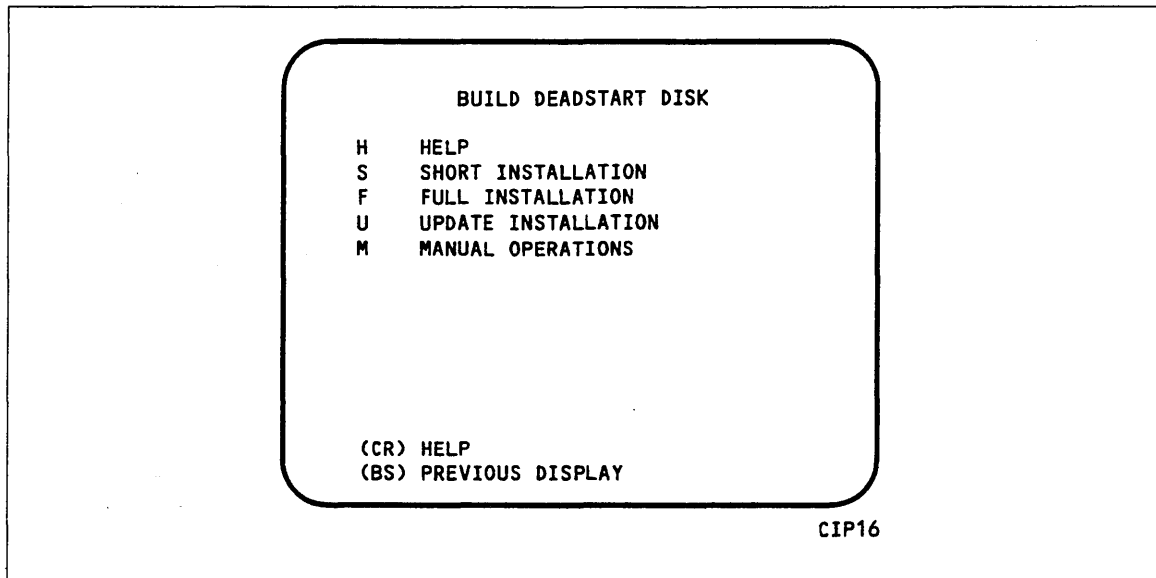

Figure 2-22. Build Deadstart Disk for I1n Class Systems

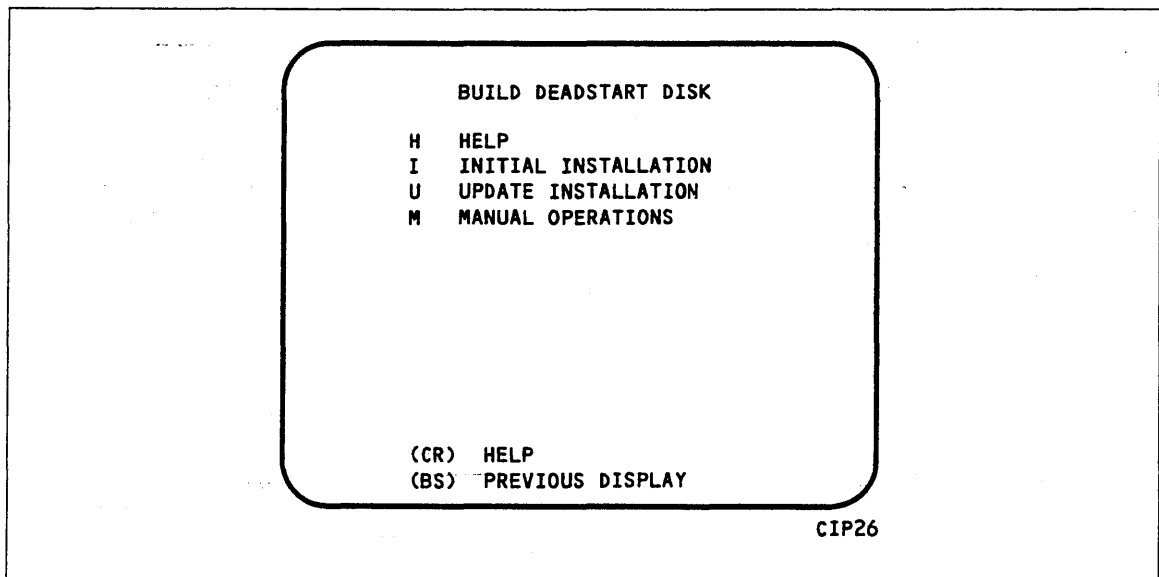

Figure 2-23. Build Deadstart Disk for I2n and All I4n Class Systems

Option	Description
(CR) or H	HELP for Build Option selection. When the CC634B console is being used, press H or the HELP key for a description of the build options.

CAUTION

The INITIAL INSTALLATION, FULL INSTALLATION, and SHORT INSTALLATION options destroy all information on the CIP device, except the disk microcode, before installing CIP. Before any S, F, I Installation, be sure you have a backup copy of any information on the CIP device that you want to preserve, including operating system permanent files and CE command buffers. After any S, F, I Installation, you must perform an operating system initialization of the CIP device.

I	INITIAL INSTALLATION. Select this option to initialize the CIP device and then install all of CIP to the CIP device.
F	FULL INSTALLATION. Select this option to initialize the CIP device and then install all of CIP to the CIP device. Execute either the short or full option when you install CIP for the first time.
S	The SHORT INSTALLATION option initializes the CIP device and installs most of CIP. The CIP tape contains off-line maintenance diagnostics that you use to execute mainframe tests for preventive maintenance or to diagnose a hardware error. The SHORT INSTALLATION option installs a predefined set of diagnostics (diagnostics you use frequently). Those used infrequently can be loaded and executed from the CIP tape when needed. The SHORT INSTALLATION option reserves 15 megabytes of disk storage for the CIP.
U	UPDATE INSTALLATION. Select this option to replace CIP on the CIP device some time after the short/full installation. The update option preserves operating system information on the CIP device.
M	MANUAL OPERATIONS. Select this option to perform emergency CIP component replacement at any time after CIP has been installed. Figure 2-24, the MANUAL OPERATIONS display, provides manual operation option selection.

Manual Operations Display

The MANUAL OPERATIONS display (figure 2-24) appears when you select option M, MANUAL OPERATIONS, from the BUILD DEADSTART DISK display. Manual operations are available only when you deadstart from the CIP tape.

Manual operations allow manual replacement of individual CIP components, which may be required in the event of a critical problem. Refer to Emergency CIP Repair Procedures in section 6 for repair and manual replacement procedures. More detailed information about manual operations is provided in the MSL 15X Reference manual.

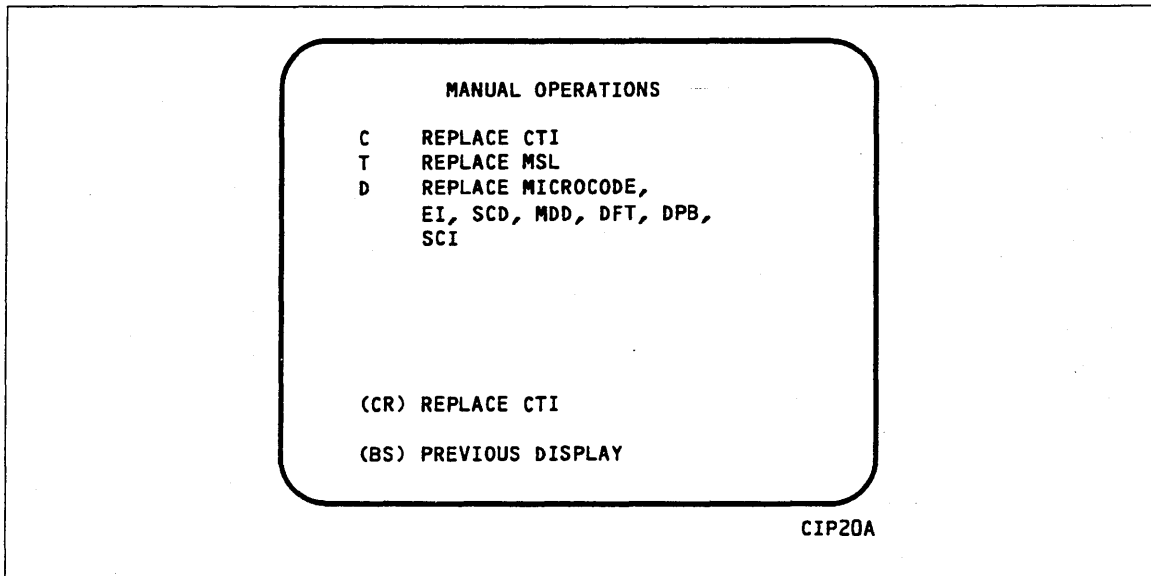

Figure 2-24. Manual Operations

Option	Description
(CR) or C	REPLACE CTI. Select this option to replace the CTI component of CIP to the CIP device.
NOTE	
This option also provides the capability to release CTI-MSL/HIVS/OS disk space. For detailed procedures, see Build Deadstart Disk Operations (All Systems, Excluding I4Cn Class Systems) in section 6.	
T	REPLACE MSL. Select this option to replace the MSL component of CIP on the CIP device.

Option	Description
D	REPLACE MICROCODE, EI, SCD, MDD, DFT, DPB, SCI, VE MODULES.

NOTE

Select this option only after an initial install has been performed.

Select this option to replace microcode, EI, the CC634B SCD, MDD, DFT, DPB, SCI, or the NOS/VE boot modules, or to initialize the CDA. When option D is selected, you are prompted to enter the disk channel and disk unit numbers. After you enter the channel and unit numbers or press the carriage return key (CR) to accept the default values shown, the REPLACE CTI/MSL DISK AREA MODULE display shown in figure 2-25 appears. Options A through H manually replace CIP modules in the Common Disk area on the CIP device.

Select option Y on the REPLACE CTI/MSL DISK AREA MODULE display to display the level numbers of the programs resident in the Common Disk area of the CIP device. If any module has been manually replaced, an asterisk appears by the module name on this display.

Select option Z to initialize the Common Disk area. This option will execute options A through H and will also initialize the following.

- The MRT which identifies the logical state of all mainframe elements. Any of these elements previously defined as logically "OFF" must be redesignated as such.
- The deadstart Error Log.

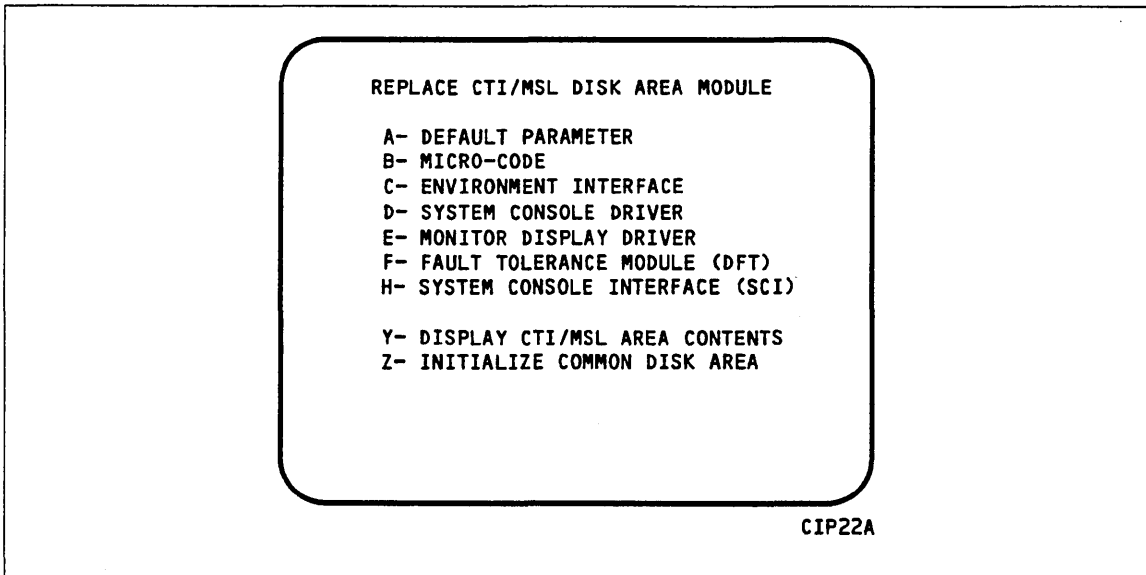

Figure 2-25. Replace CTI/MSL Disk Area Module

Utilities Display

Selecting the U option from the INITIAL OPTIONS display causes the UTILITIES display, figure 2-26, to appear.

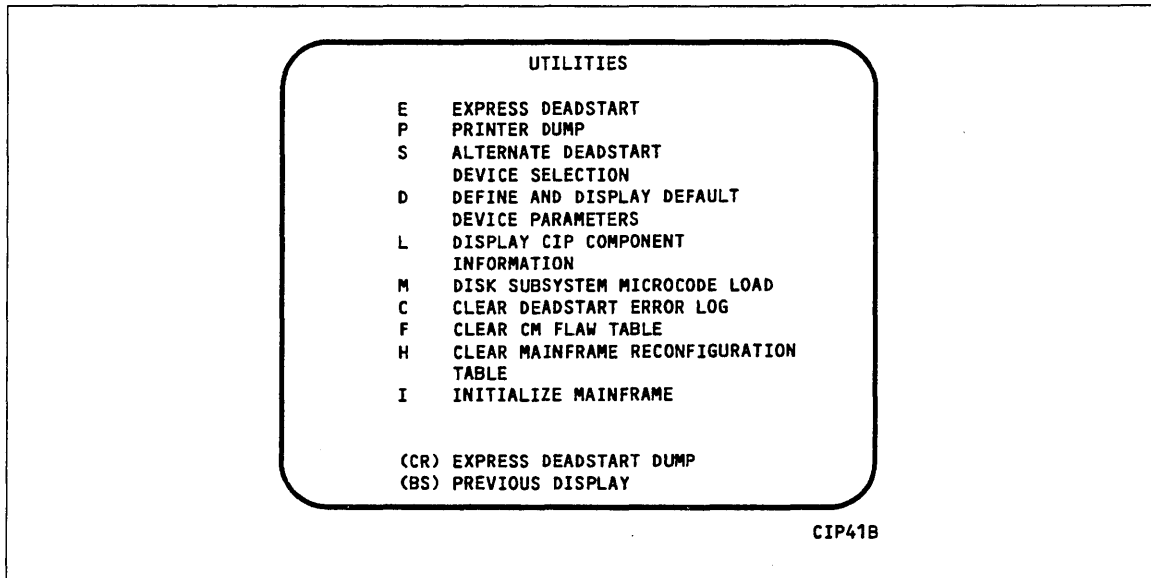

Figure 2-26. Utilities, Tape Deadstart

Option	Description
(CR) or E	EXPRESS DEADSTART DUMP. Select this option to dump to magnetic tape the contents of PP memories, central memory, unified extended memory, CPU hardware registers, maintenance registers, processor control store memories, and the tape and disk controlware. Refer to Performing an Express Deadstart Dump in section 6 for further information.
P	PRINTER DUMP. Select this option to dump central memory, PP memory, or maintenance register contents to a line printer. When you specify P, the appropriate DUMP TO PRINTER OPTIONS display, figure 2-27 or 2-28 (depending on your mainframe configuration) appears. You cannot return to the UTILITIES display from this display. You must redeadstart the system. Table 2-5 lists the keyboard entries for performing a printer dump. For more information refer to Performing a Printer Dump in section 6.

NOTE

When the E or P options are selected, CTI will check the error status of all the system elements. If errors are encountered, CTI will log the errors in the DEL. If the DEL is full, CTI will display the errors before allowing the deadstart to continue.

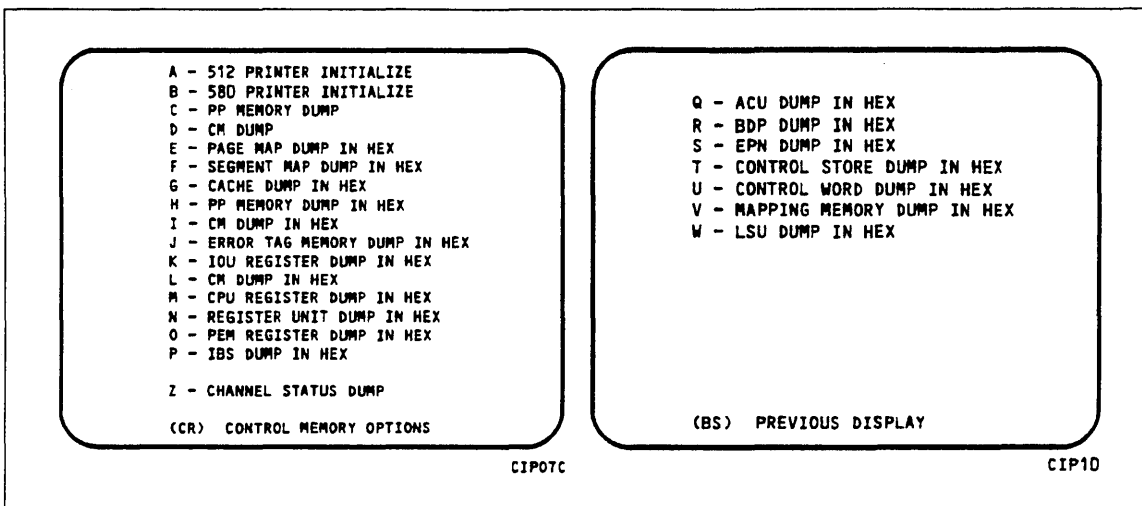

Figure 2-27. Dump to Printer Options for I4n 990 Class Systems, Tape

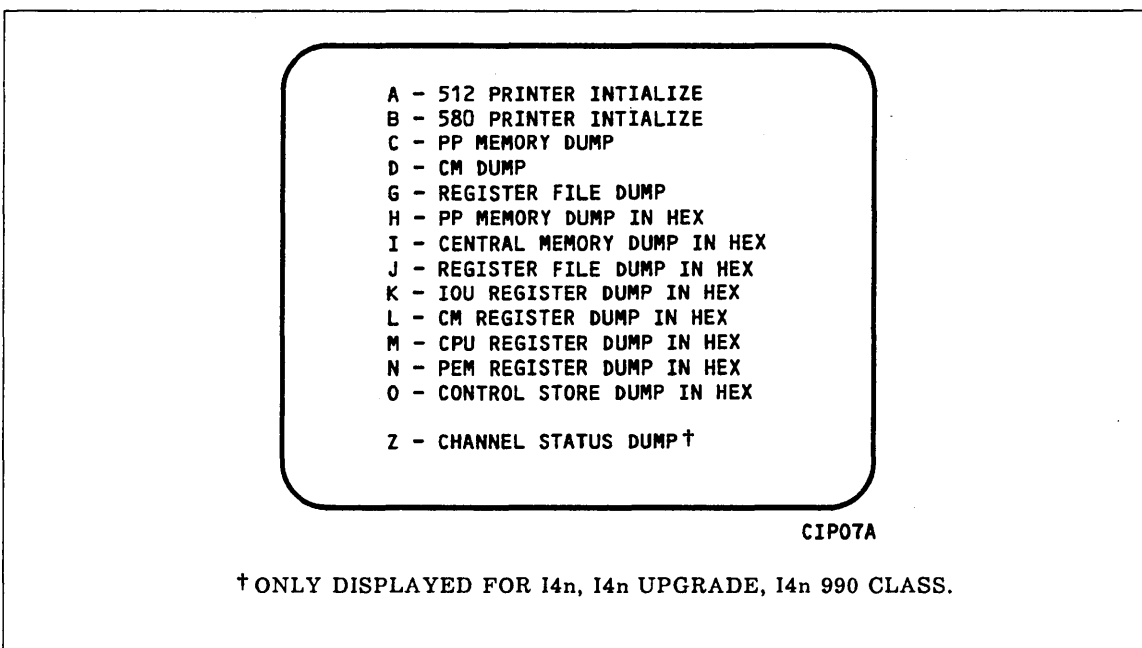

Figure 2-28. Dump to Printer Options for All CYBER Systems Except I4n 990 Class Systems, Tape

Table 2-5. Keyboard Entries for a Printer Dump, I1n, I2n, and All I4n Class Systems, Tape Deadstart

Entry	Function
A	512 PRINTER INITIALIZE. This option initializes the 512 printer image with the data necessary to print with a 512-1 print train.
B	580 PRINTER INITIALIZE. This option initializes the 580 printer buffer image and format buffer image memories.
C ¹	PP MEMORY DUMP. This option provides an octal dump to printer of 12-bit PP memories and 16-bit PP memories with their associated R registers. If the IOU is an I4, the associated P, Q, K, and A register values will also be dumped.
D	CM DUMP. This option provides an octal dump to printer of a selected area of central memory.
E	PAGE MAP DUMP IN HEX. This option provides a hexadecimal dump to the printer of the CPU Page Map.
F	SEGMENT MAP DUMP IN HEX. This option provides a hexadecimal dump to the printer of the CPU Segment Map.
G	CACHE DUMP IN HEX. This option provides a hexadecimal dump to the printer of the CPU Cache.
H	PP MEMORY DUMP IN HEX. This option provides a hexadecimal dump to the printer of the PP memories. If the IOU is an I4, the associated P, Q, K, and A register values will also be dumped.
I	CM DUMP IN HEX. This option provides a hexadecimal dump to the printer of a selected area of central memory.
J	REGISTER FILE DUMP IN HEX. This option provides a hexadecimal dump to the printer of the CPU register file contents.
J ²	ERROR TAG MEMORY DUMP IN HEX. This option provides a hexadecimal dump to the printer of the CPU Error Tag Memory contents.
K ¹	IOU REGISTER FILE DUMP IN HEX. This option provides a hexadecimal dump to the printer of the IOU maintenance register contents. If the IOU is an I4, the CIO registers will also be dumped, if installed.
L	CM REGISTER DUMP IN HEX. This option provides a hexadecimal dump to the printer of the contents of the central memory maintenance registers.

1. On multiple IOU systems, IOU0 only is supported.

2. I4n 990 Class systems only.

(Continued)

Table 2-5. Keyboard Entries for a Printer Dump, I1n, I2n, and All I4n Class Systems, Tape Deadstart (Continued)

Entry	Function
M	CPU REGISTER DUMP IN HEX. This option provides a hexadecimal dump to the printer of the contents of the CPU maintenance registers. Respond to the message CPU NO = by entering the number of the CPU for which registers are to be dumped. If microcode is not executing, the program dumps only the hardware maintenance registers. In place of the software registers, the following message appears on the printer dump: MICROCODE HUNG
N	PEM REGISTER DUMP IN HEX. This option provides a hexadecimal dump of the contents of the PEM registers.
N ¹	REGISTER UNIT DUMP IN HEX. This option provides a hexadecimal dump of the contents of associated registers.
O	CONTROL STORE DUMP IN HEX. This option provides a hexadecimal dump to the printer of the contents of control store. Respond to the message CPU NO = by entering the number of the CPU for which control store is to be dumped.
O ¹	PEM REGISTER DUMP IN HEX. This option provides a hexadecimal dump of the contents of the PEM registers.
P	IBS DUMP IN HEX. This option provides a hexadecimal dump to the printer of the CPU IBS contents.
Q	ACU DUMP IN HEX. This option provides a hexadecimal dump to the printer of the CPU ACU contents.
R	BDP DUMP IN HEX. This option provides a hexadecimal dump to the printer of the CPU BDP contents.
S	EPN DUMP IN HEX. This option provides a hexadecimal dump to the printer of the CPU EPN contents.
T	CONTROL STORE DUMP IN HEX. This option provides a hexadecimal dump to the printer of the contents of control store followed by a dump of shadow memory, if available.
U	CONTROL WORD DUMP IN HEX. This option provides a hexadecimal dump to the printer of CPU Control Word contents.

NOTE

For any of the CPU Dump options respond to the message CPU NO = by entering the number of the CPU for which registers are to be dumped.

1. I4n 990 Class systems only.

(Continued)

Table 2-5. Keyboard Entries for a Printer Dump, I1n, I2n, and All I4n Class Systems, Tape Deadstart (Continued)

Entry	Function
V	MAPPING MEMORY DUMP IN HEX. This option provides a hexadecimal dump to the printer of the CPU Mapping Memory control memory contents.
W	LSU DUMP IN HEX. This option provides a hexadecimal dump to the printer of the CPU LSU control memory contents.
Z	CHANNEL STATUS DUMP. This option, available on I4 IOUs only dumps the status of Parity Error Disable, Active, Full, Channel Flag, and Channel Error for NIO channels 00-31B and, if installed, CIO channels 00-11B. A "0" in the resulting output indicates the corresponding status flag is clear and a "1" indicates the status flag is set.

Option	Description
S	ALTERNATE DEADSTART. Select this option to specify an alternate CIP tape unit or disk device from which to deadstart. The ALTERNATE DEADSTART display, figure 2-29, appears.

DEADSTART DEVICE TYPE - 2

(1=66X, 2=63X/67X/698, 3=DISK)

CHANNEL - 13
EQUIPMENT - 0
UNIT - 00

(BS) BACK TO PREVIOUS ENTRY

CIPO8A

Figure 2-29. Alternate Deadstart

Enter the device type and press the carriage return key. The system then prompts you for channel, equipment, and unit numbers.

Default values are provided for the device parameters. The values are those specified in the default parameter block. The default parameter block is defined through option D, DEFINE AND DISPLAY DEFAULT DEVICE PARAMETERS.

Option	Description
	<p>After the device information is entered, press the carriage return key to deadstart from the alternate device.</p>
	<p>NOTE</p>
	<p>Alternate deadstart from operating system deadstart tapes is not supported for I1n, I2n, and all I4n Class systems. To load the operating system from a tape file, select option T, OPERATING SYSTEM FILE ON TAPE, from the OPERATOR INTERVENTION display.</p>
D	<p>DEFINE AND DISPLAY DEFAULT DEVICE PARAMETERS. Select this option to assign default values to the channel, equipment, and unit numbers of a CIP tape deadstart device, disk deadstart device, alternate disk deadstart device, tape dump (EDD) device, or printer dump device. Default values are initially assigned to the device parameters when CIP is installed.</p>
L	<p>DISPLAY CIP COMPONENT INFORMATION. Select this option to display the release levels of the CIP components: microcode, EI, SCD, MDD, SCI, DFT, NOS/VE programs, and the valid and invalid status of the DEL, CFT, VCU, and MRT. An asterisk identifies components that have been installed manually.</p>
I	<p>INITIALIZE MAINFRAME. Select this option to initialize the mainframe after power interruption or maintenance activity. The INITIAL OPTIONS display reappears with the following message on the bottom of the display:</p>
	<p style="padding-left: 40px;">ALL MAINFRAME MEMORIES WILL BE INITIALIZED FOR MSL/OS LOADS</p>
	<p>Mainframe initialization, including initialization of central memory, PP memory, and maintenance registers, occurs when you select this option and then perform either an operating system load on a level 0, 1, or 2 (not 3) deadstart or select the off-line maintenance option. Refer to Performing a Power-On Initialization in section 6 for procedures and additional information about this option.</p>
M ¹⁶	<p>DISK SUBSYSTEM MICROCODE LOAD. Select this option to load peripheral microcode into the 834/836, 844, 885, or 895 disk adapter and control module memory and install peripheral microcode onto specified drives. Refer to Loading and Installing Disk Subsystem Microcode From Tape in section 6 for procedures and additional information about this option.</p>
C	<p>CLEAR DEADSTART ERROR LOG. Select this option to clear the data in the DEL.</p>

16. Option not available on I4Cn Class systems.

Option	Description
F	CLEAR CM FLAW TABLE. Select this option to clear the data in the CM flaw table.
H	Clear mainframe reconfiguration table (MRT). Select this option to clear the mainframe reconfiguration table data stored on disk.

Clearing the MRT will cause the following items on the next Deadstart,

ALL MAINFRAME MEMORIES WILL
BE INITIALIZED FOR OS LOADS

CM/ESM RELOAD FROM EDD TAPE OPTION
WILL NOT BE AVAILABLE.

(CR) TO CONTINUE
(BS) BACKSPACE TO PREVIOUS DISPLAY

NOTE

Beginning with CIP Ver. 7, clearing the MRT forces a Memory Initialization by CTI. This was made necessary because with CM Reload, CTI no longer writes CM (EI and the CIP Directory) on Recovery Deadstarts. This requires that the first word address (FWA) of the CIP Buffer be maintained in the MRT.

CIP Tape-Related Deadstart Displays, I4Cn Class Systems

In the sense that all I4Cn Class system operating system deadstarts are executed from the internal disk of the CC598A system console (I4Cn CIP device), the only tape-related CIP function for this class of systems is the Install-Update CIP (IUC) system console utility. IUC options and displays described in this section incorporate the following conventions.

- The first option listed on a menu display is the default option; it can automatically be selected by pressing the Enter/Return key.
- Pressing the backspace key returns you to the previous display.
- Simultaneously pressing the Ctrl and F2 keys returns you to the CONSOLE MAIN MENU display.

Overview

IUC is a CC598A system console utility which installs or updates contents of the CIP tape onto the I4Cn Class system CIP device. IUC consists of the following.

- A disk driver which executes in PP1.
- A tape driver which executes in PP0.

IUC uses four directories (CTI, CDA, MSL, CB) on the CIP device for storage of CIP tape components. In addition IUC can perform the following operations:

- Initial installation:
 - Installs CTI components in the CTI directory.
 - Installs CDA components in the CDA directory.
 - Installs MSL components to the MSL directory.
 - Installs Command Buffers to the CB directory.
- Update installation:
 - Installs the entire contents of the CIP tape onto the CIP device, excluding programs in the CDA directory which must be carried over when performing an update operation.
- Manual installation:
 - Replacement of the MSL directory contents.
 - Replacement of the CTI directory contents.
 - Replacement of the CB directory contents.
 - Addition or replacement of programs in the CDA directory.
 - Addition or replacement of programs in the MSL directory.
 - Addition or replacement of programs in the CB directory.
 - Manual addition or replacement of programs in the CDA directory.
 - Manual installation of VE boot programs in the CDA directory.
 - Copying of MSL programs to tape.
 - Copying of command buffers to tape.

Figures 2-30 and 2-31 show the paths for execution of IUC on the CC598A system console for single and dual IOU I4Cn Class systems, respectively.

WARNING

Simultaneously pressing Ctrl and F2 during execution of IUC can result in an error as a file might be left open. If IUC is presently running and if it must be halted, terminate its execution by pressing the S key, followed by the Enter/Return key. Thereafter, you may simultaneously press Ctrl and F2.

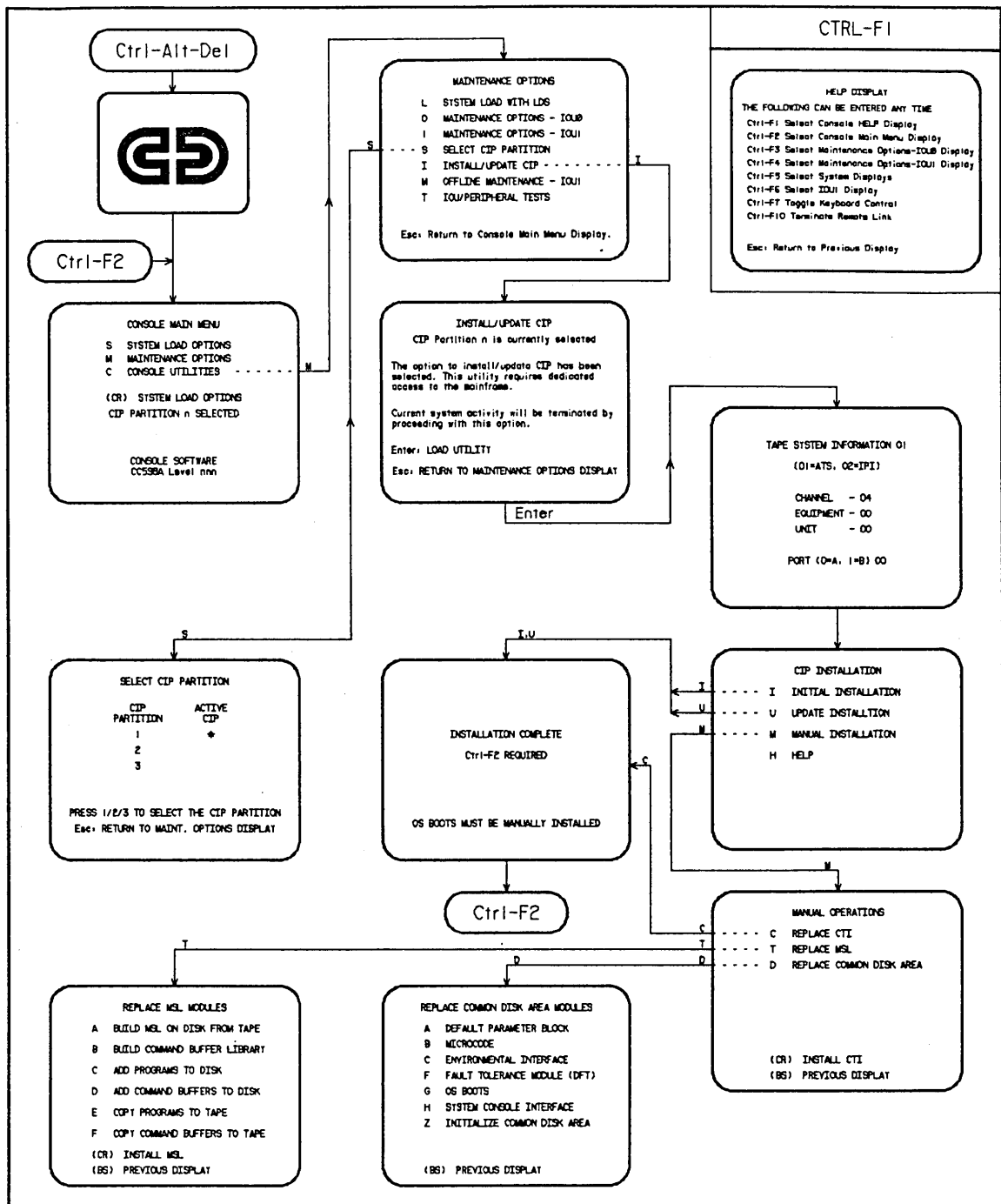

Figure 2-31. Overview of Displays for Dual IOU I4Cn Class Systems, CIP Tape-Related Deadstart Displays

Maintenance Options Display

From the CONSOLE MAIN MENU, enter M to bring up the MAINTENANCE OPTIONS menu. If your system has a single IOU, the MAINTENANCE OPTIONS menu shown in figure 2-32 will appear. If your system has a dual IOU, the MAINTENANCE OPTIONS menu shown in figure 2-33 will appear.

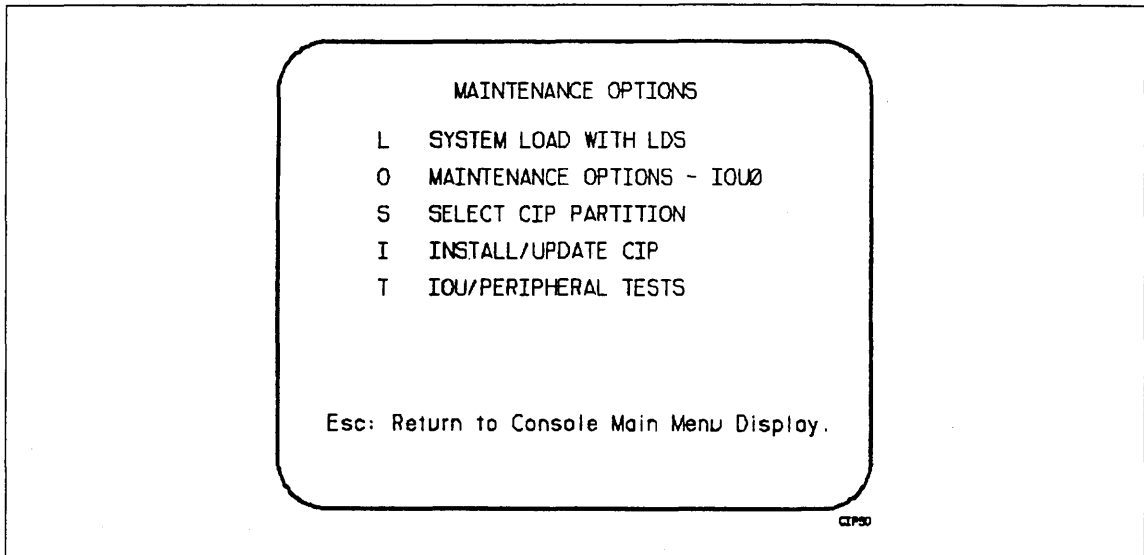

Figure 2-32. Maintenance Options - Single IOU

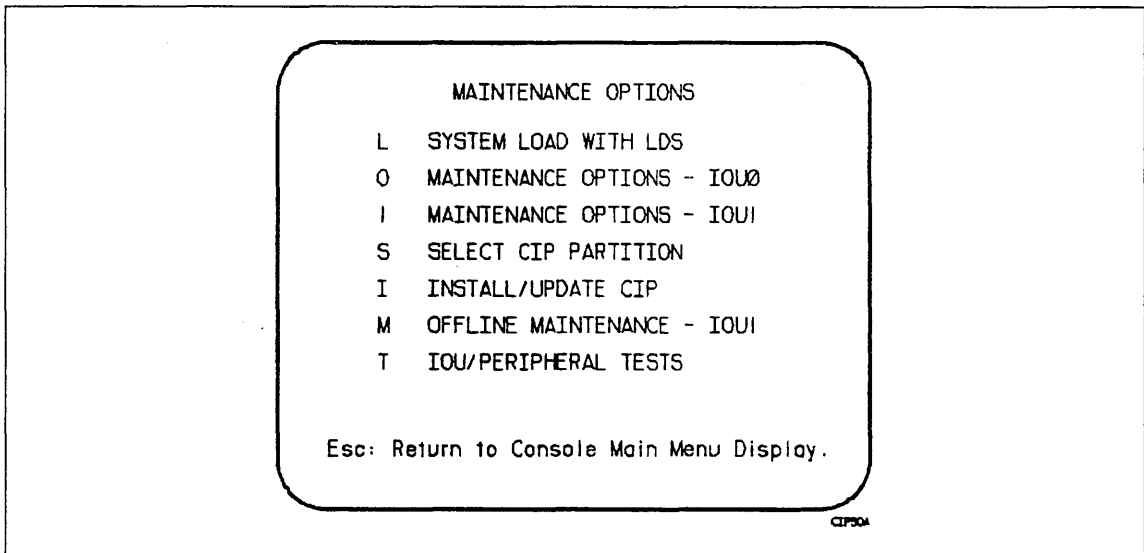

Figure 2-33. Maintenance Options - Dual IOU

Maintenance

Option	Description
L	The SYSTEM LOAD WITH LDS option brings up a dynamic ¹⁷ MAINTENANCE OPTION display as shown in figure 2-34.
O	The MAINTENANCE OPTION - IOU0 option brings up a static MAINTENANCE OPTION display (refer to figure 2-35).
1	The MAINTENANCE OPTION - IOU1 option brings up a static MAINTENANCE OPTION display (refer to figure 2-35; dual IOU systems only).
S	The SELECT CIP PARTITION option toggles between one of three CIP partitions. Enter 1, 2, or 3 to select the desired partition and simultaneously press Ctrl and F2 to return to the CONSOLE MAIN MENU display. If the desired partition is already active, ¹⁸ press ESC; refer to figure 2-36. The selected CIP partition will remain selected until changed by the user.
NOTE	
If the TPM (IOU) board is pulled after power has been removed from the CC598A console, the CIP partition selection will default to 1. Merely powering down the IOU, without removing the TPM board, however, has no effect on the CIP partition selection.	
I	The INSTALL/UPDATE CIP option brings up the intermediate INSTALL/UPDATE CIP display shown in figure 2-37. Pressing the enter key, while the intermediate display is shown, will load IUC. You will then be queried for tape system information. After satisfying all tape system information requests, the CIP INSTALLATION display shown in figure 2-38 will appear.
M	The OFFLINE MAINTENANCE IOU1 option will perform offline maintenance tasks on IOU1 (dual IOU systems only).
T	The IOU/PERIPHERAL TESTS option brings up the display shown in figure 2-42.

17. Registers located in the upper right-hand quadrant of this display will change on your console.

18. The active CIP partition will be marked with an asterisk (*).

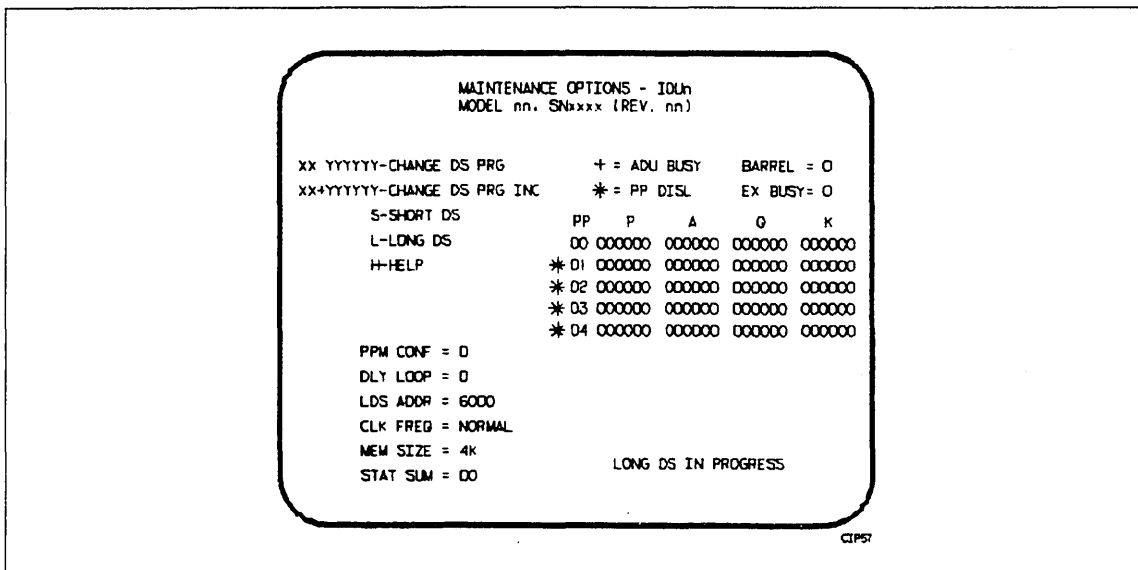

Figure 2-34. Maintenance Options (System Load With LDS)

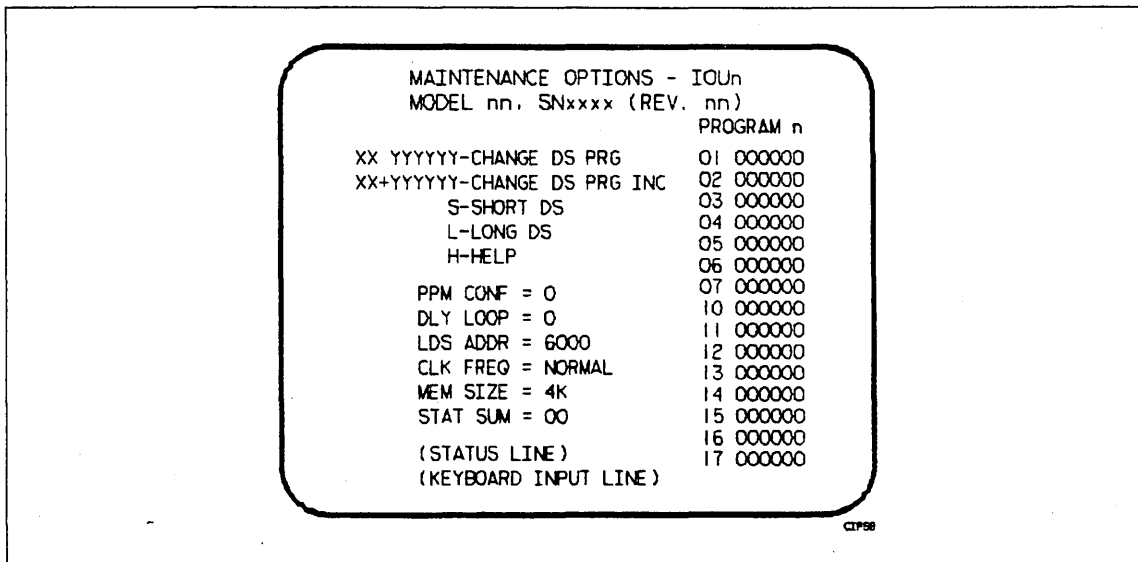

Figure 2-35. Maintenance Options - IOU0

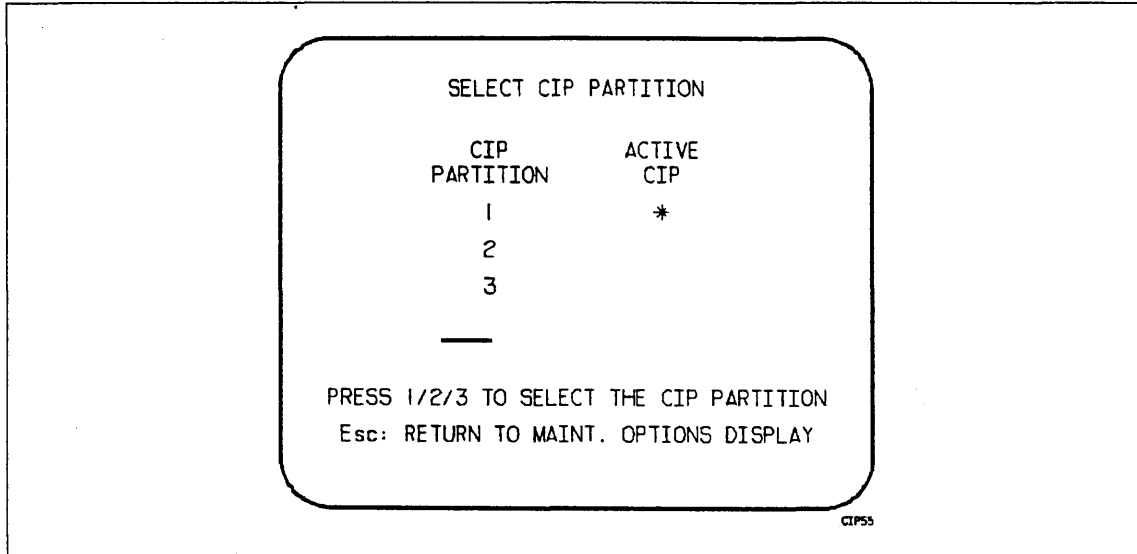

Figure 2-36. Select CIP Partition

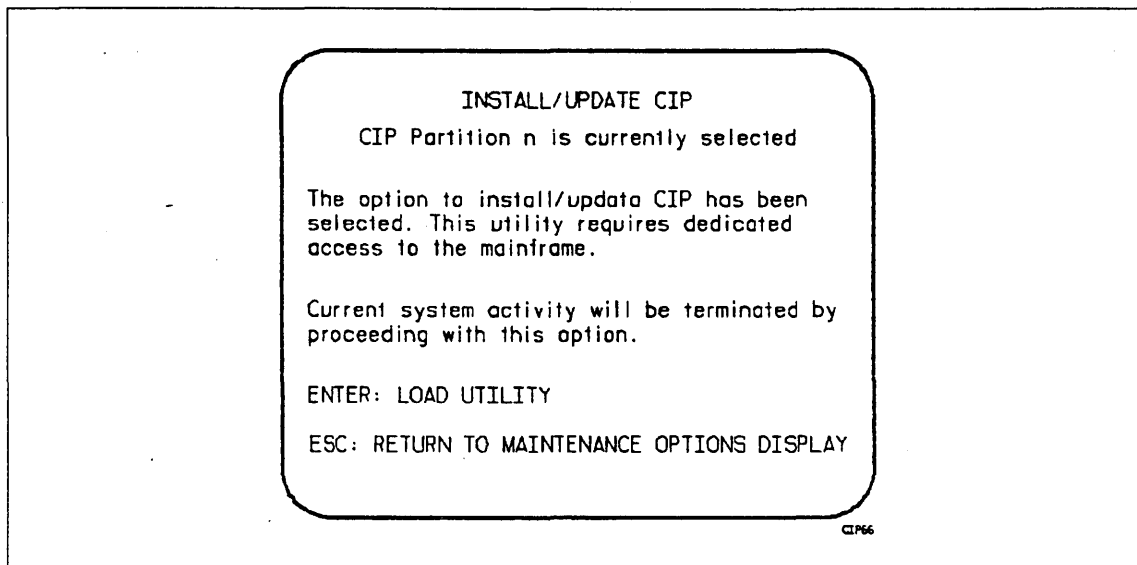

Figure 2-37. Intermediate IUC Display

Load IUC by selecting option I from the MAINTENANCE OPTIONS display. After answering prompts in regard to system configuration, the CIP INSTALLATION display (figure 2-38) will appear.

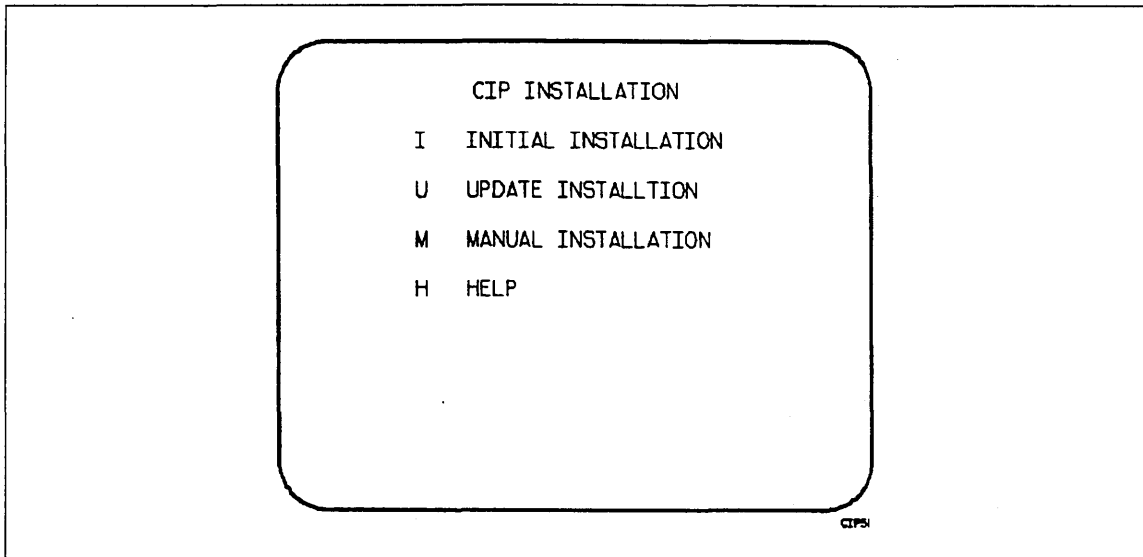

Figure 2-38. CIP Installation

**CIP
Installation
Option**

Description

I	The INITIAL INSTALLATION option installs the entire contents of the CIP tape onto the CIP device. When this option is selected, the previous contents of all four CIP device directories are destroyed. Refer to CIP Installation, I4Cn Class Systems earlier in this section.
U	The UPDATE INSTALLATION option installs the entire contents of the CIP tape onto the CIP device, excluding those programs in the CDA directory which must be carried over when performing an update operation. With the exception of the CDA directory, the contents of all CIP device directories are destroyed.
M	The MANUAL INSTALLATION option allows IUC to perform manual operations which involve each of the four CIP device directories. The display shown in figure 2-39 is presented.
H	The HELP option presents a brief description of the I, U, and M options.

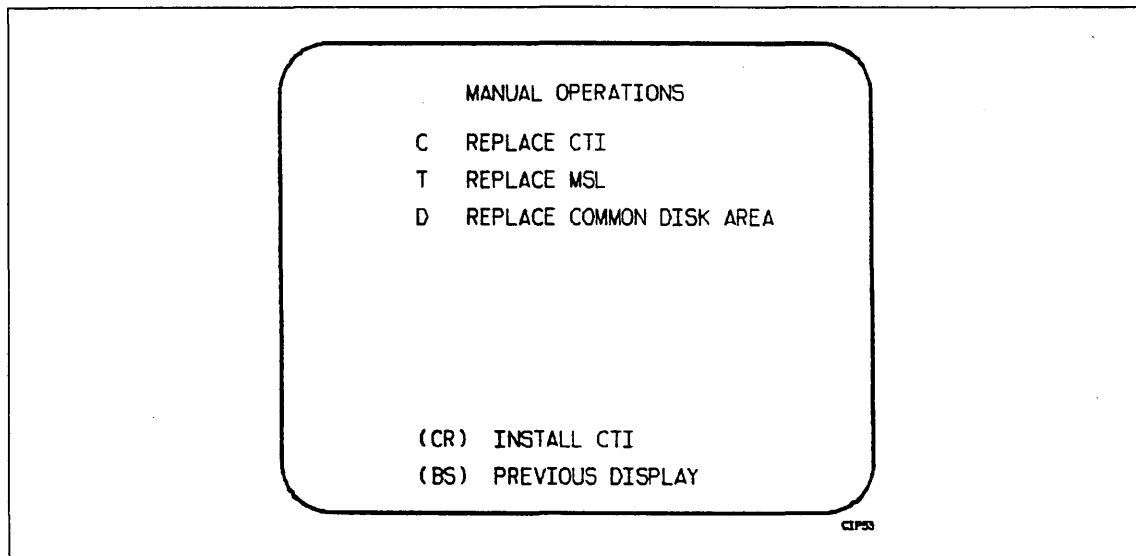

Figure 2-39. Manual Operations

Manual Operations

Option	Description
C	The REPLACE CTI option installs the entire contents of the mounted tape into the CTI directory of the CIP device. All previous contents within the CTI directory are destroyed.
T	The REPLACE MSL option allows IUC to enter data into the MSL directory of the CIP device and to transfer programs from tape to the CIP device. Refer to figure 2-40 for the REPLACE MSL display.
D	The REPLACE COMMON DISK AREA option allows you to add or replace programs in the CDA directory of the CIP device. This option is also capable of initializing the CDA. Refer to figure 2-41 for the REPLACE COMMON DISK AREA display.
(CR)	Pressing the Enter/Return key once will select the default option (option C).

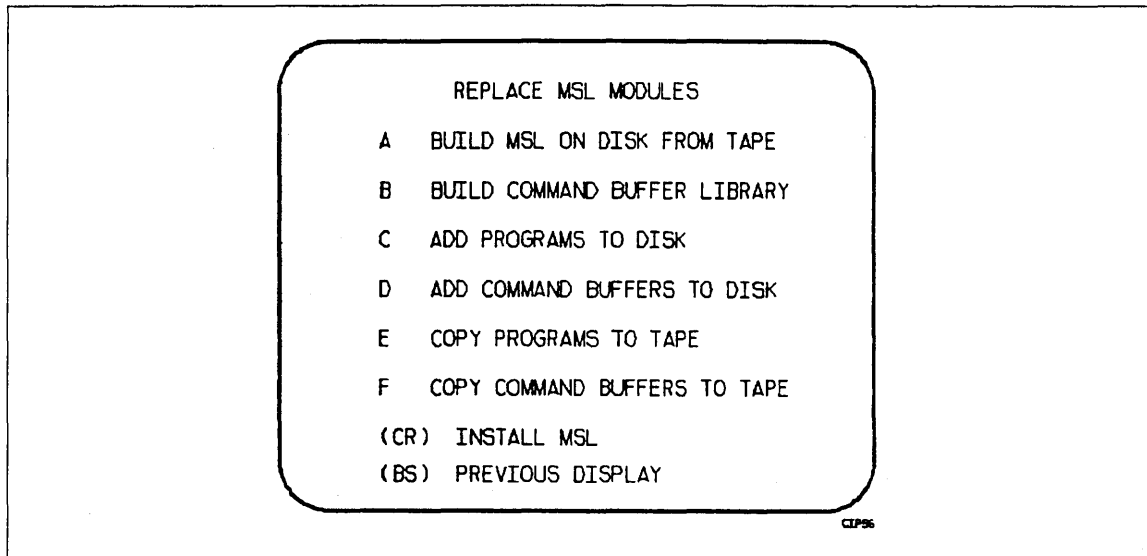

Figure 2-40. Replace MSL

**Replace
MSL
Option**

Description

A	The BUILD MSL ON DISK FROM TAPE option allows IUC to transfer MSL files/programs to the MSL directory of the CIP device. Previous contents of the MSL directory are destroyed.
B	The BUILD COMMAND BUFFER LIBRARY option allows IUC to transfer MSL files/command buffers to the CB directory of the CIP device. Previous contents of the CB directory are destroyed.
C	The ADD PROGRAMS TO DISK option allows you to add programs to the MSL directory of the CIP device.
D	The ADD COMMAND BUFFERS TO DISK option allows you to add command buffers to the MSL directory of the CIP device.
E	The COPY PROGRAMS TO TAPE option allows you to copy selected MSL programs to tape.
F	The COPY COMMAND BUFFERS TO TAPE option allows you to copy selected command buffers to tape.
(CR)	Pressing the Enter/Return key once will select the default option (option A).

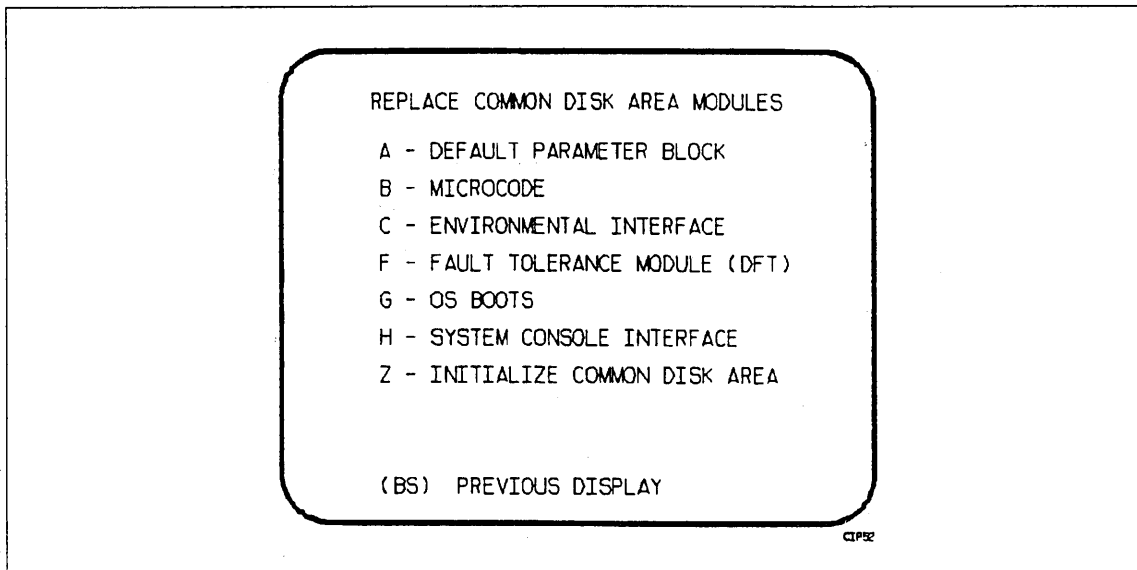

Figure 2-41. Replace Common Disk Area

Replace CDA Option	Description
A	The DEFAULT PARAMETER BLOCK option adds or replaces an existing copy of the program DPB in the CDA directory of the CIP device. DPB is read from the currently assigned tape.
B	The MICROCODE option adds or replaces the existing copies of the peripheral and product set microcode in the CDA directory; microcode in the MSL directory is not replaced.
C	The ENVIRONMENT INTERFACE option adds or replaces the existing copy of the program EI in the CDA directory of the CIP device. EI is read from the currently assigned tape.
F	The FAULT TOLERANCE MODULE option adds or replaces DFT modules in the CDA directory of the CIP device. The required program is read from the currently assigned tape.
G	The OS BOOTS option adds or replaces existing copies of the VE boot programs within the CDA directory, from either the OS deadstart tape or from the CIP tape.
H	The SYSTEM CONSOLE INTERFACE option adds or replaces the existing copy of SCI within the CDA directory of the CIP device, from either the OS deadstart tape or from the CIP tape.
Z	The INITIALIZE COMMON DISK AREA option initializes the CDA directory. All previous programs in the directory are destroyed and the directory is rebuilt exactly as during an initial build. VE boots are not installed.

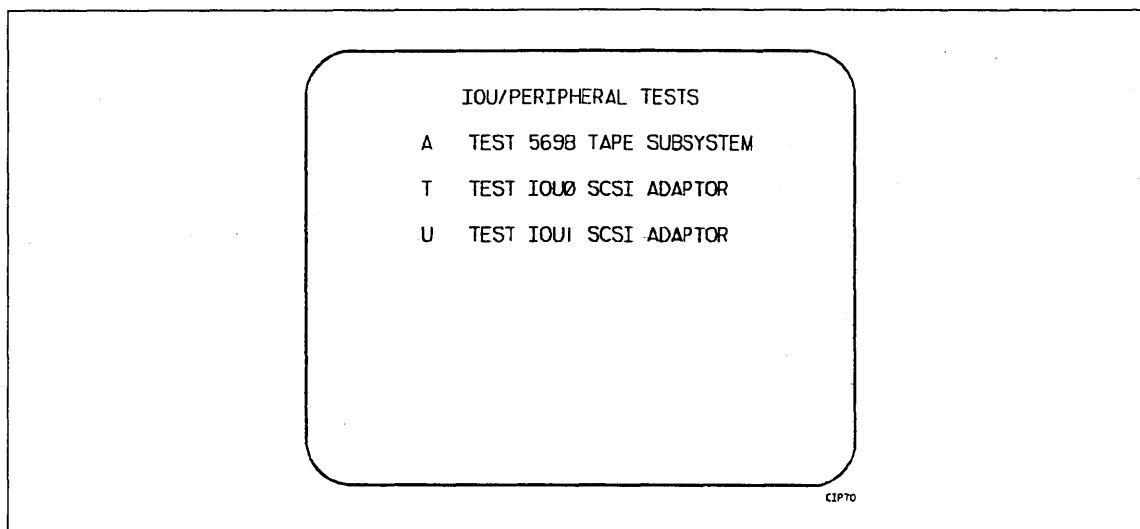

Figure 2-42. IOU/Peripheral Tests

**IOU/
Peripheral
Tests**

Option	Description
A	The TEST 5698 TAPE SUBSYSTEM option loads and executes the IT4 tape subsystem test. ¹⁹
T	The TEST IOU0 SCSI ADAPTOR option loads and executes the SAT4 test ²⁰ of the IOU0 SCSI. ²¹
U	The TEST IOU1 SCSI ADAPTOR option loads and executes the SAT4 test ²⁰ of the IOU1 SCSI ²¹ (dual IOU systems only).

19. For more information on the IT4 test, refer to the System Peripheral Diagnostics Reference Manual (60000144).

20. For information on the SAT4 test, refer to MSL 153/155, CYBER 96X Maintenance Software Reference Manual Test Procedures and Test Descriptions manuals (60461110 and 60461920, respectively).

21. IUC interfaces to the CC598A system console disk (I4Cn CIP device) via the SCSI channel.

CIP Procedures, Displays, and Options for CYBER 170/170M Models 865 and 875

3

CIP Installation, Models 865 and 875	3-3
OS Deadstart, Models 865 and 875	3-5
Disk Deadstart	3-5
Operating System File on Disk	3-5
Operating System File on Tape or Alternate Disk	3-6
Disk Deadstart Displays, Models 865 and 875	3-7
Overview	3-7
Initial Options Display	3-11
Operator Intervention Display	3-13
Utilities Display	3-20
CIP Tape Deadstart Displays, Models 865 - 875	3-25
Overview	3-25
Initial Options Display	3-29
Build Deadstart Disk Display	3-31
Manual Operations Display	3-32
Utilities Display	3-33



CIP Procedures, Displays, and Options for CYBER 170/170M Models 865 and 875 3

This section includes automatic CIP installation procedures, operating system deadstart procedures, and descriptions of CIP displays and options available to users of CYBER 170 models 865 and 875 and CYBER 170M model 875.

CIP Installation, Models 865 and 875

The CIP modules must be installed to disk for models 865 and 875. Select a disk unit in your configuration to be the deadstart disk. The installation process installs the CIP modules to the deadstart disk so that operating system information may also reside on the disk.

Use the following procedure to install CIP to the disk or to update CIP on the deadstart disk. The installation procedure requires dedicated machine time. At least one tape drive and one disk unit must be available. The procedure assumes that controlware has been loaded into the peripheral controller(s). If the controlware is not loaded, refer to section 5 for coldstart instruction.

1. Mount the CIP tape on a tape drive.
2. Set the deadstart program for a deadstart from the CIP tape. Refer to section 5.
3. Press the DEADSTART button. The INITIAL OPTIONS display appears.
4. Press the carriage return key to select the default option, BUILD DEADSTART DISK. The BUILD DEADSTART DISK display appears.

CAUTION

Do not proceed until you have read all the instructions for step 5.

5. For first time installation of the CIP tape select I, INITIAL INSTALLATION option, which initializes the deadstart disk and installs CIP. The INITIAL INSTALLATION option reserves 20 megabytes of disk storage for CIP.

NOTE

The INITIAL INSTALLATION option destroys all information on the deadstart disk, except the disk microcode, prior to installing CIP. Before executing the INITIAL INSTALLATION option, be sure you have a backup copy of any information on the deadstart disk that you want to preserve, including operating system permanent files and CE command buffers. After executing the INITIAL INSTALLATION option, you must perform an operating system initialization of the disk.

For installation of CIP some time after the initial installation, enter U to select the UPDATE option. The UPDATE option replaces CIP on the deadstart disk and preserves operating system information on the deadstart disk, including permanent files.

The CIP modules replaced during an update are:

CTI
MSL (includes command buffers)

Information saved during an update includes:

Default parameter block
Operating system pointers and permanent files

6. Enter the channel, equipment, and unit numbers of the deadstart disk when prompted. Follow each entry by pressing the carriage return key. Press only the carriage return key to select the displayed default value.
7. CIP installation is complete when the message `INSTALLATION COMPLETE` appears. You can now perform an operating system load, off-line maintenance, DPB definition, or other deadstart utility operation. Refer to section 6.

OS Deadstart, Models 865 and 875

An operating system deadstart can be performed on models 865 and 875 only when CIP has been installed on disk. Operating system tape deadstart is not supported for model 800 computer systems. Operating system load from a tape file, however, is supported for model 800 computer systems through the disk deadstart process.

The operating system deadstart procedures require at least one disk unit and, when the operating system file is on tape, one tape unit. The procedures assume that controlware has been loaded into the peripheral controller(s). If the controlware is not loaded, refer to section 5 for coldstart instruction.

Disk Deadstart

This procedure assumes that:

- The deadstart program is set for deadstart from disk.
- CIP has been installed to disk. Refer to CIP Installation earlier in this section.

If the operating system file has also been installed to disk, a complete disk deadstart can be performed. Refer to the NOS 2 Analysis Handbook, INSTALL command, to find out how to install the NOS file to disk. The NOS/BE level 0 deadstart process automatically installs the NOS/BE file on disk for use on the following deadstarts.

Operating System File on Disk

1. Press the DEADSTART button to initiate deadstart. The INITIAL OPTIONS display appears.
2. Press the carriage return key to select the default option, AUTOMATIC OS LOAD. The automatic option assumes that the deadstart program is set correctly on the deadstart panel for deadstart level (0, 1, 2, 3) and for CMRDECK selection (NOS) or for CMR selection (NOS/BE).
If the deadstart program is set correctly, operating system deadstart is initiated.
3. If the deadstart program is not set correctly for these selections, enter O to select the OPERATOR INTERVENTION option. Operator intervention also allows reconfiguration of mainframe hardware components and execution of the hardware verification sequences. For specific information regarding operator intervention, refer to the displays and options for deadstart from disk later in this section.

Operating System File on Tape or Alternate Disk

1. Press the DEADSTART button to initiate deadstart. The INITIAL OPTIONS display appears.
2. Enter O to select the OPERATOR INTERVENTION option. The OPERATOR INTERVENTION display appears.
3. If the deadstart program is not set correctly for deadstart level and for CMRDECK selection (NOS) or CMR selection (NOS/BE), enter P to select the DEADSTART PANEL PARAMETERS option, before proceeding. Operator intervention also allows reconfiguration of the mainframe hardware components and execution of hardware verification sequences. For specific information regarding operator intervention, refer to the displays and options for deadstart from disk later in this section.
4. Enter S to select tape or alternate disk.
 - a. Tape Deadstart
 1. Enter T to deadstart using a tape.
 2. Enter tape type, channel, equipment, and unit when prompted.
 - b. Alternate Disk Deadstart
 1. Enter D to select alternate disk deadstart.
 2. Enter disk channel, equipment, and unit when prompted.
5. Press the carriage return key. Operating system deadstart is initiated.
6. You will see messages indicating that NOS or NOS/BE is loading programs or running tests.

Disk Deadstart Displays, Models 865 and 875

The CIP disk deadstart displays and options included in this subsection incorporate the following conventions.

- The first option listed on a menu display is the default option. The option can be selected automatically by pressing the carriage return key.
- Help information is provided for the INITIAL OPTIONS display. The HELP display supplies brief information about the options. More detailed option information is given elsewhere in this section.
- Pressing the backspace key allows you to return to the previous display.

Overview

Figure 3-1 provides an overview of the displays and options available during a deadstart from disk on models 865 and 875.

Initial Options Display

The INITIAL OPTIONS display, figure 3-2, always appears first when a deadstart is initiated.

When the deadstart program is set for deadstart from disk, the INITIAL OPTIONS display provides operating system load, execution of off-line maintenance, and deadstart utilities.

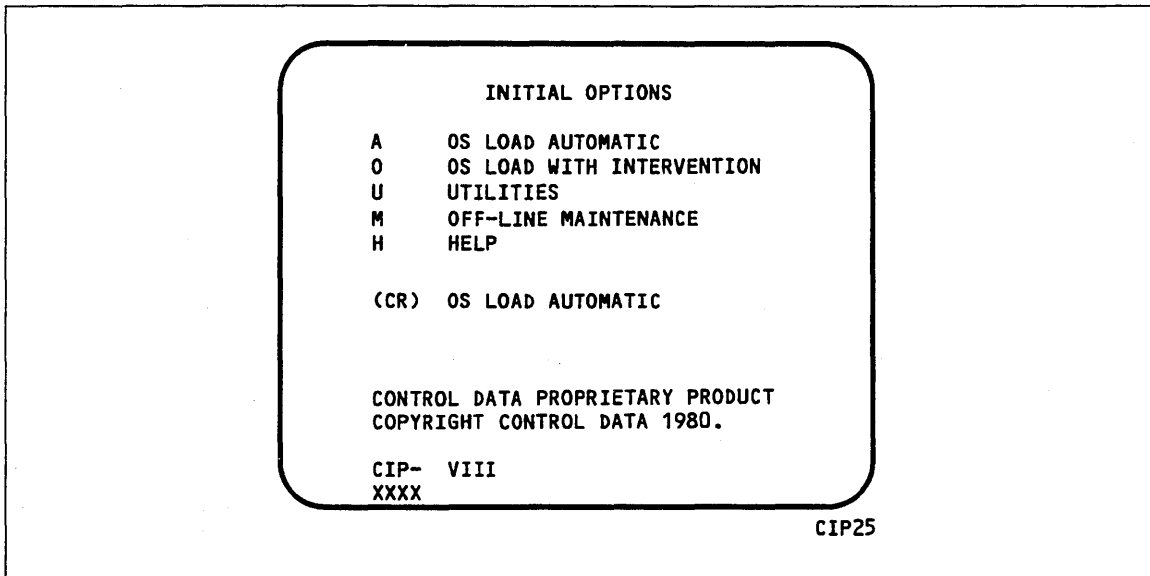

Figure 3-2. Initial Options From Disk

Option	Description
--------	-------------

(CR) or A	OS LOAD AUTOMATIC. Select this option to load the operating system with no intervention on your part.
--------------	---

Before CIP transfers deadstart to the operating system, confidence tests verify the ability of PP memory to hold simple data patterns and preset PP memory contents to all ones.

If the system detects a fatal error during confidence testing, the following information appears.

DEADSTART ABORTED - FATAL ERROR

```

MR-0-2   yyyy yyyy yyyy yyyy yyyy
MR-0-1   yyyy yyyy yyyy yyyy yyyy
MR-0-0   yyyy yyyy yyyy yyyy yyyy
    
```

yyyy is the contents of a word in the maintenance register, word 16 is the upper left word, and word 0 is the lower right word. A text explanation of the error appears below the register contents. Inform a CE.

Option	Description
O	OS LOAD WITH INTERVENTION. Select this option to execute the hardware verification sequences, to reconfigure mainframe hardware components, or to change the operating system deadstart level or CMRDECK selection specified in the deadstart program. Refer to the OPERATOR INTERVENTION display, figure 3-3, later in this section for more information.
U	UTILITIES. Select this option to: <ul style="list-style-type: none">• Perform EDD.• Perform a printer dump.• Deadstart from a different device.• Define DPB.• Display CIP component information.• Initialize external memory (ESM) after power interruption or maintenance activity. Refer to the UTILITIES display, figure 3-7, later in this section for more information.
M	OFF-LINE MAINTENANCE. This option enables you to execute hardware tests for preventive maintenance or hardware error diagnosis. Information about the option is included in the MSL 140 Reference manual. The contents of word 12 of the deadstart program also affect the M option. Refer to Setting Word 12 in section 5.
H	HELP for INITIAL OPTIONS display.

The CIP version number, CIP- VIII, is displayed at the bottom of the INITIAL OPTIONS display. At the bottom of the display, xxxx is the PSR level.

Operator Intervention Display

The OPERATOR INTERVENTION display, figure 3-3, appears when option O, OPERATOR INTERVENTION, is selected at the INITIAL OPTIONS display.

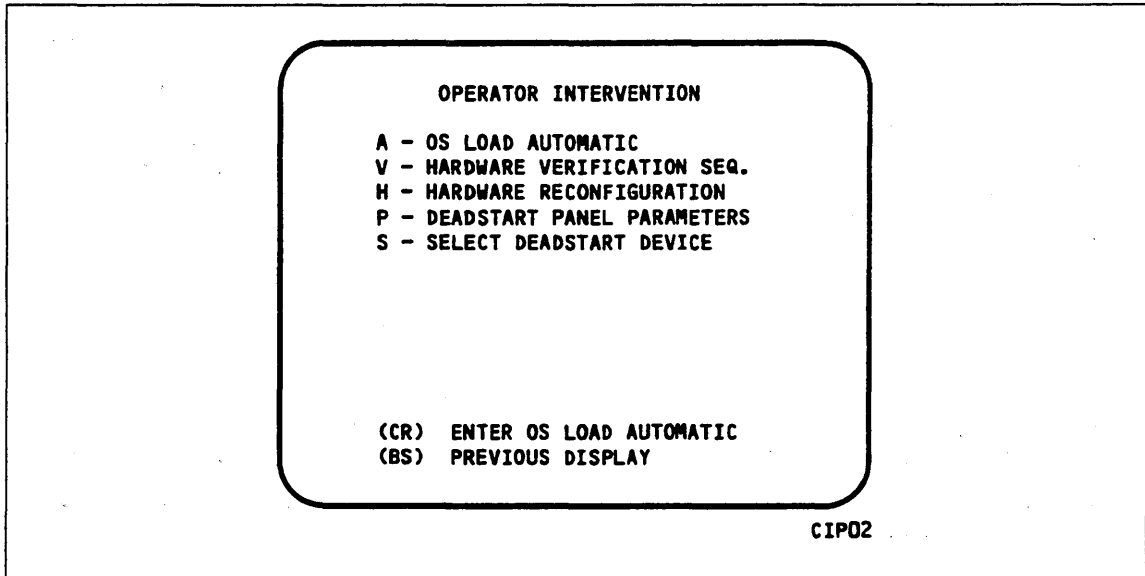

Figure 3-3. Operator Intervention

Option	Description
(CR) or A	OS LOAD AUTOMATIC. Select this option to perform an operating system load. Refer to the description of the OS LOAD AUTOMATIC option on the INITIAL OPTIONS display earlier in this section for more information.
V	HARDWARE VERIFICATION sequence. Select this option to execute PP, CM, and CPU confidence tests. If you have selected either a level 0, 1, or 2 deadstart, central memory contents are changed when you execute this option. The V option cannot be executed if a level 3 deadstart is selected. You cannot test hardware that has been turned off via the HARDWARE RECONFIGURATION option. The names of the tests HIVS executes for the models 865 and 875 are CMC7, CT77, EJP, MY17, and PCX7. Appendix E includes a brief description of each test.

Option	Description
--------	-------------

If an error condition occurs, one of the following messages appears.

```

ERROR PP xx
ERROR CM
ERROR CPU xx
ERROR EM
ERROR REG
MAINT.REG ERROR yyyy
    
```

xx indicates the PP, or CPU in error. Contact a CE.

yyyy indicates a maintenance register word 0 error. If the error is fatal, the system displays it on a subsequent deadstart. Contact a CE.

Upon successful test completion, the system displays:

```

TESTING COMPLETE-DEADSTART
    
```

Initiate deadstart after testing to ensure that the system is returned to initial deadstart condition prior to system loading or recovery.

H **HARDWARE RECONFIGURATION.** Select this option to alter the mainframe hardware configuration. When selected, the display in figure 3-4 appears.

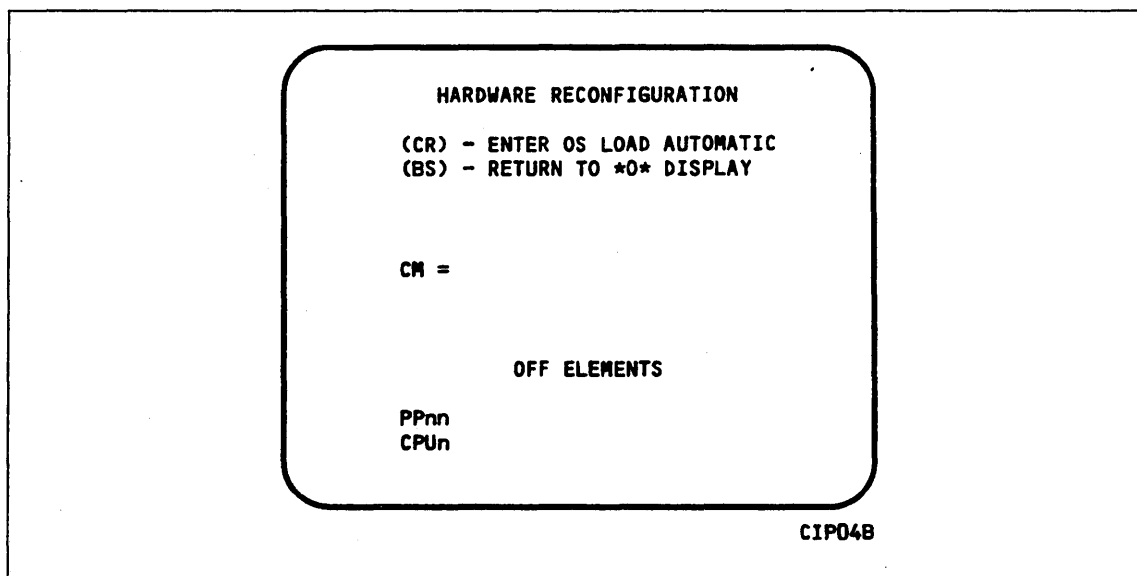

Figure 3-4. Hardware Reconfiguration

The default hardware configuration includes every hardware element available for use. To change the hardware configuration, enter the appropriate entry as described in table 3-1. When you turn off an element, its identifier is added to the OFF ELEMENTS list on the display. Entries are in the form keyword=option.

Table 3-1. Hardware Reconfiguration Entries, Models 865 and 875

Keyword	Option	Function														
CM=	nnnnnnn	Specifies the size, in octal, of central memory in hundreds of words. The following examples show the value you enter for nnnnnnn, given the central memory size.														
		<table border="1"> <thead> <tr> <th>Central Memory Size in 60-bit Decimal Words</th> <th>nnnnnnn</th> </tr> </thead> <tbody> <tr> <td>98K</td> <td>3000</td> </tr> <tr> <td>262K</td> <td>10000</td> </tr> <tr> <td>524K</td> <td>20000</td> </tr> <tr> <td>1048K</td> <td>40000</td> </tr> <tr> <td>2097K</td> <td>100000</td> </tr> <tr> <td>4195K</td> <td>200000</td> </tr> </tbody> </table>	Central Memory Size in 60-bit Decimal Words	nnnnnnn	98K	3000	262K	10000	524K	20000	1048K	40000	2097K	100000	4195K	200000
Central Memory Size in 60-bit Decimal Words	nnnnnnn															
98K	3000															
262K	10000															
524K	20000															
1048K	40000															
2097K	100000															
4195K	200000															
		If you enter CM=0 or do not enter the CM=nnnnnnn parameter, the system sets the maximum central memory size.														
		If you specify a value for nnnnnnn that exceeds the amount of physical memory, the system sends the following message.														
		UNAVAILABLE														
		If you specify a central memory size that is not large enough for a system deadstart, the system sets the maximum central memory size and the following message appears.														
		INVALID ENTRY														
CPU _n =	OFF/ON	Specifies the logical status of each available CPU. Values for n can be 0 or 1.														
		On a two-CPU system, at least one must be ON.														
		If you enter CPU ₀ =OFF on a one-CPU system, the entry is a no-op; the system uses the CPU.														
PP _{nn} =	OFF/ON	Logically turns OFF/ON one or more peripheral processors. Acceptable values for nn are 3 through 11 (excluding 10) and, if you have them, 20 through 31. Ranges may be specified. For example, PP ₅₋₇ =OFF.														
CEJ/MEJ=	OFF/ON	Specifies logical status of CEJ/MEJ. NOS does not run with either CEJ/MEJ logically OFF or with the CEJ/MEJ deadstart panel switch set to DISABLE.														

Option	Description
--------	-------------

P	<p>DEADSTART PANEL PARAMETERS. Select this option to change any of the following: the deadstart level, the CMRDECK, or deadstart program words 12 and 14. The DEADSTART PANEL PARAMETERS display, figure 3-5, appears.</p>
---	--

Press the carriage return key to cause system deadstart processing to continue with no further intervention on your part. You cannot select additional options after this entry.

Press the backspace key to return to the OPERATOR INTERVENTION display.

Table 3-2 shows the keyboard entries that you can make to change deadstart panel (program) parameters.

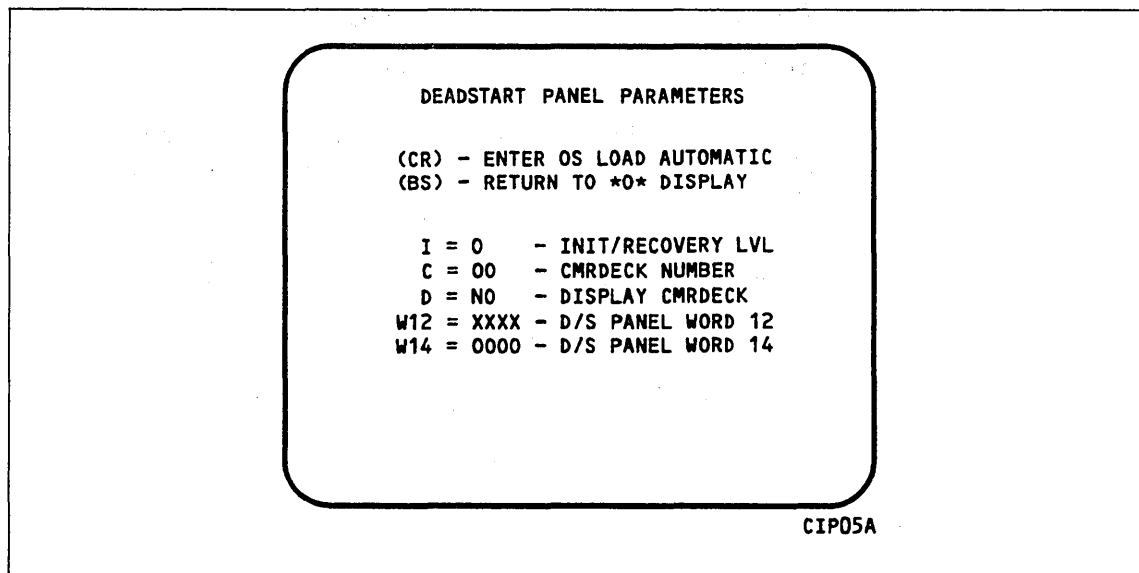

Figure 3-5. Deadstart Panel Parameters

Table 3-2. Keyboard Entries for the Deadstart Panel Parameters Display, Models 865 and 875

Keyword	Function
I=x	Specifies the level of deadstart. The value of x can be 0, 1, 2, or 3.
C=xx	Specifies the CMRDECK (CMR, for NOS/BE) number. The value of xx can be any number from 0 to 77 octal. Refer to section 5 for information about CMRDECK, CMR selection.
D=xxx	Entry is not used by NOS/BE. For NOS, specifies whether the CMRDECK is to be displayed. The value of xxx can be: YES for display CMRDECK. NO for do not display CMRDECK.
W12=xxxx	Specifies the value for deadstart program word 12. Consult a CE for information regarding use of this word.
W14=xxxx	Specifies the value for deadstart program word 14. Word 14 is reserved for the operating system or maintenance system.

Option	Description
S (NOS or NOS/BE)	SELECT OS DEADSTART DEVICE. Select this option to specify an alternate disk or a tape device as the OS Deadstart Device (figure 3-6). Press the carriage return key to cause system deadstart processing to continue with no further intervention on your part. You cannot select additional options after this entry. The CIP disk device is therefore the OS device. Press the backspace key to return to the OPERATOR INTERVENTION display.

Entry	Description
T	TAPE DEADSTART. Select this option for a tape OS deadstart rather than from disk. For NOS or NOS/BE deadstarts, the system prompts you for tape device type, channel, equipment, and unit.
D	ALTERNATE DISK DEADSTART. Select this option to choose an alternate disk device for the OS deadstart device. For NOS or NOS/BE deadstarts, the system prompts you for the disk channel, equipment, and unit.

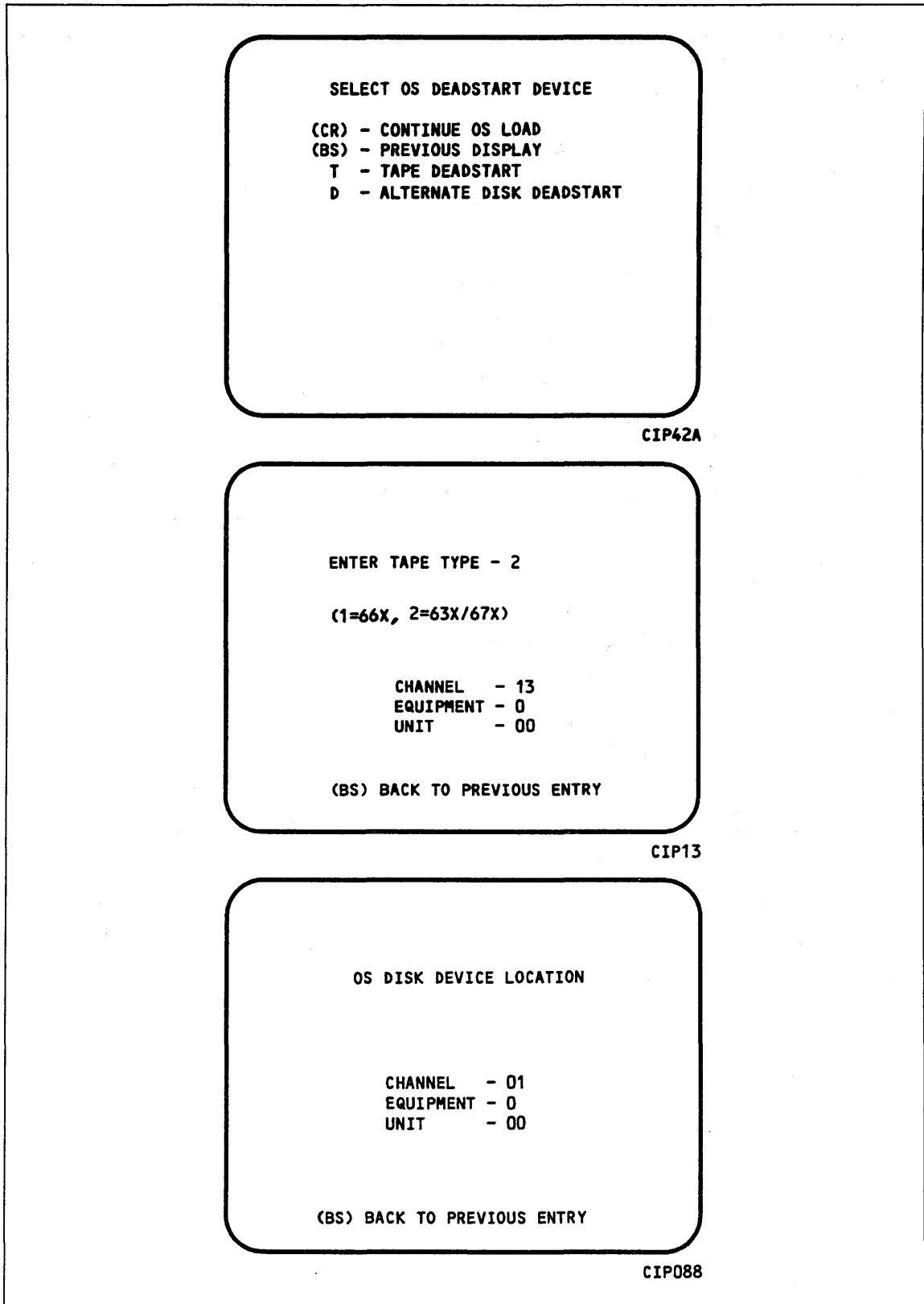

Figure 3-6. Deadstart Device

Utilities Display

Selecting the U option from the INITIAL OPTIONS display causes the UTILITIES display, figure 3-7, to appear.

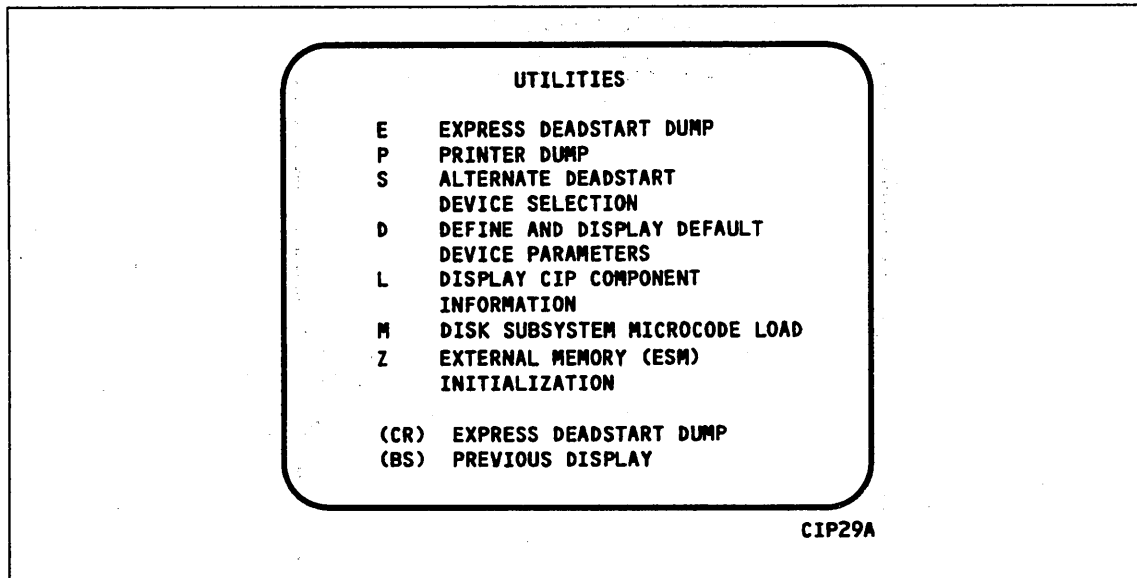

Figure 3-7. Utilities, Disk Deadstart

Option	Description
(CR) or E	EXPRESS DEADSTART DUMP. Select this option to dump to magnetic tape the contents of PP memories, central memory, unified extended memory, CPU hardware registers, maintenance registers, and the tape and disk controlware. Refer to Performing an Express Deadstart Dump in section 6 for procedures and further information.
P	PRINTER DUMP. Select this option to dump central memory, PP memory, or maintenance register contents to a line printer. The DUMP TO PRINTER OPTIONS display, figure 3-8, appears. You cannot return to the UTILITIES display from this display. Table 3-3 shows the keyboard entries for performing a printer dump. Refer to Performing a Printer Dump in section 6 for procedures and further information.

NOTE

When the E or P options are selected, CTI will check the error status of all the system elements. If errors are encountered, CTI will log the errors in the DEL. If the DEL is full, CTI will display the errors before allowing the deadstart to continue.

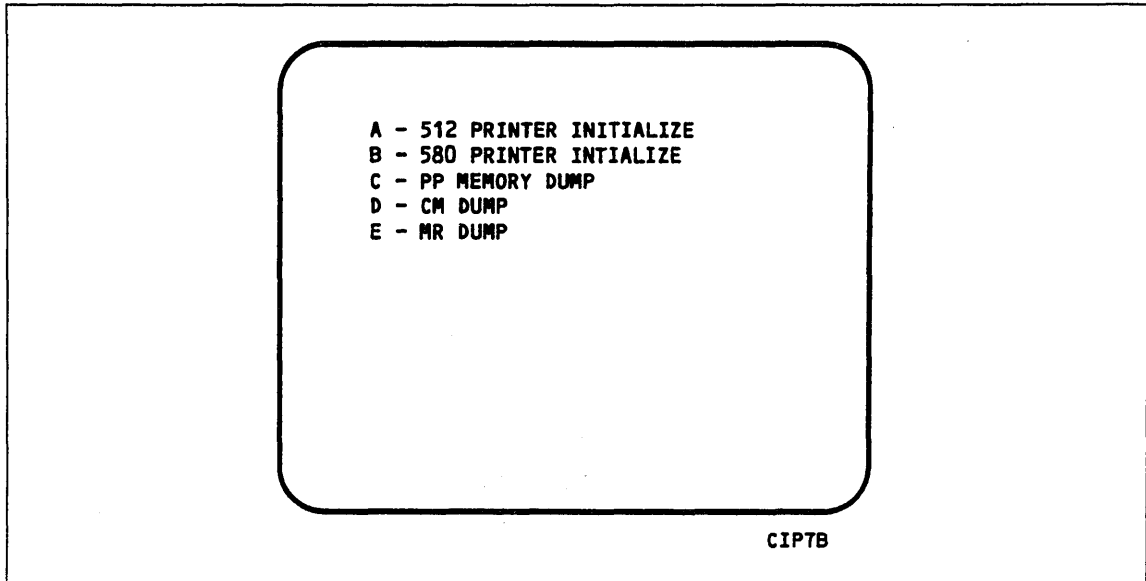

Figure 3-8. Dump to Printer Options

Table 3-3. Keyboard Entries for a Printer Dump, Models 865 and 875, Disk

Entry	Function
A	512 PRINTER INITIALIZE. This option initializes the 512 printer image with the data necessary to print with a 512-1 print train.
B	580 PRINTER INITIALIZE. This option initializes the 580 printer buffer image and format buffer image memories.
C	PP MEMORY DUMP. This option provides an octal dump to printer of 12-bit PP memories and 16-bit PP memories with their associated R registers.
D	CM DUMP. This option provides an octal dump to printer of a selected area of central memory.
E	MR DUMP. This option provides the ability to dump the contents of the maintenance register to the printer.

Option	Description
--------	-------------

- | | |
|---|--|
| S | ALTERNATE DEADSTART DEVICE SELECTION. Select this option to specify an alternate CIP tape unit or disk device from which to deadstart. The Alternate Deadstart display, figure 3-9, appears. |
|---|--|

DEADSTART DEVICE TYPE - 2

(1=66X, 2=63X/67X, 3=DISK)

CHANNEL - 13
EQUIPMENT - 0
UNIT - 00

(BS) BACK TO PREVIOUS ENTRY

CIP08A

Figure 3-9. Alternate Deadstart

Enter the device type then press the carriage return key. The system then prompts you for channel, equipment, and unit numbers.

Default values are provided for the device parameters. The values are those specified in the default parameters block. The default parameters block is defined through option D, DEFINE AND DISPLAY DEFAULT DEVICE PARAMETERS.

After the device information is entered, press the carriage return key to deadstart from the alternate device.

NOTE

Alternate deadstart from OS deadstart tapes is not supported for model 800 computer systems. To load the operating system from a tape file, select option T, operating system file on tape, from the OPERATOR INTERVENTION display.

- | | |
|---|---|
| D | DEFINE AND DISPLAY DEFAULT DEVICE PARAMETERS. Select this option to assign default values to the channel, equipment, and unit numbers of a CIP tape deadstart device, disk deadstart device, alternate disk deadstart device, tape dump (EDD) device, or printer dump device. Default values are initially assigned to the device parameters when CIP is installed. |
|---|---|

Option	Description
L	DISPLAY CIP COMPONENT INFORMATION.
M	PERIPHERAL MICROCODE LOAD
Z	EXTERNAL MEMORY (ESM) INITIALIZATION. Select this option to execute the clear ESM utility, ZAP.

NOTE

This option should be performed after any power interruption or maintenance activity.

Refer to section 6 for procedures and additional information about this option.

CIP Tape Deadstart Displays, Models 865 - 875

The CIP tape deadstart displays and options included in this subsection incorporate the following conventions.

- The first option listed on a menu display is the default option. The option can be selected automatically by pressing the carriage return key.
- Help information is provided for the INITIAL OPTIONS display. The HELP display supplies brief information about the options. More detailed option information is given elsewhere in this section.
- Pressing the backspace key allows you to return to the previous display.

Overview

Figure 3-10 provides an overview of the displays and options available during a deadstart from CIP tape on models 865 and 875.

Initial Options Display

The INITIAL OPTIONS display, figure 3-11, is the first screen that appears after you press the DEADSTART button. When you deadstart from the CIP tape, the INITIAL OPTIONS display provides utilities to install CIP to disk. A CIP tape deadstart also allows execution of several utilities from tape should the deadstart disk be unusable.

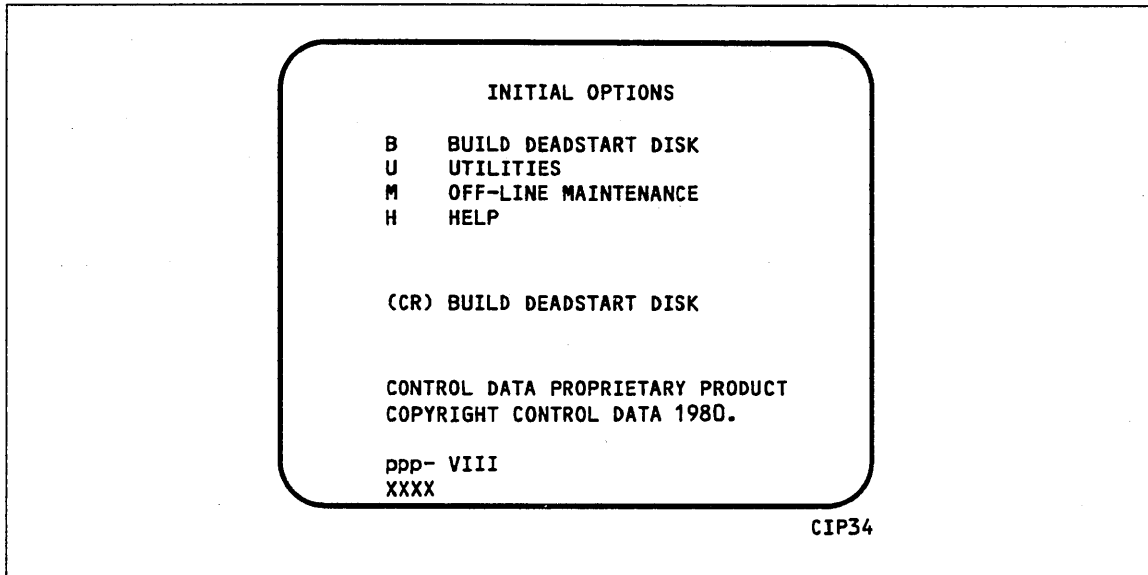

Figure 3-11. Initial Options From CIP Tape

Option	Description
(CR) or B	<p>BUILD DEADSTART DISK. This option allows you to install CIP to disk. CIP modules are used to initialize the mainframe and establish the operating environment.</p> <p>Refer to CIP Installation earlier in this section.</p>
U	<p>UTILITIES. Select this option to:</p> <ul style="list-style-type: none"> • Perform EDD. • Perform a printer dump. • Deadstart from a different device. • Define DPB. • Display CIP component levels. • Initialize ESM after power interruption or maintenance activity. • Load/install peripheral microcode.

Option	Description
---------------	--------------------

M	OFF-LINE MAINTENANCE. This option is provided to enable you to execute hardware tests for preventive maintenance or hardware error diagnosis. Information about the option is included in the MSL 140 Reference manual.
----------	--

The contents of word 12 of the deadstart program also affect the M option. Refer to Setting Word 12 in section 5 of this manual.

Execution of the hardware diagnostics from tape is much slower than from disk. Use tape only when your deadstart disk is not usable.

H	HELP for INITIAL OPTIONS display.
----------	--

The CIP level number, ppp- VIII, is displayed at the bottom of the INITIAL OPTIONS display. At the very bottom of the display, xxxx is the PSR level.

Build Deadstart Disk Display

The BUILD DEADSTART DISK display, figure 3-12, is presented on selection of option B, BUILD DEADSTART DISK, of the INITIAL OPTIONS display and is available only when you deadstart from the CIP tape. The BUILD DEADSTART DISK display provides the options that install the CIP to the deadstart disk. Refer to CIP Installation, earlier in this section, for installation procedures and displays.

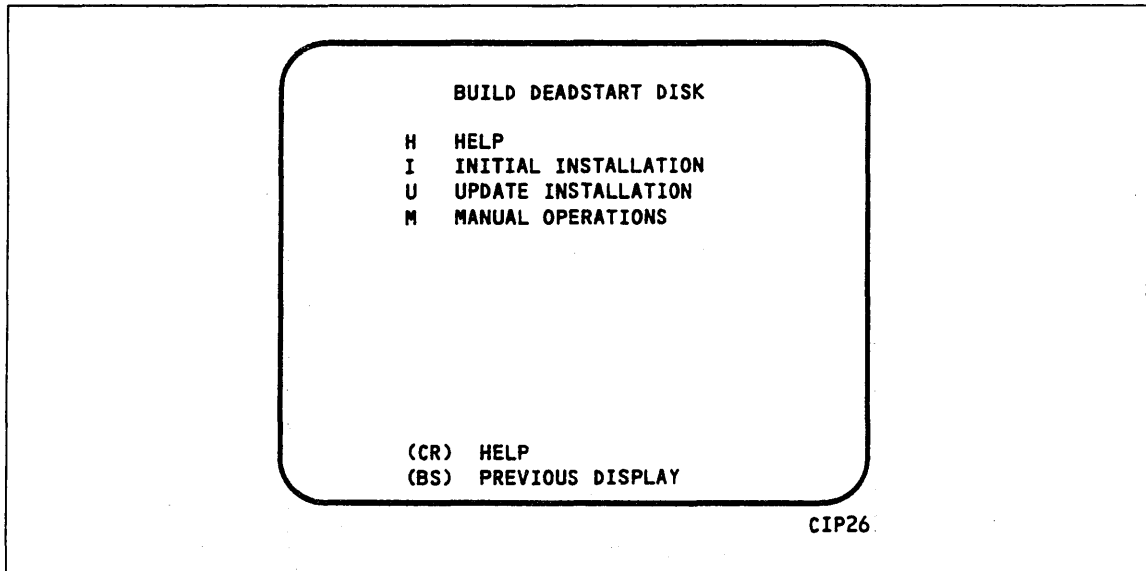

Figure 3-12. Build Deadstart Disk

Option	Description
(CR) or H	HELP for this option.
CAUTION	
I	The INITIAL INSTALLATION option destroys all information on the deadstart disk except for the disk microcode before installing CIP. Before executing the INITIAL INSTALLATION option, be sure you have a backup copy of any information on the deadstart disk that you want to preserve, including operating system permanent files and CE command buffers. After executing the INITIAL INSTALLATION option, you must perform an operating system initialization of the disk.
U	UPDATE INSTALLATION. Select this option to replace CIP on the deadstart disk some time after the initial installation. The update option preserves operating system information on the deadstart disk.
M	MANUAL OPERATIONS. Select this option only to perform emergency CIP component replacement. Figure 3-13, the MANUAL OPERATIONS display, provides manual operation option selection.

Manual Operations Display

The MANUAL OPERATIONS display, figure 3-13, appears when you select option M, MANUAL OPERATIONS, from the BUILD DEADSTART DISK display. Manual operations are available only when you deadstart from the CIP tape.

Manual operations allow manual installation of individual CIP components, which may be required in the event of a critical problem. Refer to Emergency CIP Repair in section 6 for repair and manual installation procedures. More detailed information about the manual operations is provided in the MSL 140 Reference manual.

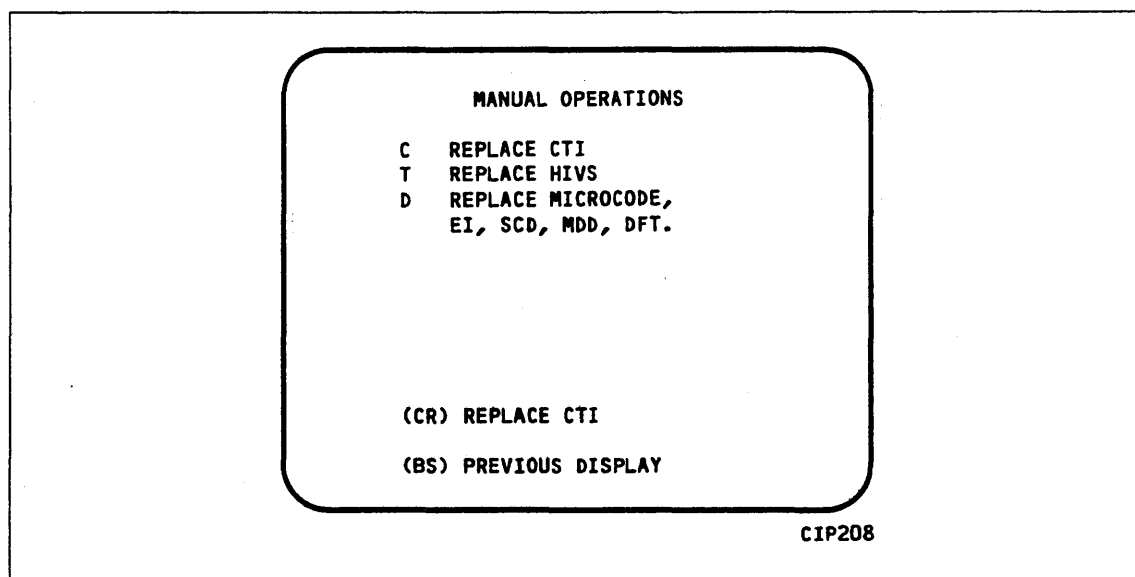

Figure 3-13. Manual Operations

Option	Description
(CR) or C	REPLACE CTI. Select this option to replace the CTI component of CIP to the deadstart disk.
NOTE	
This option provides the capability to release CTI-MSL/HIVS/OS disk space. For detailed procedures, refer to Build Deadstart Disk Operations in section 6.	
T	REPLACE MSL. Select this option to replace the MSL component of CIP to the deadstart disk.
D	REPLACE DEFAULT DEVICE PARAMETERS.
	Select the option to replace the DPB and peripheral microcode to the deadstart disk. Default device parameters are automatically installed when a CIP installation is performed. Refer to Utilities Display earlier in this section for information regarding DPB definition.

Utilities Display

Selecting the U option from the INITIAL OPTIONS display causes the UTILITIES display, figure 3-14, to appear.

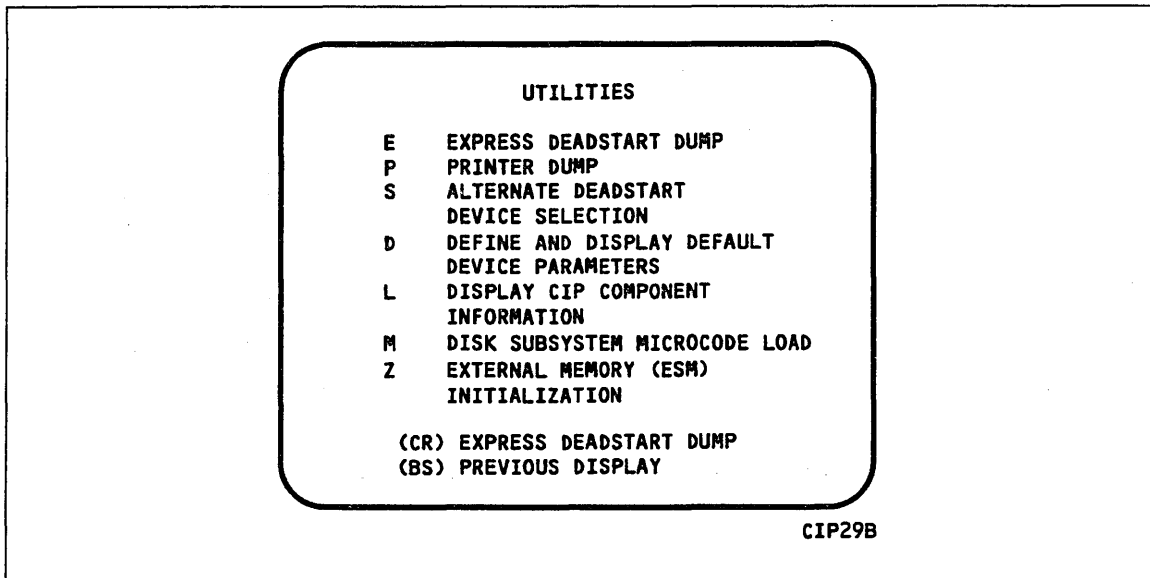

Figure 3-14. Utilities, Tape Deadstart

Option	Description
(CR) or E	EXPRESS DEADSTART DUMP. Select this option to dump to magnetic tape the contents of PP memories, central memory, unified extended memory, CPU hardware registers, maintenance registers, and the tape and disk controlware. Refer to Performing an Express Deadstart Dump in section 6 for procedures and further information.
P	PRINTER DUMP. Select this option to dump central memory, PP memory, or maintenance register contents to a line printer. The DUMP TO PRINTER OPTIONS display, figure 3-15, appears. You cannot return to the UTILITIES display from this display. Table 3-4 shows the keyboard entries for performing a printer dump. Refer to Performing a Printer Dump in section 6 for procedures and further information.

NOTE

When the E or P options are selected, CTI will check the error status of all the system elements. If errors are encountered, CTI will log the errors in the DEL. If the DEL is full, CTI will display the errors before allowing the deadstart to continue.

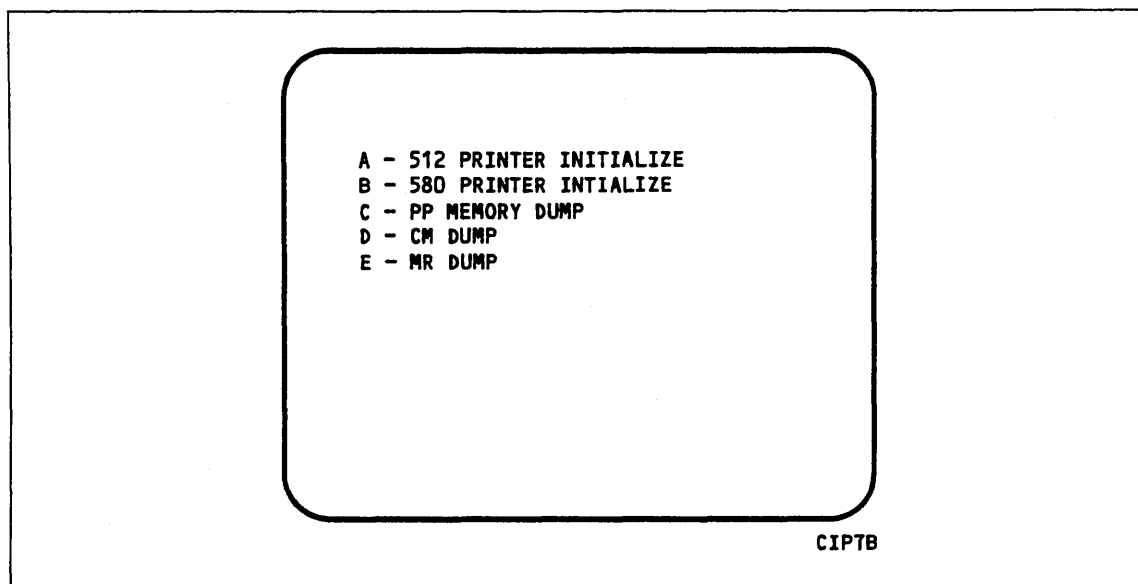

Figure 3-15. Dump to Printer Options

Table 3-4. Keyboard Entries for a Printer Dump, Models 865 and 875

Entry	Function
A	512 PRINTER INITIALIZE. This option initializes the 512 printer image with the data necessary to print with a 512-1 print train.
B	580 PRINTER INITIALIZE. This option initializes the 580 printer buffer image and format buffer image memories.
C	PP MEMORY DUMP. This option provides an octal dump to printer of 12-bit PP memories and 16-bit PP memories with their associated R registers.
D	CM DUMP. This option provides an octal dump to printer of a selected area of central memory.
E	MR DUMP. This option provides the ability to dump the contents of the maintenance register to the printer.

Option	Description
S	ALTERNATE DEADSTART. Select this option to specify an alternate CIP tape unit or disk device from which to deadstart. The ALTERNATE DEADSTART display, figure 3-16, appears.

DEADSTART DEVICE TYPE - 2

(1=66X, 2=63X/67X, 3=DISK)

CHANNEL - 13
EQUIPMENT - 0
UNIT - 00

(BS) BACK TO PREVIOUS ENTRY

CIP08A

Figure 3-16. Alternate Deadstart

Enter the device type then press the carriage return key. The system then prompts you for channel, equipment, and unit numbers.

Default values are provided for the device parameters. The values are those specified in the default parameters block. The default parameters block is defined through option D, DEFINE AND DISPLAY DPBs.

After the device information is entered, press the carriage return key to deadstart from the alternate device.

NOTE

Alternate deadstart from OS deadstart tapes is not supported for model 800 computer systems. To load the operating system from a tape file, select option T, operating system file on tape, from the OPERATOR INTERVENTION display.

D	DEFINE AND DISPLAY DEFAULT DEVICE PARAMETERS. Select this option to assign default values to the channel, equipment, and unit numbers of a CIP tape deadstart device, disk deadstart device, alternate disk deadstart device, tape dump (EDD) device, or printer dump device. Default values are initially assigned to the device parameters when CIP is installed.
---	---

Option	Description
L	DISPLAY CIP COMPONENT INFORMATION.
Z	EXTERNAL MEMORY (ESM) INITIALIZATION. Select this option to execute the clear ESM utility, ZAP.

NOTE

This option should be performed after any power interruption or maintenance activity.

Refer to the clearing ESM procedure in section 6 for procedures and additional information about this option.

M	DISK SUBSYSTEM MICROCODE LOAD. Select this option to load peripheral microcode into the 834/836, 844, 885, or 895 disk adapter and control module memory and install peripheral microcode onto specified drives. Refer to Loading and Installing Disk Subsystem Microcode from CIP Tape in section 6 for procedures and additional information about this option.
---	---

CIP Procedures, Displays, and Options for Non-Model-800 Computer Systems

4

CIP Installation, Non-800 Computer Systems	4-3
OS Deadstart, Non-800 Computer Systems	4-5
Disk Deadstart	4-5
Operating System File on Disk	4-5
Operating System File on Tape or Alternate Disk	4-6
OS Tape Deadstart	4-6
Disk/OS Tape Deadstart Displays, Non-800 Computer Systems	4-7
Overview	4-7
Initial Options Display	4-11
Operator Intervention Display	4-13
Utilities Display	4-19
CIP Tape Deadstart Displays, Non-800 Computer Systems	4-23
Overview	4-23
Initial Options Display	4-27
Build Deadstart Disk Display	4-28
Manual Operations Display	4-29
Utilities Display	4-30

CIP Procedures, Displays, and Options for Non-Model-800 Computer Systems

4

This section includes automatic installation procedures, operating system deadstart procedures, and descriptions of CIP displays and options available to users of non-model-800 computer systems.

CIP Installation, Non-800 Computer Systems

CIP installation to disk is optional for initialization and deadstart of non-model-800 computer systems. Installation of the CIP to disk allows you to perform disk deadstarts.

For CIP installation to disk, select a disk unit in your configuration as the deadstart disk. Install or update CIP on the deadstart disk according to the following procedure.

The installation procedure requires dedicated machine time. At least one tape drive and one disk unit must be available. The procedure assumes that controlware has been loaded into the peripheral controller(s). If the controlware is not loaded, refer to section 5 for coldstart instruction.

1. Mount the CIP tape on a tape drive.
2. Set the deadstart program for deadstart from the CIP tape. Refer to section 5.
3. Press the DEADSTART button. The INITIAL OPTIONS display appears.
4. Press the carriage return key to select the default option, BUILD DEADSTART DISK. The BUILD DEADSTART DISK display appears.

CAUTION

Do not proceed until you have read all the instructions for step 5.

5. For first-time installation of CIP tape, enter I to select the INITIAL INSTALLATION option, which initializes the deadstart disk and installs CIP. The INITIAL INSTALLATION option reserves 20 megabytes of disk storage for CIP.

NOTE

The INITIAL INSTALLATION option destroys all information on the deadstart disk except disk microcode prior to installing CIP. Before executing the INITIAL INSTALLATION option, be sure you have a backup copy of any information on the deadstart disk that you want to preserve, including operating system permanent files and CE command buffers. After executing the INITIAL INSTALLATION option, you must perform an operating system initialization of the disk.

For replacement of CIP some time after the initial installation, enter U to select the UPDATE option. The UPDATE option replaces CIP on the deadstart disk and preserves operating system information on the deadstart disk, including permanent files.

The CIP module replaced during an update is:

CTI

Information saved during an update includes:

Default parameter block
 Operating system pointers and permanent files

6. Enter the channel, equipment, and unit numbers of the deadstart disk when prompted. Follow each entry by pressing the carriage return key. Press only the carriage return key to select the displayed default value.
For 844 drives, the unit number must be entered within the range of 00 through 07. Press the carriage return key to accept unit 00 or enter an alternate unit number, then press the carriage return key.
For 885 drives, the unit number must be in the range 40 through 57. Enter a valid unit number, then press the carriage return key.
7. CIP installation is complete when the message `INSTALLATION COMPLETE` appears.
You can now perform an operating system load, DPB definition, or other deadstart utility operation. Refer to section 6.

OS Deadstart, Non-800 Computer Systems

An operating system deadstart can be performed when the deadstart file is on magnetic tape or on disk.

The operating system deadstart procedures require at least one disk unit and, when the operating system file is on tape, one tape unit. The procedures assume that controlware has been loaded into the peripheral controller(s). If the controlware is not loaded, refer to section 5 for coldstart instructions.

Documentation follows for the two types of operating system deadstart:

- Disk Deadstart
- Operating System (OS) Tape Deadstart

Disk Deadstart

This procedure assumes that:

- The deadstart program is set for deadstart from disk.
- CIP has been installed to disk. Refer to CIP Installation earlier in this section.

If the operating system file has also been installed to disk, a complete disk deadstart can be performed. Refer to the NOS 2 Analysis Handbook, INSTALL command, to find out how to install the NOS file to disk. The NOS/BE level 0 deadstart process automatically installs the NOS/BE file on disk for use on following deadstarts.

Operating System File on Disk

1. Press the DEADSTART button to initiate deadstart. The INITIAL OPTIONS display appears.
2. Press the carriage return key to select the default option, AUTOMATIC OS LOAD. The automatic option assumes that the deadstart program is set correctly on the deadstart panel for deadstart level (0, 1, 2, 3) and for CMRDECK selection (NOS) or for CMR selection (NOS/BE).

If the deadstart program is set correctly, operating system deadstart is initiated.

3. If the deadstart program is not set correctly for these selections, enter O to select the OPERATOR INTERVENTION option. Operator intervention also allows reconfiguration of mainframe hardware components and execution of the hardware verification sequences. For specific information regarding operator intervention options refer to the displays and options for deadstart from disk or OS tape later in this section.

Operating System File on Tape or Alternate Disk

1. Press the DEADSTART button to initiate deadstart. The INITIAL OPTIONS display appears.
2. Enter O. The OPERATOR INTERVENTION display appears.
3. If the deadstart program is not set correctly for deadstart level and for CMRDECK selection (NOS) or CMR selection (NOS/BE), enter P to select the DEADSTART PANEL PARAMETERS option, before proceeding. Operator intervention also allows reconfiguration of the mainframe hardware components and execution of hardware verification sequences. For specific information regarding operator intervention, refer to the displays and options for deadstart from disk or OS tape later in this section.
4. Enter S to select tape or alternate disk.
 - a. Tape Deadstart
 1. Enter T to deadstart using a tape.
 2. Enter tape type, channel, equipment, and unit when prompted.
 - b. Alternate Disk Deadstart
 1. Enter D to select alternate disk deadstart.
 2. Enter disk channel, equipment, and unit when prompted.
5. Press the carriage return key. Operating system deadstart is initiated.
6. You will see messages indicating that NOS or NOS/BE is loading programs and running tests.

OS Tape Deadstart

The deadstart program is set for deadstart from OS tape.

1. Mount operating system deadstart tape.
2. Press the DEADSTART button to initiate deadstart. The INITIAL OPTIONS display appears on the console screen.
3. Press the carriage return key to select the default option, AUTOMATIC OS LOAD. The automatic option assumes that the deadstart panel is set correctly on the deadstart panel for deadstart level (0, 1, 2, 3) and for CMRDECK selection (NOS) or CMR selection (NOS/BE).
4. If the program is not set correctly for these selections, enter O to select the OPERATOR INTERVENTION option. Operator intervention also allows reconfiguration of mainframe hardware components. For specific information regarding operator intervention, refer to the displays and options for deadstart from disk or OS tape, next.

Disk/OS Tape Deadstart Displays, Non-800 Computer Systems

The deadstart displays and options included in this subsection are presented when a deadstart is initiated from a disk or from an OS tape. The displays incorporate the following conventions.

- The first option listed on a menu display is the default option. The option can be selected automatically by pressing the carriage return key.
- Help information is provided for the INITIAL OPTIONS display. The HELP display supplies brief information about the options. More detailed option information is given elsewhere in this section.
- Pressing the backspace key allows you to return to the previous display.

Overview

Figure 4-1 provides an overview of the displays and options available during a deadstart from disk or OS tape on non-model 800 computer systems.

Initial Options Display

The INITIAL OPTIONS display, figure 4-2, always appears first when a deadstart is initiated.

When the deadstart program is set for deadstart from disk or when the deadstart program is set for deadstart from the OS tape, the INITIAL OPTIONS display provides operating system load and deadstart utilities.

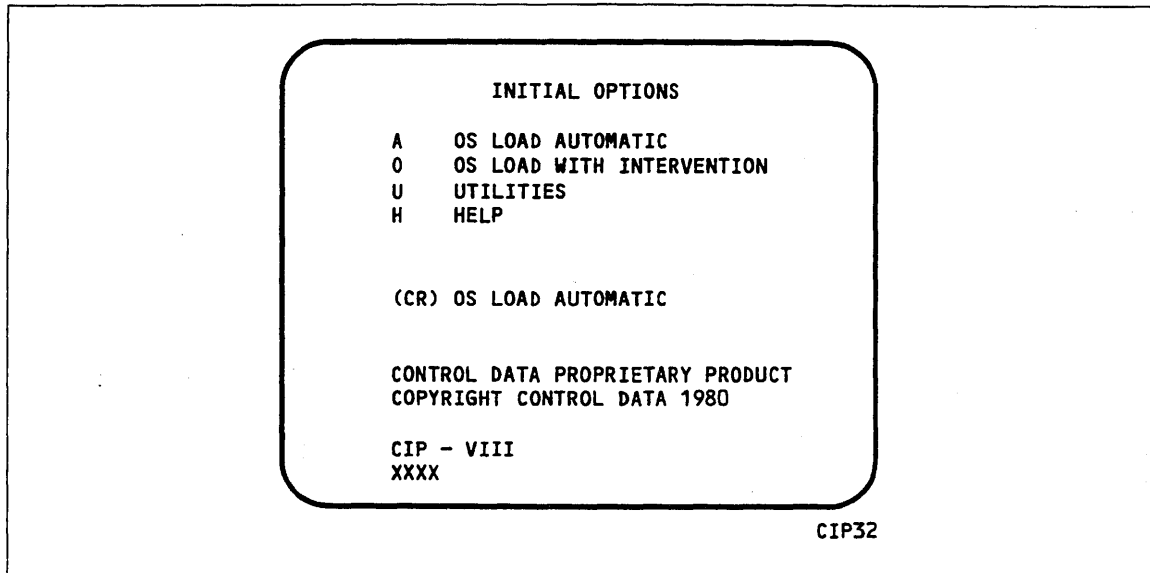

Figure 4-2. Initial Options From Disk or From OS Tape

Option	Description
(CR) or A	OS LOAD AUTOMATIC. Select this option to load the operating system with no intervention on your part.
	Before CIP transfers deadstart to the operating system, memory confidence tests verify the ability of central memory and PP memory to hold simple data patterns, and then preset CM and PP memory contents to all ones.
	If the system detects a fatal error on a CYBER 170 mainframe during the confidence testing, the following information appears.
	DEADSTART ABORTED - FATAL ERROR
	SR-0-2 yyyy yyyy yyyy yyyy yyyy
	SR-0-1 yyyy yyyy yyyy yyyy yyyy yyyy
	SR-0-0 yyyy yyyy yyyy yyyy yyyy yyyy
	yyyy is the contents of a word in the SCR register; word 16 is the upper left word, and word 0 is the lower right word. A text explanation of the error appears below the register contents. Inform a CE.

Option	Description
O	OS LOAD WITH INTERVENTION. Select this option to execute the hardware verification sequences, to reconfigure mainframe hardware components, or to change the operating system deadstart level or CMRDECK selection specified in the deadstart program. Refer to the OPERATOR INTERVENTION display, figure 4-3, for more information.
U	UTILITIES. Select this option to: <ul style="list-style-type: none">• Perform an EDD.• Perform a printer dump.• Deadstart from a different device.• Define DPB.• Display CIP component information.• Initialize ESM after power interruption or maintenance activity.
H	HELP for INITIAL OPTIONS display.

The CIP version number, CIP- VIII, is displayed at the bottom of the INITIAL OPTIONS display. At the very bottom of the display, xxxx is the PSR level.

Operator Intervention Display

The OPERATOR INTERVENTION display, figure 4-3, appears when you select option O, OPERATOR INTERVENTION, from the INITIAL OPTIONS display.

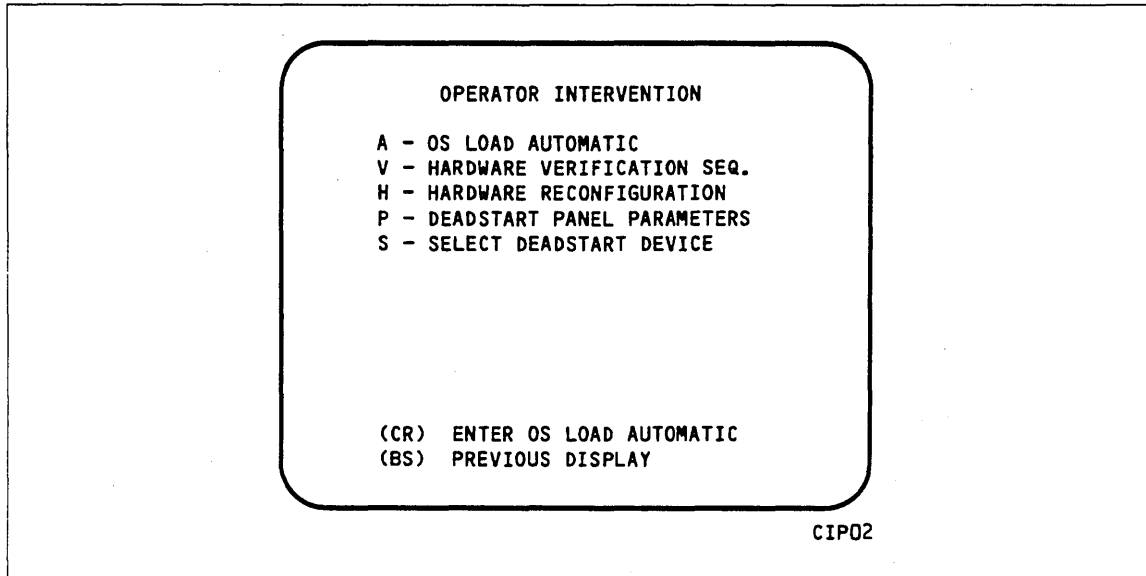

Figure 4-3. Operator Intervention

Option	Description
(CR) or A	OS LOAD AUTOMATIC. Select this option to perform an operating system load. Refer to the description of the OS LOAD AUTOMATIC option under INITIAL OPTIONS Display earlier in this section for more information.
V	HARDWARE VERIFICATION sequence. Select this option to execute PP, CM, and CPU confidence tests. If you have selected either a level 0, 1, or 2 deadstart, central memory contents are changed when you execute this option. The V option cannot be executed if a level 3 deadstart is selected. You cannot test hardware that has been turned off via the HARDWARE RECONFIGURATION option. The names of the tests used by HIVS are listed in table 4-1. Appendix E provides a brief description of each test. Upon successful test completion, the system displays: TESTING COMPLETE-DEADSTART Initiate deadstart after testing to ensure that the system is returned to initial deadstart condition prior to system loading or recovery.

Table 4-1. HIVS Tests by Computer System

CYBER 70 Computer Systems	6000 Computer Systems, CYBER 170 Models 175, 740, 750, 760	CYBER 170 Models 171 through 174, 720, 730	CYBER 170 Model 176
CMC	CMC	CMC	BMEM
CT3	CT3	CT3	CMC
ECM	CT7	ECM	CT73
EJP	ECM	EJP	LCM4
IRT	EJP	MY1	PCX
MY1	MY1	PCX	SSMC
PCX	PCX		

Option	Description
H	HARDWARE RECONFIGURATION. Select this option to alter the mainframe hardware configuration. When selected, figure 4-4 appears.

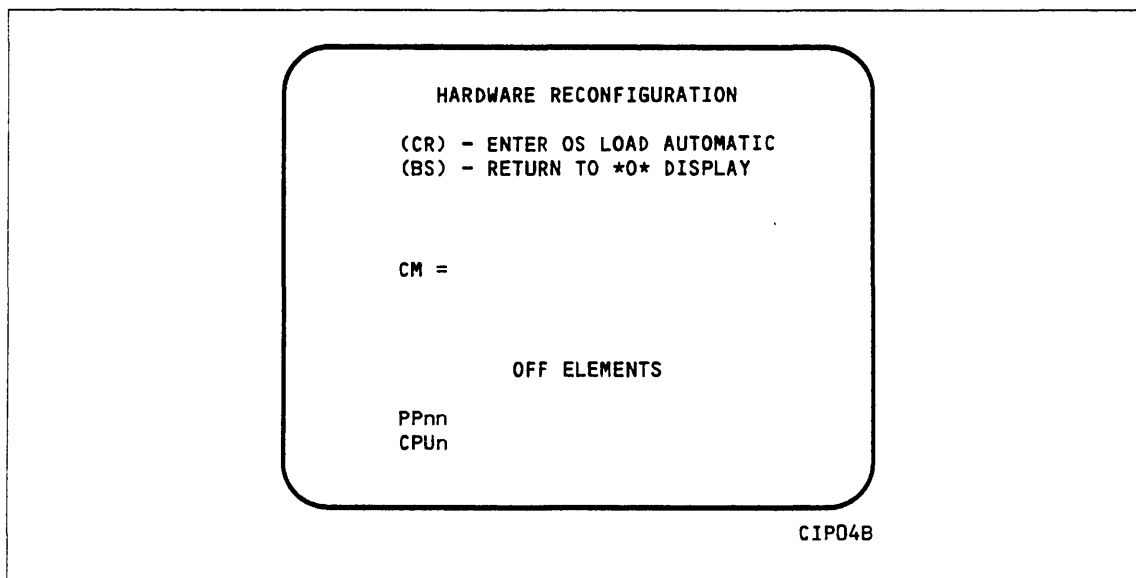

Figure 4-4. Hardware Reconfiguration

The default hardware configuration includes every hardware element available for use. To change the hardware configuration, enter the appropriate entry as described in table 4-2. When you turn off an element, its identifier is added to the OFF ELEMENTS list on the display. Entries are in the form keyword=option.

Table 4-2. Hardware Reconfiguration Entries, Non-Model-800 Computer Systems

Keyword	Option	Function										
CM=	nnnnnnn	<p>Specifies the size, in octal, of central memory in hundreds of words. The following examples show the value you enter for nnnnnnn, given the central memory size.</p> <table border="1"> <thead> <tr> <th>Central Memory Size in 60-bit Decimal Words</th> <th>nnnnnnn</th> </tr> </thead> <tbody> <tr> <td>98K</td> <td>3000</td> </tr> <tr> <td>131K</td> <td>4000</td> </tr> <tr> <td>198K</td> <td>6000</td> </tr> <tr> <td>262K</td> <td>10000</td> </tr> </tbody> </table> <p>If you enter CM=0 or do not enter the CM=nnnnnnn parameter, the system sets the maximum size.</p> <p>If you specify a value for nnnnnnn that exceeds the amount of physical memory, the system sends the following message:</p> <p style="text-align: center;">UNAVAILABLE</p> <p>If you specify a central memory size that is not large enough for a system deadstart, the system sets the maximum central memory size and the following message appears:</p> <p style="text-align: center;">INVALID ENTRY</p>	Central Memory Size in 60-bit Decimal Words	nnnnnnn	98K	3000	131K	4000	198K	6000	262K	10000
Central Memory Size in 60-bit Decimal Words	nnnnnnn											
98K	3000											
131K	4000											
198K	6000											
262K	10000											
CPU _n =	OFF/ON	<p>Specifies the logical status of each available CPU. Values for n can be 0 or 1.</p> <p>On a two-CPU system, at least one must be ON.</p> <p>If you enter CPU₀=OFF on a one-CPU system, the entry is a no-op; the system uses the CPU.</p>										
PP _{nn} =	OFF/ON	<p>Logically turns OFF/ON one or more peripheral processors. Acceptable values for nn are 3 through 11 (excluding 10) and, if you have them, 20 through 31. Ranges may be specified. For example, PP₅₋₇=OFF.</p>										
PPU _{nn} =	OFF/ON	<p>Logically turn OFF/ON one or more of the model 176 first level peripheral processors (PPs). Acceptable values for nn are octal numbers 1 through 15. Ranges may be specified. For example, PPU 2-3=OFF.</p>										
CEJ/MEJ=	OFF/ON	<p>Specifies logical status of CEJ/MEJ. NOS does not run with either CEJ/MEJ logically OFF or with the CEJ/MEJ deadstart panel switch set to DISABLE.</p>										
CMU=	OFF/ON	<p>Specifies logical status of the compare/move unit hardware.</p>										

Option	Description
--------	-------------

P	<p>DEADSTART PANEL PARAMETERS. Select this option to change any of the following: the deadstart level, the CMRDECK, or deadstart program words 12 and 14. The DEADSTART PANEL PARAMETERS display, figure 4-5, appears.</p>
---	--

Press the carriage return key if you want to cause system deadstart processing to continue with no further intervention on your part. You cannot select additional options after this entry.

Press the backspace key if you want to return to the OPERATOR INTERVENTION display.

Table 4-3 shows the keyboard entries that you can make to change deadstart panel (program) parameters.

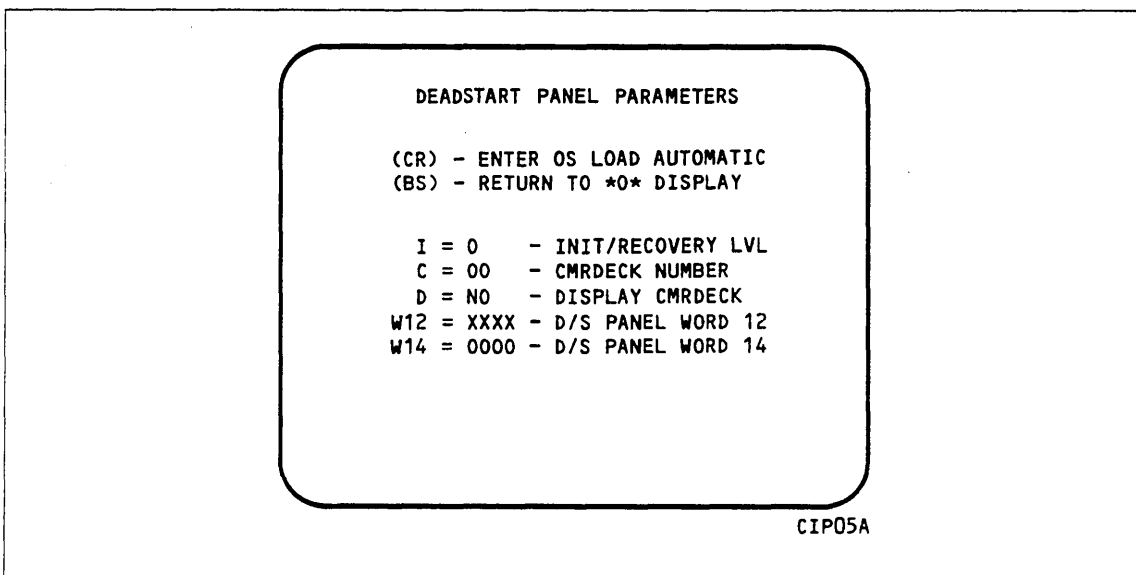

Figure 4-5. Deadstart Panel Parameters

Table 4-3. Keyboard Entries for the Deadstart Panel Parameters Display, Non-Model-800 Computer Systems

Keyword	Function
I=x	Specifies the level of deadstart. The value of x can be 0, 1, 2, or 3.
C=xx	Specifies the CMRDECK (CMR, for NOS/BE) number. The value of xx can be 0 through 77 octal. Refer to section 5 for information about CMRDECK, CMR selection.
D=xxx	Entry is not used by NOS/BE. For NOS, specifies whether the CMRDECK is to be displayed. The value of xxx can be: YES for display CMRDECK. NO for do not display CMRDECK.
W12=xxxx	Specifies the value for deadstart program word 12. Consult a CE for information regarding use of this word.
W14=xxxx	Specifies the value for deadstart program word 14. Word 14 is reserved for the operating system or maintenance system.

Option	Description						
S (NOS or NOS/BE)	<p>SELECT OS DEADSTART DEVICE. Select this option to specify an alternate disk or a tape device as the OS Deadstart Device (figure 4-6).</p> <p>Press the carriage return key to cause system deadstart processing to continue with no further intervention on your part. You cannot select additional options after this entry. The CIP disk device is therefore the OS device.</p> <p>Press the backspace key to return to the OPERATOR INTERVENTION display.</p>						
	<table border="1"> <thead> <tr> <th>Entry</th> <th>Description</th> </tr> </thead> <tbody> <tr> <td>T</td> <td>TAPE DEADSTART. Select this option for a tape OS deadstart rather than from disk. For NOS or NOS/BE deadstarts the system prompts you for tape device type, channel, equipment and unit.</td> </tr> <tr> <td>D</td> <td>ALTERNATE DISK DEADSTART. Select this option to choose an alternate disk device for the OS deadstart device. For NOS or NOS/BE deadstarts, the system prompts you for the disk channel, equipment and unit.</td> </tr> </tbody> </table>	Entry	Description	T	TAPE DEADSTART. Select this option for a tape OS deadstart rather than from disk. For NOS or NOS/BE deadstarts the system prompts you for tape device type, channel, equipment and unit.	D	ALTERNATE DISK DEADSTART. Select this option to choose an alternate disk device for the OS deadstart device. For NOS or NOS/BE deadstarts, the system prompts you for the disk channel, equipment and unit.
Entry	Description						
T	TAPE DEADSTART. Select this option for a tape OS deadstart rather than from disk. For NOS or NOS/BE deadstarts the system prompts you for tape device type, channel, equipment and unit.						
D	ALTERNATE DISK DEADSTART. Select this option to choose an alternate disk device for the OS deadstart device. For NOS or NOS/BE deadstarts, the system prompts you for the disk channel, equipment and unit.						

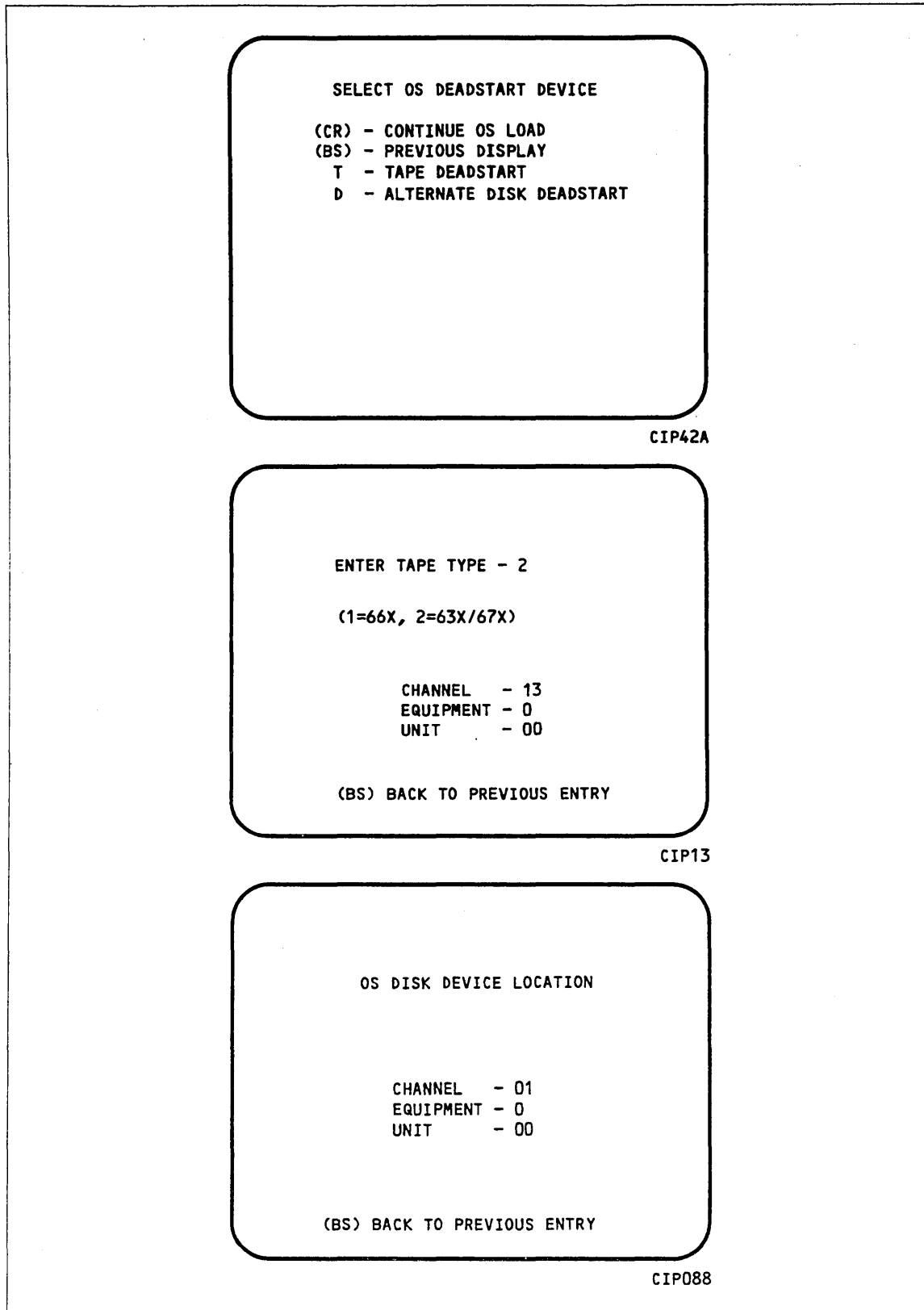

Figure 4-6. Deadstart Device

Utilities Display

Selecting the U option from the INITIAL OPTIONS display causes the UTILITIES display, figure 4-7, to appear.

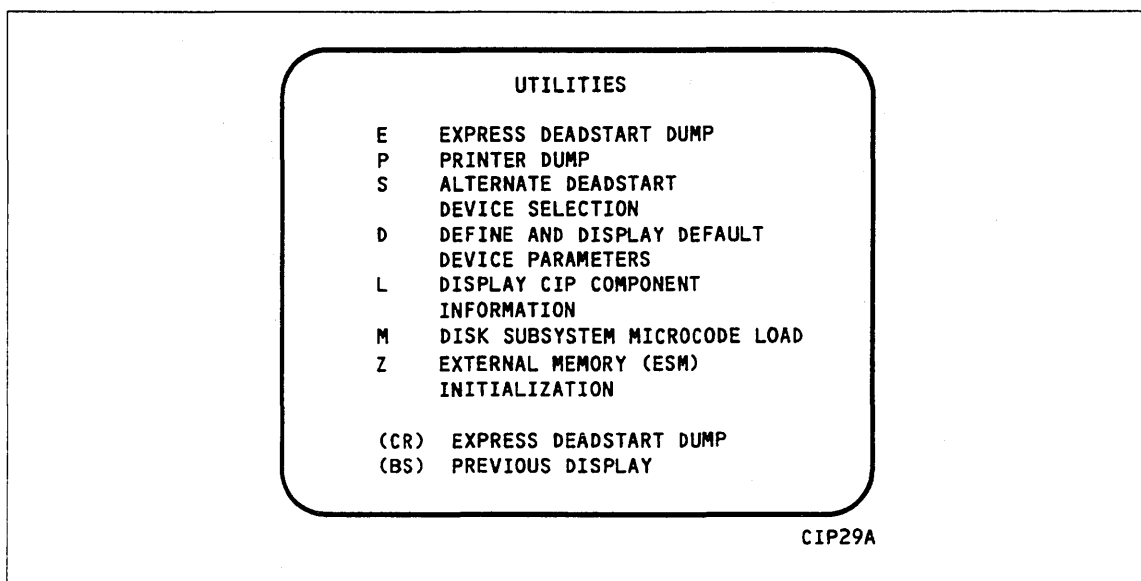

Figure 4-7. Utilities, Disk Deadstart

Option	Description
(CR) or E	EXPRESS DEADSTART DUMP. Select this option to dump to magnetic tape the contents of PP memories, central memory, hardware registers, and the tape and disk controlware. Refer to Performing an Express Deadstart Dump in section 6 for procedures and further information.
P	PRINTER DUMP. Select this option to dump central memory, PP memory, or hardware register contents to a line printer. The DUMP TO PRINTER OPTIONS display, figure 4-8, appears. You cannot return to the Utilities display from this display. You must redeadstart the system. Table 4-4 shows the keyboard entries for performing a printer dump. Refer to Performing a Printer Dump in section 6 for procedures and further information.

NOTE

When the E or P options are selected, CTI will check the error status of all the system elements. If errors are encountered, CTI will log the errors in the DEL. If the DEL is full, CTI will display the errors before allowing the deadstart to continue.

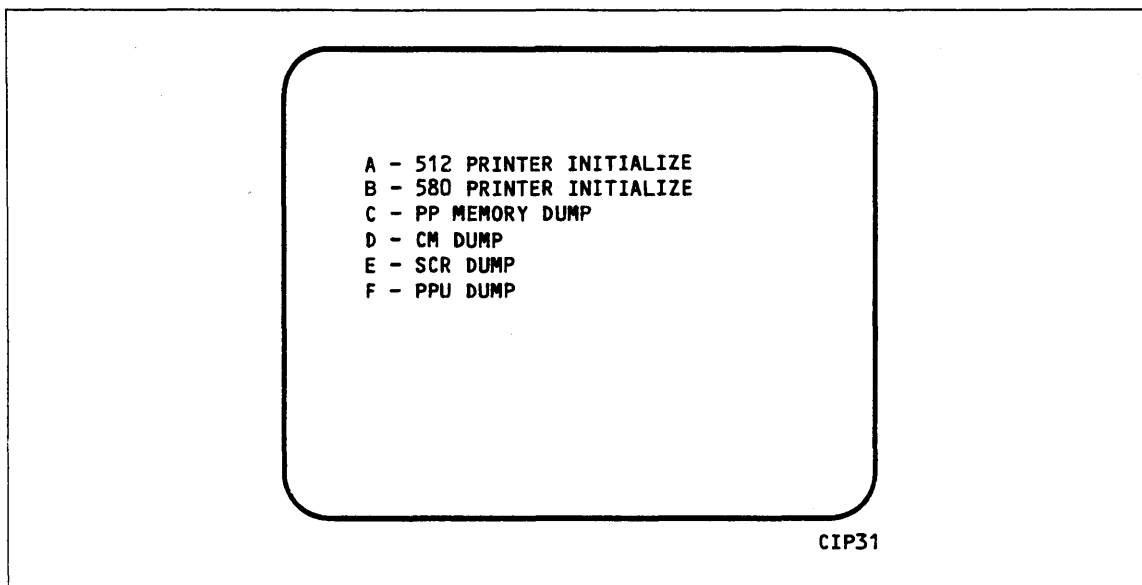

Figure 4-8. Dump to Printer Options

Table 4-4. Keyboard Entries for a Printer Dump, Non-Model-800 Computer Systems, Disk

Entry	Function
A	512 PRINTER INITIALIZE. This option initializes the 512 printer image with the data necessary to print with a 512-1 print train.
B	580 PRINTER INITIALIZE. This option initializes the 580 printer buffer image and format buffer image memories.
C	PP MEMORY DUMP. This option provides an octal dump to printer of 12-bit PP memories and 16-bit PP memories with their associated R registers.
D	CM DUMP. This option provides an octal dump to printer of a selected area of central memory.
E	SCR DUMP. This option provides the ability to dump the contents of the status control register to the printer.
F	PPU MEMORY DUMP. This option provides an octal dump to printer of 12-bit PPU memories (CYBER 170 model 176 only).

Option	Description
S	ALTERNATE DEADSTART. Select this option to specify an alternate tape unit or disk device from which to deadstart. The ALTERNATE DEADSTART display, figure 4-9, appears.

DEADSTART DEVICE TYPE - 2

(1=66X, 2=63X/67X, 3=DISK)

CHANNEL - 13
EQUIPMENT - 0
UNIT - 00

(BS) BACK TO PREVIOUS ENTRY

CIP08A

Figure 4-9. Alternate Deadstart

Enter the device type then press the carriage return key. The system then prompts you for channel, equipment, and unit numbers.

Default values are provided for the device parameters. The values are those specified in the default parameters block. The default parameters block is defined through option D, DEFINE AND DISPLAY DEFAULT DEVICE PARAMETERS.

After the device information is entered, press the carriage return key to deadstart from the alternate device.

D	DEFINE AND DISPLAY DEFAULT DEVICE PARAMETERS. Select this option to assign default values to the channel, equipment, and unit numbers of a tape deadstart device, disk deadstart device, alternate disk deadstart device, tape dump (EDD) device, or printer dump device. Default values are initially assigned to the device parameters when CIP is installed.
---	---

Option	Description
L	DISPLAY CIP COMPONENTS INFORMATION.
M	PERIPHERAL MICROCODE LOAD
Z	EXTERNAL MEMORY (ESM) INITIALIZATION. Select this option to execute the clear ESM utility, ZAP.

NOTE

This option should be performed after any power interruption or maintenance activity.

Refer to section 6 for procedures and additional information about this option.

CIP Tape Deadstart Displays, Non-800 Computer Systems

The displays and options included in this subsection are presented when a deadstart is initiated from a CIP tape. The displays incorporate the following conventions.

- The first option listed on a menu display is the default option. The option can be selected automatically by pressing the carriage return key.
- Help information is provided for the INITIAL OPTIONS display. The HELP display supplies brief information about the options. More detailed option information is given elsewhere in this section.
- Pressing the backspace key allows you to return to the previous display.

Overview

Figure 4-10 provides an overview of the displays and options available during a deadstart from CIP tape on non-model-800 computer systems.

Initial Options Display

The INITIAL OPTIONS display, figure 4-11, is the first screen that appears after deadstart is initiated. When you deadstart from CIP tape, the INITIAL OPTIONS display provides utilities to install the CIP to disk. A CIP tape deadstart also allows execution of several utilities from tape should the deadstart disk be unusable.

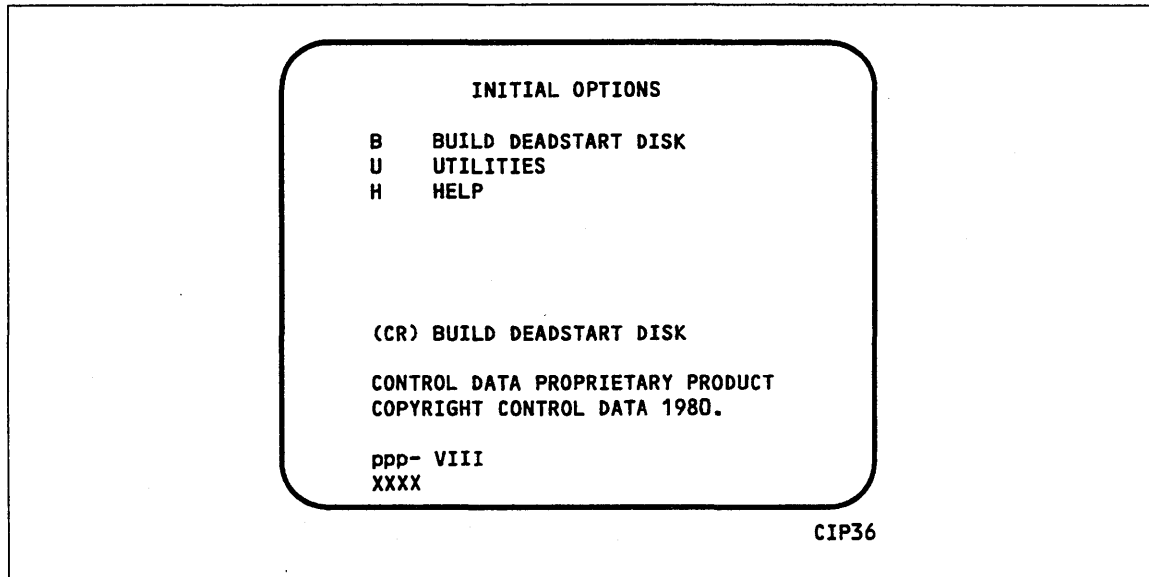

Figure 4-11. Initial Options From CIP Tape

Option	Description
(CR) or B	BUILD DEADSTART DISK. This option allows you to install the CIP to disk. CIP modules are used to initialize the mainframe and establish the operating environment. Refer to CIP Installation earlier in this section.
U	UTILITIES. Select this option to: <ul style="list-style-type: none"> • Perform EDD. • Perform a printer dump. • Deadstart from a different device. • Define DPB. • Display CIP component levels. • Initialize ESM after power interruption or maintenance activity. • Load/install peripheral microcode.
H	HELP for INITIAL OPTIONS display.

The CIP version number, ppp- VIII, is displayed at the bottom of the INITIAL OPTIONS display. At the very bottom of the display, xxxx is the PSR level.

Build Deadstart Disk Display

The BUILD DEADSTART DISK display, figure 4-12, appears when you select option B, BUILD DEADSTART DISK, from the INITIAL OPTIONS display. The BUILD DEADSTART DISK display is available only when you deadstart from the CIP tape. This display provides the options that install the CIP to the deadstart disk. Refer to CIP Installation earlier in this section for installation procedures and displays.

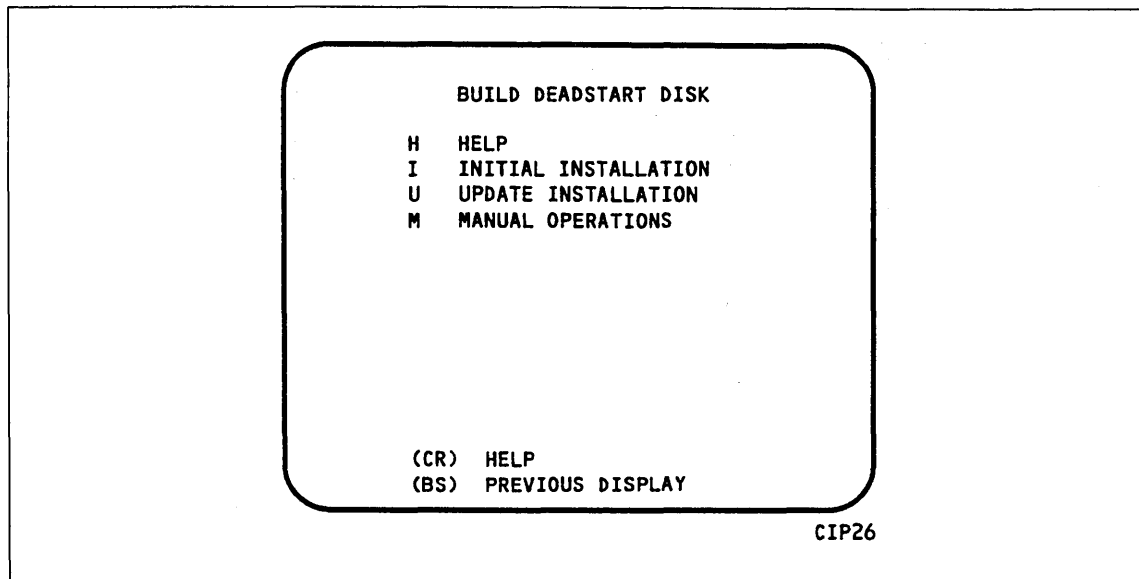

Figure 4-12. Build Deadstart Disk

Option	Description
(CR) or H	HELP for this option.
CAUTION	
I	INITIAL INSTALLATION. Select this option to install CIP for the first time. The INITIAL INSTALLATION option initializes the deadstart disk and then installs CIP to the deadstart disk.
U	UPDATE INSTALLATION. Select this option to replace CIP on the deadstart disk some time after the initial installation. The update option preserves operating system information on the deadstart disk.
M	MANUAL OPERATIONS. Select this option only to perform emergency CIP component replacement. The Manual Operations display, figure 4-13, provides manual operation option selection.

Manual Operations Display

The MANUAL OPERATIONS display, figure 4-13, appears when you select option M, MANUAL OPERATIONS, from the BUILD DEADSTART DISK display. Manual operations are available only when you deadstart from the CIP tape.

Manual operations provide manual installation of individual CIP components, which may be required in the event of a critical problem.

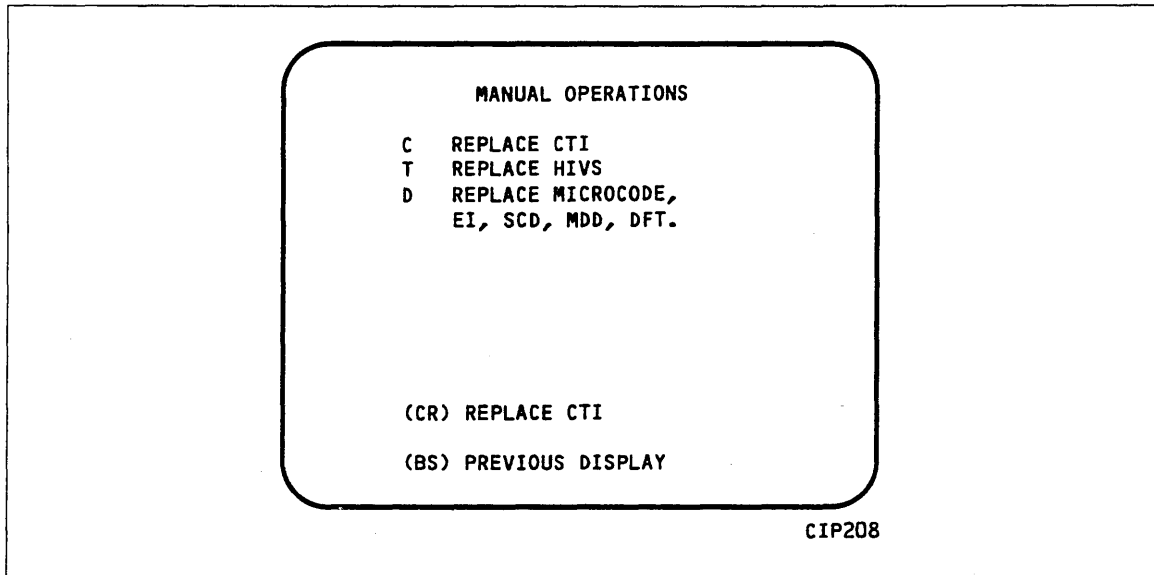

Figure 4-13. Manual Operations

Option	Description
(CR) or C	REPLACE CTI. Select this option to replace the CTI component of CIP to the deadstart disk.
NOTE	
This option provides the capability to release CTI-MSL/HIVS/OS disk space. For detailed procedures, refer to Build Deadstart Disk Operations in section 9.	
T	REPLACE HIVS. Select this option to replace the HIVS component of CIP to the deadstart disk.
D	REPLACE DEFAULT DEVICE PARAMETERS. Select the option to replace the DPB and peripheral microcode to the deadstart disk. Default device parameters are automatically installed when a CIP installation is performed. Refer to UTILITIES display earlier in this section for information regarding DPB definition.

Utilities Display

Selecting the U option from the INITIAL OPTIONS display causes the UTILITIES display, figure 4-14, to appear.

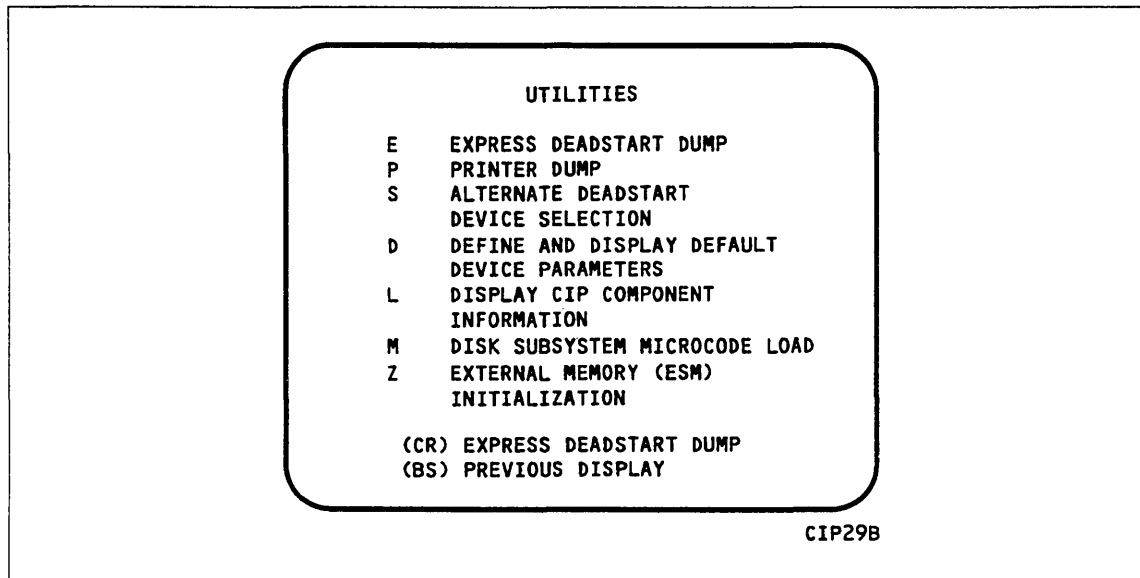

Figure 4-14. Utilities, Tape Deadstart

Option	Description
(CR) or E	EXPRESS DEADSTART DUMP. Select this option to dump to magnetic tape the contents of PP memories, central memory, hardware registers, and the tape and disk controlware. Refer to Performing an Express Deadstart Dump in section 6 for procedures and information.
P	PRINTER DUMP. Select this option to dump central memory, PP memory, or hardware register contents to a line printer. The DUMP TO PRINTER OPTIONS display, figure 4-15, appears. You cannot return to the UTILITIES display from this display. You must redeadstart the system. Table 4-5 shows the keyboard entries for performing a printer dump. Refer to Performing a Printer Dump in section 6 for procedures and further information.

NOTE

When the E or P options are selected, CTI will check the error status of all the system elements. If errors are encountered, CTI will log the errors in the DEL. If the DEL is full, CTI will display the errors before allowing the deadstart to continue.

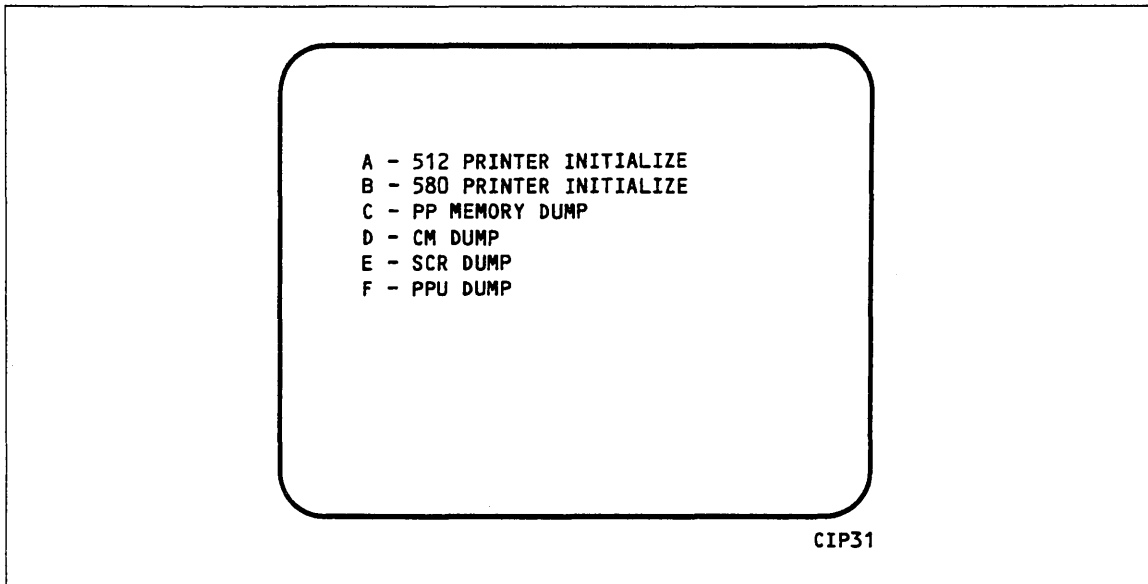

Figure 4-15. Dump to Printer Options

Table 4-5. Keyboard Entries for a Printer Dump, Non-Model-800 Computer Systems, Tape

Entry	Function
A	512 PRINTER INITIALIZE. This option initializes the 512 printer image with the data necessary to print with a 512-1 print train.
B	580 PRINTER INITIALIZE. This option initializes the 580 printer buffer image and format buffer image memories.
C	PP MEMORY DUMP. This option provides an octal dump to printer of 12-bit PP memories and 16-bit PP memories with their associated R registers.
D	CM DUMP. This option provides an octal dump to printer of a selected area of central memory.
E	SCR DUMP. This option provides the ability to dump the contents of the status control register to the printer.
F	PPU MEMORY DUMP. This option provides an octal dump to printer of 12-bit PPU memories (CYBER 170 model 176 only).

Option	Description
S	<p>ALTERNATE DEADSTART. Select this option to specify an alternate tape unit or disk device from which to deadstart. The ALTERNATE DEADSTART display, figure 4-16, appears.</p> <p>Enter the device type then press the carriage return key. The system then prompts you for channel, equipment, and unit numbers.</p> <p>Default values are provided for the device parameters. The values are those specified in the default parameters block. The default parameters block is defined through option D, DEFINE AND DISPLAY DEFAULT DEVICE PARAMETERS.</p> <p>After the device information is entered, press the carriage return key to deadstart from the alternate device.</p>

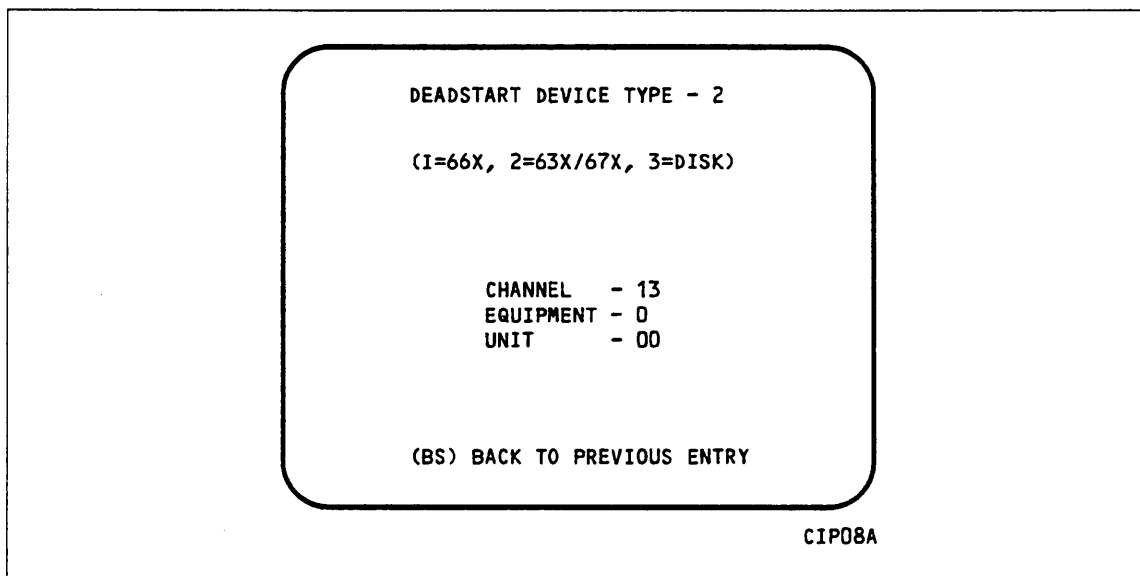

Figure 4-16. Alternate Deadstart

Option	Description
D	<p>DEFINE AND DISPLAY DEFAULT DEVICE PARAMETERS. Select this option to assign default values to the channel, equipment, and unit numbers of a tape deadstart device, disk deadstart device, alternate disk deadstart device, tape dump (EDD) device, or printer dump device. Default values are initially assigned to the device parameters when CIP is installed.</p>
L	<p>DISPLAY CIP COMPONENTS INFORMATION.</p>

Option	Description
Z	EXTERNAL MEMORY (ESM) INITIALIZATION. Select this option to execute the clear ESM utility, ZAP.
<hr/> NOTE <hr/>	
This option should be performed after any power interruption or maintenance activity.	
<hr/>	
Refer to the clearing ESM procedure in section 6 for procedures and additional information about this option.	
M	DISK SUBSYSTEM MICROCODE LOAD. Select this option to load peripheral microcode into the 834/836, 844, 885, or 895 disk adapter and control module memory and install peripheral microcode onto specified drives. Refer to Loading and Installing Disk Subsystem Microcode from CIP Tape in section 6 for procedures and additional information about this option.

Deadstart Procedure Summaries

5

General Deadstart Procedures	5-1
Coldstart Procedures	5-9
Warmstart Procedures	5-9
Coldstart Procedure Summary for I1n, I4Cn and All I4n Class Systems	5-12
Warmstart Procedure Summary for I1n and All I4n Class Systems	5-16
Setting the Deadstart Panel for a Coldstart	5-18
Setting the Deadstart Panel/Program for a Warmstart	5-23
Coldstart of Tape Controllers for 667 or 669 Tape Units	5-27
Coldstart of 7021/7152 Tape Controllers From a Card Reader	5-28
Panel/Program Settings for Coldstart of 7021/7152 Tape Controllers From a Card Reader.....	5-28
Coldstart of 7152 Tape Controllers From a Tape Unit	5-30
Panel Settings for Coldstart of 7152 Tape Controllers From a Tape Unit	5-30
Coldstart of Disk Controllers for 844, 885-11/12, or 895 Disk Units	5-32
Coldstart of 7054/7154/7152/7155/7165 Disk Controllers From a Card Reader .	5-32
Panel Settings for the Coldstart of 7054/7154/7152/7155/7165 Disk Controllers From a Card Reader.....	5-33
Coldstart of 7152/7155/7165 Disk Controllers From a Disk Unit	5-35
Panel Settings for Coldstart of 7152/7155/7165 Disk Controllers From a Disk Unit	5-35
Coldstart/Warmstart of 834/836 Disk Subsystems From Disk	5-39
Deadstart Program for Coldstart/Warmstart of 834/836 Disk Controllers From a Disk Unit.....	5-41
Coldstart/Install of 834/836/844/885/895 Disk Subsystem Microcode From a CIP Tape.....	5-43
Coldstart of 639 Tape Units From Tape	5-43
Deadstart Program for Coldstart of 639 Tape Unit Controllers or 7155/7165 Disk Controllers from Tape	5-47
Coldstart of 698 Tape Units From Tape, I1n and I4n Class Systems	5-49
Deadstart Program for Coldstart of 698-xx Tape Unit From Tape (I1n, I4n Class Systems)/Deadstart Program for Coldstart of 698-xx Tape Unit From CI	
Coldstart of 698 Tape Units From CIP Device, I4Cn Class Systems	5-53
Setting Word 12	5-55
Setting Word 13	5-56
Selecting the Deadstart Level (NOS)	5-56
Selecting the Deadstart Level (NOS/BE)	5-60
Selecting the Deadstart Parameters	5-61
Selecting the CMRDECK (NOS)	5-62
Selecting the CMR (NOS/BE)	5-63
Selecting the DCFILE Deck (NOS/VE)	5-64

Deadstart is the process that makes the computer system operational and ready to process jobs. There are two deadstart procedures: coldstart and warmstart. Coldstart is the procedure used to deadstart the system when the tape or disk controllers do not have controlware loaded. Warmstart is the procedure used when controlware is loaded and executing correctly. The CIP installation procedures and operating system deadstart procedures in sections 2 through 4 are warmstart procedures.

In general, the procedure used most often to perform deadstarts is the warmstart. Warmstarting from mass storage, or a CDC 63X/667/669/698 magnetic tape unit, is only possible after the disk controller or tape controller to be used has been loaded with the proper controlware and only if the controlware is functioning properly. Warmstarts are always possible from 677/679 magnetic tape units.

Before you perform a warmstart, the following preliminary procedures might be required.

- Coldstart: Loads tape and disk controlware to their respective controllers.
- CIP installation to disk: Loads appropriate CIP modules (CTI, EI, HIVS/MSL, MDD, microcode, SCI, and SCD) to disk.

If a coldstart is required, you must do it before any other procedure. In some instances, coldstarts and warmstarts are combined into a single procedure (for example, coldstart/warmstart of the CDC 834 disk subsystem).

General Deadstart Procedures

If you are using a CC545 console, you initiate the deadstart process by momentarily pressing the DEADSTART button. This executes the peripheral processor (PP) deadstart program.

For I1n and all I4n Class systems, in addition to support of deadstart from a CC545, CIP also supports deadstart from CC634B and CC598B consoles which have been initialized to be the primary operator console. When deadstarting from a CC545 in a dual IOU environment which also has a CC598B console, the CC598B must be initialized and it must have the CONSOLE MAIN MENU displayed. For I4Cn Class systems, a CC598A console must be used to deadstart the system. Refer to section 2 for steps on using the CC598A or CC598B console as a primary console and to appendix H for procedures on initializing a CC634B console for use as a primary operator console.

When a CC634B display terminal has been initialized for use as the primary operator console, complete the following steps to bring up the DEADSTART OPTIONS shown in figure 5-1 (for I1n [except 815/825] and all single IOU I4n Class systems):

- ___ 1. Press the RESET button to reinitialize the console.
- ___ 2. Hold down the CTRL key while pressing the G key.
- ___ 3. When the message *OPERATOR ACCESS ENABLED* appears on the screen, hold down the CTRL key while pressing the R key.

NOTE

The CC634B console is supported as the primary console for I2n Class systems with the limitation that a CTRL-G/CTRL-R deadstart cannot be performed. To select the CC634B as the primary console, you must set bit 2 of deadstart panel word 12 to a one (refer to Setting Word 12, later in this section). You then initiate a deadstart by pressing the DEADSTART button on the CC634B, or on the CC545, or by utilizing the DEADSTART button or switch on the deadstart panel.

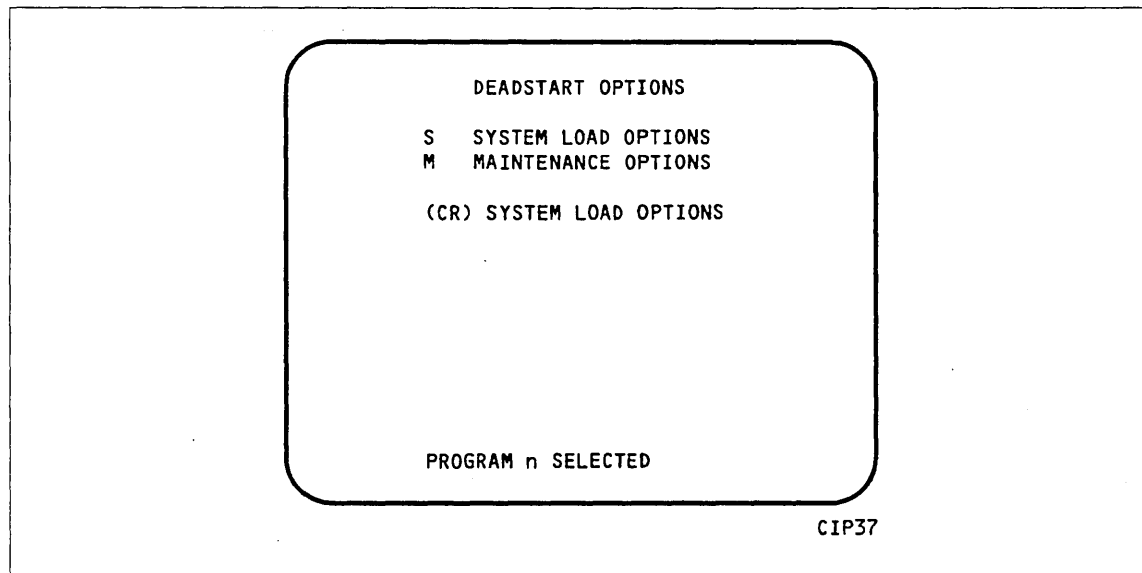

Figure 5-1. Deadstart Options Menu

If your primary operator console is a CC598B, perform the following steps to execute a deadstart.

- ___ 1. If the console is already initialized, but the CONSOLE MAIN MENU is not currently being displayed, simultaneously press the Ctrl and F2 keys to bring up the CONSOLE MAIN MENU (figure 5-2).
- ___ 2. If the console is not initialized, simultaneously press the Ctrl, Alt, and Del keys. The CDC logo will appear. Approximately ten seconds thereafter, the CONSOLE MAIN MENU (figure 5-2) will appear.
- ___ 3. If the appropriate deadstart program is selected, enter S or press the Enter key; the SYSTEM LOAD OPTIONS warning shown in figure 5-3 will appear. From this display, press the Enter key if you wish to proceed to the INITIAL OPTIONS display. Skip to step 6.
- ___ 4. If the appropriate deadstart program is not selected, perform one of the following steps from the CONSOLE MAIN MENU.
If you have a single IOU system:
 - ___ a. Enter M to bring up the MAINTENANCE OPTIONS - IOU0 display (see figure 5-5).
 - ___ b. Enter or retrieve the appropriate deadstart program.
 If you have a dual IOU system:
 - ___ a. Enter M to bring up the MAINTENANCE OPTIONS menu shown in figure 5-4. This menu allows you to select between options IOU0 or IOU1.¹
 - ___ b. Enter either 0 or 1 to bring up the MAINTENANCE OPTIONS - IOU0 or the MAINTENANCE OPTIONS - IOU1 display, respectively (see figure 5-5).
 - ___ c. Enter or retrieve the appropriate deadstart program.
- ___ 5. From the MAINTENANCE OPTIONS - IOUn display (figure 5-5), enter either S or L to execute a short or long deadstart. After executing a deadstart, you may proceed to select appropriate options from the CTI displays.
- ___ 6. You may now proceed to select appropriate options from the CTI displays.

1. An operating system deadstart is only supported from IOU0 and a deadstart load of CMSE is only supported for IOU1.

NOTE

All procedures discussed in this manual assume you have selected IOU0.

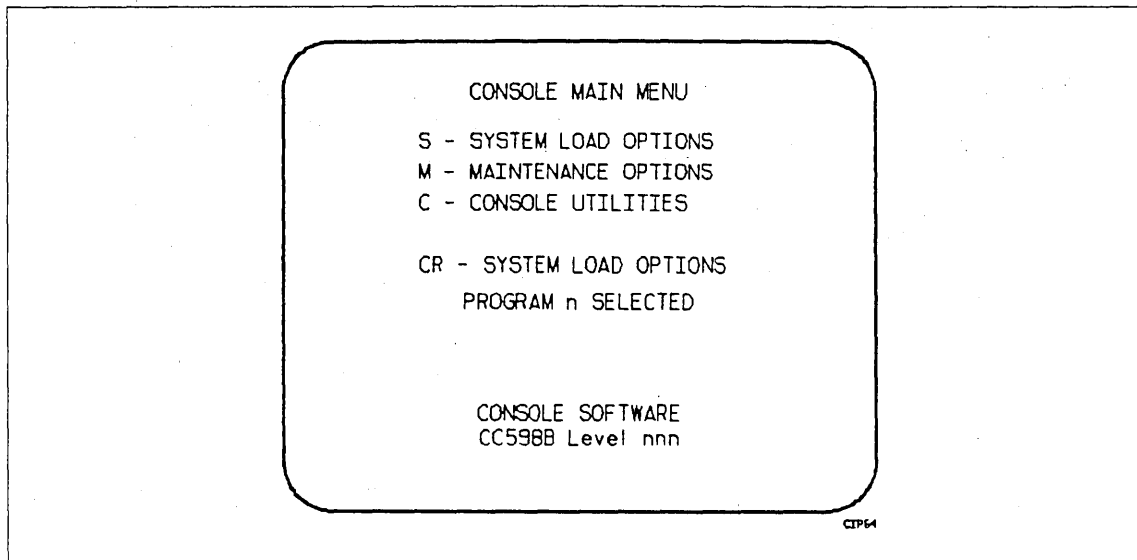

Figure 5-2. Console Main Menu (CC598B Console)

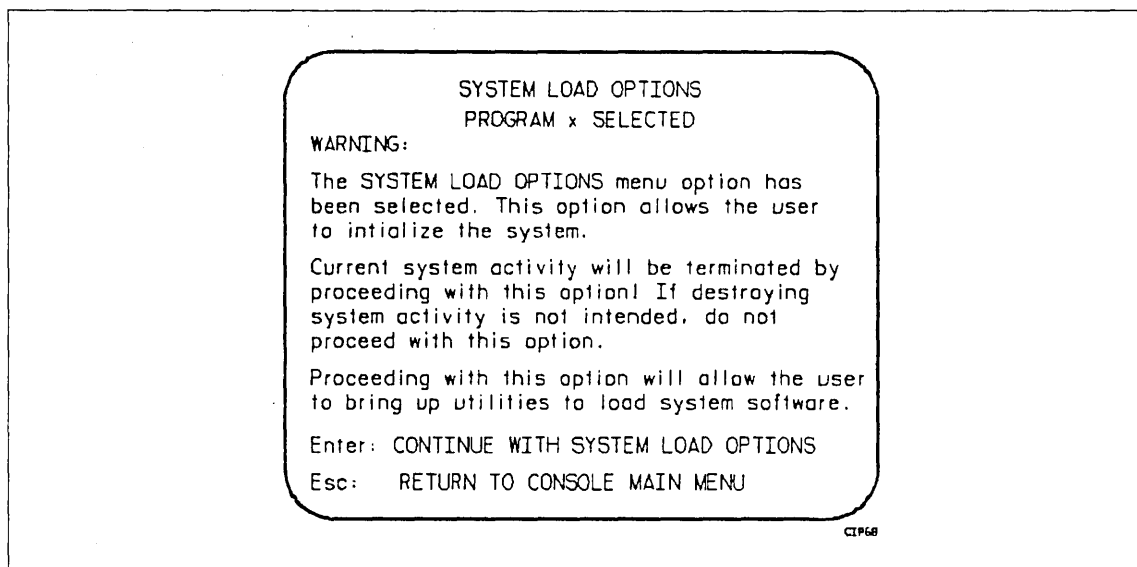

Figure 5-3. System Load Options Warning (CC598B Console)

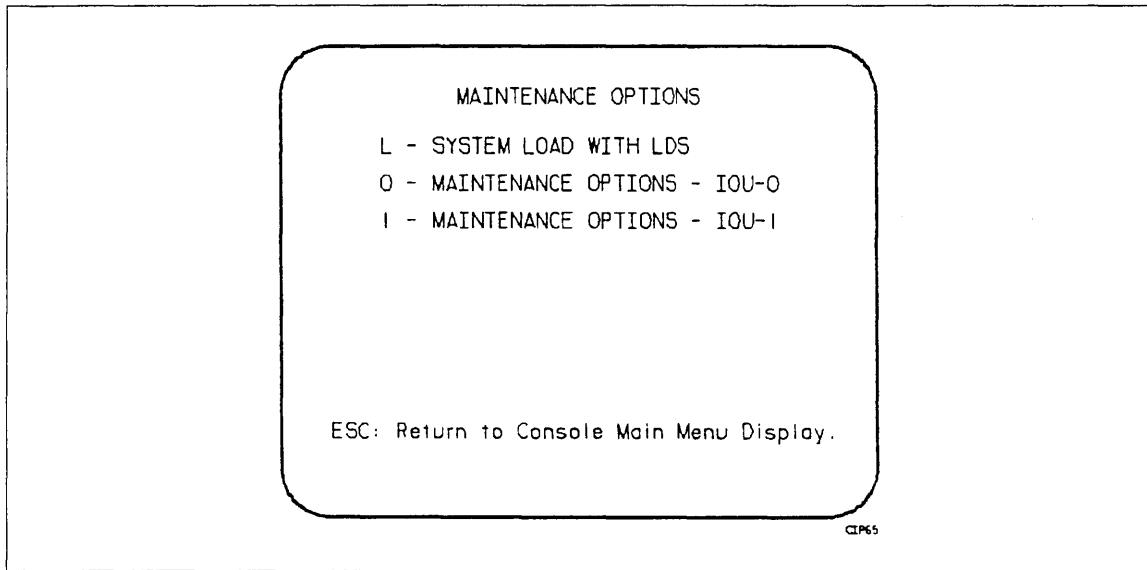

Figure 5-4. Maintenance Options Menu (CC598B Console - Dual IOU System)

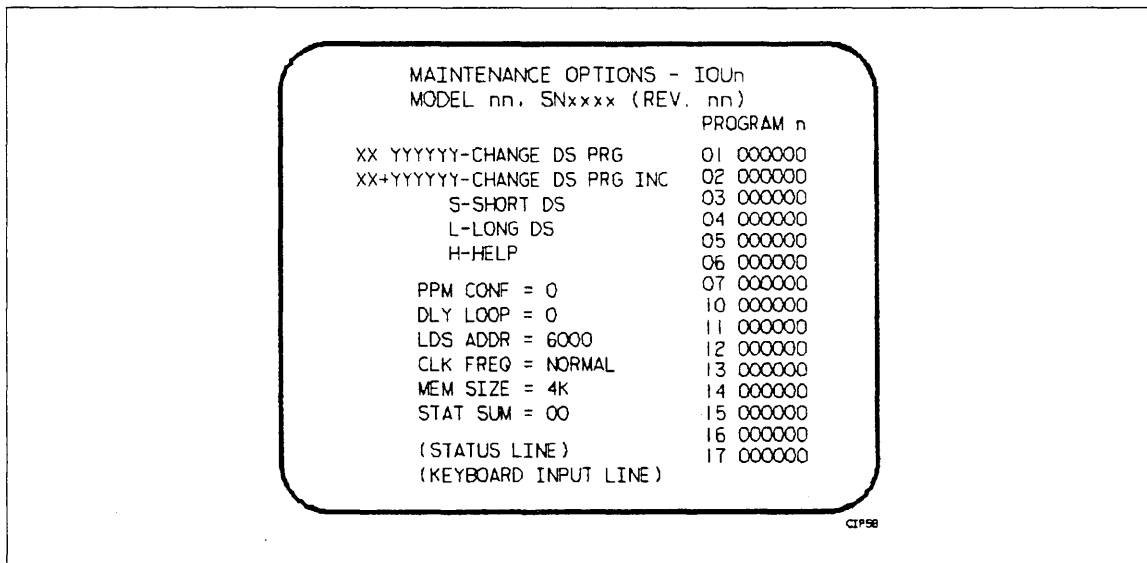

Figure 5-5. Maintenance Options - IOUn Display (CC598B Console)

If your primary operator console is a CC598A, perform the following steps to execute a deadstart.

- ___ 1. If the console is already initialized, but the CONSOLE MAIN MENU is not currently being displayed, simultaneously press the Ctrl and F2 keys to bring up the CONSOLE MAIN MENU (figure 5-6).
- ___ 2. If the console is not initialized, simultaneously press the Ctrl, Alt, and Del keys. The CDC logo will appear. Approximately ten seconds thereafter, the CONSOLE MAIN MENU (figure 5-6) will appear.
- ___ 3. If the appropriate deadstart program is selected, enter S or press the Enter/Return key; the SYSTEM LOAD OPTIONS warning shown in figure 5-7 will appear. From this display, press the Enter key if you wish to proceed to the INITIAL OPTIONS display. Skip to step 7.
- ___ 4. If the appropriate deadstart program is not selected, enter M from the CONSOLE MAIN MENU to bring up the MAINTENANCE OPTIONS menu. If your system has a single IOU, the MAINTENANCE OPTIONS menu shown in figure 5-8 will appear. If your system has a dual IOU, the MAINTENANCE OPTIONS menu shown in figure 5-9 will appear.
- ___ 5. Enter either 0 to bring up the MAINTENANCE OPTIONS - IOU0 display or 1 (dual IOU systems only) to bring up the MAINTENANCE OPTIONS - IOU1 display. Refer to figure 5-10.
- ___ 6. Enter either S or L to execute a short or long deadstart.
- ___ 7. You may now proceed to select appropriate options from the CTI displays.

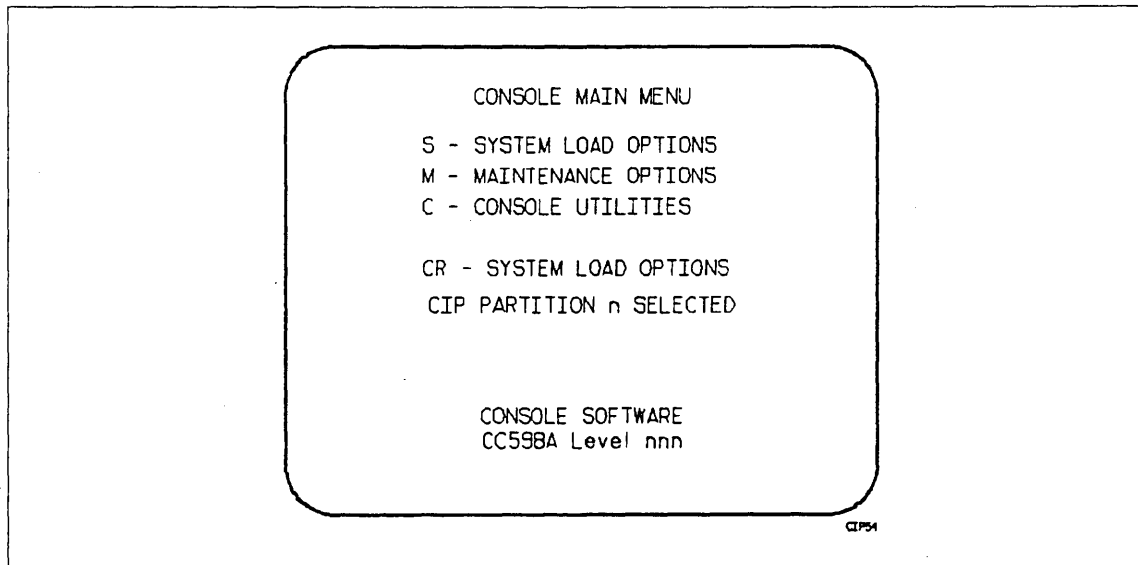

Figure 5-6. Console Main Menu (CC598A Console)

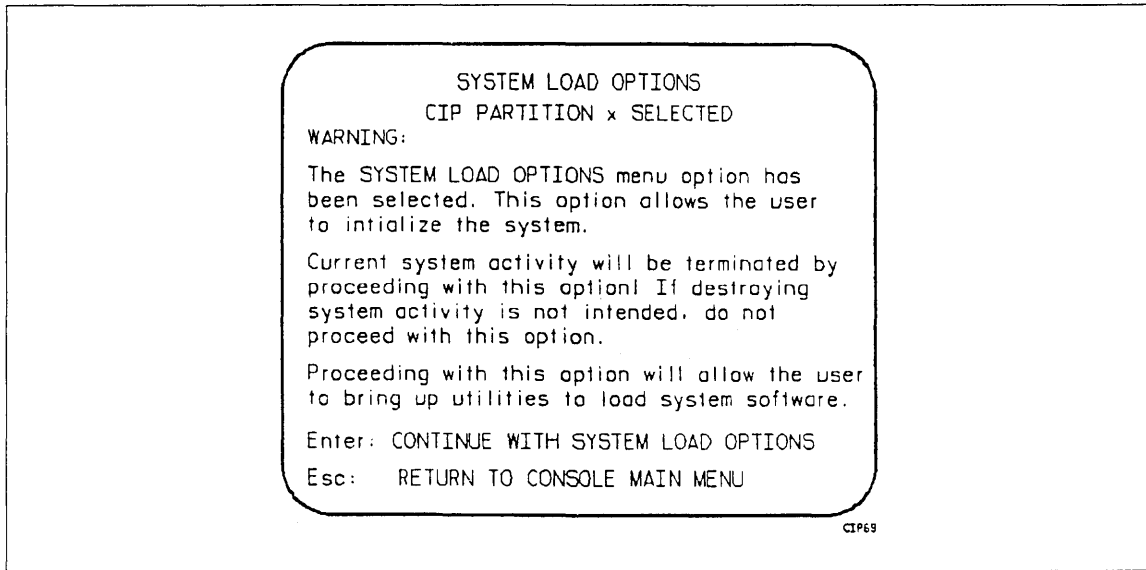

Figure 5-7. System Load Options Warning (CC598A Console)

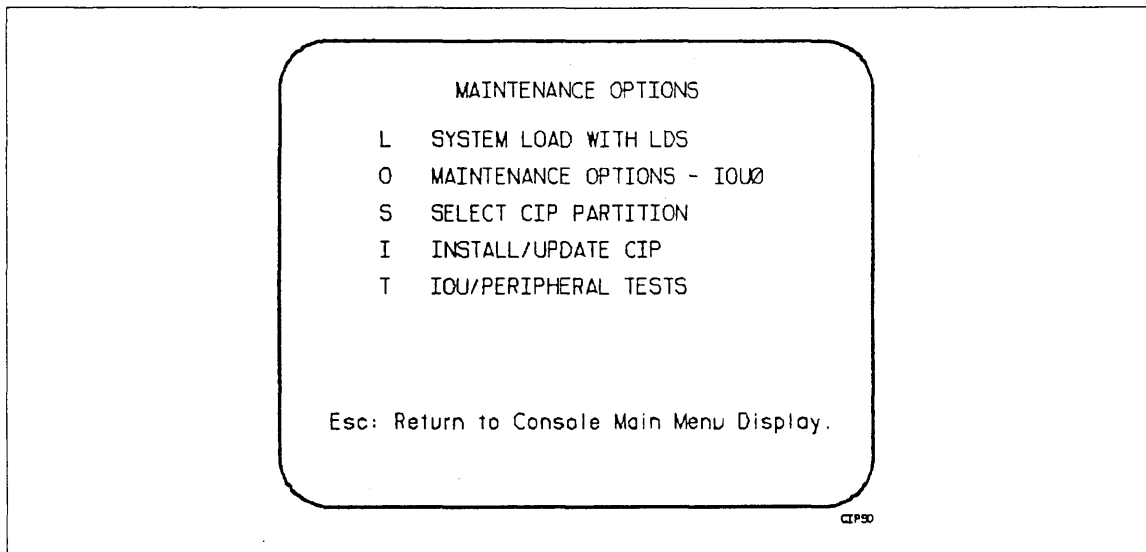

Figure 5-8. Maintenance Options Menu (CC598A Console, Single IOU System)

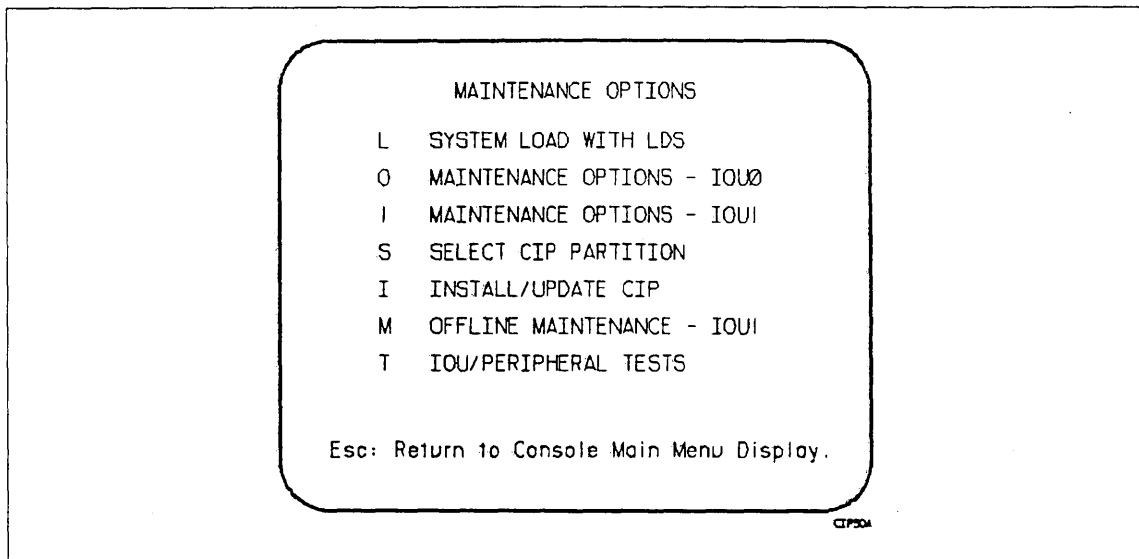

Figure 5-9. Maintenance Options Menu (CC598A Console, Dual IOU System)

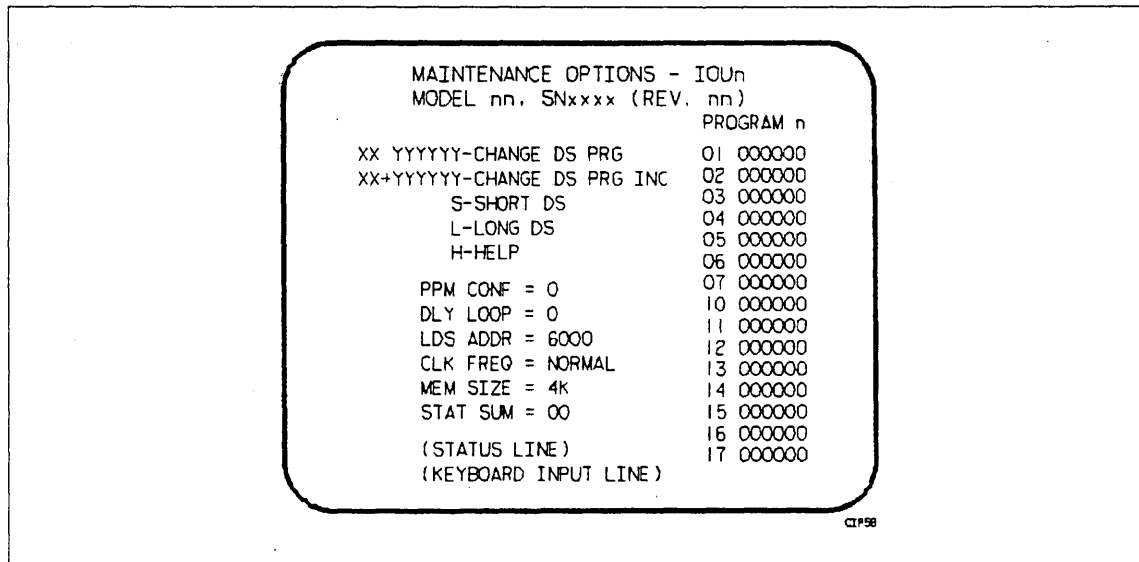

Figure 5-10. Maintenance Options - IOUn Display (CC598A Console)

NOTE

Attempts to perform deadstarts from mass storage could be unsuccessful in configurations with shared access to controllers and drives. Conflicts can arise in both single and multiple mainframe configurations. In a multi-mainframe configuration, if a certain mainframe requires a controller or drive for its deadstart, which another mainframe has reserved, the deadstart is delayed until the reservation is released. In a single mainframe configuration, if a certain channel has reserved a drive which is also required for a deadstart, the deadstart is unsuccessful. In this case, set the deadstart program for the other channel.

Coldstart Procedures

Coldstart procedures load tape and disk controllers with controlware. The manner in which controlware is loaded, however, depends on the type of controller a tape or disk unit utilizes.

For instance, the CDC 7021 tape controller, used in 667/669 magnetic tape units, requires its controlware be loaded from a card reader. On the other hand, the CDC 7152 tape controller can have its controlware loaded by either a card reader or by a tape unit. Similarly, the CDC 7054 and 7154 disk controllers must have their controlware loaded from a card reader, while the CDC 7152 and 7155 disk controllers (for CDC 844-41/44 and 885-11/12 disk storage units) can have their controlware loaded from either a card reader or a disk unit.

Controlware for the CDC 834/836 disk subsystem can be loaded into the disk control module and disk adapter from either the 834/836 disk or from tape.

This section contains summaries of the procedures needed to perform a coldstart. As these procedures apply to all mainframes except I1n, I4Cn, and all I4n Class systems, be sure to use the appropriate summary as a checklist during the deadstart process. Detailed descriptions of all procedures in the deadstart process are provided throughout the remainder of this section.

NOTE

This manual assumes that power is applied on all required equipment, and that the equipment is functioning properly. If at any time the system loses power or the equipment fails, consult the site analyst or CE.

Warmstart Procedures

Warmstart is the deadstart procedure used when the controlware is loaded and functioning properly. Figure 5-11 illustrates the general warmstart procedure. Detailed information concerning all phases of the deadstart process follows. Warmstart options are not needed in I4Cn Class system deadstart displays.

The following steps summarize the procedures necessary to perform a warmstart from a 639/66X/67X magnetic tape unit, a 834/836 disk unit, a 844 disk unit, or from a 885-11/12 disk unit. However, for I1n and all I4n Class systems, steps 3 and 4 must be interchanged. (For more complete information, refer to Warmstart Procedure Summary for I1n and All I4n Class Systems later in this section). Use these steps as a checklist during warmstarts.

- ___ 1. Ensure that required mass storage devices are available and that they have packs mounted.
- ___ 2. Mount the deadstart tape or pack.
- ___ 3. Set the deadstart panel/program for warmstart (refer to Setting the Deadstart Panel/Program for a Warmstart later in this section).
 - ___ a. Select the correct deadstart function.
 - ___ b. Select the correct CMRDECK number (NOS), DCFILE number (NOS/VE), or CMR number (NOS/BE).

- ___ 4. Complete the following steps to bring up the DEADSTART OPTIONS display or the CONSOLE MAIN MENU display.

NOTE

For Model 815/825, the INITIAL OPTIONS display will appear.

If using a CC545 console:

- ___ a. Press the DEADSTART button. The DEADSTART OPTIONS display will appear.

If using a CC634B display terminal as the primary operator console:

- ___ a. Press the RESET button to reinitialize the console.
- ___ b. Hold down the CTRL key while pressing the G key.
- ___ c. When the message *OPERATOR ACCESS ENABLED* appears on the screen, hold down the CTRL key while pressing the R key. The DEADSTART OPTIONS display will appear.

If using a CC598B display terminal as the primary operator console and if the console is already initialized, but the CONSOLE MAIN MENU is not currently being displayed:

- ___ a. Simultaneously press the Ctrl and F2 keys. The CONSOLE MAIN MENU will appear.

If using a CC598B display terminal as the primary operator console and if the console is not initialized:

- ___ a. Simultaneously press the Ctrl, Alt, and Del keys. The CDC logo will appear. Approximately ten seconds thereafter, the CONSOLE MAIN MENU will appear.

If deadstarting from a spun-down 834 or 836 disk unit, the initial display will not appear until the drive has completed spinning up (about 30 seconds).

- ___ 5. Enter S or press the Enter/Return key; the SYSTEM LOAD OPTIONS warning display (figure 5-3 or 5-6) will appear. From this display, press the Enter/Return key to proceed to the INITIAL OPTIONS display.

WARNING

Before pressing the Enter/Return key from the warning display (in order to proceed to the INITIAL OPTIONS display), be sure that you understand the consequences associated with this action.

- ___ 6. Select the correct CTI options.

NOTE

The CC634B console is supported as the primary console for I2n Class systems. To select the CC634B as the primary console you must set bit 2 of deadstart panel word 12 to a one (refer to Setting Word 12, later in this section). You then initiate a deadstart by pressing the DEADSTART button on the CC545 or CC634B console, or by activating the DEADSTART button or switch on the deadstart panel.

Continue to initialize the operating system or to load MSL as described in the appropriate operating system operator's guide or MSL manuals.

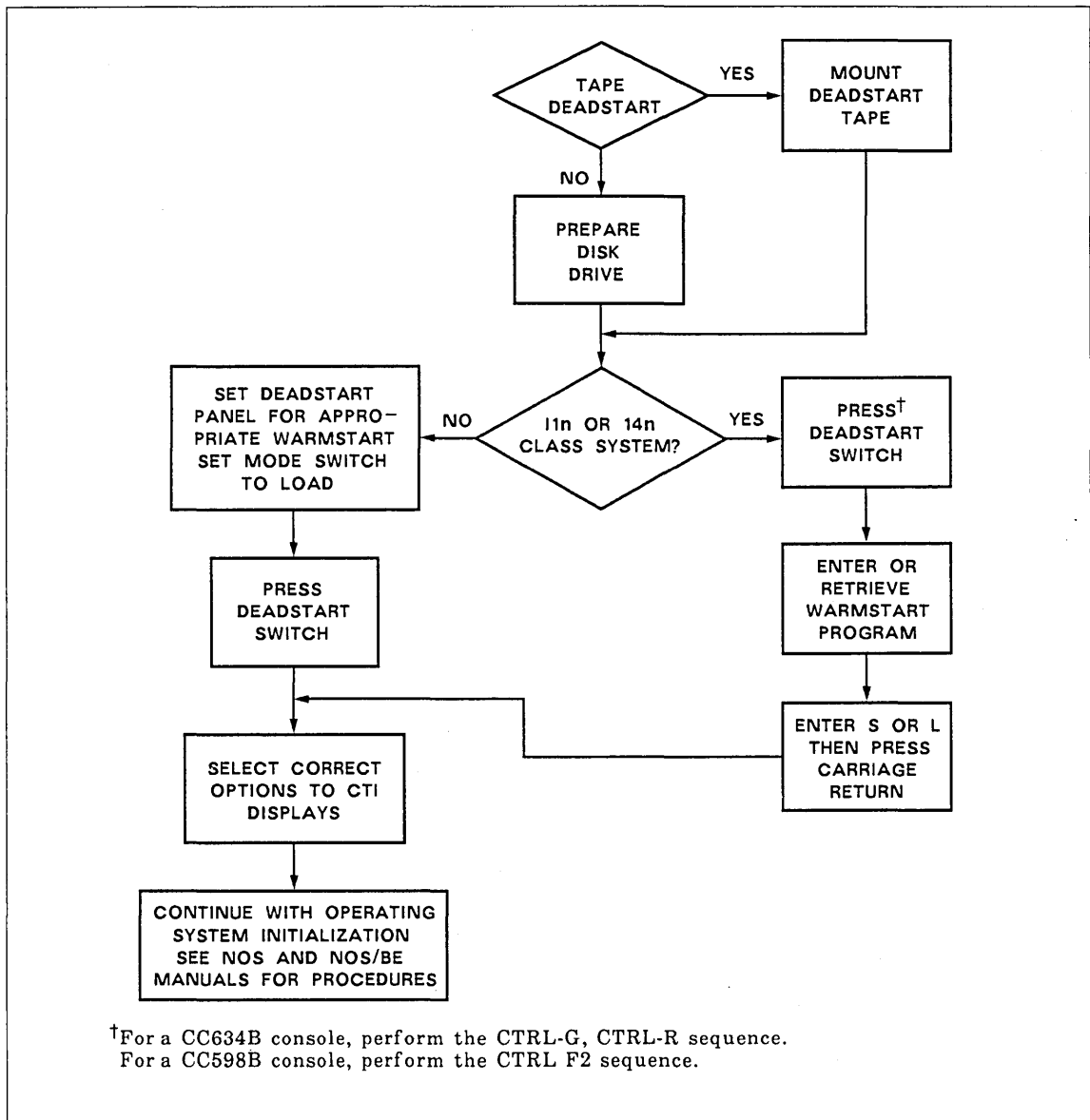

Figure 5-11. Warmstart

Coldstart Procedure Summary for I1n, I4Cn and All I4n Class Systems

The procedures to coldstart various controllers for I1n, I4Cn, or any I4n Class system are similar to those for other computer systems, except that this class of systems does not have a deadstart panel. The coldstart programs represented by the deadstart panel switch settings on I2n Class systems must be entered as octal numbers on the console keyboard of I1n, I4Cn, and all I4n Class systems. Otherwise, coldstart programs for I1n, I4Cn, and all I4n Class systems are identical to those for I2n Class systems (except where specifically noted).

In the various coldstart procedures described in this section, deadstarting an I1n model (except 815/825) or any single IOU I4n Class system model brings up the DEADSTART OPTIONS shown in figure 5-1. Selecting option M from the DEADSTART OPTIONS display brings up the MAINTENANCE OPTIONS shown in figure 5-12, and selecting option S or pressing the carriage return key from the DEADSTART OPTIONS display brings up the INITIAL OPTIONS display (refer to section 2).

Because the DEADSTART OPTIONS display is not provided for model 815/825 of the I1n system, deadstarting on the 815/825 automatically displays the MAINTENANCE OPTIONS shown in figure 5-12.

MAINTENANCE OPTIONS (REV. 03)	
	PROGRAM 0
XX YYYYYY-CHANGE DS PRG	01 001402
XX+YYYYYY-CHANGE DS PRG INC	02 007303
S-SHORT DS	03 000017
L-LONG DS	04 007503
H-HELP	05 007703
	06 000301
	07 007403
PPM CONF = 00	10 007103
BRL CONF = 0	11 007301
DLY LOOP = 0	12 000710
LDS ADDR = 6000	13 000376
CLK FREQ = NORMAL	14 000000
CM RECONF SW3 = C	15 000000
SW4 = C SW5 = C	16 000000
	17 000000
	20 007112

CIP386

Figure 5-12. Maintenance Options Display for I1n and Single IOU I4n Class Systems

On a dual IOU I4n or on a I4Cn Class system, simultaneously pressing the Ctrl and F2 keys on the CC598A/CC598B system console will bring up the CONSOLE MAIN MENU, then entering an M will bring up the MAINTENANCE OPTIONS menu, and selecting O will bring up the two-port mux MAINTENANCE OPTIONS - IOU0 display.

On a single IOU I4n Class system, simultaneously pressing the Ctrl and F2 keys on the CC598B system console will bring up the CONSOLE MAIN MENU, then entering an M will lead directly to the two-port mux MAINTENANCE OPTIONS - IOU0 display.

The bottom line of the DEADSTART OPTIONS display (I1n [except 815/825] or any I4n Class system) identifies which deadstart program is selected and is to be executed. If this is not the desired deadstart program, enter M to bring up the MAINTENANCE OPTIONS display. I4n Class systems having a dual IOU configuration will have an extra MAINTENANCE OPTIONS display, as shown in figure 5-4. This allows you to select IOU0 or IOU1. An operating system deadstart is supported for IOU0 only. If you select IOU1, you will get the MAINTENANCE OPTIONS - IOU1 display. You can only perform a deadstart load of CMSE from IOU1.

The following paragraphs describe how to retrieve or modify the deadstart program from the MAINTENANCE OPTIONS display (I1n or any I4n Class system) or from the MAINTENANCE OPTIONS - IOU-x display (I4Cn and dual IOU I4n Class systems). The coldstart program, if already stored in the microprocessor, may be retrieved by entering:

GP n

where n (0 through 3) is the number of the stored program. Changing instructions within a program, such as the unit number or other parameters, will be described in this section. These changes are not retained across deadstarts unless the new program is stored, as outlined later in this section.

If the correct coldstart program is not stored, or if a new program is to be entered and stored, the program must be entered through the console keyboard as octal numbers equivalent to the switch settings on deadstart panels for other models.

Enter the coldstart program, represented by the switch settings shown in the related deadstart panel figure for your configuration, by entering:

xx yyyyyy (or xx.yyyyyy, or xx,yyyyyy)

where xx is the octal row number of the deadstart instruction and yyyyyy is the octal number equivalent of the actual instruction. When you enter a six-digit instruction, the first two digits of the instruction must be zeros. Leading zeros in both the octal row number and the instruction, however, need not be entered. For example, if the row number was 03 and the instruction was 001014, you could enter:

3 1014

and get the same setting as entering:

03 001014

If you want the system to automatically increment the octal row number, the entry after which the increment is to occur is:

xx+yyyyyy

The + character indicates that the system is to automatically increment the octal row number. When the automatic increment is in effect, the system displays the next location (after accepting the previous entry), and then only the next instruction need be entered.

To cancel the automatic incrementing, press the left blank (erase) key after the octal row number appears.

To store a new program or a modified program, enter:

SP n

where n (0 through 3) is the number of the program to be stored. If a program is already stored at the specified number, the new program replaces it.

After entering or retrieving the desired coldstart program, enter:

S

then press the carriage return key to coldstart the controller.

NOTE

The only device within an I4Cn environment that may be coldstarted is the 698 tape subsystem.

Warmstart Procedure Summary for I1n and All I4n Class Systems

The procedure to warmstart I1n and all I4n Class systems is similar to procedures for other computer systems, except that these models do not have a deadstart panel. The warmstart programs represented by the deadstart panel switch settings on an I2n Class system are entered as octal numbers through an I1n or an I4n Class system console keyboard. Warmstart programs for the I1n and all I4n Class systems are identical to those for I2n Class systems (except where noted).

In the various warmstart procedures described throughout this section, deadstarting an I1n Class system (except model 815/825) or a single IOU I4n Class system activates the DEADSTART OPTIONS display shown in figure 5-1. Selecting option M on this display brings up the MAINTENANCE OPTIONS display (figure 5-12). Selecting option S or pressing the carriage return key brings up the INITIAL OPTIONS display (refer to section 2). Because the DEADSTART OPTIONS display is not provided for model 815/825 of the I1n system, deadstarting on the 815/825 automatically sequences to the MAINTENANCE OPTIONS display (figure 5-12).

The bottom line of the DEADSTART OPTIONS display (I1n system [except model 815/825]) identifies which deadstart program is selected and is to be executed. If the displayed option is not the desired deadstart program, enter M to bring up the MAINTENANCE OPTIONS display. The following paragraphs describe how to retrieve or modify the deadstart program.

If the desired warmstart program is stored in the microprocessor, retrieve it by entering:

```
GP n
```

where n (0 through 3) is the number of the desired program. You can change individual instructions in a program, such as a unit number or other parameters, as described in following paragraphs. These changes are not retained across deadstarts unless this new program or a modified program is stored as described later in this section.

You can use the space bar to cycle through the stored programs. If the correct warmstart program is not stored or if a new program is to be entered and stored, the program must be entered as octal numbers equivalent to the switch settings on the deadstart panels of other models.

You can also change the warmstart program (represented by the switch settings shown in the related deadstart panel figure) for your configuration by entering:

```
xx yyyyyy (or xx.yyyyyy, or xx,yyyyyy)
```

where xx is octal row number of the deadstart instruction and yyyyyy is the octal number equivalent to the actual instruction.

When you enter a six-digit instruction, the first two digits of the instruction must be zeros. Leading zeros in both the octal row number and the instruction, however, need not be entered. For example, if the row number was 03 and the instruction was 000017 you could enter:

3 17

and get the same setting as entering:

03 000017.

If you want the system to automatically increment the octal row number, the entry after which the increment is to occur is:

xx+yyyyyy

The + character indicates that the system is to automatically increment the octal row number. When the automatic increment is in effect, the system displays the next location after accepting the previous entry. Only the next instruction need be entered.

To cancel the automatic incrementing, press the left blank (erase) key after the octal row number appears.

To store a new program or a modified program, enter:

SP n

where n (0 through 3) is the number of the program to be stored. If a program is already stored at the specified number, the new program replaces it.

After entering or retrieving the desired warmstart program, enter:

S

and then press the carriage return key for a short deadstart sequence, or enter:

L

and then press the carriage return key for a long deadstart sequence.

When system power is applied to an I1n Class system mainframe, the microprocessor can automatically retrieve the warmstart program, which has been stored as program number 3, and initiate a long deadstart sequence. If you want this automated feature, store the warmstart program for your configuration as program number 3. If you do not want this feature, store the first word of program 3 as 000300. This instruction places the PPO resident program into a loop. Consequently, no deadstart activity occurs and no displays appear on the screen, rather, you must press the deadstart button to bring up the initial deadstart display. You can then retrieve or enter the desired warmstart program and select a short or long deadstart sequence.

Setting the Deadstart Panel for a Coldstart

All systems, excluding I1n, I4Cn, and all I4n Class systems have a matrix of toggle switches on their respective deadstart panels. The manipulation of these switches comprise the deadstart program.

The deadstart panel for all models of the CYBER 170 computer system contains a 16-by-12 matrix of toggle switches (see figure 5-13). The matrix rows are numbered from 1 to 20g. In CYBER 70 and 6000 computer systems, however, the deadstart panel (see figure 5-14) contains a 12-by-12 matrix with rows numbered from 0001 to 0014g.

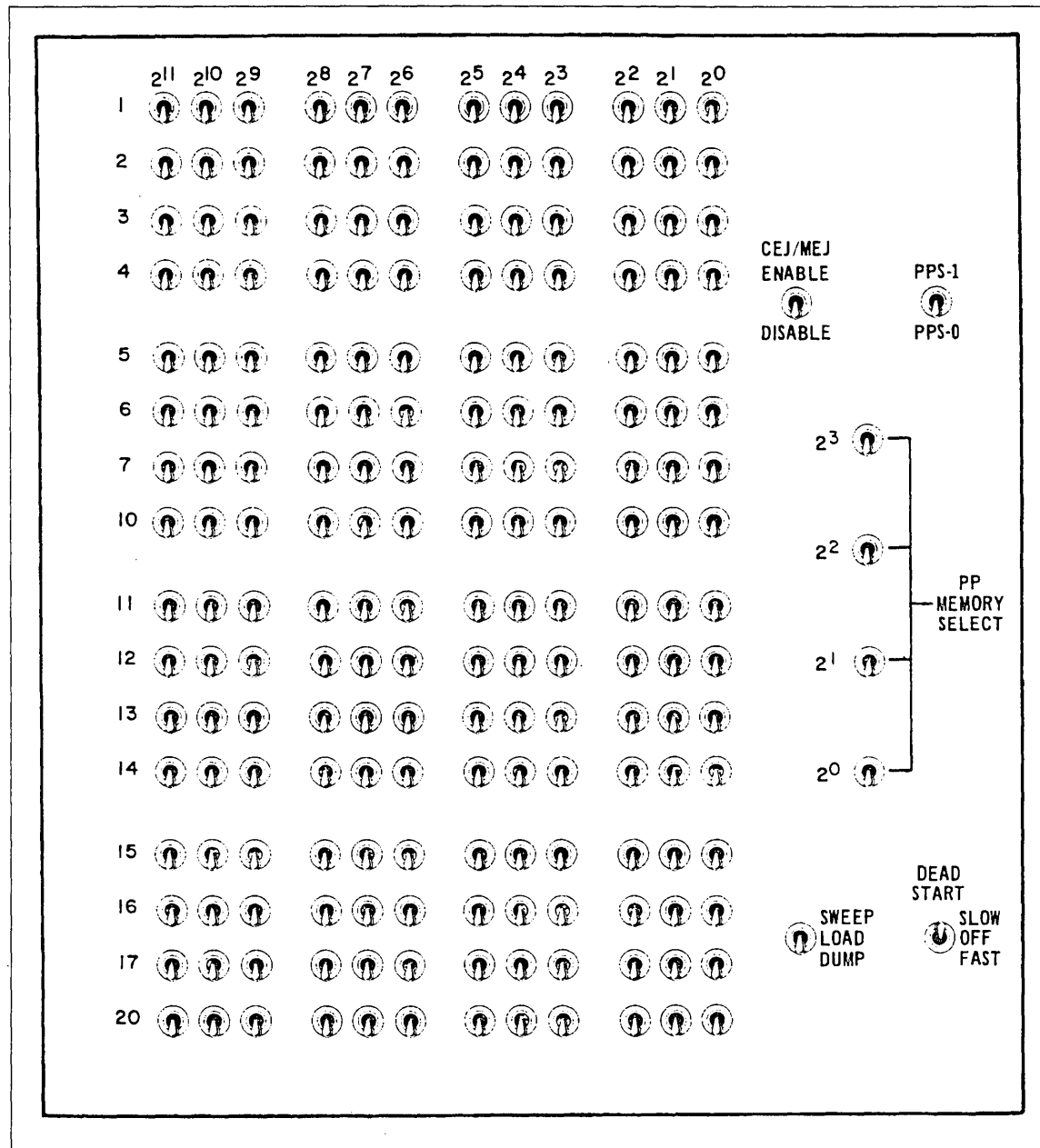

Figure 5-13. CYBER 170 Computer Systems Deadstart Panel

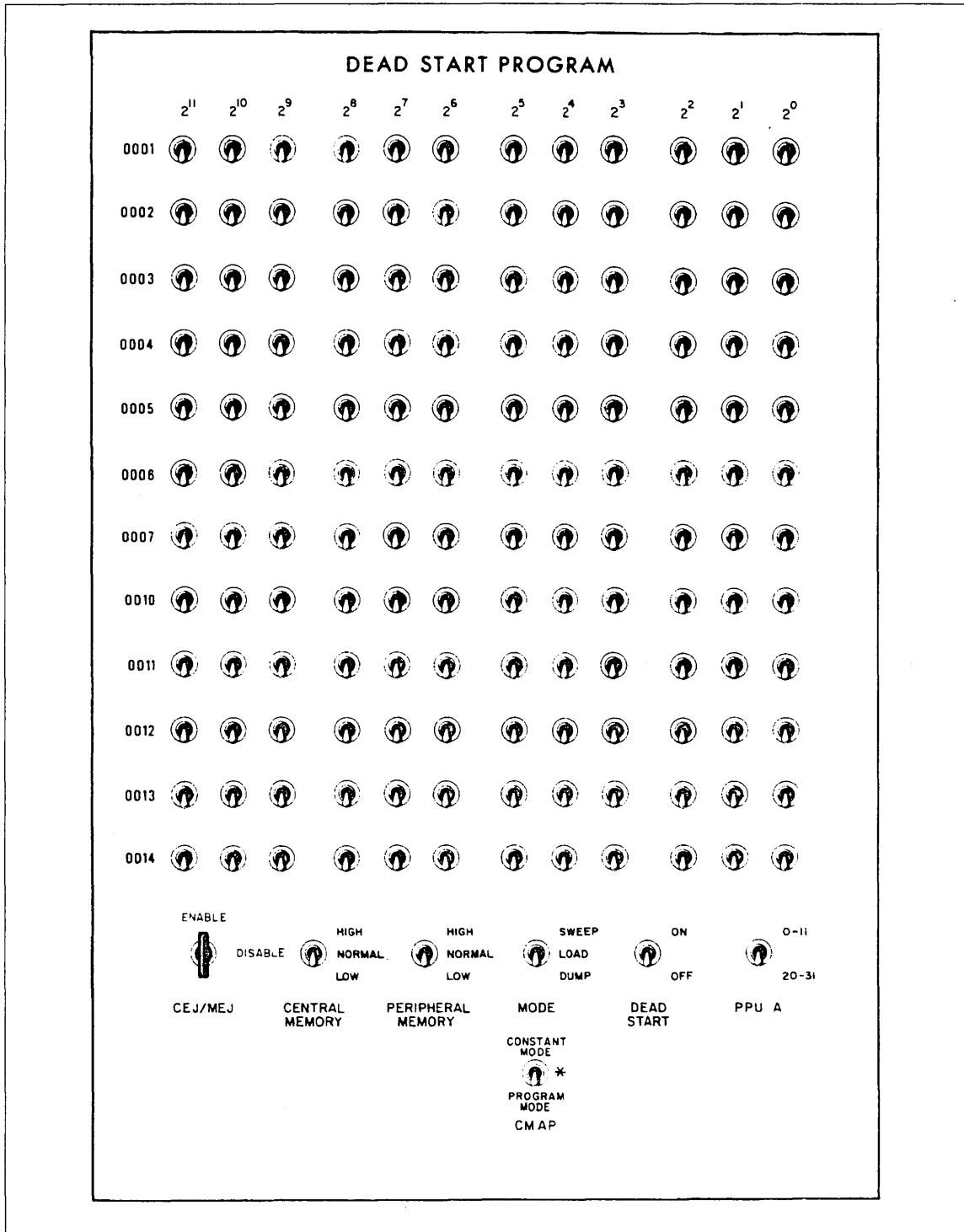

Figure 5-14. CYBER 70/6000 Computer Systems Deadstart Panel

Each row of switches on the deadstart panel represents a 12-bit PP instruction word in the deadstart program. Thus, by setting these switches in a prescribed manner, you create the program necessary for a deadstart. This deadstart program is subsequently loaded into PP0 memory and it is executed whenever you press the DEADSTART button.

The deadstart program:

- Identifies the tape/disk unit, controller, and channel number to be used to access the deadstart device (specified in words 1 through 10).
- Reads the first record from the deadstart file. This routine initiates the processing of the remainder of the deadstart file according to the options specified in the deadstart program (word 13).

The deadstart panel for I2n Class systems (see figure 5-15) contains a 16-by-16 matrix of toggle switches with rows numbered from 1 to 20₈. To deadstart any I2n Class system, set the four leftmost columns of switches (columns 2¹² through 2¹⁵) to the down position.

NOTE

All switches in columns 2¹² through 2¹⁵ must be in the down position for proper operation of I2n Class systems.

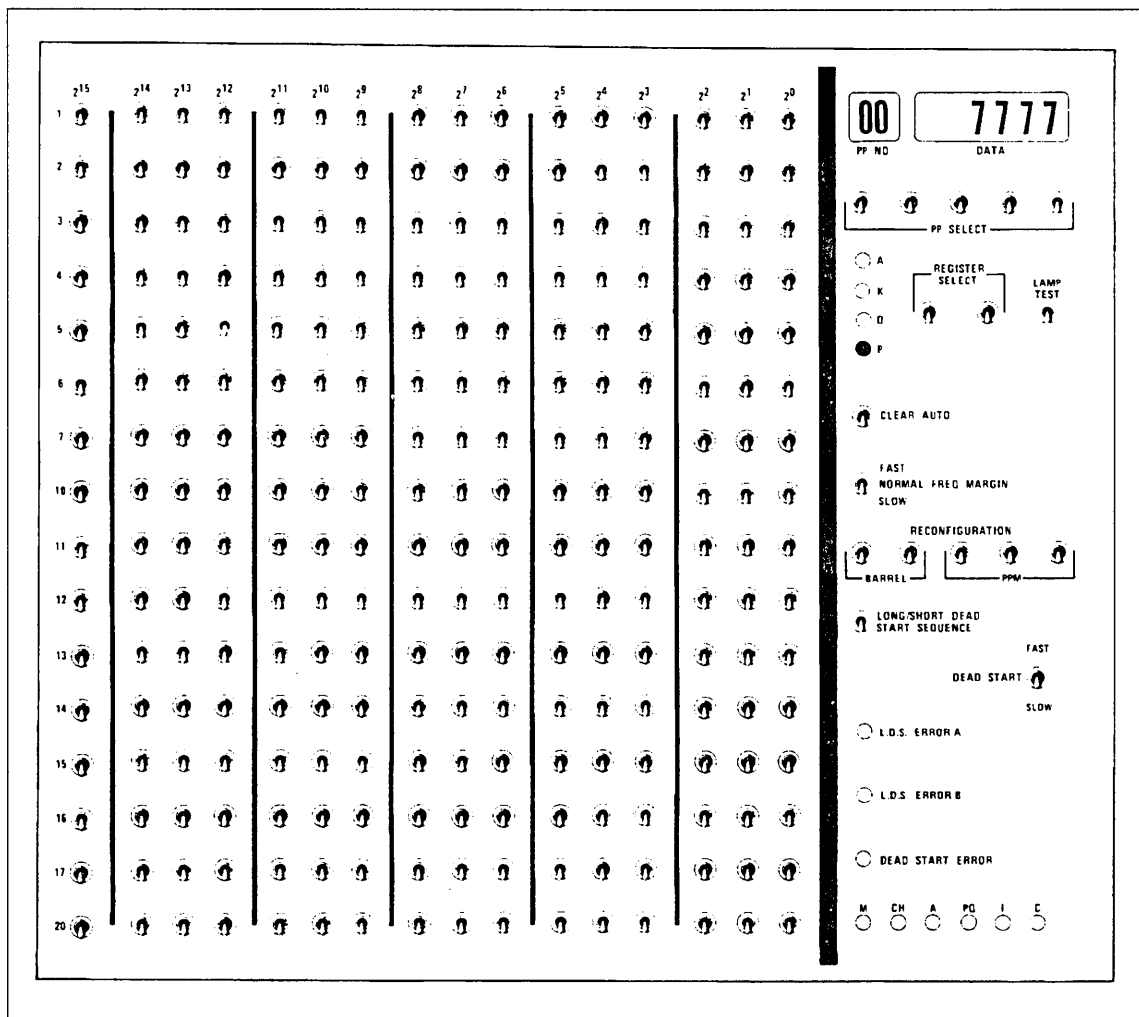

Figure 5-15. I2n Class Systems Deadstart Panel

Use the 12 rightmost columns of switches to set the 12-bit PP instruction words which comprise the deadstart program. This program is subsequently loaded into PP0 memory and is executed whenever you press the DEADSTART button.

For I2n Class systems select one of these deadstart options:

Option	Action
No testing	Set the LONG/SHORT DEADSTART SEQUENCE switch to the down (short) position.
Confidence testing	Set the LONG/SHORT DEADSTART SEQUENCE switch to the up (long) position. This option destroys some information in PP memory (refer to Performing an Express Deadstart Dump in section 6).
Extended deadstart testing	Set the LONG/SHORT DEADSTART SEQUENCE switch to the up (long) position and set the rightmost bit (2^0) of word 12 to the up position. This option destroys some information in PP memory (refer to Performing an Express Deadstart Dump in section 6).

For normal operator deadstarts, performing the confidence test and extended deadstart test is not necessary. These tests are usually done after maintenance is performed on the system. Refer to the appropriate hardware reference manual for more information on extended deadstart testing.

NOTE

Before pressing the DEADSTART button, set the mode switch on the deadstart panel to LOAD (for all systems except I1n, I2n, I4Cn, and all I4n Class systems) and set the CMAP switch to CONSTANT MODE (for the CYBER 70 and 6000 computer systems).

In the following deadstart panel illustrations, switch position 1 (in the up position) and switch position 0 (in the down position) are mandatory settings. The switch positions for fields represented by alphabetic characters, however, are determined by each installation. Octal values entered on the I1n, I2n, I4Cn, and all I4n Class systems deadstart displays appear to the right of the panel illustrations.

For all computer systems except I1n, I2n, I4Cn, and all I4n Class systems, the CEJ/MEJ option is logically enabled by default. NOS does not run if the CEJ/MEJ option is disabled. For I1n, I2n, and all I4n Class systems, CEJ/MEJ is permanently enabled; you cannot turn it off.

For all computer systems (except I1n, I2n, I4Cn, and all I4n Class systems), if the CEJ/MEJ switch or key is physically disabled on the deadstart panel and if you do not logically override it via the HARDWARE RECONFIGURATION display (refer to the OPERATOR INTERVENTION display for your model of computer system), the system displays the following error message after you press the final carriage return for the the CTI options.

```
CEJ/MEJ OPTION NOT ENABLED
FOR CEJ/MEJ USAGE, ENABLE SWITCH
ON DEADSTART PANEL AND DEADSTART
```

```
(CR) FOR NON CEJ/MEJ USAGE
```

The preceding conditions are also true if your computer system does not contain a CEJ/MEJ switch or key. The same error message also appears if the CEJ/MEJ switch or key fails, or if the CEJ/MEJ option has not been logically disabled.

To utilize the CEJ/MEJ option, enable the switch or key on the deadstart panel and deadstart again.

NOTE

For CYBER 70 and 6000 computer systems, turn the CEJ/MEJ key fully counterclockwise to enable CEJ/MEJ. Turn the key fully clockwise to disable CEJ/MEJ.

Setting the Deadstart Panel/Program for a Warmstart

There are two types of warmstart panel settings: one for a CIP device connected to a channel with a PP and the other for a CIP device connected to a channel without a PP. When the deadstart device is connected to a channel with a PP, the panel settings will differ (since CYBER 70/6000 deadstart panels have fewer switches).

NOTE

When deadstarting from a 7054 or 7154 disk controller, incorrect panel settings, such as channel or unit numbers, can hang the controller. To free the controller, correct the panel settings and master clear the controller by pressing, in sequence, the STOP, MASTER CLEAR, and GO buttons, which are located inside the controller chassis.

The deadstart device on which the deadstart tape or disk pack is mounted, its associated controller, and the channel used to access this equipment are identified by setting the switches/bits shown in the unshaded area of the deadstart panels/programs as illustrated in figures 5-16, 5-17, and 5-18 (refer to appendix F to determine which channels in your hardware configuration do not have PPs).

	Binary				Octal
1	001	100	000	010	1402
2	111	011	0cc	ccc	73cc
3	000	000	001	111	0017
4	111	101	1cc	ccc	75cc
5	111	111	0cc	ccc	77cc
6	eee	ddd	ddd	ddd	eddd
7	111	100	0cc	ccc	74cc
10	111	001	0cc	ccc	71cc
11	111	011	000	001	7301
12	000	000	000	cfa	0000
13	rrr	ppp	xxx	xxx	rp [†] xx
14	000	000	000	000	0000
15	000	000	000	000	0000
16	000	000	000	000	0000
17	000	000	000	000	0000
20	111	001	001	010	7112

[†]The instructions for setting the bits represented by these parameters are given under Setting Word 13 later in this section.

Figure 5-16. CYBER 170 and I1n, I2n, and All I4n Class Systems Panel/Program Settings for Warmstarts from a Channel with a PP (For Example, Channel 1, 2, or 11)

Descriptions of the deadstart panel/program parameters for I1n, I2n, and all I4n Class systems follow; refer to figure 5-16.

Parameter	Description								
cc ccc	Channel number used to access the deadstart equipment.								
eee	Controller number to which the deadstart tape unit is connected.								
ddd ddd ddd	Tape deadstart function; depends on device type as follows: <table border="0" style="margin-left: 2em;"> <tr> <td>001 01u uuu</td> <td>639, 698 tape units.</td> </tr> <tr> <td>010 11u uuu</td> <td>66X tape units.</td> </tr> <tr> <td>001 01u uuu</td> <td>677 tape units at 800 cpi and all 679 tape units.</td> </tr> <tr> <td>011 01u uuu</td> <td>677 tape units at 556 cpi.</td> </tr> </table> <p>where u uuu represents the physical unit number on which the deadstart tape is mounted.</p>	001 01u uuu	639, 698 tape units.	010 11u uuu	66X tape units.	001 01u uuu	677 tape units at 800 cpi and all 679 tape units.	011 01u uuu	677 tape units at 556 cpi.
001 01u uuu	639, 698 tape units.								
010 11u uuu	66X tape units.								
001 01u uuu	677 tape units at 800 cpi and all 679 tape units.								
011 01u uuu	677 tape units at 556 cpi.								
c	Specifies whether system displays are to appear on the CC545 or on the CC634B for I2n Class systems.								
f	No longer applicable.								
a	Specifies an extended deadstart sequence option for I1n, I2n, and all I4n Class systems.								
rrr	Deadstart level. (Not used by NOS/VE).								
ppp	Deadstart parameters.								
xxx xxx	CMR number (NOS/BE), CMRDECK number (NOS) or DCFILE number (NOS/VE).								

	<u>Binary</u>				<u>Octal</u>
1	001	100	000	010	1402
2	111	011	0cc	ccc	73cc
3	000	000	001	111	0017
4	111	101	1cc	ccc	75cc
5	111	111	0cc	ccc	77cc
6	eee	ddd	ddd	ddd	eddd
7	111	100	0cc	ccc	74cc
10	111	001	0cc	ccc	71cc
11	111	011	000	001	7301
12	rrr	ppp	xxx	xxx	rpxx [†]
13	000	000	000	000	0000
14	111	001	001	010	7112

[†]The instructions for setting the bits represented by these parameters are given under Setting Word 13 later in this section.

Figure 5-17. CYBER 70 and 6000 Computer Systems Panel Settings for Warmstarts from a Channel with a PP (For Example, Channel 1, 2, or 11)

	<u>Binary</u>				<u>Octal</u>
1	000	000	000	000	0000
2	000	000	000	000	0000 [†]
3	000	000	000	000	0000 [†]
4	111	101	1cc	ccc	75cc [†]
5	111	111	0cc	ccc	77cc
6	eee	ddd	ddd	ddd	eddd ^{††}
7	111	100	0cc	ccc	74cc
10	111	001	0cc	ccc	71cc
11	111	011	000	001	7301
12	000	000	000	cfa	0000
13	rrr	ppp	xxx	xxx	rpxx ^{†††}
14	000	000	000	000	7112

[†]If a 6681 data channel converter is the first equipment on the channel, or if it precedes the the deadstart device controller, words 2, 3, and 4 must be set as follows:

	<u>Binary</u>				<u>Octal</u>
2	111	101	1cc	ccc	75cc
3	111	111	0cc	ccc	77cc
4	010	001	000	000	2100

^{††}eddd for tape; dddd for disk deadstart.
^{†††}The instructions for setting the bits represented by these parameters are given under Setting Word 13 later in this section.

Figure 5-18. CYBER 70 and 6000 Computer Systems Panel Settings for Warmstarts from a Channel with No PP (For Example, Channel 0, 12, or 13)

Descriptions of the deadstart panel parameters for figures 5-17 and 5-18 follow.

Parameter	Description								
cc ccc	Channel number used to access the deadstart equipment.								
eee	Controller number to which the deadstart tape unit is connected.								
ddd ddd ddd	Tape deadstart function; depends on device type as follows: <table border="0" style="margin-left: 2em;"> <tr> <td>001 01u uuu</td> <td>639, 698 tape units.</td> </tr> <tr> <td>010 11u uuu</td> <td>66X tape units.</td> </tr> <tr> <td>001 01u uuu</td> <td>677 tape units at 800 cpi and all 679 tape units.</td> </tr> <tr> <td>011 01u uuu</td> <td>677 tape units at 556 cpi.</td> </tr> </table> <p>where u uuu represents the physical unit number on which the deadstart tape is mounted.</p>	001 01u uuu	639, 698 tape units.	010 11u uuu	66X tape units.	001 01u uuu	677 tape units at 800 cpi and all 679 tape units.	011 01u uuu	677 tape units at 556 cpi.
001 01u uuu	639, 698 tape units.								
010 11u uuu	66X tape units.								
001 01u uuu	677 tape units at 800 cpi and all 679 tape units.								
011 01u uuu	677 tape units at 556 cpi.								
c	Specifies whether system displays are to appear on the CC545 or on the CC634B for I2n Class systems.								
f	No longer applicable.								
a	Specifies an extended deadstart sequence option for I1n, I2n, and all I4n Class systems.								
rrr	Deadstart level. (Not used by NOS/VE).								
ppp	Deadstart parameters.								
xxx xxx	CMR number (NOS/BE), CMRDECK number (NOS) or DCFILE number (NOS/VE).								

Note from the footnote of the example shown in figure 5-18 that if a disk were used instead of a tape unit for the deadstart, line 6 of the example program would have been dddd instead of eddd. This variation in conventions is described as follows.

Parameter	Description
ddd ddd ddd ddd	Disk deadstart function; depends on device type as follows:
000 011 uuu uuu	844 or 885-11/12 disk units.
000 011 ccc uuu	834 or 836 disk units. Control module self-checking diagnostics are executed. The initial options display usually appears after 15 to 30 seconds.
000 101 ccc uuu	834 or 836 disk units. Control module self-checking diagnostics are not executed. The initial options display appears instantly.
011 011 uuu uuu	895 disk units.
	where uuu uuu or uuu represents the physical unit number on which the deadstart disk is mounted. ccc represents the physical control module equipment number of the control module connected to the deadstart disk.

When setting the deadstart panel, all numbers are entered in binary form; each switch represents a bit in a 12-bit PP instruction word. For I1n, I2n, I4Cn, and all I4n Class systems, you must set the four leftmost bit positions of each row to 0 (they are not shown in figures 5-16, 5-17, and 5-18).

Refer to Setting Word 13 later in this section for detailed information on word 12 (CYBER 70 and 6000 computer systems) and word 13 parameters.

Coldstart of Tape Controllers for 667 or 669 Tape Units

Coldstart procedures are necessary when subsequent deadstarts are from 667 or 669 magnetic tape units and in cases where controlware for the tape units has not yet been loaded into the controller. Such coldstart procedures contain a special program which reads the tape controller controlware, downloads the controlware onto the controller, then loads the deadstart tape.

Immediately following a successful coldstart, you should reset the deadstart panel/program for a warmstart (except for I1n, I4Cn, and all I4n systems; refer to Setting the Deadstart Panel/Program for a Warmstart earlier in this section). After a coldstart from a card reader, the system loads the deadstart tape automatically. A warmstart, unlike a coldstart, occurs after the controlware has been loaded and is functioning properly.

After initial loading of the controlware, there is no reason to perform a coldstart again (providing the tape subsystem is operating correctly).

Coldstart of 7021/7152 Tape Controllers From a Card Reader

The following steps summarize the procedures necessary to coldstart a 7021 or 7152 tape controller from a card reader. Use this as a checklist during coldstarts. Ensure that the card reader and the tape unit, on which the deadstart tape is to be mounted, are on different channels. The card reader must be on a channel without a PP (for example, channel 12 or 13).

- ___ 1. Ensure that required mass storage devices have packs mounted and/or are available.
- ___ 2. Mount the deadstart tape.
 - ___ a. Ensure that the write-enable ring is not on the reel.
 - ___ b. Mount the tape and ready the unit.
- ___ 3. Set the deadstart program² for a coldstart from a card reader (refer to figure 5-19).
- ___ 4. Set the mode switch to LOAD.³
- ___ 5. Press the DEADSTART button.
- ___ 6. Insert the card deck⁴ in the card reader and activate the card reader as follows:
 - ___ a. Press MOTOR POWER.
 - ___ b. Select AUTO MODE.
 - ___ c. Press RELOAD MEMORY.
 - ___ d. Press READY.
- ___ 7. Continue with the deadstart process by selecting CIP options (refer to the INITIAL OPTIONS display for your model).

Panel/Program Settings for Coldstart of 7021/7152 Tape Controllers From a Card Reader

During coldstarts from a card reader, the deadstart program:

- Identifies the controller and channel number used to access the card reader from which the controlware is to be read.
- Specifies the controller, channel, and unit number of the tape unit on which the deadstart tape is mounted.
- Reads the controlware card deck (this deck loads the tape controller).
- Processes the deadstart tape according to the options specified on the deadstart panel.

2. Refer to Coldstart Procedure Summary for I1n, I4Cn, and All I4n Class Systems earlier in this section.

3. For all systems except I1n, I2n, and all I4n Class systems.

4. For detailed information on the controlware deck, refer to the NOS 2 or NOS/BE Installation Handbook.

By setting the switches/bits shown in the unshaded area of the deadstart panel (see figure 5-19), you identify all devices used in a coldstart. This includes both the channel and controller number associated with the card reader and the channel, controller, and unit number of the tape unit.

	Binary				Octal
1	111	101	cc	ccc	75cc
2	111	111	0cc	ccc	77cc
3	fff	000	000	000	f000
4	000	000	000	000	0000
5	111	111	0cc	ccc	77cc
6	001	100	000	000	1400
7	111	100	0cc	ccc	74cc
10	111	001	0cc	ccc	71cc
11	111	110	110	100	7664
12	000	000	0cc	ccc	00cc [†]
13	rrr	ppp	xxx	xxx	rpxx ^{††}
14	eee	010	11u	uuu	e2uu

[†] Refer to Setting Word 12 later in this section for information on performing deadstart testing for models 835, 845, and 855.
^{††} The instructions for setting the bits represented by these parameters are given under Setting Word 13 later in this section.

Figure 5-19. Coldstart of 7021/7152 Tape Controller From Card Reader

Descriptions of the deadstart panel/program parameters follow.

Parameter	Description
-----------	-------------

cc ccc	Channel number used to access the card reader from which the controlware is to be read.
fff	Controller number to which the card reader is connected.
rrr	Deadstart level.
ppp	Deadstart parameters.
xxx xxx	CMRDECK number (NOS), CMR number (NOS/BE).
eee	Controller number to which the tape unit is connected.
u uuu	Physical unit number of the tape unit on which the deadstart tape is mounted.

The card reader and the tape unit on which the deadstart tape is mounted must be on different channels. Furthermore, the card reader must be on a channel without a PP (for example, channel 12 or 13). Refer to appendix F to determine which channels in your hardware configuration do not have PPs.

The device identification numbers are entered in binary form on the deadstart panel; each switch represents a bit in a 12-bit PP instruction word. For I2n Class system models, set the four leftmost bit positions for each row to 0 (they are not shown in figure 5-19). Refer to Setting Word 13 later in this section for detailed information on word 13 parameters.

If the tape subsystem is functioning properly, there is no need to perform another coldstart after initially loading the controlware. After a successful coldstart, you should immediately reset the deadstart panel for a warmstart.

Coldstart of 7152 Tape Controllers From a Tape Unit

The following steps summarize the procedures necessary to coldstart a 7152 tape controller from a 669 tape unit (coldstart of a 7152 tape controller from a 667 tape unit is not possible). Use these steps as a checklist during coldstarts. Ensure that the 669 tape unit is set to a unit number between 10 and 17 and that the unit resides on a channel without a PP (for example, channel 12 or 13).

- ___ 1. Mount the controlware tape on the tape unit which is to be specified on the deadstart panel.
 - ___ a. Ensure that the write-enable ring is not on the reel.
 - ___ b. Mount the tape and ready the unit.
- ___ 2. Set the deadstart program to perform a coldstart from the tape unit (refer to figure 5-20).
- ___ 3. Set the mode switch to LOAD.⁵
- ___ 4. Press the DEADSTART button. No display should appear on the console, however, unloading of the controlware tape indicates that the controlware was loaded successfully.
- ___ 5. Perform a warmstart to complete the deadstart operation.

Panel Settings for Coldstart of 7152 Tape Controllers From a Tape Unit

During coldstart from a tape unit, the deadstart program:

- Identifies the channel and unit number of the tape unit on which the controlware tape is mounted and to be read.
- Reads the controlware tape and loads the controlware into tape controller.

By setting the switches shown in the unshaded area of the deadstart panel (see figure 5-20), you identify the tape unit and the channel used in a coldstart. The tape unit number must be between 10 and 17, and the unit must be on a channel without a PP (for example, channel 12 or 13). Refer to appendix F to determine which channels in your hardware configuration do not have PPs.

5. For all systems except I1n, I2n, and all I4n Class systems.

The device identification numbers are entered in binary form on the deadstart panel/program; each switch represents a bit in a 12-bit PP instruction word. For I1n, I2n, and all I4n Class systems, set the four leftmost bit positions of each row to 0 (they are not shown in figure 5-20). The remaining panel/program parameters are not used.

Unloading of the controlware tape indicates that the controlware was loaded successfully. At this point, you must immediately reset the deadstart panel/program for a warmstart in order for the system to proceed with loading the system deadstart tape.

	<u>Binary</u>				<u>Octal</u>
1	111	101	1cc	ccc	75cc
2	011	110	001	101	3615
3	001	000	001	100	1014
4	001	111	000	001	1701
5	000	101	111	110	0576
6	111	111	1cc	ccc	77cc
7	000	000	11u	uuu	00uu
10	000	011	000	000	0300

Figure 5-20. Coldstart of 7152 Tape Controller From Tape Unit

Descriptions of the deadstart panel parameters follow.

Parameter	Description
cc ccc	Channel number that accesses the controlware tape equipment.
u uuu	Physical unit number of the tape unit on which the controlware tape is mounted.

Coldstart of Disk Controllers for 844, 885-11/12, or 895 Disk Units

A coldstart is necessary when deadstarting from 844, 885-11/12, or 895 disk units, if the controlware is not yet loaded into the controller. The coldstart procedure contains a special program which reads the disk controller controlware, loads the controlware onto the controller, and then loads the deadstart file.

The following procedures for coldstarting a 7054/7154/7152/7155/7165 disk controller from a card reader will load all disk controllers. After a coldstart from a card reader, the system loads the deadstart tape automatically (use a warmstart for subsequent deadstarts only).

If the MSL is available at your site, procedures outlined later in this section (Coldstart of a 7152/7155/7165 Disk Controller From a Disk Unit) may be used to load the 7152, 7155, and 7165 disk controllers.

After any successful coldstart, you should immediately reset the deadstart program for a warmstart (refer to Setting the Deadstart Panel for a Warmstart, earlier in this section). After the controlware is loaded and functioning properly, there is no reason to perform a coldstart again (if the disk subsystem is operating correctly).

Coldstart of 7054/7154/7152/7155/7165 Disk Controllers From a Card Reader

The following steps summarize the procedures necessary to coldstart a disk controller from a card reader. Use this as a checklist during coldstarts. Ensure that the card reader and the disk unit on which the deadstart device is mounted are on different channels. The card reader must be on a channel without a PP (for example, 12 or 13).

- ___ 1. Ensure that all required mass storage devices have packs mounted and available.
- ___ 2. Mount the deadstart disk unit (if using an 844 disk unit).
- ___ 3. Set the deadstart program⁶ to perform a coldstart from a card reader using 844 or 885-11/12 disk units (refer to figure 5-21).
- ___ 4. Set the mode switch to LOAD.⁷
- ___ 5. Press the DEADSTART button.
- ___ 6. Insert card deck⁸ in card reader and activate card reader as follows:
 - ___ a. Press MOTOR POWER.
 - ___ b. Select AUTO MODE.
 - ___ c. Press RELOAD MEMORY.
 - ___ d. Press READY.
- ___ 7. Continue with the deadstart process by selecting CIP options (refer to the INITIAL OPTIONS display for your model of computer system).

6. Refer to Coldstart Procedure Summary for I1n, I4Cn, and All I4n Class Systems earlier in this section.

7. For all systems except I1n, I2n, and all I4n Class systems.

8. For detailed information on the controlware deck, refer to the NOS 2 or NOS/BE Installation Handbook.

Panel Settings for the Coldstart of 7054/7154/7152/7155/7165 Disk Controllers From a Card Reader

During a coldstart from a card reader, the deadstart program:

- Identifies the controller and channel number from which the card reader is accessed (from which the controlware is to be read).
- Specifies the controller, channel, and unit number of the drive on which the deadstart disk is mounted.
- Reads the controlware card deck (this deck loads the disk controller).
- Processes the deadstart tape according to the options specified on the deadstart panel.

By setting the switches shown in the unshaded area of the deadstart panel (see figure 5-21), you identify all the devices necessary for a coldstart. This includes the controller and channel numbers associated with the card reader and the channel, controller, and disk unit numbers associated with the disk unit.

The card reader and disk drive, on which the deadstart disk is mounted, must be on different channels, while the card reader also must be on a channel without a PP (for example, channel 12 or 13). Refer to appendix F to determine which channels in your hardware configuration do not have PPs.

	Binary				Octal
1	111	101	1cc	ccc	75cc
2	111	111	0cc	ccc	77cc
3	fff	000	000	000	f000
4	000	000	000	000	0000
5	111	111	0cc	ccc	77cc
6	001	100	000	000	1400
7	111	100	0cc	ccc	74cc
10	111	001	0cc	ccc	71cc
11	111	110	110	100	7664
12	000	000	0cc	ccc	00cc [†]
13	rrr	ppp	xxx	xxx	rpxx ^{††}
14	eee	011	uuu	uuu	e3uu

[†] Refer to Setting Word 12 later in this section for information on performing deadstart testing for I2n Class Systems.
^{††} The instructions for setting the bits represented by these parameters are given under Setting Word 13 later in this section.

Figure 5-21. Coldstart of Disk Controller From Card Reader

Descriptions of deadstart panel parameters follow.

Parameter	Description
cc ccc	Channel number used to access the card reader (from which the controlware is to be read).
fff	Controller number to which the card reader is connected (4, 5, 6, or 7).
rrr	Deadstart level.
ppp	Deadstart parameters.
xxx xxx	CMRDECK number (NOS), CMR number (NOS/BE).
eee	Controller number to which the disk unit is connected.
uuu uuu	Physical unit number of the drive on which the deadstart disk is mounted.

NOTE

When deadstarting from a 7054 or 7154 disk controller, incorrect panel settings, such as channel or unit numbers, can hang the controller. To free the controller, correct the panel settings and master clear the controller by pressing, in sequence, the STOP, MASTER CLEAR, and GO buttons. These buttons are located inside the controller chassis.

The device identification numbers are entered in binary form on the deadstart panel; each switch represents a bit in a 12-bit PP instruction word. For models 835 through 860, set the four leftmost bit positions of each row to 0 (they are not shown in figure 5-21).

Refer to Setting Word 13 later in this section for detailed information on word 13 parameters.

If the disk subsystem is functioning properly, there is no need to perform another coldstart after initial loading of the controlware, and it is advised that you immediately reset the deadstart panel for a warmstart.

Coldstart of 7152/7155/7165 Disk Controllers From a Disk Unit

If controlware is already loaded onto a disk unit,⁹ use this procedure to perform a deadstart. The following steps summarize the procedures necessary to perform coldstarts from a disk unit. Use this as a checklist during coldstart.

- ___ 1. Ensure that all required mass storage devices have packs mounted and/or are available.
- ___ 2. Mount the deadstart disk unit (if using an 844 disk unit).
- ___ 3. Set the deadstart program¹⁰ for a coldstart from a disk unit (figure 5-22). Set the mode switch to LOAD.¹¹
- ___ 4. Press the DEADSTART button. The INITIAL OPTIONS display appears.
- ___ 5. Continue with the deadstart process by selecting CIP options (refer to the INITIAL OPTIONS display for your model of computer system).

Panel Settings for Coldstart of 7152/7155/7165 Disk Controllers From a Disk Unit

During coldstart from a disk unit, the deadstart program:

- Identifies the controller and channel number used to access the disk unit (from which the controlware is to be read).
- Specifies the controller, channel, and unit number of the drive on which the deadstart disk is mounted.
- Reads the controlware (this controlware loads the disk controller).
- Processes the deadstart file according to the options specified on the deadstart panel.

By setting the switches shown in the unshaded area of the deadstart panel (see figures 5-22 through 5-24 for appropriate configurations), you identify all devices used during a coldstart. This includes the channel number and controller associated with the disk unit and the channel, controller, and unit number of the drive.

The disk unit must be on a channel with no PP (for example, channel 12 or 13). Refer to appendix F to determine which channels in your hardware configuration do not have PPs.

The device identification numbers are entered in binary form on the deadstart panel; each switch represents a bit in a 12-bit PP instruction word. For models I2n Class systems, set the four leftmost bit positions of each row to 0 (they are not shown in figures 5-22, 5-23, and 5-24).

9. For more information on loading controlware to the disk, contact a CE.

10. For I1n, I4Cn, and all I4n Class systems refer to Coldstart Procedure Summary for I1n, I4Cn, and All I4n Class Systems, earlier in this section.

11. For all systems except I1n, I2n, and all I4n 990 Class systems.

Refer to Setting Word 13 later in this section for detailed information on word 13 parameters.

If the disk subsystem is functioning properly, there is no need to perform another coldstart after an initial loading of the controlware, and you should immediately reset the deadstart panel for a warmstart.

	<u>Binary</u>				<u>Octal</u>
1	000	000	000	000	0000
2	111	101	1cc	ccc	75cc
3	111	111	0cc	ccc	77cc
4	eee	001	vvv	vvv	e1vv
5	111	111	0cc	ccc	77cc
6	eee	011	uuu	uuu	e3uu
7	111	100	0cc	ccc	74cc
10	111	001	0cc	ccc	71cc
11	111	011	000	001	7301
12	000	000	000	000	0000
13	rrr	ppp	xxx	xxx	rpxx [†]
14	000	000	000	000	0000

[†]The instructions for setting the bits represented by these parameters are given under Setting Word 13 later in this section.

Figure 5-22. Coldstart of 7152/7155/7165 Disk Controller From Disk Unit (CYBER 70/6000 Systems)

Descriptions of the deadstart panel parameters follow:

Parameter	Description
cc ccc	Channel number used to access the deadstart disk equipment.
eee	Controller number to which the disk unit is connected.
vvv vvv	Physical unit number of the disk drive from which the coldstart operation is to be completed.
uuu uuu	Physical unit number of the disk drive from which the warmstart operation is to be completed.
rrr	Deadstart level.
ppp	Deadstart parameters.
xxx xxx	CMRDECK number (NOS), CMR number (NOS/BE).

	<u>Binary</u>				<u>Octal</u>
1	000	000	000	000	0000
2	000	000	000	000	0000
3	000	000	000	000	0000
4	111	101	1cc	ccc	75cc
5	111	111	0cc	ccc	77cc
6 [†]	000	001	uuu	uuu	01uu
7	111	100	0cc	ccc	74cc
10	111	001	0cc	ccc	71cc
11	111	011	000	001	7301
12	000	000	000	000	0000
13	rrr	ppp	xxx	xxx	rpxx
14	000	000	000	000	0000
15	000	000	000	000	0000
16	000	000	000	000	0000
17	000	000	000	000	0000
20	000	000	000	000	0000

†For 7165 controllers/895 diskdrives, set word 6 as follows:

6		000	001	sss	ddd		01sd
---	--	-----	-----	-----	-----	--	------

where sss = storage director number
ddd = disk drive number

Figure 5-23. Coldstart of 7152/7155/7165 Disk Controller From Disk Unit, With No PP on Disk Channel (I1n, I2n, and All I4n Class Systems)

<u>Parameter</u>	<u>Description</u>
cc cc	Channel number used to access the deadstart disk equipment.
uuu uuu	Physical unit number of the disk drive from which the warmstart operation is to be completed.
rrr	Deadstart level.
ppp	Deadstart parameters.
xxx xxx	CMRDECK number (NOS), CMR number (NOS/BE).

	Binary				Octal
1	001	100	000	010	1402
2	111	011	0cc	ccc	73cc
3	000	000	001	111	0017
4	111	101	1cc	ccc	75cc
5	111	111	0cc	ccc	77cc
6 [†]	000	001	uuu	uuu	01uu
7	111	100	0cc	ccc	74cc
10	111	001	0cc	ccc	71cc
11	111	011	000	001	7301
12	000	000	000	000	0000
13	rrr	ppp	xxx	xxx	rpxx
14	000	000	000	000	0000
15	000	000	000	000	0000
16	000	000	000	000	0000
17	000	000	000	000	0000
20	111	001	001	010	7112

†For 7165 controllers/895 diskdrives, set word 6 as follows:

6		000	001	sss	ddd		01sd
---	--	-----	-----	-----	-----	--	------

where sss = storage director number
ddd = disk drive number

Figure 5-24. Coldstart of 7152/7155/7165 Disk Controller From Disk Unit, With a PP on Disk Channel (I1n, I2n, and All I4n Class Systems)

Descriptions of the deadstart panel parameters follow.

Parameter Description

cc ccc	Channel number used to access the deadstart disk equipment.
uuu uuu	Physical unit number of the disk drive from which the warmstart operation is to be completed.
rrr	Deadstart level.
ppp	Deadstart parameters.
xxx xxx	CMRDECK number (NOS), CMR number (NOS/BE).

NOTE

Figures 5-23 and 5-24 show deadstart panel settings for the system deadstart with a disk controller deadstart. These two programs would initially load the controlware, and then load CTI. However, if you desire to load only the controlware (that is coldstart the disk subsystem), change word 12 of the program to 0300.

Coldstart/Warmstart of 834/836 Disk Subsystems From Disk

Use the following procedure to coldstart and warmstart an 834 or 836 disk subsystem. The coldstart will load the controlware, which has already been installed onto the disk, into the disk adapter and control module. Once the disk has been coldstarted, the warmstart occurs automatically.

Complete one of the following steps to bring up the DEADSTART OPTIONS display or the CONSOLE MAIN MENU display.

- ___ 1. If a CC545 display is the primary console:
 - ___ a. Press the DEADSTART button on the console to bring up the MAINTENANCE OPTIONS display.
- ___ 2. If a CC634B display terminal is the primary operator console:
 - ___ a. Press the RESET button to reinitialize the console.
 - ___ b. Hold down the CTRL key while pressing the G key.
 - ___ c. When the message *OPERATOR ACCESS ENABLED* appears on the screen, hold down the CTRL key while pressing the R key.
- ___ 3. If a CC598B is the primary console and if the console is already initialized, but the CONSOLE MAIN MENU is not currently being displayed:
 - ___ a. Simultaneously press the Ctrl and F2 keys. The CONSOLE MAIN MENU will appear.
- ___ 4. If a CC598B is the primary console and if the console is not initialized:
 - ___ a. Simultaneously press the Ctrl, Alt, and Del keys. The CDC logo will appear. Approximately ten seconds thereafter, the CONSOLE MAIN MENU will appear.

After bringing up either the DEADSTART OPTIONS display or the CONSOLE MAIN MENU display, proceed with the following steps.

- ___ 1. If you are deadstarting from a CC598B on a single IOU system, or from a CC545 or CC634B perform one of the following steps.

If the program selected is the desired coldstart/warmstart program:

 - ___ a. Enter an M to bring up the MAINTENANCE OPTIONS¹² display.
 - ___ b. Skip to step 6.

If the program selected is not the desired coldstart/warmstart program:

 - ___ a. Enter an M to bring up the MAINTENANCE OPTIONS^{xx} display shown the upper display of figure 5-12.
 - ___ b. Skip to step 3.

12. The MAINTENANCE OPTIONS IOU0 display will appear on a CC598B console.

- ___ 2. If you are deadstarting from a CC598B on a dual IOU system, perform one of the following steps.
If the program selected is not the desired coldstart/warmstart program:
 - ___ a. Go to step 3.If the program selected is the desired coldstart/warmstart program:
 - ___ a. Enter M to bring up the MAINTENANCE OPTIONS menu (figure 5-4).
 - ___ b. Select 0 to bring up the MAINTENANCE OPTIONS - IOU0 display (figure 5-5).
- ___ 3. If the coldstart/warmstart program is already stored in microprocessor random access memory (RAM):
 - ___ a. Retrieve the coldstart program by entering GP n and then press the carriage return key, where n (0 through 3 octal) is the RAM program number.
 - ___ b. Skip steps 4, 5 and 6.
- ___ 4. Enter the coldstart/warmstart program (refer to figure 5-23 earlier in this section) using the console keyboard.
- ___ 5. Enter SP n if you want to store your program in RAM for future use, where n (0 through 3 octal) is the RAM program number.
- ___ 6. Coldstart the disk controller by entering either S or L, then press the carriage return key. The INITIAL OPTIONS display appears.

Deadstart Program for Coldstart/Warmstart of 834/836 Disk Controllers From a Disk Unit

Use the program shown in figure 5-25 or 5-26 when coldstarting and warmstarting an 834 or 836 disk controller on an IIn Class system.

	<u>Binary</u>				<u>Octal</u>
1	000	000	000	000	0000
2	000	000	000	000	0000
3	000	000	000	000	0000
4	111	101	1cc	ccc	75cc
5	111	111	0cc	ccc	77cc
6	000	001	uuu	ddd	01ud
7	111	100	0cc	ccc	74cc
10	111	001	0cc	ccc	71cc
11	111	011	000	001	7301
12	000	mmm	001	000	0m10
13	rrr	ppp	xxx	xxx	rpxx
14	000	000	000	000	0000
15	000	000	000	000	0000
16	000	000	000	000	0000
17	000	000	000	000	0000
20	000	000	000	000	0000

Figure 5-25. Coldstart/Warmstart of 834/836 Disks From a Disk Unit, With No PP on Disk Channel

	<u>Binary</u>				<u>Octal</u>
1	001	100	000	010	1402
2	111	011	0cc	ccc	73cc
3	000	000	001	111	0017
4	111	101	1cc	ccc	75cc
5	111	111	0cc	ccc	77cc
6	000	001	uuu	ddd	01ud
7	111	100	0cc	ccc	74cc
10	111	001	0cc	ccc	71cc
11	111	011	000	001	7301
12	000	mmm	001	000	0m10
13	rrr	ppp	xxx	xxx	rpxx
14	000	000	000	000	0000
15	000	000	000	000	0000
16	000	000	000	000	0000
17	000	000	000	000	0000
20	111	001	001	010	7112

Figure 5-26. Coldstart/Warmstart of 834/836 Disks From a Disk Unit, With PP on Disk Channel

NOTE

Figures 5-25 and 5-26 show deadstart panel settings for the system deadstart with a disk controller deadstart. These two programs would initially load the controlware, and then load CTI. However, if you desire to load only the controlware (that is coldstart the disk subsystem), change word 12 of the program to 0300.

Descriptions of the deadstart panel parameters follow.

Parameter	Description
cc ccc	Channel number used to access the disk subsystem.
uuu	Control module number (0 through 7).
ddd	Disk unit number (0 through 3).
mmm	Defines memory as follows:
	1 = 1 Mbyte 4 = 8 Mbytes
	2 = 2 Mbytes 5 = 16 Mbytes
	3 = 4 Mbytes 6 = 32 Mbytes
rpxx	The instructions for setting the bits represented by these parameters are given under Setting Word 13 later in this section.

Coldstart/Install of 834/836/844/885/895 Disk Subsystem Microcode From a CIP Tape

A special utility provides the capability of loading disk subsystem microcode into the 834 or 836 disk adapter and control module memory (coldstart) and also provides the capability of installing microcode onto the specified disk drives (refer to Loading and Installing Disk Subsystem Microcode From CIP Tape in section 6). After microcode has been installed onto the disk, the Coldstart/Warmstart of 834/836 Disk Subsystems From Disk procedure described previously can be used. This utility will also install controlware onto 7155¹³ and 7165¹⁴ disk controllers as well.

Coldstart of 639 Tape Units From Tape

Use the following procedure to coldstart a 639 intelligent small tape unit (ISMT) on I1n and I4n Class systems. This procedure is to be used when mainframe power has been turned off and the subsequent deadstart is to be performed from a tape unit. The coldstart procedures outlined here will load the peripheral microcode (controlware) from the CIP tape into the tape unit adapter. Once the tape unit has been coldstarted, the warmstart procedure, described previously, should be followed.

- ___ 1. Apply power to the system and 639 tape unit.
- ___ 2. Mount the CIP tape on the tape unit.
- ___ 3. Ensure that the tape unit is placed on line.
- ___ 4. If the system console is a CC634B display terminal, press the RESET button to reinitialize the system console. If the CC634B console has never been initialized, complete the steps given in appendix H to initialize the console.
- ___ 5. Complete one of the following steps to bring up the DEADSTART OPTIONS display or the CONSOLE MAIN MENU display.
 - If a CC545 display is the primary console:
 - ___ a. Press the DEADSTART button. The DEADSTART OPTIONS display appears.
 - If a CC634B display terminal is the primary operator console:
 - ___ a. Press the RESET button to reinitialize the console.
 - ___ b. Hold down the CTRL key while pressing the G key.
 - ___ c. When the message *OPERATOR ACCESS ENABLED* appears on the screen, hold down the CTRL key while pressing the R key. The DEADSTART OPTIONS display appears.
 - If a CC598B is the primary console and if the console is already initialized, but the CONSOLE MAIN MENU is not currently being displayed:
 - ___ a. Simultaneously press the Ctrl and F2 keys. The CONSOLE MAIN MENU will appear.

13. For 844 or 885 disk units.

14. For 895 disk units.

If a CC598B is the primary console and if the console is not initialized:

- ___ a. Simultaneously press the Ctrl, Alt, and Del keys. The CDC logo will appear. Approximately ten seconds thereafter, the CONSOLE MAIN MENU will appear.
- ___ 6. Complete one of the following two steps to bring up a maintenance options display.
- ___ a. If your system console is not a CC598B, enter M to bring up the MAINTENANCE OPTIONS display shown in figure 5-12.
 - ___ b. If your system console is a CC598B and if you have a dual IOU system, enter M to bring up the MAINTENANCE OPTIONS menu shown in figure 5-4 and then enter 0 to bring up the MAINTENANCE OPTIONS - IOU0 display shown in figure 5-5.
 - ___ c. If your system console is a CC598B and if you have a single IOU system, enter M to bring up the MAINTENANCE OPTIONS - IOU0 display shown in figure 5-5.
- ___ 7. If the coldstart program is already stored in microprocessor RAM:
- ___ a. Retrieve the coldstart program by entering GP n and pressing the carriage return key, where n (0 through 2 octal) is the RAM program number.
 - ___ b. Skip steps 8 and 9.
- ___ 8. Enter the coldstart program (shown in figure 5-27 or figure 5-28), using the console keyboard.
- Program entry is accomplished by entering xx yyyyyy and then pressing the carriage return key. In this format, xx (1 through 20 octal) is the location, and yyyyyy (octal) is the instruction. The first two digits of the instruction should be zeros; however, leading zeros, both in the location and in the instruction, do not have to be entered. If you want the system to add an increment to the location automatically, enter xx+yyyyyy. When the automatic increment is in effect, the system displays the next location (after accepting the previous entry). Since locations are automatically incremented, you need enter only the instruction. To terminate the automatic increment, press the erase key after the location appears.
- ___ 9. Enter SP n if you want to store your program in RAM for future use, where n (0 through 3 octal) is the RAM program number.
- ___ 10. Initialize as follows when using a CC634B console:
- ___ a. Enter S to coldstart the tape unit. Upon receipt of the 60u function, the tape unit adapter:
 - 1) Executes internal diagnostics.
 - 2) Connects to the 639 ISMT.
 - 3) Rewinds the tape unit.
 - 4) Reads the 639 microcode record from tape.

- 5) Verifies the microcode ID and revision level.
- 6) Performs a checksum of the microcode.
- 7) Executes the microcode diagnostics.
- 8) Rewinds the tape (if all of the preceding items execute properly).
You will see the message SYSTEM INITIALIZATION IN PROGRESS.

___ 11. Initialize as follows when using a CC545 console:

- ___ a. Enter S to coldstart the tape unit. Upon receipt of the 60u function, the tape unit adapter:
 - 1) Executes internal diagnostics.
 - 2) Connects to the 639 ISMT.
 - 3) Rewinds the tape unit.
 - 4) Reads the 639 microcode record from tape.
 - 5) Verifies the microcode ID and revision level.
 - 6) Performs a checksum of the microcode.
 - 7) Executes the microcode diagnostics.
 - 8) Rewinds the tape (if all of the preceding items execute properly).
You will see the message SYSTEM INITIALIZATION IN PROGRESS.

To verify proper loading of the microcode or to identify the cause of a bad load, complete the following steps.

- ___ 1. Wait for tape motion to stop or wait about 10 seconds if the tape did not move and then perform the following steps to bring up the DEADSTART OPTIONS display or the CONSOLE MAIN MENU display.
If using a CC545 console:
 - ___ a. Press the DEADSTART button on the console. The DEADSTART OPTIONS shown in figure 5-12 will appear.
 If using a CC634B console:
 - ___ a. Hold down the CTRL key while pressing the G key.
 - ___ b. When the message *OPERATOR ACCESS ENABLED* appears on the screen, hold down the CTRL key while pressing the R key. The DEADSTART OPTIONS shown in figure 5-1 will appear.
 If a CC598B is the primary console and if the console is already initialized, but the CONSOLE MAIN MENU is not currently being displayed:
 - ___ a. Simultaneously press the Ctrl and F2 keys. The CONSOLE MAIN MENU will appear.

If a CC598B is the primary console and if the console is not initialized:

- ___ a. Simultaneously press the Ctrl, Alt, and Del keys. The CDC logo will appear. Approximately ten seconds thereafter, the CONSOLE MAIN MENU will appear.
- ___ 2. Complete one of the following two steps to bring up a maintenance options display.
 - ___ a. If your system console is not a CC598B, enter M to bring up the MAINTENANCE OPTIONS shown in figure 5-12.
 - ___ b. If your system console is a CC598B and if you have a dual IOU system, enter M to bring up the MAINTENANCE OPTIONS menu shown in figure 5-4 and then enter 0 to bring up the MAINTENANCE OPTIONS - IOU0 display shown in figure 5-5.
 - ___ c. If your system console is a CC598B and if you have a single IOU system, enter M to bring up the MAINTENANCE OPTIONS - IOU0 display shown in figure 5-5.
- ___ 3. Enter PR and press the return key to bring up the PP REGISTER display.
- ___ 4. Examine the PP 00 line of the display. If P equals 0016, enter PM and then press the carriage return key to bring up the PP MEMORY display. If location 0030 equals 1000, the microcode is loaded and initialized correctly and subsequently, the tape unit is ready to use.

NOTE

This display shows the contents of PP registers for barrel 0. Press + to display PP registers for barrel 1 if you have reconfigured PPs using the RB command.

- ___ 5. If P does not equal 0016 on the PP REGISTER display, or location 0030 does not equal 1000 on the PP MEMORY display, an error has occurred. Recheck the entries in the deadstart program and the status of the hardware to ensure that you did not make an error when following the procedure. Retry the procedure, and if you are still unsuccessful, contact a CE for assistance.

Deadstart Program for Coldstart of 639 Tape Unit Controllers or 7155/7165 Disk Controllers from Tape

Use one of the programs shown in figures 5-27 or 5-28 when coldstarting a 639 tape unit controller on any I4n Class computer system.

*C830
ch 6*

	<u>Binary</u>				<u>Octal</u>
1	001	100	000	010	1402
2	111	011	0cc	ccc	73cc
3	000	000	001	111	0017
4	111	101	1cc	ccc	75cc
5	111	111	0cc	ccc	77cc
6	000	110	000	uuu	060u
7	001	101	000	000	1500
10	011	100	011	000	3430
11	111	111	0cc	ccc	77cc
12	000	000	001	010	0012
13	111	100	0cc	ccc	74cc
14	111	001	0cc	ccc	71cc
15	000	000	011	000	0030
16	000	011	000	000	0300
17	000	000	000	000	0000
20	111	011	001	010	7112

Notation	Description
cc ccc	Channel number used to access tape unit.
uuu	Tape unit number (0 through 3).

Figure 5-27. Coldstart of 639 Tape Units From Tape on a Channel With a PP

	Binary				Octal
1	000	000	000	000	0000
2	000	000	000	000	0000
3	000	000	000	000	0000
4	111	101	1cc	ccc	75cc
5	111	111	0cc	ccc	77cc
6	000	110	000	uuu	060u
7	001	101	000	000	1500
10	011	100	011	000	3430
11	111	111	0cc	ccc	77cc
12	000	000	001	010	0012
13	111	100	0cc	ccc	74cc
14	111	001	0cc	ccc	71cc
15	000	000	011	000	0030
16	000	011	000	000	0300
17	000	000	000	000	0000
20	111	011	001	010	0000

Notation	Description
cc ccc	Channel number used to access tape unit.
uuu	Tape unit number (0 through 3).

Figure 5-28. Coldstart of 639 Tape Units From Tape on a Channel With No PP

Coldstart of 698 Tape Units From Tape, I1n and I4n Class Systems

A coldstart loads peripheral microcode (controlware) from the CIP tape into the CYBER Channel Coupler (CCC). Once the tape unit has been coldstarted, the warmstart procedure, described previously, should be followed. Use the following procedure to coldstart a 698 CYBER Magnetic Tape Unit (CMTS) on a model I1n and on all I4n Class Systems. This procedure is to be used when mainframe power has been turned off and the subsequent deadstart is to be performed from a tape unit.

- ___ 1. Apply power to the system and to the 698 tape unit.
- ___ 2. Mount the CIP tape on the tape unit.
- ___ 3. Ensure that the tape unit is placed on line.
- ___ 4. If the system console is a CC634B display terminal, press the RESET button to reinitialize the system console. If the CC634B console has never been initialized, complete the steps given in appendix H to initialize the console.
- ___ 5. Complete one of the following steps to bring up the DEADSTART OPTIONS display or the CONSOLE MAIN MENU display.
 - If a CC545 display is the primary console:
 - ___ a. Press the DEADSTART button. The DEADSTART OPTIONS display appears.
 - If a CC634B display terminal is the primary operator console:
 - ___ a. Press the RESET button to reinitialize the console.
 - ___ b. Hold down the CTRL key while pressing the G key.
 - ___ c. When the message *OPERATOR ACCESS ENABLED* appears on the screen, hold down the CTRL key while pressing the R key. The DEADSTART OPTIONS display appears.
 - If a CC598B is the primary console and if the console is already initialized, but the CONSOLE MAIN MENU is not currently being displayed:
 - ___ a. Simultaneously press the Ctrl and F2 keys. The CONSOLE MAIN MENU will appear.
 - If a CC598B is the primary console and if the console is not initialized:
 - ___ a. Simultaneously press the Ctrl, Alt, and Del keys. The CDC logo will appear. Approximately ten seconds thereafter, the CONSOLE MAIN MENU will appear.
- ___ 6. Complete one of the following two steps to bring up a maintenance options display.
 - ___ a. If your system console is not a CC598B, enter M to bring up the MAINTENANCE OPTIONS shown in figure 5-12.
 - ___ b. If your system console is a CC598B and if you have a dual IOU system, enter M to bring up the MAINTENANCE OPTIONS menu shown in figure 5-4 and then enter 0 to bring up the MAINTENANCE OPTIONS - IOU0 display shown on the bottom of figure 5-5.

- ___ c. If your system console is a CC598B and if you have a single IOU system, enter M to bring up the MAINTENANCE OPTIONS - IOU0 display shown in figure 5-5.
- ___ 7. If the coldstart program is already stored in microprocessor RAM:
 - ___ a. Retrieve the coldstart program by entering GP n and then press the carriage return key. The n in this entry (0 through 2 octal) is the RAM program number.
 - ___ b. Skip steps 8 and 9.
 - ___ 8. Enter the coldstart program shown in figure 5-29 or figure 5-30 using the console keyboard.
 Program entry is accomplished by entering xx yyyyyy and then pressing the carriage return key. In this format, xx (1 through 20 octal) is the location and yyyyyy (octal) is the instruction. The first two digits of the instruction should be zeros; however, leading zeros, both in the location and in the instruction, do not have to be entered. If you want the system to add an increment to the location automatically, enter xx+yyyyyy. When the automatic increment is in effect, the system displays the next location after accepting the previous entry. Since locations are automatically incremented, you need enter only the instruction. To terminate the automatic increment, press the erase key after the location appears.
 - ___ 9. Enter SP n if you want to store your program in RAM for future use, where n (0 through 2 octal) is the RAM program number.
 - ___ 10. Coldstart as follows when using a CC634B console:
 - ___ a. Hold down the CTRL key while pressing the G key.
 - ___ b. Hold down the CTRL key while pressing the R key.
 - ___ c. Enter S to coldstart the tape unit; you will see the message SYSTEM INITIALIZATION IN PROGRESS.
 - ___ 11. Coldstart as follows if using a CC545 console:
 - ___ a. Press the DEADSTART button on the console.
 - ___ b. Enter S to coldstart the tape unit; you will see the message SYSTEM INITIALIZATION IN PROGRESS.
 - ___ 12. Coldstart as follows when using a CC598B as the primary console and if the console is already initialized, but the CONSOLE MAIN MENU is not currently being displayed:
 - ___ a. Simultaneously press the Ctrl and F2 keys. The CONSOLE MAIN MENU will appear.
 - ___ b. Enter S to coldstart the tape unit; you will see the message SYSTEM INITIALIZATION IN PROGRESS.

- ___ 13. Coldstart as follows when using a CC598B as the primary console and if the console is not initialized:
- ___ a. Simultaneously press the Ctrl, Alt, and Del keys. The CDC logo will appear. Approximately ten seconds thereafter, the CONSOLE MAIN MENU will appear.
 - ___ b. Enter S to coldstart the tape unit; you will see the message SYSTEM INITIALIZATION IN PROGRESS.

NOTE

If the tape does not move or if it fails to rewind after moving forward, refer to the 698 CYBER Magnetic Tape Subsystem (CMTS) users Guide, publication number 60000009, section 5, Troubleshooting.

Deadstart Program for Coldstart of 698-xx Tape Unit From Tape (I1n, I4n Class Systems)/Deadstart Program for Coldstart of 698-xx Tape Unit From CIP Device (I4Cn Class Systems)

Use one of the programs shown in figures 5-29 and 5-30 when coldstarting a 698-xx tape unit.

	Binary				Octal
1	001	100	000	010	1402
2	111	011	0cc	ccc	73cc
3	000	000	001	111	0017
4	111	101	1cc	ccc	75cc
5	111	111	0cc	ccc	77cc
6	000	110	000	uuu	060u
7	00	011	000	000	0300
10	000	000	000	000	0000
11	000	000	000	000	0000
12	000	000	000	000	0000
13	000	000	000	000	0000
14	000	000	000	000	0000
15	000	000	000	000	0000
16	000	000	000	000	0000
17	000	000	000	000	0000
20	111	001	001	010	7112

Notation	Description
cc ccc	Channel number used to access tape unit.
uuu	Tape unit number (0 through 3).

Figure 5-29. Coldstart of 698 Tape Units From Tape (I1n, I4n Class Systems) on a Channel With a PP/Coldstart of 698 Tape Units From CIP Device (I4Cn Class Systems) on a Channel With a PP

	<u>Binary</u>				<u>Octal</u>
1	000	000	000	000	0000
2	000	000	000	000	0000
3	000	000	000	000	0000
4	111	101	cc	ccc	75cc
5	111	111	0cc	ccc	77cc
6	000	110	000	uuu	060u
7	00	011	000	000	0300
10	000	000	000	000	0000
11	000	000	000	000	0000
12	000	000	000	000	0000
13	000	000	000	000	0000
14	000	000	000	000	0000
15	000	000	000	000	0000
16	000	000	000	000	0000
17	000	000	000	000	0000
20	000	000	000	000	0000

Notation	Description
cc ccc	Channel number used to access tape unit.
uuu	Tape unit number (0 through 3).

Figure 5-30. Coldstart of 698 Tape Units From Tape (I1n, I4n Class Systems) on a Channel Without a PP/Coldstart of 698 Tape Units From CIP Device (I4Cn Class Systems) on a Channel Without a PP

Coldstart of 698 Tape Units From CIP Device, I4Cn Class Systems

A coldstart loads peripheral microcode (controlware) from the CIP device into the CYBER Channel Coupler (CCC). Use the following procedure to coldstart a 698 CYBER Magnetic Tape Unit (CMTS) on a model I4Cn Class System. This procedure is to be used after a 698 tape unit is powered up.

- ___ 1. Perform one of the following steps on the CC598A system console:

If the CC598A is already initialized, but the CONSOLE MAIN MENU is not currently being displayed:

 - ___ a. Simultaneously press the Ctrl and F2 keys. The CONSOLE MAIN MENU will appear.

If the CC598A is not initialized:

 - ___ a. Simultaneously press the Ctrl, Alt, and Del keys. The CDC logo will appear. Approximately ten seconds thereafter, the CONSOLE MAIN MENU will appear.
- ___ 2. Ensure that CIP has been installed onto the CIP device (refer to CIP Installation, I4Cn Class Systems earlier in this manual).
- ___ 3. Enter M to bring up the MAINTENANCE OPTIONS menu. If you have a single IOU system, the MAINTENANCE OPTIONS menu shown in figure 5-8 will appear. If you have a dual IOU system, the MAINTENANCE OPTIONS menu shown in figure 5-9 will appear.
- ___ 4. Enter 0 to bring up the MAINTENANCE OPTIONS - IOU0 menu (figure 5-10).
- ___ 5. If the coldstart program is already stored in microprocessor RAM:
 - ___ a. Retrieve the coldstart program by entering GP n and then press the carriage return key. The n in this entry (0 through 2 octal) is the RAM program number.
 - ___ b. Skip steps 7 and 8.
- ___ 6. Enter the coldstart program shown in figure 5-29 or figure 5-30 using the console keyboard.

Program entry is accomplished by entering xx yyyyyy and then pressing the carriage return key. In this format, xx (1 through 20 octal) is the location and yyyyyy (octal) is the instruction. The first two digits of the instruction should be zeros; however, leading zeros, both in the location and in the instruction, do not have to be entered. If you want the system to add an increment to the location automatically, enter xx+yyyyyy. When the automatic increment is in effect, the system displays the next location after accepting the previous entry. Since locations are automatically incremented, you need enter only the instruction. To terminate the automatic increment, press the erase key after the location appears.
- ___ 7. Enter SP n if you want to store your program in RAM for future use, where n (0 through 2 octal) is the RAM program number.

Setting Word 12

The a field in word 12 of the deadstart program allows you to enter the model type that HIVS/MSL 15X uses to select extended deadstart testing on I1n, I2n, I4Cn, and all on I4n Class systems (except 865 and 875). A third field, f, determines whether or not the alternate PP is initialized when maintenance (M) is selected.

The switches that represent these fields are shown in figure 5-31. The switches are set on the deadstart panel for I2n Class systems, or they may be entered as octal values through the I1n, I2n, I4Cn, and all I4n Class systems console.

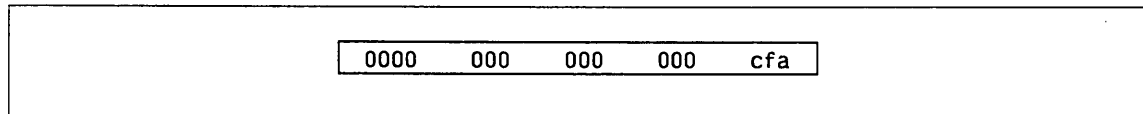

Figure 5-31. Setting Word 12 Switches

Setting	Description
c	If this field is set, word 12 specifies that the deadstart displays will appear on a CC634B console if the console is connected to port 0 of an I2n class system. A deadstart is initiated by pressing the DEADSTART button on a CC634B or CC545 console, or by pressing the DEADSTART button or switch on the deadstart panel. If the c field of word 12 is clear, the deadstart must be initiated either at the CC545 console or at the deadstart panel. After initiating this procedure, displays will appear on the CC545 console.
f	No longer applicable.
a	Specifies the EXTENDED DEADSTART SEQUENCE option. If you set this bit and set the LONG/SHORT DEADSTART SEQUENCE switch on the deadstart panel to the up (long) position, (or enter L after entering or retrieving the warmstart program for an I1n, I4Cn, and I4n 990 Class system), the system loads and executes the extended deadstart sequence (EDS). If you do not set this bit or if you set the LONG/SHORT DEADSTART SEQUENCE switch to the down (short) position, (or enter S after entering or retrieving the warmstart program for an I1n, I4Cn, and I4n 990 Class system), the EDS does not occur.

When this bit is set, parts of PP memories are destroyed. Refer to Performing an Express Deadstart Dump in section 6 for more information.

On a CYBER 176 and I1n, I2n, I4Cn, and all I4n Class systems (excluding the 865 and 875), the alternate PP does not access central memory. On all other mainframes, the alternate PP will use word zero and words 100 through 177 of central memory to determine the type of CPU on the mainframe. CTI does, however, restore the portion of central memory that it uses prior to hand-off, but the CPU exchange packages will not be valid.

Setting Word 13

Three unique fields exist in word 13 (word 12 on CYBER 70 and 6000 computer systems) of the deadstart program, which allow you to select the CMRDECK, the deadstart parameters, and the level of deadstart. The switches, shown in figure 5-32, which represent these fields are set on the deadstart panel of all models (except I1n, I4Cn, and all I4n Class systems). For the I1n, I4n, and I4Cn Class system, the fields are entered as octal values through the system console.

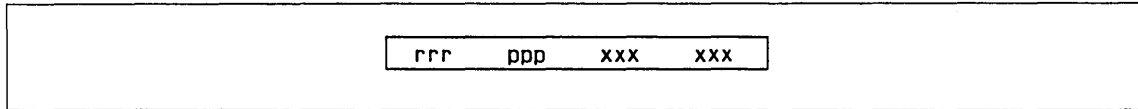

Figure 5-32. Setting Word 13 Switches

Setting	Description
rrr	Specifies the level of deadstart (not used by NOS/VE).
ppp	Specifies the deadstart parameters.
xxx xxx	Specifies the CMRDECK number (NOS), CMR number (NOS/BE) or DCFIELD number (NOS/VE).

Selecting the Deadstart Level (NOS)

You can select one of four levels of deadstarts by setting bits 11, 10, and 9 in word 13. The switches which represent this field of bits are shown in the unshaded area of figure 5-33.

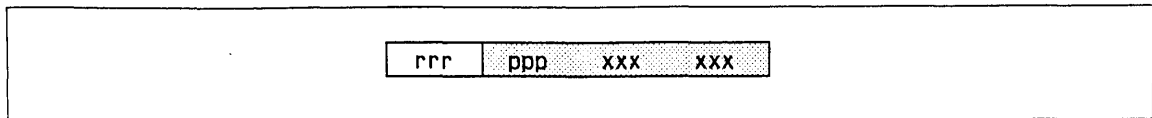

Figure 5-33. Setting Word 13, NOS Deadstart

Value of rrr (Bits 1 11-9)	Description
000	<p>Indicates an initial or level 0 deadstart, during which the system is loaded from the deadstart file. This is not considered a recovery deadstart, although permanent files, queued files, and system dayfiles are recovered automatically (unless those file types are initialized by the EQPDECK entry, INITIALIZE). If queued files are recovered, they are inactive (refer to the QREC utility in the NOS 2 Analysis Handbook for more information). Furthermore, an attempt to recover these files is initiated by all levels of system deadstarts. A level 0 deadstart is normally specified:</p> <ul style="list-style-type: none"> • For the first deadstart following a period in which the system was either inoperative or used for purposes other than NOS operations. • When a system malfunction occurred and other levels of system deadstarts prove ineffective. <p>If it is necessary to redeadstart the system (for example, due to system malfunction), it is recommended that you attempt a level 3 recovery deadstart. If you select level 0, the system is reloaded from the deadstart file. All PP contents and central memory (except on I1n, I2n, and all I4n Class systems) are destroyed by the memory confidence test.</p>

001 Indicates a level 1 recovery deadstart, during which the system, all jobs, and all active files are recovered from checkpoint information on mass storage. Permanent files are also recovered during a level 1 deadstart. You can perform a level 1 deadstart, however, only if the DSD command CHECK POINT SYSTEM (refer to the NOS 2 Operations Handbook) is successfully executed at a point immediately prior to the deadstart.

CAUTION

A level 1 deadstart does not work if the contents of the extended memory are destroyed. Once a level 1 recovery deadstart begins, all central memory (except on I1n, I2n, and all I4n Class systems)¹⁵ and PP contents are destroyed by the memory confidence test.

Normally you use a level 1 recovery deadstart to allow maintenance to be performed and then to resume normal processing. It is also useful in system test situations. Never use a level 1 recovery deadstart to attempt recovery from a system malfunction or to preserve queue files.

15. Central memory and extended memory are not destroyed on I1n, I2n, all I4n Class systems, and model 875 unless the V option is selected from the Operator Intervention display (refer to the Operator Intervention display for your model of computer system in sections 2 through 4 of this manual).

Value of rrr (Bits 1 11-9)	Description
010	<p>Indicates a level 2 recovery deadstart, during which all jobs and active files are recovered from checkpoint information on mass storage. No attempt is made to recover the system after a level 2 deadstart. Instead, the system is loaded from the deadstart file as in a level 0 deadstart. In all other respects, a level 2 recovery deadstart is identical to that described for a level 1 recovery deadstart. Once a level 2 recovery deadstart begins, all central memory (except on I1n, I2n, and all I4n Class systems)¹⁶ and PP contents are destroyed by the memory confidence test.</p> <p>Normally you use a level 2 recovery deadstart in system test situations; it is not recommended for the normal production environment.</p>
011	<p>Indicates a level 3 recovery deadstart, during which all jobs, active files, and the system (with the exception of the library directory) are recovered from central memory tables. A level 3 deadstart is the only level that preserves the contents of central memory. If a deadstart level less than 3 is selected early in the deadstart process, a memory test pattern is written throughout central memory. To avoid inadvertent destruction of central memory contents when a level 3 deadstart is intended, it is recommended that you always select level 3 on the deadstart panel. If you need a deadstart level other than 3, you can specify the level by changing the DEADSTART PARAMETERS display. In a level 3 deadstart, the library directory is recovered from mass storage and permanent files are also recovered. A CHECKPOINT SYSTEM command, however, must be issued prior to a deadstart in order to prevent loss of SYSEDIT (system library modification) information. Only PP memory confidence testing occurs during a level 3 recovery deadstart; central memory is unaffected.</p> <p>Normally you perform a level 3 recovery deadstart following an equipment malfunction (for example, channel or PP hung), providing central memory and mass storage remain intact. Unless you can determine that the central memory is no longer reliable, you should attempt a level 3 recovery following a malfunction. If level 3 recovery fails, you must perform a level 0 deadstart.</p>

NOTE

Attempting a level 1 or 2 recovery deadstart after a level 3 deadstart fails does not correctly recover system activity and can endanger system and permanent file integrity. You must perform only a level 0 deadstart following a failed level 3 deadstart.

For additional information concerning levels of deadstart, refer to the NOS 2 Operations Handbook.

16. Central memory and extended memory are not destroyed on I1n, I2n, and all I4n Class systems and model 875 unless the V option is selected from the Operator Intervention display (refer to the Operator Intervention display for your model of computer system in sections 2 through 7 of this manual).

Selecting the Deadstart Level (NOS/BE)

You can select one of four levels of deadstarts by setting bits 11, 10, and 9 in word 13. The switches that represent this field of bits are shown in the unshaded area of figure 5-34.

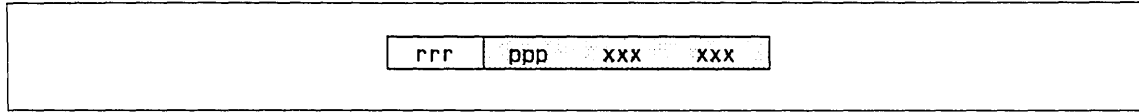

Figure 5-34. Setting Word 13, NOS/BE Deadstart

**Value of rrr
(Bits 11-9)**

Description

Value of rrr (Bits 11-9)	Description
000	Indicates an initial or level 0 deadstart, during which the system loads the deadstart file from tape to disk before setting up the CMR libraries and directory. If CTI has been installed on a member of the system set that is turned on, you can perform an RMS deadstart on subsequent deadstarts. An RMS deadstart is not possible if the following message appears at postdeadstart.

FUTURE RMS D/S NOT POSSIBLE

For additional information about this message, refer to Entering Date and Time in the NOS/BE Operator's Guide.

Upon successful completion of a level 0 deadstart, you do not need to perform any further level 0 deadstarts.

001	Indicates a level 1 recovery deadstart, which sets the CMR libraries and directory from the deadstart file on disk. You normally specify a level 1 deadstart when: <ul style="list-style-type: none"> • NOS/BE is being deadstarted after some other system has been using the mainframe. • A system malfunction has occurred and a level 3 deadstart proves ineffective.
-----	---

This level is the lowest level of deadstart which can use an RMS device as the deadstart device.

Value of rrr (Bits 11-9)	Description
010	<p data-bbox="511 258 1412 388">Indicates a level 2 recovery deadstart, during which all jobs and active files are recovered from a checkpoint file on RMS. You can do a level 2 deadstart only if the DSD command CHECKPOINT was successfully processed earlier.</p> <p data-bbox="511 415 1323 541">Extended memory contents are not saved when the system automatically enters IDLE mode. At level 627 of NOS/BE, the contents of extended memory are saved if the DSD command CHECKPOINT is entered by the operator.</p> <p data-bbox="511 569 1388 693">You normally use a level 2 deadstart to perform maintenance and then resume to normal processing. Although a level 2 doeadstart is useful in system test situations, it should never be used to attempt recovery from a system malfunction.</p>
011	<p data-bbox="511 720 1356 783">Indicates a level 3 recovery deadstart, which recovers the system (including all jobs and active files from central memory tables).</p> <p data-bbox="511 810 1421 1062">A level 3 deadstart is the only level that preserves the contents of central memory. If any deadstart level less than 3 is selected early in the deadstart process, a memory test pattern is written throughout central memory. To avoid inadvertent destruction of central memory contents when a level 3 deadstart is intended, it is recommended that you always select level 3 on the deadstart panel. If you need a deadstart level other than 3, you can specify the level by changing the DEADSTART PARAMETERS display.</p> <p data-bbox="511 1089 1421 1302">Normally you would perform a level 3 recovery deadstart following an equipment malfunction (for example, channel or PP hung), provided that the central memory, mass storage devices, and the extended memory remain intact. Unless you can determine that CMR, central memory, or RMS tables are not intact, or if a level 3 recovery fails, you must perform a level 1 deadstart. If the tables on the system set are inaccurate, perform a level 0 deadstart.</p>
NOTE	
<p data-bbox="511 1381 1412 1570">Level 0 is the only level that deadstarts exclusively from tape. In all other levels, the system can be deadstarted either from tape or disk (depending on the device selected by the deadstart panel settings). If the deadstart device is a tape unit, any level deadstart can be performed after the warning FUTURE RMS D/S NOT POSSIBLE appears at post-deadstart time.</p>	

For additional information concerning levels of deadstart, refer to the NOS/BE Operator's Guide.

Selecting the Deadstart Parameters

You can select deadstart parameters to control miscellaneous deadstart functions by setting bits 8 through 6 in word 13. The switches which represent this field of bits are shown in the unshaded area of figure 5-35.

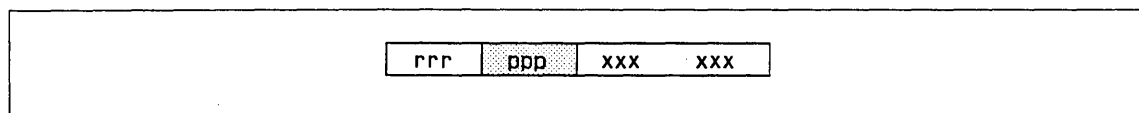

Figure 5-35. Setting Word 13, Deadstart Parameters

Setting	Description
ppp	Specifies miscellaneous deadstart functions. Refer to table 5-1.

Table 5-1. Deadstart Parameters Switch Settings

Bit Number	Switch Position	Description
8=0	Down	Reserved for future use.
7=0	Down	Reserved for future use.
6=0	Down	For NOS, indicates that the CMRDECK or the level option display is not displayed during deadstart. For NOS/VE, indicates that no operator pause is to occur during deadstart. Not used for NOS/BE.
6=1	Up	For NOS, indicates that the CMRDECK is displayed during levels 0, 1, and 2 deadstarts. Level 3 options are displayed on a level 3 deadstart. For NOS/VE, indicates that operator pause is to occur during a deadstart. Not used for NOS/BE.

When EDD dumps PP memory, the system destroys some contents of the PPO memory. You can save the entire contents of the PPO memory by reconfiguring PPs; refer to the EXPRESS DEADSTART DUMP option on the UTILITIES display (for your model of computer system; see section 2 through 4 of this manual) and to appendix G (for further information on how to reconfigure PPs).

Selecting the CMRDECK (NOS)

The CMRDECK defines the table sizes and other information to be used for system operations. Up to 64 CMRDECKs (numbered 0 through 77₈) can be included on the deadstart file.

NOTE

You can select the CMRDECK only during a level 0 (initial) deadstart. For a level 1 or 2 (recovery) deadstart, you must use the CMRDECK selected during the most recent level 0 deadstart. Refer to Selecting the Deadstart Level for NOS or for NOS/BE earlier in this section for information concerning the levels of deadstart.

The number of the selected CMRDECK is indicated by setting the switches (bits 5 through 0) in word 13 shown in the unshaded area of figure 5-36.

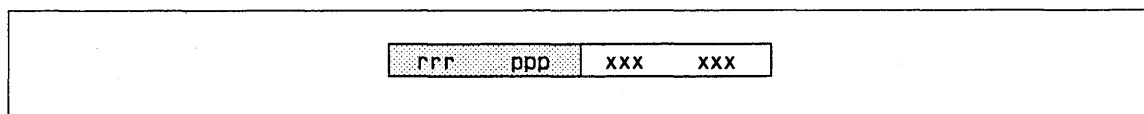

Figure 5-36. Setting Word 13, CMRDECK

Setting	Description
xxx xxx	Specifies the CMRDECK number (0 through 77 ₈) to be used.

For example, if CMRDECK number 26₈ is selected, the corresponding switches on the deadstart panel are set as follows:

rrr ppp 010 110

where 0 indicates that the switch is in the down position and 1 indicates that the switch is in the up position. You can also specify the CMRDECK from the console keyboard by using the DEADSTART PARAMETERS display. Values entered from the DEADSTART PARAMETERS display take precedence over those specified on the deadstart panel. For example, although bits 5 through 0 of word 13 on the deadstart panel (xxx xxx) could be set to select the CMRDECK most frequently used by an installation, a different CMRDECK could be selected by using the DEADSTART PARAMETERS display during a level 0 deadstart.

Selecting the CMR (NOS/BE)

The CMR defines the equipment configuration to be used for system operations. Up to 64 CMRs (numbered 0 through 77₈) can be included on the deadstart file (numbered 0 through 77₈). This provides an installation with the ability to select one of several equipment configurations when the system is deadstarted.

NOTE

You can select the CMR during a level 0 or level 1 deadstart. If it is necessary to perform a level 2 or level 3 deadstart, you must use the CMR number that was running at the time of the checkpoint (for a level 2 deadstart) or system malfunction (for a level 3 deadstart). Refer to Selecting the Deadstart Level for either NOS or NOS/BE, earlier in this section, for information concerning levels of deadstart.

The number of the CMR to be used is selected by setting the switches in word 13 (bits 5 through 0) shown in the unshaded area of figure 5-37.

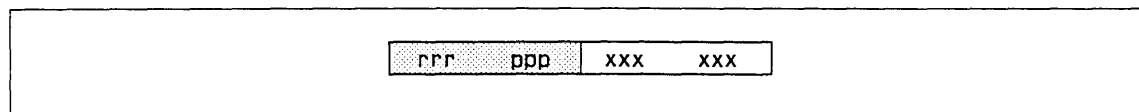

Figure 5-37. Setting Word 13, CMR

Setting	Description
---------	-------------

xxx xxx	Specifies the CMR number (0 through 77 ₈) to be used.
---------	---

For example, assume that CMR number 26₈ is to be used to define the equipment configuration at deadstart. In this case, the corresponding switches on the deadstart panel would be set as follows (0 indicates that the switch is in the down position; 1 indicates that the switch is in the up position):

xxx xxx 010 110.

It is not necessary to specify the CMR on the deadstart panel. In this case, the DEADSTART PARAMETERS display allows you to specify the CMR to be used from the console keyboard. In addition, values entered via the DEADSTART PARAMETERS display have precedence over those specified on the deadstart panel. For example, bits 0 through 5 of word 13 on the deadstart panel (xxx xxx) could be set to select the CMR which is most frequently used by an installation. However, another CMR could be selected when necessary by utilizing the DEADSTART PARAMETERS display during a level 0 or level 1 deadstart.

Selecting the DCFILE Deck (NOS/VE)

The DCFILE deck contains some of the system core commands for NOS/VE. Up to 64 DCFILE decks (numbered 0 through 77₀) can be included on the deadstart file. The number of the DCFILE deck to be used is identified in word 13 (bits 5 through 0), shown in the unshaded area of figure 5-38.

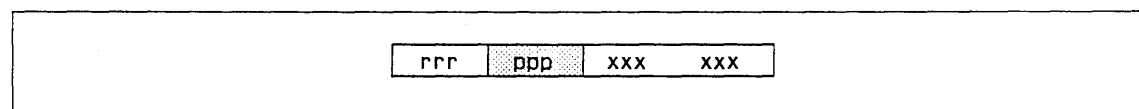

Figure 5-38. Setting Word 13, DCFILE

Setting	Description
---------	-------------

xxx xxx	Specifies the DCFILE deck number (0 through 77 ₀) to be used.
---------	---

Setting Word 12

The a field in word 12 of the deadstart program allows you to enter the model type that HIVS/MSL 15X uses to select extended deadstart testing on I1n, I2n, I4Cn, and all on I4n Class systems (except 865 and 875). A third field, f, determines whether or not the alternate PP is initialized when maintenance (M) is selected.

The switches that represent these fields are shown in figure 5-23. The switches are set on the deadstart panel for I2n Class systems, or they may be entered as octal values through the I1n, I2n, I4Cn, and all I4n Class systems console.

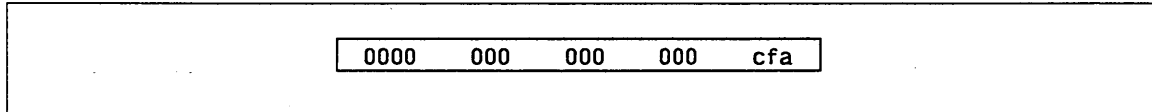

Figure 5-23. Setting Word 12 Switches (Bits c and f)

Setting	Description
c	If this field is set, word 12 specifies that the deadstart displays will appear on a CC634B console if the console is connected to port 0 of an I2n class system. A deadstart is initiated by pressing the DEADSTART button on a CC634B or CC545 console, or by pressing the DEADSTART button or switch on the deadstart panel. If the c field of word 12 is clear, the deadstart must be initiated either at the CC545 console or at the deadstart panel. After initiating this procedure, displays will appear on the CC545 console.
f	If the OS LOAD AUTOMATIC (A option) or the OS LOAD WITH INTERVENTION (O option) is selected from the INITIAL OPTIONS display, CTI will initialize the alternate PP. If this field is clear when the OFF-LINE MAINTENANCE (M option) is selected from the INITIAL OPTIONS display, it specifies that the alternate PP used for passing handoff data from CTI to the MSL is to be initialized.

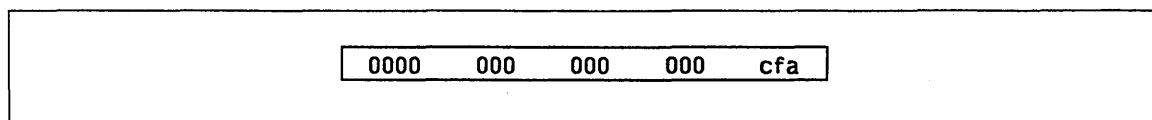

Figure 5-24. Setting Word 12 Switches (Bit a)

Setting	Description
---------	-------------

- | | |
|---|--|
| a | <p>Specifies the EXTENDED DEADSTART SEQUENCE option. If you set this bit and set the LONG/SHORT DEADSTART SEQUENCE switch on the deadstart panel to the up (long) position, (or enter L after entering or retrieving the warmstart program for an I1n, I4Cn, and I4n 990 Class system), the system loads and executes the extended deadstart sequence (EDS). If you do not set this bit or if you set the LONG/SHORT DEADSTART SEQUENCE switch to the down (short) position, (or enter S after entering or retrieving the warmstart program for an I1n, I4Cn, and I4n 990 Class system), the EDS does not occur.</p> |
|---|--|

When this bit is set, parts of PP memories are destroyed. Refer to Performing an Express Deadstart Dump in section 6 for more information.

NOTE

When you are coldstarting a tape or disk controller from a card reader, bit f is also used as part of the channel number of the card reader. Thus, the channel number of the card reader controls whether the EDS occurs when the LONG/SHORT DEADSTART SEQUENCE switch is in the up (long) position (you entered an L after loading the warmstart program for I1n, I4Cn, and all I4n Class systems). If the channel number is an odd number (the 2⁰ bit is set), the EDS takes place. If the channel number is an even number (the 2⁰ bit is not set), the EDS does not take place.

On a CYBER 176 and I1n, I2n, I4Cn, and all I4n Class systems (excluding the 865 and 875), the alternate PP does not access central memory regardless of the setting of bit f. On all other mainframes, the alternate PP will use word zero and words 100 through 177 of central memory to determine the type of CPU on the mainframe. CTI does, however, restore the portion of central memory that it uses prior to hand-off, but the CPU exchange packages will not be valid. Thus, setting bit f when selecting the M (MAINTENANCE) option will keep CTI from accessing central memory or from performing any exchange jumps of the CPU.

Setting Word 13

Three unique fields exist in word 13 (word 12 on CYBER 70 and 6000 computer systems) of the deadstart program, which allow you to select the CMRDECK, the deadstart parameters, and the level of deadstart. The switches, shown in figure 5-25, which represent these fields are set on the deadstart panel of all models (except I1n, I4Cn, and all I4n Class systems). For the I1n, I4n, and I4Cn Class system, the fields are entered as octal values through the system console.

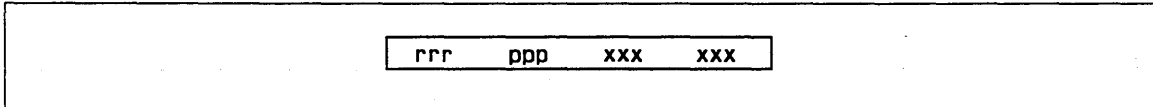

Figure 5-25. Setting Word 13 Switches

Setting	Description
rrr	Specifies the level of deadstart (not used by NOS/VE).
ppp	Specifies the deadstart parameters.
xxx xxx	Specifies the CMRDECK number (NOS), CMR number (NOS/BE) or DCFIELD number (NOS/VE).

Selecting the Deadstart Level (NOS)

You can select one of four levels of deadstarts by setting bits 11, 10, and 9 in word 13. The switches which represent this field of bits are shown in the unshaded area of figure 5-26.

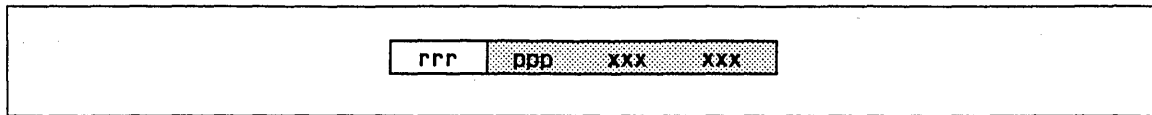

Figure 5-26. Setting Word 13, NOS Deadstart

Value of rrr (Bits 1 11-9)	Description
000	<p>Indicates an initial or level 0 deadstart, during which the system is loaded from the deadstart file. This is not considered a recovery deadstart, although permanent files, queued files, and system dayfiles are recovered automatically (unless those file types are initialized by the EQPDECK entry, INITIALIZE). If queued files are recovered, they are inactive (refer to the QREC utility in the NOS 2 Analysis Handbook for more information). Furthermore, an attempt to recover these files is initiated by all levels of system deadstarts. A level 0 deadstart is normally specified:</p> <ul style="list-style-type: none"> • For the first deadstart following a period in which the system was either inoperative or used for purposes other than NOS operations. • When a system malfunction occurred and other levels of system deadstarts prove ineffective. <p>If it is necessary to redeadstart the system (for example, due to system malfunction), it is recommended that you attempt a level 3 recovery deadstart. If you select level 0, the system is reloaded from the deadstart file. All PP contents and central memory (except on I1n, I2n, and all I4n Class systems) are destroyed by the memory confidence test.</p>

001

Indicates a level 1 recovery deadstart, during which the system, all jobs, and all active files are recovered from checkpoint information on mass storage. Permanent files are also recovered during a level 1 deadstart. You can perform a level 1 deadstart, however, only if the DSD command CHECK POINT SYSTEM (refer to the NOS 2 Operations Handbook) is successfully executed at a point immediately prior to the deadstart.

CAUTION

A level 1 deadstart does not work if the contents of the extended memory are destroyed. Once a level 1 recovery deadstart begins, all central memory (except on I1n, I2n, and all I4n Class systems)¹³ and PP contents are destroyed by the memory confidence test.

Normally you use a level 1 recovery deadstart to allow maintenance to be performed and then to resume normal processing. It is also useful in system test situations. Never use a level 1 recovery deadstart to attempt recovery from a system malfunction or to preserve queue files.

13. Central memory and extended memory are not destroyed on I1n, I2n, all I4n Class systems, and model 875 unless the V option is selected from the Operator Intervention display (refer to the Operator Intervention display for your model of computer system in sections 2 through 4 of this manual).

Value of rrr (Bits 1 11-9)	Description
010	<p>Indicates a level 2 recovery deadstart, during which all jobs and active files are recovered from checkpoint information on mass storage. No attempt is made to recover the system after a level 2 deadstart. Instead, the system is loaded from the deadstart file as in a level 0 deadstart. In all other respects, a level 2 recovery deadstart is identical to that described for a level 1 recovery deadstart. Once a level 2 recovery deadstart begins, all central memory (except on I1n, I2n, and all I4n Class systems)¹⁴ and PP contents are destroyed by the memory confidence test.</p> <p>Normally you use a level 2 recovery deadstart in system test situations; it is not recommended for the normal production environment.</p>
011	<p>Indicates a level 3 recovery deadstart, during which all jobs, active files, and the system (with the exception of the library directory) are recovered from central memory tables. A level 3 deadstart is the only level that preserves the contents of central memory. If a deadstart level less than 3 is selected early in the deadstart process, a memory test pattern is written throughout central memory. To avoid inadvertent destruction of central memory contents when a level 3 deadstart is intended, it is recommended that you always select level 3 on the deadstart panel. If you need a deadstart level other than 3, you can specify the level by changing the DEADSTART PARAMETERS display. In a level 3 deadstart, the library directory is recovered from mass storage and permanent files are also recovered. A CHECKPOINT SYSTEM command, however, must be issued prior to a deadstart in order to prevent loss of SYSEDIT (system library modification) information. Only PP memory confidence testing occurs during a level 3 recovery deadstart; central memory is unaffected.</p> <p>Normally you perform a level 3 recovery deadstart following an equipment malfunction (for example, channel or PP hung), providing central memory and mass storage remain intact. Unless you can determine that the central memory is no longer reliable, you should attempt a level 3 recovery following a malfunction. If level 3 recovery fails, you must perform a level 0 deadstart.</p>

NOTE

Attempting a level 1 or 2 recovery deadstart after a level 3 deadstart fails does not correctly recover system activity and can endanger system and permanent file integrity. You must perform only a level 0 deadstart following a failed level 3 deadstart.

For additional information concerning levels of deadstart, refer to the NOS 2 Operations Handbook.

14. Central memory and extended memory are not destroyed on I1n, I2n, and all I4n Class systems and model 875 unless the V option is selected from the Operator Intervention display (refer to the Operator Intervention display for your model of computer system in sections 2 through 7 of this manual).

Selecting the Deadstart Level (NOS/BE)

You can select one of four levels of deadstarts by setting bits 11, 10, and 9 in word 13. The switches that represent this field of bits are shown in the unshaded area of figure 5-27.

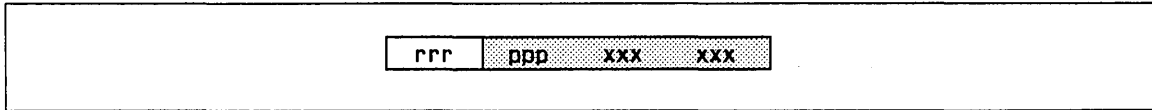

Figure 5-27. Setting Word 13, NOS/BE Deadstart

Value of rrr (Bits 11-9)	Description
000	<p>Indicates an initial or level 0 deadstart, during which the system loads the deadstart file from tape to disk before setting up the CMR libraries and directory. If CTI has been installed on a member of the system set that is turned on, you can perform an RMS deadstart on subsequent deadstarts. An RMS deadstart is not possible if the following message appears at postdeadstart.</p> <p style="text-align: center;">FUTURE RMS D/S NOT POSSIBLE</p> <p>For additional information about this message, refer to Entering Date and Time in the NOS/BE Operator's Guide.</p> <p>Upon successful completion of a level 0 deadstart, you do not need to perform any further level 0 deadstarts.</p>
001	<p>Indicates a level 1 recovery deadstart, which sets the CMR libraries and directory from the deadstart file on disk. You normally specify a level 1 deadstart when:</p> <ul style="list-style-type: none"> • NOS/BE is being deadstarted after some other system has been using the mainframe. • A system malfunction has occurred and a level 3 deadstart proves ineffective. <p>This level is the lowest level of deadstart which can use an RMS device as the deadstart device.</p>

Value of rrr (Bits 11-9)	Description
010	<p>Indicates a level 2 recovery deadstart, during which all jobs and active files are recovered from a checkpoint file on RMS. You can do a level 2 deadstart only if the DSD command CHECKPOINT was successfully processed earlier.</p> <p>Extended memory contents are not saved when the system automatically enters IDLE mode. At level 627 of NOS/BE, the contents of extended memory are saved if the DSD command CHECKPOINT is entered by the operator.</p> <p>You normally use a level 2 deadstart to perform maintenance and then resume to normal processing. Although a level 2 deadstart is useful in system test situations, it should never be used to attempt recovery from a system malfunction.</p>
011	<p>Indicates a level 3 recovery deadstart, which recovers the system (including all jobs and active files from central memory tables).</p> <p>A level 3 deadstart is the only level that preserves the contents of central memory. If any deadstart level less than 3 is selected early in the deadstart process, a memory test pattern is written throughout central memory. To avoid inadvertent destruction of central memory contents when a level 3 deadstart is intended, it is recommended that you always select level 3 on the deadstart panel. If you need a deadstart level other than 3, you can specify the level by changing the DEADSTART PARAMETERS display.</p> <p>Normally you would perform a level 3 recovery deadstart following an equipment malfunction (for example, channel or PP hung), provided that the central memory, mass storage devices, and the extended memory remain intact. Unless you can determine that CMR, central memory, or RMS tables are not intact, or if a level 3 recovery fails, you must perform a level 1 deadstart. If the tables on the system set are inaccurate, perform a level 0 deadstart.</p>

NOTE

Level 0 is the only level that deadstarts exclusively from tape. In all other levels, the system can be deadstarted either from tape or disk (depending on the device selected by the deadstart panel settings). If the deadstart device is a tape unit, any level deadstart can be performed after the warning FUTURE RMS D/S NOT POSSIBLE appears at post-deadstart time.

For additional information concerning levels of deadstart, refer to the NOS/BE Operator's Guide.

Selecting the Deadstart Parameters

You can select deadstart parameters to control miscellaneous deadstart functions by setting bits 8 through 6 in word 13. The switches which represent this field of bits are shown in the unshaded area of figure 5-28.

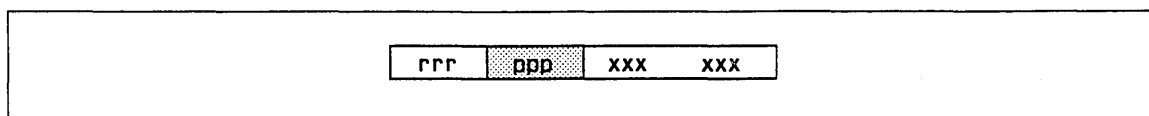

Figure 5-28. Setting Word 13, Deadstart Parameters

Setting	Description
ppp	Specifies miscellaneous deadstart functions. Refer to table 5-1.

Table 5-1. Deadstart Parameters Switch Settings

Bit Number	Switch Position	Description
8	Down	Reserved for future use.
7	Down	Reserved for future use.
6=0	Down	For NOS, indicates that the CMRDECK or the level option display is not displayed during deadstart. For NOS/VE, indicates that no operator pause is to occur during deadstart. Not used for NOS/BE.
6=1	Up	For NOS, indicates that the CMRDECK is displayed during levels 0, 1, and 2 deadstarts. Level 3 options are displayed on a level 3 deadstart. For NOS/VE, indicates that operator pause is to occur during a deadstart. Not used for NOS/BE.

When EDD dumps PP memory, the system destroys some contents of the PPO memory. You can save the entire contents of the PPO memory by reconfiguring PPs; refer to the EXPRESS DEADSTART DUMP option on the UTILITIES display (for your model of computer system; see section 2 through 4 of this manual) and to appendix G (for further information on how to reconfigure PPs).

Selecting the CMRDECK (NOS)

The CMRDECK defines the table sizes and other information to be used for system operations. Up to 64 CMRDECKs (numbered 0 through 77₈) can be included on the deadstart file.

NOTE

You can select the CMRDECK only during a level 0 (initial) deadstart. For a level 1 or 2 (recovery) deadstart, you must use the CMRDECK selected during the most recent level 0 deadstart. Refer to Selecting the Deadstart Level for NOS or for NOS/BE earlier in this section for information concerning the levels of deadstart.

The number of the selected CMRDECK is indicated by setting the switches (bits 5 through 0) in word 13 shown in the unshaded area of figure 5-29.

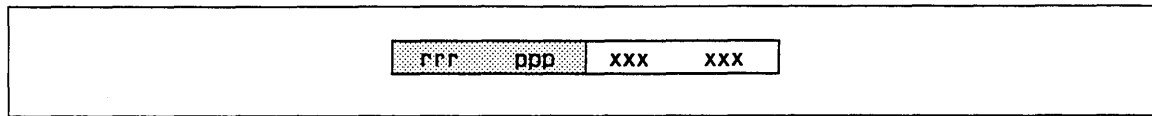

Figure 5-29. Setting Word 13, CMRDECK

Setting	Description
---------	-------------

xxx xxx	Specifies the CMRDECK number (0 through 77 ₈) to be used.
---------	---

For example, if CMRDECK number 26₈ is selected, the corresponding switches on the deadstart panel are set as follows:

rrr	ppp	010	110
-----	-----	-----	-----

where 0 indicates that the switch is in the down position and 1 indicates that the switch is in the up position. You can also specify the CMRDECK from the console keyboard by using the DEADSTART PARAMETERS display. Values entered from the DEADSTART PARAMETERS display take precedence over those specified on the deadstart panel. For example, although bits 5 through 0 of word 13 on the deadstart panel (xxx xxx) could be set to select the CMRDECK most frequently used by an installation, a different CMRDECK could be selected by using the DEADSTART PARAMETERS display during a level 0 deadstart.

Selecting the CMR (NOS/BE)

The CMR defines the equipment configuration to be used for system operations. Up to 64 CMRs (numbered 0 through 77₈) can be included on the deadstart file (numbered 0 through 77₈). This provides an installation with the ability to select one of several equipment configurations when the system is deadstarted.

NOTE

You can select the CMR during a level 0 or level 1 deadstart. If it is necessary to perform a level 2 or level 3 deadstart, you must use the CMR number that was running at the time of the checkpoint (for a level 2 deadstart) or system malfunction (for a level 3 deadstart). Refer to Selecting the Deadstart Level for either NOS or NOS/BE, earlier in this section, for information concerning levels of deadstart.

The number of the CMR to be used is selected by setting the switches in word 13 (bits 5 through 0) shown in the unshaded area of figure 5-30.

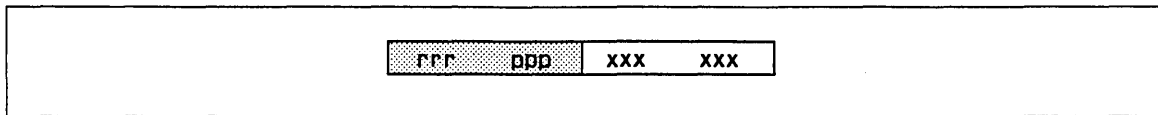

Figure 5-30. Setting Word 13, CMR

Setting	Description
---------	-------------

xxx xxx	Specifies the CMR number (0 through 77 ₈) to be used.
---------	---

For example, assume that CMR number 26₈ is to be used to define the equipment configuration at deadstart. In this case, the corresponding switches on the deadstart panel would be set as follows (0 indicates that the switch is in the down position; 1 indicates that the switch is in the up position):

xxx xxx 010 110.

It is not necessary to specify the CMR on the deadstart panel. In this case, the DEADSTART PARAMETERS display allows you to specify the CMR to be used from the console keyboard. In addition, values entered via the DEADSTART PARAMETERS display have precedence over those specified on the deadstart panel. For example, bits 0 through 5 of word 13 on the deadstart panel (xxx xxx) could be set to select the CMR which is most frequently used by an installation. However, another CMR could be selected when necessary by utilizing the DEADSTART PARAMETERS display during a level 0 or level 1 deadstart.

Selecting the DCFILE Deck (NOS/VE)

The DCFILE deck contains some of the system core commands for NOS/VE. Up to 64 DCFILE decks (numbered 0 through 77₀) can be included on the deadstart file. The number of the DCFILE deck to be used is identified in word 13 (bits 5 through 0), shown in the unshaded area of figure 5-31.

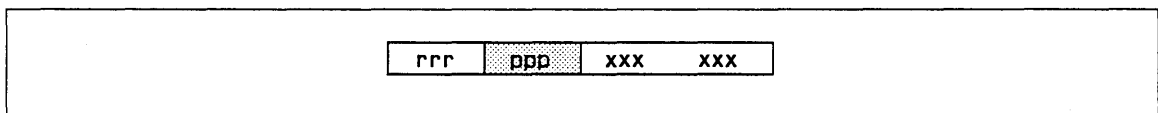

Figure 5-31. Setting Word 13, DCFILE

Setting	Description
---------	-------------

xxx xxx	Specifies the DCFILE deck number (0 through 77 ₀) to be used.
---------	---

Emergency CIP Repair	6-3
Installing an Individual CIP Module	6-3
Replacing EI, Microcode, SCD, MDD, or SCI	6-4
Replacing an MSL Module	6-4
Replacing an HIVS Module	6-5
Replacing a CTI Module	6-5
CIP Utility Procedures	6-7
Performing an Express Deadstart Dump	6-7
Performing a Printer Dump (All Systems, Excluding I4Cn Class Systems)	6-18
Selecting an Alternate Deadstart Device (All Systems, Excluding I4Cn Class Systems).....	6-20
Modifying Default Parameters	6-21
Performing a Power-On Initialization (I1n, I2n, I4Cn, and All I4n Class Systems).....	6-24
Clearing ESM (Except I1n, I2n, I4Cn, and All I4n Class Systems)	6-26
Loading and Installing Disk Subsystem Microcode from Tape	6-28
Operator Intervention Procedures	6-31
Running Hardware Verification Sequence (HIVS) (All Systems, Excluding I4Cn Class Systems).....	6-31
Resetting the Deadstart Parameters	6-32
Build Deadstart Disk Operations (All Systems, Excluding I4Cn Class Systems)	6-35
Manually Replace Modules on the Deadstart Disk	6-35
Install-Update CIP System Console Utility (IUC)	6-40
IUC Parameter Entries	6-41
CIP Installation Display	6-43
I - INITIAL INSTALLATION	6-43
U - UPDATE INSTALLATION	6-43
M - MANUAL INSTALLATION	6-43
Manual Operations Display	6-44
C - REPLACE CTI	6-44
T - REPLACE MSL	6-44
D - REPLACE COMMON DISK AREA	6-51
Special Keys and Descriptive Messages Utilized by IUC	6-53
Special Keys	6-53
Informative Messages	6-54
Error Messages	6-55

This section includes procedures that are generally independent of the computer system model or that apply to a range of models. Notes with the procedures indicate when model types are significant.

Most of the procedures included here use several of the displays and options offered by CIP. The starting point of a procedure is generally a deadstart operation, or a major options display such as the CONSOLE MAIN MENU display, the INITIAL OPTIONS display, the UTILITIES display, the MANUAL OPERATIONS display, and so forth.

Emergency CIP Repair

If a critical problem exists with one of the CIP modules, a patch to fix the problem may be required. Patches are sent to the CE in the form of a new module, providing a critical PSR or critical TAR has been received from the site. Install the new module to the deadstart disk to replace the module with the problem. Use the individual CIP module installation procedures described next.

NOTE

The patched module is a temporary solution. Control Data will combine the patched module with the other CIP modules to form a new CIP level. The new CIP tape is then sent out as an FCO. Install the CIP FCO to the deadstart disk to replace the patched module.

Emergency CIP repair considerations:

- Manual operations can only be executed from the CIP tape.
- When manual operations options are used to install microcode or EI, the system appends an asterisk to the module name. The asterisk denotes to support personnel that the module has been modified. You display the module name by selecting option L, DISPLAY CIP COMPONENT INFORMATION, from the UTILITIES display.
- Do not use the manual operations to mix components of CIPs of different levels; that is, do not install only the microcode from a new CIP.
Microcode released with the initial CIP release (November 1983) does not work with CTI at L149 (or before).

For I4Cn Class system installation/replacement procedures, refer to Install-Update CIP Utility (IUC) later in this section.

Installing an Individual CIP Module

Install the patched module using this procedure.

1. Mount the current CIP tape on a tape drive.
2. Mount the tape containing the patched module on another tape drive.
3. Set the deadstart program for a deadstart from the CIP tape.
4. Initiate deadstart. The INITIAL OPTIONS display appears.
5. Press the carriage return key to select the BUILD DEADSTART DISK option. The BUILD DEADSTART DISK display appears.
6. Enter an M to select manual operations. The MANUAL OPERATIONS display appears.
7. The next steps depend upon the type of module that was patched: EI, microcode, MSL, HIVS, or CTI. Use the following applicable procedure.

Replacing EI, Microcode, SCD, MDD, or SCI

1. Enter D while displaying the MANUAL OPERATIONS display to replace EI, microcode, SCD, MDD, DFT, or SCI.
2. Enter:
 - a. The disk channel and unit number of the deadstart disk then press the carriage return key, or
 - b. The tape type, channel, equipment, and unit numbers of patched module tape then press the carriage return key.
3. Enter B to replace microcode, C to replace EI, D to replace CC634B SCD, E to replace MDD, F to replace DFT, or H to replace SCI.
4. The patched module is installed to disk.
5. Initiate deadstart.

Replacing an MSL Module

1. Enter T while displaying the MANUAL OPERATIONS display to install MSL. The initial TDX display appears.
2. Press the carriage return key.
3. Enter the channel and unit of the deadstart disk.
4. Enter the device type, channel, equipment, and unit of the tape drive containing the patched MSL module then press the carriage return key. The TDX OPTIONS display appears.
5. Enter A to build MSL on disk from tape. The MSL INSTALLATION options appear.
6. Enter F to perform a full installation in MSL/OS shared disk mode. The system asks you if you want to save command buffers.
7. Enter Y to save command buffers or N to load command buffers from tape.
8. Press the carriage return key when TDX displays:

```
COPY FROM  
-CR- = 1st NAME
```
9. Press the carriage return key when TDX displays:

```
COPY THRU  
-CR- = LAST NAME
```
10. Enter Y if you want TDX to perform a write verify function when transferring the data, or N for no verification. MSL installation is complete when TDX displays the last cylinder, track, and sector used for the copy.
11. Initiate deadstart.

Replacing an HIVS Module

1. Enter T while displaying the MANUAL OPERATIONS display to install HIVS (for sites with no maintenance contract).
2. Enter the channel and unit of the deadstart disk.
3. Enter the type, channel, equipment, and unit of the tape device containing the patched HIVS module then press the carriage return key.
When the message INSTALLATION COMPLETE appears, HIVS installation is complete.
4. Initiate deadstart.

Replacing a CTI Module

1. Enter C. to install CTI. This warning message appears:

```
*WARNING*  
PERMANENT FILES MAY BE LOST  
IF CTI IS NOT ALREADY  
INSTALLED ON THIS DEVICE  
(CR) TO CONTINUE
```

2. Press the carriage return key to continue.
3. Enter the channel and unit of the deadstart disk.
4. Upon successful installation, the following messages appear:

```
INSTALL COMPLETE  
  
(CR) TO PROCESS DIFFERENT DEVICE
```

5. Initiate deadstart.

CIP Utility Procedures

The procedures described next use one or more of the options offered on the UTILITIES display. The UTILITIES display may be accessed during either a deadstart from disk or deadstart from CIP tape operation.

NOTE

The UTILITIES display may be accessed during a deadstart from CIP device for I4Cn Class systems.

Performing an Express Deadstart Dump

Express Deadstart Dump (EDD) is an option offered on the UTILITIES display. It dumps the contents of PP memories, central memory, extended memory, CPU hardware registers, status/control (S/C) registers, maintenance registers (on I1n [Model 815], I2n, I4Cn, and all I4n Class systems), processor control store (on I1n, I2n, and all I4n Class systems), and tape and disk (except FSC) controlware to magnetic tape.

The default tape density is 800 cpi for seven-track 667/677 tapes and 1600 bpi for nine-track 639/669/679/698/5698 tapes. All tapes are written in S format and as one file.

NOTE

EDD dumps unified extended memory (UEM) for models 810 through 990 (and for models 865 and 875 that contain UEM). For all other CYBER 170 computer systems (including models 865 and 875 with external extended memory), you must dump extended memory separately.

When EDD dumps PP memories, it destroys some of the contents of the PPs. For all systems except models 810 through 990, the following locations are affected.

PP	Locations
PP0	0 through 52 ₈ and 4275 ₈ through 7777 ₈ .
PP1	0 through 7.
All other PPs	0 through 3 and 7771 ₈ through 7777 ₈ .

On I1n, I2n, I4Cn, and all I4n Class systems, the long deadstart sequence and the UEM destroy parts of PP memories. If you select EDD after selecting one of these deadstart sequences, some of the information dumped is not valid. The amount of information destroyed depends on whether EDD was preceded by a short deadstart or long deadstart sequence and the setting of bit 2⁰ in word 12 (EDS) of the deadstart program. Table 6-1 shows the effect of EDD.

Table 6-1. Locations Affected by EDD

PP	Short Deadstart Sequence	Long Deadstart or Long Deadstart with EDS
PP0	0 through 52 ₈ , 4275 ₈ through 7777 ₈ .	All memory destroyed.
PP1 through PP4	No loss.	All memory destroyed.
All other PPs	No loss.	No loss.

If you deadstart from a channel of an active PP on I1n, I2n, I4Cn, or any I4n Class system, that PP loses the contents in locations 0 and 1.

For all systems, if you want to dump the entire contents of PP0, you must reconfigure the PPs to deadstart from another PP or transfer the contents of PP0 to another PP before using EDD. When possible, reconfigure PPs. If you cannot reconfigure PPs, transfer the contents of PP0 to another PP prior to the dump as follows:

1. Choose a channel of an active PP to which the system can transfer the contents of PP0.
2. Enter the following deadstart panel program.

	Binary				Octal
word 1	010	000	000	000	2000
2	111	111	111	111	7776
3	111	011	ppp	ppp	73pp
4	000	000	000	000	0000
5	000	011	000	000	0300

pp is number of the PP you chose to hold contents of PP0.

3. Initiate a short deadstart sequence to run the program described in step 2. The system transfers contents of PP0 to the PP you selected. Contents of that PP are destroyed by the transfer.
4. Reset deadstart program for the appropriate warmstart.

NOTE

If you have reconfigured PPs or transferred the contents of PP0, you must redeadstart to use EDD. Remember which PP has the contents of PP0, so when the system dumps PPs you know which PP to print to get contents of PP0.

The following EDD procedure assumes that a dump tape has been mounted on the tape unit and the tape unit is ready. This procedure also assumes you have deadstarted the system and have selected the UTILITIES display.

1. Enter E to start the dump process. The console displays:

```
EXPRESS DUMP DEVICE TYPE - m

1=667, 669          ( 800 BPI)
2=667                ( 800 BPI)
   639, 679, 698, 5698 (1600 BPI)
3=639, 679, 698, 5698 (6250 BPI)
```

The value m is the device type specified in the default parameter block of the CTI/CDA (common disk area). If the parameter block is not present, zeros are displayed.

NOTE

If the dump tape is mounted on a drive that does not support the selected tape type/density, unexpected results may occur. In such a case, the EDD must be restarted. The integrity of some of the information obtained during the second dump is questionable.

2. Press the carriage return key to use the device type being displayed or enter a 1, 2, or 3, then press the carriage return key to specify an alternate device. The console displays:

```
EXPRESS DUMP DEVICE TYPE - m

CHANNEL-cc

(BS) - BACK TO PREVIOUS ENTRY
```

The value cc is the channel specified in the default parameter block in the CTI/CDA. If the parameter block is not present, zeros are displayed.

NOTE

The channel entered in response to this display must be equal to or greater in value than 2 (in a CYBER 992 or 994, the channel must be 2, 3, or 4). If an erroneous channel is entered, you will be prompted back to this display after executing step 4.

3. Press the carriage return key to use the channel being displayed or enter the two-digit channel number of the tape unit to which data is to be dumped and press the carriage return key. The console displays:

```
EXPRESS DUMP DEVICE TYPE - m
```

```
CHANNEL-cc
```

```
EQUIPMENT-e
```

```
(BS) - BACK TO PREVIOUS ENTRY
```

The value e is the equipment number specified in the default parameter block in the CTI/CDA. If the default parameter block is not present, zeros are displayed.

4. Press the carriage return key to use the equipment number displayed or enter the equipment number and press the carriage return key. The console displays:

```
EXPRESS DUMP DEVICE TYPE - m
```

```
CHANNEL-cc
```

```
EQUIPMENT-e
```

```
UNIT-uu
```

```
(BS) - BACK TO PREVIOUS ENTRY
```

The value uu is the unit number specified in the default parameter block of the CTI/CDA. If the default parameter block is not present, zeros are displayed.

5. Press the carriage return key to use the unit number displayed or enter the two-digit unit number and press the carriage return key. The console displays:

```
EXPRESS DUMP NUMBER = 00
```

6. If the system does not have a clock chip, EDD asks for the current day's date using the following display.

```
ENTER DATE - 00/00/00
```

```
(FORMAT YY/MM/DD)
```

```
(SPACE - SKIP FOR CHANGES)
```

```
(LEFT BLANK - ZERO ENTRY)
```

```
(BS) - BACK TO PREVIOUS ENTRY
```

7. The console next displays:

UNLOAD DUMP TAPE OPTION.

Y - UNLOAD TAPE AFTER DUMP.

N - REWIND TAPE AFTER DUMP.

(CR) - UNLOAD TAPE AFTER DUMP.

(BS) - BACK TO PREVIOUS ENTRY.

Press Y to have the dump tape unloaded after the dump is completed. Press N to have the tape rewound and ready when the dump is completed. The default is to have the tape unloaded.

8. The following message appears for computer systems with the following configurations (except for CYBER 992 and 994).

- All CYBER 170-7XX, CDC 6000, and CYBER 70.
- I1n, I2n, I4Cn, and all I4n Class systems with the ECS/ESM prompt bit set in the deadstart panel/program.

NOTE

The ECS/ESM prompt bit should be set only if access to extended memory is through the Low Speed Port. This bit is bit 2⁸ of word 13 for all configurations except for CDC 6000 and CYBER to mainframes that are deadstarting on a channel with an active PP (any channel but 0, 12, 13, 32, and 33).

The console displays:

ECS/LCM/ESM DUMP OPTIONS

(CR) = DO NOT DUMP EXTENDED MEMORY.

NNNN = NUMBER OF 10000B WORD BLOCKS.

(BS) - BACK TO PREVIOUS ENTRY.

Status line

Keyboard input

This display indicates how much extended memory should be dumped. Keyboard input is shown on the keyboard input line.

Press the carriage return key to skip this option, or enter the number of 10000₈ word blocks of extended memory, then press the carriage return key to dump extended memory.

If a nonzero value was specified in the previous display for the number of blocks of extended memory to dump and the ECS/ESM prompt bit is set in the deadstart panel, the following display appears.

EXTENDED MEMORY CHANNEL

(CR) = NO EM CHANNEL.

00 = CHANNEL TO DUMP EM.

(BS) = BACK TO PREVIOUS ENTRY.

This display prompts for the channel number for EDD to dump ECS/ESM.

9. The console next displays (except in CYBER 992 and 994 systems):

CONTROLWARE WILL BE DUMPED
FROM THE FOLLOWING CHANNELS

NONE (the channel numbers used are displayed here)

CONTROLWARE DUMP OPTIONS

DUMP = CH
DUMP CONTROLWARE
FROM SPECIFIED CHANNELS.

CLEAR = CH
DO NOT DUMP CONTROLWARE
FROM SPECIFIED CHANNELS.

(CR) PROCEED WITH DUMP.
(BS) - BACK TO PREVIOUS ENTRY.

Status line
Keyboard line

Channel numbers are added to this display as they are selected to be dumped.
The following controllers have dumpable controlware and are supported by EDD.

Controller Product Number	Controller Name
7021-1x	66X Tape
7154/55	844 Disk, 885 Disk
7165(CCC)	895 Disk
10395	ISD-I Disk
FA7B4	ISD-II Disk
7221	63X Tape (ISMT)

Channels that are not connected to one of the above controllers should NOT be specified to be dumped by EDD, as EDD may hang in trying to dump controlware from channels that have unknown equipment. This would prevent EDD from writing the end-of-tape marks at the end of the dump, and make the dump useless for later analysis.

NOTE

The tape controller 7021-1x does allow for the dumping of buffer controlware by EDD, but the controllers 7021-2x and 7021-4x do not.

10. Enter D, the channel number, and press the carriage return key for each channel from which the controlware should be dumped. The system completes entry of the word DUMP and inserts the equal sign for you. The channel numbers are added to the list of channels to be dumped.

Enter C, the channel number, and press the carriage return key to remove a channel from the list of channels to be dumped. The system completes entry of the word CLEAR and inserts an equal sign for you.

The default is no controlware will be dumped.

11. If the dump tape equipment is not ready, the console displays:

```
DUMP TAPE ON CHcc EQee UNuu NOT READY (CR WHEN READY)
```

cc Channel number.

ee Equipment number.

uu Unit number.

Ready the equipment then press the carriage return key to continue.

12. If the write ring is not on the tape, the console displays:

```
DUMP TAPE ON CHcc EQee UNuu NO WRITE RING (CR WHEN READY)
```

Insert the write ring then press the carriage return key.

13. When EDD reaches the end of a tape reel before dump completion, the following message is displayed.

```
DUMP TAPE ON CHcc EQee UNuu WAITING REELrr (CR WHEN READY)
```

cc = dump tape channel number.

ee = dump tape equipment number.

uu = dump tape unit number.

rr = dump tape reel number.

14. The following messages are issued when a dump tape to be written upon contains label information prohibiting such action.

```
VSN = vvvvvv NOT ACCESSIBLE
```

This message indicates that the Volume Accessibility Field in the existing VOL1 label is not blank. A different tape must be used.

```
VSN = vvvvvv FILE NOT EXPIRED
```

This message indicates that the HRD1 label contains an expiration date greater than today's date, as indicated by either the calendar/clock chip or operator input. An unlabeled or expired tape must be used.

15. The existing message, EXPRESS DUMP IN PROGRESS, (for a system containing a 721 console) has been augmented by the following message.

REEL nn, VSN = vvvvvv

where nn is the current reel number and vvvvvv is the volume serial number of the tape being written.

16. In the case where the tape controller does not load the character conversion tables correctly, EDD will hang and display the following message.

CHi i Tj kTS CONVERSION TABLE LOAD ERRORS.
DEADSTART REQUIRED.

i i = dump tape channel number.

j = 7 for 7-track dump tape.

= 9 for 9-track dump tape.

k = M for MTS Tape Subsystem.

= A for ATS, 67X, FSC, CCC, or 63X Tape Subsystems.

Dumping to a tape on a different channel is required.

17. Press the carriage return key to initiate the dump.

When the CC634B console is being used for models 810 or 830, the following message is displayed.

EXPRESS DUMP IN PROGRESS

18. When the dump is complete, the console displays:

DUMP id COMPLETE

id is dump identifier entered during sequence.

On all systems except I1n and I2n Class systems, the following message is displayed if an extended memory dump was specified and extended memory was not able to be dumped.

DUMP id COMPLETE.
DEADSTART REQUIRED.
ECS/ESM NOT ACCESSIBLE.

On all systems the following message is displayed if one or more of the channels selected for the controlware dump options was not able to be dumped.

DUMP id COMPLETE.
DEADSTART REQUIRED.

CONTROL WAS NOT DUMPED
FROM THE FOLLOWING CHANNELS

nn	nn	nn	nn	nn	nn
nn	nn	nn	nn	nn	nn
nn	nn	nn	nn	nn	nn
nn	nn	nn	nn	nn	nn

nn is the channel number to be dumped. From 1 to 24 channel numbers may be displayed.

The ECS/ESM NOT ACCESSIBLE and the CONTROLWARE WAS NOT DUMPED messages may both be displayed if the conditions that cause them to be displayed exist simultaneously.

If an error occurred during the dump, one of the following messages appears.

ERROR IN (error)
FATAL TO DUMP OPERATION

or

DUMP SUCCESSFUL
equipment
(CR) TO SEE ERROR STATUS

Error	Description
UN	Unit errors.
EQ	Controller errors.
CH	Channel errors.

Equipment	Description
BC	Buffer controller.
CM	Central memory.
CPU	Central processor hardware registers.
ECS-LCM	Extended memory (except unified extended memory).
FLPP	First level peripheral processors (for model 176 only).
MMR ¹	Memory maintenance registers.
MR	Maintenance registers (for models 810 through 860).
PCS ¹	Processor control store.
PEP ¹	Processor exchange package.
PMR ¹	Processor maintenance registers.
PP _i	Peripheral processors numbered consecutively ($0 < i < 17$).
PRF ¹	Processor register file.
SCR ²	Status and control registers.

If you press the carriage return key following this display, the system displays general and detailed equipment status information.

NOTE

If a CPU is logically turned off, a flag indicating this is set in the dump and the CPU is not exchanged during EDD execution. If CPU0 is down on a one-CPU system, both CPU0 and CPU1 must be logically turned off at deadstart to avoid exchanging of the registers.

If you reconfigured PPs before the dump, reconfigure them back to their normal settings after system completes the dump.

1. For I1n, I2n, I4Cn, and all I4n Class systems.

2. For all models except I1n, I2n, I4Cn, and all I4n Class systems. For models 865 and 875, S/C registers are maintenance registers.

Performing a Printer Dump (All Systems, Excluding I4Cn Class Systems)

A printer dump is an option offered on the UTILITIES display. It dumps the contents (in octal or hexadecimal) of part or all of a PP memory, central memory, register files, IOU registers, CM registers, CP registers, S/C registers (except models 810 through 860), and control store buffers selected by the operator to a line printer.

CTI supports print capability on a 512-line printer and the 580-12, 580-16, 580-20, 580-120, 580-160, or 580-200 line printers using print array cartridges 596-1 through 596-6. Not all computer systems or operating systems, however, support these printers.

The following procedure assumes that your line printer is ready and that you have deadstarted the system and selected the UTILITIES display.

1. Enter P. The console displays printer dump options. The options offered depend on the computer system model. Refer to the display shown in the section on displays and options for your model of computer system. You cannot return to the UTILITIES display from this display. You must redeadstart the system.
2. Select option A or B.
 - A Select this option to initialize the 512-line printer buffer image with the data necessary to print with a 512-1 print train. The A parameter provides compatibility with previous systems.
 - B Select this option to initialize the 580-line printer buffer image and format buffer image memories.

The console displays:

```
PRINTER CH = 12
```

3. Press the carriage return key to accept the default channel number, or enter desired printer channel number then press the carriage return key to select a different channel. The following line appears below the channel display.

```
PRINTER EQ = 5
```

4. Press the carriage return key to accept the equipment number for the line printer, or enter the equipment number for line printer, if different from the default value, then press the carriage return key.

If option A was selected initially, proceed to step 7.

If option B was selected initially, the following message appears.

```
1 = 596-1  
2 = 596-2  
3 = 596-3  
4 = 596-4  
5 = 596-5  
6 = 596-6  
TRAIN SELECT = 5
```

5. Press the carriage return key to select the default train selection shown on the last line, or enter the desired printer train number, if different from the default value, then press the carriage return key.

The following message appears (option B only).

```
SET FORMAT BUFFER Y OR N
```

```
Y = YES
```

```
N = NO
```

```
(DEFAULT = Y)
```

6. Press the carriage return key to accept the default selection, or enter the desired option, if different from default value, then press the carriage return key. If you select the Y option, the 580 print buffer and format buffer memories are initialized. If you select the N option, only the print buffer memory is initialized.
7. Enter the letter of a dump option then press the carriage return key. Depending on your selection, you may be prompted to enter additional parameters. If so, respond to prompt as follows.

NOTE

Do not select option A or B after selecting any other options. If you do, the screen goes blank and you must deadstart.

Prompt	Entry
PP NO=	Number of PP to be dumped. Enter the letter A then press the carriage return key to dump all PPs except logical PP0. (NXX = NIO PP XX, CXX = CIO PP XX) ³
PPU NO	Number of PPU to be dumped (CYBER 170 model 176 only). Enter the letter A then press the carriage return key if all PPUs are to be dumped.
START ADRS	Starting central memory address (1 through 10 octal digits, or 1 through 7 hexadecimal digits).
END ADRS	Last memory address to be dumped (from 1 to 10 octal digits for octal dump; from 1 to 7 hexadecimal digits for hexadecimal dump).
SELECT ADDRESS MODE	Enter H for hexadecimal address entry or B for byte address (octal) entry mode.
CPU= ⁴	Enter CPU number (options G, J, M, and N).

Press the carriage return key. The system executes the option you selected and displays dump options.

3. Displayed for I4 only.

4. This prompt is displayed only on systems with multiple CPUs when both are available.

8. Enter the letter of another option then press the carriage return key, or terminate the dump by redeadstarting system.
9. During the printer dump sequence, you may encounter an error informative message. Refer to appendix B for a directory of messages and responses.

Selecting an Alternate Deadstart Device (All Systems, Excluding I4Cn Class Systems)

Option S of the UTILITIES display allows you to specify an alternate tape unit or disk device for the deadstart operation. Entries made during this option override words 2, 4, 5, 6, 7, and 10 of the deadstart program. Refer to section 5 for a detailed description of the deadstart program parameters.

This procedure assumes you have deadstarted the system and have selected the UTILITIES display.

1. Enter S. The following display appears on left screen:

```
DEADSTART DEVICE TYPE - m
(1=66X, 2=63X/67X, 3=DISK)
```

2. m is the device type indicated on deadstart program (word 6).

Press the carriage return key to use this device, or specify an alternate device type by entering its type number (1, 2, or 3) then pressing the carriage return key. The following line appears.

```
CHANNEL - cc
```

3. cc is the channel indicated on the deadstart program (words 2, 4, 5, 7, and 10).

Press the carriage return key to use this channel, or specify an alternate channel by entering channel number then pressing the carriage return key. The following line appears.

```
EQUIPMENT - e
```

4. e is the equipment indicated on the deadstart program (word 6).

Press the carriage return key to use this equipment, or specify an alternate equipment by entering equipment number then pressing the carriage return key. The following line appears.

```
UNIT - uu
```

5. uu is unit number indicated on the deadstart program (word 6).

Press the carriage return key to use this unit, or enter the unit number then press the carriage return key to specify an alternate unit.

The system now deadstarts from the alternate device and the INITIAL OPTIONS display reappears.

Modifying Default Parameters

Option D allows the operator to define and change the default parameters used with the CTI routines. Following is the initial display for the A option.

DEFAULT PARAMETER PROCESSING.

EACH ENTRY WILL BE PROCESSED
WHEN A -CR- IS ENTERED.

SPECIAL KEY INPUTS

(+) - DISPLAY THE NEXT DEFAULT BLOCK.
(-) - DISPLAY THE PREVIOUS DEFAULT BLOCK.
BKSP - DELETE THE LAST CHARACTER.
CR - ENDS EACH ENTRY WRITES DEFAULTS TO DISK.

ALL ENTRIES ARE IN THE FORMAT:

XXXX

WHERE XXXX = 1 TO 10 ALPHA-
NUMERIC ENTRY DEFINING THE
PARAMETER TO BE PROCESSED.

(ENTER + TO CONTINUE.)

Enter a (+) character and follow it with a (CR). The first default block display appears.

DEADSTART TAPE DEFAULTS

ENTER TAPE TYPE.....01
(1 = 66X, 2 = 63X/67X)

Enter the proper tape type, if different from the displayed value, and follow it with a (CR). The display adds the following line.

ENTER CHANNEL NUMBER....13

Enter the proper channel number, if different from the displayed value, and follow it with a (CR). The display adds the following line.

ENTER EQUIPMENT NUMBER..00

Enter the proper equipment number, if different from the displayed value, and follow it with a (CR). The display adds the following line.

ENTER UNIT NUMBER.....00

Enter the proper unit number, if different from the displayed value, and follow it with a (CR). The display adds the following line.

ENTER + TO CONTINUE

A (+) character causes the following default block display to appear.

EDD TAPE DUMP DEFAULTS

ENTER TAPE TYPE.....01
(1 = 66X, 2 = 63X/67X)

Enter the proper tape type, if different from the displayed value, and follow it with a carriage return. The following line appears.

ENTER CHANNEL NUMBER....13

Enter the proper channel number, if different from the displayed value, and follow it with a carriage return. The following line appears.

ENTER EQUIPMENT NUMBER..00

Enter the proper equipment number, if different from the displayed value, and follow it with a carriage return. The following line appears.

ENTER UNIT NUMBER.....00

Enter the proper unit number, if different from the displayed value, and follow it with a carriage return. The following line appears.

ENTER + OR - TO CONTINUE

A (+) character causes the next default block display to appear.

SYSTEM DISK DEFAULTS

ENTER CHANNEL NUMBER....01

Enter the proper channel number, if different from the displayed value, and follow it with a (CR). The display adds the following line.

ENTER UNIT NUMBER..00

Enter the proper unit number, if different from the displayed value, and follow it with a (CR). The display adds the following line.

ENTER + OR - TO CONTINUE

A (+) character causes the next default block display to appear.

ALTERNATE SYSTEM
DISK DEFAULTS

ENTER CHANNEL NUMBER....01

Enter the proper channel number, if different from the displayed value, and follow it with a (CR). The display adds the following line.

ENTER UNIT NUMBER.....00

Enter the proper unit number, if different from the displayed value, and follow it with a (CR). The display adds the following line.

ENTER + OR - TO CONTINUE

A (+) character causes the next default block display to appear.

MSL-HVS DISK DEFAULTS

ENTER CHANNEL NUMBER....01

Enter the proper channel number, if different from the displayed value, and follow it with a (CR). The display adds the following line.

ENTER UNIT NUMBER.....00

Enter the proper unit number, if different from the displayed value, and follow it with a (CR). The display adds the following line.

ENTER + OR - TO CONTINUE

A (+) character causes the next default block display to appear.

LINE PRINTER DUMP DEFAULTS

ENTER CHANNEL NUMBER....12

Enter the proper channel number, if different from the displayed value, and follow it with a (CR). The display adds the following line.

ENTER EQUIPMENT NUMBER..07

Enter the proper equipment number, if different from the displayed value, and follow it with a (CR). The display adds the following lines.

ENTER TRAIN TYPE.....04

(1 = 596-1, 2 = 596-2)

(3 = 596-3, 4 = 596-4)

(5 = 596-5, 6 = 596-6)

Enter the proper train type, if different from the displayed value, and follow it with a (CR). The display adds the following lines.

FORMAT CONTROL MODE.....01

(1 = PROGRAMMABLE, 2 = FORMAT TAPE)

Enter the proper format control mode, if different from the displayed value, and follow it with a (CR).

Upon completion of the default parameter entry, the following message is displayed.

PARAMETER PROCESSING COMPLETE

ENTER (-), OR DEADSTART

Performing a Power-On Initialization (I1n, I2n, I4Cn, and All I4n Class Systems)

Use the following procedure to initialize an I1n, I2n, I4Cn, or any I4n Class system after applying power to the mainframe or after performing a maintenance action. This procedure first initializes the two port mux and then initializes the CPU.

1. Complete one of the following steps to initialize the TPM.
If your system console is not a CC598A or CC598B:
 - a. From the MAINTENANCE OPTIONS display (refer to section 2) enter I to initialize the two port mux.If your system console is a CC598A or CC598B:
 - a. Presuming your console has already been initialized, press CTRL-F2 to get the CONSOLE MAIN MENU display.
 - b. Enter M from the CONSOLE MAIN MENU to get the MAINTENANCE OPTIONS menu for dual IOU systems or to get the MAINTENANCE OPTIONS - IOU0 display for single IOU systems.
 - c. If you have a dual IOU system, enter 0 from the MAINTENANCE OPTIONS menu to get the MAINTENANCE OPTIONS - IOU-0 display.
 - d. From the MAINTENANCE OPTIONS - IOU-0 display, enter I to initialize the two port mux.
2. From the UTILITIES display (refer to section 2) Enter I to initialize the CPU. The INITIAL OPTIONS display appears with the following message at the bottom of the display.

ALL MAINFRAME MEMORIES WILL
BE INITIALIZED FOR MSL/OS LOADS

3. Enter one of the following.
(CR) To initialize the system (deadstart recovery level 0) and load the operating system. If the deadstart recovery level is 3, the following message appears.

LEVEL 3 RECOVERY NOT POSSIBLE

CENTRAL MEMORY INITIALIZATION
HAS BEEN SELECTED BY THE OPERATOR,
OR AUTOMATICALLY SET BY THE
HARDWARE.

DEADSTART AND SELECT A DIFFERENT
RECOVERY LEVEL, OR DO NOT SELECT
MAINFRAME INITIALIZATION.

Reset the deadstart program for a level 0 deadstart and initiate a deadstart.

NOTE

On I4 IOUs, bit 33 of the NIO EC register is defined as the "System Initialized" bit. This bit, when set, indicates the mainframe was initialized during a previous deadstart, and no unrecoverable errors were encountered. The bit is automatically cleared when power is applied to the system.

If the operator selects any OS load option on models 835 through 860, or model 990, and the IOU is an I4, CTI will check the state of the system initialized bit. If the bit is set, no further action is taken. If the bit is clear, CTI sets an internal flag indicating mainframe initialization is to be performed, then checks the deadstart recovery level. If the recovery level is 3, the above message is displayed, and the deadstart is aborted.

- M To initialize the system, including the alternate PP, and load off-line maintenance software.

The alternate PP will always be initialized on maintenance loads unless CTI is incapable of accessing the CPU. If CTI cannot access the CPU, the following message is displayed:

```
UNABLE TO ACCESS CPU VIA
THE MAINTENANCE CHANNEL
ENTER (CR) TO CONTINUE OR
DEADSTART AND INFORM CE
```

NOTE

On all I4n or I4Cn Class systems, CTI clears the system initialized bit in the NIO EC register when the operator selects the M option. If the operator selects an OS load on the next subsequent deadstart, CTI will force a mainframe initialization to be performed as described in the above NOTE. Under such conditions, a level 3 deadstart will be impossible.

4. If communication is lost with a PP during initialization, the following message is displayed.

```
PP xx NOT RESPONDING
DEADSTART ABORTED
```

Reinitiate deadstart, logically turn off the PP, and repeat the procedure.

Clearing ESM (Except I1n, I2n, I4Cn, and All I4n Class Systems)

The CLEAR ESM option (Z) on the UTILITIES display provides the capability to master clear the ESM control logic or to clear ESM.

NOTE

This option should be selected after any power interruption or maintenance activity.

The following procedure assumes you have deadstarted the system and have selected the UTILITIES display.

1. Enter Z. The console displays:

A - MASTER CLEAR CONTROL LOGIC

B - CLEAR ESM

2. Enter A to master clear ESM control logic.

- a. The console displays:

ESM ACCESS CHANNEL =

- b. Enter a one- or two-digit octal channel number then press the carriage return key. If an invalid number is entered, the console displays:

INVALID CHANNEL ENTRY
(CR) TO RETRY

Press the carriage return key and reenter the channel number.

- c. Entry of a valid number causes the next line to be added to the display.

ESM ACCESS EQUIPMENT =

Enter one octal digit then press the carriage return key. If the system is unable to access ESM using the specified channel and equipment, the console displays:

UNABLE TO ACCESS PORT
(CR) TO RETRY

Press the carriage return key and reenter the channel and equipment numbers to retry.

- d. When the system accesses the side door port, one of the following messages appears.

MASTER CLEAR COMPLETE
(CR) TO RETURN TO OPTION DISPLAY

or

STATUS BIT ERROR

The STATUS BIT ERROR message indicates that the system is detecting an error when the side door port is statused following the master clear. Press the DEADSTART switch to return to the INITIAL OPTIONS display. If the message reappears, contact a CE.

3. Enter B to clear ESM. The console displays the following warning message.

WARNING
RECOVERY DEADSTART IMPOSSIBLE
IF THIS PROCESS CONTINUES.
(CR) TO CONTINUE, OR (BS)
TO SELECT ANOTHER OPTION.

- a. Press the carriage return key. The console displays:

AVAILABLE ESM =

- b. Enter the amount of ESM available (from one to eight octal digits) then press the carriage return key.

The system clears the specified amount of ESM by writing different patterns of zeros and ones.

When the process is complete, the console displays:

ESM CLEAR COMPLETE
LAST ADDRESS CLEARED = xxxxxxxx
(CR) TO RETURN TO OPTION DISPLAY.

- c. If the system is unable to access the specified available ESM, the console displays:

ERROR - ADDRESS OUT OF RANGE
LAST ADDRESS CLEARED = xxxxxxxx
(CR) TO RETURN TO OPTION DISPLAY

Press the carriage return key to clear the ESM options display. Reselect option b and reenter the ESM available address.

4. Press the DEADSTART switch to return to the INITIAL OPTIONS display.

Loading and Installing Disk Subsystem Microcode from Tape

This procedure loads peripheral microcode to 834/836 disk adapters and control module memories, 7155 disk controllers, and 7165 CYBER Channel Couplers, and installs peripheral microcode onto specified 834, 836, 844, 885, or 895 disk drives. The procedure makes the following assumptions.

- The system has been deadstarted from a CIP tape.
- The tape containing peripheral microcode has been mounted on a tape unit. (The CIP tape and the tape containing peripheral microcode may be separate tapes, however, all peripheral microcodes to be installed must be on the same tape.)
- The UTILITIES display (option U of the INITIAL OPTIONS display) has been selected.
- Any 844, 885 or 895 disk on which peripheral microcode will be installed is mounted and/or ready to perform the necessary write functions. (For 895 drives, this requires that the area to receive peripheral microcode has been formatted to small sectors.)
- All channel, equipment and unit numbers entered are octal values.
- If installing to an 844-4X, it is connected to a 7155 type controller.

1. Enter M. The following display appears on the screen.

```
DISK SUBSYSTEM PERIPHERAL  
MICROCODE INSTALLATION UTILITY
```

```
ENTER DISK TYPE
```

```
A = 844-4X  
B = 885  
C = 895  
D = 834 (ISD-1)  
E = 836 (ISD-2)
```

2. Select the appropriate option for the disk on which peripheral microcode is to be installed. The screen is cleared and the following message appears.

```
DISK DRIVE LOCATION
```

```
CHANNEL - 00
```

3. Press carriage return key to accept channel 00, or enter an alternate channel then press the carriage return key. The display adds the following lines.

```
EQUIPMENT - 0
```

```
(BS) - BACKSPACE TO PREVIOUS ENTRY
```

4. Equipment number must be zero for all disk drives. Press the backspace key to change disk channel number, or press the carriage return key. The display adds the following line when carriage return is pressed.

UNIT - 00

5. For 834/836 disk drives, 00 is interpreted as cu, where c = control module number, and u = unit number. Press the carriage return key to accept control module 0, unit 0, or enter alternate values, then press the carriage return key. For 844 drives, unit number must be in the range 00 - 07. Press the carriage return key to accept unit 00, or enter an alternate unit number, then press the carriage return key. For 885 drives, unit number must be in the range 40 - 57. Enter a valid unit number, then press the carriage return key. For 895 disk drives, 00 is interpreted as su, where s = storage director number, and u = unit number. Press the carriage return key to accept storage director 0, unit 0, or enter alternate values, then press the carriage return key. After the carriage return key has been pressed, the screen is cleared and the following line appears.

ENTER TAPE TYPE - t

(1=66X, 2=63X/67X/698)

NOTE

The tape parameters displayed are initially defaulted to the CIP deadstart tape device. When entering these parameters, enter the values for the tape which contains peripheral microcode. If peripheral microcode is on the CIP tape, press the carriage return key for each parameter.

6. Press carriage return to accept t as shown, or enter an alternate tape type. The display adds the following line.

CHANNEL - cc

7. Press the carriage return key to accept cc as shown, or enter an alternate channel, then press the carriage return key. The display adds the following lines.

EQUIPMENT - e

(BS) - BACKSPACE TO PREVIOUS ENTRY

8. Press the backspace key to change the tape channel number. Press the carriage return to accept e as shown, or enter an alternate equipment number, then press carriage return. The display adds the following line.

UNIT - uu

9. Press the backspace key to change the tape equipment number. Press the carriage return key to accept uu as shown, or enter an alternate unit number, then press the carriage return.

The system now begins the peripheral microcode load/install process. Self-explanatory messages are presented during the process to inform the operator of the progress of the installation process.

10. When the process is complete, one of the following displays is presented on the screen, depending upon the disk type selected.

834	836	844/885	895
INSTALLED	INSTALLED	INSTALLED	INSTALLED
MA462-XX	MA462-XX	MA721-XX	MA464-XX
MH422-XX	MH424-XX		
MD422-XX	MD424-XX		

ENTER (CR) TO CONTINUE.

(XX is the revision number of the peripheral microcode(s) installed.

11. To load/install peripheral microcode to another device, press the carriage return key. The ENTER DISK TYPE display will appear on the screen. Repeat steps 2 through 5, and step 11 for each drive.

Operator Intervention Procedures

The procedures included here use options offered on the OPERATOR INTERVENTION display. The OPERATOR INTERVENTION display may be accessed only during a deadstart from disk operation.

Running Hardware Verification Sequence (HIVS) (All Systems, Excluding I4Cn Class Systems)

The hardware verification sequencer controls the execution of a set of go/no go tests of the peripheral processor subsystem (PPS), central memory (CM), and the central processor unit (CPU). The tests are taken from the MSL and run under control of the sequencer using the capabilities of the common maintenance software executive (CMSE). The tests executed depend on the model of machine being tested. Refer to the description of the HARDWARE VERIFICATION display for your model of computer system in part I of this manual for a list of tests. Appendix E includes a brief description of each HIVS test.

Use this procedure to initiate the hardware verification sequence (HIVS). This procedure assumes you have deadstarted the system and have selected the OPERATOR INTERVENTION display.

NOTE

To do a level 3 recovery deadstart after verifying the hardware, you must set the deadstart program for a level 3 recovery prior to deadstart.

1. Enter V to select HIVS. The HARDWARE VERIFICATION SEQUENCE display appears.

When a test is attempted on hardware that is turned OFF via CTI or is physically not present, the following messages appear.

```
NO PP AVAILABLE
NO CM AVAILABLE
NO CP AVAILABLE
NO EM AVAILABLE
```

HIVS displays following messages during testing sequence.

```
TESTING REG
TESTING PPS
TESTING CM
TESTING CPU xx
```

If the test sequence completes without detecting errors, HIVS displays:

```
TESTING COMPLETE-DEADSTART
```

2. If an error is detected, HIVS displays one of the following error messages.

```
ERROR PP xx
ERROR CM
ERROR CPU xx
ERROR REG
SCR ERROR yyyy (CY70, CY170 865/875 only)
```

xx indicates the PP or CPU in error.

Refer to appendix B for a directory of error messages and responses.

Resetting the Deadstart Parameters

The P option of the OPERATOR INTERVENTION display provides a display of the contents of the words 12, 13, and 14 of the deadstart program. Parameters entered using this display override the following deadstart program parameters.

- Deadstart level
- CMRDECK number (NOS), CMR number (NOS/BE), DCFILE Deck (NOS/VE)
- Deadstart program words 12 and 14

For a detailed description of deadstart program parameters refer to section 5.

Use this procedure to reset the deadstart program parameters. The procedure assumes you have deadstarted the system and have selected the OPERATOR INTERVENTION display.

1. Enter P. The console displays the DEADSTART PARAMETERS display.
2. Reset level of deadstart by entering:

I=x Value x is the deadstart level as follows:

Level	Use
0	Initial deadstart; it is used when recovery deadstart is impossible.
1	To resume normal processing following maintenance.
2	For system test only.
3	Following equipment malfunction.

3. Specify the CMRDECK (NOS), CMR (NOS/BE), or DCFILE Deck (NOS/VE) number by entering:

C=xx

The value xx can range from 0 to 77₈.

4. Specify whether or not the NOS system load is to halt and display CMRDECK by entering:

D=Y Display CMRDECK.

D=N Do not display CMRDECK.

Refer to section 5 for instructions on modifying the CMRDECK.

NOTE

Steps 5 and 6 are for maintenance operations only and do not affect operating system deadstart.

5. Reset value of deadstart program word 12 by entering:

W12=wxyf wxyf defines size of UEM, CM size, CPU type (refer to Setting Word 12 in section 5).

6. Reset value of deadstart program word 14 by entering:

W14=fff This field is currently reserved for future use by maintenance software or operating system.

7. Press the carriage return key to accept the deadstart program parameters shown and continue the deadstart sequence. Press the backspace key to accept parameters and return to OPERATOR INTERVENTION display.

Build Deadstart Disk Operations (All Systems, Excluding I4Cn Class Systems)

The procedures described next use one or more of the options offered on the BUILD DEADSTART DISK display and MANUAL OPERATIONS display. The BUILD DEADSTART DISK display may be accessed only during a deadstart from CIP tape operation.

NOTE

This procedure should be used only after an initial install has been performed.

Manually Replace Modules on the Deadstart Disk

Use the manual replacement procedure when you have modified the components of the CIP tape or when you need tests other than the predefined subset of tests.

Should the entire CIP require more disk space than is normally allocated in a shared-disk mode, you must edit the released binary tape or circumvent this limitation. Editing the CIP tape is the preferred method.

After you have edited the CIP binary tape, if necessary, perform the following steps to replace CIP components in a shared-disk mode.

NOTE

Omit steps 4, 7, 8, and 9 for mainframes other than model I1n and I2n class systems.

1. Ensure that the tape and disk controlware are present and functioning properly, and perform a system warmstart.
 - a. Mount the CIP tape without the write-enable ring and ready the unit.
 - b. Set the deadstart panel or program for a warmstart from tape. Refer to Warmstart Procedures Summary in section 5. After a successful warmstart, the INITIAL OPTIONS display appears.

2. Replace CTI module on deadstart disk.

- a. Press the carriage return key or enter B while displaying the INITIAL OPTIONS display. The BUILD DEADSTART DISK display appears.
- b. Enter M. The MANUAL OPERATIONS display appears.
- c. Enter C to install CTI. The following display appears.

```
ENTER ONE OF THE FOLLOWING
(CR) - INSTALL DEADSTART
      MODULE ON DISK
R    - RELEASE OF CTI-MSL/HIVS/OS
      RESERVED DISK SPACE
```

- d. Press the carriage return key. The system now requests channel, equipment, and unit numbers for the disk device. Enter channel, equipment, and unit number for device.
- e. Press the carriage return key. The following warning message appears.

WARNING

```
PERMANENT FILES WILL BE LOST IF CTI IS NOT
ALREADY INSTALLED ON THIS DEVICE
```

```
(CR) TO CONTINUE
```

- f. Press the carriage return key. The system now requests channel, equipment, and unit numbers of disk device.
The following message appears when CTI is loaded successfully.

```
INSTALL COMPLETE
(CR) TO PROCESS DIFFERENT DEVICE
```

- g. If your site has more than one system disk, press the carriage return key and repeat steps 2d through 2h for each disk (optional).
- h. Initiate deadstart to return to the INITIAL OPTIONS display. The version of CIP is indicated at the bottom of the display.

3. Replace CTI/MSL common disk area (CDA) modules.

- a. Press the carriage return key or enter B while displaying the INITIAL OPTIONS display. The BUILD DEADSTART DISK display appears.
- b. Enter M. The MANUAL OPERATIONS display appears.
- c. Select the D option. Then enter the disk and tape channel and unit numbers as prompted by the display.
If the disk unit selected for the CDA utility is reserved by another controller, the following message appears.

```
DISK UNIT RESERVED
```

Clear the reserved status of the disk unit to initiate automatic retry.

If the disk selected for the CDA utility is a fixed module drive whose READ ONLY switch is set, the following message appears:

READ ONLY SELECTED.

Turn off the READ ONLY switch and press the carriage return key to initiate automatic retry.

4. Replace microcode on deadstart disk.
 - a. Enter B while displaying the REPLACE CTI/MSL DISK AREA MODULE display.
 - b. The REPLACE CTI/MSL DISK AREA MODULE display appears when modules have been replaced.
5. Replace default parameter deck on deadstart disk from CIP tape.
 - a. Enter A while displaying the REPLACE CTI/MSL DISK AREA MODULE display.
 - b. The REPLACE CTI/MSL DISK AREA MODULE display appears when modules have been replaced.
6. Replace EI on CTI/MSL disk area.
 - a. Enter C while displaying the REPLACE CTI/MSL DISK AREA MODULE display.
 - b. The REPLACE CTI/MSL DISK AREA MODULE display appears when installation is complete.
7. Replace CC634B SCD on the disk.
 - a. Enter D while displaying the REPLACE CTI/MSL DISK AREA MODULE display.
 - b. The REPLACE CTI/MSL DISK AREA MODULE display appears when installation is complete.
8. Replace MDD on the disk.
 - a. Enter E while displaying the REPLACE CTI/MSL DISK AREA MODULE display.
 - b. The REPLACE CTI/MSL DISK AREA MODULE display appears when installation is complete.
9. Replace DFT module on the disk.
 - a. Enter F while displaying the REPLACE CTI/MSL DISK AREA MODULE display.
 - b. The REPLACE CTI/MSL DISK AREA MODULE display appears when installation is complete.

10. Replace SCI

- a. Enter it while displaying REPLACE CTI/MSL DISK AREA MODULE display.
- b. The CAU initial options display appears when installation is complete.

11. Replace MSL module to disk.

- a. Press the carriage return key or enter B while displaying the INITIAL OPTIONS display. The BUILD DEADSTART DISK display appears.
- b. Enter M. The MANUAL OPERATIONS display appears.
- c. Enter T. The console displays:

```
      TDX
DISK AND TAPE TRANSFER UTILITY
CR TO CONTINUE
```

- d. Press the carriage return key then enter TDX parameters as prompted. The TDX option display appears upon completion of these entries.
- e. Enter A to build MSL from tape.
- f. Enter F to select MSL/OS Shared Disk mode. Programs are installed at the predefined area of the disk.

The following message appears.

```
SAVE COMMAND BUFFER AREA
Y = YES  N = NO
```

- g. Enter N in response to the above message (you do not have to press the carriage return key). TDX initializes the PNT and SRT and presents the following display.

```
COPY FROM
-CR- = 1ST NAME
```

- h. Press the carriage return key to cause TDX to begin copying with the first program it encounters. When the COPY FROM selection is complete, TDX presents the following display.

```
COPY THRU
-CR- = LAST NAME
```

- i. Press the carriage return key to instruct TDX to copy to the last program on the tape. For tape-to-disk copies, TDX has the ability to verify data written to disk. TDX presents the following display.

```
DATA VERIFY (Y/N)
```

- j. Enter Y. TDX transfers each program to the disk, displaying the name of each program as it is copied to the disk. TDX skips over any command buffers located on the tape. Upon completion of the copy operation, TDX displays the first cylinder, track, and sector used for the copy. Press the space bar to display the last available cylinder for the complete MSL build.

NOTE

If the SRT FULL message appears instead, the edited MSL is too large for the predefined disk area. You must either obtain permission to use more of the disk and install in maintenance only mode, or use an alternate tape editing method and install a partial MSL. In either case, you cannot continue from this point without deadstarting.

- k. Press the space bar to clear the display and display a reduced set of TDX options.
12. Install command buffers to disk.
 - a. Enter B when the TDX options display is present. TDX presents the following display.

```
COPY FROM  
-CR- = 1ST NAME
```

- b. Press the carriage return key to cause TDX to begin copying with the first command buffer it encounters. TDX then presents the following display.

```
COPY THRU  
-CR- = LAST NAME
```

- c. Press the carriage return key to instruct TDX to copy to the last command buffer on the tape. For tape-to-disk copies, TDX has the ability to verify data written to disk. TDX presents the following display.

```
DATA VERIFY (Y/N)
```

- d. Enter Y. TDX transfers each command buffer to the disk, displaying the name of each command buffer as it is copied to the disk. Upon completion of the copy operation, TDX displays the last cylinder, track, and sector used for the copy.
- e. Press the space bar to clear the message and display a reduced set of TDX options.
13. The system is now ready to install the operating system.

Install-Update CIP System Console Utility (IUC)

The install-update CIP (IUC) system console utility is a PP utility which installs or updates contents of the CIP tape onto the the I4Cn Class system CIP device. IUC interfaces to the I4Cn Class system CIP device (contained within the CC598A console) via the Small Computer Standard Interface (SCSI) channel.

IUC consists of:

- A disk driver which executes in PP1
- A tape driver which executes in PP0

IUC uses four directories (CTI, CDA, MSL, CB) on the system console hard disk for storage of CIP tape components. IUC can install or update components in the four disk directories. In addition, IUC can perform the following operations:

- Initial installation:
 - Installs CTI components on the CTI directory.
 - Installs CDA components on the CDA directory.
 - Installs MSL components on the MSL directory.
 - Installs command buffers on the CB directory.
- Update installation:
 - Installs the entire contents of the CIP tape onto the CIP device, excluding programs in the CDA directory which must be carried over when performing an update operation.
- Manual installation:
 - Replacement of the MSL directory contents.
 - Replacement of the CTI directory contents.
 - Replacement of the CB directory contents.
 - Addition or replacement of programs in the CDA directory.
 - Addition or replacement of programs in the MSL directory.
 - Addition or replacement of programs in the CB directory.
 - Manual addition or replacement of programs in the CDA directory.
 - Manual installation of VE boot programs in the CDA directory.
 - Copying MSL programs to tape.
 - Copying command buffers to tape.

IUC Parameter Entries

All parameter entries are terminated by a carriage return; the backspace key permits change of the previous entry. Selecting option I from the CC598A MAINTENANCE OPTIONS menu will prompt the following message to be displayed:

INSTALL/UPDATE CIP

CIP Partition n is currently selected.

The option to install/update CIP has been selected.
This utility requires dedicated access to the mainframe.

Current system activity will be terminated by proceeding with this option.

Enter: LOAD UTILITY
Esc: RETURN TO MAINTENANCE OPTIONS DISPLAY.

If the CIP partition must be changed, press the ESC key to bring up the MAINTENANCE OPTIONS menu, and then select S to bring up the SELECT CIP PARTITION display. From the SELECT CIP PARTITION display, change the CIP partition and then press ESC again to return to the MAINTENANCE OPTIONS menu.

If the desired CIP partition is selected, press the Enter key; the TAPE SYSTEM INFORMATION message will appear:

TAPE SYSTEM INFORMATION 01

(01=ATS, 02=IPI)

If your tape system type differs from the default value as shown in the initial display, enter the proper tape type. The following line is then added:

CHANNEL 04

If the channel displayed is not the desired channel, enter the proper tape channel (4-6). The tape equipment default number will then appear:

EQUIPMENT 00

Enter the proper tape equipment number, if different from the default value. The tape unit default number then appears:

UNIT 00

Enter the proper tape unit number, if different from the default value. If your tape subsystem is an IPI system, the following line is then added:

PORT(0=A, 1=B) 00

If the port displayed is not correct, enter the proper port (0 or 1). When all proper values are successfully entered, IUC then proceeds to the CIP INSTALLATION display. If an illegal parameter is entered in response to either the CHANNEL, EQUIPMENT, or TAPE UNIT prompt, IUC displays the message:

ILLEGAL ENTRY

Depressing the space bar then allows the parameter to be re-entered.

After tape parameters are entered, IUC attempts to connect to the tape drive. If connection to the unit is unsuccessful, IUC displays the message:

TAPE UNIT NOT CONNECTED

Entry of a space bar prompts IUC to re-attempt the tape drive connection.

CIP Installation Display

Following is the options display presented by IUC:

CIP INSTALLATION

I INITIAL INSTALLATION
 U UPDATE INSTALLATION
 M MANUAL INSTALLATION
 H HELP

To execute a CIP INSTALLATION option, enter either I, U, or M.

I - INITIAL INSTALLATION

The INITIAL INSTALLATION option installs the entire contents of the CIP tape onto the CIP device. When this option is selected, the previous contents of all four directories are destroyed and the names of the programs/command buffers being installed are displayed as they are loaded. No further displays are presented which require operator intervention. Upon completion, the following message is displayed:

INSTALLATION COMPLETE
 CTRL-F2 REQUIRED

OS BOOTS MUST BE MANUALLY INSTALLED

U - UPDATE INSTALLATION

The UPDATE INSTALLATION option installs the entire contents of the CIP tape onto the CIP device, excluding those programs in the CDA directory which must be carried over when performing an update operation. With the exception of the CDA directory, the contents of all directories are destroyed and the names of the programs/command buffers being installed are displayed as they are loaded onto the CIP device. There are no further displays presented which require operator intervention. Upon completion, the following message is displayed:

INSTALLATION COMPLETE
 CTRL-F2 REQUIRED

M - MANUAL INSTALLATION

The MANUAL INSTALLATION option allows IUC to perform manual operations involving each of the four system console disk directories. The following display is presented:

MANUAL OPERATIONS

C REPLACE CTI
 T REPLACE MSL
 D REPLACE COMMON DISK AREA

(CR) INSTALL CTI
 (BS) PREVIOUS DISPLAY

To execute a MANUAL OPERATIONS option, enter either C, T, or D.

Manual Operations Display

This subsection describes the options available in the MANUAL OPERATIONS menu.

C - REPLACE CTI

The REPLACE CTI option installs the entire contents of the mounted tape into the CTI directory of the CIP device. All previous contents within the CTI directory are destroyed and the names of the newly installed programs are displayed as they are loaded onto the CIP device. No further intervention is required. Upon completion, the following message is displayed:

INSTALLATION COMPLETE
CTRL-F2 REQUIRED

OS BOOTS MUST BE MANUALLY INSTALLED

T - REPLACE MSL

The REPLACE MSL option allows IUC to enter data into the MSL directory of the CIP device and to transfer programs from tape to the CIP device. Selecting this option prompts the following display:

A - BUILD MSL ON DISK FROM TAPE
B - BUILD COMMAND BUFFER LIBRARY
C - ADD PROGRAMS TO DISK
D - ADD COMMAND BUFFERS TO DISK
E - COPY PROGRAMS TO TAPE
F - COPY COMMAND BUFFERS TO TAPE

(CR) INSTALL MSL

To execute a REPLACE MSL option, enter the letter of the desired option. Refer to table 6-2 for a description of the REPLACE MSL options.

Table 6-2. Replace MSL Options

Option	Description
A	<p>The BUILD MSL ON DISK FROM TAPE option prompts IUC to transfer MSL files/programs to the MSL directory of the CIP device. IUC will delete all files/programs currently residing in the MSL directory before copying all MSL programs on the CIP tape, between marker records ZZ4 and ZZ5, to the CIP device.</p> <p>During execution of file transfers, IUC copies only valid programs while it skips over any command buffers located on the tape. The name of each program is displayed as the program is copied to CIP device.</p> <p>Upon completion of the BUILD MSL ON DISK FROM TAPE operation, IUC displays a reduced set of copy options that may be performed without a deadstart.</p>

(Continued)

Table 6-2. Replace MSL Options *(Continued)*

Option	Description
B	<p>The BUILD COMMAND BUFFER LIBRARY option prompts IUC to transfer MSL files/command buffers to the CB directory of the CIP device. IUC allows you to specify the first and last command buffers to be transferred from tape; however, IUC will delete all files/command buffers within the CB directory before displaying:</p> <pre data-bbox="662 478 862 531"> COPY FROM -CR- = 1ST NAME </pre> <p>Enter only a (CR) to begin copying the first command buffer IUC encounters. Otherwise, specify the name of the first command buffer to be copied onto the CIP device. As characters for the command buffer name are entered, they appear on the display to the right of COPY FROM. Since command buffer names are limited to seven characters, any attempt to enter more than seven characters results in the additional characters successively replacing the seventh character of the name.</p> <p>After your response to the COPY FROM message, IUC displays:</p> <pre data-bbox="678 905 889 957"> COPY THRU -CR- = LAST NAME </pre> <p>You may enter either a (CR), which instructs IUC to copy files up to the last command buffer on tape, or you may enter the name of the final program to be copied (up to seven characters).</p> <p>IUC copies programs from tape to the CIP device as directed by the user; if CTI resides on the tape being used, the programs copied will also include CTI.</p> <p>During file transfers, IUC copies only valid command buffers while it skips over any programs located on the tape. The name of each command buffer is displayed as the program is copied to the CIP device.</p> <p>Upon completion of the BUILD COMMAND BUFFER LIBRARY operation, IUC displays a reduced set of copy options that may be performed without a deadstart.</p>

(Continued)

Table 6-2. Replace MSL Options (Continued)

Option	Description
C	<p>The ADD PROGRAMS TO DISK option enables you to add programs to the MSL directory on the CIP device. Since duplicate program names are not allowed within a single directory of the CIP device, IUC will give you the following option:</p> <pre data-bbox="609 441 1096 567"> REPLACE DUPLICATE NAMES (Y/N) WARNING - IF REPLACEMENT IS NOT SELECTED, DUPLICATES WILL BE SKIPPED AND NOT WRITTEN TO THE DISK. </pre> <p>If a Y is entered, then for each program transferred from tape, IUC searches the CIP device for an existing program with the same name, it deletes any existing program of the same name, and copies the new program to CIP device.</p> <p>If N is entered, IUC adds to the CIP device only those programs that do not already reside on CIP device. All other programs are skipped over.</p> <p>IUC enables you to specify the first and last programs to be transferred from tape. After answering Y or N in response to the REPLACE DUPLICATE NAMES prompt, IUC presents the following display:</p> <pre data-bbox="755 955 966 1018"> COPY FROM -CR- = 1ST NAME </pre> <p>Enter only a (CR) to begin copying the first program IUC encounters. Otherwise, enter the name of the first program to be copied onto the CIP device. As the characters are entered, they appear on the display to the right of COPY FROM. Since program names are limited to seven characters, any attempt to enter more than seven characters results in the additional characters successively replacing the seventh character of the name.</p> <p>After you respond to the COPY FROM message, IUC displays:</p> <pre data-bbox="771 1354 998 1407"> COPY THRU -CR- = LAST NAME </pre> <p>You may either enter a (CR), which instructs IUC to copy files up to the last program on tape, or you may enter the name of the final program to be copied (up to seven characters). IUC then executes the operation as specified by the REPLACE DUPLICATE NAMES (Y/N) parameter.</p> <p>Each program name is displayed as it is transferred to the CIP device. After completing the ADD PROGRAMS TO DISK operation, IUC displays a reduced set of copy options that may be performed without a deadstart.</p>

(Continued)

Table 6-2. Replace MSL Options *(Continued)*

Option	Description
D	<p>The ADD COMMAND BUFFERS TO DISK option enables you to add command buffers to the MSL directory on the CIP device. Since duplicate command buffer names are not allowed within a single directory of the CIP device, IUC will give you the following option:</p> <pre data-bbox="542 443 1021 562"> REPLACE DUPLICATE NAMES (Y/N) WARNING - IF REPLACEMENT IS NOT SELECTED, DUPLICATES WILL BE SKIPPED AND NOT WRITTEN TO THE DISK. </pre> <p>If a Y is entered, then for each command buffer transferred from tape, IUC searches the CIP device for an existing command buffer with the same name, it deletes any existing command buffer of the same name, and copies the new command buffer to the CIP device</p> <p>If N is entered, IUC adds to the CIP device only those command buffers that do not already reside on the CIP device. All other command buffers are skipped over.</p> <p>IUC also enables you to specify the first and last command buffers to be transferred from tape. After answering Y or N in response to the REPLACE DUPLICATE NAMES prompt, IUC presents the following display:</p> <pre data-bbox="688 989 888 1041"> COPY FROM -CR- = 1ST NAME </pre> <p>Enter only a (CR) to begin copying the first command buffer IUC encounters. Otherwise, enter the name of the first command buffer to be copied onto the CIP device. As the characters are entered, they appear on the display to the right of COPY FROM. Since command buffer names are limited to seven characters, any attempt to enter more than seven characters results in the additional characters successively replacing the seventh character of the name.</p> <p>After you respond to the COPY FROM message, IUC displays:</p> <pre data-bbox="699 1379 914 1432"> COPY THRU -CR- = LAST NAME </pre> <p>You may either enter a (CR), which instructs IUC to copy files up to the last command buffer on tape, or you may enter the name of the final command buffer to be copied (up to seven characters). IUC then executes the operation as specified by the REPLACE DUPLICATE NAMES (Y/N) parameter.</p> <p>Each command buffer name is displayed as it is transferred to the CIP device. After completing the ADD COMMAND BUFFERS TO DISK operation, IUC displays a reduced set of copy options that may be performed without a deadstart.</p>

(Continued)

Table 6-2. Replace MSL Options (Continued)

Option	Description
E	<p>The COPY PROGRAMS TO TAPE option allows IUC to copy programs from the CIP device to tape. After selecting this option, IUC will present the following display:</p>
	<pre>COPY FROM -CR- = 1ST NAME</pre>
	<p>Reply to this query by entering the name of the of the first program to be copied and then press the Enter/Return key. As you enter the characters, they will appear on the display to the right of COPY FROM. Names are limited to seven characters. Any attempt to enter more than seven characters results in the additional characters successively replacing the seventh character in the name. Simply pressing the Enter/Return key will prompt IUC to begin searching the CIP device for a blank program name. Thus, the first name <i>must</i> be specified.</p>
	<p>NOTE</p>
	<p>For disk-to-tape operation, disk programs are read in the order of which they were written to disk.</p>
	<p>After a response is entered for the COPY FROM message, IUC will present the following display:</p>
	<pre>COPY THRU -CR- = LAST NAME</pre>
	<p>You may either press the Enter/Return key, which instructs IUC to copy through the last file in the directory, or you may enter the name of the final program to be copied (seven characters or less) and then press the Enter/Return key.</p>
	<p>IUC allows you to either create a new tape of MSL programs or to add programs to an existing tape. IUC presents the following display:</p>
	<pre>VALID DATA ON TAPE (Y/N)</pre>
	<p>Enter a Y or N character without pressing the Enter/Return key. If Y is entered, IUC searches the tape for a tapemark or for a filemark which signals the end of valid data on tape. IUC will then backspace over the filemark and prepare to write the first block of new data.</p>
	<p>If N is entered, IUC returns to the beginning of the tape, where it will prepares to write the first block of new data. Data previously written on the tape is destroyed.</p>
	<p>Following a response to VALID DATA ON TAPE, IUC executes the operation. The name of each program copied to tape is displayed while the copy is in progress. Upon completion of the operation, IUC displays a reduced set of copy options that may be performed without a deadstart.</p>

(Continued)

Table 6-2. Replace MSL Options (Continued)

Option	Description
F	<p>The COPY COMMAND BUFFERS TO TAPE option allows IUC to copy command buffers from the CIP device to tape. Following selection of this option, IUC allows you to specify the first and last command buffers to be transferred to tape by presenting the following display:</p>
	<pre>COPY FROM -CR- = 1ST NAME</pre>
	<p>You must reply to this query by entering the name of the first command buffer to be copied and then press the Enter/Return key. As the characters are entered, they appear on the display to the right of COPY FROM. Names are limited to seven characters. Any attempt to enter more than seven characters will result in the additional characters successively replacing the seventh character in the name. Simply pressing the Enter/Return key will prompt IUC to begin searching the CIP device for a blank command buffer name. Thus, the first name <i>must</i> be entered.</p>
	<p>NOTE</p>
	<p>For disk-to-tape operations, disk command buffers are read in the order of which they were written to disk.</p>
	<p>After a response has been entered for the COPY FROM message, IUC presents the following display:</p>
	<pre>COPY THRU -CR- = LAST NAME</pre>
	<p>You may either press the Enter/Return key, which instructs IUC to copy through the last command buffer in the directory, or you may enter the name of the final command buffer to be copied (seven characters or less) and then press the Enter/Return key.</p>
	<p>IUC allows you to either create a new tape of command buffers or to add command buffers to an existing tape. IUC presents the following message:</p>
	<pre>VALID DATA ON TAPE (Y/N)</pre>
	<p>Enter a Y or N character without pressing the Enter/Return key. If Y is entered, IUC searches the tape for a tapemark or for a filemark which signals the end of valid data on tape. IUC will then backspace over the filemark and prepare to write the first block of new data.</p>
	<p>If N is entered, IUC returns to the beginning of the tape, where it will prepare to write the first block of new data. Data previously written on the tape is destroyed.</p>
	<p>Following a response to VALID DATA ON TAPE, IUC executes the operation. The name of each command buffer copied to tape is displayed while the copy is in progress. Upon completion of the operation, IUC displays a reduced set of copy options that may be performed without a deadstart.</p>

D - REPLACE COMMON DISK AREA

The REPLACE COMMON DISK AREA option enables you to add or replace programs in the CDA directory of the CIP device (this option is also capable of initializing the CDA). Upon selection of this option, the following display is presented:

REPLACE COMMON DISK AREA MODULES

A - DEFAULT PARAMETER BLOCK
 B - MICROCODE
 C - ENVIRONMENTAL INTERFACE
 F - FAULT TOLERANCE MODULE (DFT)
 G - OS BOOTS
 H - SYSTEM CONSOLE INTERFACE
 Z - INITIALIZE COMMON DISK AREA

(BS) PREVIOUS DISPLAY

To execute an option, enter the letter of the desired option. Refer to table 6-3 for a description of the REPLACE COMMON DISK AREA options.

Table 6-3. Replace CDA Module Options

Option	Description
A	The DEFAULT PARAMETER BLOCK option adds or replaces an existing copy of the program DPB in the CDA disk directory. DPB is read from the currently assigned tape.
B	The MICROCODE option adds or replaces the existing copies of the peripheral and product set microcode in the CDA directory; microcode in the MSL directory is not replaced. The microcode added or replaced in the CDA directory exists between records ZZ2 and ZZ4 of the currently assigned tape. During the file transfers, names of the microcode being installed are displayed.
C,F	Either of these options adds or replaces the existing copy of a program within the CDA directory of the CIP device. The required program is read from the currently assigned tape.
G	The OS BOOTS option adds or replaces existing copies of the VE boot programs within the CDA directory. The boots may be loaded from either the OS deadstart tape or from the CIP tape; you will be queried to specify which tape is to be read. During the file transfer, names of the programs being installed are displayed.
H	The SYSTEM CONSOLE INTERFACE option adds or replaces the existing copy of SCI within the CDA directory of the CIP device.

(Continued)

Table 6-3. Replace CDA Module Options *(Continued)*

Option	Description
Z	The INITIALIZE COMMON DISK AREA option initializes the CDA directory. All previous programs in the directory are destroyed and the directory is rebuilt exactly as during an initial build. VE boots are not installed. All information on the assigned CIP tape between records ZZ1 and ZZ4, plus DPB are written to the disk. During file transfers, the names of the programs being installed are displayed.

Upon completion of any IUC task within table 6-3, the REPLACE CDA menu will again be displayed. This feature permits multiple CDA changes without having to press Ctrl and F2 simultaneously and return to the CONSOLE MAIN MENU display.

Special Keys and Descriptive Messages Utilized by IUC

Discussed in this section are the following:

- Special keys.
- Informative messages.
- Error messages.

Special Keys

Table 6-4 describes the special keys recognized by IUC during normal execution.

Table 6-4. IUC Special Keys

Character	Description
BACKSPACE	BACKSPACE may only be used to re-enter a character in entries that end with a carriage return. BACKSPACE is not recognized by entries requiring a single character.
SPACE BAR	SPACE BAR may be used to resume IUC execution following a halt for error display, information display, or user-requested halt.
S	The S key may be used to halt IUC during the transfer of programs or command buffers. IUC halts following the transfer of the current program. If IUC is resumed, it resumes at the point where it was halted. This key is not enabled for operations dealing with either the CDA or CTI directories.
R	The R key may be used to restart IUC during the transfer of programs or command buffers. IUC finishes the current transfer and proceeds to the appropriate end-of-copy display. This special key can only be utilized when in the MSL or CB directories of the CIP device.
Ctrl-F2	Simultaneously pressing the Ctrl and F2 keys returns you to the CONSOLE MAIN MENU display. If pressing Ctrl and F2 simultaneously fails, simultaneously press the Ctrl, Alt, and Del keys to reinitialize the system console (the CONSOLE MAIN MENU will also appear when the console is initialized).

WARNING

Pressing Ctrl and F2 simultaneously during execution of IUC can result in an error as a file might be left open. If IUC is presently running and if it must be halted, terminate its execution with an S, followed by a carriage return. Thereafter, Ctrl-F2 may be entered.

Informative Messages

Table 6-5 describes the informative messages presented by IUC during normal execution.

Table 6-5. IUC Informative Messages

Message	Description
INITIALIZING CIP DEVICE	IUC is clearing the selected CIP device directory prior to installing programs or command buffers on the disk.
xxxxxx HALTED	An S key has been entered, which in turn has halted execution of IUC. The xxxxxx in this message is the name of the last program or command buffer copied by IUC. Entering a space bar clears this message and causes IUC to resume execution at the point where it was halted.
INSTALLATION COMPLETE	IUC has completed the latest CIP tape installation.
CTRL-F2 REQUIRED	The Ctrl and F2 keys must be simultaneously depressed: the CONSOLE MAIN MENU appears.
OS BOOTS MUST BE MANUALLY INSTALLED	As a result of the last install, the VE boots are no longer on the CIP device.
ILLEGAL ENTRY	The user made an illegal entry during parameter entry. Press the space bar to return to the parameter display and then re-enter the parameter.

Error Messages

Table 6-6 describes error messages presented by IUC.

Table 6-6. IUC Error Messages

Error Message	Description
xxxxxx NOT FOUND	IUC has not been able to locate the program or command buffer xxxxxx for which it has been searching. In the case of a tape-to-CIP device copy, the IUC search may be initiated whenever the name of the desired program is known or by a COPY FROM request. Entering a space bar returns IUC to the copy message which contains the unknown name.
xxxxxx TAPE ERR STAT YYYY	The status received from the tape drive reveals an error condition. The xxxxxx in this message is the name of the program or command buffer that IUC was working with when the error occurred; YYYY is the octal status word. Entering a space bar prompts IUC to proceed with the operation, although the result may not be reliable.
xxxxxx TAPE UNIT NOT READY	The tape drive is not sending a ready status. The xxxxxx is the name of the program or command buffer that IUC was working with. Correct the not ready condition without moving the tape and press the space bar to continue.
xxxxxx NAME TOO LONG	IUC has detected a program or command buffer name on tape that contains more than seven characters. The xxxxxx in the message is the first seven characters of the detected name. Entering a space bar will prompt IUC to skip to the next program or command buffer and continue with the next operation.
xxxxxx COMMAND TOO LONG	During a tape-to-CIP device copy, IUC has encountered a command to be placed on disk that is greater than 60 (decimal) characters long. The xxxxxx in the message is the name of the program or command buffer where the faulty command was found. Entering a space bar prompts IUC to truncate the command to 60 (decimal) characters and continue the operation.
xxxxxx COPY ERROR	During a copy operation, the program or command buffer xxxxxx could not be copied successfully. Entry of a space bar allows IUC to skip to the next program or command buffer and resume copying.

(Continued)

Table 6-6. IUC Error Messages (Continued)

Error Message	Description
xxxxxx INTER-PP DATA TRANSFER ERROR	The tape or disk driver is unable to output or input the expected number of words to or from the other driver. The xxxxxx is the name of the current program or command buffer. A deadstart is required to clear the condition. This message will appear if an OS deadstart tape is mounted when a CIP tape is to be used.
xxxxxx SCSI ERR STATUS=YYYY.TASK=ZZZZ MMMM	An error occurred when a program from tape could not be written successfully to the CIP device. The xxxxxx in the message is the name of the program which was being written (copied) to disk, YYYY is the SCSI general status, and ZZZZ is the SCSI task being attempted. The remaining portion of the message (MMMM) may be one of two messages: Ctrl-F2 REQUIRED or SPACE - SKIP TO NEXT PROGRAM. The first message indicates that the error is fatal and that a Ctrl-F2 is required. In the second instance, pressing the space key will prompt IUC to skip the program which is currently being transferred and to attempt to transfer the next program.
ASSIGNED TAPE IS EITHER NOT CIP OR UN-HEXIFIED	During either an INITIAL or an UPDATE operation, the first program read from tape was not the IPL program. Therefore, the tape is not a CIP tape or the tape was not properly hexified when built.
VE BOOTS NOT ON ASSIGNED TAPE	The currently assigned tape, which could either be a CIP tape or an OS deadstart tape, was supposed to contain VE boots. Restart the program to clear the error.
UNABLE TO DETERMINE THE MACHINE TYPE ENTER 1 FOR 962, 2 FOR 992	Following a request to install the DFT modules, an attempt was made to determine the machine type by reading the maintenance register. However, as a hardware problem prevented the maintenance register read from happening, you must enter either a 1 (if your computer system is a CYBER 962) or 2 (if your computer system is a CYBER 992).

Monitor Display Driver (MDD)

7

MDD Terminal Control	7-1
Command Syntax	7-1
MDD Initialization	7-2
CHANGE_MDD_OPERATING_MODE Command	7-3
Conventions	7-3
Central Memory Display Commands	7-4
Display Bytes	7-4
Display CM	7-4
Display Hexadecimal CM	7-5
Display Virtual Memory	7-5
Display Next Central Memory Block	7-7
Display Previous Central Memory Block	7-7
Central Memory Change Commands	7-8
Enter Bytes into Memory	7-8
Enter Central Memory	7-8
Maintenance Register Display Commands	7-9
Display Maintenance Registers	7-9
Enter New Maintenance Register Value	7-10
Clear Errors on Maintenance Element	7-10
Master Clear a Maintenance Element	7-11
Interpret MCR Bit Settings	7-11
Interpret UCR Bit Settings	7-11
Display PP Register Values	7-12
Idle PP	7-12
Restart PP at Specified Address	7-13
Halt Processor	7-13
Start Processor	7-14
Set CPU Value	7-14
Display the Register File for a Processor	7-14
DFT Commands	7-15
Display DFT Block	7-15
Set DFT Flag	7-16
Control Store Commands	7-17
Display Eight-Byte Control Store	7-17
Display Sixteen-Byte Control Store	7-18
Enter Eight-Byte Control Store	7-19
Enter Sixteen-Byte Control Store	7-20
Miscellaneous Commands	7-21
Return MDD PP to the Operating System	7-21
Set Refresh Mode	7-21
Set Refresh Rate	7-22
Display MDDs Commands	7-22
ESC Key	7-22
Other Messages to the Terminal	7-23

Error Log/Dayfile Messages	7-25
Examples of MDD Command Usage	7-26
Registers Displayed by MDD	7-31

MDD is a PP program that utilizes the Two Port Multiplexer (TPM) on the CDC CYBER I1n, I2n, I4Cn, and all I4n Class systems (excluding models 865 and 875) to provide a window to the hardware status. This program is built to run on the NOS, NOS/BE, or NOS/VE operating system. Once initiated, MDD detaches itself from the operating system until directed via the MDD console to terminate. MDD is not dependent on an operating system and should function if the operating system malfunctions due to hardware or software problems. As of the CIP level 9 release, MDD is contained in SCI (combined VPB, SCD and MDD). If SCI is already executing in a PP when MDD is initiated, MDD mode is turned on for that copy of SCI. A new copy is not loaded. This means that one copy of SCI services both MDD and the CC634B and CC598A/B consoles. If NOS/VE is executing in a dual state environment when MDD is initiated, then MDD must be initiated from the NOS/VE console.

MDD Terminal Control

MDD is designed to allow sharing of the communications port (and any terminal connected to it). On a CDC 721 terminal, if the user presses the F7 key, MDD releases the port (and thereby the terminal) if another driver wishes to use the port. If no other driver has signaled a request for the port, MDD responds with a beep. If a terminal other than a CDC 721 is used, the operator should enter an RS (Record Separator = 1E hexadecimal) and a lower case w.

On the CYBER 930 there is only a subset of the MDD command set available. Refer to command summary to identify which commands are not available denoted with an asterisk.

Command Syntax

MDD receives commands from the MDD console to:

- Display or change central memory (60 or 64 bit)
- Display, interpret, or change the contents of registers
- Display or change control store (64 or 128 bit)
- Display the DFT block or buffers
- Set flags to control DFT processing
- Stop or start PPs
- Stop or start a CPU

Using any of the display commands should have no effect on an operating system. Most MDD commands allow position dependent parameters, keywords, or a combination of both. This means that for the command whose syntax is:

DR element RN=register_number RC=repeat_count

where element can be one of the keywords i, m, or p, all of the following do the same thing.

DR i RN=30 RC=9
DR i 30 9
DR i RN=30 9

The delimiter between parameters in MDD commands can be either a space or a comma. Parameters can be positioned with multiple commas. All of the examples below are correct.

DB MA=0,WC=10
DB,,WC=10
DB 0 10
DB,,10

MDD Initialization

MDD can be initiated on either Port 1 or Port 0 of the Two Port Mux. MDD waits indefinitely for the Carrier ON status. MDD cannot be directed to terminate if initiated by CIP.

To bring up MDD via CTI, select option M and enter:

MDD=YES
PORT=port number desired

CAUTION

This mode should only be used to track problems associated with an operating system deadstart.

NOTE

When deadstarting a mainframe via the Two Port Mux, it is possible for the SCD and MDD to share the same port. If this occurs, the operator needs to use the F7 key to toggle use of the terminal between these two functions.

The timeout parameter has been removed from the NOS X.MDD command. To bring up MDD under NOS, type the following under Dynamic System Display (DSD).

X.MDD(p)

where p is an octal digit. If p=1, MDD uses Port 0 of the Two Port Mux. If p is any other value or not specified, then MDD uses Port 1.

In a dual state environment, MDD must be initiated from the NOS/VE side through use of the `CHANGE_MDD_OPERATING_MODE` command. However, MDD could be initiated from the 170 side before NOS/VE deadstart is initiated.

To bring up MDD under NOS/BE, type the following under DSD.

```
UNLOCK,passwd.
MDD,n.
LOCK.
```

The `n` parameter follows the protocol for the `p` parameter in NOS. `n` specifies the port number, zero or one.

CHANGE_MDD_OPERATING_MODE Command

Enter this command only under direction of a site analyst.

Purpose To turn MDD on or off or to change the port on which its output is displayed.

Format `CHANGE_MDD_OPERATING_MODE a p`
a=ON_OR_OFF
p=PORT_NUMBER

Parameters *a*
 Specifies whether MDD is to be turned on or off.

b
 Specifies the port number MDD will use when displaying output.

Remarks

- This command must be entered from the Critical Display Window.
- There is no abbreviated form of this command.
- SCI/MDD can only be active on one port.

Conventions

Delimiters Only a comma or space may be used.

Parameter Options These are listed in the explanatory text following the parameter, if applicable.

Required Parameters These are listed in the explanatory text following the parameter, if applicable.

Parameter Defaults These are listed in the explanatory text following the parameter, if applicable.

Central Memory Display Commands

All of the central memory display commands save the address and word_count parameters. The default values for the address and word_count on the next central memory display are obtained from these values.

Display Bytes

Purpose The DB command displays 64-bit memory in 8-bit byte format (one word per line, eight groups of two hexadecimal digits per word).

Format DB

MA = byte_address
WC = word_count

Parameters MA

Starting byte address for the central memory display (hexadecimal). This value is rounded down to the nearest word boundary. The default value is zero or the address used by the most recent memory, control store, or DFT command.

WC

Number of words to display (hexadecimal). The default is 8 or the most recently entered value.

Display CM

Purpose The DC command displays the least significant 60 bits of central memory in octal word format (one word per line, twenty octal digits per word). Display CM is not available on CYBER 930.

Format DC

MA = octal_address
WC = word_count

Parameters MA

Starting word address for the central memory display (octal). The default value is zero or the address used by the most recent memory, control store, or DFT command.

WC

Number of words to display (octal). The default is 8 or the most recently entered value.

Display Hexadecimal CM

Purpose The DH command displays 64-bit memory in hexadecimal word format (one word per line, 16 hexadecimal digits per word).

Format **DH**
MA=word_address
WC=word_count

Parameters **MA**
 Starting word address for the central memory display (hexadecimal). The default value is zero or the address used by the most recent memory, control store, or DFT command.

WC
 Number of words to display (hexadecimal). The default is 8 or the most recently entered value.

Display Virtual Memory

Purpose The DM command can be used to display memory in a virtual environment. When first initiated, MDD initializes all of its default virtual memory parameters from the hardware registers. These values may be changed if desired. The memory is displayed by first displaying the segment number and the memory in byte format (eight groups of two hexadecimal digits) with an eight-digit relative byte offset for an address. The Real Memory Address (RMA) for the first word displayed is saved to be used as the default for the DC, DH, and DB commands. This allows the user to determine the RMA for an arbitrary PVA by simply entering a DB, DH, or DC command. The PVA entered is retained as the default PVA for the next execution of the DM command.

NOTE

MP, JP, PT, PS, and PL are reinitialized when the SE command is entered. The SE command is necessary if MDD is activated prior to NOS/VE deadstart.

Format **DM**
PVA=virtual_address
WC=word_count
xp=exchange_package
PT=page_table_rma
BO=byte_offset
PS=page_size_mask
PL=page_table_length

Parameters *PVA*

Process Virtual Address to use as the starting memory address for the display. This is an eleven-digit hexadecimal number consisting of three digits of segment number and eight digits of byte offset. The default is all zeros or the most recently entered value.

WC

The number of words to display (hexadecimal). This defaults to the previously used value.

xp/MPS

xp/JPS

xp/XPS

EXchange Package address to be used to obtain the segment table address used in converting a PVA to a System Virtual Address (SVA) prior to searching the Page Table. Just specifying the keyword uses the value last specified for the keyword. Specifying *xp=hex_address* changes the value that is associated with the keyword *xp*. If this parameter is omitted, then the keyword last entered on a DM command is assumed. The initial defaults for *MP* and *JP* are the values of the *monitor_state* and *job_* process registers when MDD is started up.

PTA

Page Table Address. The initial default is the page table address when MDD is started up. The default is changed by entering this parameter.

BO

Byte Offset. This parameter can be used if you wish to display a different offset in the same segment. If this parameter is used, then the *PVA* parameter should not be used.

PS

Page Size mask. Hexadecimal number for the new page size mask. The initial default is the page size mask when MDD is started up. The default is changed by entering this parameter.

PL

Page table Length. Hexadecimal number for the new Page Table length. The initial default is the page table length when MDD is started up. The default is changed by entering this parameter.

Display Next Central Memory Block

Purpose The + repeats the last CM display command using a new starting address. If no increment is given, then the CM displayed starts where the previous display ended. If the increment is specified, the starting address for the memory displayed is equal to the `current_starting_address` plus the increment.

Format +
increment

Parameters *increment*
Optional `starting_address` increment when the CM display command is repeated. The increment is interpreted in the same manner as the word or byte count of the previous memory display command.

Display Previous Central Memory Block

Purpose The - repeats the last CM display command using a new starting address. If no decrement is given, then the CM displayed ends where the previous display started. If the decrement is specified, the starting address for the memory displayed is equal to the `current_starting_address` minus the decrement.

Format -
decrement

Parameters *decrement*
Optional `starting_address` decrement when the CM display command is repeated. The decrement is interpreted in the same manner as the word or byte count of the previous memory display command.

Central Memory Change Commands

The following commands are used to change central memory. Each attempt to write central memory will check the address against the OS Bounds Register. If the write would cause an OS Bounds violation, MDD toggles the OS Bounds Register and performs the central memory write commands.

Enter Bytes into Memory

Purpose The EB command changes memory one byte at a time for 1 to 33 bytes. The byte address is retained for successive memory display commands.

Format EB
MA = byte_address
B1...Bn

Parameters MA
 Starting byte address (hexadecimal) to be changed. The address is the exact byte address and need not be on a word boundary. The address must be specified.

B1...Bn

The new values for the bytes starting at the byte address specified by the MA parameter. Each value is a one- or two-digit hexadecimal number. One or more bytes may be changed at a time.

Enter Central Memory

Purpose The EC command changes one word of 60-bit memory to the specified octal value. The address changed is retained for successive memory display commands. This command is not available in CYBER 930.

Format EC
MA = word_address
WV = word_value

Parameters MA
 The word address (octal) to be changed. The address must be specified.

WV

The new value to be entered into the address given by MA. This is a 1- to 20-digit octal value, right justified. The default for this parameter is zero.

Maintenance Register Display Commands

Display Maintenance Registers

- Purpose** The DR command displays either a single maintenance register, a list of consecutive registers, or a predefined list of registers in a specific element (IOU, memory, processor). On a dual I4 system, IOU0 is the only IOU which may be accessed by way of this command. The display consists of the register number (hexadecimal), the contents of the register in 16 hexadecimal digits, and a description of the register (only for the predefined list option). This command is not available on CYBER 930.
- Format** **DR**
element
RN=register_number
RC=repeat_count
- Parameters** *element/x*
- Identifies the element from which to read the register(s). The only valid keys are: I for IOU, M for memory, and P for processor. The initial default is P. Once a value has been specified it becomes the default. On a dual I4 system, IOU0 is the only IOU which can be accessed by way of this command.
- RN***
- Register Number to display (hexadecimal). If this parameter is omitted, the predefined list based on the element and mainframe model is used. On dual I4 systems, IOU1 registers cannot be displayed with this command.
- RC***
- Repeat Count (hexadecimal). This parameter when specified with the RN parameter defines the number of additional registers to display. This parameter has no effect if RN is not specified.
- The default registers displayed depends upon which element is specified.

Enter New Maintenance Register Value

Purpose The ER command allows the user to change the value of a register in an element on the maintenance channel. On a dual I4 system, IOU0 is the only IOU which can be accessed by way of this command. This command is not available on CYBER 930.

CAUTION

Not all registers can be safely changed while an operating system is up. Some registers cannot be written by MDD for hardware reasons. The user should be familiar with the register he/she is trying to alter as mistakes can lead to unpredictable and unreliable results.

Format ER
element
RN=register_number
RV=register_value

Parameters *element/x*
Identifies from which element to write the register. The only valid keys are: I for IOU, M for memory, and P for processor. The initial default is P or the most recently entered value. On a dual I4 system, IOU1 registers cannot be entered with this command.

RN

The required hexadecimal Register Number to change.

RV

Value to write into the register. This may be a 1- to 16-digit hexadecimal number. The value is written to the register right justified.

Clear Errors on Maintenance Element

Purpose The CE command clears errors on the specified element. On a dual I4 system, IOU0 is the only IOU which can be accessed by way of this command.

Format CE
element

Parameters *element/x*
The element for which the Clear Errors function is executed. The only valid keys are: I for IOU, M for memory, and P for processor. The default is the most recently entered value from an ER, DR, CX, or CE command. On a dual I4 system, IOU1 errors cannot be cleared with this command.

Master Clear a Maintenance Element

Purpose The CX command master clears a specified element. On dual I4 systems, IOU0 is the only IOU which may be accessed by way of this command. This command is not available on CYBER 930.

WARNING

This command should not be used if an operating system is functioning.

Format CX
 element

Parameters *element/x*
The element for which the master clear function is executed. The only valid keys are: I for IOU, M for memory, and P for processor. The default is the most recently entered value from an ER, DR, CX, or CE command. On a dual I4 system, IOU1 cannot be master cleared with this command.

Interpret MCR Bit Settings

Purpose The MC command gives a brief description of each bit set in either the provided MCR value or from the active MCR register. If no parameter is supplied and no bits in the active MCR register are set, the user is informed that the register is clear. This command is not available on CYBER 930.

Format MC
 RV=mcr_contents

Parameters *RV*
The MCR Register Value to be interpreted. If not specified, then the current MCR is read and its contents are used.

Interpret UCR Bit Settings

Purpose The UC command gives a brief description of each bit set in either the provided UCR value or from the live UCR register. If no parameter is supplied and no bits in the live UCR register are set, the user is informed that the register is clear. This command is not available on CYBER 930.

Format UC
 RV=ucr_contents

Parameters *RV*
The UCR Register Value to be interpreted. If not specified, then the current UCR is read and its contents are used.

Display PP Register Values

Purpose The DP command displays the selected register for all the PPs in the IOU0. On dual I4 systems, PP register values in IOU1 cannot be displayed by way of this command. The registers are displayed as six-digit octal numbers, five to a line. The first line displays PPs 0 to 4. The second line displays PPs 5 to 11. The third line displays PPs 20 to 24 and the fourth line PPs 25 to 31. If CIO PPs are present, a fifth line displays CIO PPs 0 to 4. If a second barrel of CIO PPs is present, then a sixth line displays CIO PPs 5 to 11. This command is not available on CYBER 930.

Format DP
register

Parameters *register/x*
Identifies which PP register to be displayed for each PP. The valid keys are: P for the program counter, Q for the Q register, K for current instruction, and A for the accumulator. The initial default is P or the most recently entered value.

Idle PP

Purpose The IP command idles the selected PP in IOU0 by doing a hardware idle on the PP. On a dual I4 system, PPs in IOU1 cannot be idled by way of this command. Once idled, the PP can only be restarted by way of MDD by execution of the RP command. The A register is destroyed during the restart. This command is not available on CYBER 930.

Format IP
PP=pp_number
pp_type

Parameters *PP*
PP number to idle. This must be an octal number 0 to 11 or 20 to 31. This parameter is required.

pp_type/x

The *pp_type* is used to differentiate between NIO and CIO PPs. The only valid keys are N for NIO and C for CIO. The initial default is N or the most recently entered value.

Restart PP at Specified Address

Purpose The RP command restarts a PP in IOU by deadstarting the PP and setting a new P register. On a dual I4 system, PPs in IOU1 cannot be restarted by way of this command. This command is not available on CYBER 930.

CAUTION

The deadstart load destroys words 0 and 1 as well as the A register of the specified PP.

Format RP
PP=pp_number
AD=starting_address
pp_type

Parameters *PP*
 PP number to restart. This must be an octal number 0 to 11 or 20 to 31. The parameter is required.

AD
 Address of first instruction to be executed. The address is an octal value from 0 to 7776. This parameter is required.

pp_type/x
pp_type is used to differentiate between NIO and CIO PPs. The only valid keys are N for NIO and C for CIO. The initial default is N or the most recently entered value.

Halt Processor

Purpose The HP command unconditionally halts the CPU. If used on a dual CPU system, the CPU that is halted is the one specified by the SE command. The initial default is CPU0. This command is not available on CYBER 930.

CAUTION

The HP command should only be used by trained individuals that understand the hardware they are using. For example, if the user enters the HP command before he/she enters an SD T ON command, DFT recognizes that CPU as being halted and attempts to restart it.

Format HP

Start Processor

Purpose The SP command attempts to restart the CPU by restarting the microcode. Depending on the reason the processor halted, this may or may not be successful. A specific microcode address may (optionally) be supplied. If used on a dual CPU system, the CPU that is started is the one specified by the SE command. The initial default is CPU 0. This command is not available on CYBER 930.

Format SP
AD=micro_code_address

Parameters AD
 Optional four-digit hexadecimal microcode Address. If no address is supplied, the CPU is restarted from where it was stopped.

Set CPU Value

Purpose The SE command specifies which CPU is used when entering DR, ER, RF, HP, SP, DS, DK, ES, EK, CX, CE, MC, and UC commands. It also resets the MP, JP, PT, PS, and PL values on the DM command to the appropriate values for the CPU selected.

Format SE
CP=n

Parameters CP
 The number of the CPU to be used for future commands which reference CPU registers. Allowed values are zero or one. The initial default is zero.

Display the Register File for a Processor

Purpose The RF command displays the register file for the CPU which has been previously selected by the SE command. This command is not available on CYBER 930.

NOTE

The CPU must be halted to execute this command on some models and must be running on others.

Format RF
AD=address
WC=word_count

Parameters AD
 Hexadecimal register number to display. The default value is 0.

WC
 The number of entries to display (hexadecimal). The default value is 10 or the most recently entered value from a DS, DK, or RF command.

DFT Commands

Display DFT Block Header

Purpose The DF command displays the DFT control block header. The DFT control block header consists of the DFT control word and the following pointer words to various buffers and tables. If DFT has not set the verified (or rejected) flag, the message NO DFT is output to the terminal.

NOTE

The address of the DFT control block or buffer of interest is saved so the next memory display command also displays this portion of memory.

Format DF

Parameters NONE

Display DFT Maintenance Buffer

Purpose The MB command displays the maintenance register buffer control words or the contents of a specific maintenance register buffer. Invalid register entries are suppressed. If DFT has not set the verified (or rejected) flag, the message NO DFT is output to the terminal.

NOTE

The address of the DFT maintenance register buffer control words or buffer of interest is saved so the net memory display command also displays this portion of memory.

Format MB

BN = maintenance_register_buffer_number

Parameters BN

Maintenance buffer number to display (0 through 10; hexadecimal). If the number is beyond the number of buffers on the specific mainframe the command terminates.

Display DFT Model Dependent Buffer

Purpose The MD command displays the three pointers to the DFT Model Dependent Buffers or if the buffer index parameter is specified, it displays one of the DFT Model Dependent Buffers. If DFT has not set the verified (or rejected) flag, the message NO DFT is output to the terminal.

NOTE

The address of the DFT Model Dependent Buffer (or the address of the pointers) is saved so that the next memory display command also displays this portion of memory.

Format MD

BI = buffer_index

Parameters BI

Specifies which specific model dependent buffer to display. Allowed values are zero, one, or two. This parameter is ignored if DFT is at version 3 or earlier.

Set DFT Flag

Purpose The SD command can be used to instruct DFT to freeze on (or process) corrected and/or uncorrected errors or instruct DFT to ignore errors. If DFT is instructed to freeze on corrected and/or uncorrected errors, and if the appropriate error occurs, DFT halts all processors, logs errors and then waits until instructed to again process errors. It then clears the registers and restarts all processors. If instructed to ignore errors, DFT stops reading maintenance registers, thereby ignoring any errors until instructed to again look for errors. If DFT has not set the verified flag, the message DFT NOT VERIFIED is output to the terminal. The command has various formats, depending on the action code specified.

NOTE

The SD T ON command results in any errors that occur being ignored. If DFT is at version 4 or earlier, the user must enter both the SD U ON and the SD C ON commands to instruct DFT to halt all processing when any error occurs. If DFT is at version 5 or later, the most recently entered SD command overrides any previously entered command. The user must enter SD A ON to instruct DFT to halt all processing when any error occurs. Note also that at DFT version 5 or later, the use of the UE/WE commands overrides any SD command (and vice versa).

Format SD
error_type
DFT_action

Parameters *error_type/x*

This keyword indicates what error processing DFT should do. The allowed values of U for uncorrected errors and C for corrected errors cause DFT to process errors as indicated above if the DFT action is set to ON or to continue normal processing if the DFT action is set to OF. The value A causes DFT to process all errors (corrected and uncorrected) as described above if the DFT action is set to ON and to process all errors normally if the DFT action is set to OF. See the note above for more information regarding the use of A vs. U/C at various levels of DFT. The value T causes DFT to ignore errors if the DFT action is set to ON. The default is initially T. The default changes when a new value is entered.

DFT_action/x

The ON keyword sets the DFT flag and the OF keyword clears the flag. The initial default is OF. The default changes when a new value is entered.

Set DFT Error Control Data

Purpose The UE (Update DFT error control data), DE (display DFT ECR element) and WE (write DFT ECR element) commands can be used to isolate specific hardware errors in a system element. A system element is an IOU, CPU, central memory, or page map (CYBER 930 only). The error control data is stored in the ECR (Error Control Record) for the element and it tells DFT to freeze on or process specific errors. Error control data can be very general; for example, stopping the system on any error or ignoring all errors (similar to the SD command). It can also be very specific; for example, freezing the system when a certain bit of a PFS register in a certain element is set.

Typically, the UE command would first be entered to specify an element and an action code. Other formats of the UE command would then be used to enter the parameters (register numbers, register values, and masks) required by a specific action code. As the data is entered, it is stored in a central memory buffer. The DE command can be used to display the data that has been entered thus far. After all of the required data has been entered, the WE command is executed to tell DFT to update its copy of the ECR from the CM buffer. DFT also updates the copy of the ECR on the CIP device. Once the WE command is entered, the error control data remains in effect until it is changed through another series of UE/DE/WE commands or through the SD command or CIP is reloaded.

If DFT has not set the verified flag, the message DFT NOT VERIFIED is output to the terminal. These commands are valid only if DFT is at version 5 or later.

NOTE

These commands should be used only by knowledgeable persons who are familiar with the command and the DFT OS Interface Specification. Incorrect or incomplete entry of data could result in undesirable system halts.

Update DFT Error Data

Purpose The UE command sets error control data on any system element. The command has various formats to enter the parameters required by the specified action code.

NOTE

An action code=1 causes all errors that occur in a particular element to be ignored. In order to cause DFT to halt all processing when any error occurs, the user must enter an action code=2 for all elements. Use of the SD command overrides any UE/WE commands that were previously entered (and vice versa).

Format UE

EI=element_id AC=action_code
EI=element_id RA=register_number RV=register_value
EI=element_id MA=register_mask
EI=element_id RB=register_number RV=register_value
EI=element_id MB=register_mask

Parameters AC

A decimal ordinal from 0 to 18 which describes what action DFT is to take. There is no default for this parameter.

- 0 Process all errors.
- 1 Ignore all errors.
- 2 Freeze on any error.
- 3 Freeze on any corrected error.
- 4 Freeze on any uncorrected error.
- 5 Freeze on RA bit range.
- 6 Freeze on RA specific bits.
- 7 Freeze on RA bit range and RB bit range.
- 8 Freeze on RA bit range and RB specific.
- 9 Freeze on RA specific and RB bit range.
- 10 Freeze on RA specific and RB specific.
- 11 Ignore corrected error.
- 12 Ignore uncorrected error.
- 13 Ignore RA bit range.
- 14 Ignore RA specific bits.
- 15 Ignore RA bit range and RB bit range.
- 16 Ignore RA bit range and RB specific.
- 17 Ignore RA specific and RB bit range.
- 18 Ignore RA specific and RB specific.

EI

This required parameter is a numeric value which corresponds to a system element.

- 00 CPU0
- 10 CPU1
- 02 IOU0
- 12 IOU1
- 01 Central memory
- 03 Page map (CYBER 930 only)

RA

This parameter is the hexadecimal number of a register within the specified element. There is no default for this parameter.

RB

This parameter is the hexadecimal number of a register within the specified element. There is no default for this parameter.

RV

This is a 64-bit hexadecimal value to be stored in the specified register. There is no default for this parameter.

MA

A logical AND will be performed between this 64-bit hexadecimal value and the RA register. There is no default for this parameter.

MB

A logical AND will be performed between this 64-bit hexadecimal value and the RB register. There is no default for this parameter.

Display Element

Purpose The DE command displays the error control data that has been entered into the CM buffer for a specific element.

Format DE
EI=element_id

Parameters EI
This required parameter is a numeric value which corresponds to a system element.

00	CPU0
10	CPU1
02	IOU0
12	IOU1
01	Central memory
03	Page map (CYBER 930 only)

Write Element

Purpose The WE command tells DFT to write its copy of the ECR and the copy on the CIP device from the CM buffer.

Format WE

Parameters NONE

Display DFT Structure

Purpose The DD command displays any DFT structure. Only the data is displayed, no interpretation is performed.

Format DD
structure

Parameters **structure/x**

This keyword indicates which DFT structure should be displayed. the default is BC.

SI	SECDED ID table.
MR	Maintenance register buffer.
NV	NOS/VE request pointers.
PR	C170 PP resident buffer.
BC	Buffer control words.
ME	Mainframe element counters.
EC	Error control record.
SS	Supportive status buffer.
NS	Non-register supportive status buffer.
CM	Central memory resident.
PS	PP register save area.
SD	Secondary DFT buffer.

Control Store Commands

Display Eight-Byte Control Store

Purpose The DS command displays 64-bit control store. This command is only available on CYBER models 810, 815, 825, 830, 835, and CYBER 99X.

NOTE

The processor must be halted to execute this command.

Format DS
AD=address
TC=type_code
WC=word_count

Parameters AD
The four-digit hexadecimal Address to begin displaying the control store memory. The default is 0 or the most recently entered value from an DS, DK, ES, EK, DFT command, or memory command.

TC
The one-digit Type Code for the desired control store. The default is 0 or the most recently entered value from a DK, DS, EK, or ES command.

WC
The number of words of control store to display. The default value is 10 or the most recently entered value from a DB, DC, DH, DS, DK, or RF command.

Display Sixteen-Byte Control Store

Purpose The DK command displays 128-bit control store. This command is only available on CYBER models 810, 815, 825, 830, 835, and CYBER 99X.

NOTE

The CPU must be halted to execute this command.

Format **DK**
AD=address
TC=type_code
WC=word_count

Parameters *AD*
The four-digit hexadecimal ADDRESS to begin displaying the control store memory. The default is 0 or the most recently entered value from an DS, DK, ES, EK, DFT command, or memory command.

TC

The one-digit Type Code for the desired control store. The default is 0 or the most recently entered value from a DK, DS, EK, or ES command.

WC

The number of words of control store to display. The default value is 10 or the most recently entered value from a DB, DC, DH, DS, DK, or RF command.

Enter Eight-Byte Control Store

Purpose The ES command changes a word in 64-bit control store. The new values are to be entered byte-wise and are entered left justified. This command is only available on CYBER models 810, 815, 825, 830, 835, and CYBER 99X.

NOTE

The CPU must be halted to execute this command.

Format ES
AD=address
TC=type_code
B1...Bn

Parameters AD
The four-digit hexadecimal ADDRESS to begin displaying the control store memory. This parameter is required.

TC
The one-digit Type Code for the desired control store. The default is 0 or the most recently entered value from a DK, DS, EK, or ES command.

B1...Bn
The new values for the bytes starting at the byte address specified by the AD parameter. Each value is a one- or two-digit hexadecimal number. One or more bytes may be changed at a time.

Enter Sixteen-Byte Control Store

Purpose The EK command changes a word in 128-bit control store. The new values are to be entered byte-wise and are entered left justified. This command is only available on CYBER models 810, 815, 825, 830, 835, and CYBER 99X.

NOTE

The CPU must be halted to execute this command.

Format **EK**
AD=address
TC=type_code
B1...Bn

Parameters *AD*
 The four-digit hexadecimal ADdress to begin displaying the control store memory. This parameter is required.

TC

The one-digit Type Code for the desired control store. The default is 0 or the most recently entered value from a DK, DS, EK, or ES command.

B1...Bn

The new values for the bytes starting at the byte address specified by the AD parameter. Each value is a one- or two-digit hexadecimal number. One or more bytes may be changed at a time.

Miscellaneous Commands

Return MDD PP to the Operating System

Purpose The BY command causes MDD to give up the communications port and return the PP to the operating system if no other SCI is made active (for example, SCD). MDD must then be started from the operating system console.

The BY command causes MDD to write into word DFCM+10 in the Environmental Interface Control Block (if at least at Level 4) the following status.

Bit	Meaning
0-15	RFU.
16-31	Number of SCI overlays that were actually loaded from CM.
32-47	Number of times MDD wrote CM.
48-63	Number of times MDD wrote Maintenance Registers.

NOTE

If MDD was initiated by CIP in a dual state environment, this command, enters the values described above, responds with *ILL* and MDD continues to function normally.

Format BY

Set Refresh Mode

Purpose MDD can be run in a refresh mode that allows the user to watch registers or memory change. In refresh mode, MDD outputs an 18 (hexadecimal) and a 0C (hexadecimal) to clear the screen for most CRT terminals. The terminal should be in page mode; when operating in this refresh mode, the cursor homes to lower left.

Format SR
mode

Parameters *mode/x*

ON sets MDD to display in refresh mode and OF sets the refresh mode off. The initial default value is off.

Set Refresh Rate

Purpose If MDD is operating in refresh mode, the RR command allows the user to set the refreshing rate faster or slower. This allows the user to adjust the refreshing rate to his/her needs by repeating this command.

Format **RR**
change

Parameters *change/x*
This parameter has two values. FA causes the displays to be updated more rapidly and SL slows down the refreshing rate. The initial default is FA.

Display MDDs Commands

Purpose The HE command allows the user to see a brief explanation of all of the commands which are available. If the command parameter is specified, MDD displays the syntax for that command. To accommodate different screen sizes, a pause is inserted into the output of the command list to allow the user time to read the information. Pressing any key at this time causes the list to continue.

Format **HE**
command

Parameters *command*
When this optional parameter is entered, MDD displays the syntax for the desired command. If an invalid command name is entered, MDD responds with *ILL* (see Other Messages to the Terminal).

ESC Key

Purpose The ESC key allows the user to terminate the input of a command. When MDD receives a 1B (hexadecimal), it terminates any input it has received, outputs the message *ILL*, and waits for new input.

Other Messages to the Terminal

Message	Cause of Message
CHANNEL 17 HUNG	MDD shares the maintenance channel with other utilities. If this channel is hung and MDD is unable to access it, the message CHANNEL 17 HUNG appears. When this happens, all commands which access this channel no longer function.
CLEARED	After MDD does a master clear (CX) of an element, the message CLEARED is displayed.
CPU Halted	MDD has halted the currently selected CPU.
CPU must be Halted to access Control Store	Execute a DS, DK, ES, or EK command the CPU must be halted.
CPU Started	MDD has started the currently selected CPU.
CPU x	MDD has set the default CPU to the value indicated by x.
CPU 0	Value for a nonexistent CPU. MDD has reset to the default CPU of 0.
CPU # not found	The SE command was given with a CP parameter.
Deadman Timeout	MDD has encountered an error while it was attempting to read or write a maintenance register.
DFT NOT VERIFIED	DFT has rejected the DFT block. The SD command will not function.
ECR UPDATED	MDD has completed the update of the specified DFT error control record.
ELEMENT ID NOT FOUND	MDD could not find the specified element ID.
ERROR	MDD has encountered an error while it was attempting to read or write a maintenance register.
ERROR Handling inactive	MDD has set the desired flag in the DFT Control Word.
ERROR Handling active	MDD has cleared the desired flag in the DFT Control Word.
IGNORED	If the user wishes to abort a command, he/she may press the ESC key. MDD then ignores the previous input. Or the F7 key has been pressed and no other driver has signaled a request for the port.

Message Center	Cause of Message
ILL	If the user enters a command which MDD does not recognize or uses improper syntax, MDD responds with *ILL*. The previous input is ignored and the user should enter the proper command and syntax. MDD also follows this protocol if it detects a character it does not recognize (for example, @). If the user wants to abort a command he may press the ESC key. MDD responds *ILL* and ignores the previous input.
MDD Level xx Copyright CONTROL DATA 1989	Each time MDD acquires access to the terminal via the two port multiplexer this message is displayed. This permits the user to confirm that he/she is communicating with MDD. The xx after the word level is incremented for each update to MDD.
MEMORY WRITE WOULD CROSS OS BOUNDS	An attempt to execute an EB or EC command would cause MDD to violate the OS Bounds register. The user should enter the AB command and try again.
MR ERROR	MDD has encountered an error while trying to access channel 15.
NO DFT	The DFT PP has not verified (or rejected) the DFT control block. The DF and SD commands do not execute.
OS BOUNDS toggled for MDD	The next execution of an EB, EC, or SD command allows MDD to reset its side of the OS Bounds register if needed.
PAGE MISSING	MDD has searched the Page Table for an address specified by a DM command and has not found the page in central memory.
PP HALTED	Indicates MDD has halted a PP.
Press any key for more HELP	The listing of the commands available to MDD has been suspended. Any key pressed causes the output to continue.
PROCESSOR HALTED	MDD has halted the currently selected CPU.
Processor MUST be HALTED to read Control Store	To execute a DS or DK command the processor must be halted.
Processor MUST be HALTED to write control store	To execute a ES or EK command the processor must be halted.
PROCESSOR STARTED	MDD has started the currently selected CPU.
SEGMENT MISSING	The segment number provided on a DM command is either invalid or has an invalid ASID.

Message Center	Cause of Message
WRITE WOULD CROSS MEMORY BOUNDS	An attempt to execute an EB or EC command would cause MDD to violate the Memory Bounds register. The user must know how to enable write and try again.
ZERO BUFFER LENGTH	The DD command was executed for a structure with a zero length; therefore it could not be displayed.

Error Log/Dayfile Messages

Message	Cause of Message
MDD - ALREADY ACTIVE.	There is already a copy of MDD executing in a PP. A "BY" command must be issued to that copy before a new one can be initiated.
MDD - CONSOLE MUST BE UNLOCKED.	An attempt was made to bring MDD up when the operators console was in a locked state. The operator should unlock the console. MDD will drop out. An alert status is sent.
MDD - IMPROPER ACCESS ATTEMPT.	MDD was not initiated with the proper validation. MDD will drop out. On NOS an alert status is sent.
MDD - MR ERROR.	A maintenance register error was detected at initialization time. MDD will drop out. If no PPs are hung, the operator should attempt to bring MDD up again.
MDD - NOT ALLOWED ON THIS MAINFRAME.	MDD will only run in a CYBER 170-8xx mainframe (865-875 excluded), 180-8xx mainframe, or a 180-9xx mainframe. MDD will drop out. On NOS an alert status is sent.
MDD - SCI NOT FOUND IN CIP DIRECTORY.	MDD has searched the central memory CTI directory and has not found the resident version of SCI. The CIP level is less than 7. MDD will drop out. On NOS an alert status is sent.
MDD - VALIDATED.	MDD has successfully validated itself and begun operation.
MDD - MUST BE INITIATED FROM NOS/VE.	When NOS/VE is active in a dual state environment, MDD cannot be initiated from the 170 side. It must be brought up on the 180 side. MDD could be initiated from the 170 side before NOS/VE is deadstarted.

Examples of MDD Command Usage

```
dr i
0 0000000000000000 SS
12 0000FFFAFFF0F07 OI
18 0000000000000000 MASK REGISTER
21 1F1F1F1F000007FE OS BOUNDS
30 0000000000000009 EC
40 0000000000008800 STATUS
80 0000000000000000 FS1
81 0000000000000000 FS2
A0 0000000000000003 TM
```

Display register with default IOU registers.

```
dr m
00 0000000000000000 SS
12 0041000000000000 OI
20 0100000002000000 EC
21 400000000bf60000 MEM BOUNDS
A0 0000000000000000 CEL
A4 0000000000000000 UEL1
A8 0000000000000000 UEL2
```

Display register with default memory registers.

```
er m 21 0
21 0000000000000000
```

Disable Memory Bounds.¹

```
er m 21 400000000bf60000
21 400000000bf60000
```

Restore Memory Bounds.

```
dr p 61
61 000000000FF8270
```

Display register 61 of the processor.

```
dm pva=50000000 mps wc=5
* SEGMENT *005
00000000 00 00 18 00 00 10 81 20
00000008 90 00 00 00 09 09 19 83
00000010 00 00 03 40 00 00 00 18
00000018 00 00 00 02 00 FF 89 D0 p
00000020 8D 01 00 4A 0E 12 AC DF J ,
```

Display the first five words of EI.

```
db
00FFFA000 00 00 18 00 00 10 81 20
00FFFA008 90 00 00 00 09 09 19 83
00FFFA010 00 00 03 40 00 00 00 18
00FFFA018 00 00 00 02 00 FF 89 D0 p
00FFFA020 8D 01 00 4A 0E 12 AC DF J ,
```

Display the same memory with the DB command.

1. Not available on CYBER 930.

```
dh
01FF400 0000180000108120
01FF408 9000000009091983
01FF410 0000034000000018
01FF418 0000000200FF89D0      p
01FF420 8D01004A0E12ACDF      J ,
```

Display the same memory with the DH command. Note: the display address is given by word address instead of byte address.

```
dc
007772000 00006000000004100440      F  DHDI
007772001 00000000001102214601      IBQ A
007772002 000000640000000000030      X
007772003 00000001000777704720      H      P
007772004 64010004501604526017      A D ND  O
```

Display the same memory with the DC command.

```
dh, 17EF65, 4
017EF65 0000000000AD870      p
017EF66 0100100100000B28      (
017EF67 00FF100100000B28      (
017EF68 FE00FFFF80000000
```

Display four words of memory in hexadecimal word format. Note: The display address is given by word address.

```
+
017EF69 00001E070000F7C0      w
017EF6A 0000100000010200
017EF6B 0000100000000180
017EF6C 0000100000000000
```

Advance to the next block of memory.

```
db wc=1 ma=bf7b29
0BF7B28 00 00 10 00 00 0A 08 70      p
```

Display one word in byte format. Note: Address was rounded down.

```
+30
0BF7B58 00 00 10 00 00 00 01 80
```

Advance the display by 30 (hexadecimal) bytes.

```
-B58
0BF7000 90 00 00 13 00 10 41 07
```

Display memory b58 bytes lower in memory.

```
eb bf7003 1 2 3b 4
```

Change memory byte-wise.

```
db
0BF7000 90 00 00 01 02 3B 04 07
```

Display memory just changed.

```
mc
MCR = CLEAR
```

Display current MCR register flags.

```
mc 8010
MCR = DUE, SIT,
```

Display bit definitions for MCR.

```
uc 9000
UCR = PRIV FAULT, PIT
```

Display bit definitions for UCR.

```
dp a
A REG
004000 000073 000127 000145 000153
000154 000001 000147 006421 005510
000022 000001 000002 000056 004276
001460 173542 004563 777771 003551
```

Display PP A registers.

```
he rr
RR [FA/SL]
he
DB DISPLAY MEMORY C180-BYTE
DC DISPLAY MEMORY C170-WORD
DH DISPLAY MEMORY C180-WORD
DM DISPLAY VIRTUAL MEMORY
EB ENTER HEX BYTE[S]
EC ENTER A C170 WORD
DR DISPLAY REGISTER CONTENTS
ER ENTER REGISTER CONTENTS
RF DISPLAY REGISTER FILE
DK DISPLAY CONTROL STORE
DS DISPLAY CONTROL STORE
EK ENTER CONTROL STORE
ES ENTER CONTROL STORE
CE CLEAR ERROR ON PORT
CX MASTER CLEAR PORT
HP HALT PROCESSOR
SE SET CPU VALUE
SP START CONTROL STORE
MC EXPLAIN MCR BITS
UC EXPLAIN UCR BITS
DP DISPLAY PP REGISTER
IP IDLE PP
```

Press any key to continue.

```
q
RP RESTART PP AT A SPECIFIED ADDRESS
DF DISPLAY DFT HEADER
MB DISPLAY DFT MAINTENANCE REGISTER BUFFER
MD DISPLAY DFT MODEL DEPENDENT BUFFER
DD DISPLAY DFT STRUCTURE
SD SET DFT STATE FOR ERROR ACTIONS
UE UPDATE DFT ECR ELEMENT
DE DISPLAY DFT ECR ELEMENT
WE WRITE ELEMENT
RR SET REFRESH RATE
SR SET REFRESH
BY RETURN MDD PP
```

Display the syntax for the RR command.

Display a list of commands.

(Any key entered from terminal.)

df

Display the DFT Control
Block Header (version 3)

```
0701030119030080 DFT Control Word
0022000000020008 SECDED ID Table PTR.
002A0000000201A9 Maintenance Reg. Buffers PTR.
0000000000000000 Model Dependent Buffer PTR.
003300030E800004 NOS/VE Buffer PTR.
0000000000000000 C170 PP Resident Buffer PTR.
0000000000000000 C170 OS Request PTR.
DFT = DFT VERIFIED,
```

df

Display the DFT Control
Block Header (version 6)

```
0F0706010F110080 DFT Control word
001000000002000A SECDED ID Table PTR.
001C0000000200FF Maintenance Reg. Buffers PTR.
0000000000000000 Model Dependent Buffer PTR.
003300030E900004 NOS/VE Buffer PTR.
0000000000000000 C170 PP Resident Buffer PTR.
0000000000000000 C170 OS Buffer PTR.
001D0000000060011 MR Buf. Control Words Buffer PTR.
00300000000060004 MF Element Counter Buffer PTR.
00360000000060019 DFT Control Info. Buffer PTR.
00110000000070078 Supportive Status Buffers PTR.
000B0000000090015 Non-Register Status Buffer PTR.
00220000000090064 DFT Central Memory Resident PTR.
00860000000090128 PP Register Save Area PTR.
000D0000000056003C Secondary DFT Buffer PTR.
DFT = DFT VERIFIED,
```

mb

Display DFT Maintenance
Buffer

```
0000000000000000 Maint. Reg. Buff. Control Word
0000000000000019 Maint. Reg. Buff. Control Word
0000000000000032 Maint. Reg. Buff. Control Word
```

mb 1

```
TOP OF HOUR MAINFRAME ELEMENT COUNTERS
ELEMENT      ULOG CORR UCOR
CPU-0        - 0000 0000 0000
CPU-1        - 0000 0000 0000
IOU-0        - 0000 0000 0000
MEMORY-0     - 0000 0000 0000
```

NOTE

For systems which operate under the 1.4.2 release, version 6 of the DFT buffer will only appear on 96X and 99X machines.

```
sd t on
Error Handling INACTIVE
```

```
sd t of
Error Handling ACTIVE
se 1
CPU 1.
```

```
se 3
CPU # not found
CPU 0.
```

```
by
*ILL*
```

This response comes from the CIP version.

```
hp
CPU HALTED
```

```
sp
CPU STARTED
```

```
EB 345F8 44 33 4?*ILL*
```

Illegal character entered by mistake.

This series of commands could be used to instruct DFT to freeze on a specific bit range in CPU0 register 80. The example requests that DFT freeze if any bit 8 through 15 is set.

```
UE EI=00 AC=5 Set up the error control data.
```

```
UE EI=00 RA=80 RV=00FF000000000000
```

```
UE EI=00 MA=00FF000000000000
```

```
WE Write the updated ECR record.
```

This series of commands could be used to instruct DFT to freeze on bit 24 in PFS register 82 in CPU1.

```
UE EI=10 AC=6 Set up the error control data.
```

```
UE EI=10 RA=82 RV=0000008000000000
```

```
UE EI=10 MA=0000008000000000
```

```
WE Write the updated ECR record.
```

This series of commands could be used to instruct DFT to freeze when bits 1 AND 3 are set in CPU0 register 80 AND any bit 48 through 51 OR 53 through 55 in CPU0 register 83 is set (ignore bit 52).

```
UE EI=00 AC=9 Set up the error control data.
```

```
UE EI=00 RA=80 RV=5000000000000000
```

```
UE EI=00 MA=0000008000000000
```

```
UE EI=00 RB=83 RV=000000000000F700
```

```
UE EI=00 MB=000000000000F700
```

```
WE Write the updated ECR record.
```

Registers Displayed by MDD

For the IOU, the following are displayed and labeled accordingly.

```

00 xxxxxxxxxxxxxxxxxxxx SS
12 xxxxxxxxxxxxxxxxxxxx OI
18 xxxxxxxxxxxxxxxxxxxx MASK REG
21 xxxxxxxxxxxxxxxxxxxx OS BOUNDS
30 xxxxxxxxxxxxxxxxxxxx EC
40 xxxxxxxxxxxxxxxxxxxx STATUS
80 xxxxxxxxxxxxxxxxxxxx FS1
81 xxxxxxxxxxxxxxxxxxxx FS2
A0 xxxxxxxxxxxxxxxxxxxx TM

```

For an IOU - 4 (but not for an I4C) the following CIO registers are also displayed.

```

16 xxxxxxxxxxxxxxxxxxxx OI
1C xxxxxxxxxxxxxxxxxxxx MASK REG
25 xxxxxxxxxxxxxxxxxxxx OS BOUNDS
34 xxxxxxxxxxxxxxxxxxxx EC
44 xxxxxxxxxxxxxxxxxxxx STATUS
84 xxxxxxxxxxxxxxxxxxxx FS1
85 xxxxxxxxxxxxxxxxxxxx FS2
A4 xxxxxxxxxxxxxxxxxxxx TM
B0 xxxxxxxxxxxxxxxxxxxx C-CH 0
B1 xxxxxxxxxxxxxxxxxxxx C-CH 1
B2 xxxxxxxxxxxxxxxxxxxx C-CH 2
B3 xxxxxxxxxxxxxxxxxxxx C-CH 3
B4 xxxxxxxxxxxxxxxxxxxx C-CH 4
B5 xxxxxxxxxxxxxxxxxxxx C-CH 5
B6 xxxxxxxxxxxxxxxxxxxx C-CH 6
B7 xxxxxxxxxxxxxxxxxxxx C-CH 7
B8 xxxxxxxxxxxxxxxxxxxx C-CH 8
B9 xxxxxxxxxxxxxxxxxxxx C-CH 9

```

For memory, the defaults are:

```

00 xxxxxxxxxxxxxxxxxxxx SS
12 xxxxxxxxxxxxxxxxxxxx OI
20 xxxxxxxxxxxxxxxxxxxx EC
21 xxxxxxxxxxxxxxxxxxxx MEM BOUNDS
A0 xxxxxxxxxxxxxxxxxxxx CEL
A4 xxxxxxxxxxxxxxxxxxxx UEL1
A8 xxxxxxxxxxxxxxxxxxxx UEL2

```

For a 990 CPU, the following memory registers are also displayed or are relabeled.

```

A0 xxxxxxxxxxxxxxxxxxxx CEL0
A1 xxxxxxxxxxxxxxxxxxxx CEL1
A2 xxxxxxxxxxxxxxxxxxxx CEL2
A3 xxxxxxxxxxxxxxxxxxxx CEL3
A4 xxxxxxxxxxxxxxxxxxxx UEL1
A5 xxxxxxxxxxxxxxxxxxxx UEL2
A6 xxxxxxxxxxxxxxxxxxxx UEL3
A7 xxxxxxxxxxxxxxxxxxxx UEL4

```

For the CPU, the following list is displayed for all mainframes.

```
00 xxxxxxxxxxxxxxxxxxxx SS
30 xxxxxxxxxxxxxxxxxxxx DEC
31 xxxxxxxxxxxxxxxxxxxx S
40 xxxxxxxxxxxxxxxxxxxx P
41 xxxxxxxxxxxxxxxxxxxx MPS
42 xxxxxxxxxxxxxxxxxxxx MCR
43 xxxxxxxxxxxxxxxxxxxx UCR
48 xxxxxxxxxxxxxxxxxxxx PTA
49 xxxxxxxxxxxxxxxxxxxx PTL
4A xxxxxxxxxxxxxxxxxxxx PSM
51 xxxxxxxxxxxxxxxxxxxx MDW
61 xxxxxxxxxxxxxxxxxxxx JPS
62 xxxxxxxxxxxxxxxxxxxx SIT
80 xxxxxxxxxxxxxxxxxxxx PFS
```

In addition, the following registers are displayed for a series.

810, 830 CPU - 815, 825 CPU

```
81 xxxxxxxxxxxxxxxxxxxx PFS1 - 93 xxxxxxxxxxxxxxxxxxxx MCEL
91 xxxxxxxxxxxxxxxxxxxx CSEL
93 xxxxxxxxxxxxxxxxxxxx MCEL
```

835 CPU

```
81 xxxxxxxxxxxxxxxxxxxx PFS1
92 xxxxxxxxxxxxxxxxxxxx CCEL
93 xxxxxxxxxxxxxxxxxxxx MCEL
```

845, 855 CPU

```
81 xxxxxxxxxxxxxxxxxxxx PFS
82 xxxxxxxxxxxxxxxxxxxx PFS
83 xxxxxxxxxxxxxxxxxxxx PFS
84 xxxxxxxxxxxxxxxxxxxx PFS
85 xxxxxxxxxxxxxxxxxxxx PFS
86 xxxxxxxxxxxxxxxxxxxx PFS
87 xxxxxxxxxxxxxxxxxxxx PFS
88 xxxxxxxxxxxxxxxxxxxx PFS
89 xxxxxxxxxxxxxxxxxxxx PFS
```

990 CPU

81 xxxxxxxxxxxxxxxxxxxx PFS
82 xxxxxxxxxxxxxxxxxxxx PFS
83 xxxxxxxxxxxxxxxxxxxx PFS
84 xxxxxxxxxxxxxxxxxxxx PFS
85 xxxxxxxxxxxxxxxxxxxx PFS
86 xxxxxxxxxxxxxxxxxxxx PFS
87 xxxxxxxxxxxxxxxxxxxx PFS
88 xxxxxxxxxxxxxxxxxxxx PFS
89 xxxxxxxxxxxxxxxxxxxx PFS
8A xxxxxxxxxxxxxxxxxxxx PFS
8B xxxxxxxxxxxxxxxxxxxx PFS
8C xxxxxxxxxxxxxxxxxxxx PFS
8D xxxxxxxxxxxxxxxxxxxx PFS
8E xxxxxxxxxxxxxxxxxxxx PFS
8F xxxxxxxxxxxxxxxxxxxx PFS

Appendixes

Glossary	A-1
CIP Error Messages	B-1
Field Change Announcement (FCA) Interpretation for Model 800 Computer Systems	C-1
Problem Reporting	D-1
Hardware Initialization Verification Software (HIVS) Tests	E-1
Peripheral Processor (PP) Configurations	F-1
Mainframe Reconfiguration	G-1
CC634B Console Initialization	H-1

A

Address

The location of a word in memory. The location is designated by number or symbolic name.

Alphanumeric Characters

The letters of the alphabet (A through Z) and the digits (0 through 9).

B

Binary File

A noneditable file that contains a precompiled program.

C

Cache

A high-speed memory that resides in the central processor.

CAU

Refer to Common Disk Area Utility (CAU).

CDA

Refer to Common Disk Area (CDA).

Central Memory (CM)

The main storage device whose storage cells (words) can be addressed by a computer program and from which instructions and data can be loaded directly into registers. The instructions can be executed and the data can be manipulated from these registers.

Central Memory Flaw Table (CFT)

File name where central memory flaw data is stored.

Central Memory Resident (CMR)

The low address area of central memory reserved for tables, pointers, and subroutines necessary for operation of the operating system. It is never accessible to a user's central processor program. The remainder of central memory is allocated by monitor to jobs as they are selected on a priority basis for execution.

Central Processor Unit (CPU)

The high-speed arithmetic unit that performs the addition, subtraction, multiplication, division, incrementing, logical operations, and branching instructions needed to execute programs.

CFT

Refer to Central Memory Flaw Table.

Channel Number

The number of the data channel on which a peripheral device controller can be accessed.

CIP

Refer to CYBER Initialization Package.

CM

Refer to Central Memory.

CMR

Refer to Central Memory Resident.

CMRDECK

A deadstart text deck used by the NOS operating system to configure the system.

CMSE

Refer to Common Maintenance Software Executive.

CMU

Refer to Compare/Move Unit.

Coldstart

Procedure used to deadstart if the tape or disk controller has not yet been loaded with controlware or the controlware is not running.

Common Disk Area (CDA)

The disk storage area that contains a default parameter block, EI, microcode, SCD, MDD, and CEL.

Common Disk Area Utility (CAU)

The utility program CTI uses to install default parameters, EI, SCD, MDD, and microcode in the common disk area.

Common Maintenance Software Executive (CMSE)

The MSL executive program.

Common Test and Initialization (CTI)

Common deadstart process used to load the operating system and MSL. CTI is one of the modules provided on the CIP tape.

Compare/Move Unit (CMU)

The hardware that executes the CPU instructions for moving and comparing data fields consisting of strings of 6-bit characters.

Confidence Level Testing

Testing done by CTI, HIVS, long deadstart sequence (810, 815, 825, 830, 835, and 855 only) and extended deadstart sequence (models 810 through 860 only). These programs enter data in different parts of memory and then check to see if the patterns hold.

Controller

Hardware device that connects channels to peripheral devices. For example, a tape controller might connect up to eight tape units to one channel.

Controlware

A special type of software that resides in a peripheral controller. The controlware defines the functional characteristics of the controller.

CPU

Refer to Central Processor Unit.

CTI

Refer to Common Test and Initialization.

CYBER Initialization Package (CIP)

A release mechanism that provides CTI, HIVS/MSL, EI, SCD, MDD, and microcode on a single tape.

D**Deadstart**

The process of initializing the system by loading controlware, components of the CIP tape, and the operating system. Coldstart and warmstart are two forms of deadstart.

Deadstart Error Log (DEL)

Log where fatal errors are stored by CTI during confidence testing.

Dedicated Fault Tolerance (DFT)

Software package that controls error handling for CYBER mainframes.

Default

A system-supplied value used when you do not supply the value.

Default Parameter Block (DPB)

The memory block where the default deadstart parameters are stored.

Delimiter

A character used to separate statement elements, such as words and literal constants, or other strings of text.

Device

A tape or disk unit used during system deadstart or for utility operations.

DFT

Refer to Dedicated Fault Tolerance.

DPB

Refer to Default Parameter Block.

DSD

Refer to Dynamic System Display.

Dump

The process of transferring the contents of memory and registers to tape or to a printer for analysis.

Dynamic System Display (DSD)

The operating system program that provides communication between the operator and the system by accepting control information typed on the console keyboard and by displaying to the operator information pertinent to all jobs known to the system. DSD is permanently assigned to peripheral processor 1.

E

ECS

Refer to Extended Core Storage.

EDD

Refer to Express Deadstart Dump.

EI

Refer to Environment Interface Program.

Environment Interface Program (EI)

EI is a component of CIP for models 810 through 860 and 990.

EQPDECK

A deadstart text deck that is used to describe the hardware configuration to the operating system.

Equipment Number

A number from 0 to 7 that identifies the setting on a peripheral device controller.

Equipment Status Table (EST)

A table built and used by the operating system. A list of all peripheral devices connected to the system. Each table entry indicates the status of a particular device. EST resides in CMR.

ESM

Refer to Extended Semiconductor Memory and to Extended Memory.

EST

Refer to Equipment Status Table.

Express Deadstart Dump (EDD)

A utility that may be run at deadstart time after a system malfunction has occurred. It generates the express deadstart dump file on magnetic tape.

Express Deadstart Dump (EDD) File

File that is generated on magnetic tape by the express deadstart dump utility. This file contains memory, hardware registers, and controller memory.

Extended Core Storage (ECS)

A type of extended memory that is an option available for 6000 computer systems, CYBER 70 computer systems, and CYBER 170 computer systems, except for models 176, 815, 825, 835, 845, and 855. Refer to Extended Memory.

Extended Memory

An additional portion of memory available as an option. This memory can be used for program and data storage, but not for program execution. Special hardware instructions exist for transferring data between central memory and extended memory. Extended memory consists of either extended core storage (ECS), large central memory extended (LCME), extended semiconductor memory (ESM), or unified extended memory (UEM).

Extended Semiconductor Memory (ESM)

A type of extended memory that is an option available for 6000 computer systems, CYBER 70 computer systems, and CYBER 170 computer systems, except for models 176, 810, 815, 825, 830, 835, 845, and 855. Refer to Extended Memory.

F**FCA**

Refer to Field Change Announcement.

FCO

Refer to Field Change Order.

Field Change Announcement (FCA)

A chart that communicates the levels of maintenance software, hardware, CYBER Initialization Package, and operating system that have been tested and certified by Control Data to function together correctly.

Field Change Order (FCO)

The directive to install changes in Control Data equipment after normal manufacturing process.

Field Length (FL)

The number of memory words assigned to a program.

File Name Table (FNT)

A system-managed table that contains the local file name, the file type of all active files in the system, and other job control information.

File Status Table (FST)

A system-managed table that contains information pertaining to a file's location on mass storage and other job control information. Each active file in the system has an FST entry. Refer also to File Name Table.

First Level Peripheral Processor (FLPP)

The processor that is connected directly to the CYBER 170 model 176 mainframe and operates synchronously with the mainframe.

FL

Refer to Field Length.

FLPP

Refer to First Level Peripheral Processor.

FNT

Refer to File Name Table.

FST

Refer to File Status Table.

H

Hardware Initialization and Verification Software (HIVS)

The software package that assists CTI during deadstart. It includes the Hardware Verification Sequencer (HVS) that provides deadstart confidence-level testing.

HIVS

Refer to Hardware Initialization and Verification Software.

HIVS-TDX

The tape-to-disk utility used to build HIVS on a disk from tape.

I

Intelligent Small Magnetic Tape (ISMT) Unit

A peripheral tape unit that is small, magnetic, and intelligent.

ISMT

Refer to Intelligent Small Magnetic Tape Unit.

IOU

Input/output unit (models 810 through 875). IOU is a collection of all PPs, PP channels, and related hardware.

IUC

Install/Update CIP Utility. A utility to build the CIP device from tape on I4C Class systems. IUC also enables the transfer of programs/command buffers from the I4C CIP device to tape.

L

Large Central Memory Extended (LCME)

A type of extended memory that is an option available for model 176. Refer to Extended Memory.

LCME

Refer to Large Central Memory Extended.

M

Mainframe Reconfiguration Table (MRT)

File name where mainframe reconfiguration data is stored.

Maintenance Register

A register used in error detection, logging, and recovery procedures for models 865 and 875 only.

Maintenance Software Library (MSL)

A set of tests, diagnostics, and utility programs that test system components, isolate malfunctions, and monitor machine states. MSL executes off-line to the operating system.

MDD

Refer to Monitor Display Driver.

Microcode

Programs residing in control memory or control memories that cause the hardware to execute the product set or diagnostic operations. Microcode is a component of CIP for models 810 through 860.

Monitor Display Driver (MDD)

A program that monitors maintenance registers during operating system operation.

MRT

Refer to Mainframe Reconfiguration Table.

MSL

Refer to Maintenance Software Library.

Multimainframe System

A network of physically and logically connected computer systems.

N**NOS**

Network operating system. A standard operating system for a CYBER 180, CYBER 170, CYBER 70, or 6000 computer system.

NOS/BE

Network Operating System/Batch Environment. A standard operating system for a CYBER 180, CYBER 170, CYBER 70, or 6000 computer system. It controls the execution of programs submitted through remote terminals and maintains normal batch processing operations for jobs submitted locally.

NOS/VE

Network Operating System/Virtual Environment. In addition to having all the capabilities of NOS, NOS/VE also uses virtual memory.

O**Operating System (OS)**

The set of system programs that controls the execution of computer programs and provides scheduling, error detection, input/output control, accounting, compilation, storage assignment, and other related services.

OS

Refer to Operating System.

P

Performance Monitor Facility Register (PMF)

A hardware register used to record system performance. Sometimes referred to as the Performance Environment Monitor Register (PEM).

Peripheral Processor (PP)

The hardware unit within the host computer that performs physical input and output through the computer's data channels.

Peripheral Processor Unit (PPU)

The hardware unit within a mainframe that performs input and output using the mainframe data channels and operates synchronously with the mainframe. Sometimes referred to as a first level peripheral processor (FLPP).

Permanent File

A mass storage file that is cataloged by the system so its location and identification are always known to the system. They are protected by the system from unauthorized access according to privacy controls specified when they are created.

PMF

Refer to Performance Monitor Facility Register.

PP

Refer to Peripheral Processor.

PPU

Refer to Peripheral Processor Unit.

R

RA

Refer to Relative Address.

RCM

Refer to Restore Central Memory (RCM) Utility.

Relative Address (RA)

The absolute machine address in central memory of the first word of a loaded program.

Restore Central Memory (RCM) Utility

The utility that restores central memory from an Express Deadstart Dump (EDD) dump as part of an operating system recovery sequence.

S

S/C Register

Refer to Status/Control Register.

SCD

Refer to System Console Driver.

SCI

Refer to System Control Interface.

SI Tape

Refer to System Internal Tape.

SRT

Sector Reservation Table.

Status/Control (S/C) Register

A hardware register used in error detection, logging, and recovery procedures. This register is present on all CYBER 170 computer systems. For models 865 and 875, the S/C register is replaced by a maintenance register. Refer to Maintenance Register.

System Console Driver (SCD)

An operating system program that provides an interface between the operating system and a CC634B display terminal connected to a two-port multiplexer.

System Control Interface

CIP module containing VPB, SCD and MDD programs.

System Internal (SI) Tape

A magnetic tape with fixed length physical record units of 128 decimal central memory words for coded tape and 512 decimal central memory words for binary tape. An SI tape can be labeled or unlabeled, and written on seven-track or nine-track tape.

T**TDX**

The tape-to-disk transfer utility used to build MSL on a disk from tape.

U**UEM**

Refer to Unified Extended Memory.

Unified Extended Memory (UEM)

A type of extended memory that is available as an option for models 810 through 875. UEM differs from other types of extended memory in that it is a portion of central memory and not a separate memory unit. Refer to Extended Memory.

Unit Number

A number that identifies a hardware device. Used to identify a hardware device when more than one device can be connected to a controller.

V

Virtual Processor Boot (VPB)

An operating system boot program that provides interface between the operating system and the display terminal.

VPB

Refer to Virtual Processor Boot.

W

Warmstart

Procedure used to deadstart if the tape or disk controller is loaded and the controlware is running.

Write Ring

A circular device inserted into a tape reel indicating to the tape unit that it can write on that reel. The operating system checks for the presence of a write ring if you request it.

CIP Error and Informative Messages

B

This appendix contains an alphabetical listing of the error and informative messages that may appear during a CIP operation. All messages are sorted according to the first nonvariable word or character. Messages beginning with special characters (such as hyphens or asterisks) are sorted as if the special characters were not present.

Messages issued by MSL are not included here. See the appropriate MSL reference manual.

Message	Description	Reporting Module
ALL CPUS OFF, OS LOAD IMPOSSIBLE	At least one CPU must be turned on for the OS load to proceed.	CTI
ASSIGNED TAPE IS EITHER NOT CIP OR UN-HEXIFIED	During either an INITIAL or an UPDATE operation, the first program read from tape was not the IPL program. Therefore, the tape is not a CIP tape or the tape was not properly hexified when built.	IUC
CEJ/MEJ OPTION NOT ENABLED FOR CEJ/MEJ USAGE, ENABLE SWITCH ON DEADSTART PANEL AND DEADSTART (CR) FOR NON CEJ/MEJ USAGE	Indicates the CEJ/MEJ switch is physically set to the disable position on deadstart panel and is not logically disabled via the Hardware Reconfiguration display. Enable the switch on deadstart panel and redeadstart to continue.	CTI
CENTRAL PROCESSOR(S) NOT ACCESSIBLE VIA MAINTENANCE CHANNEL. DEADSTART AND SELECT OPTIONS U,I,U,E TO OBTAIN EXPRESS DEADSTART DUMP. NOTE: THIS PROCEDURE WILL RESULT IN THE PARTIAL LOSS OF MAINTENANCE REGISTER INFORMATION. IF UNABLE TO COMPLETE THE DUMP OPERATION AFTER PERFORMING THIS PROCEDURE CONTACT A CUSTOMER ENGINEER.	Express Deadstart Dump determined during its initialization that the central processor is not accessible via the maintenance channel and this inaccessibility would cause a bad dump to be performed. Redeadstart and reselect EDD as directed. Since this procedure clears some of the error bits in the maintenance registers, some maintenance register information will be lost. If you are unable to complete the dump, inform CE.	EDD
CHANNEL ACTIVE ERROR	Channel active when it is supposed to be inactive.	CTI
CHANNEL 15 DATA TRANSFER ERROR	Data transfer error. Inform CE.	CTI
CHANNEL nn PARITY ERROR	Status/Control (S/C) register error. Inform CE.	CTI

Message	Description	Reporting Module
CHANNEL yy UNIT xx NOT RESPONDING	Tape unit xx on channel yy is not responding to a read request. The unit either is not ready or does not exist.	CTI
CIP COMPONENT xxxxx NOT FOUND	CTI cannot find CIP component xxxxx in the common disk area. Reinstall CIP. If message persists, inform CE.	CTI
CM ADDRESS PARITY ERROR	S/C register error. Inform CE.	CTI
CM MISMATCH - CM SIZE AS SET BY CTI DOES NOT MATCH THAT OF DUMP TAPE - DEADSTART REQUIRED	The EDD dump tape used for the Restore CM operation was dumped with a different size of memory. The CM size must be the same to reload central memory. Change CM size via CTI to the same as when the EDD dump was taken.	RCM
CM NOT ACTIVE - LEVEL 3 REC	Memory initialization cannot be performed on a level 3 recovery.	CTI
CM RELOAD NOT FOUND ON DUMP TAPE	The EDD dump tape used for Restore CM does not have a central memory record. Use a correct EDD dump tape for restoring central memory.	RCM
CM UNAVAILABLE, (CR) TO RE-ENTER	Indicates that an address entered during a CM memory dump option is greater than the central memory size. Press the carriage return key and reenter the address.	CTI
CMC x PARITY ERROR	S/C register error. Inform CE.	CTI
CMC PARITY ERROR	S/C register error. Inform CE.	CTI
xxxxxxx COMMAND TOO LONG	Indicates that during a tape-to-disk copy, TDX has encountered a command to be placed on disk that has more than 60 (decimal) characters. The xxxxxxxx in the message is the name of the program or command buffer where the faulty command was found. Pressing the space bar allows TDX to truncate the command to 60 (decimal) characters and continue the operation.	TDX, IUC
COMMON DISK AREA FULL	Insufficient space in the CDA to perform an update build. Redeadstart using the CIP tape and initialize the CDA by selecting the Z option on the CAU Initial Options display.	CTI

Message	Description	Reporting Module
CON,CSaaaa,DSbbbb FCN,CSaaaa,DSbbbb WRT,CSaaaa,DSbbbb	When attempting to generate a dump tape, a connect reject (CON), function reject (FCN), or write error (WRT) was encountered. aaaa specifies the channel converter status. bbbb specifies the controller status.	EDD
COPY ERROR xxxxxxx	Indicates that during a copy operation, the program or command buffer xxxxxxx could not be copied successfully. Pressing the space bar allows TDX to skip to the next program or command buffer and resume copying.	TDX, IUC
CPU x NOT RESPONDING	CPU x did not respond to EI function request within 1-second time limit. Inform CE.	CTI
CPU x P REGISTER PARITY ERROR	S/C register error. Inform CE.	CTI
CS=nnnn	Device communication error (data channel converter status). Inform CE.	CTI
CSU x ADDRESS PARITY ERROR	S/C register error. Inform CE.	CTI
CSU x FAULT	S/C register error. Inform CE.	CTI
CTI CYLINDER OVERFLOW	Space available on the CTI cylinder was not enough to contain the entire CTI file. This problem may have been caused by disk errors. Reformatting the disk or changing packs may resolve the problem.	CTI
CTI PPxx NOT RESPONDING DEADSTART ABORTED	CTI cannot communicate with the PP selected as the alternate PP. Inform CE.	CTI
xxxxxxx DCC ERR STAT yyyy	Indicates that the status received from the data channel converter for a tape drive (60X or 65X) shows that an error condition exists. The xxxxxxx in this message is the name of the program or command buffer that TDX was working with when the error occurred, and yyyy is the octal status word. Pressing the space bar allows TDX to request the current status word.	TDX

Message	Description	Reporting Module
DEADSTART ABORTED - FATAL ERROR	The system detected a fatal error during confidence testing. Inform CE.	CTI
DEADSTART SECTOR ERROR	Indicates TDX was unable to read or write the deadstart sector. A deadstart is required.	TDX
DISK BUSY	Indicates that the disk general status has responded busy to 10000 (octal) attempts by TDX to perform a seek to read or write. Pressing the space bar allows TDX to continue the read or write attempt.	TDX
DISK CONTROLLER RESERVED	Indicates that the disk controller general status shows the multiple access disk controller continues to be reserved to another PP channel following 20 (decimal) attempts 20 (decimal) attempts to connect to the unit. TDX continues to display the message and attempts the connect until successful or until a deadstart is performed.	TDX, CTI
DISK CONTROLLER TRANSFER ERROR xxxxxxx	Indicates TDX was unable to output or input the expected number of words to or from the disk controller, but that the general status indicates no errors. The xxxxxxx is the name of the program or command buffer being copied. Pressing the space bar causes TDX to retry the transfer.	TDX
DISK ERR STAT yyyy xxxxxxx	Indicates that the status received from the disk drive shows that an error condition exists. The xxxxxxx in the message is the name of the program or command buffer that TDX was working with when the error occurred, and yyyy is the octal status word. Pressing the space bar allows TDX to continue the operation, through the result may not be reliable.	TDX

Message	Description	Reporting Module
DISK FUNC REJ yyyy xxxxxxx	Indicates that a function sent to the disk controller has been rejected. The xxxxxxx in this message is the name of the program or command buffer that TDX was working with when the error occurred, and the yyyy is the octal value of the function code that was rejected. Pressing the space bar allows TDX to retry the operation.	TDX
DISK FUNCTION REJECT FUNCTION = xx	The indicated function code xx was not accepted by the disk controller. xx is the function code that was rejected. Press the carriage return key to attempt an error recovery operation.	TDX
DISK UNIT RESERVED	The general status indicates the disk unit has reserved status.	CTI
DISK READ ERROR INFORM CE	CTI was unable to access disk within a predetermined number of attempts. Inform CE.	CTI
DISK STATUS ERROR STATUS = xxxx	The general status word xxxx received from the disk indicates an error condition exists. Press the carriage return key to retry the operation.	CTI
DISK UNIT RESERVED	Indicates that the disk general status shows that the disk remains reserved to another controller following 20 (decimal) attempts to connect to the disk. TDX continues to display the message and attempts the connect until successful or until a deadstart is performed.	TDX
DISPLAY SPACE UNAVAILABLE FOR ADDITIONAL ERRORS	S/C or maintenance register error. Inform CE.	CTI
DUMP TAPE ON CHcc EQee UNuu NOT READY (CR WHEN READY)	The dump tape equipment for an express deadstart dump is not ready. Ready the equipment and press the carriage return key to continue.	EDD
DUMP TAPE ON CHcc EQee UNuu NO WRITE RING (CR WHEN READY)	The dump tape for an express deadstart dump does not contain a write ring. Insert a write ring and press the carriage return key to continue.	EDD

Message	Description	Reporting Module
ECS ERROR.	S/C register error. Inform CE.	CTI
ELEMENT NOT ACCESSIBLE VIA THE MAINTENANCE CHANNEL	Indicates that HDP is unable to access central memory, CPU, register files, or maintenance registers as required by the option.	CTI
ERROR - ADDRESS OUT OF RANGE	The system was unable to access the specified available memory during memory initialization. Press the carriage return key to clear the display.	CTI
ERROR CM	The system detected an error in CM during hardware verification (HIVS). Inform CE.	HIVS
ERROR CPU xx	The system detected an error in CPU xx during hardware verification (HIVS). Inform CE.	HIVS
ERROR EM	The system detected an error in EM during hardware verification (HIVS). Inform CE.	HIVS
ERROR IN (error) FATAL TO DUMP OPERATION	An error occurred during an express deadstart dump operation. Press DEADSTART to retry the dump. If message reappears, inform CE.	EDD
ERROR IN EXECUTABLE AREA	A central memory parity error occurred prior to executing a test program in the CPU.	CTI
ERROR IN SECOND PPS	S/C register error. Inform CE.	CTI
ERROR PP xx	The system detected an error in PP xx during hardware verification (HIVS). Inform CE.	CTI
ERROR PPU xx	The system detected an error in PPU xx during hardware verification (HIVS). Inform CE.	HIVS
ERROR REG	The system detected an error during hardware verification (HIVS). Inform CE.	HIVS
ERRORS OCCURRED DURING CENTRAL MEMORY INITIALIZATION.	An error occurred during central memory initialization. Inform CE.	CTI

Message	Description	Reporting Module
FLAW CYL xxxx TRK yyyy SEC zzzz	Indicates that TDX has failed in four consecutive attempts to write data to a disk sector. The values in the message are the cylinder (xxxx), track (yyyy), and the sector (zzzz), which may not be written in. Pressing the space bar allows TDX to continue the copy with another sector. The bit of the flawed sector remains set in the SRT to ensure that TDX does not attempt to use the bad sector again.	TDX
FORMATTING ERROR	Indicates an error occurred while formatting the MSL area on an 895 Disk subsystem.	TDX
FUNCTION TIMEOUT, (CR) TO RETRY	Indicates that a function issued to the printer has not been accepted. Press the carriage return key to retransmit the function.	HDP
GS=nnnn	Device communication error (general status). Inform CE.	I/O Driver
HARDWARE VERIFICATION IS UNAVAILABLE WITH A LEVEL 3 DEADSTART (BS) PREVIOUS DISPLAY	HIVS can only be executed on a level 2 or less recovery.	CTI
ILLEGAL BUILD SELECTION OS FILES COULD BE DESTROYED	Indicates the build option selected could cause operating system files to be destroyed because space previously allocated to the operating system is being used. Choose an installation mode that will not destroy operating system files or deadstart and release the disk space using CTI.	TDX
ILLEGAL ENTRY	The user entered an illegal parameter during parameter entry. Press the space bar to return to the parameter display and reenter the parameter.	TDX, IUC
IMPOSSIBLE TO INSTALL PROGRAMS AND SAVE COMMAND BUFFER AREA	The operator is saving a command buffer library at cylinder xxxxxxxx. TDX does not examine the two succeeding cylinders to find a suitable starting cylinder. Deadstart is required.	TDX

Message	Description	Reporting Module
INCORRECT LABEL FOR CM RELOAD MOUNT EDD TAPE (CR WHEN READY)	The tape used for the Restore CM operation is not a correctly labeled EDD dump tape. Mount the proper tape and press carriage return.	RCM
INSTALL ABORTED DUE TO DEVICE ERROR INFORM CE (CR) TO PROCESS DIFFERENT DEVICE	Error encountered during installation. Press the carriage return key to select a device or deadstart to exit.	CTI
INSTALLATION COMPLETE CTRL-F2 REQUIRED	Indicates IUC has completed either an initial or update CIP installation task, or a replace CTI task (a manual CIP installation option).	IUC
INSTALLATION COMPLETE DEADSTART IS REQUIRED	Indicates TDX has completed a disk build for automatic CIP tape installation. Deadstart to continue.	TDX
INSUFFICIENT LOGICALLY ON PPS, DEADSTART ABORTED	Too many PPs have been logically turned off to permit a successful deadstart.	CTI
INTER-PP DATA TRANSFER ERROR	Indicates the tape or disk driver is unable to output or input the expected number of words to or from the other driver. The xxxxxxxx is the name of the current program or command buffer. A deadstart is required.	TDX, IUC
INTERLOCK REG. CHANNEL FULL	For CYBER 70 only. Interlock register was detected as being full and should have been empty. Inform CE.	CTI
INVALID CHANNEL ENTRY	An invalid channel number was entered. Press the carriage return key and reenter the channel number.	CTI
INVALID ENTRY	Invalid keyin. Pressing the left blank key clears the message.	CTI
INVALID ENTRY	Indicates that a character that is not a member of an accepted character set as been entered. Enter a valid character to clear the error.	CTI
INVALID OPTION	Invalid option was selected.	CTI

Message	Description	Reporting Module
INVALID PROGRAM NUMBER	Undefined CTI module requested.	CTI
INVALID SELECTION, (CR) TO RETRY	Indicates that the start address is larger than the end address for a CM memory dump option. Press the carriage return key and reenter the two addresses.	CTI
IOU1 NOT RESPONDING	CTI cannot communicate with IOU 1. Inform CE.	PAK
IPL NOT FOUND	First record was read from the deadstart device and its name was not IPL.	CTI
LEVEL 3 RECOVERY NOT POSSIBLE.	A level 3 recovery is not possible when power on initialization is selected. On I4 IOUs, power on initialization will be set automatically by CTI following a system power up, or when the current deadstart immediately follows an MSL load. In this case, you must change the deadstart level to less than 3.	CTI
CENTRAL MEMORY INITIALIZATION HAS BEEN SELECTED BY THE OPERATOR, OR AUTOMATICALLY SET BY THE HARDWARE.		
DEADSTART AND SELECT DIFFERENT RECOVERY LEVEL, OR DO NOT SELECT MAINFRAME INITIALIZATION.		
LOAD ERROR DEADSTART ABORTED	An attempt to load a module from the MSL or the CTI/MSL disk area failed. Inform CE.	CTI
LOGGING MAINTENANCE REGISTERS	Maintenance register errors and DHE is writing them to the CEL.	CTI
MAINS POWER FAILURE	S/C register error. Inform CE.	CTI
MAINTENANCE CHANNEL TIMEOUT (DEADSTART ABORTED) INFORM CE	Maintenance channel did not respond when an attempt was made to function or transfer data to a mainframe element. Inform CE.	CTI
MAINT. REG ERROR yyyy	The system detected an error in a maintenance register during hardware verification (HIVS). Inform CE.	HVS
MEMORY MARGINS SELECTED (CR) TO CONTINUE	CTI detected central memory margins status selected in the maintenance registers. Press the carriage return key to proceed, or return switch to normal and deadstart.	CTI

Message	Description	Reporting Module
MAINFRAME RECONFIGURATION TABLE (MRT) ON DISK DOES NOT MATCH THE MAINFRAME BEING DEADSTARTED	The MRT on disk will be initialized for the current mainframe. Enter a carriage return to continue the deadstart.	CTI
MAINTENANCE NOT FOUND ON DEVICE ENTER ALTERNATE DEVICE	The deadstart file does not contain the HVS module. Enter an alternate device or install the HVS module on the same device and redeadstart.	CTI
MEMORY NOT ACCESSIBLE	A memory element is not accessible via the maintenance channel.	CTI
MEMORY UNAVAILABLE	Selected value exceeds memory. Clear message and reenter command.	CTI
	Operator has attempted to set the logical state of an I4 CIO RP, but none are installed.	
MICROCODE INITIALIZATION ERROR (DEADSTART ABORTED) INFORM CE	Processor microcode failed to complete its initialization in the prescribed time limit. Inform CE.	CTI
MIN CONFIGURATION NOT AVAILABLE	The operator attempted to load microcode, EI, or both without the required minimum system elements. CTI also displays the count of each system element. Reconfigure hardware to at least the minimum configuration.	CTI
MODULE NOT ON LIBRARY DEADSTART ABORTED	An attempt to find a module on the MSL failed. Inform CE.	CTI
MONITOR CONDITION REGISTER=xxxx	During central memory initialization, a nonzero monitor condition register appeared in the job exchange package after reverting to monitor mode. Inform CE.	CTI
MORE S/C REGISTER ERRORS.	There were too many errors to fit on one screen.	CTI
MR-0-2 yyyy yyyy yyyy yyyy yyyy MR-0-1 yyyy yyyy yyyy yyyy yyyy yyyy MR-0-0 yyyy yyyy yyyy yyyy yyyy yyyy	The system detected a fatal error during confidence testing. Inform CE.	CTI

Message	Description	Reporting Module
MS LOAD NOT POSSIBLE. ALTERNATE PP DISABLE IS SET, AND CENTRAL MEMORY INITIALIZATION HAS BEEN SELECTED BY THE OPERATOR, OR AUTOMATICALLY SET BY THE HARDWARE. DEADSTART AND CLEAR ALTERNA- TE PP DISABLE, OR DO NOT SELECT MAINFRAME INITIALIZATION.	Selection of the M option after selecting power-on initialization is only allowed when word 12 of the deadstart program directs CTI to initialize the alternate PP. Select the desired option and redeadstart.	CTI
MSL STARTING CYLINDER UNUSABLE	Indicates that the starting cylinder and the two succeeding cylinders are unsuitable for a maintenance-only installation. A deadstart is required to reattempt the installation at another cylinder.	TDX
MSL STARTING CYLINDER UNUSABLE ENTER -CR- TO USE ALTERNATE CYLINDER yyyy OR RELOAD TDX AND SELECT A NEW CYLINDER	Indicates that the starting cylinder is unusable, although one of the two succeeding cylinders is suitable for the operation. The yyyy is the cylinder which TDX has found to be suitable. Entering a CR allows TDX to prepare cylinder yyyy for the operation. Entering any other character allows TDX to request another starting cylinder.	TDX
NOTE		
If the user is saving a command buffer library at cylinder xxxx, TDX displays the message IMPOSSIBLE TO INSTALL PROGRAMS AND SAVE COMMAND BUFFER AREA and does not examine the two succeeding cylinders.		
xxxxxxx NAME TOO LONG	Indicates that TDX has detected a program or command buffer name on tape that contains more than seven characters. The xxxxxxx in the message is the first seven characters of the name that is too long. Entering a space bar allows TDX to skip to the next program or command buffer and continue the operation.	TDX, IUC

Message	Description	Reporting Module
NM=xxx	CTI module xxx not found.	CTI
NO CM AVAILABLE	An HIVS test is selected for which hardware is turned OFF via CTI or is physically not present.	I/O Driver
NO CP AVAILABLE	An HIVS test is selected for which hardware is turned OFF via CTI or is physically not present.	HIVS
NO PP AVAILABLE	An HIVS test is selected for which hardware is turned OFF via CTI or is physically not present.	HIVS
xxxxxxx NO TAPE WRITE RING	Indicates that a disk-to-tape copy is being attempted and that no write ring is being detected on the tape. You may, upon seeing the NO TAPE WRITE RING message, unload and dismount the tape, insert a write ring into the tape hub, and mount and reload the tape. When you press the space bar, the tape is positioned at the beginning of tape and the copy proceeds. The xxxxxxx is the name of the program or command buffer with which TDX was working.	TDX, IUC
xxxxxxx NOT COPIED - END OF TAPE	Indicates TDX encountered the end-of-tape while writing program xxxxxxx in a disk to tape copy. TDX backspaced the tape and wrote end-of-information and file marks to the tape before displaying the message. A deadstart is required.	TDX, IUC
xxxxxxx NOT FOUND	Indicates that TDX has not been able to locate a program or command buffer for which it has been searching. The xxxxxxx in this message is the name being searched for. In the case of a tape-to-disk copy, the TDX search is initiated by a COPY FROM request. In the case of a disk-to-tape copy, the TDX search may be initiated by either a COPY FROM or COPY THRU request. For a COPY THRU request, TDX begins the search with the program entered for the COPY FROM message. Pressing the space bar returns TDX to the copy message that contains the unknown name.	TDX, IUC

Message	Description	Reporting Module
OFFLINE MAINTENANCE NOT AVAILABLE	The M option was selected from the Initial Options display after deadstart from a HIVS/CIP tape.	CTI
OPERATING SYSTEM FILE NOT FOUND ON DEVICE. ENTER ALTERNATE DEVICE	The deadstart file does not contain the operating system. Enter an alternate device or install the operating system on the same device and redeadstart.	CTI
PACKET COMMUNICATION ERROR	An error was encountered when CTI attempted to send a packet to the intelligent console.	CTI
PACKET TRANSFER ERROR TO IOU1 ERROR CODE - xx	Error Codes 1 = CHECKSUM ERROR 2 = ILLEGAL FUNCTION CODE 3 = PACKET TOO LONG 4 = DATA TRANSMISSION ERROR 7 = PP ERROR C = DATA ERROR 10 = CTRL-G EXCHANGE ABORTED 11 = NO START BYTE 12 = PACKET ERROR 13 = TIMEOUT ERROR 14 = BUSY	CTI
PAGE TABLE AREA VERIFY ERROR, (DEADSTART ABORTED) INFORM CE	A data error was detected while doing a one/zeros page check of the central memory area in which the page table is built. Inform CE.	CTI
PARITY ERROR ON DATA RCVD FROM EXT CHANNEL.	S/C register error. Inform CE.	CTI
PARITY ERROR ON DATA XMTD FROM EXTERNAL PP.	S/C register error. Inform CE.	CTI
PNT FULL xxxxxxx	Indicates that the disk PNT is full. The xxxxxxxx in the message is the name of the program or command buffer that filled the PNT. A deadstart is required to clear this message.	TDX
PP HUNG, (CR) TO RETRY	Indicates that communication has been lost with the PP performing the memory dump to printer. Press the carriage return key to attempt to reestablish communication.	CTI
PPnn NOT RESPONDING - FATAL ERROR - DEADSTART ABORTED	PP will not accept idle loop package or a processor (CP or PP) has not completed execution within a predefined time period. Inform CE.	CTI

Message	Description	Reporting Module
PPnn STOPPED ON PARITY ERROR - PPM.	S/C register error. Inform CE.	CTI
PP UNAVAILABLE, (CR) TO RE-ENTER	Indicates that the PP chosen for the PP memory dump option physically does not exist. Press the carriage return key and reenter the desired PP number.	CTI
PPU ERROR.	S/C register error. Inform CE.	CTI
PPU UNAVAILABLE, (CR) TO RE-ENTER	Indicates that the PPU chosen for the PPC memory dump option physically does not exist. Press the carriage return key and reenter the desired PPU number.	CTI
PRINTER BUSY	Indicates that the printer is busy. When the condition clears, the message is erased from the display and HDP execution continues automatically.	CTI
PRINTER NOT READY	Indicates that the printer is not ready to accept HDP output. When the condition clears, the message is erased from the display and HDP execution continues automatically.	CTI
PROCESSOR FAULT STATUS ERROR (DEADSTART ABORTED) INFORM CE	A fault status error was detected while the processor was being initialized. Inform CE.	CTI
PROCESSOR NOT ACCESSIBLE	A processor element is not accessible on the maintenance channel.	CTI
PROCESSOR NOT RESPONDING FATAL ERROR - (DEADSTART ABORTED) INFORM CE	A processor exists, but is not responding to functions on the maintenance channel. Inform CE.	CTI
PROGRAM NOT ON TAPE - mne	The program name was not found when reading the tape.	CTI
READ DISASSY PARITY ERROR.	S/C register error. Inform CE.	CTI
READ PYRAMID PARITY ERROR.	S/C register error. Inform CE.	CTI
S/C REGISTER CHANNEL FULL - FATAL ERROR.	Inform CE.	CTI
S/C REGISTER ERRORS.	This is a header for an SCR error display.	CTI

Message	Description	Reporting Module
SCR ERROR yyyy	The system detected an error in a S/C register during hardware verification (HIVS). Inform CE.	HIVS
SECDDED DOUBLE BIT ERROR - QUADRANT xx, CSU y	S/C register error. Inform CE.	CTI
SECDDED SINGLE BIT ERROR - QUADRANT xx, CSU y	S/C register error. Inform CE.	CTI
xxxxxx SCSI ERR STATUS=YYYY.Task=ZZZZ MMMM DETAILED STATUS BLOCK SAS= ISS= TSS= SCPS= AXS= FFMT PLLEC= LAF=	An error occurred when a program from tape could not be written successfully to the CIP device. The xxxxxx in the message is the name of the program which was being written (copied) to disk, and ZZZZ is the SCSI task being attempted. If YYYY, which is the SCSI general status, equals 0002 (fatal SCSI error), the detailed status block information which follows MMMM will accompany the SCSI error message. ¹ The remaining portion of the message (MMMM) may be one of two messages: CTRL-F2 REQUIRED or SPACE - SKIP TO NEXT PROGRAM. The first message indicates that the error is fatal and that a CTRL-F2 is required. In the second instance, pressing the space key will prompt IUC to skip the program which is currently being transferred and to attempt to transfer the next program.	IUC
SCI NOT IN CIP BUFFER AREA	Indicates that CTI was unable to find SCI in the CIP buffer area of central memory. Ensure that SCI is installed on the Common Disk Area (CDA) of the CIP device and then attempt another deadstart.	CTI

1. If YYYY is not equal to 0002, the detailed status block information will not appear.

Message	Description	Reporting Module
SHUTDOWN IMMINENT.	S/C register error. Inform CE.	CTI
SMU x ERROR.	S/C register error. Inform CE.	CTI
SR-0-2 yyyy yyyy yyyy yyyy yyyy. SR-0-1 yyyy yyyy yyyy yyyy yyyy yyyy. SR-0-0 yyyy yyyy yyyy yyyy yyyy yyyy. DEADSTART ABORTED - FATAL ERROR.	S/C register error. This message indicates that the system detected a fatal error during confidence testing. Inform CE.	CTI
SRT FULL xxxxxxxL	Indicates that the disk SRT has reserved the entire available area on the disk. The xxxxxx in this message is the name of the program or command buffer that filled the disk. A deadstart is required to clear this message.	TDX
STATUS BIT ERROR	The system detected an error when the side door port was statused following a master clear during memory initialization. Press the DEADSTART switch to return to the Initial Options display. If the message reappears, inform CE.	CTI
STATUS ERROR STATUS=xxxxxx	The General Status Word received from the SCSI driver indicates an error. Refer to the CYBER Systems Peripheral Diagnostics Reference Manual (60000144) for error code definitions.	CTI
xxxxxxx TAPE ERR STAT yyyy	Indicates that the status received from the tape drive shows that an error condition exists. The xxxxxx in this message is the name of the program or command buffer that TDX was working with when the error occurred, and yyyy is the octal status word. Pressing the space bar allows TDX to attempt to continue the operation, though the result may not be reliable.	TDX, IUC

Message	Description	Reporting Module
xxxxxxx TAPE FUNC REJ yyyy	Indicates that a function sent to the tape drive or data channel converter (60X or 65X) has not been accepted. The xxxxxxx in this message is the name of the program or command buffer that TDX was working with when the error occurred, and the yyyy is the octal value of the function code that was rejected. TDX tries the operation three times (including timeouts) before displaying the message. Press the space bar to allow TDX to retry the operation.	TDX, IUC
TAPE ON UNIT XX NOT RECOGNIZED (CR) TO CONTINUE	The tape mounted on unit XX does not contain an IDC record which CTI recognizes. Press the Enter key to return to the UTILITIES display. If another install option is selected, mount a different tape on unit XX, or select a different tape unit.	CTI
TAPE STATUS ERROR STATUS = xxxx	The general status word xxxx received from the tape indicates an error condition exists. Press the carriage return key to retry.	CTI
TPM FUNCTION TIMEOUT	The TPM function timed out.	PAK
xxxxxxx TAPE UNIT NOT READY	Indicates that the status received from the tape drive shows that the unit is not ready. The xxxxxxx is the name of the program or command buffer with which TDX was working. Correct the not ready condition without moving the tape and press the space bar to continue.	TDX, IUC
UNABLE TO ACCESS CPU VIA MAINTENANCE CHANNEL. ENTER (CR) TO CONTINUE, OR DEADSTART AND INFORM CE.	CTI was unable to access any CPU during initialization for printer dumps via HDP. Enter (CR) to perform PP or IOU register dumps only, or inform CE.	CTI
UNABLE TO ACCESS DISK (CR) TO PROCESS DIFFERENT DEVICE	Not able to access specified device. Press the carriage return key to select a different device or deadstart to exit.	CTI

Message	Description	Reporting Module
UNABLE TO ACCESS PORT (CR) TO RETRY	The system was unable to access ESM during memory initialization using the specified channel and equipment. Press the carriage return key and reenter the channel and equipment numbers.	CTI
UNABLE TO ACCESS TAPE (CR) TO PROCESS DIFFERENT DEVICE	Not able to access specified device. Press the carriage return key to select a different device or deadstart to exit.	CTI
UNABLE TO DETERMINE THE MACHINE TYPE ENTER 1 FOR 962, 2 FOR 992	Following a request to install the DFT modules, an attempt was made to determine the machine type by reading the maintenance register. However, as a hardware problem prevented the maintenance register read from happening, you must enter either a 1 (if your computer system is a CYBER 962) or 2 (if your computer system is a CYBER 992).	IUC
UNABLE TO EXECUTE COMMON DISK AREA REQUEST. CDA HAS NOT BEEN INITIALIZED. DEADSTART REQUIRED.	With the release of CIP V006, an initial install is required before any CDA utility can be executed. Subsequent CIP releases do not require this initial build.	CTI
UNABLE TO EXECUTE COMMON DISK AREA REQUEST. CDA HAS NOT BEEN INITIALIZED. (CR) FOR OPTION DISPLAY	With the release of CIP V006, an initial install is required before any CDA utility can be executed. Subsequent CIP releases do not require this initial build.	CTI
UNABLE TO INSTALL CIP READ ONLY SWITCH ACTIVE	An attempt to install CTI to an FMD disk drive, CTI found the read-only switch depressed. Toggle the read-only switch.	CTI
UNABLE TO LOAD MDD. THE INTEGRITY OF CENTRAL MEMORY HAS BEEN COMPROMISED.	MDD checksum failed.	CTI
UNABLE TO PERFORM -UPDATE- INSTALL. COMMON DISK AREA NOT INITIALIZED. DEADSTART AND SELECT AN -INITIAL- CIP INSTALLATION.	With the release of CIP V006, an initial install is required before any other build can be executed. Subsequent CIP releases do not require this initial build.	CTI
UNAVAILABLE	Operator has attempted to set the logical state of an I4 CIO PP, but none are installed.	CTI

Message	Description	Reporting Module
USER CONDITION REGISTER=xxxx	During central memory initialization, a nonzero user condition register appeared in the job exchange package after reverting to monitor mode. Inform CE.	CTI
UNUSABLE DISK	Indicates that the default starting cylinder for a HIVS installation is faulty. The operator must deadstart and perform the installation to a different device.	TDX
VE BOOTS NOT ON ASSIGNED TAPE	The currently assigned tape, which could either be a CIP tape or an OS deadstart tape, was supposed to contain VE boots. Restart the program to clear the error.	IUC
VERIFY CM DATA ERROR	Indicates CTI encountered errors when verifying EI data written to central memory. Inform CE.	CTI
VSN=vvvvvv FILE NOT EXPIRED	The HDR 1 label of the tape contains an expiration date greater than today's date, as indicated by either the calendar/clock chip or operator input. An unlabeled or expired tape must be used.	EDD
WRITING MEMORY	Each available word of central memory is written with two patterns, checking for errors on each pass. The duration of the message is a function of central memory size.	CTI

Field Change Announcement (FCA) Interpretation for Model 800 Computer Systems

C

The purpose of the FCA chart is to communicate the levels of maintenance software, hardware, CIP, and operating system software (system elements) that have been tested and certified by Control Data to function correctly together. Each model 800 computer system has its own FCA. The chart is distributed monthly to FCO distribution and Control Data Engineering Services support personnel, and also accompanies each FCO. FCOs are sent to the CE responsible for the site.

Each mainframe's FCA indicates the baseline components for the machine; that is, the system element levels for the machine at first field availability. The FCA index at that time is 1. A change in one of the system elements is reflected as a new line on the FCA. Only when the change requires a change to another system element or when microcode is changed is the FCA index incremented.

The chart presents the information in grid format, which allows for little verbal explanation. Short comments are provided on the form. Additional information is provided on the ARIES system, which is accessible by the CE.

Figure C-1 shows a sample FCA chart and includes abbreviated definitions of the chart entries.

Control Data certifies that the hardware at the current FCO level works with the current levels of maintenance software, the current level of the CIP, and current level of operating systems. Control Data also ensures that operating systems released within the last 12 months will work with the current hardware level. The levels of hardware and software that are certified to work together are commonly referred to as plug and play levels.

If you have questions regarding a particular combination of system components, contact Arden Hills Field Support [Controlnet 235-3074, 800-328-9567, or (612) 482-3074] for help.

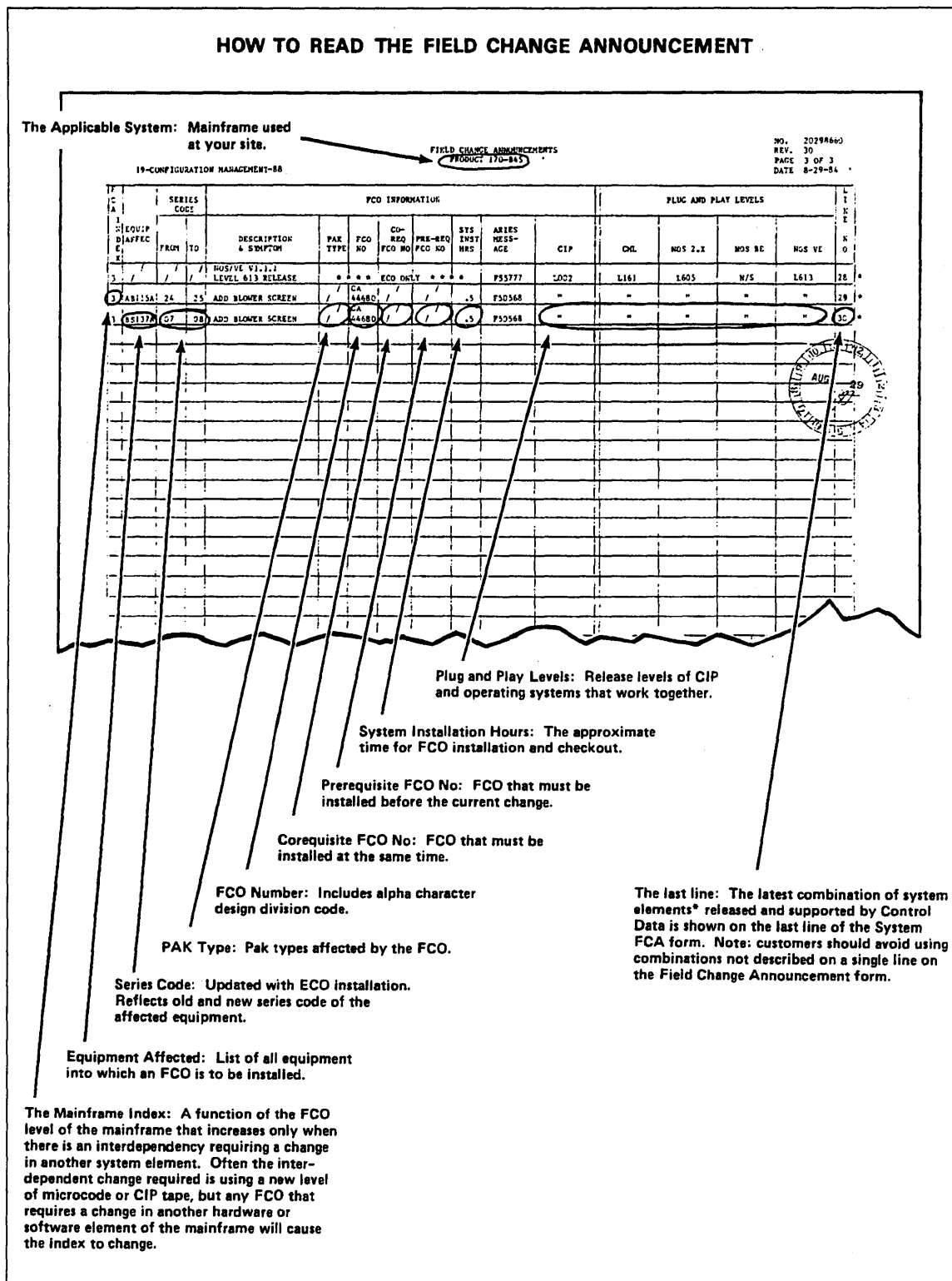

Figure C-1. How to Read the FCA Chart

The CIP contains hardware and software components. Hardware problems are reported differently than software problems: The TAR is the primary mechanism for reporting hardware problems; the PSR is the primary mechanism for reporting software problems. Eventually, one form will be used to report both types of problems. Until that time, report problems as you currently do:

- If a hardware problem occurs, write a TAR.
- If a software problem occurs (either maintenance software, console software, deadstart-time software, or operating system software), write a PSR.

NOTE

For sites with a CC598A/CC598B console, be sure to include the Fault Symptom code (if available) when reporting a console software problem. Also, if you have a console printer, and if the problem you are experiencing is related to a console display(s), it is very helpful to have a printout of the problem (via the print screen function).

When CIP problems are fixed, the release vehicle of the solution is a new CIP release.

Hardware Initialization Verification Software (HIVS) Tests

E

The following tests, listed in alphanumeric order, are associated with the HIVS. Each test is briefly described.

BMEM - PPU MEMORY TEST

BMEM tests the ability of the PPU to run four word loops, with a data pattern included in the loop.

CMC - CENTRAL MEMORY CONFLICT PROGRAM

CMC compares one 12-bit word at a time with a known pattern until five words are checked. Those that do not compare produce an error message.

CMC7 - CENTRAL MEMORY CONFLICT TEST

CMC7 is similar to the CMC test. It is used with the CYBER 170 models 865 and 875.

CT3 - RANDOM INSTRUCTION TEST WITH SIMULATION

CT3 tests random instructions by generating random numbers to determine what values are used.

CT7 - CYBER 170, MODEL 175, RANDOM COMMAND TEST

CT7 tests the CPU control and the functional units. It generates and executes random instructions and operands, and checks the results against a second set of answers obtained from a simulator using other functional units.

CT73 - RANDOM INSTRUCTION TEST

CT73 is a random instruction test. In normal mode, it generates and executes random instruction sequences and random operands; it then checks the results against a second set of answers obtained from a simulator that uses other functional units. In ZIP mode, it forms a checksum from the output exchange package after each pass; it then adds this checksum to the checksum from the previous pass.

CT77 - RANDOM INSTRUCTION TEST

CT77 is similar to the CT73 test. It is used with CYBER 170 models 865 and 875.

CT8 - RANDOM INSTRUCTION TEST WITH SIMULATION

CT8 is similar to the CT3 test. It is used with models 810 through 860.

EJP - GO/NO GO EXCHANGE JUMP TEST

EJP is a go/no go test of the exchange hardware normally executed by HIVS. The test runs in any selected area of CM.

IRT - INTERLOCK REGISTER TEST

IRT tests the performance of the CYBER 70 Computer Systems interlock register and interlock channels.

LCM4 - LARGE-CORE MEMORY TEST

LCM4 detects large-core memory failures that originate in the marginal or defective LCM stack and/or logic circuits related to it.

MY1 - 65K AND 131K CENTRAL MEMORY TEST

MY1 performs data-only checks of central memory (65K and 131K). MY1 halts at address RA+132.

MY17 - 65K AND 131K CENTRAL MEMORY TEST

MY17 is similar to the MY1 test. It is used with CYBER 170 models 865 and 875.

PCX - PPU COMMAND TEST

PCX tests all instructions (other than I/O) in the PPs of the system. Each PP is checked using 100 instructions.

PCX7 - PPU COMMAND TEST

PCX7 is similar to the PCX test. It is used with CYBER 170 models 865 and 875.

SSMC - SMALL SEMICONDUCTOR CONTROL TEST

SSMC checks the control logic of the small semiconductor memory (SSM) and its related area. The test does not stress memory stack.

Peripheral Processor (PP) Configurations F

Table F-1 shows the channels that are not connected to an active PP for 6000 Computer Systems, CYBER 70 models 71, 72, 73, and 74, and CYBER 170 and CYBER 180 Computer Systems for the various PP configurations. A dash in the table indicates that the PP configuration for that system is not possible.

For 7, 8, 9, and 10 PP configurations, channels 0 through 13 (octal) are available. For 14, 17, and 20 PP configurations, channels 0 through 13 (octal) and 20 through 33 (octal) are available. Channel 0 is connected to an inactive PP. The other channels shown in table F-1 are not connected to a PP.

Table F-1. Channels That Are Not Connected to an Active PP

System	7	8	9	10	14	15	17	20
6200	0,5,6, 7,12,13	0,6,7, 12,13	0,7, 12,13	0,12,13	0,3,6,7, 12,13,23, 26,27,32, 33	-	0,12,13, 23,26,27, 32,33	-
6400	0,5,6, 7,12,13	0,6,7, 12,13	0,7, 12,13	0,12,13	0,3,6,7, 12,13,23, 26,27,32, 33	-	0,12,13, 23,26,27, 32,33	0,12, 13,32, 33
6500, 6600, 6700	-	-	-	0,12,13	0,3,6,7, 12,13,23, 26,27,32, 33	-	0,12,13, 23,26,27, 32,33	0,12, 13,32, 33
CYBER 71,72, 73,74	-	-	-	0,12,13	0,3,6,7, 12,13,23, 26,27,32, 33	-	0,12,13, 23,26,27, 32,33	0,12, 13,32, 33
CYBER 170 Except Models 815, 825,835, 845, and 855	-	-	-	0,12,13	0,12,13, 24,25,26, 27,30,31, 32,33	-	0,12,13, 27,30,31, 32,33	0,12, 13,32, 33

(Continued)

Table F-1. Channels That Are Not Connected to an Active PP (Continued)

System	7	8	9	10	14	15	17	20
CYBER 170 Models 815, 825, 835, 845, and 855	-	-	-	0,12,13	-	0,12, 13,25, 26,27, 30,31, 32,33	-	0,12, 13,32, 33
CYBER 180 Models 810 through 860 and 990	-	-	-	0,12,13	-	0,12, 13,25, 26,27, 30,31, 32,33	-	0,12, 13,32, 33

NO 21 AND 22 ARE CONNECTED TO CHANNELS

INACTIVE FIRST 3 WORDS ARE ZERO.

~~NO 23 AND 24 ARE CONNECTED TO CHANNELS~~

For most systems there are two types of reconfiguration possible: reconfiguration using CTI, and physical reconfiguration using the deadstart panel switches on the mainframe or reconfiguration commands on the Initial Deadstart display. The type of problem that has occurred determines which reconfiguration, if any, is possible. For information on reconfiguration using CTI refer to the Hardware Reconfiguration display for your model of computer system in this manual. Physical reconfiguration information is contained in this appendix.

When you have a hardware problem that does not allow deadstart to complete, you may want to change the system so that you can continue running. This can be done by reconfiguring the PPs. Refer to PP Reconfiguration, next, for more information on deadstart panel PP reconfiguration. You can also decrease the amount of central memory, making a particular part of the memory inactive. Refer to CM Reconfiguration for CYBER 170 Computer Systems, later in this appendix for more information.

PP Reconfiguration

The system associates a number with each PP. For a given hardware configuration, the system always associates the same number with each PP. This number is called the logical PP number.

Reconfiguring the hardware causes a change in the logical PP number assignment. When the computer system is fully operational, logical PP0 is associated with physical PP0 memory. You can reconfigure the PPs by assigning a different physical PP as logical PP0 using switches on the deadstart panel for all models except models 815 and 825. You can reconfigure PPs on models 815 and 825 by using the PP reconfiguration commands when the Initial Deadstart display appears on the console screen.

Within the hardware, PPs are grouped for orderly processing of PP instructions. Each group is called a barrel and has 4, 5, 7, or 10 PPs. Contact site personnel for more information on barrels.

For the standard physical configuration (except for models 810, 815, 825, 830, and 990), set the barrel switches to the first barrel and the PP switches (when present) to the first PP within the first barrel. For models 815 and 825, use the commands RB x and RP xx (refer to Model 810, 815, 825, 830, and 990 PP Reconfiguration later in this appendix). Normally, when the system is running, the deadstart panel (Initial Deadstart display for models 810, 815, 825, and 830) is set to the standard physical PP configuration. When you reconfigure, the logical numbers for all PPs change. For example, on a 20-PP system if you reconfigure so that PP0 is the PP that was associated with physical PP number 20₈ in the standard configuration, the shift shown in figure G-1 occurs.

In the new configuration, the PP previously associated with the physical PP number 20₈ is now PP0. To get the reconfigured logical PP number assignments, exchange the numbers on the right of the first barrel in the first diagram of figure G-1 with the numbers on the right of the second barrel. This exchange is shown in the second diagram of figure G-1.

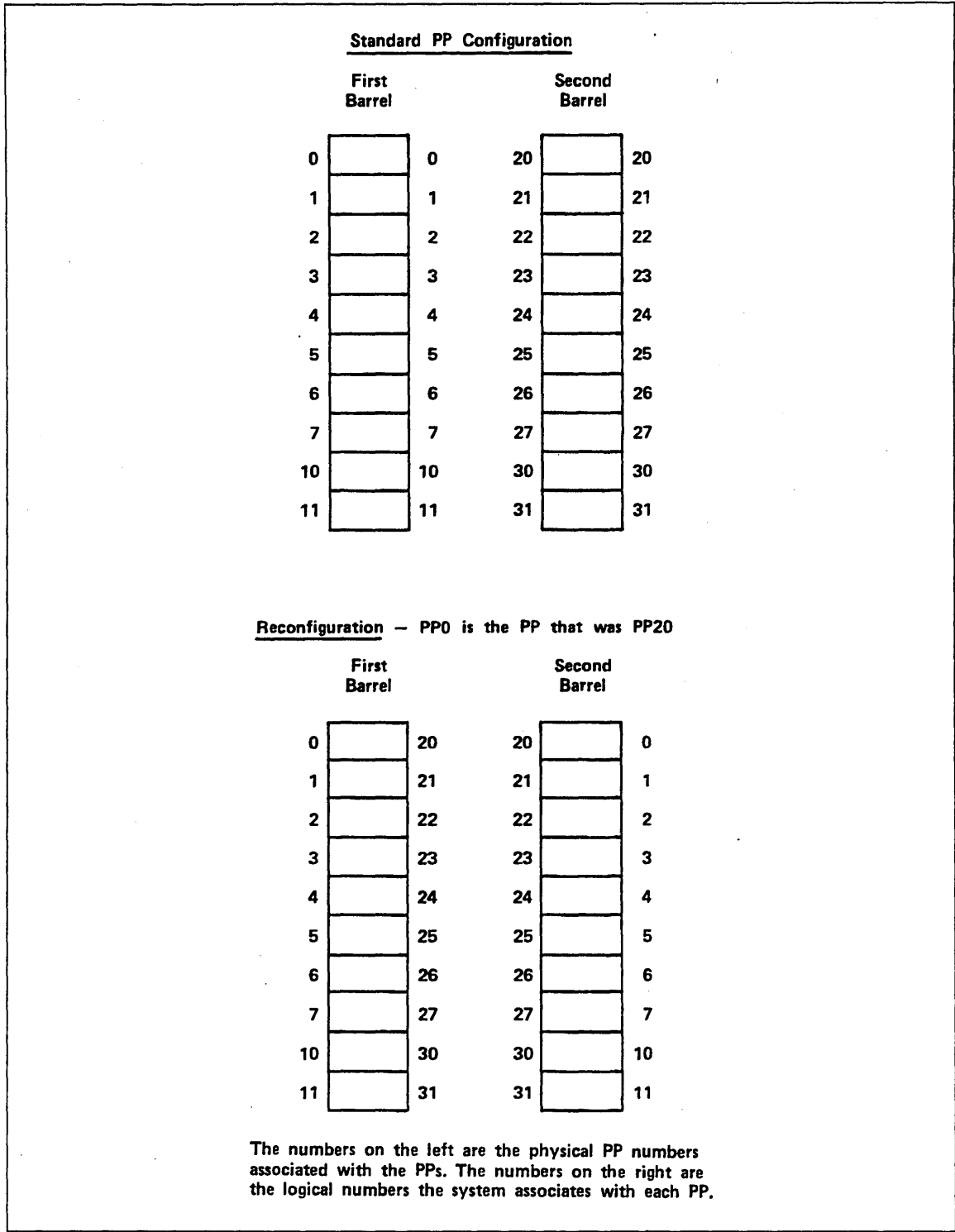

Figure G-1. Sample Reconfiguration

Turning Off PPs

You cannot turn off the hardware for PPs. Using CTI, you can logically turn off PPs capable of accepting the instruction needed to idle them. Refer to the Hardware Reconfiguration display in the section of this manual for your model of computer system.

PPs 0, 1, 2, and 10 must be on and functioning in order to deadstart. If one or more of these PPs are not functioning, you can reconfigure the PPs so that the system does not associate the bad PP with the logical PP numbers 0, 1, 2, or 10. Then you can deadstart and turn off the bad PP. For example, on a 20-PP system under the standard PP configuration, if PP2 is not functioning you can reconfigure the PPs so that PP20 becomes PP0 (refer to figure G-2). The bad PP is now numbered 22. You can turn off PP20 and continue operating.

CYBER 70/6000 Computer Systems PP Reconfiguration

You can reconfigure the CYBER 70/6000 Computer Systems that have 14, 17, or 20 PPs (refer to table G-1). Use the deadstart panel switch labeled PPU-A to reconfigure PPs. For the standard PP configuration, the switch is in the up (0-11) position. Put the switch in the down (20-31) position to reconfigure the PPs. This shifts the logical PP numbers so that the system associates PP0 with the PP that is PP20 in the standard PP configuration (refer to figure G-1). Using the PPU-A switch is the only way you can reconfigure the CYBER 70/6000 Computer Systems.

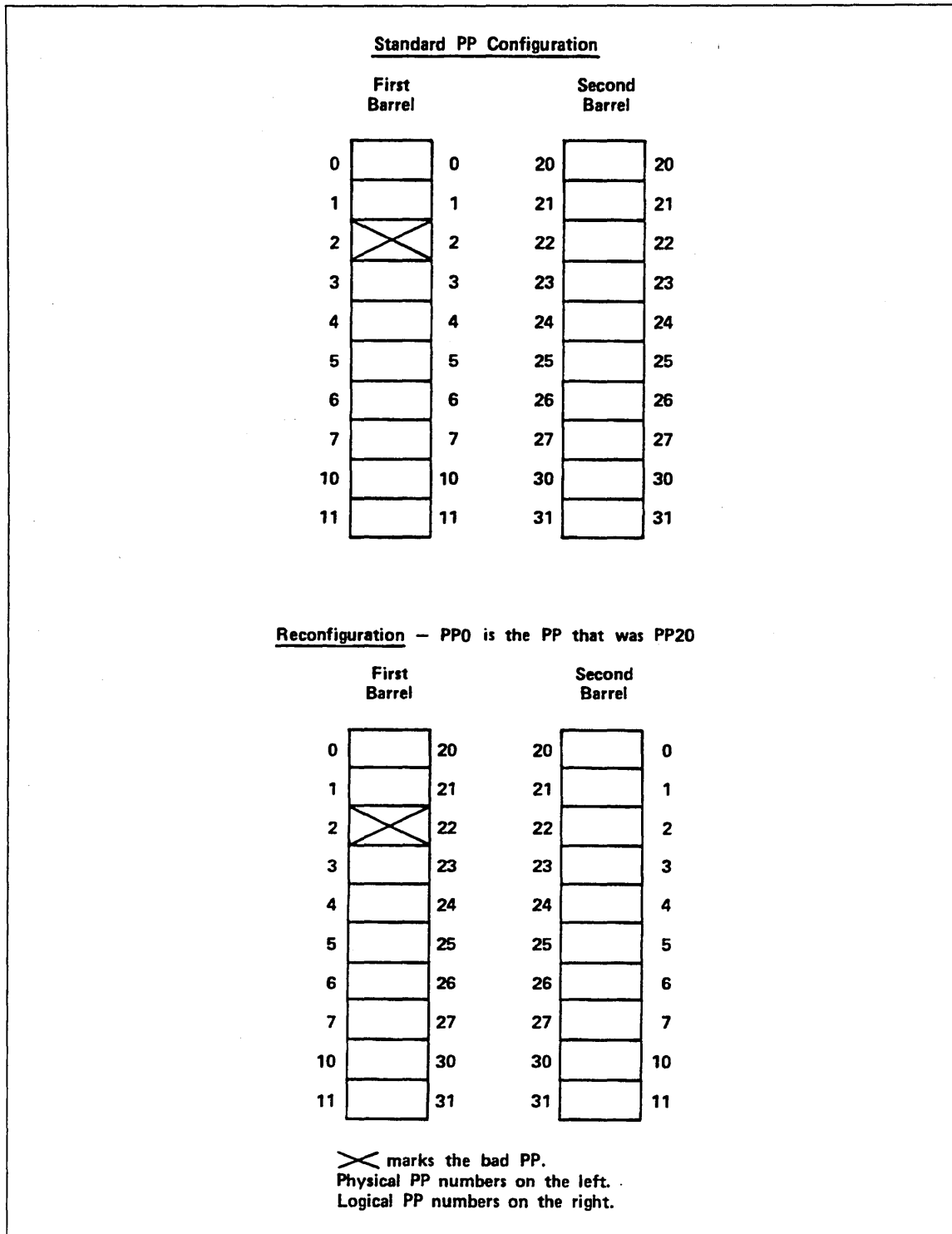

Figure G-2. Sample Reconfiguration for a Bad PP

Table G-1. Deadstart PP Reconfiguration

No. of PPs	6000 and 70	170 Except Models 815, 825, 835, 845, and 855	Models 810, 815, 825, and 830	Models 840, 850, 855, and 860 ¹
10	1. Not possible.	1. Possible. 2. PP MEMORY SELECT switches.	1. Possible. 2. RP xx command. 3. No barrel reconfiguration.	1. Possible. 2. BARREL switches. 3. PP0 --> PP5.
14	1. Possible. 2. PPU-A switch. 3. PP0 --> PP20.	1. Possible. 2. PP MEMORY SELECT switches.	N/A	N/A
15	N/A	N/A	1. Possible. 2. RB x and RP xx commands. 3. PP0 --> PP20 (use RB1).	1. Possible. 2. BARREL switches. 3. PP0 --> PP20. ²
17	1. Possible. 2. PPU-A switch. 3. PP0 --> PP20.	1. Possible. 2. PP MEMORY SELECT switches.	N/A	N/A
20	1. Possible. 2. PPU-A switch. 3. PP0 --> PP20.	1. Possible. 2. PPS-1 PPS-0 ³ switch or IOU-1 IOU-0 switch. 3. PP0 --> PP20.	1. Possible. 2. RB x and RP xx commands. 3. PP0 --> PP20 (use RB1).	1. Possible. 2. BARREL switches. 3. PP0 --> PP20. ⁴

1. You can also reconfigure using the PPM switches.

2. Set the BARREL switches to the second barrel (setting 01) to shift PP0 to the PP that was PP20.

3. You can also reconfigure using the PP MEMORY SELECT switches.

4. Set the BARREL switches to the third barrel (setting 10) to shift PP0 to the PP that was PP20.

CYBER 170 Computer Systems (Except Models 815, 825, 835, 845, and 855) PP Reconfiguration

For a CYBER 170 Computer Systems (except models 815, 825, 835, 845, and 855) with 20 PPs, the most common way to reconfigure PPs is to use the deadstart panel switch labeled PPS-1 PPS-0; IOU-1 IOU-0 for models 865 and 875 (refer to table G-1). The 0 on the switch indicates the first barrel; the 1 indicates the second barrel. For the standard PP configuration, the switch is in the down (PPS-0 or IOU-0) position. To reconfigure, put it in the up (PPS-1 or IOU-1) position. This shifts the logical PP numbers so that the system associates PP0 with the PP that is PP20 in the standard configuration (refer to figure G-1).

To reconfigure a CYBER 170 Computer System (except models 815, 825, 835, 845, and 855) with 10, 14, or 17 PPs, you must shift the logical PP numbers within barrel 0. You can do this using the PP MEMORY SELECT switches on the deadstart panel (refer to figure G-3).

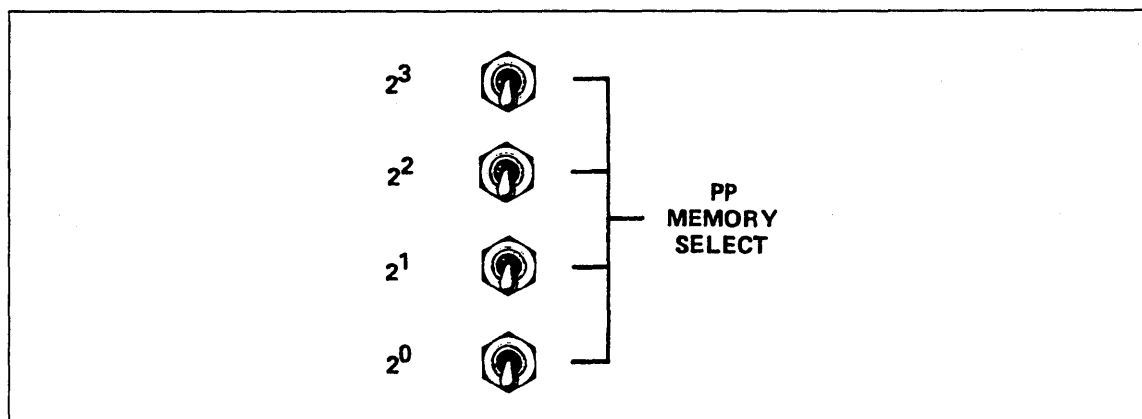

Figure G-3. PP MEMORY SELECT Switches

Choose the standard physical PP number that you want to become logical PP0. Set this number (using binary) on the PP MEMORY SELECT switches. For example, if you choose the number 5, you would set the switches as shown in figure G-4.

This causes the logical numbers of the PPs in the first diagram to shift five positions downward, the bottom numbers shifting to the top.

The following information appears in each box within table G-1.

1. The possibility of reconfiguration: possible or not possible.
2. The name of the switch(es) or commands used for reconfiguration.
3. The shift of PP0 that occurs when you reconfigure using the barrel switch(es) or RB x command. (PP0 --> PP20) means the system assigns PP0 to the PP that was PP20 in the standard PP configuration.)

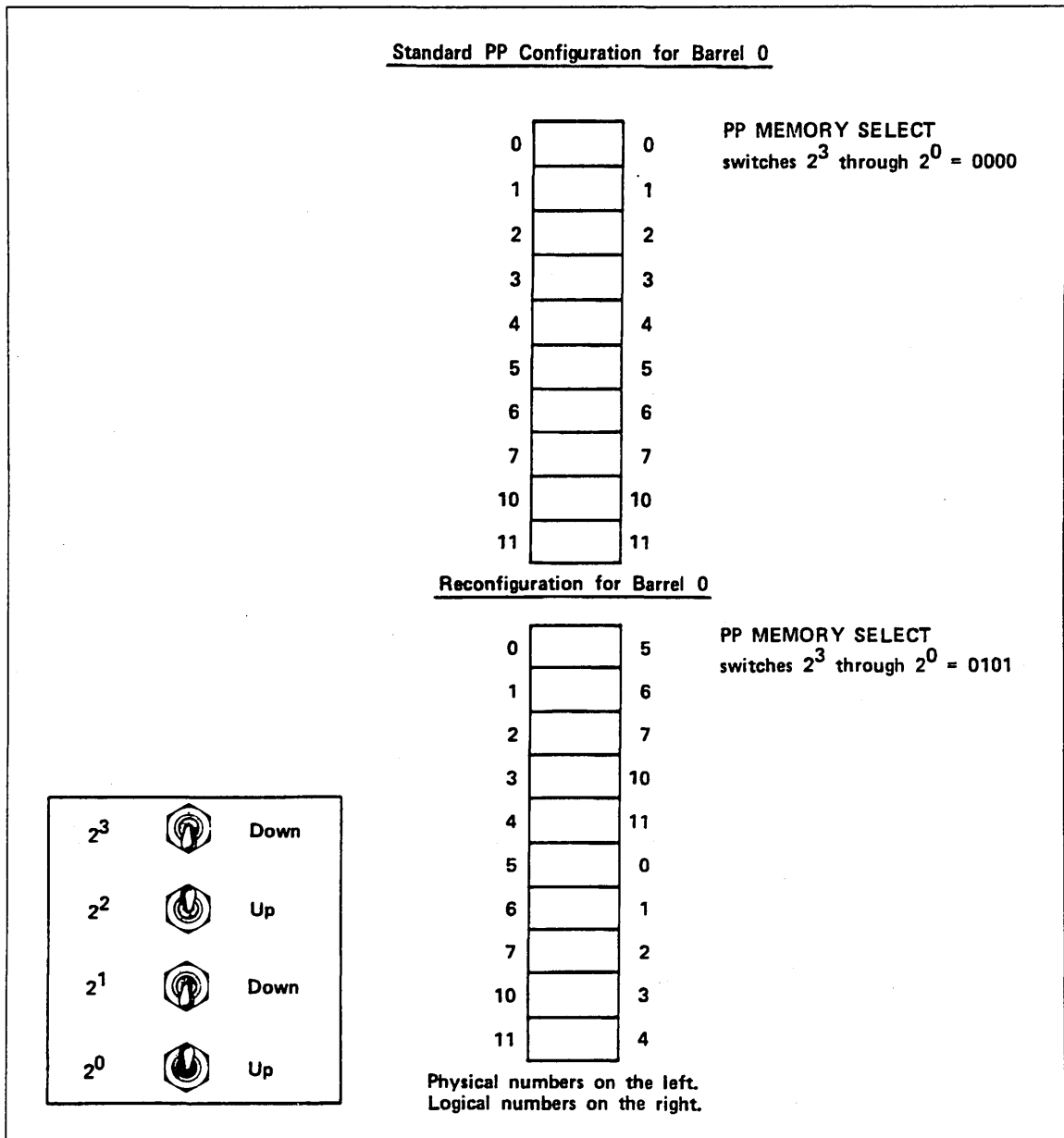

Figure G-4. Reconfiguration of Barrel 0 for CYBER 170 Computer Systems

After reconfiguration, each PP in barrel 0 has a new logical number. You can set the PP MEMORY SELECT switches to a number from 0 (setting 0000) to 11_8 (setting 1001). If you set the switches to any other number, no reconfiguration takes place.

You can also reconfigure CYBER 170 Computer Systems (except models 815, 825, 835, 845, and 855) that have 20 PPs by shifting logical numbers using the PP MEMORY SELECT switches. Set these switches as described in the previous paragraphs. When the PP MEMORY SELECT switches are set to 3 on a 20-PP system, the rotation shown in figure G-5 occurs.

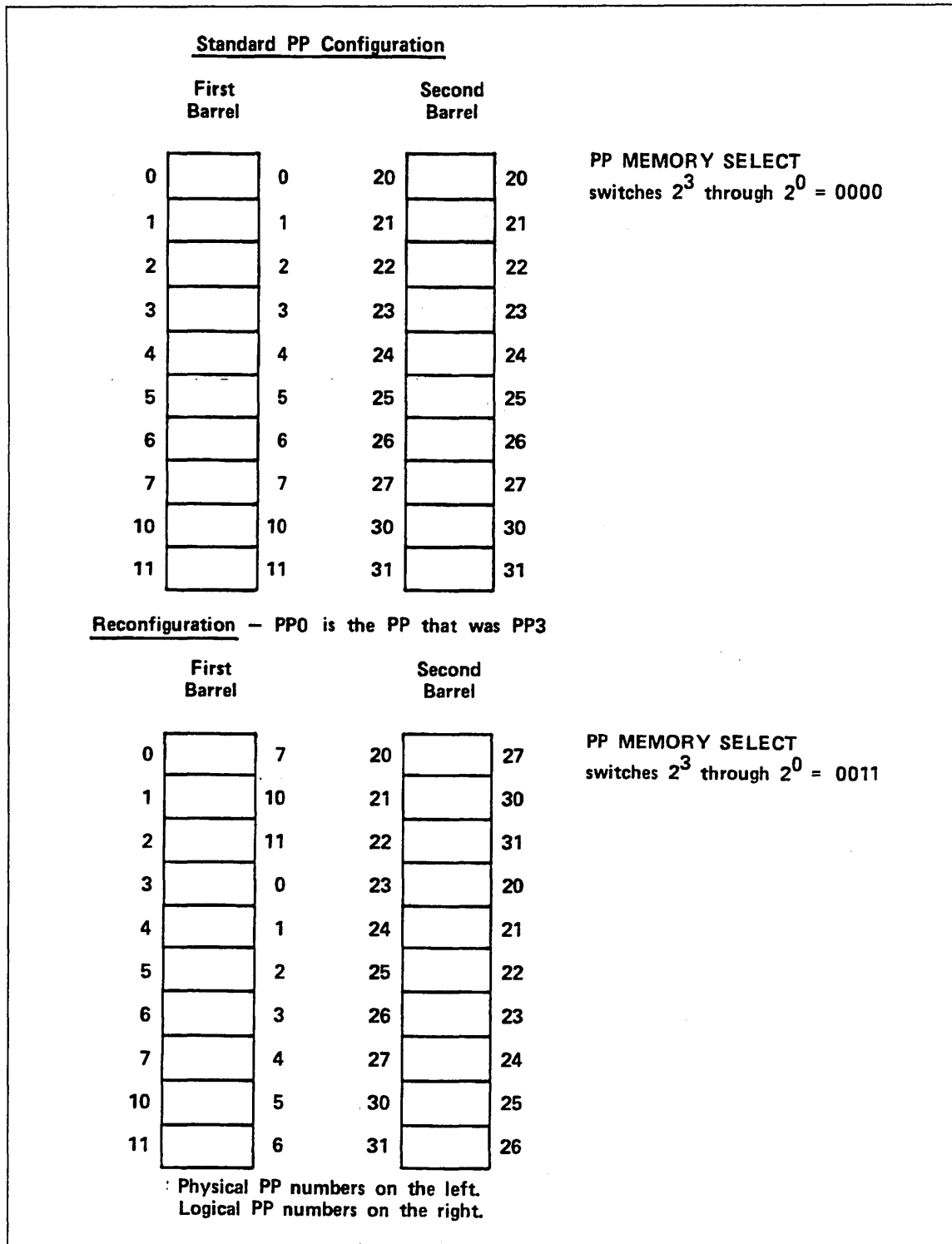

Figure G-5. Sample Reconfiguration Using the PP MEMORY SELECT Switches for CYBER 170 Computer Systems (Except Models 815, 825, 835, 845, and 855)

Models 835 through 860 PP Reconfiguration

For all models 835 through 860, the most common way to reconfigure PPs is to use the deadstart panel switches labeled BARREL (refer to table G-1). The barrels are numbered 0, 1, 10₂, and 11₂, where 0 refers to the first barrel, 1 the second, 10₂ the third, and 11₂ the fourth. For the standard PP configuration, the BARREL switches are set to 0.0. To reconfigure, set the BARREL switches to either 01, 10, or 11, depending on how many PPs you have (there are five PPs in each barrel). For example, to reconfigure on a 20-PP system, you can set the BARREL switches to the third barrel (setting 10). The shift shown in figure G-6 occurs.

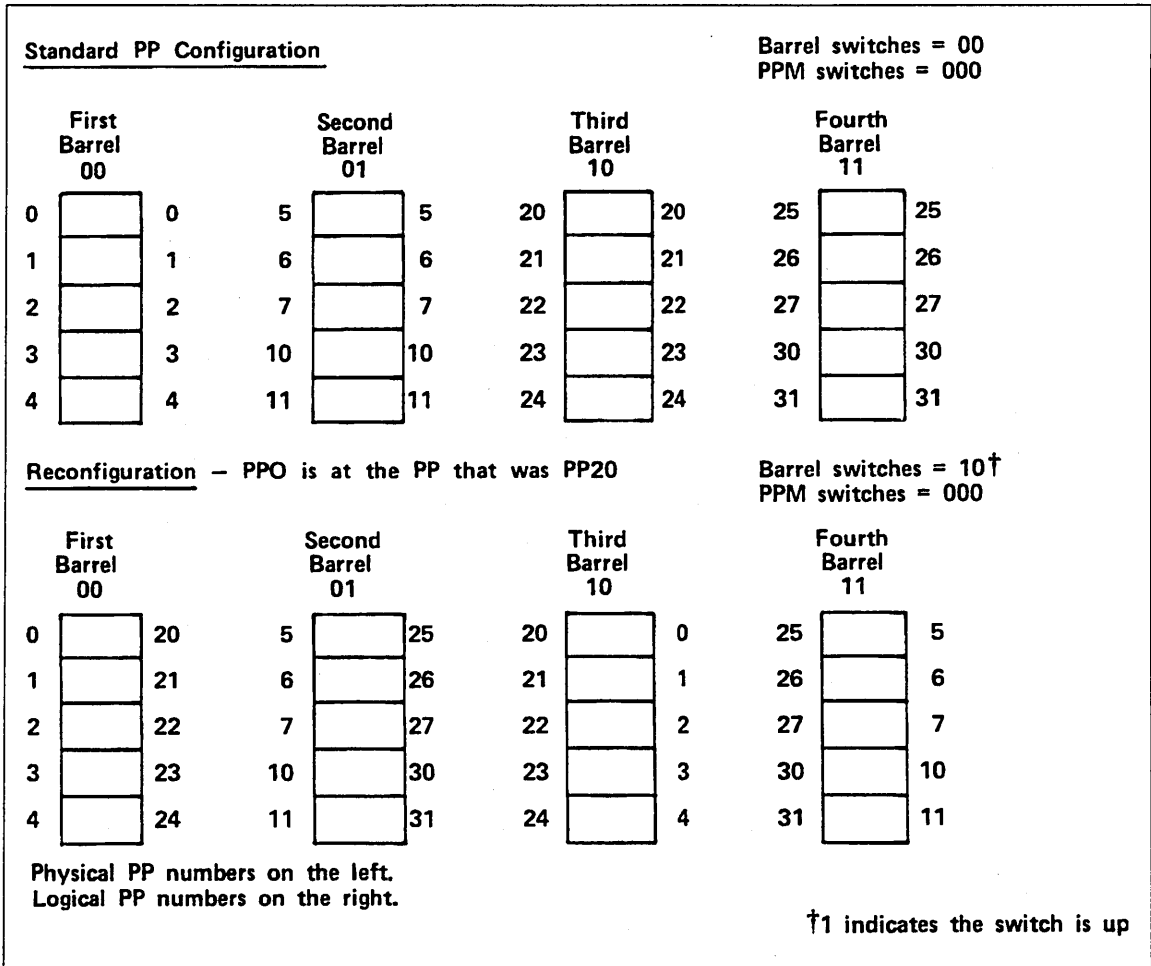

Figure G-6. Sample Model 835 Through 860 PP Reconfiguration

The system associates logical PP0 with the PP that is PP20 in the standard PP configuration.

You can also reconfigure models 835, 845, and 855 computer systems by shifting logical PP numbers within each barrel. You can do this using the PPM switches on the deadstart panel (refer to figure G-7).

Choose the physical PP number that you want to become logical PP0 (numbers 0 through 4). Set this number (using binary) on the PPM switches. For example, if you choose the number 3 you would set the switches as shown in figure G-8.

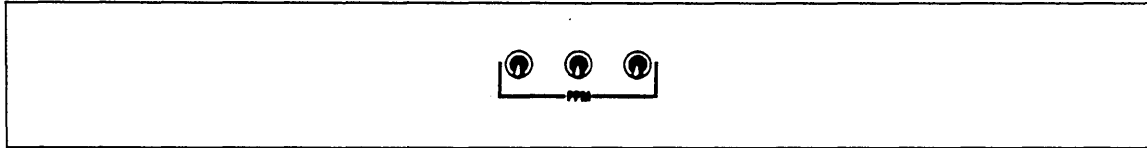

Figure G-7. PPM Switches

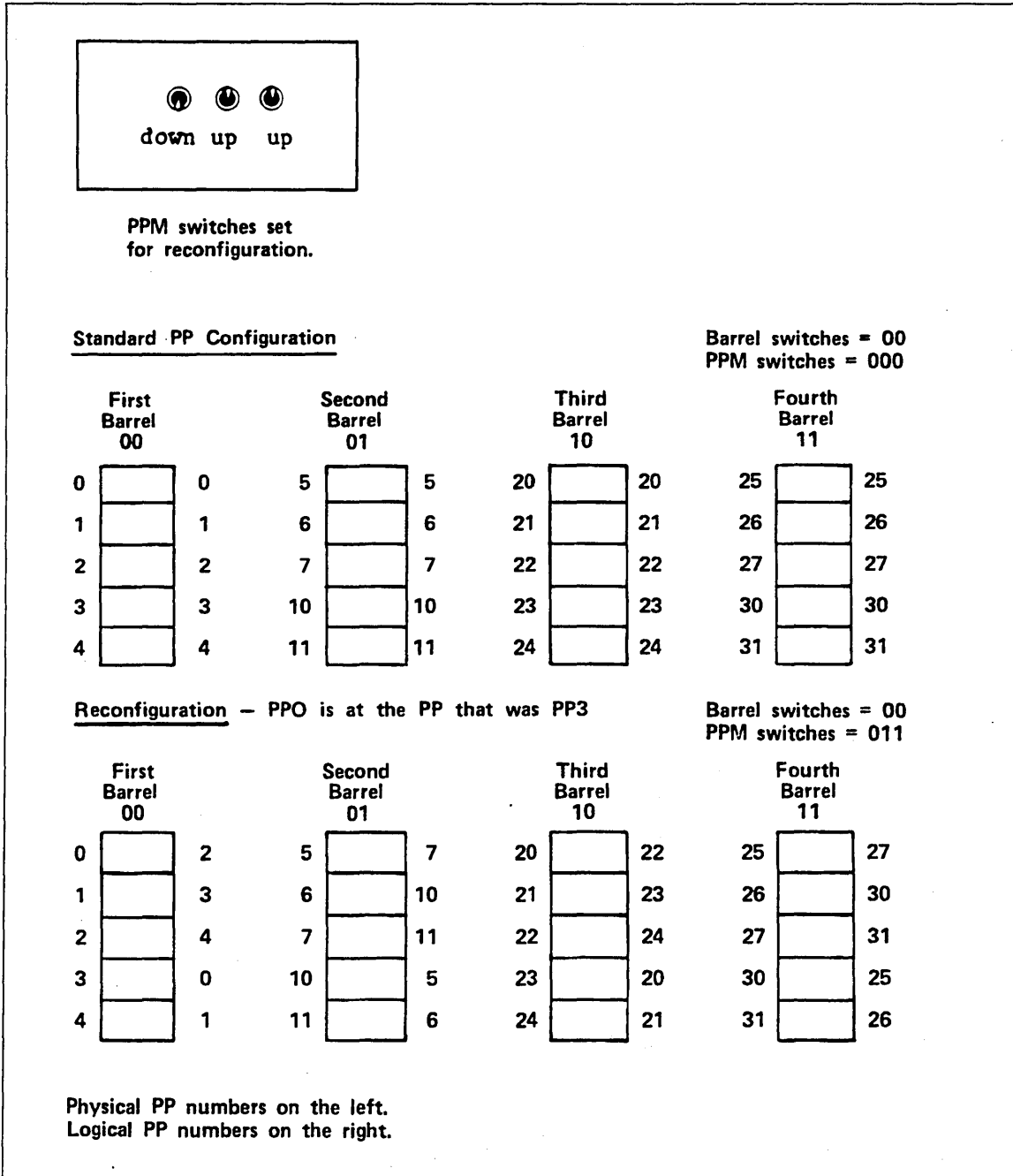

Figure G-8. Sample Model 835 Through 860 Reconfiguration Using PPM Switches

Models 810, 815, 825, 830, and 990 PP Reconfiguration

Models 810, 815, 825, 830, and 990 have one barrel if the system has 10 PPs and two barrels if the system has 15 or 20 PPs. To reconfigure the barrels, bring up the Initial Deadstart display and enter the command:

RB x

x is the number of the barrel (0 or 1) to be used as logical barrel 0 that contains PP0. The number typed appears in the message BRL CONF = near the top of the display. The other barrel becomes logical barrel 1 and contains PP20.

You can reconfigure PP memories within the barrels through the Initial Deadstart display by entering the command:

RP xx

xx is the number of the PP to be used as logical PP0 in the logical barrel 0. It also specifies which PP in logical barrel 1 is to be logical PP20. The value xx appears in the message PPM CONF = at the top of the deadstart display. Allowable values for xx vary with the number of PPs in the system.

Reconfiguring 10-PP System

A 10-PP system has only one barrel containing PPs 0 through 11. You can reconfigure PPs only through the RP xx command. Legal values for xx are octal numbers from 0 to 11. The system rejects values out of this range, nonoctal numbers, and the RB command.

Reconfiguring 15-PP System

A system with 15 PPs has two barrels. In the standard configuration, barrel 0 contains PPs 0 through 11 and barrel 1 contains PPs 20 through 24. Using the RB x command results in interchanging PPs 0 through 4 and 20 through 24 between barrels. PPs 5 through 11 remain in barrel 0. You can reconfigure the PPs within barrels through the RP xx command. Allowable values for xx are 0 through 4. Figure G-9 illustrates PP reconfiguration for models 815 and 825 with a 15-PP system. Models 810 and 830 do not include a 15-PP configuration.

Reconfiguring 20-PP System

A system with 20 PPs has two barrels. In the standard configuration, barrel 0 contains PPs 0 through 11 and barrel 1 contains PPs 20 through 31.

Using the RB x command results in interchanging PPs 0 through 11 and 20 through 31 between barrels. You can reconfigure the PPs within barrels through the RP xx command. Allowable values for xx are octal numbers from 0 to 11. Figure G-10 illustrates PP reconfiguration for a 20-PP system using RB 1 and RP 03.

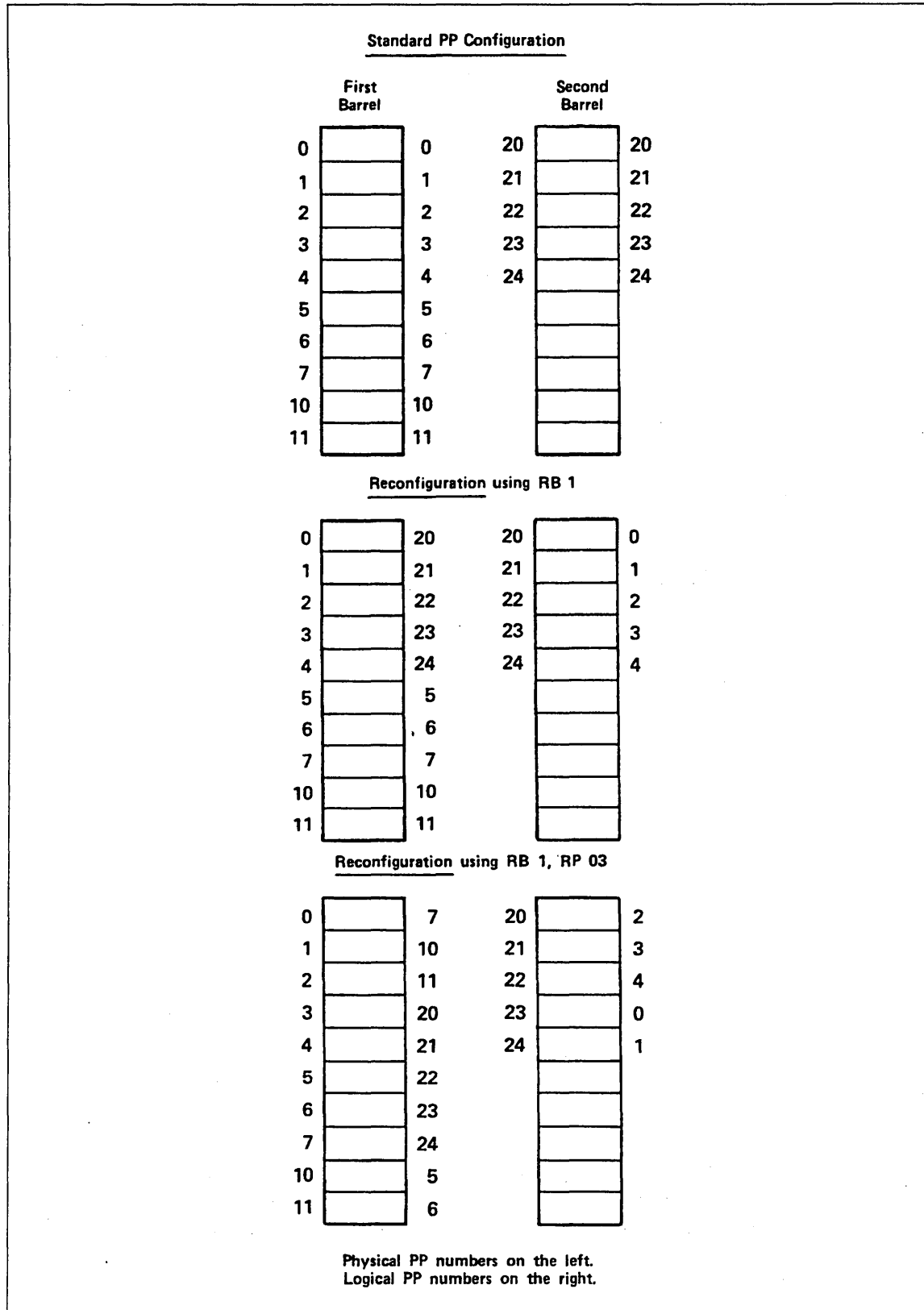

Figure G-9. Sample Reconfiguration for Models 815 and 825 With 15 PPs

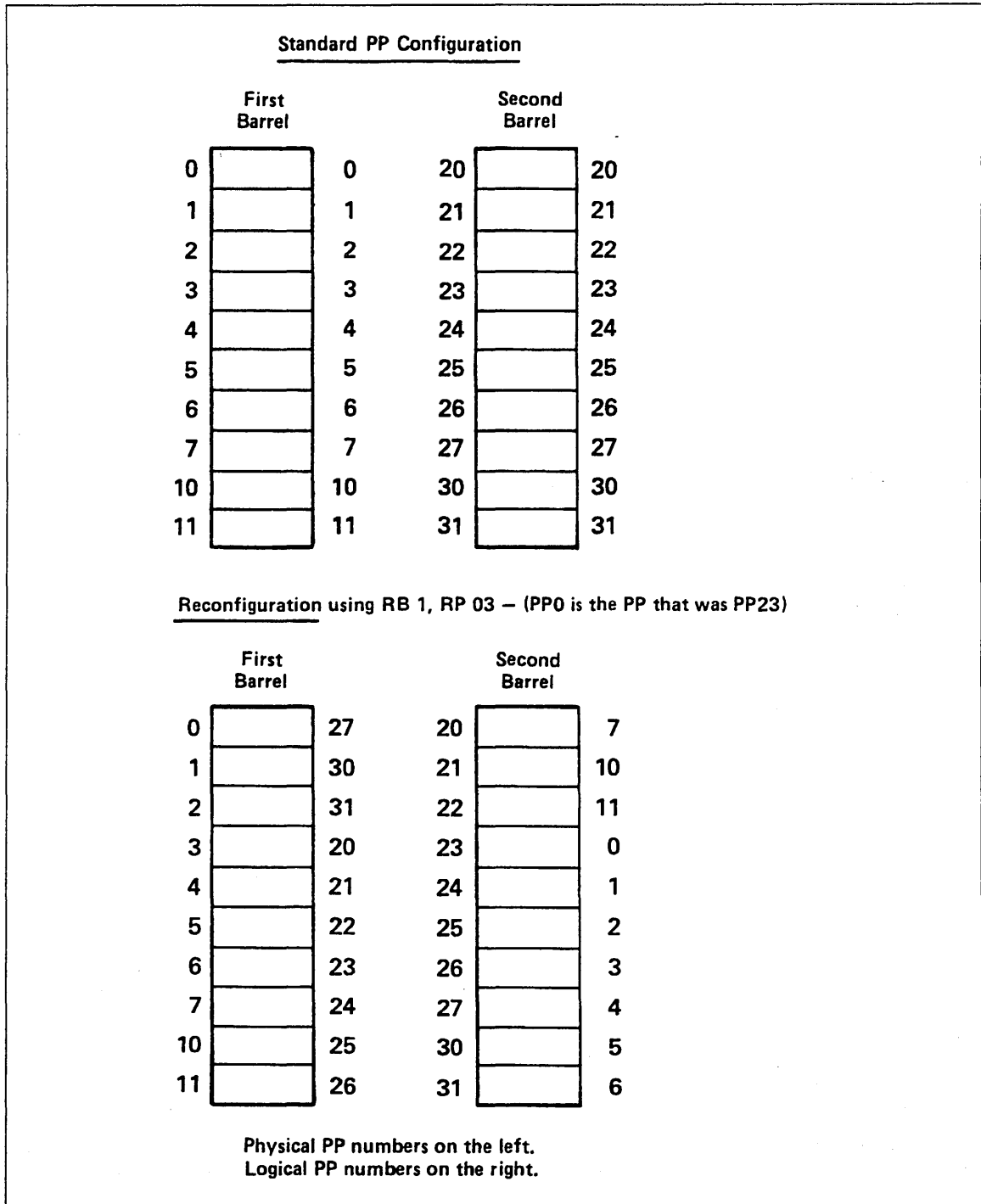

Figure G-10. Sample Reconfiguration for Models 810, 815, 825, 830, and 990 With 20 PPs

CM Reconfiguration for CYBER 170 Computer Systems (Except Models 815, 825, 835, 845, and 855)

This subsection pertains to CYBER 170 computer systems (except models 815, 825, 835, 845, and 855). CM hardware reconfiguration cannot be done on 6000 or CYBER 70 computer systems. For CM software reconfiguration, refer to the Hardware Reconfiguration display for your model of computer system. Refer to CM Reconfiguration for models 815 through 860 later in this appendix for central memory reconfiguration information.

This documentation is valid for reconfiguring central memory down one step only. Any reconfiguration of more than one step down is not recommended.

When it is determined that central memory reconfiguration is desirable, you need to know the following information to reconfigure.

- The CYBER 170 model number.
- The normal total memory size.
- The quadrant number and Control Store Unit (CSU) number (if applicable) of the defective section of memory (usually found in an S/C register¹ error message at deadstart).

To reconfigure central memory, use the following procedure:

1. Locate the CM configuration switches on the mainframe.
2. Locate the correct table for your CPU model (refer to tables G-2 through G-6).
3. Select from that table the correct grouping by locating the normal size of central memory from the CM Before Reconfiguration column.
4. Locate the correct line within the grouping by selecting the quadrant number (and CSU number if applicable) associated with the defective section of memory.
5. Determine the switch number order for the CM configuration switches (refer to figures G-11 and G-12).
6. Compare the settings of the CM configuration switches on your mainframe to the settings shown in the Normal Setting Switch Number column of the line identified in step 4.
7. If the CM configuration switches are shown in the Normal Setting Switch Number column, reset them to the setting shown in the Reconfiguration Setting Switch Number column and deadstart. If the CM configuration switches are not in the normal setting before the attempt to reconfigure, additional reconfiguration is not recommended.

1. For models 865 and 875, S/C registers are maintenance registers.

Table G-2. CM Reconfiguration for Models 171, 172, 173, and 174

CM Before Reconfig- uration	Quadrant	CSU	Normal Setting ¹ Switch Number							Reconfiguration Setting ¹ Switch Number							CM After Reconfig- uration
			1	2	3	4	5	6	7	1	2	3	4	5	6	7	
262K	3	1	0	0	0	0	0	0	0	0	0	0	1	0	0	0	196K
	2	1	0	0	0	0	0	0	0	0	0	0	1	0	0	1	
	1	1	0	0	0	0	0	0	0	0	0	0	1	0	1	0	
	0	1	0	0	0	0	0	0	0	0	0	0	1	0	1	1	
	3	0	0	0	0	0	0	0	0	0	0	0	1	1	0	0	
	2	0	0	0	0	0	0	0	0	0	0	0	1	1	0	1	
	1	0	0	0	0	0	0	0	0	0	0	0	1	1	1	0	
	0	0	0	0	0	0	0	0	0	0	0	0	1	1	1	1	
196K	1	1	0	0	0	1	0	0	0	1	0	0	0	0	1	0	131K
	0	1	0	0	0	1	0	0	0	1	0	0	0	0	1	1	
	3	0	0	0	0	1	0	0	0	1	0	0	0	1	0	0	
	2	0	0	0	0	1	0	0	0	1	0	0	0	1	0	1	
	1	0	0	0	0	1	0	0	0	1	0	0	0	1	1	0	
	0	0	0	0	0	1	0	0	0	1	0	0	0	1	1	1	
131K	3	0	1	0	0	0	0	0	0	1	0	0	1	1	0	0	98K
	2	0	1	0	0	0	0	0	0	1	0	0	1	1	0	1	
	1	0	1	0	0	0	0	0	0	1	0	0	1	1	1	0	
	0	0	1	0	0	0	0	0	0	1	0	0	1	1	1	1	
98K	2	0	1	0	0	1	0	0	0	1	1	0	0	1	0	1	65K
	1	0	1	0	0	1	0	0	0	1	1	0	0	1	1	0	
	0	0	1	0	0	1	0	0	0	1	1	0	0	1	1	1	
65K	1	0	1	1	0	0	0	0	0	1	1	1	0	1	1	0	49K
	0	0	1	1	0	0	0	0	0	1	1	1	0	1	1	1	
49K	1	0	1	1	0	1	0	0	0	1	1	1	0	1	1	0	32K
	0	0	1	1	0	1	0	0	0	1	1	1	0	1	1	1	
32K ²																	

1. 1 means up, 0 means down.

2. No reconfiguration possible.

Table G-3. CM Reconfiguration for Model 175

CM Before Reconfig- uration	Quadrant	CSU	Normal Setting ¹				Reconfiguration Setting ¹				CM After Reconfig- uration
			Switch Number	0	1	2	3	Switch Number	0	1	
262K	3	1	1	1	1	1	1	1	1	0	196K
	2	1	1	1	1	1	1	0	1		
	1	1	1	1	1	1	0	1	1		
	0	1	1	1	1	1	0	1	1		
	3	0	1	1	1	1	1	1	1	0	
	2	0	1	1	1	1	1	1	0	1	
	1	0	1	1	1	1	1	0	1	1	
	0	0	1	1	1	1	1	0	1	1	
196K	2	1	1	1	1	0	1	1	0	0	131K
	1	1	1	1	1	0	1	0	1	0	
	0	1	1	1	1	0	0	1	1	0	
	2	0	1	1	1	0	1	1	0	0	
	1	0	1	1	1	0	1	0	1	0	
	0	0	1	1	1	0	0	1	1	0	
131K	1	1	1	1	0	0	1	0	0	0	98K
	0	1	1	1	0	0	0	1	0	0	
	1	0	1	1	0	0	1	0	0	0	
	0	0	1	1	0	0	0	1	0	0	
98K	1	1	1	1	0	0	1	0	0	0	65K
	0	1	1	1	0	0	Not possible				
	1	0	1	1	0	0	1 0 0 0				
	0	0	1	1	0	0	Not possible				
65K ²											

1. 1 means up, 0 means down.

2. No reconfiguration possible.

Table G-4. CM Reconfiguration for Models 176, 740, 750, and 760

CM Before Reconfiguration	Quadrant	Normal Setting ¹ Switch Number				Reconfiguration Setting ¹ Switch Number				CM After Reconfiguration
		0	1	2	3	0	1	2	3	
262K	3	1	1	1	1	1	1	1	0	196K
	2	1	1	1	1	1	1	0	1	
	1	1	1	1	1	1	0	1	1	
	0	1	1	1	1	0	1	1	1	
196K	2	1	1	1	0	1	1	0	0	131K
	1	1	1	1	0	1	0	1	0	
	0	1	1	1	0	0	1	1	0	
131K	1	1	1	0	0	1	0	0	0	65K
	0	1	1	0	0	0	1	0	0	

1. 1 means up, 0 means down.

Table G-5. CM Reconfiguration for Models 720 and 730

CM Before Reconfiguration	Quadrant	Normal Setting ¹ Switch Number					Reconfiguration Setting ¹ Switch Number					CM After Reconfiguration
		1	2	3	4	5	1	2	3	4	5	
262K	3	0	0	0	0	0	0	0	0	1	0	196K
	2	0	0	0	0	0	0	0	1	0	0	
	1	0	0	0	0	0	0	1	0	0	0	
	0	0	0	0	0	0	1	0	0	0	0	
196K	2	0	0	0	1	0	0	0	1	1	0	131K
	1	0	0	0	1	0	0	1	0	1	0	
	0	0	0	0	1	0	1	0	0	1	0	
131K	1	0	0	1	1	0	0	1	1	1	0	65K
	0	0	0	1	1	0	1	0	1	1	0	
98K	1 0 ²	0	0	1	1	1	0	1	1	1	0	65K

1. 1 means up, 0 means down.

2. No reconfiguration possible.

Table G-6. CM Reconfiguration for Models 865 and 875

CM Before Reconfig- uration	Quadrant	Normal Setting ¹ Switch Number				Reconfiguration Setting ¹ Switch Number				CM After Reconfig- uration
		0	1	2	3	0	1	2	3	
1048K	3	1	1	1	1	1	1	1	0	786K
	2	1	1	1	1	1	1	0	1	
	1	1	1	1	1	1	0	1	1	
	0	1	1	1	1	0	1	1	1	
786K	2	1	1	1	0	1	1	0	0	524K
	1	1	1	1	0	1	0	1	0	
	0	1	1	1	0	0	1	1	0	
524K	1	1	1	0	0	1	0	0	0	262K
	0	1	1	0	0	0	1	0	0	

1. 1 means up, 0 means down.

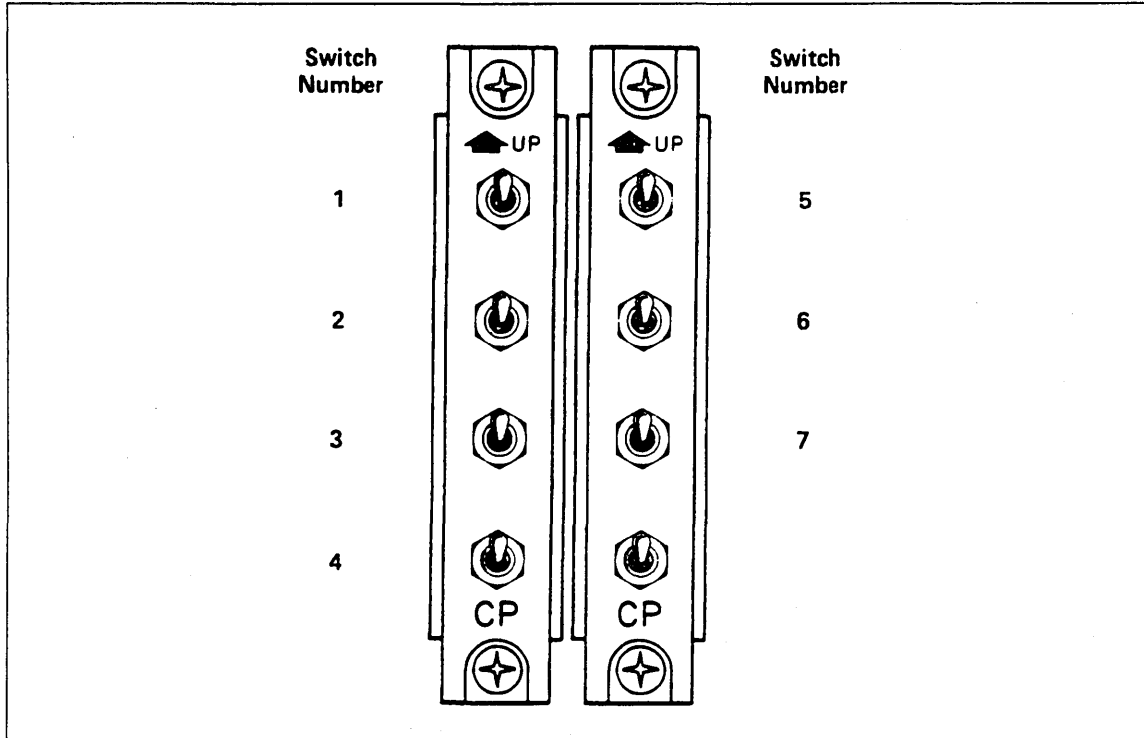

Figure G-11. Switch Numbering Scheme for CYBER 170 Computer Systems Models 171, 172, 173, 174, 720, and 730

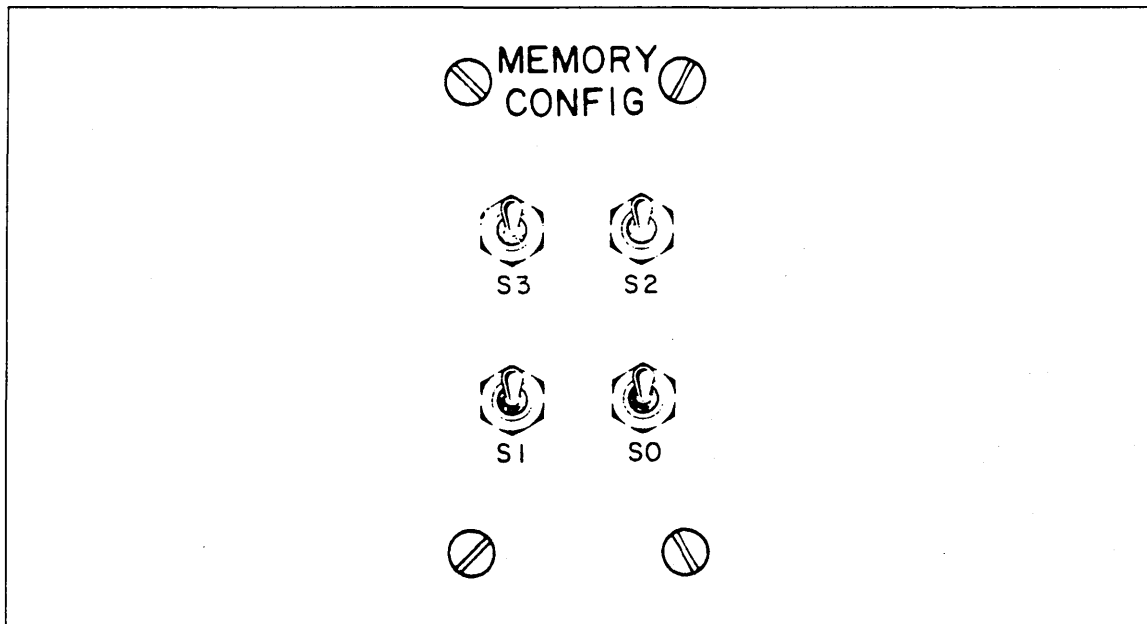

Figure G-12. Switch Numbering Scheme for CYBER 170 Computer Systems Models 175, 176, 740, 750, 760, 865, and 875

CM Reconfiguration for Models 810 and 830

This subsection pertains to models 810 and 830. For CM reconfiguration using CTI, refer to the hardware reconfiguration display for your model of computer.

This documentation is valid for reconfiguring central memory down to the values shown in tables G-7 and G-9 only. Reconfiguration to values other than those shown in these tables is not recommended.

When reconfiguration is necessary or desirable, the following information is needed to reconfigure.

- The normal total memory size.
- The central memory address in the text portion of the CTI message DEADSTART ABORTED-FATAL ERROR.

Use the following procedure to reconfigure the central memory for the models 810 and 830.

1. Press the deadstart switch on a CC545 to bring up the Deadstart Options display. When a CC634B display terminal is being used as the primary operator console, complete the following steps to bring up the Deadstart Options display:
 - a. Press the RESET button to reinitialize the console.
 - b. Hold down the CTRL key while pressing the G key.
 - c. When the message *OPERATOR ACCESS ENABLED* appears on the screen, hold down the CTRL key while pressing the R key.
2. Select the correct grouping from table G-7 or G-9 by locating the normal size of central memory from the CM Before Reconfiguration column.
3. Locate the correct line within the grouping by selecting the CM address shown with the CTI message.
4. If the display shows that all the CM configuration switches are centered (the display shows the letter C for each switch), reset them to the positions shown in the Reconfiguration Setting Switch Number column by entering:

SWx y

x is the switch number 2, 3, 4, 5, and y is C for center, U for up, and D for down. Then press the carriage return key.

If the switches are not centered before the attempt to reconfigure, additional reconfiguration is not recommended.

CM Reconfiguration for Models 815, 825, 835, 840, 845, 850, 855, 860 and 990

This section pertains to models 815, 825, 835, 840, 845, 850, 855, and 860 only. For CM reconfiguration using CTI, refer to the Hardware Reconfiguration display for your model of computer system.

This documentation is valid for reconfiguring central memory down to the values shown in tables G-8, G-10, G-11, and G-12 only. Reconfiguration to values other than those shown in the tables is not recommended.

When reconfiguration is necessary or desirable, the following information is needed to reconfigure:

- The normal total memory size.
- The central memory address in the text portion of the CTI message DEADSTART ABORTED-FATAL ERROR (refer to OS load automatic (CR) option on the Initial Options display for your model of computer system).

Use the following procedure to reconfigure central memory.

1. Locate the CM reconfiguration switches on the mainframe.
2. Select from table G-8, G-10, G-11, or G-12 the correct grouping by locating the normal size of central memory from the CM Before Reconfiguration column.
3. Locate the correct line within the grouping by selecting the CM address shown with the CTI message.
4. If all of the CM reconfiguration switches (refer to figures G-13 and G-14 for models 815 and 825; figure G-15 for models 835, 845, and 855; and G-17 for model 990 without the memory upgrade option) are centered, reset them to the position shown in the Reconfiguration Setting Switch Number column and deadstart. If the switches are not centered before the attempt to reconfigure, additional reconfiguration is not recommended.

If all of the CM reconfiguration switches for models 840, 850, and 860 and models 845 and 855 memory upgrade option (refer to figure G-16) are down, reset them to the position shown in the Reconfiguration Setting Switch Number column and deadstart. The purpose of reconfiguration, in this case, is to move the block of memory containing the failing bit to an area of memory that is outside the portion being used in C170 state (0 - 1FF FFF). No part of memory is actually turned off; instead halves of blocks of memory are transposed.

Table G-7. CM Reconfiguration for Models 810 and 830 Without Memory Upgrade Option

CM Before Reconfiguration	Normal Setting ¹	Address in CTI Message	Reconfiguration Setting	CM After Reconfiguration
4 Mbytes (524K Words)	Switch 3 C	≡ 0 3 F F F F	Switch 3 C	2 Mbytes (262K Words)
	Switch 4 C		Switch 4 C	
	Switch 5 C		Switch 5 U	
		≡ 0 4 0 0 0 0	Switch 3 C	
			Switch 4 C	
			Switch 5 U	
8 Mbytes (1048K Words)	Switch 3 C	≡ 0 7 F F F F	Switch 3 C	4 Mbytes (524K Words)
	Switch 4 C		Switch 4 U	
	Switch 5 C		Switch 5 C	
		≡ 0 8 0 0 0 0	Switch 3 C	
			Switch 4 D	
			Switch 5 U	
12 Mbytes (1572K Words)	Switch 3 C	≡ 0 F F F F F	Switch 3 U	4 Mbytes (524K Words)
	Switch 4 C		Switch 4 C	
	Switch 5 C		Switch 5 C	
		≡ 1 0 0 0 0 0	Switch 3 D	8 Mbytes (1048K Words)
			Switch 4 C	
			Switch 5 C	
16 Mbytes (2097K Words)	Switch 3 C	≡ 0 F F F F F	Switch 3 U	8 Mbytes (1048K Words)
	Switch 4 C		Switch 4 C	
	Switch 5 C		Switch 5 C	
			Switch 3 D	
			Switch 4 C	
			Switch 5 C	

1. C means switch is centered, U means up, and D means down.

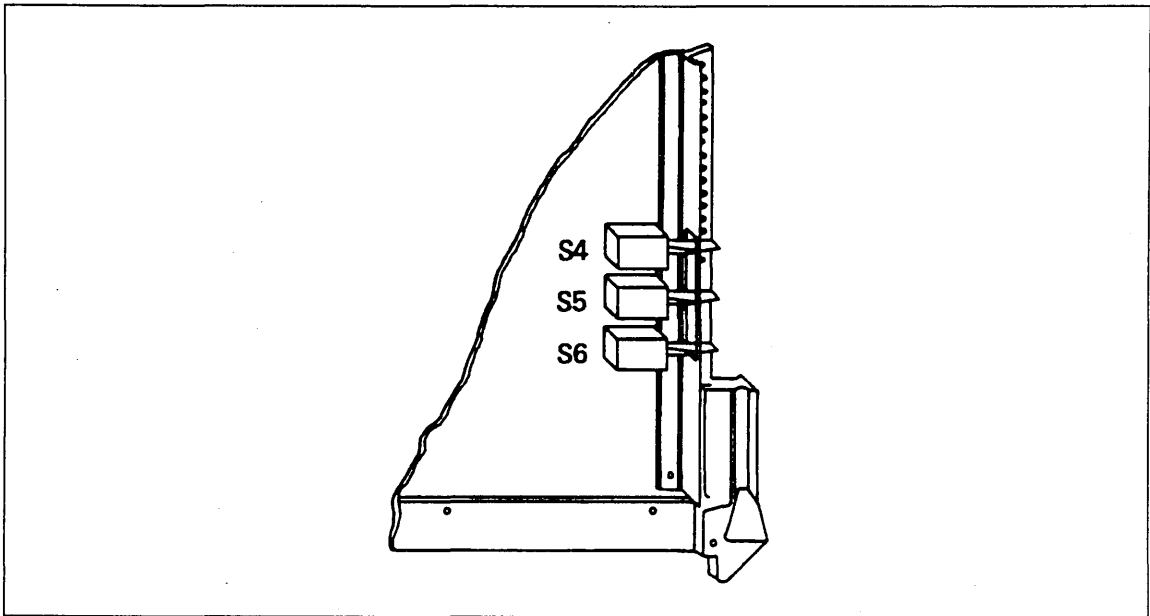

Figure G-13. Switch Numbering Scheme for Models 815 and 825 Without Memory Upgrade Option

Table G-8. CM Reconfiguration for Models 815 and 825 Without Memory Upgrade Option

CM Before Reconfiguration	Normal Setting¹	Address in CTI Message	Reconfiguration Setting	CM After Reconfiguration
2 Mbytes (262K Words)	Switch 4 C	≡ 0 1 F F F F	Switch 4 C	1 Mbytes (131K Words)
	Switch 5 C Switch 6 C		Switch 5 C Switch 6 U	
		≡ 0 2 0 0 0 0	Switch 4 C Switch 5 C Switch 6 C	
4 Mbytes (524K Words)	Switch 4 C	≡ 0 3 F F F F	Switch 4 C	2 Mbytes (262K Words)
	Switch 5 C Switch 6 C		Switch 5 U Switch 6 C	
		≡ 0 4 0 0 0 0	Switch 4 C Switch 5 D Switch 6 C	
6 Mbytes (786K Words)	Switch 4 C	≡ 0 7 F F F F	Switch 4 U	2 Mbytes (262K Words)
	Switch 5 C Switch 6 C		Switch 5 C Switch 6 C	
		≡ 0 8 0 0 0 0	Switch 4 D Switch 5 C Switch 6 C	4 Mbytes (524K Words)
8 Mbytes (1048K Words)	Switch 4 C	≡ 0 7 F F F F	Switch 4 U	4 Mbytes (524K Words)
	Switch 5 C Switch 6 C		Switch 5 C Switch 6 C	
		≡ 0 8 0 0 0 0	Switch 4 D Switch 5 C Switch 6 C	

1. C means switch is centered, U means up, and D means down.

Table G-9. CM Reconfiguration for Models 810, 815, 825, and 830 With Memory Upgrade Option

CM Before Reconfiguration	Normal Setting ¹	Address in CTI Message	Reconfiguration Setting	CM After Reconfiguration
16 Mbytes (2097K Words)	Switch 1 C	≤ 0 F F F F F	Switch 1 C	8 Mbytes (1049K Words)
	Switch 2 C Switch 3 C		Switch 2 C Switch 3 C	
		≤ 1 0 0 0 0 0	Switch 1 C Switch 2 C Switch 3 D	
32 Mbytes (4195K Words)	Switch 1 C	≤ 1 F F F F F	Switch 1 C	16 Mbytes (2097K Words)
	Switch 2 C Switch 3 C		Switch 2 U Switch 3 C	
		≤ 2 0 0 0 0 0	Switch 1 C Switch 2 D Switch 3 C	

1. C means switch is centered, U means up, and D means down. Switch 1 is not used.

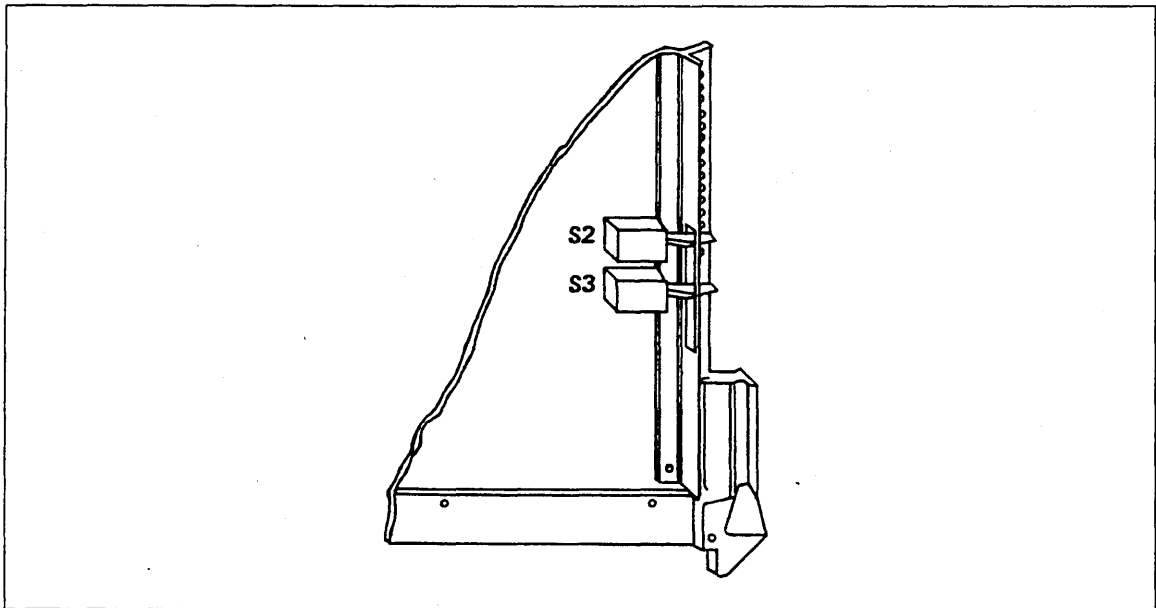

Figure G-14. Switch Numbering Scheme for Models 815 and 825 with Memory Upgrade Option

Table G-10. CM Reconfiguration for Models 835, 845, and 855 Without Memory Upgrade Option

CM Before Reconfiguration	Normal Setting ¹	Address in CTI Message	Reconfiguration Setting	CM After Reconfiguration
4 Mbytes (524K Words)	Switch 3 C	≡ 0 3 F F F F	Switch 3 C	2 Mbytes (262K Words)
	Switch 4 C Switch 5 C Switch 6 C		Switch 4 C Switch 5 U Switch 6 C	
		≡ 0 0 0 0 0 0	Switch 3 C Switch 4 C Switch 5 D Switch 6 C	
8 Mbytes (1048K Words)	Switch 3 C	≡ 0 7 F F F F	Switch 3 C	4 Mbytes (524K Words)
	Switch 4 C Switch 5 C Switch 6 C		Switch 4 U Switch 5 C Switch 6 C	
		≡ 0 8 0 0 0 0	Switch 3 C Switch 4 D Switch 5 C Switch 6 C	
12 Mbytes (1572K Words)	Switch 3 C	≡ 0 F F F F F	Switch 3 U	4 Mbytes (524K Words)
	Switch 4 C Switch 5 C Switch 6 C		Switch 4 C Switch 5 C Switch 6 C	
		≡ 1 0 0 0 0 0	Switch 3 D Switch 4 C Switch 5 C Switch 6 C	8 Mbytes (1048K Words)
16 Mbytes (2097K Words)	Switch 3 C	≡ 0 F F F F F	Switch 3 U	8 Mbytes (1048K Words)
	Switch 4 C Switch 5 C Switch 6 C		Switch 4 C Switch 5 C Switch 6 C	
		≡ 1 0 0 0 0 0	Switch 3 D Switch 4 C Switch 5 C Switch 6 C	

1. C means switch is centered, U means up, and D means down.

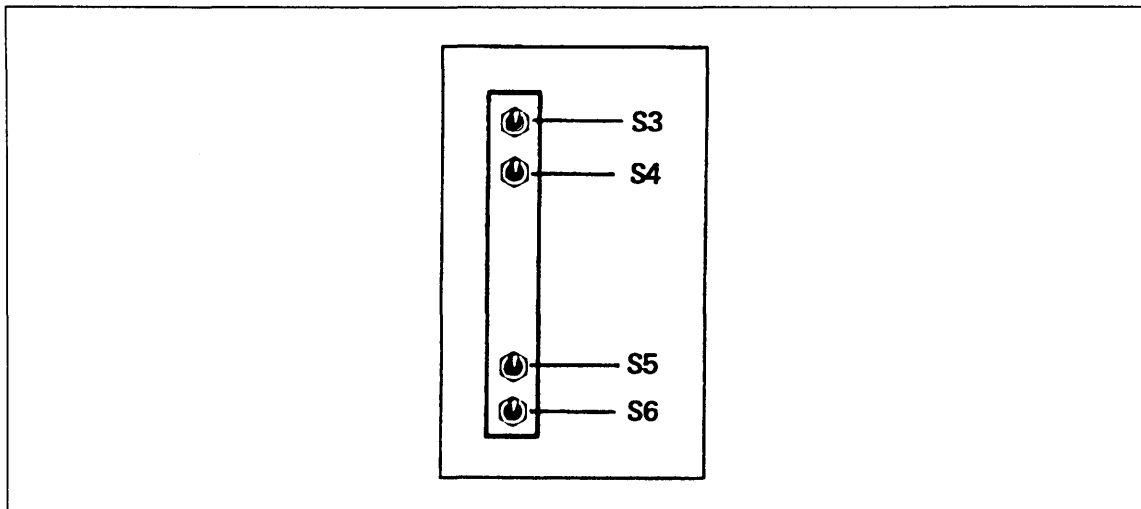

Figure G-15. Switch Numbering Scheme for Models 835, 845, and 855 Without Memory Upgrade Option

Table G-11. CM Reconfiguration Switch Settings for Models 845 and 855 With Memory Upgrade Option and for Models 840, 850, and 860

CM Before Reconfiguration	Address in CTI Message	Switch Setting 0 1 2 3 4 5	Error Free CM After Reconfiguration
16 Mbytes (2097K Words)	≤ 0 F F F F F	Switch 0, Address 37 D Switch 1, Address 38 D Switch 2, Address 39 D Switch 3, Address 40 U Switch 4, Address 39 D Switch 5, Address 40 D	8 Mbytes (1049K Words)
	≤ 1 0 0 0 0 0	Switch 0, Address 37 D Switch 1, Address 38 D Switch 2, Address 39 D Switch 3, Address 40 D Switch 4, Address 39 D Switch 5, Address 40 D	
32 Mbytes (4195K Words)	≤ 1 F F F F F	Switch 0, Address 37 D Switch 1, Address 38 D Switch 2, Address 39 U Switch 3, Address 40 D Switch 4, Address 39 D Switch 5, Address 40 D	16 Mbytes (2097K Words)
	≤ 1 F F F F F	Switch 0, Address 37 D Switch 1, Address 38 D Switch 2, Address 39 U Switch 3, Address 40 D Switch 4, Address 39 D Switch 5, Address 40 D	
64 Mbytes (8390K Words)	≤ 1 F F F F F	Switch 0, Address 37 D Switch 1, Address 38 D Switch 2, Address 39 U Switch 3, Address 40 D Switch 4, Address 39 D Switch 5, Address 40 D	32 Mbytes (4195K Words)
	≤ 1 F F F F F	Switch 0, Address 37 D Switch 1, Address 38 U Switch 2, Address 39 D Switch 3, Address 40 D Switch 4, Address 39 D Switch 5, Address 40 D	

NOTE: The normal setting of all switches is down.

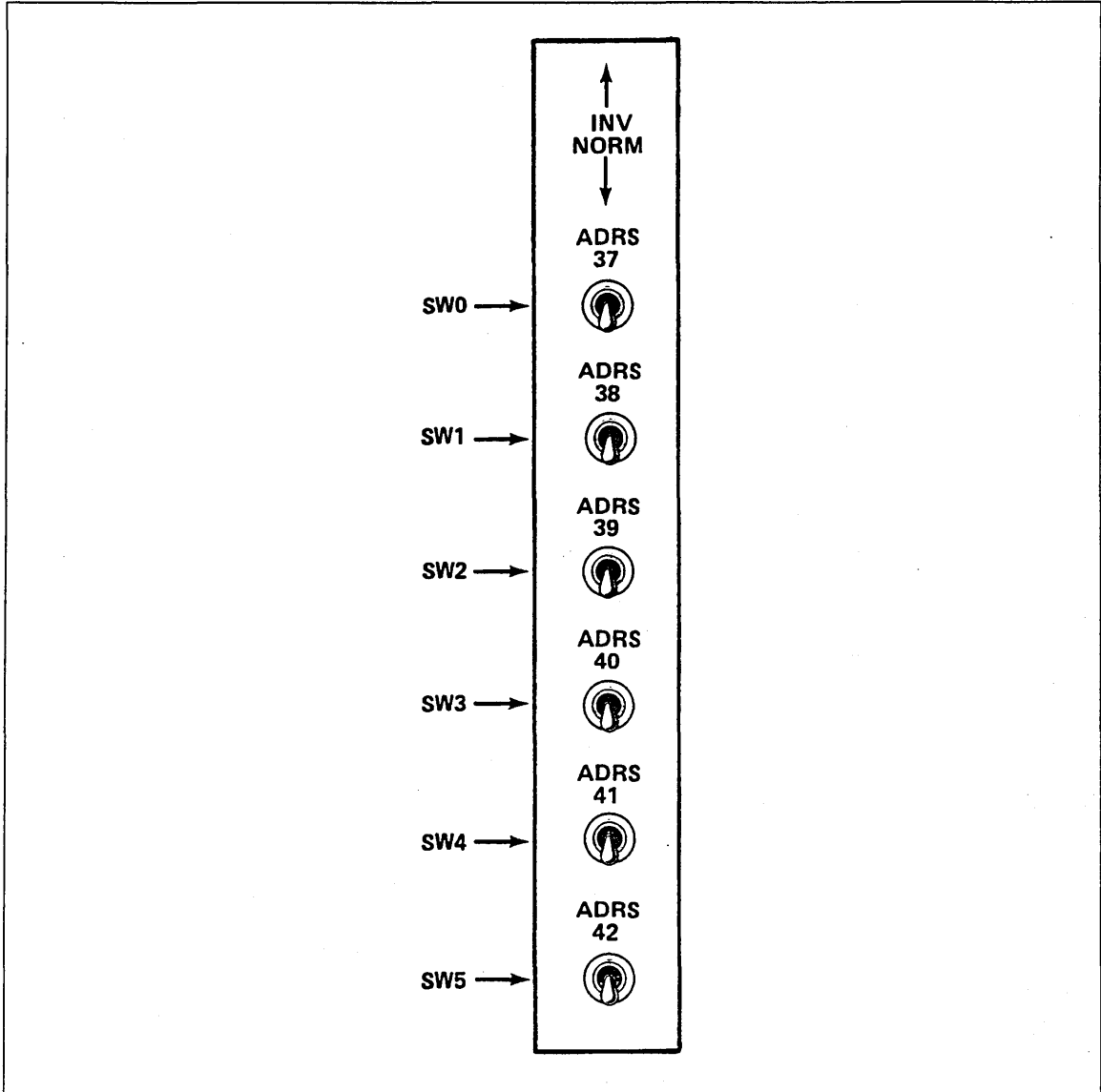

Figure G-16. Switch Numbering Scheme for Models 845 and 855 With Memory Upgrade Option and for Models 840, 850, and 860

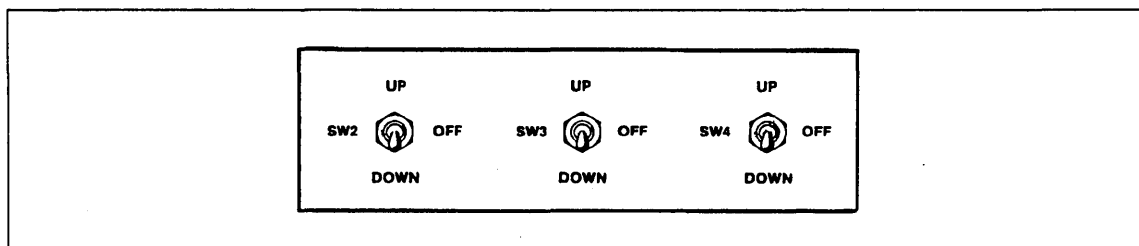

Figure G-17. Switch Numbering Scheme for Model 990

Table G-12. CM Reconfiguration for Model 990

Original CM		Reconfigured CM	Location of Failing CM ¹		
Size in Words	Address Range	Size in Words	RMA Bit 39	RMA Bit 40	RMA Bit 41
1049K (8MB)	0-3 777 777	524K (4MB)	X	X	0
		524K (4MB)	X	X	1
2097K (16MB)	0-7 777 777	1049K (8MB)	X	0	X
		1049K	X (8MB)	1	X
3146K (24MB)	0-13 777 777	1049K (8MB)	0	0	X
		1049K	0 (8MB)	1	X
		2097K	1 (16MB)	0	X
4195K (32MB)	0-17 777 777	2097K (16MB)	0	X	X
		2097K (16MB)	1	X	X

Notes:

1. CM remaining can be further reconfigured by setting additional configuration switches.

(Continued)

Table G-12. CM Reconfiguration for Model 990 (Continued)

Original CM		Reconfigured CM	Reconfiguration Setting ¹ Switch Number		
Size in Words	Address Range		2	3	4
1049K (8MB)	0-3 777 777	524K (4MB)	-	-	U
		524K (4MB)	-	-	D
2097K (16MB)	0-7 777 777	1049K (8MB)	-	U	-
		1049K (8MB)	-	D	-
3146K (24MB)	0-13 777 777	1049K (8MB)	-	U	-
		1049K (8MB)	-	D	-
		2097K (16MB)	D	-	-
4195K (32MB)	0-17 777 777	2097K (16MB)	U	-	-
		2097K (16MB)	D	-	-

Notes:

1. U equals up, D equals down, and dash (-) equals center position.

Before a CC634B console can be configured as a primary console, you must first establish its operational state by installing a specific subset of its parameters. Although the initial installation procedure is somewhat lengthy, once you have performed it, you can accomplish the same results by pressing the RESET button on the console.

The following lists are parameters that require initialization.

Terminal Installation Parameters:

F4 Configuration

Position 1 = 1: Auto select enabled

F6 Auto Select Mode

Position = 1: CYBER mode selected

CYBER Mode Installation Parameters:

F2 Configuration

Position 1 = 1: Mode execution enabled

Position 6 = 0: Host interface

F3 Configuration

Position 3 = 0: Host communications to have 7 data bits (excluding parity)

Position 4 = 1: Parity in host communications enabled

Position 5 = 1: Parity is even/mark

Position 6 = 0: Words in host communications to have 1 stop bit

F4 Configuration

Position 1 = 1: DTR switched off during local operations

Position 2 = 0: RTS constant

F5 Configuration

Position 1 = 0: Pacing disabled

Position 2 = 1: Bias enabled

F6 Operation Default Parameters (hexadecimal value):

Position 1 (binary power of 2 representation)

Bit 2^0 = 0: On-line

Bit 2^1 = 0: Printer deselected

Position 2 (binary power of 2 representation)

Bit 2^3 = 1: Large CYBER

Position 3 (binary power of 2 representation)

Bit 2^0 = 0: Background dark

Bit 2^1 = 0: Cursor line

Bit 2^2 = 0: Cursor blink

Position 4 (binary power of 2 representation)

- Bit 2⁰ = 1: Full duplex
- Bit 2¹ = 0: 80 characters per line
- Bit 2² = 1: 30 lines
- Bit 2³ = 0: Transparent feature off

F9 Default File Number, Transmit/Receive Baud Rate (hexadecimal value):

Position 3 is transmit baud rate in bits per second (bps) as follows:

Value	Baud Rate	Value	Baud Rate
4	300 bps	8	2400 bps
5	600 bps	9	4800 bps
6	1200 bps	A	9600 bps
7	1800 bps	B	19200 bps

Position 4 is receive baud rate. Refer to transmit baud rate for values.

NOTE

This procedure assumes that the CC634B display terminal with no internal options installed is connected to a two-port multiplexer and is operational.

Complete the following steps to initialize a CC634B console.

1. Turn on the console. The Mode Selection display appears on the screen. This display consists of a row of 10 lighted blocks across the bottom of the screen. Go to step 3. If the Mode Selection display does not appear, complete step 2.
2. If the console has been previously configured to automatically select an operational mode, the Mode Selection display does not appear. In this situation, wait 60 seconds for a load time-out to occur. After 60 seconds, the Mode Selection display should appear. If it does not, complete the following steps.
 - a. Press the SETUP key.
 - b. Press the F10 key twice.

The Mode Selection display should now appear.
3. Hold down the CTRL key while you press the SETUP key. The default terminal installation parameters appear in a row of lighted blocks on the screen. Refer to the 721-21/31 Owner's Manual listed in the preface for a description of this display.

NOTE

A small blinking light (cursor) appears in the F2 block. The cursor highlights where the next character you type on the keyboard will appear on the screen.

4. Press the F4 key to position the cursor under the F4 block (CONFIG).
5. Press the 1 key to set auto select enabled.
6. Press the F6 key to position the cursor under the F6 block (AS X Y).

7. Press the 1 key to select mode 1, CYBER mode.
8. Press the COPY key to write the terminal installation parameters into nonvolatile memory. This makes the changes permanent. The cursor moves to the F9 block.
9. Press the F10 key and then press the 1 key to select operating mode 1 (CYBER mode) and display the Installation Parameters.
10. Press the F2 key, if necessary, to position the cursor under the F2 block (CONFIG).
11. Enter the value 1xxxx0 in the F2 block.
 - a. Press the 1 key to enable mode 1, CYBER mode.
 - b. Press the space bar until the cursor is under the sixth or rightmost position, then press the 0 (zero) key to select host interface.
12. Press the F3 key, if necessary, to position the cursor under the F3 block (CONFIG).
13. Enter the value xx0110 in the F3 block.
 - a. Space to the third position of the F3 block. Press the 0 (zero) key to select host to have 7 data bits.
 - b. With the cursor in the fourth position, press the 1 key to select host parity enabled.
 - c. With the cursor in the fifth position, press the 1 key to select host parity even/mark.
 - d. With the cursor in the sixth position, press the 0 (zero) key to select host words have 1 stop bit.
14. Press the F4 key, if necessary, to position the cursor under the F4 block (CONFIG).
15. Enter the value 10xxxx in the F4 block.
 - a. With the cursor in the first position, press the 1 key to select data terminal ready (DTR) signal switched off.
 - b. With the cursor in the second position, press the 0 (zero) key to select request to send (RTS) signal on constantly when DTR or data set ready signals drop.
16. Press the F5 key to position the cursor under the F5 block (CONFIG).
17. Enter the value 01xxxx in the F5 block.
 - a. With the cursor in the first position, press the 0 (zero) key to select pacing disabled.
 - b. With the cursor in the second position, press the 1 key to select bias enabled.
18. Press the F6 key to position the cursor under the F6 block (OPR DF). Four hexadecimal characters are displayed.
19. Enter the value 0C05 in the F6 block.
20. Press the F9 key to position the cursor under the F9 block (DF T R).

21. Press the space bar twice to position the cursor under the third hexadecimal character (under the T).
22. Enter the proper transmit line speed/ baud rate from the following table:

Entry	Baud Rate
4	300 bps
5	600 bps
6	1200 bps
7	1800 bps
8	2400 bps
9	4800 bps
A	9600 bps ¹
B	19200 bps

23. With the cursor under the fourth hexadecimal character (under the R), enter the proper receive line speed/ baud rate using the table in step 22.
The blocks you changed should now be displayed at the bottom of the screen as shown in figure H-1.

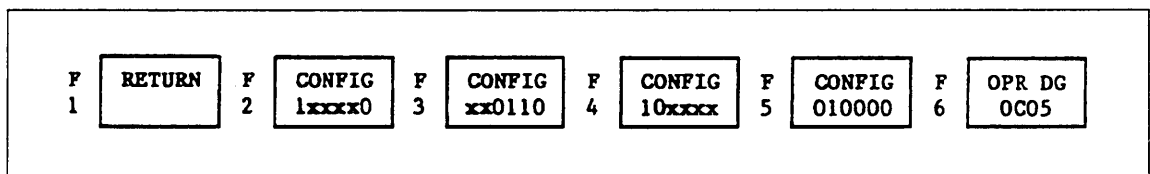

Figure H-1. Mode Installation Parameters

24. Press the COPY key to write the mode installation parameters into nonvolatile memory. This makes the changes permanent. The cursor moves to the F10 block.
25. Press the F1 key twice to return the console to CYBER mode.

Installation of parameters required to support automatic initialization of the CC634B console is now complete.

1. A baud rate of 19200 bps is generally used when the CC634B is used as the primary console.

ase fold on dotted line;
al edges with tape only.

FOLD

DLD

FOLD



NO POSTAGE
NECESSARY
IF MAILED
IN THE
UNITED STATES

BUSINESS REPLY MAIL
First-Class Mail Permit No. 8241 Minneapolis, MN

POSTAGE WILL BE PAID BY ADDRESSEE

CONTROL DATA
Technical Publications
ARH219
4201 N. Lexington Avenue
Arden Hills, MN 55126-9983



We would like your comments on this manual to help us improve it. Please take a few minutes to fill out this form.

Who are you?

- Manager
- Systems analyst or programmer
- Applications programmer
- Operator
- Other _____

How do you use this manual?

- As an overview
- To learn the product or system
- For comprehensive reference
- For quick look-up
- Other _____

What programming languages do you use? _____

How do you like this manual? Answer the questions that apply.

- | Yes | Somewhat | No | |
|--------------------------|--------------------------|--------------------------|---|
| <input type="checkbox"/> | <input type="checkbox"/> | <input type="checkbox"/> | Does it tell you what you need to know about the topic? |
| <input type="checkbox"/> | <input type="checkbox"/> | <input type="checkbox"/> | Is the technical information accurate? |
| <input type="checkbox"/> | <input type="checkbox"/> | <input type="checkbox"/> | Is it easy to understand? |
| <input type="checkbox"/> | <input type="checkbox"/> | <input type="checkbox"/> | Is the order of topics logical? |
| <input type="checkbox"/> | <input type="checkbox"/> | <input type="checkbox"/> | Can you easily find what you want? |
| <input type="checkbox"/> | <input type="checkbox"/> | <input type="checkbox"/> | Are there enough examples? |
| <input type="checkbox"/> | <input type="checkbox"/> | <input type="checkbox"/> | Are the examples helpful? (<input type="checkbox"/> Too simple? <input type="checkbox"/> Too complex?) |
| <input type="checkbox"/> | <input type="checkbox"/> | <input type="checkbox"/> | Do the illustrations help you? |
| <input type="checkbox"/> | <input type="checkbox"/> | <input type="checkbox"/> | Is the manual easy to read (print size, page layout, and so on)? |
| <input type="checkbox"/> | <input type="checkbox"/> | <input type="checkbox"/> | Do you use this manual frequently? |

Comments? If applicable, note page and paragraph. Use other side if needed.

Check here if you want a reply:

Name

Company

Address

Date

Phone

Please send program listing and output if applicable to your comment.

CORPORATE HEADQUARTERS, P.O. BOX 0, MINNEAPOLIS, MINN 55440
SALES OFFICES AND SERVICE CENTERS IN MAJOR CITIES THROUGHOUT THE WORLD

LITHO IN U.S

 CONTROL DATA

(
(