



**CYBER INITIALIZATION PACKAGE (CIP)
USER'S HANDBOOK**

**CDC® COMPUTER SYSTEMS:
CYBER 180
CYBER 170
CYBER 170M
CYBER 70
MODELS 71, 72, 73, 74
6000**

REVISION RECORD

REVISION	DESCRIPTION
01 (11-21-83)	Preliminary manual. Reflects CIP release L001.
A (02-20-84)	Manual released.
B (05-15-84)	Manual revised to CIP L002. Manual supports CYBER 180 Models 810, 830, 835, 845, and 855. Support of CYBERPLUS, 721 console, dual-CPU, 639 streaming tape unit, Monitor Display Driver (MDD), revisions to EDD, and miscellaneous corrections are also included. Because extensive changes are made, change bars and dots are not used and all pages reflect the latest revision level. This edition obsoletes all previous editions.
C (12-03-84)	Manual revised to CIP L003. Manual supports CYBER 170M Model 875, and the Disk Subsystem Microcode Load Utility. Revisions to EDD and HIVS procedures are included as are miscellaneous corrections. Because extensive changes are made, change bars and dots are not used and all pages reflect the latest revision level. This edition obsoletes all previous editions.
D (05-28-85)	Manual revised to CIP L004. Manual supports CYBER 180 Models 840, 850, and 860; memory upgrade options for models 810, 815, 825, 830, 845, and 855; and 836 and 895 disk subsystems. This edition obsoletes all previous editions.
E (12-04-85)	Manual revised to CIP L005. Manual supports CYBER 180 Model 990 and models 840-860 with I4. This edition obsoletes all previous editions.
F (07-07-86)	Manual Revised to CV006. Manual supports CYBER 180 Model 990 Dual CPU; revisions to EDD, CTI, and MDD procedures; and miscellaneous corrections are also included. Because extensive changes are made, change bars and dots are not used and all pages reflect the latest revision level. This edition obsoletes all previous editions.
Publication No. 60457180	

REVISION LETTERS I, O, Q, S, X AND Z ARE NOT USED.

Address comments concerning this manual to:

Control Data Corporation
Technology and Publications Division
4201 North Lexington Avenue
St. Paul, Minnesota 55126-6198

or use Comment Sheet in the back of this manual.

©1983, 1984, 1985, 1986
by Control Data Corporation
All rights reserved
Printed in the United States of America

PREFACE

The CIP User's Handbook includes information on how to install and use the CONTROL DATA® CYBER Initialization Package (CIP) on CDC CYBER 180 Computer Systems Models 810, 830, 835, 840, 845, 850, 855, 860, and 990; CDC CYBER 170 Computer Systems Models 171, 172, 173, 174, 175, 176, 720, 730, 740, 750, 760, 815, 825, 835, 845, 855, 865, and 875; CDC CYBER 170M Computer System Model 875; CDC CYBER 70 Computer Systems Models 71, 72, 73, and 74; and 6000 Computer Systems.

ORGANIZATION

This handbook is organized into two parts and several appendixes. Since many CIP features are model dependent, part I is organized by model numbers. Part I includes the following sections:

Section 1 introduces CIP, noting its advantages and implications.

Sections 2 through 7 provide model-dependent procedures and displays. These sections include procedures for installing CIP and for performing an operating system deadstart, and describe the various deadstart displays and the options offered.

Part II provides procedural summaries and overviews that are applicable to several models of computers. Part II includes the following sections:

Section 1 provides deadstart procedure summaries, coldstart procedures, and deadstart programs.

Section 2 provides general procedures that are applicable to most or all of the computer systems.

Part III provides reference information for the monitor display driver (MDD).

The appendixes include a glossary of terms, a directory of error messages, a directory of HIVS tests, and CIP installation and maintenance information oriented toward the customer engineer.

CONVENTIONS

This handbook includes many procedures you'll work through at the system operator console. In describing the entries you'll be making at your console keyboard, one of the phrases used is "press the carriage return key" to describe how to terminate an entry. The specific key you press to terminate an entry varies depending on the type of operator console you're using, CC545 or CC634B.

The method of initiating a deadstart also varies depending on the type of operator console. To deadstart using the CC545, you simply press the Deadstart button on the console. When using the CC634B, you must perform a CTRL-G, CTRL-R sequence to start the deadstart process. This sequence is described for specific computer system models elsewhere in this handbook.

RELATED PUBLICATIONS

Procedures and descriptions within this manual may refer you to information in the following related Control Data publications.

<u>Control Data Publication</u>	<u>Publication Number</u>
NOS Version 2 Administration Handbook	60459840
NOS Version 2 Analysis Handbook	60459300
NOS Version 2 Installation Handbook	60459320
NOS Version 2 Operations Handbook	60459310
NOS/BE Operator's Guide	60493900
NOS/BE System Programmer's Reference Manual, Volume 1	60494100
CYBER 170 Computer Systems Models 815 and 825 Hardware Operator's Guide	60469370
CYBER 170 System Models 835, 845, and 855 Hardware Operator's Guide	60458390
CYBER 180 Computer Systems Models 810 and 830 Hardware Operator's Guide	60469440
MSL 140 Off-Line Maintenance Software Library Reference Manual	60459860
MSL 15X Off-Line Maintenance Software Library Reference Manual	60456530
721-21/31 Owner's Manual	62950101
NOS/VE Operations Manual	60463914
NOS/VE Installation and Upgrade Manual	60463913

DISCLAIMER

This product is intended for use only as described in this document. Control Data cannot be responsible for the proper functioning of undescribed features or parameters.

CONTENTS

<p>PART I</p> <p>I-1. INTRODUCTION I-1-1</p> <p>CIP Features I-1-2</p> <p style="padding-left: 20px;">Automatic Installation Option I-1-2</p> <p style="padding-left: 20px;">Help Displays I-1-2</p> <p>Considerations for Sites with CYBER 170 and CYBER 180 Model 800 Computer Systems I-1-2</p> <p style="padding-left: 20px;">CIP Release and Distribution I-1-3</p> <p style="padding-left: 20px;">Disk Space Requirements I-1-3</p> <p style="padding-left: 20px;">Tailored CIP I-1-3</p> <p style="padding-left: 20px;">Single CTI Copy I-1-4</p> <p style="padding-left: 20px;">Sites with No Maintenance Contract I-1-4</p> <p>Considerations for Sites with Non- Model-800 Computer Systems I-1-4</p> <p>I-2. CIP PROCEDURES, DISPLAYS, AND OPTIONS FOR CYBER 180 MODELS 810 AND 830 I-2-1</p> <p>CIP Installation I-2-3</p> <p>Operating System Deadstart I-2-7</p> <p style="padding-left: 20px;">Disk Deadstart I-2-7</p> <p style="padding-left: 40px;">Operating System File on Disk I-2-7</p> <p style="padding-left: 40px;">Operating System File on Tape or Alternate Disk I-2-8</p> <p>Displays and Options for Deadstart from Disk I-2-9</p> <p style="padding-left: 20px;">Overview I-2-9</p> <p style="padding-left: 20px;">Initial Options Display I-2-13</p> <p style="padding-left: 20px;">Operator Intervention Display I-2-16</p> <p style="padding-left: 20px;">Utilities Display I-2-24</p> <p>Displays and Options for Deadstart from CIP Tape I-2-31</p> <p style="padding-left: 20px;">Overview I-2-31</p> <p style="padding-left: 20px;">Initial Options Display I-2-35</p> <p style="padding-left: 20px;">Build Deadstart Disk Display I-2-36</p> <p style="padding-left: 20px;">Manual Operations Display I-2-38</p> <p style="padding-left: 20px;">Utilities Display I-2-40</p> <p>I-3. CIP PROCEDURES, DISPLAYS, AND OPTIONS FOR CYBER 170 MODELS 815 AND 825 I-3-1</p> <p>CIP Installation I-3-3</p> <p>Operating System Deadstart I-3-7</p>		<p style="padding-left: 40px;">Disk Deadstart I-3-7</p> <p style="padding-left: 60px;">Operating System File on Disk I-3-7</p> <p style="padding-left: 60px;">Operating System File on Tape or Alternate Disk I-3-8</p> <p>Displays and Options for Deadstart from Disk I-3-9</p> <p style="padding-left: 20px;">Overview I-3-9</p> <p style="padding-left: 20px;">Initial Options Display I-3-13</p> <p style="padding-left: 20px;">Operator Intervention Display I-3-15</p> <p style="padding-left: 20px;">Utilities Display I-3-23</p> <p>Displays and Options for Deadstart from CIP Tape I-3-29</p> <p style="padding-left: 20px;">Overview I-3-29</p> <p style="padding-left: 20px;">Initial Options Display I-3-33</p> <p style="padding-left: 20px;">Build Deadstart Disk Display I-3-34</p> <p style="padding-left: 20px;">Manual Operations Display I-3-36</p> <p style="padding-left: 20px;">Utilities Display I-3-38</p> <p>I-4. CIP PROCEDURES, DISPLAYS, AND OPTIONS FOR CYBER 170/180 MODELS 835 THROUGH 860 I-4-1</p> <p>CIP Installation I-4-3</p> <p>Operating System Deadstart I-4-5</p> <p style="padding-left: 20px;">Disk Deadstart I-4-5</p> <p style="padding-left: 40px;">Operating System File on Disk I-4-5</p> <p style="padding-left: 40px;">Operating System File on Tape or Alternate Disk I-4-6</p> <p>Displays and Options for Deadstart from Disk I-4-9</p> <p style="padding-left: 20px;">Overview I-4-9</p> <p style="padding-left: 20px;">Initial Options Display I-4-13</p> <p style="padding-left: 20px;">Operator Intervention Display I-4-16</p> <p style="padding-left: 20px;">Utilities Display I-4-25</p> <p>Displays and Options for Deadstart from CIP Tape I-4-31</p> <p style="padding-left: 20px;">Overview I-4-31</p> <p style="padding-left: 20px;">Initial Options Display I-4-35</p> <p style="padding-left: 20px;">Build Deadstart Disk Display I-4-36</p> <p style="padding-left: 20px;">Manual Operations Display I-4-38</p> <p style="padding-left: 20px;">Utilities Display I-4-40</p> <p>I-5. CIP PROCEDURES, DISPLAYS, AND OPTIONS FOR CYBER 170 MODELS 865 AND 875 AND CYBER 170M MODEL 875 I-5-1</p> <p>CIP Installation I-5-3</p> <p>Operating System Deadstart I-5-5</p>
--	--	--

Disk Deadstart	I-5-5
Operating System File on Disk	I-5-5
Operating System File on Tape or Alternate Disk	I-5-6
Displays and Options for Deadstart from Disk	I-5-7
Overview	I-5-7
Initial Options Display	I-5-11
Operator Intervention Display	I-5-13
Utilities Display	I-5-19
Displays and Options for Deadstart from CIP Tape	I-5-23
Overview	I-5-23
Initial Options Display	I-5-27
Build Deadstart Disk Display	I-5-28
Manual Operations Display	I-5-29
Utilities Display	I-5-31

I-6. CIP PROCEDURES, DISPLAYS, AND OPTIONS FOR NON-MODEL-800 COMPUTER SYSTEMS	I-6-1
CIP Installation	I-6-3
Operating System Deadstart	I-6-5
Disk Deadstart	I-6-5
Operating System File on Disk	I-6-5
Operating System File on Tape or Alternate Disk	I-6-6
OS Tape Deadstart	I-6-6
Displays and Options for Deadstart from Disk or OS Tape	I-6-7
Overview	I-6-7
Initial Options Display	I-6-11
Operator Intervention Display	I-6-12
Utilities Display	I-6-19
Displays and Options for Deadstart from CIP Tape	I-6-23
Overview	I-6-23
Initial Options Display	I-6-27
Build Deadstart Disk Display	I-6-28
Manual Operations Display	I-6-29
Utilities Display	I-6-30

I-7. CIP PROCEDURES, DISPLAYS, AND OPTIONS FOR CYBER 180 MODEL 990	I-7-1
CIP Installation	I-7-3
Operating System Deadstart	I-7-7
Disk Deadstart	I-7-7
Operating System File on Disk	I-7-7
Operating System File on Tape or Alternate Disk	I-7-8

Displays and Options for Deadstart from Disk	I-7-9
Overview	I-7-9
Initial Options Display	I-7-13
Operator Intervention Display	I-7-17
Utilities Display	I-7-25
Displays and Options for Deadstart from CIP Tape	I-7-31
Overview	I-7-31
Initial Options Display	I-7-35
Build Deadstart Disk Display	I-7-36
Manual Operations Display	I-7-38
Utilities Display	I-7-40

PART II

II-1. DEADSTART PROCEDURE SUMMARIES	II-1-1
Coldstart Procedure Summaries	II-1-5
Coldstart of Tape Controllers for 667 or 669 Tape Units	II-1-5
Coldstart 7021/7152 Tape Controller from Card Reader	II-1-5
Coldstart 7152 Tape Controller from Tape Unit	II-1-6
Coldstart of Disk Controllers for 844, 885-11/12, or 895	II-1-7
Disk Units	II-1-7
Coldstart 7054/7154/7152/ 7155/7165 Disk Controller from Card Reader	II-1-7
Coldstart 7152/7155/7165 Disk Controller from Disk Unit	II-1-8
Coldstart Procedure Summary for Models 810, 815, 825, 830, and 990	II-1-8
Coldstart/Install 834/836 Disk Subsystem Microcode from CIP Tape	II-1-9
Coldstart/Warmstart 834/836 Disk Subsystem from Disk	II-1-10
Coldstart 639 Tape Unit from Tape	II-1-10
Setting the Deadstart Panel for a Coldstart	II-1-12
Panel Settings for Coldstart of 7021/7152 Tape Controller from Card Reader	II-1-17
Panel Settings for Coldstart of 7152 Tape Controller from Tape Unit	II-1-19
Panel Settings for Coldstart of 7054/7154/7152/7155/7165 Disk Controller from Card Reader	II-1-20

Panel Settings for Coldstart of 7152/7155/7165 Disk Controller from Disk Unit	II-1-22	Running Hardware Verification Sequence (HIVS)	II-2-28
Deadstart Program for Coldstart/Warmstart of 834/836 Disk Controller from Disk Unit	II-1-24	Resetting the Deadstart Parameters	II-2-29
Deadstart Program for Coldstart of 639 Tape Unit Controller from Tape	II-1-25	Build Deadstart Disk Operations	II-2-31
Warmstart Procedure Summary	II-1-27	Manually Replace Modules on the Deadstart Disk	II-2-31
Warmstart Procedure for Models 810, 815, 825, and 830	II-1-29		
Setting the Deadstart Panel for a Warmstart	II-1-30	PART III	
Setting Word 12	II-1-33	III-1. MONITOR DISPLAY DRIVER (MDD)	III-1-1
Setting Word 13	II-1-35	MDD Terminal Control	III-1-1
Selecting the Deadstart Level (NOS)	II-1-36	Command Syntax	III-1-1
Selecting the Deadstart Level (NOS/BE)	II-1-38	MDD Initialization	III-1-2
Selecting the Deadstart Parameters	II-1-39	Conventions	III-1-3
Selecting the CMRDECK (NOS)	II-1-40	MDD Command Explanation and Syntax	III-1-4
Selecting the CMR (NOS/BE)	II-1-41	Central Memory Display Commands	III-1-4
		Display Bytes	III-1-4
		Display CM	III-1-4
		Display Hexadecimal CM	III-1-5
		Display Virtual Memory	III-1-5
		Display Next Central Memory Block	III-1-7
		Display Previous Central Memory Block	III-1-7
		Central Memory Change Commands	III-1-8
		Enter Bytes into Memory	III-1-8
		Enter Central Memory	III-1-8
		Write Across the Bounds Register	III-1-8
II-2. GENERAL CIP PROCEDURES	II-2-1	Maintenance Register Display Commands	III-1-9
Emergency CIP Repair Procedures - Model 800 Computer Systems	II-2-3	Display Maintenance Registers	III-1-9
Installing an Individual CIP Module	II-2-3	Enter New Maintenance Register Value	III-1-10
Replacing EI, Microcode, SCD, or MDD	II-2-4	Clear Errors on Maintenance Element	III-1-10
Replacing an MSL Module	II-2-4	Master Clear a Maintenance Element	III-1-11
Replacing an HIVS Module	II-2-5	Interpret MCR Bit Settings	III-1-11
Replacing a CTI Module	II-2-5	Interpret UCR Bit Settings	III-1-11
Installing a Patch	II-2-5	Display PP Register Values	III-1-12
Installing a Microcode Patch	II-2-6	Idle PP	III-1-12
Installing a CTI, HIVS, SCD, MDD, or MSL Patch	II-2-7	Restart PP at Specified Address	III-1-13
CIP Utility Procedures	II-2-9	Halt Processor	III-1-13
Performing an Express Deadstart Dump (EDD)	II-2-9	Start Processor	III-1-14
Performing a Printer Dump	II-2-17	Set CPU Value	III-1-14
Selecting an Alternate Deadstart Device	II-2-19	Display the Register File for a Processor	III-1-14
Modify Default Parameters	II-2-20	DFT Commands	III-1-15
Performing a Power-On Initialization (Models 810 through 860 and 990)	II-2-23	Display DFT Block	III-1-15
Clearing ESM (Except Models 810 through 860 and 990)	II-2-24	Set DFT Flag	III-1-16
Loading and Installing Disk Subsystem Microcode from CIP Tape	II-2-27	Control Store Commands	III-1-17
Operator Intervention Procedures	II-2-28	Display Eight-Byte Control Store	III-1-17
		Display Sixteen-Byte Control Store	III-1-18

Enter Eight-Byte Control Store	III-1-19	Set Refresh Rate	III-1-22
Enter Sixteen-Byte Control Store	III-1-20	Display MDDs Commands	III-1-22
Miscellaneous Commands	III-1-21	ESC Key	III-1-22
Return MDD PP to the Operating System	III-1-21	Other Messages to the Terminal	III-1-23
Set Refresh Mode	III-1-21	Error Log/Dayfile Messages	III-1-25
		Examples of MDD Command Usage	III-1-26
		Registers Displayed by MDD	III-1-30

APPENDIXES

A. GLOSSARY	A-1	Models 835 through 860 PP Reconfiguration	G-8
B. CIP ERROR MESSAGES	B-1	Models 810, 815, 825, 830, and 990 PP Reconfiguration	G-10
C. FIELD CHANGE ANNOUNCEMENT (FCA) INTERPRETATION FOR MODEL 800 COMPUTER SYSTEMS	C-1	Reconfiguring 10-PP System	G-10
D. PROBLEM REPORTING	D-1	Reconfiguring 15-PP System	G-10
E. HARDWARE INITIALIZATION VERIFICATION SOFTWARE (HIVS) TESTS	E-1	Reconfiguring 20-PP System	G-10
F. PERIPHERAL PROCESSOR (PP) CONFIGURATIONS	F-1	CM Reconfiguration for CYBER 170 Computer Systems (Except Models 815, 825, 835, 845, and 855)	G-12
G. MAINFRAME RECONFIGURATION	G-1	CM Reconfiguration for Models 810 and 830	G-18
PP Reconfiguration	G-1	CM Reconfiguration for Models 815, 825, 835, 840, 845, 850, 855, 860 and 990	G-19
Turning Off PPs	G-1	H. BINARY PATCH UTILITY	H-1
CYBER 70/6000 Computer Systems	G-4	On-Line Binary Patch Utility (BINEDIT)	H-1
PP Reconfiguration	G-4	BINEDIT Directives	H-1
CYBER 170 Computer Systems (Except Models 815, 825, 835, 845, and 855) PP Reconfiguration	G-4	BINEDIT Example	H-5
		BINEDIT Error Messages	H-6
		I. CC634B CONSOLE INITIALIZATION	I-1

DISPLAYS

Models 810 and 830 Displays	I-2-13	Build Deadstart Disk	I-2-36
I-2-1 Initial Options From Disk	I-2-14	Manual Operations	I-2-38
I-2-2 Operator Intervention	I-2-15	CAU Initial Options	I-2-39
I-2-3 Hardware Reconfiguration	I-2-16	Utilities, Tape Deadstart	I-2-40
I-2-4 Reconfigure CPU Elements	I-2-17	Dump to Printer Options	I-2-41
I-2-5 Deadstart Panel Parameters	I-2-17	Alternate Deadstart	I-2-42
I-2-6 Deadstart Device	I-2-20	MDD Parameters	I-2-44
I-2-7 Load MDD	I-2-22		
I-2-8 Utilities, Disk Deadstart	I-2-23	Models 815 and 825 Displays	
I-2-9 Dump to Printer Options	I-2-24	I-3-1 Initial Options From Disk	I-3-13
I-2-10 Alternate Deadstart	I-2-25	I-3-2 Operator Intervention	I-3-15
I-2-11 MDD Parameters	I-2-27	I-3-3 Hardware Reconfiguration	I-3-16
I-2-12 Initial Options From CIP Tape	I-2-28		
	I-2-28		
	I-2-35		

FIGURES

I-2-1	Overview of Displays and Options for Deadstart from Disk (Models 810 and 830)	I-2-11	II-1-6	Coldstart of Disk Controller from Card Reader	II-1-21
I-2-2	Overview of Displays and Options for Deadstart from CIP Tape (Models 810 and 830)	I-2-33	II-1-7	Coldstart of 7152/7155/7165 Disk Controller from Disk Unit	II-1-23
I-3-1	Overview of Displays and Options for Deadstart from Disk (Models 815 and 825)	I-3-11	II-1-8	Coldstart/Warmstart of 834/836 Disk from Disk Unit	II-1-24
II-3-2	Overview of Displays and Options for Deadstart from CIP Tape (Models 815 and 825)	I-3-31	II-1-9	Coldstart of 639 Tape Unit from Tape on Channel with a PP	II-1-25
I-4-1	Overview of Displays and Options for Deadstart from Disk (Models 835 through 860)	I-4-11	II-1-10	Coldstart of 639 Tape Unit from Tape on Channel with No PP	II-1-25
I-4-2	Overview of Displays and Options for Deadstart from CIP Tape (Models 835 through 860)	I-4-33	II-1-11	Warmstart	II-1-28
I-5-1	Overview of Displays and Options for Deadstart from Disk (Models 865 and 875)	I-5-9	II-1-12	CYBER 170 and CYBER 180 Computer Systems Panel Settings for Warmstart from Channel with a PP (For Example, Channel 1, 2, or 11)	II-1-31
I-5-2	Overview of Displays and Options for Deadstart from CIP Tape (Models 865 and 875)	I-5-25	II-1-13	CYBER 70 and 6000 Computer Systems Panel Settings for Warmstart from Channel with a PP (For Example, Channel 1, 2, or 11)	II-1-31
I-6-1	Overview of Displays and Options for Deadstart from Disk (Non-Model-800 Computer Systems)	I-6-9	II-1-14	Panel Settings for Warmstart from Channel with No PP (For Example, Channel 0, 12, or 13)	II-1-32
I-6-2	Overview of Displays and Options for Deadstart from CIP Tape (Non-Model-800 Computer Systems)	I-6-25	C-1	How to Read the FCA Chart	C-2
I-7-1	Overview of Displays and Options for Deadstart from Disk (Model 990)	I-7-11	G-1	Sample Reconfiguration	G-2
I-7-2	Overview of Displays and Options for Deadstart from CIP Tape (Model 990)	I-7-33	G-2	Sample Reconfiguration for a Bad PP	G-3
II-1-1	CYBER 170 Computer Systems (Except Models 815, 825, 835, 845, and 855) Deadstart Panel	II-1-14	G-3	PP MEMORY SELECT Switches	G-4
II-1-2	CYBER 70/6000 Computer Systems Deadstart Panel	II-1-15	G-4	Reconfiguration of Barrel 0 for CYBER 170 Computer Systems	G-6
II-1-3	Models 835 through 860 Deadstart Panel	II-1-16	G-5	Sample Reconfiguration Using the PP MEMORY SELECT Switches for CYBER 170 Computer Systems (Except Models 815, 825, 835, 845, and 855)	G-7
II-1-4	Coldstart of 7021/7152 Tape Controller from Card Reader	II-1-18	G-6	Sample Model 835 through 860 PP Reconfiguration	G-8
II-1-5	Coldstart of 7152 Tape Controller from Tape Unit	II-1-19	G-7	PPM Switches	G-9
			G-8	Sample Model 835 through 860 Reconfiguration Using PPM Switches	G-9
			G-9	Sample Reconfiguration for Models 815 and 825 with 15 PPs	G-11
			G-10	Sample Reconfiguration for Models 810, 815, 825, and 830 and 990 With 20 PPs	G-12

G-11	Switch Numbering Scheme for CYBER 170 Computer Systems Models 171, 172, 173, 174, 720, and 730	G-17	G-15	Switch Numbering Scheme for Models 835, 845, and 855 without Memory Upgrade Option	G-23
G-12	Switch Numbering Scheme for CYBER 170 Computer Systems Models 175, 176, 740, 750, 760, 865, and 875	G-17	G-16	Switch Numbering Scheme for Models 845 and 855 with Memory Upgrade Option and for Models 840, 850, and 860	G-24
G-13	Switch Numbering Scheme for Models 815 and 825 without Memory Upgrade Option	G-20	G-17	Switch Numbering Scheme for Model 990	G-25
G-14	Switch Numbering Scheme for Models 815 and 825 with Memory Upgrade Option	G-22			

TABLES

I-2-1	Hardware Reconfiguration Entries, Models 810 and 830	I-2-18	I-5-4	Keyboard Entries for a Printer Dump, Models 865 and 875	I-5-32
I-2-2	Keyboard Entries for the Deadstart Panel Parameters Display, Models 810 and 830	I-2-21	I-6-1	HIVS Tests by Computer System	I-6-13
I-2-3	Keyboard Entries for a Printer Dump, Models 810 and 830	I-2-25	I-6-2	Hardware Reconfiguration Entries, Non-Model-800 Computer Systems	I-6-14
I-2-4	Keyboard Entries for a Printer Dump, Models 810 and 830	I-2-41	I-6-3	Keyboard Entries for the Deadstart Panel Parameters Display, Non-Model-800 Computer Systems	I-6-16
I-3-1	Hardware Reconfiguration Entries, Models 815 and 825	I-3-17	I-6-4	Keyboard Entries for a Printer Dump, Non-Model-800 Computer Systems	I-6-20
I-3-2	Keyboard Entries for the Dead- start Panel Parameters Display, Models 815 and 825	I-3-20	I-6-5	Keyboard Entries for a Printer Dump, Non-Model-800 Computer Systems	I-6-31
I-3-3	Keyboard Entries for a Printer Dump, Models 815 and 825	I-3-24	I-7-1	Hardware Reconfiguration Entries, Model 990	I-7-19
I-3-4	Keyboard Entries for a Printer Dump, Models 815 and 825	I-3-39	I-7-2	Keyboard Entries for the Deadstart Panel Parameters Display, Model 990	I-7-22
I-4-1	Hardware Reconfiguration Entries, Models 835 through 860	I-4-18	I-7-3	Keyboard Entries for a Printer Dump, Model 990	I-7-27
I-4-2	Keyboard Entries for the Dead- start Panel Parameters Display, Models 835 through 860	I-4-21	I-7-4	Keyboard Entries for a Printer Dump, Model 990	I-7-41
I-4-3	Keyboard Entries for a Printer Dump, Models 835 through 860	I-4-26	II-1-1	Deadstart Parameters Switch Settings	II-1-40
I-4-4	Keyboard Entries for a Printer Dump, Models 835 through 860	I-4-41	F-1	Channels That Are Not Connected to an Active PP	F-1
I-5-1	Hardware Reconfiguration Entries, Models 865 and 875	I-5-15	G-1	Deadstart PP Reconfiguration	G-5
I-5-2	Keyboard Entries for the Deadstart Panel Parameters Display, Models 865 and 875	I-5-17	G-2	CM Reconfiguration for Models 171, 172, 173, and 174	G-14
I-5-3	Keyboard Entries for a Printer Dump, Models 865 and 875	I-5-20	G-3	CM Reconfiguration for Model 175	G-15
			G-4	CM Reconfiguration for Models 176, 740, 750, and 760	G-15

G-5	CM Reconfiguration for Models 720 and 730	G-16	G-10	CM Reconfiguration for Models 835, 845, and 855 without Memory Upgrade Option	G-22
G-6	CM Reconfiguration for Models 865 and 875	G-16	G-11	CM Reconfiguration for Models 845 and 855 with Memory Upgrade Option and for Models 840, 850, and 860	G-23
G-7	CM Reconfiguration for Models 810 and 830 without Memory Upgrade Option	G-20	G-12	CM Reconfiguration for Model 990	G-25
G-8	CM Reconfiguration for Models 815 and 825 without Memory Upgrade Option	G-21			
G-9	CM Reconfiguration for Models 810, 815, 825, and 830 with Memory Upgrade Option	G-21			

PART I

INTRODUCTION

1

The CYBER Initialization Package (CIP) provides a simple process for distributing and installing the following hardware/software interface modules.

- Common Test and Initialization (CTI)
- Environment Interface (EI)
- Hardware Initialization and Verification Software (HIVS)/Maintenance Software Library (MSL)
- Microcode
- Monitor Display Driver (MDD)
- System Console Driver (SCD)
- Dedicated Fault Tolerance (DFT)
- NOS/VE Boot Programs

CIP combines the modules into a single release package and simplifies the installation process so that all of the CIP modules are automatically installed to disk when you select just one installation option.

CIP module combinations for individual computer systems follow.

- For CYBER 180 Computer Systems and for CYBER 170 models 815, 825, 835, 840, 845, 850, 855, 860, and 990. CIP contains CTI, EI, MDD, microcode, MSL, DFT, NOS/VE programs, and SCD.
- For CYBER 170 models 865 and 875, CIP contains CTI and MSL.
- For CYBER 170 models 170 and 700; CYBER 70 models 71, 72, 73, and 74; and 6000 Computer Systems, CIP contains CTI and HIVS.

The automatic installation process requires one deadstart, a single tape, and a minimum number of steps.

CAUTION

For CYBER 170/180 systems using a NOS/VE version previous to 1.2.1, CIP should not be installed on a NOS/VE device. NOS/VE does not recognize CIP as a read-only disk area and will write over it.

CIP FEATURES

Two CIP features simplify the installation and use of the CIP modules. They are the automatic installation option and the help displays.

AUTOMATIC INSTALLATION OPTION

You can automatically install CIP by selecting a single installation option, which installs all of the CIP modules. CIP is installed to coexist with operating system information on the deadstart disk.

Automatic installation can be performed either in initialize or update mode. Initialize mode initializes the deadstart disk and installs CIP, preserving no other information. Update mode installs CIP to the deadstart disk and preserves operating system information on the disk, including permanent files.

NOTE

The options to install CIP modules individually are provided for emergency CIP repair only.

HELP DISPLAYS

The CTI module includes help displays that assist you in executing most of the deadstart utilities without consulting a manual.

CONSIDERATIONS FOR SITES WITH CYBER 170 AND CYBER 180 MODEL 800 COMPUTER SYSTEMS

CIP benefits sites with CYBER 170 and CYBER 180 Model 800 Computer Systems more significantly than sites that do not have non-model-800 computer systems. The following paragraphs explain how the new process affects all model 800 computer systems sites, including sites with models 865 and 875.

CIP RELEASE AND DISTRIBUTION

CIP is released when a change (either a new feature or a correction) is made to one of the CIP modules. A CIP release is planned to occur every 6 months. A critical problem that must be fixed between the planned releases causes an additional CIP release.

CIP is released on a SCOPE Internal (SI) format magnetic tape [recorded in phase encoded (PE) mode] and distributed to model 800 computer systems sites as a Field Change Order (FCO). As an FCO, CIP is sent automatically to the same individual to whom hardware and microcode FCOs are shipped. In general, it is the site customer engineer (CE).

The CE informs the site that the CIP FCO has been received and recommends installation of CIP based on the Field Change Announcement (FCA) data distributed with the FCO. If the FCO is to be installed, the CE and the site must schedule dedicated machine time for CIP installation. The actual installation may be performed by either site personnel or the CE, and requires approximately 20 minutes of machine time.

DISK SPACE REQUIREMENTS

The CIP must be installed to disk. When CIP is installed, disk space is reserved automatically for MSL, which provides the off-line diagnostics. Disk residence of MSL in the production environment facilitates hardware preventive maintenance and reduces problem reaction time. The disk space requirements are:

Disk	Mainframe Models 810-830		Mainframe Models 835-990†
	Full	Short	
844-21	28.0%	17.3%	28.0%
844-4X	14.0%	8.6%	14.0%
885	4.8%	3.1%	4.8%
895	N/A	N/A	8.2%
834	20.0%	12.1%	N/A
836	6.7%	4.1%	N/A

TAILORED CIP

The CIP tape is tailored for each model 800 computer system. For example, an 835 CIP contains microcode and an MSL unique to the CYBER 170 or CYBER 180 model 835.

Each model 800 computer system mainframe in a multimainframe complex receives a CIP FCO. With the following exception, two or more model 800 computer systems mainframes in a site's complex can share a disk containing CIP, if the mainframes are of the same type and at the same FCO level. The CYBER 170 model 865 and 875 mainframes are an exception to this guideline. CIP is the same for these mainframes, and, therefore, a CYBER 170 model 865 and a CYBER 170 model 875 mainframe can share a disk containing CIP.

†Not applicable to models 865 and 875.

SINGLE CTI COPY

One of the objectives of CIP is to release only one copy of any of the modules. CTI is a part of the CIP tape. Therefore, operating system deadstart tapes received with a NOS or NOS/BE order do not contain a copy of CTI.

NOTE

Sites may use a deadstart tape containing CTI as the operating system load file. However, the CTI on the deadstart tape cannot be used to initialize the mainframe; no operating system tape deadstart capability is provided.

SITES WITH NO MAINTENANCE CONTRACT

Model 800 computer systems installed at sites with no maintenance contract will receive a CIP tape containing HIVS instead of MSL (HIVS is a subset of MSL) upon receipt of the computer system. To order a new CIP after that, the marketing representative must send LDS Data Form #AA5570 to Software Manufacturing and Distribution, ARH 230, specifying the computer system model.

CONSIDERATIONS FOR SITES WITH NON-MODEL-800 COMPUTER SYSTEMS

The effect of the CIP process on sites with CYBER 170 models 170 and 700, CYBER 70 model 70, and 6000 Computer Systems is minimal.

The CIP tape replaces the HIVS tape. CIP content and function are the same as HIVS in that the CIP tape:

- Contains CTI and HIVS modules.
- Is distributed with an operating system order (not as an FCO).
- Provides hardware verification sequencer and deadstart utilities.
- Provides disk deadstart capability if installed to disk.

NOTE

Disk residence of CIP is not a requirement.

The difference between the CIP tape and HIVS tape is that the installation of the CIP tape is easier and the deadstart displays are more usable.

Unlike operating system deadstart tapes provided for model 800 computer systems sites, operating system deadstart tapes for these mainframe types contain a copy of CTI.

To order CIP, the CDC marketing representative must send LDS Data Form #AA5570 to Software Manufacturing and Distribution, ARH 230, specifying the mainframe type.

CIP PROCEDURES, DISPLAYS, AND OPTIONS FOR CYBER 180 MODELS 810 AND 830

2

This section includes CIP automatic installation procedures, operating system deadstart procedures, and descriptions of CIP displays and options available to users of CYBER 180 models 810 and 830.

This section refers to the deadstart displays that are presented after deadstart is initiated. The initial deadstart display and use of the deadstart program are described in part II, section 1 of this handbook. Other displays referenced are described in part II, section 2 of this handbook.

CAUTION

For CYBER 170/180 systems using a NOS/VE version previous to 1.2.1, CIP should not be installed on a NOS/VE device. NOS/VE does not recognize CIP as a read-only disk area and will write over it.

CIP INSTALLATION

The CIP modules must be installed to disk for models 810 and 830. Select a disk unit in your configuration to be the deadstart disk. The installation process installs the CIP modules to the deadstart disk so that operating system information can also reside on the disk.

Complete the following procedure to initially install CIP to the deadstart disk or to update CIP on the deadstart disk. The installation procedure requires dedicated machine time. At least one tape drive and one disk unit must be available. The procedure assumes that controlware has been loaded into the peripheral controller(s). If the controlware is not loaded, refer to part II, section 1 of this handbook for coldstart instructions.

1. Mount the CIP tape on a tape drive.
2. Press the deadstart button on a CC545 to initiate deadstart from the tape. The Deadstart Options display appears.

If a CC634B with option GK427A is being used as the primary console (required for NOS/VE standalone), press deadstart button and go to step 3.

If a CDC CC634B is being used as the primary console complete the following steps to bring up the Deadstart Options display:

- a. Press the RESET button to reinitialize the console.
 - b. Hold down the CTRL key while pressing the G key.
 - c. When the message *OPERATOR ACCESS ENABLED appears on the screen, hold down the CTRL key while pressing the R key.
3. Enter an S to select the short deadstart sequence if the deadstart program selected is for deadstart from CIP tape.

Otherwise, perform the following steps if the deadstart program selected is not for deadstart from CIP tape.

- a. Enter an M to select the Maintenance Options display.
- b. Enter or retrieve the deadstart from CIP tape program as described under Warmstart Procedure for Models 810, 815, 825, and 830 in part II, section 1.
- c. Enter an S to select the short deadstart sequence.

NOTE

For model 810 and 830 mainframe sites with no maintenance contract, enter an I to initialize the disk and install CTI and HIVS. Although the CIP tape for such sites contains no off-line maintenance diagnostics, it must be installed to the deadstart disk.

4. Press the carriage return key to select the default option. The Build Deadstart Disk display appears.

CAUTION

Do not proceed until you have read all the instructions for step 5.

5. For first time installation of the CIP, enter either S, to select the short installation option, or enter F, to select the full installation option, based on the following information.

NOTE

The short and full installation options destroy all information on the deadstart disk, except for the disk microcode, prior to installing CIP. Before executing either the short or full installation option, be sure you have a backup copy of any information on the deadstart disk that you want to preserve, including operating system permanent files and CE command buffers.

After executing the short or full option, you must perform an operating system initialization of the disk.

- S The short installation option initializes the deadstart disk and then installs most of CIP. The CIP tape contains off-line maintenance diagnostics that the CE uses to execute mainframe tests for preventive maintenance or to diagnose a hardware error. The short option installs a predefined set of diagnostics (diagnostics that the CE uses frequently). Those used infrequently can be loaded and executed from the CIP tape when needed. The short installation option reserves 15 megabytes of disk storage for the CIP.
- F The full installation option initializes the deadstart disk and installs all of CIP. The full installation option reserves 25 megabytes of disk storage for CIP.

For reinstallation of CIP some time after the initial installation, enter U to select the update option.

- U The update option replaces CIP on the deadstart disk and preserves operating system information on the deadstart disk, including permanent files. The update option replaces CIP in the same mode, short or full, that was used when the deadstart disk was initialized.

The CIP modules replaced during an Update are:

- CTI
- EI
- MSL (includes command buffers)
- Microcode
- MDD
- SCD
- DFT
- NOS/VE Programs

Information saved during an Update includes:

Deadstart error log (DEL)
Default parameter block
Operating system pointers and permanent files
NOS/VE system file pointers
Mainframe Reconfiguration Table (MRT)

6. Enter the channel, equipment, and unit numbers of the deadstart disk when prompted. Follow each entry by pressing the carriage return key. Press only the carriage return key to select the displayed default value.
7. CIP installation is complete when the message INSTALLATION COMPLETE appears.

You can now perform an operating system load, off-line maintenance, default deadstart device definition, or other deadstart utility operation. Refer to part II, section 2.

OPERATING SYSTEM DEADSTART

An operating system deadstart can be performed on models 810 and 830 only when CIP has been installed on disk. Procedures included here are for operating system deadstart when the deadstart program is set for deadstart from disk, which is known as disk deadstart. Operating system tape deadstart is not supported for models 810 and 830. Operating system load from a tape file, however, is supported for models 810 and 830 through the disk deadstart process.

The operating system deadstart procedures require at least one disk unit and, when the operating system file is on tape, one tape unit. The procedures assume that controlware has been loaded into the peripheral controller(s). If the controlware is not loaded, refer to part II, section 1 for coldstart instruction.

DISK DEADSTART

This procedure assumes that:

- The deadstart program shown as selected on the Deadstart Option display is set for deadstart from disk.
- CIP has been installed to disk. Refer to CIP Installation earlier in this section.

If the operating system file has also been installed to disk, a complete disk deadstart can be performed. Refer to the NOS 2 Analysis Handbook, INSTALL command, to find out how to install the NOS file to disk. The NOS/BE level 0 deadstart process automatically installs the NOS/BE file on disk for use on following deadstarts. For NOS/VE standalone, refer to the NOS/VE Installation Reference Manual for procedures to install NOS/VE to disk.

Operating System File on Disk

1. Press the deadstart button on a CC545 display (NOS or NOS/BE only). The Deadstart Options display appears.

If a CC634B with option GK427A is being used as the primary console (required for NOS/VE standalone), press deadstart button and go to step 2.

If a CC634B is being used as the primary console for Deadstarts, complete the following steps to bring up the Deadstart Options display:
 - a. Press the RESET button to reinitialize the console.
 - b. Hold down the CTRL key while pressing the G key.
 - c. When the message *OPERATOR ACCESS ENABLED appears on the screen, hold down the CTRL key while pressing the R key. The Deadstart Options display appears.
2. Enter S, then press the carriage return key. The Initial Options display appears.
3. Press the carriage return key to select the default option, automatic OS load. This option assumes that the deadstart program is set correctly for deadstart level (0, 1, 2, 3) and for CMRDECK selection (NOS), or for CMR selection (NOS/BE), or for DCFIL selection (NOS/VE).

If the deadstart program is set correctly, operating system deadstart is initiated.

4. If the deadstart program is not set correctly for these selections, enter 0 to select the operator intervention option. Operator intervention also allows reconfiguration of mainframe hardware components and execution of the hardware verification sequences. For specific information regarding operator intervention options, turn to Displays and Options for Deadstart From Disk later in this section.

Operating System File on Tape or Alternate Disk

1. Press the deadstart button on a CC545 console for NOS or NOS/BE only. The Deadstart Options display appears.

If a CC634B with option GK427A is being used as the primary console (required for NOS/VE standalone), press deadstart button and go to step 2.

If a CC634B is being used as the primary console for Deadstarts, complete the following steps to bring up the Deadstart Options display:

- a. Press the RESET button to reinitialize the console.
 - b. Hold down the CTRL key while pressing the G key.
 - c. When the message *OPERATOR ACCESS ENABLED appears on the screen, hold down the CTRL key while pressing the R key.
2. Enter S or press the carriage return key. The Initial Options display appears.
 3. Enter 0 to select the operator intervention option. The Operator Intervention display appears.
 4. If the deadstart program is not set correctly for deadstart level and for CMRDECK selection (NOS) or CMR selection (NOS/BE) or DCFILE selection (NOS/VE), enter P to select the deadstart parameters option, before proceeding. Operator intervention also allows reconfiguration of the mainframe hardware components and execution of hardware verification sequences. For specific information regarding operator intervention options, refer to Displays and Options for Deadstart From Disk, next.
 5. Enter S to select tape or alternate disk deadstart.
 - a. Tape Deadstart
 1. Enter T to deadstart using a tape.
 2. Enter tape type, channel, equipment, and unit when prompted.†
 - b. Alternate Disk Deadstart.
 1. Enter D to select alternate disk deadstart.
 2. Enter disk channel, equipment, and unit when prompted.†
 6. Press the carriage return key. Operating System deadstart is initiated.†
 7. You will see messages showing that NOS, NOS/BE, or NOS/VE is loading programs and running tests.

†Applicable for NOS and NOS/BE deadstarts only. For NOS/VE deadstarts, the Operating System deadstart sequence is initiated upon selecting the D or T option. (Reference the NOS/VE Operations Manual for more information on NOS/VE Deadstarts.)

DISPLAYS AND OPTIONS FOR DEADSTART FROM DISK

The CIP disk deadstart displays and options included in this section incorporate the following conventions:

- The default option on a menu display is the first option listed. The option can be selected automatically by pressing the carriage return key.
- Help information is provided for the Initial Options displays and the Build Deadstart Disk display. The Help displays supply brief information about the options. More detailed option information is given elsewhere in this section.
- Pressing the backspace key allows you to return to the previous display.

OVERVIEW

Figure I-2-1 provides an overview of the displays and options available during a deadstart from disk on models 810 and 830.

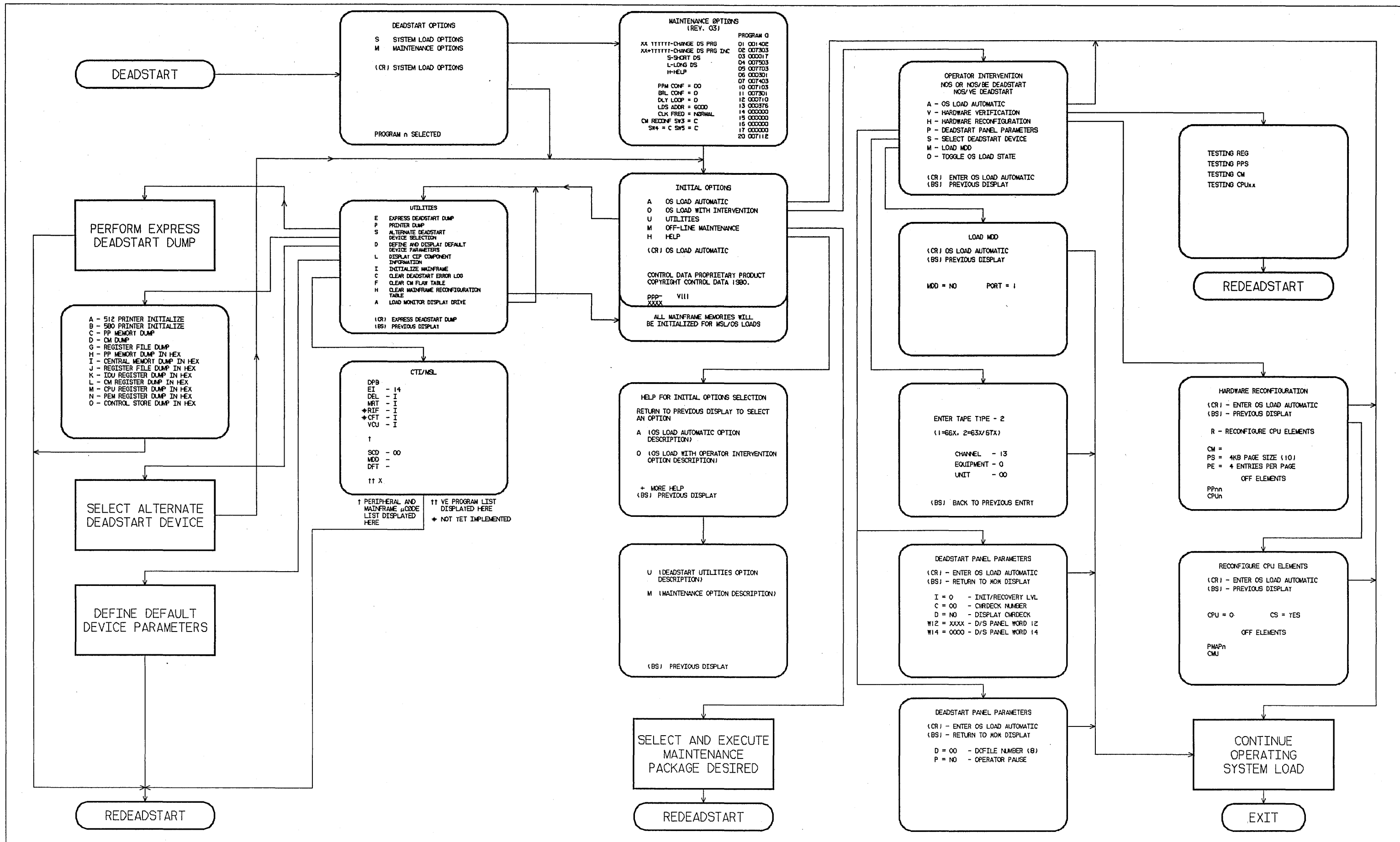

Figure I-2-1. Overview of Displays and Options for Deadstart From Disk (Models 810 and 830)

INITIAL OPTIONS DISPLAY

The Initial Options display, display I-2-1, is the first screen that appears after deadstart is initiated.

The Initial Options display provides operating system load, execution of off-line maintenance, and deadstart utilities when the deadstart program is set for deadstart from disk.

```

          INITIAL OPTIONS

A   OS LOAD AUTOMATIC
O   OS LOAD WITH INTERVENTION
U   UTILITIES
M   OFF-LINE MAINTENANCE
H   HELP

(CR) OS LOAD AUTOMATIC

CONTROL DATA PROPRIETARY PRODUCT
COPYRIGHT CONTROL DATA 1980.

ppp-   VIII
XXXX
    
```

CIP01A

Display I-2-1. Initial Options From Disk

<u>Option</u>	<u>Description</u>
(CR) or A	OS Load Automatic. The system initialization software assumes that CIP has been installed to the deadstart disk. The system loads modules from the deadstart disk into memory and the central processor to establish the operating environment. Then, confidence tests verify the ability of PP memory to hold simple data patterns and preset PP memory contents to all ones.
	If the system detects a fatal error during confidence testing, CTI records the errors in the deadstart error log (DEL), if it is empty, for later processing by the operating system. The following information appears on the left screen.
	DEADSTART ABORTED - FATAL ERROR
	<pre> eeee-nn rrrr =cc cc cc cc cc cc cc cc rrrr =cc cc cc cc cc cc cc cc rrrr =cc cc cc cc cc cc cc cc </pre>

Option

Description

Notation

Description

eeee-nn Name and logical number of the hardware that has the error.

Name

Hardware

IOU-00

Input/output unit.

MEM-00

Central memory.

PROC-0n

Central processing unit. n=logical number.

rrrr Register name.

cc Register content in hexadecimal notation.

Inform a CE when a fatal error occurs.

The ENTER DATE and ENTER TIME prompts are displayed on the model 810 and 830 systems only when the Two Port Mux wall clock is invalid and:

- a. The operator has selected a NOS/VE load, or
- b. The operating system being loaded supports CTI as the primary source of current date and time.

NOTE

The smallest unit of time that can be written to the Two Port Mux is minutes. If clock accuracy to within 1 second is desired, the operator should enter the desired seconds. However, this causes CTI to delay to the next minute before writing the clock and continuing the deadstart. Example: If the operator enters a time of 08:15:05, CTI delays for 55 seconds, and writes the clock with a time of 08:16:00. The informative message Updating Clock is added to the display during the delay.

If clock accuracy to within 1 minute is sufficient, the operator can enter 00 seconds and CTI writes the clock without delaying the deadstart.

Anytime the time entry is hh hours, 59 minutes, ss seconds, CTI writes the clock as hh:59:00. Example: If the operator enters 14:59:59, CTI writes the clock as 14:59:00.

<u>Option</u>	<u>Description</u>
O	OS Load With Operator Intervention. Select this option to execute the hardware verification sequences, to reconfigure mainframe hardware components, or to change the operating system deadstart level or CMRDECK selection specified in the deadstart program. Refer to the Operator Intervention display, display I-2-2, later in this section for more information.
U	<p>Utilities. Select this option to:</p> <ul style="list-style-type: none"> • Perform an Express Deadstart Dump (dump memories and registers to tape). • Perform a printer dump. • Deadstart from a different device. • Define default device parameters. • Display CIP component levels. • Initialize the mainframe after power interruption or maintenance activity. • Clear deadstart error log (DEL). • Load the monitor display driver (MDD) in NOS/VE standalone mode. • Clear the central memory flaw table. • Clear the mainframe reconfiguration table (MRT). <p>Refer to the Utilities display, display I-2-8, later in this section for more information.</p>
M	<p>Off-Line Maintenance. This option enables the CE to execute hardware tests for preventive maintenance or hardware error diagnosis. Information about the option is included in the MSL 15X Reference Manual.</p> <p>The contents of word 12 of the deadstart program also affect the M option. Refer to Setting Word 12 in part II, section 1 of this manual.</p>
H	<p>Help for Initial Option Selection.</p> <p>When the CC634B console is being used, press H or the HELP key for a description of the initial options.</p>

The CIP level, ppp- V111, is displayed at the bottom of the Initial Options display; ppp is mainframe type, and 111 is the CIP version level. At the very bottom of the display, xxxx is the PSR level.

OPERATOR INTERVENTION DISPLAY

The Operator Intervention display, display I-2-2, appears when you select option 0, operator intervention, from the Initial Options display.

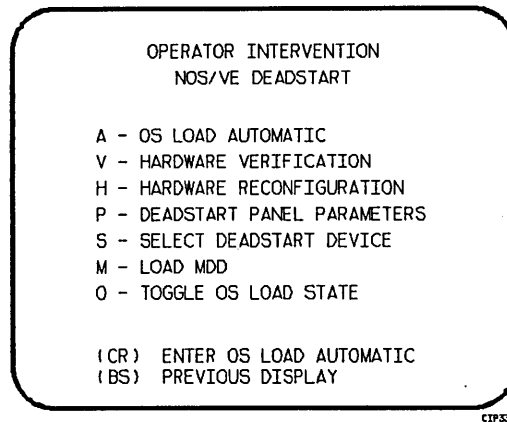
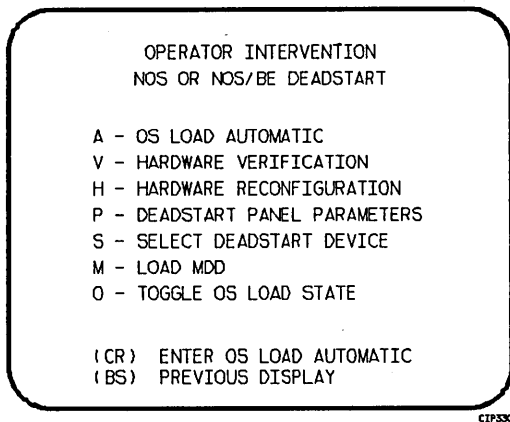

Display I-2-2. Operator Intervention

<u>Option</u>	<u>Description</u>
(CR) or A	OS Load Automatic. Select this option to perform an operating system load. Refer to the description of the OS Load Automatic option on the Initial Options display, display I-2-1, earlier in this section for more information.
V	Hardware Verification Sequence. Select this option to execute PP, CM, and CPU confidence tests.
	If you have selected either a level 0, 1, or 2 deadstart, central memory contents are changed when you execute this option. The V option cannot be executed if a level 3 deadstart is selected.
	You cannot test hardware that has been turned off via option H, Hardware Reconfiguration.
	The names of the tests used by HIVS for the models 810 and 830 are CMC, CT8, EJP, and MY1. Appendix E includes a brief description of each test.
	If an error condition occurs, one of the following messages appears.
	<pre> ERROR PP xx ERROR CM ERROR CPU xx ERROR REG </pre>
	xx indicates the PP or CPU in error. Inform a CE.
	Upon successful test completion, the system displays:
	TESTING COMPLETE-DEADSTART
	Initiate deadstart after testing to ensure that the system is returned to initial deadstart condition prior to system loading or recovery.

Option

Description

H Hardware Reconfiguration. Select this option to alter the mainframe hardware configuration. When selected, display I-2-3 appears:

```
HARDWARE RECONFIGURATION
(CR) - ENTER OS LOAD AUTOMATIC
(BS) - PREVIOUS DISPLAY

R - RECONFIGURE CPU ELEMENTS

CM = †
PS = 4KB PAGE SIZE (10)
PE = 4 ENTRIES PER PAGE

OFF ELEMENTS

PPnn
CPUh
```

CIP04A

†IF NOS/VE DEADSTART, CM = MB CM SIZE (10); IF NOS or NOS/BE DEADSTART, CM = CM WORDS/100B.

Display I-2-3. Hardware Reconfiguration

The hardware reconfiguration display permits you to reconfigure central memory elements. To reconfigure CPU elements, enter an R while displaying the Hardware Reconfiguration display to select the display. The display, shown in display I-2-4, permits you to reconfigure CPU elements.

```
RECONFIGURE CPU ELEMENTS
(CR) - ENTER OS LOAD AUTOMATIC
(BS) - PREVIOUS DISPLAY

CPU = 0          CS = YES

OFF ELEMENTS

PMAPh
CMU
```

CIP04A

Display I-2-4. Reconfigure CPU Elements

The default hardware configuration includes every hardware element available for use. To change the hardware configuration, enter the appropriate entry on the or display as described in table I-2-1. When you turn off an element, its identifier is added to the OFF ELEMENTS list on the display. Entries are in the form keyword=option.

Table I-2-1. Hardware Reconfiguration Entries, Models 810 and 830 (Sheet 1 of 2)

Keyword	Option	Display †	Function																					
CM= ††	nnnnnnn	*1	<p>Specifies the size, in octal if NOS or NOS/BE, of central memory in hundreds of words. If NOS/VE standalone, the cm size is specified and entered in decimal megabytes. The following examples show the value you enter for nnnnnnn, given the central memory size for NOS or NOS/BE.</p> <table border="0"> <thead> <tr> <th>Central Memory Size in Decimal Words</th> <th>Central Memory Size in Megabytes</th> <th>nnnnnnn</th> </tr> </thead> <tbody> <tr> <td>131K</td> <td>1</td> <td>4000</td> </tr> <tr> <td>262K</td> <td>2</td> <td>10000</td> </tr> <tr> <td>524K</td> <td>4</td> <td>20000</td> </tr> <tr> <td>1048K</td> <td>8</td> <td>40000</td> </tr> <tr> <td>2097K</td> <td>16</td> <td>100000</td> </tr> <tr> <td>4195K†††</td> <td>32†††</td> <td>200000</td> </tr> </tbody> </table> <p>If you enter CM=0 or do not enter the CM=nnnnnnn parameter, the system sets the maximum central memory size.</p> <p>If you specify a value for nnnnnnn that exceeds the amount of physical memory, the system sends the following message:</p> <p style="text-align: center;">UNAVAILABLE</p> <p>If you specify a central memory size that is not large enough for a system deadstart, the system sets the maximum central memory size and the following message appears:</p> <p style="text-align: center;">INVALID ENTRY</p>	Central Memory Size in Decimal Words	Central Memory Size in Megabytes	nnnnnnn	131K	1	4000	262K	2	10000	524K	4	20000	1048K	8	40000	2097K	16	100000	4195K†††	32†††	200000
Central Memory Size in Decimal Words	Central Memory Size in Megabytes	nnnnnnn																						
131K	1	4000																						
262K	2	10000																						
524K	4	20000																						
1048K	8	40000																						
2097K	16	100000																						
4195K†††	32†††	200000																						
CPU=	n	*2	<p>Specifies the CPU for which you are to reconfigure elements. The CPU specified must be ON.</p>																					
CPU _n = ††	OFF/ON	*1	<p>Specifies the logical status of each available CPU. Values for n can be 0 or 1.</p> <p>On a two-CPU system, at least one must be ON.</p> <p>If you enter CPU₀=OFF on a one-CPU system, the entry is a no-op; the system uses the CPU.</p>																					
CMU= ††	OFF/ON	*2	<p>Specifies logical status of the compare/move unit hardware.</p>																					

Table I-2-1. Hardware Reconfiguration Entries, Models 810 and 830 (Sheet 2 of 2)

Keyword	Option	Display †	Function
PPnn= ††	OFF/ON	*2	Logically turn OFF/ON one or more peripheral processors. Acceptable values for nn are 3 through 11 (excluding 10) and, if you have them, 20 through 31. Ranges may be specified. For example, PP5-7=OFF.
PMapn= ††	OFF/ON	*2	Specifies the logical status of each unit of the central processor page map. The value for n can be any number from 0 to 3. The value for n also can be in the form a-b (a through b); a and b can be any number from 0 to 3, and a is less than b. Turn OFF a page map unit only in the event of a hardware error. System performance degrades when a map unit is turned OFF.
CS= ††	YES/NO	*2	Specifies whether the system should load the central processor microcode into control store memory. The default is YES for all levels of deadstart. If NO is specified, the system does not load microcode from the deadstart disk into control store; whatever is there is used.
PS= ††	xx	*1	Specifies the NOS/VE page size for standalone or dual state deadstarts. The allowable page sizes in decimal kilobytes are 4, 8, 16, 32, and 64 (default=4).
PE= ††	x	*1	Specifies the NOS/VE entries per page table page for standalone or dual state deadstarts. The allowable values are 2, 4, and 8 (default=4).
<p>†*1 = Hardware Reconfiguration Display; *2 = Reconfigure CPU Elements Display. ††This value is saved until changed for all deadstarts in the mainframe reconfiguration table for CYBER 180 mainframe. †††Available only on models with memory upgrade option installed.</p>			

Option

Description

P Deadstart Panel Parameters for NOS or NOS/BE. Select this option to change any of the following: the deadstart level, the CMRDECK, or deadstart program words 12 and 14. The Deadstart Panel Parameters display, display I-2-5, appears.

Press the carriage return key to cause system deadstart processing to continue with no further intervention on your part. You cannot select additional options after this entry.

Press the backspace key to return to the Operator Intervention display.

Table I-2-2 lists the keyboard entries that you can make to change deadstart panel (program) parameters.

P Deadstart Panel Parameters for NOS/VE. Select this option to change the (NOS/VE) DCFILE or the operator pause entry.

NOS or NOS/BE

NOS/VE

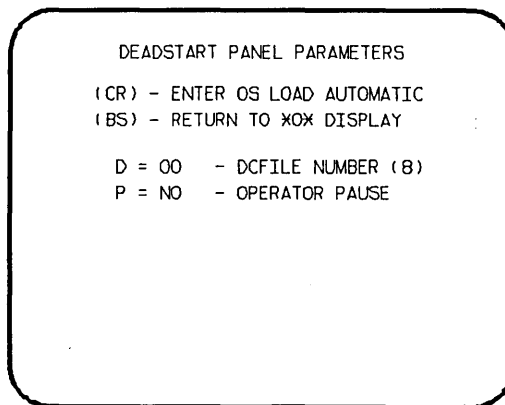
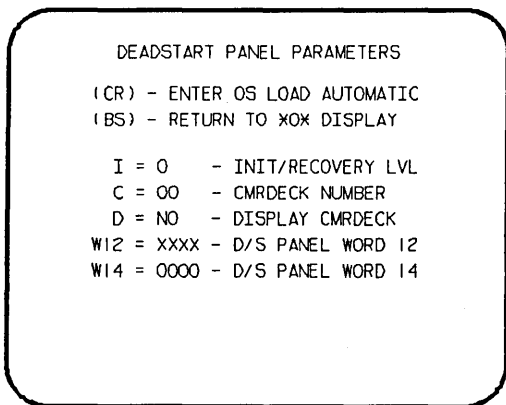

Display I-2-5., Deadstart Panel Parameters

S Select Deadstart Device. Select this option to specify an alternate disk or a tape device as the OS Deadstart Device (figure I-2-6).

Press the carriage return key to cause system deadstart processing to continue with no further intervention on your part. You cannot select additional options after this entry. The CIP disk device is therefore the OS device.

Press the backspace key to return to the Operator Intervention display.

Entry

Description

T Tape OS Deadstart. Select this option for a tape OS deadstart rather than from disk. For NOS or NOS/BE deadstarts, the system prompts you for tape device type, channel, equipment, and unit. For NOS/VE deadstarts, the OS load initiates upon selecting this option.

D Alternate Disk OS Deadstart. Select this option to choose an alternate disk device for the OS deadstart device. For NOS or NOS/BE deadstarts, the system prompts you for the disk channel, equipment, and unit. For NOS/VE deadstarts, the OS load initiates upon selecting this option.

Table I-2-2. Keyboard Entries for the Deadstart Panel Parameters Display, Models 810 and 830

Keyword	Function
	<u>NOS or NOS/BE</u>
I=x	Specifies the level of deadstart. The value of x can be 0, 1, 2, or 3.
C=xx	Specifies the CMRDECK (CMR for NOS/BE) number. The value of xx can be any number from 0 to 77 octal.
	Refer to the part II, section 1 for information about CMRDECK/CMR selection.
D=xxx	Entry is not used by NOS/BE. For NOS, specifies whether the CMRDECK is to be displayed. The value of xxx can be: YES for display CMRDECK. NO for do not display CMRDECK.
W12=xxxx	Specifies the value for deadstart program word 12. Refer to the part II, section 1 for the proper setting.
W14=xxxx	Specifies the value for deadstart program word 14. Word 14 is reserved for the operating system or maintenance system.
	<u>NOS/VE</u>
D=xx	Specifies the DCFILE number. The value of xx can be any number from 0 to 77 octal.
P=xx	Specifies whether a pause will be initiated for operator entries at the NOS/VE Deadstart Screen.

NOS or NOS/BE

SELECT OS DEADSTART DEVICE

- (CR) - CONTINUE OS LOAD
- (BS) - PREVIOUS DISPLAY
- T - TAPE DEADSTART
- D - ALTERNATE DISK DEADSTART

CIP42A

NOS/VE

SELECT OS DEADSTART DEVICE

- (BS) - PREVIOUS DISPLAY

- T - TAPE DEADSTART
- D - ALTERNATE DISK DEADSTART
- (CR) - DEFAULT DISK DEADSTART

CIP42B

ALL OPTIONS EXIT TO THE CONTINUE OPERATING SYSTEM LOAD PATH.

ENTER TAPE TYPE - 2

(1=66X, 2=63X/67X)

CHANNEL - 13

EQUIPMENT - 0

UNIT - 00

(BS) BACK TO PREVIOUS ENTRY

CIP13

OS DISK DEVICE LOCATION

CHANNEL - 01

EQUIPMENT - 0

UNIT - 00

(BS) BACK TO PREVIOUS ENTRY

CIP08B

Display I-2-6. Deadstart Device

Option

Description

- M Load the Monitor Display Driver (MDD) Program. This value is saved in the MRT until changed for all CYBER 180 mainframes. Select this option to load and execute MDD concurrent with the operating system. The display shown in display I-2-7 appears.

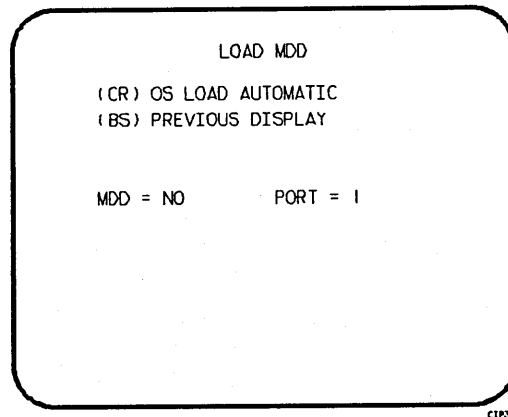

Display I-2-7. Load MDD

Direct the system to load MDD by entering:

MDD = YES

Select the port number of the two-port multiplexer that MDD uses by entering:

PORT = n

Parameter n is 0 or 1. The default port number is 1.

NOTE

Be sure the baud rate of the specified port of the two-port multiplexer is set properly for the communications being used.

- 0 Toggle the OS Load State to either a NOS/VE deadstart or a NOS or NOS/BE deadstart. The correct Load State is displayed below the Operator Intervention Display Header. This value is saved in the MRT until changed for all CYBER 180 mainframes.

Press the carriage return key to cause system deadstart processing to continue with no further intervention on your part.

Press the backspace key to return to the Operator Intervention display.

UTILITIES DISPLAY

Selecting the U option from the Initial Options display causes the Utilities display, display I-2-8, to appear.

UTILITIES

E EXPRESS DEADSTART DUMP
P PRINTER DUMP
S ALTERNATE DEADSTART
DEVICE SELECTION
D DEFINE AND DISPLAY DEFAULT
DEVICE PARAMETERS
L DISPLAY CIP COMPONENT
INFORMATION
I INITIALIZE MAINFRAME
C CLEAR DEADSTART ERROR LOG
F CLEAR CM FLAW TABLE
H CLEAR MAINFRAME RECONFIGURATION
TABLE
A LOAD MONITOR DISPLAY DRIVE

(CR) EXPRESS DEADSTART DUMP
(BS) PREVIOUS DISPLAY

CIP41A

Display I-2-8. Utilities, Disk Deadstart

<u>Option</u>	<u>Description</u>
(CR) or E	Express Deadstart Dump (EDD). Select this option to dump to magnetic tape the contents of PP memories, central memory, unified extended memory, CPU hardware registers, maintenance registers, processor control store memories, and the tape and disk controlware. When the E option is selected, CTI checks the error status of all system elements and displays error messages for any errors before allowing the deadstart dump to continue. Refer to Performing an Express Deadstart Dump in part II, section 2 for procedures and further information.
P	Dump to Printer. Select this option to dump central memory, PP memory, or maintenance register contents to a line printer. When you specify P, the Dump to Printer Options display, display I-2-9, appears. You cannot return to the Utilities display from this display. You must redeadstart the system. When the P option is selected, CTI checks the error status of all system elements and displays error messages for any errors before allowing the deadstart dump to continue. Table I-2-3 shows the keyboard entries for performing a printer dump. Refer to Performing a Printer Dump in part II, section 2 for procedures and further information.

NOTE

When the E or P options are selected, CTI will check the error status of all the system elements. If errors are encountered, CTI will log the errors in the deadstart error log. If the deadstart error log is full, CTI will display the errors before allowing the deadstart to continue.

A - 512 PRINTER INITIALIZE
B - 580 PRINTER INITIALIZE
C - PP MEMORY DUMP
D - CM DUMP
G - REGISTER FILE DUMP
H - PP MEMORY DUMP IN HEX
I - CENTRAL MEMORY DUMP IN HEX
J - REGISTER FILE DUMP IN HEX
K - IOU REGISTER DUMP IN HEX
L - CM REGISTER DUMP IN HEX
M - CPU REGISTER DUMP IN HEX
N - PEM REGISTER DUMP IN HEX
O - CONTROL STORE DUMP IN HEX

CIPOFD

Display I-2-9. Dump to Printer Options

Table I-2-3. Keyboard Entries for a Printer Dump, Models 810 and 830 (Sheet 1 of 2)

Entry	Function
A	512 Printer Initialize. This option initializes the 512 printer image with the data necessary to print with a 512-1 print train.
B	580 Printer Initialize. This option initializes the 580 printer buffer image and format buffer image memories.
C	PP Memory Dump. This option provides an octal dump to printer of 12-bit PP memories and 16-bit PP memories with their associated R registers.
D	CM Dump. This option provides an octal dump to printer of a selected area of central memory.
G	Register File Dump. This option provides an octal dump to printer of the CPU register file contents.

Table I-2-3. Keyboard Entries for a Printer Dump, Models 810 and 830 (Sheet 2 of 2)

Entry	Function
H	PP Memory Dump in Hexadecimal. This option provides a hexadecimal dump to the printer of the PP memories.
I	Central Memory Dump in Hexadecimal. This option provides a hexadecimal dump to the printer of a selected area of central memory.
J	Register File Dump in Hexadecimal. This option provides a hexadecimal dump to the printer of the CPU register file contents.
K	IOU Register Dump in Hexadecimal. This option provides a hexadecimal dump to the printer of the IOU maintenance register contents.
L	CM Register Dump in Hexadecimal. This option provides a hexadecimal dump to the printer of the contents of the central memory maintenance registers.
M	<p>CPU Register Dump in Hexadecimal. This option provides a hexadecimal dump to the printer of the contents of the CPU maintenance registers. Respond to the message CPU NO = by entering the number of the CPU for which registers are to be dumped.</p> <p>If microcode is not executing, the program dumps only the hardware maintenance registers. In place of the software registers, the following message appears on the printer dump:</p> <p style="text-align: center;">MICROCODE HUNG</p>
N	PEM Register Dump in Hexadecimal. This option provides a hexadecimal dump of the contents of the PEM registers.
O	Control Store Dump in Hexadecimal. This option provides a hexadecimal dump to the printer of the contents of control store. Respond to the message CPU NO = by entering the number of the CPU for which control store is to be dumped.

```

DEADSTART DEVICE TYPE - 2
(1=66X, 2=63X/67X, 3=DISK)

CHANNEL - 13
EQUIPMENT - 0
UNIT - 00

(BS) BACK TO PREVIOUS ENTRY

```

CIP08A

Display I-2-10. Alternate Deadstart

Option

Description

S Alternate Deadstart. Select this option to specify an alternate CIP tape unit or disk device from which to deadstart. The Alternate Deadstart display, display I-2-10, appears.

Enter the device type and press the carriage return key. The system then prompts you for channel, equipment, and unit numbers.

Default values are provided for the device parameters. The values are those specified in the default parameter block. The default parameter block is defined through option D, define default device parameters.

After the device information is entered, press the carriage return key to deadstart from the alternate device.

NOTE

Alternate deadstart from operating system deadstart tapes is not supported for model 800 computer systems. To load the operating system from a tape file, select option T, operating system file on tape, from the Operator Intervention display.

D Define and Display Default Device Parameters. Select this option to assign default values to the channel, equipment, and unit numbers of a CIP tape deadstart device, disk deadstart device, alternate disk deadstart device, tape dump (EDD) device, or printer dump device. Default values are initially assigned to the device parameters when CIP is installed.

L Display CIP Component Levels. Select this option to display the release levels of the CIP components: microcode, EI, SCD, DFT, NOS/VE programs, and MDD, and the full or empty status of the deadstart error log (DEL). An asterisk identifies components that have been installed manually.

Option

Description

- I Initialize Mainframe. Select this option to initialize the mainframe after power interruption or maintenance activity. The Initial Options display reappears with the following message on the bottom of the display:

ALL MAINFRAME MEMORIES WILL
BE INITIALIZED FOR MSL/OS LOADS

Mainframe initialization, including initialization of central memory, PP memory, and maintenance registers, occurs when you select this option and then perform either an operating system load on a level 0, 1, or 2 (not 3) deadstart or select the off-line maintenance option. Refer to part II, section 2 for procedures and additional information about this option.

- C Clear deadstart error log. Select this option to clear the data in the deadstart error log.
- F Clear central memory flaw table. Select this option to clear the data in the CM flaw table.
- H Clear mainframe reconfiguration table. Select this option to clear the mainframe reconfiguration table data stored on disk.
- A Load the Monitor Display Driver. Select this option to execute MDD in a standalone mode (not concurrent with the operating system).

When you specify A, the MDD Parameters display, display I-2-11, appears.

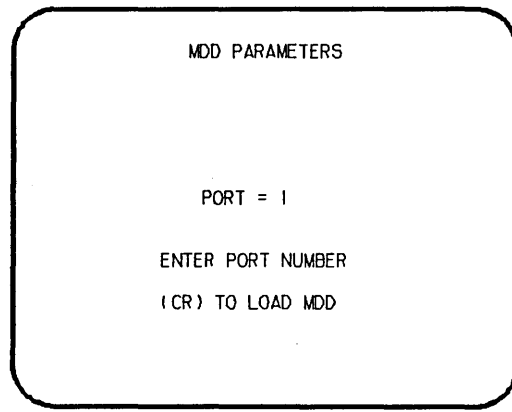

Display I-2-11. MDD Parameters

Option

Description

Enter the port number if different than the one displayed. Press the carriage return key to cause MDD to load. When you have finished using MDD, a deadstart is required. Refer to part III, section 1 for the uses of MDD.

This option is used to support the analysis of the state of a mainframe after encountering a system interrupt. It should only be selected after an operating system has been previously loaded. CTI loads MDD out of central memory (stored there on a system load) and issues the following message, if a checksum of the MDD program fails.

UNABLE TO LOAD MDD.

THE INTEGRITY OF CENTRAL MEMORY

DISPLAYS AND OPTIONS FOR DEADSTART FROM CIP TAPE

The CIP tape deadstart displays and options included in this subsection incorporate the following conventions:

- The default option on a menu display is the first option listed. The option can be selected automatically by pressing the carriage return key.
- Help information is provided for the Initial Options displays and the Build Deadstart Disk display. The Help displays supply brief information about the options. More detailed option information is given elsewhere in this section.
- Pressing the backspace key allows you to return to the previous display.

OVERVIEW

Figure I-2-2 provides an overview of the displays and options available during a deadstart from CIP tape on models 810 and 830.

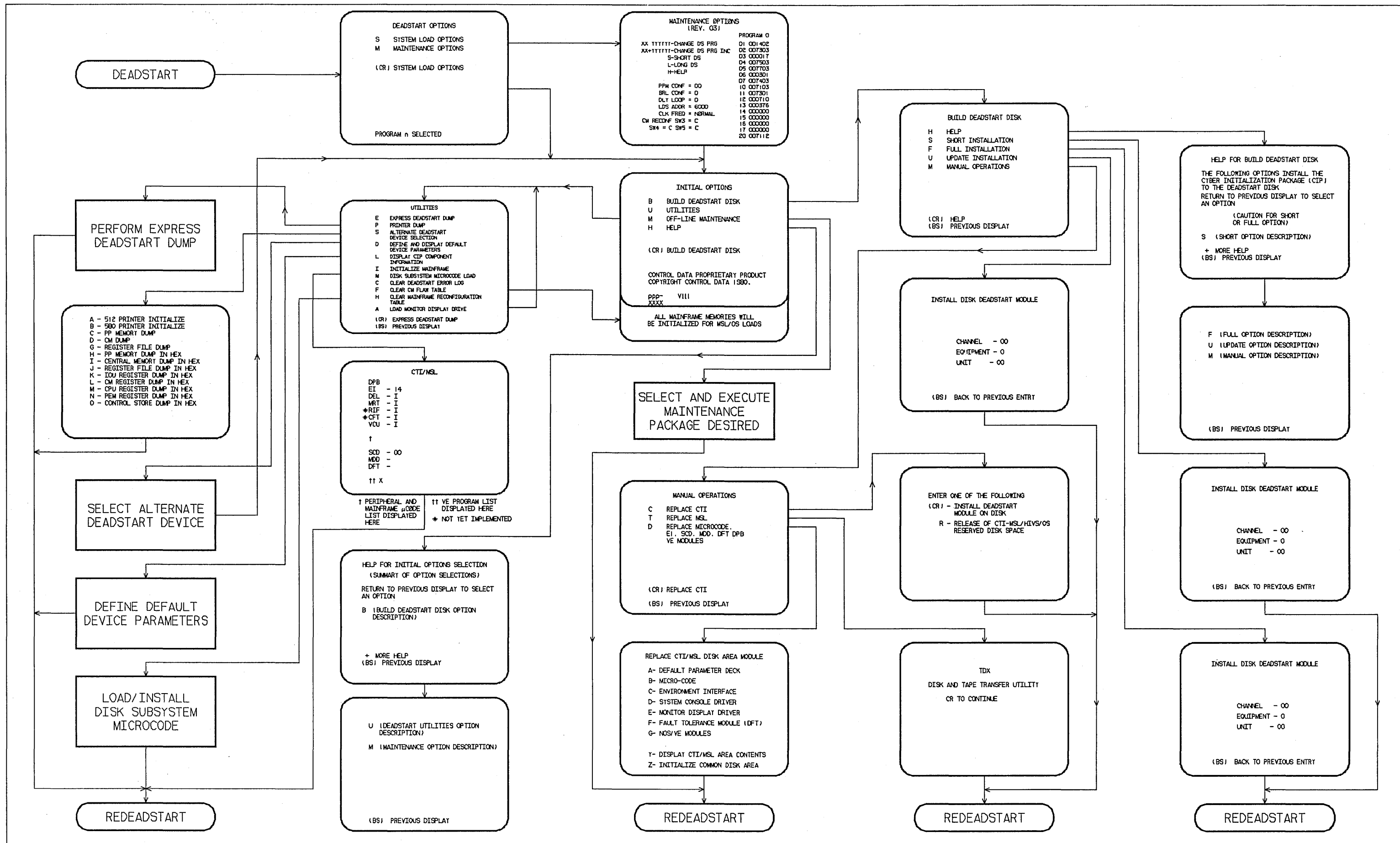

Figure I-2-2. Overview of Displays and Options for Deadstart
From CIP Tape (Models 810 and 830)

INITIAL OPTIONS DISPLAY

The Initial Options display, display I-2-12, is the first screen that appears after the deadstart program is initiated. When the deadstart program is set for deadstart from the CIP tape, the Initial Options display provides utilities to install the CIP to disk. A CIP tape deadstart also allows execution of several utilities from tape should the deadstart disk be unusable.

```
          INITIAL OPTIONS
          B  BUILD DEADSTART DISK
          U  UTILITIES
          M  OFF-LINE MAINTENANCE
          H  HELP

          (CR) BUILD DEADSTART DISK

          CONTROL DATA PROPRIETARY PRODUCT
          COPYRIGHT CONTROL DATA 1980.

          ppp-   VIII
          XXXX
```

CIP15

Display I-2-12. Initial Options From CIP Tape

<u>Option</u>	<u>Description</u>
(CR) or B	Build Deadstart Disk. This option allows you to install CIP to disk. The CIP modules must reside on the disk before an operating system deadstart can be performed. CIP modules are used to initialize the mainframe and establish the operating environment. Refer to CIP Installation earlier in this section.
U	Utilities. Select this option to: <ul style="list-style-type: none">• Perform an Express Deadstart Dump (dump memories and registers to tape).• Perform a printer dump.• Deadstart from a different device.• Define default device parameters.• Display CIP component levels.• Initialize the mainframe after power interruption or maintenance activity.• Load/install peripheral microcode.• Clear deadstart error log (DEL).

Option

Description

- Load the monitor display driver (MDD) in NOS/VE standalone mode.
- Clear the central memory flaw table.
- Clear the mainframe reconfiguration table (MRT).

M Off-Line Maintenance. This option is provided to enable the CE to execute hardware tests for preventive maintenance or hardware error diagnosis. Information about the option is included in the MSL 15X Reference Manual.

The contents of word 12 of the deadstart program also affect the M option. Refer to Setting Word 12 in part II, section 1 of this manual.

Execution of the hardware diagnostics from tape is much slower than from disk. Use tape only when your deadstart disk is not usable.

H Help for Initial Options Selection.

When the CC634B console is being used, press H or the HELP key for a description of the initial options.

The CIP level, ppp- Vlll, is displayed at the bottom of the Initial Options display; ppp is mainframe type, and lll is the CIP version level. At the very bottom of the display, xxxx is the PSR level.

BUILD DEADSTART DISK DISPLAY

The Build Deadstart Disk display, display I-2-13, appears when you select option B, build deadstart disk, from the Initial Options display. The Build Deadstart Disk display is available only when you deadstart from the CIP tape. This display provides the options that install the CIP to the deadstart disk. Refer to CIP Installation, earlier in this section, for CIP installation procedures and displays.

BUILD DEADSTART DISK

H HELP
S SHORT INSTALLATION
F FULL INSTALLATION
U UPDATE INSTALLATION
M MANUAL OPERATIONS

(CR) HELP
(BS) PREVIOUS DISPLAY

CIP16

Display I-2-13. Build Deadstart Disk

<u>Option</u>	<u>Description</u>
(CR) or H	Help for Build Option Selection. When the CC634B console is being used, press H or the HELP key for a description of the build options.

CAUTION

The short and full installation options destroy all information on the deadstart disk, except the disk microcode, before installing CIP. Before executing the short or full installation option, be sure you have a backup copy of any information on the deadstart disk that you want to preserve, including operating system permanent files and CE command buffers. After executing the short or full installation option, you must perform an operating system initialization of the disk.

- S Short Installation. Select this option to initialize the deadstart disk and then install the CIP to the deadstart disk. Some of the hardware diagnostics on the CIP will not be installed; only diagnostics needed most frequently by the CE are installed. Execute either the short or full installation option when you install CIP for the first time.
- F Full Installation. Select this option to initialize the deadstart disk and then install all of CIP to the deadstart disk. Execute either the short or full option when you install CIP for the first time.
- U Update Installation. Select this option to replace CIP on the deadstart disk some time after the short/full installation. The update option preserves operating system information on the deadstart disk.
- M Manual Operations. Select this option to perform emergency CIP component replacement at any time after CIP has been installed. Display I-2-14, the Manual Operations display, provides manual operation option selection.

MANUAL OPERATIONS DISPLAY

The Manual Operations display appears when you select option M, manual operations, from the Build Deadstart Disk display. Manual operations are available only when you deadstart from the CIP tape.

Manual operations provide manual replacement of individual CIP components, which may be required in the event of a critical problem. Refer to Emergency CIP Repair Procedures - Model 800 Computer Systems in part II, section 2 for repair and manual replacement procedures. More detailed information about manual operations is provided in the MSL 15X Reference Manual.

MANUAL OPERATIONS

C REPLACE CTI
T REPLACE MSL
D REPLACE MICROCODE,
EI, SCD, MDD, DFT DPB
VE MODULES

(CR) REPLACE CTI
(BS) PREVIOUS DISPLAY

CIP/PCA

Display I-2-14. Manual Operations

<u>Option</u>	<u>Description</u>
(CR) or C	Replace CTI. Select this option to install the CTI component of CIP to the deadstart disk.

NOTE

This option provides the capability to release CTI-MSL/HIVS/OS disk space. For detailed procedures, see Build Deadstart Disk Operations in part II, section 2.

T	Replace MSL. Select this option to install the Maintenance Software Library component of CIP to the deadstart disk.
---	---

Option

Description

D Replace microcode, EI, SCD, MDD, Dedicated Fault Tolerance (DFT), Default Device Parameters (DPB), or the NOS/VE modules.

NOTE

Select this option only after an initial install has been performed.

Select this option to replace microcode, EI, the CC634B System Console Driver (SCD), the Monitor Display Driver (MDD), DFT, default device parameters (DPB), or the NOS/VE boot modules or to initialize the common disk area (CDA). When option D is selected, you are prompted to enter the disk channel and disk unit numbers. After you enter the channel and unit numbers or press the carriage return key to accept the default values shown, the CAU Initial Options display shown in display I-2-15 appears. Options B through G manually replace CIP modules on the deadstart disk.

Select option Y on the CAU Options display to display the level numbers of the microcode and EI modules resident on the deadstart disk. If any module has been manually replaced, an asterisk appears by the module name on this display.

REPLACE CTI/MSL DISK AREA MODULE

- A- DEFAULT PARAMETER DECK
- B- MICRO-CODE
- C- ENVIRONMENT INTERFACE
- D- SYSTEM CONSOLE DRIVER
- E- MONITOR DISPLAY DRIVER
- F- FAULT TOLERANCE MODULE (DFT)
- G- NOS/VE MODULES

- Y- DISPLAY CTI/MSL AREA CONTENTS
- Z- INITIALIZE COMMON DISK AREA

C1P22

Display I-2-15. CAU Initial Options

UTILITIES DISPLAY

Selecting the U option from the Initial Options display causes the Utilities display, display I-2-16, to appear.

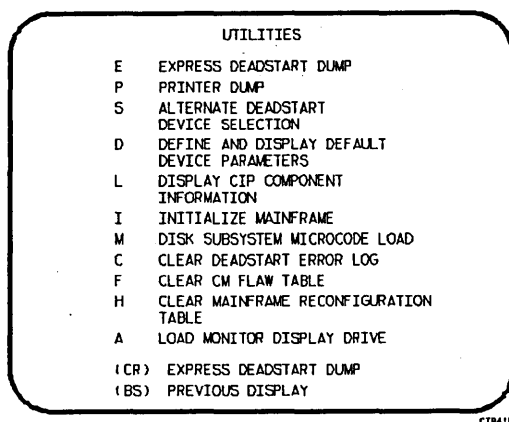

CP418

Display I-2-16. Utilities, Tape Deadstart

<u>Option</u>	<u>Description</u>
(CR) or E	Express Deadstart Dump (EDD). Select this option to dump to magnetic tape the contents of PP memories, central memory, unified extended memory, CPU hardware registers, maintenance registers, processor control store memories, and the tape and disk controlware. When the E option is selected, CTI checks the error status of all system elements and displays error messages for any errors before allowing the deadstart dump to continue. Refer to Performing an Express Deadstart Dump in part II, section 2 for further information.
P	Dump to Printer. Select this option to dump central memory, PP memory, or maintenance register contents to a line printer. When you specify P, the Dump to Printer Options display, display I-2-17, appears. You cannot return to the Utilities display from this display. You must redeadstart the system. When the P option is selected, CTI checks the error status of all system elements and displays error messages for any errors before allowing the deadstart dump to continue. Table I-2-4 lists the keyboard entries for performing a printer dump. For more information refer to Performing a Printer Dump in part II, section 2.

NOTE

When the E or P options are selected, CTI will check the error status of all the system elements. If errors are encountered, CTI will log the errors in the deadstart error log. If the deadstart error log is full, CTI will display the errors before allowing the deadstart to continue.

```

A - 512 PRINTER INITIALIZE
B - 580 PRINTER INITIALIZE
C - PP MEMORY DUMP
D - CM DUMP
G - REGISTER FILE DUMP
H - PP MEMORY DUMP IN HEX
I - CENTRAL MEMORY DUMP IN HEX
J - REGISTER FILE DUMP IN HEX
K - IOU REGISTER DUMP IN HEX
L - CM REGISTER DUMP IN HEX
M - CPU REGISTER DUMP IN HEX
N - PEM REGISTER DUMP IN HEX
O - CONTROL STORE DUMP IN HEX

```

CLP010

Display I-2-17. Dump to Printer Options

Table I-2-4. Keyboard Entries for a Printer Dump, Models 810 and 830 (Sheet 1 of 2)

Entry	Function
A	512 Printer Initialize. This option initializes the 512 printer image with the data necessary to print with a 512-1 print train.
B	580 Printer Initialize. This option initializes the 580 printer buffer image and format buffer image memories.
C	PP Memory Dump. This option provides an octal dump to printer of 12-bit PP memories and 16-bit PP memories with their associated R registers.
D	CM Dump. This option provides an octal dump to printer of a selected area of central memory.
G	Register File Dump. This option provides an octal dump to printer of the CPU register file contents.
H	PP Memory Dump in Hexadecimal. This option provides a hexadecimal dump to the printer of the PP memories.
I	Central Memory Dump in Hexadecimal. This option provides a hexadecimal dump to the printer of a selected area of central memory.
J	Register File Dump in Hexadecimal. This option provides a hexadecimal dump to the printer of the CPU register file contents.
K	IOU Register Dump in Hexadecimal. This option provides a hexadecimal dump to the printer of the IOU maintenance register contents.
L	CM Register Dump in Hexadecimal. This option provides a hexadecimal dump to the printer of the contents of the central memory maintenance registers.

Table I-2-4. Keyboard Entries for a Printer Dump, Models 810 and 830 (Sheet 2 of 2)

Entry	Function
M	<p>CPU Register Dump in Hexadecimal. This option provides a hexadecimal dump to the printer of the contents of the CPU maintenance registers. Respond to the message CPU NO = by entering the number of the CPU for which registers are to be dumped.</p> <p>If microcode is not executing, the program dumps only the hardware maintenance registers. In place of the software registers, the following message appears on the printer dump:</p> <p style="text-align: center;">MICROCODE HUNG</p>
N	<p>PEM Register Dump in Hexadecimal. This option provides a hexadecimal dump of the contents of the PEM registers.</p>
O	<p>Control Store Dump in Hexadecimal. This option provides a hexadecimal dump to the printer of the contents of control store. Respond to the message CPU NO = by entering the number of the CPU for which control store is to be dumped.</p>

Option

Description

- S Alternate Deadstart. Select this option to specify an alternate CIP tape unit or disk device from which to deadstart. The Alternate Deadstart display, display I-2-18, appears.

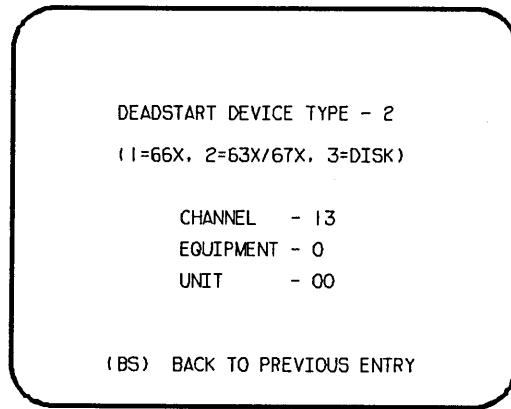

Display I-2-18. Alternate Deadstart

Enter the device type and press the carriage return key. The system then prompts you for channel, equipment, and unit numbers.

Default values are provided for the device parameters. The values are those specified in the default parameter block. The default parameter block is defined through option D, define default device parameters.

Option

Description

After the device information is entered, press the carriage return key to deadstart from the alternate device.

NOTE

Alternate deadstart from operating system deadstart tapes is not supported for model 800 computer systems. To load the operating system from a tape file, select option T, operating system file on tape, from the Operator Intervention display.

- D Define and Display Default Device Parameters. Select this option to assign default values to the channel, equipment, and unit numbers of a CIP tape deadstart device, disk deadstart device, alternate disk deadstart device, tape dump (EDD) device, or printer dump device. Default values are initially assigned to the device parameters when CIP is installed.
- L Display CIP Component Levels. Select this option to display the release levels of the CIP components: microcode, EI, SCD, DFT, NOS/VE programs, and MDD, and the full or empty status of the deadstart error log (DEL). An asterisk identifies components that have been installed manually.
- I Initialize Mainframe. Select this option to initialize the mainframe after power interruption or maintenance activity. The Initial Options display reappears with the following message on the bottom of the display:
- ALL MAINFRAME MEMORIES WILL
BE INITIALIZED FOR MSL/OS LOADS
- Mainframe initialization, including initialization of central memory, PP memory, and maintenance registers, occurs when you select this option and then perform either an operating system load on a level 0, 1, or 2 (not 3) deadstart or select the off-line maintenance option. Refer to Performing a Power-On Initialization in part II, section 2 for procedures and additional information about this option.
- M Disk Subsystem Microcode Load. Select this option to load peripheral microcode into the 834/836 disk adapter and control module memory and install peripheral microcode onto specified drives. Refer to Loading and Installing Disk Subsystem Microcode From CIP Tape in part II, section 2 for procedures and additional information about this option.
- C Clear deadstart error log. Select this option to clear the data in the deadstart error log.
- F Clear central memory flaw table. Select this option to clear the data in the CM flaw table.
- H Clear mainframe reconfiguration table. Select this option to clear the data in the mainframe reconfiguration table stored on disk.

Option

Description

A

Load the Monitor Display Driver. Select this option to execute MDD in a standalone mode (not concurrent with the operating system).

When you specify A, the MDD Parameters display, display I-2-19, appears.

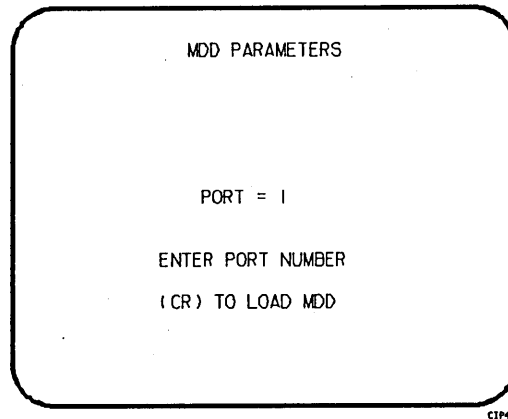

Display I-2-19. MDD Parameters

Enter the port number if different than the one displayed. Press the carriage return key to cause MDD to load. When you have finished using MDD, a deadstart is required. Refer to part III, section 1 for the uses of MDD.

This option is used to support the analysis of the state of a mainframe after encountering a system interrupt. It should only be selected after an operating system has been previously loaded. CTI loads MDD out of central memory (stored there on a system load) and issues the following message, if a checksum of the MDD program fails.

UNABLE TO LOAD MDD.

THE INTEGRITY OF CENTRAL MEMORY
HAS BEEN COMPROMISED.

CIP PROCEDURES, DISPLAYS, AND OPTIONS FOR CYBER 170 MODELS 815 AND 825

3

This section includes CIP automatic installation procedures, operating system deadstart procedures, and descriptions of CIP displays and options available to users of CYBER 170 models 815 and 825.

This section refers to the deadstart displays that are presented after deadstart is initiated. The initial deadstart display and use of the deadstart program are described in part II, section 1 of this handbook. Other displays referenced are described in part II, section 2.

CAUTION

For CYBER 170/180 systems using a NOS/VE version previous to 1.2.1, CIP should not be installed on a NOS/VE device. NOS/VE does not recognize CIP as a read-only disk area and will write over it.

CIP INSTALLATION

The CIP modules must be installed to disk for models 815 and 825. Select a disk unit in your configuration to be the deadstart disk. The installation process installs the CIP modules to the deadstart disk so that operating system information may also reside on the disk.

Complete the following procedure to initially install CIP to the deadstart disk or to update CIP on the deadstart disk. The installation procedure requires dedicated machine time. At least one tape drive and one disk unit must be available. The procedure assumes that controlware has been loaded into the peripheral controller(s). If the controlware is not loaded, refer to part II, section 1 for coldstart instructions.

1. Mount the CIP tape on a tape drive.
2. Press the deadstart button on a CC545 console to initiate deadstart from the tape.

If a CC634B with option GK427A is being used as the primary console (required for NOS/VE standalone), press deadstart button and go to step 3.

If a CC634B display terminal is being used as the primary console, complete the following steps to bring up the initial display:

- a. Press the RESET button to reinitialize the console.
- b. Hold down the CTRL key while pressing the G key.
- c. When the message *OPERATOR ACCESS ENABLED appears on the screen, hold down the CTRL key while pressing the R key.

The Initial Deadstart Program display appears.

3. Set up a deadstart program for deadstart from the CIP tape.
4. Enter S then press the carriage return key to select the short deadstart sequence. The Initial Options display appears.

NOTE

For 815 and 825 mainframe sites with no maintenance contract enter I then press the carriage return key to initialize the disk and install CTI and HIVS. Although the CIP tape for such sites contains no off-line maintenance diagnostics, it must be installed to the deadstart disk.

5. Press the carriage return key to select the default option. The Build Deadstart Disk display appears.

CAUTION

Do not proceed until you have read all the instructions for step 6.

6. For first time installation of the CIP, enter either S, to select the short installation option, or enter F, to select the full installation option, based on the following information.

NOTE

The short and full installation options destroy all information on the deadstart disk, except the disk microcode, prior to installing CIP. Before executing either the short or full installation option, be sure you have a backup copy of any information on the deadstart disk that you want to preserve, including operating system permanent files and CE command buffers.

After executing the short or full option, you must perform an operating system initialization of the disk.

- S The short installation option initializes the deadstart disk and then installs most of CIP. The CIP tape contains off-line maintenance diagnostics that the CE uses to execute mainframe tests for preventive maintenance or to diagnose a hardware error. The short option installs a predefined set of diagnostics (diagnostics that the CE uses frequently). Those used infrequently can be loaded and executed from the CIP tape when needed. The short installation option reserves 15 megabytes of disk storage for the CIP.
- F The full installation option initializes the deadstart disk and installs all of CIP. The full installation option reserves 25 megabytes of disk storage for CIP.

For reinstallation of CIP some time after the initial installation, enter U to select the update option.

- U The update option replaces CIP on the deadstart disk and preserves operating system information on the deadstart disk, including permanent files. The update option replaces CIP in the same mode, short or full, that was used when the deadstart disk was initialized.

The CIP modules replaced during an Update are:

- CTI
- EI
- MSL (includes command buffers)
- Microcode
- MDD
- SCD
- DFT
- NOS/VE Programs

Information saved during an Update includes:

Deadstart error log (DEL)
Default parameter block
Operating system pointers and permanent files
NOS/VE system file pointers
Mainframe reconfiguration table (MRT)

7. Enter the channel, equipment, and unit numbers of the deadstart disk when prompted. Follow each entry by pressing the carriage return key. Press only the carriage return key to select the displayed default value.
8. CIP installation is complete when the message INSTALLATION COMPLETE appears.

You can now perform an operating system load, off-line maintenance, default deadstart device definition, or other deadstart utility operation. Refer to part II, section 2.

OPERATING SYSTEM DEADSTART

An operating system deadstart can be performed on models 815 and 825 only when CIP has been installed on disk. Procedures described next are for operating system deadstart when the deadstart program is set for deadstart from disk, which is known as disk deadstart. Operating system tape deadstart is not supported for models 815 and 825. Operating system load from a tape file, however, is supported for models 815 and 825 through the disk deadstart process.

The operating system deadstart procedures require at least one disk unit and, when the operating system file is on tape, one tape unit. The procedures assume that controlware has been loaded into the peripheral controller(s). If the controlware is not loaded, refer to part II, section 1 for coldstart instruction.

DISK DEADSTART

This procedure assumes that:

- The deadstart program is set for deadstart from disk.
- CIP has been installed to disk. Refer to CIP Installation earlier in this section.

If the operating system file has also been installed to disk, a complete disk deadstart can be performed. Refer to the NOS 2 Analysis Handbook, INSTALL command, to find out how to install the NOS file to disk. The NOS/BE level 0 deadstart process automatically installs the NOS/BE file on disk for use on following deadstarts. Refer to NOS/VE Installation Reference Manuals for NOS/VE installation procedures.

Operating System File on Disk

1. Press the deadstart button on a CC545 console to initiate deadstart from the tape.

If a CC634B with option GK427A is being used as the primary console (required for NOS/VE standalone), press deadstart button and go to step 3.

If a CC634B display terminal is being used as the primary console, complete the following steps to bring up the initial display:

- a. Press the RESET button to reinitialize the console.
- b. Hold down the CTRL key while pressing the G key.
- c. When the message *OPERATOR ACCESS ENABLED appears on the screen, hold down the CTRL key while pressing the R key.

The Maintenance Options display appears.

2. Enter S then press the carriage return key. The Initial Options display appears.
3. Press the carriage return key to select the default option, automatic OS load. The automatic option assumes that the deadstart program is set correctly for deadstart level (0, 1, 2, 3) and for CMRDECK selection (NOS), or for CMR selection (NOS/BE), or for DCFIL selection (NOS/VE).

If the deadstart program is set correctly, Operating System Deadstart is initiated.

4. If the deadstart program is not set correctly for these selections, enter 0 to select the operator intervention option. Operator intervention also allows reconfiguration of mainframe hardware components and execution of the hardware verification sequences. For specific information regarding operator intervention options, turn to Displays and Options for Deadstart From Disk later in this section.

Operating System File on Tape or Alternate Disk

1. Press the deadstart button on a CC545 console to initiate deadstart from the tape.

If a CC634B with option GK427A is being used as the primary console (required for NOS/VE standalone), press deadstart button and go to step 2.

If a CC634B display terminal is being used as the primary console, complete the following steps to bring up the initial display:

- a. Press the RESET button to reinitialize the console.
- b. Hold down the CTRL key while pressing the G key.
- c. When the message *OPERATOR ACCESS ENABLED appears on the screen, hold down the CTRL key while pressing the R key.

The Maintenance Options display appears.

2. Enter S then press the carriage return key. The Initial Options display appears.
3. Enter 0 to select the operator intervention option. The Operator Intervention display appears.
4. If the deadstart program is not set correctly for deadstart level and for CMRDECK selection (NOS) or CMR selection (NOS/BE) or DCFILE selection (NOS/VE), enter P to select the deadstart panel parameters option, before proceeding. Operator intervention also allows reconfiguration of the mainframe hardware components and execution of hardware verification sequences. For specific information regarding operator intervention options, refer to Displays and Options for Deadstart From Disk.
5. Enter S to select tape or alternate disk deadstart.
 - a. Tape Deadstart
 1. Enter T to deadstart using a tape.
 2. Enter tape type, channel, equipment, and unit when prompted.†
 - b. Alternate Disk Deadstart
 1. Enter D to select alternate disk deadstart.
 2. Enter disk channel, equipment, and unit when prompted.†
6. Press the carriage return key. Operating System deadstart is initiated.†
7. You will see messages showing that NOS, NOS/BE, or NOS/VE is loading programs and running tests.

† Applicable for NOS and NOS/BE deadstarts only. For NOS/VE deadstarts, the Operating System deadstart sequence is initiated upon selecting the D or T option. (Reference the NOS/VE Operations Manual for more information on NOS/VE Deadstarts.)

DISPLAYS AND OPTIONS FOR DEADSTART FROM DISK

The CIP disk deadstart displays and options included in this subsection incorporate the following conventions:

- The default option on a menu display is the first option listed. The option can be selected automatically by pressing the carriage return key.
- Help information is provided for the Initial Options displays and the Build Deadstart Disk display. The Help displays supply brief information about the options. More detailed option information is given elsewhere in this section.
- Pressing the backspace key allows you to return to the previous display.

OVERVIEW

Figure I-3-1 provides an overview of the displays and options available during a deadstart from disk on models 815 and 825.

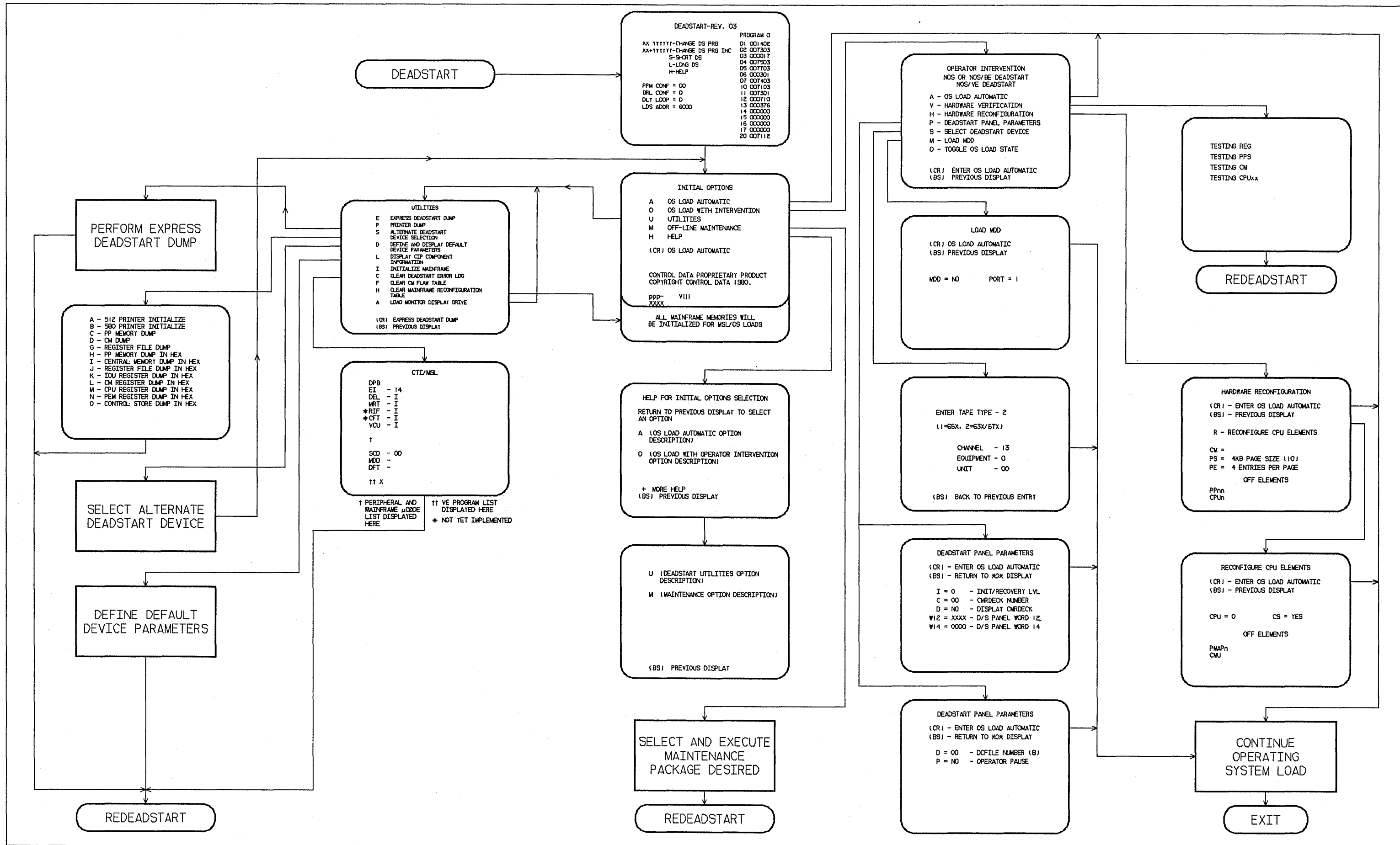

Figure I-3-1. Overview of Displays and Options for Deadstart From Disk (Models 815 and 825)

INITIAL OPTIONS DISPLAY

The Initial Options display, display I-3-1, is the first screen that appears after deadstart is initiated.

The Initial Options display provides operating system load, execution of off-line maintenance, and deadstart utilities when the deadstart program is set for deadstart from disk.

```

                INITIAL OPTIONS

A   OS LOAD AUTOMATIC
O   OS LOAD WITH INTERVENTION
U   UTILITIES
M   OFF-LINE MAINTENANCE
H   HELP

(CR) OS LOAD AUTOMATIC

CONTROL DATA PROPRIETARY PRODUCT
COPYRIGHT CONTROL DATA 1980.

ppp-   VIII
XXXX
    
```

Display I-3-1. Initial Options From Disk

<u>Option</u>	<u>Description</u>
(CR) or A	OS Load Automatic. The system initialization software assumes that CIP has been installed to the deadstart disk. The system loads modules from the deadstart disk into memory and the central processor to establish the operating environment. Then, confidence tests verify the ability of PP memory to hold simple data patterns and preset PP memory contents to all ones.

If the system detects a fatal error during confidence testing, CTI records the errors in the deadstart error log (DEL), if it is empty, for later processing by the operating system. The following information appears on the left screen:

```

DEADSTART ABORTED - FATAL ERROR

eeee-nn  rrrr   =cc cc cc cc cc cc cc cc
          rrrr   =cc cc cc cc cc cc cc cc
          rrrr   =cc cc cc cc cc cc cc cc
    
```

<u>Notation</u>	<u>Description</u>
eeee-nn	Name and logical number of the hardware that has the error.

<u>Name</u>	<u>Hardware</u>
IOU-00	Input/output unit.
MEM-00	Central memory.
PROC-0n	Central processing unit. n=logical number.

rrrr Register name.

cc Register content in hexadecimal notation.

Inform a CE when a fatal error occurs.

Option

Description

The ENTER DATE and ENTER TIME prompts are displayed on the model 810 and 830 systems only when the Two Port Mux wall clock is invalid and:

- a. The operator has selected a NOS/VE load, or
- b. The operating system being loaded supports CTI as the primary source of current date and time.

NOTE

The smallest unit of time that can be written to the Two Port Mux is minutes. If clock accuracy to within 1 second is desired, the operator should enter the desired seconds. However, this causes CTI to delay to the next minute before writing the clock and continuing the deadstart. Example: If the operator enters a time of 08:15:05, CTI delays for 55 seconds, and writes the clock with a time of 08:16:00. The informative message Updating Clock is added to the display during the delay.

If clock accuracy to within 1 minute is sufficient, the operator can enter 00 seconds and CTI writes the clock without delaying the deadstart.

Anytime the time entry is hh hours, 59 minutes, ss seconds, CTI writes the clock as hh:59:00. Example: If the operator enters 14:59:59, CTI writes the clock as 14:59:00.

0 OS Load With Operator Intervention. Select this option to execute the hardware verification sequences, to reconfigure mainframe hardware components, or to change the operating system deadstart level or CMRDECK selection specified in the deadstart program. Refer to the Operator Intervention display, display I-3-2, later in this section for more information.

U Utilities. Select this option to:

- Perform an Express Deadstart Dump (dump memories and registers to tape).
- Perform a printer dump.
- Deadstart from a different device.
- Define default device parameters.
- Display CIP component levels.
- Initialize the mainframe after power interruption or maintenance activity.
- Clear deadstart error log (DEL).
- Load the monitor display driver (MDD) in standalone mode.
- Clear the central memory flaw table.
- Clear the mainframe reconfiguration table (MRT).

<u>Option</u>	<u>Description</u>
	Refer to the Utilities display, display I-3-8, later in this section for more information.
M	Off-Line Maintenance. This option enables the CE to execute hardware tests for preventive maintenance or hardware error diagnosis. Information about the option is included in the MSL 15X Reference Manual. The contents of word 12 of the deadstart program also affect the M option. Refer to Setting Word 12 in part II, section 1 of this manual.
H	Help for Initial Option Selection. When the CC634B console is being used, press H or the HELP key for a description of the initial options.

The CIP level, ppp- Vlll, is displayed at the bottom of the Initial Options display; ppp is mainframe type, and lll is the CIP version level. At the very bottom of the display, xxxx is the PSR level.

OPERATOR INTERVENTION DISPLAY

The Operator Intervention display, display I-3-2, appears when you select option 0, operator intervention, from the Initial Options display.

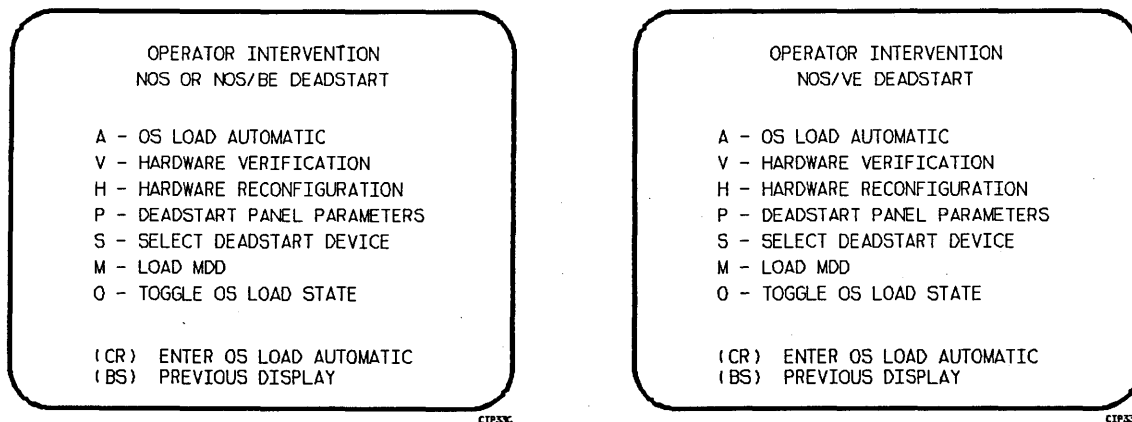

Display I-3-2. Operator Intervention

<u>Option</u>	<u>Description</u>
(CR) or A	OS Load Automatic. Select this option to perform an operating system load. Refer to the description of the OS Load Automatic option on the Initial Options display earlier in this section for more information.
V	Hardware Verification Sequence. Select this option to execute PP, CM, and CPU confidence tests.

If you have selected either a level 0, 1, or 2 deadstart, central memory contents are changed when you execute this option. The V option cannot be executed if a level 3 deadstart is selected.

You cannot test hardware that has been turned off via option H, hardware reconfiguration.

Option

Description

The names of the tests used by HIVS for the models 815 and 825 are CMC, CT8, EJP, and MY1. Appendix E provides a brief description of each test.

If an error condition occurs, one of the following messages appears:

ERROR PP xx
ERROR CM
ERROR CPU xx
ERROR REG

xx indicates the PP or CPU in error. Inform a CE.

Upon successful test completion, the system displays:

TESTING COMPLETE-DEADSTART

Initiate deadstart after testing to ensure that the system is returned to initial deadstart condition prior to system loading or recovery.

H Hardware Reconfiguration. Select this option to alter the mainframe hardware configuration. When selected, display I-3-3 appears:

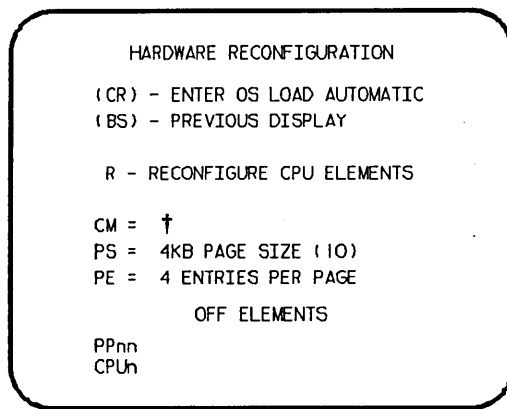

† IF NOS/VE DEADSTART, CM = MB CM SIZE (10); IF NOS OR NOS/BE DEADSTART, CM = CM WORDS/100B.

Display I-3-3. Hardware Reconfiguration

The hardware reconfiguration display permits you to reconfigure central memory elements. To reconfigure CPU elements, enter an R while displaying the Hardware Reconfiguration display to select the Reconfigure CPU Elements display. The Hardware Reconfiguration Reconfigure CPU Elements display, shown in display I-3-4, permits you to reconfigure CPU elements.

Option

Description

The default hardware configuration includes every hardware element available for use. To change the hardware configuration, enter the appropriate entry on the Hardware Reconfiguration or Reconfigure CPU Elements display as described in table I-3-1. When you turn off an element, its identifier is added to the OFF ELEMENTS list on the display. Entries are in the form keyword=option.

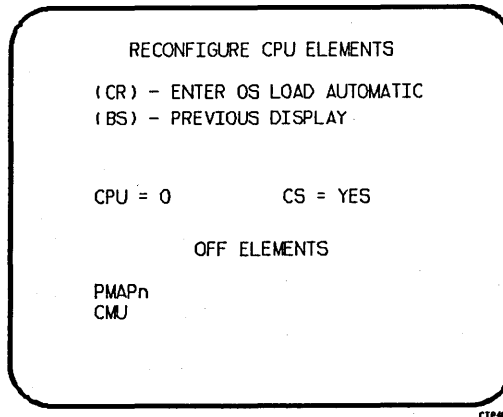

Display I-3-4. Reconfigure CPU Elements

Table I-3-1. Hardware Reconfiguration Entries, Models 815 and 825 (Sheet 1 of 2)

Keyword	Option	Display†	Function																					
CM=††	nnnnnnn	*1	<p>Specifies the size, in octal, of central memory in hundreds of words. The following examples show the value you enter for nnnnnnn, given the central memory size.</p> <table><thead><tr><th>Central Memory Size in Decimal Words</th><th>Central Memory Size in Megabytes</th><th>nnnnnnn</th></tr></thead><tbody><tr><td>131K</td><td>1</td><td>4000</td></tr><tr><td>262K</td><td>2</td><td>10000</td></tr><tr><td>524K</td><td>4</td><td>20000</td></tr><tr><td>1048K</td><td>8</td><td>40000</td></tr><tr><td>2097K</td><td>16</td><td>100000</td></tr><tr><td>4195K†††</td><td>32†††</td><td>200000</td></tr></tbody></table> <p>If you enter CM=0 or do not enter the CM=nnnnnnn parameter, the system sets the maximum central memory size.</p> <p>If you specify a value for nnnnnnn that exceeds the amount of physical memory, the system sends the following message:</p> <p>UNAVAILABLE</p>	Central Memory Size in Decimal Words	Central Memory Size in Megabytes	nnnnnnn	131K	1	4000	262K	2	10000	524K	4	20000	1048K	8	40000	2097K	16	100000	4195K†††	32†††	200000
Central Memory Size in Decimal Words	Central Memory Size in Megabytes	nnnnnnn																						
131K	1	4000																						
262K	2	10000																						
524K	4	20000																						
1048K	8	40000																						
2097K	16	100000																						
4195K†††	32†††	200000																						

Table I-3-1. Hardware Reconfiguration Entries, Models 815 and 825 (Sheet 2 of 2)

Keyword	Option	Display †	Function
CPU _n = ††	OFF/ON	*1	<p>If you specify a central memory size that is not large enough for a system deadstart, the system sets the maximum central memory size and the following message appears:</p> <p>INVALID ENTRY</p> <p>Specifies the logical status of each available CPU. Values for n can be 0 or 1.</p> <p>On a two-CPU system, at least one must be ON.</p> <p>If you enter CPU0=OFF on a one-CPU system, the entry is a no-op; the system uses the CPU.</p>
CPU=	n	*2	<p>Specifies the CPU for which you are to reconfigure elements. The CPU specified must be ON.</p>
CMU= ††	OFF/ON	*2	<p>Specifies logical status of the compare/move unit hardware.</p>
PP _{nn} = ††	OFF/ON	*1	<p>Logically turn OFF/ON one or more peripheral processors. Acceptable values for nn are 3 through 11 (excluding 10) and, if you have them, 20 through 31. Ranges may be specified. For example, PP5-7=OFF.</p>
PMAP _n = ††	OFF/ON	*2	<p>Specifies the logical status of each unit of the central processor page map.</p> <p>The value for n can be any number from 0 to 3. The value for n also can be in the form a-b (a through b); a and b can be any number from 0 to 3, and a is less than b.</p> <p>Turn OFF a page map unit only in the event of a hardware error. System performance degrades when a map unit is turned OFF.</p>
CS= ††	YES/NO	*2	<p>Specifies whether the system should load the central processor microcode into control store memory. The default is YES for all levels of deadstart. If NO is specified, the system does not load microcode from the deadstart disk into control store; whatever is there is used.</p>
PS= ††	xx	*1	<p>Specifies the NOS/VE page size for standalone or dual state deadstarts. The allowable page sizes in decimal kilobytes are 4, 8, 16, 32, and 64 (default=4).</p>
PE= ††	x	*1	<p>Specifies the NOS/VE entries per page table page for standalone or dual state deadstarts. The allowable values are 2, 4, and 8 (default=4).</p>
<p>† *1 = Hardware Reconfiguration Display; *2 = Reconfigure CPU Elements Display. †† This value is saved until changed for all deadstarts in the mainframe reconfiguration table for CYBER 180 mainframe. ††† Available only on models with memory upgrade option installed.</p>			

Option

Description

P Deadstart Panel Parameters. Select this option (NOS or NOS/BE) to change any of the following: the deadstart level, the CMRDECK, or deadstart program words 12 and 14. Select this option (NOS/VE) to change the DCFILE or the operator pause entry. The Deadstart Panel Parameters display, display I-3-5, appears.

Press the carriage return key to cause system deadstart processing to continue with no further intervention on your part. You cannot select additional options after this entry.

Press the backspace key to return to the Operator Intervention display.

Table I-3-2 lists the keyboard entries that you can make to change deadstart panel (program) parameters.

NOS or NOS/BE

NOS/VE

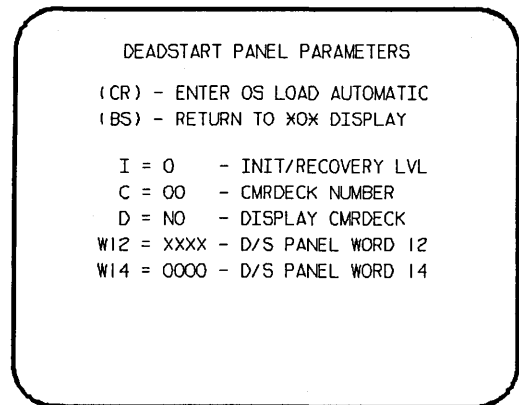
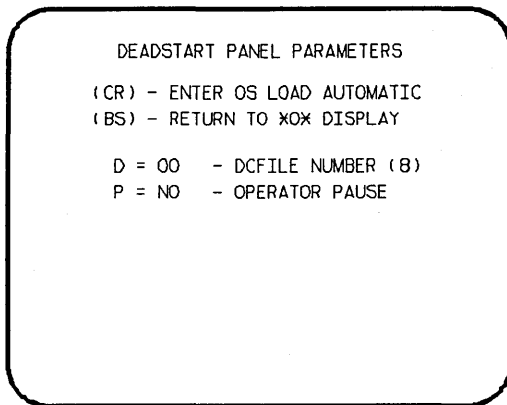

Display I-3-5. Deadstart Panel Parameters

S Select Deadstart Device. Select this option to specify an alternate disk or a tape device as the OS Deadstart Device (display I-3-6).

Press the carriage return key to cause system deadstart processing to continue with no further intervention on your part. You cannot select additional options after this entry. The CIP disk device is therefore the OS device.

Press the backspace key to return to the Operator Intervention display.

Entry

Description

T Tape OS Deadstart. Select this option for a tape OS deadstart rather than from disk. For NOS or NOS/BE deadstarts, the system prompts you for tape device type, channel, equipment, and unit. For NOS/VE deadstarts, the OS load initiates upon selecting this option.

D Alternate Disk OS Deadstart. Select this option to choose an alternate disk device for the OS deadstart device. For NOS or NOS/BE deadstarts, the system prompts you for the disk channel, equipment, and unit. For NOS/VE deadstarts, the OS load initiates upon selecting this option.

Table I-3-2. Keyboard Entries for the Deadstart Panel Parameters Display,
Models 815 and 825

Keyword	Function
<p>I=x</p> <p>C=xx</p> <p>D=xxx</p> <p>W12=xxxx</p> <p>W14=xxxx</p>	<p style="text-align: center;"><u>NOS or NOS/BE</u></p> <p>Specifies the level of deadstart. The value of x can be 0, 1, 2, or 3.</p> <p>Specifies the CMRDECK (CMRfor NOS/BE) number. The value of xx can be any number from 0 to 77 octal.</p> <p>Refer to the part II, section 1 for information about CMRDECK/CMR selection.</p> <p>Entry is not used by NOS/BE. For NOS, specifies whether the CMRDECK is to be displayed. The value of xxx can be:</p> <p style="padding-left: 40px;">YES for display CMRDECK.</p> <p style="padding-left: 40px;">NO for do not display CMRDECK.</p> <p>Specifies the value for deadstart program word 12. Refer to the part II, section 1 for the proper setting.</p> <p>Specifies the value for deadstart program word 14. Word 14 is reserved for the operating system or maintenance system.</p>
<p>D=xx</p> <p>P=xx</p>	<p style="text-align: center;"><u>NOS/VE</u></p> <p>Specifies the DCFILE number. The value of xx can be any number from 0 to 77 octal.</p> <p>Specifies whether a pause will be initiated for operator entries at the NOS/VE Deadstart Screen.</p>

SELECT OS DEADSTART DEVICE
(CR) - CONTINUE OS LOAD
(BS) - PREVIOUS DISPLAY
T - TAPE DEADSTART
D - ALTERNATE DISK DEADSTART

CIP42A

SELECT OS DEADSTART DEVICE
(BS) - PREVIOUS DISPLAY

T - TAPE DEADSTART
D - ALTERNATE DISK DEADSTART
(CR) - DEFAULT DISK DEADSTART

CIP42B

ALL OPTIONS EXIT TO THE CONTINUE OPERATING
SYSTEM LOAD PATH.

ENTER TAPE TYPE - 2
(1=66X. 2=63X/67X)

CHANNEL - 13
EQUIPMENT - 0
UNIT - 00

(BS) BACK TO PREVIOUS ENTRY

CIP13

OS DISK DEVICE LOCATION

CHANNEL - 01
EQUIPMENT - 0
UNIT - 00

(BS) BACK TO PREVIOUS ENTRY

CIP08B

Display I-3-6. Deadstart Device

Option

Description

- M Load the Monitor Display Driver (MDD) Program. This value is saved in the MRT until changed for all CYBER 180 mainframes. Select this option to load and execute MDD concurrent with the operating system. The display shown in display I-3-7 appears.

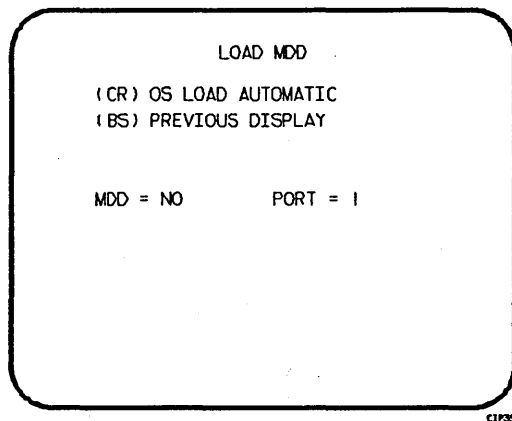

Display I-3-7. Load MDD

Direct the system to load MDD by entering:

MDD = YES

Select the port number of the two-port multiplexer that MDD uses by entering:

PORT = n

Parameter n is 0 or 1. The default port number is 1.

NOTE

Be sure the baud rate of the specified port of the two-port multiplexer is set properly for the communications being used.

- 0 Toggle the OS Load State to either a NOS/VE deadstart or a NOS or NOS/BE deadstart. The correct Load State is displayed below the Operator Intervention Display Header. This value is saved in the MRT until changed for all CYBER 180 mainframes.

Press the carriage return key to cause system deadstart processing to continue with no further intervention on your part.

Press the backspace key to return to the Operator Intervention display.

UTILITIES DISPLAY

Selecting the U option from the Initial Options display causes the Utilities display, display I-3-8, to appear.

UTILITIES

E EXPRESS DEADSTART DUMP
P PRINTER DUMP
S ALTERNATE DEADSTART
DEVICE SELECTION
D DEFINE AND DISPLAY DEFAULT
DEVICE PARAMETERS
L DISPLAY CIP COMPONENT
INFORMATION
I INITIALIZE MAINFRAME
C CLEAR DEADSTART ERROR LOG
F CLEAR CM FLAW TABLE
H CLEAR MAINFRAME RECONFIGURATION
TABLE
A LOAD MONITOR DISPLAY DRIVE

(CR) EXPRESS DEADSTART DUMP
(BS) PREVIOUS DISPLAY

CIP41A

Display I-3-8. Utilities, Disk Deadstart

<u>Option</u>	<u>Description</u>
(CR) or E	Express Deadstart Dump (EDD). Select this option to dump to magnetic tape the contents of PP memories, central memory, unified extended memory, CPU hardware registers, maintenance registers, processor control store memories, and the tape and disk controlware. When the E option is selected, CTI checks the error status of all system elements and displays error messages for any errors before allowing the deadstart dump to continue. Refer to Performing an Express Deadstart Dump in part II, section 2 for procedures and further information.
P	Dump to Printer. Select this option to dump central memory, PP memory, or maintenance register contents to a line printer. The Dump to Printer Options display, display I-3-9, appears. You cannot return to the Utilities display from this display. You must redeadstart the system. When the P option is selected, CTI checks the error status of all system elements and displays error messages for any errors before allowing the deadstart dump to continue. Table I-3-3 lists the keyboard entries for performing a printer dump. Refer to Performing a Printer Dump in part II, section 2 for procedures and further information.

NOTE

When the E or P options are selected, CTI will check the error status of all the system elements. If errors are encountered, CTI will log the errors in the deadstart error log. If the deadstart error log is full, CTI will display the errors before allowing the deadstart to continue.

A - 512 PRINTER INITIALIZE
B - 580 PRINTER INITIALIZE
C - PP MEMORY DUMP
D - CM DUMP
G - REGISTER FILE DUMP
H - PP MEMORY DUMP IN HEX
I - CENTRAL MEMORY DUMP IN HEX
J - REGISTER FILE DUMP IN HEX
K - IOU REGISTER DUMP IN HEX
L - CM REGISTER DUMP IN HEX
M - CPU REGISTER DUMP IN HEX
N - PEM REGISTER DUMP IN HEX
O - CONTROL STORE DUMP IN HEX

CTP070

Display I-3-9. Dump to Printer Options

Table I-3-3. Keyboard Entries for a Printer Dump, Models 815 and 825 (Sheet 1 of 2)

Entry	Function
A	512 Printer Initialize. This option initializes the 512 printer image with the data necessary to print with a 512-1 print train.
B	580 Printer Initialize. This option initializes the 580 printer buffer image and format buffer image memories.
C	PP Memory Dump. This option provides an octal dump to printer of 12-bit PP memories and 16-bit PP memories with their associated R registers.
D	CM Dump. This option provides an octal dump to printer of a selected area of central memory.
G	Register File Dump. This option provides an octal dump to printer of the CPU register file contents.
H	PP Memory Dump in Hexadecimal. This option provides a hexadecimal dump to the printer of the PP memories.
I	Central Memory Dump in Hexadecimal. This option provides a hexadecimal dump to the printer of a selected area of central memory.

Table I-3-3. Keyboard Entries for a Printer Dump, Models 815 and 825 (Sheet 2 of 2)

Entry	Function
J	Register File Dump in Hexadecimal. This option provides a hexadecimal dump to the printer of the CPU register file contents.
K	IOU Register Dump in Hexadecimal. This option provides a hexadecimal dump to the printer of the IOU maintenance register contents.
L	CM Register Dump in Hexadecimal. This option provides a hexadecimal dump to the printer of the contents of the central memory maintenance registers.
M	<p>CPU Register Dump in Hexadecimal. This option provides a hexadecimal dump to the printer of the contents of the CPU maintenance registers. Respond to the message CPU NO = by entering the number of the CPU for which registers are to be dumped. If microcode is not executing, the program dumps only the hardware maintenance registers. In place of the software registers, the following message appears on the printer dump:</p> <p style="text-align: center;">MICROCODE HUNG</p>
N	PEM Register Dump in Hexadecimal. This option provides a hexadecimal dump of the contents of the PEM registers.
O	Control Store Dump in Hexadecimal. This option provides a hexadecimal dump to the printer of the contents of control store. Respond to the message CPU NO = by entering the number of the CPU for which control store is to be dumped.

Option

Description

- S Alternate Deadstart. Select this option to specify an alternate CIP tape unit or disk device from which to deadstart. The Alternate Deadstart display, display I-3-10, appears.

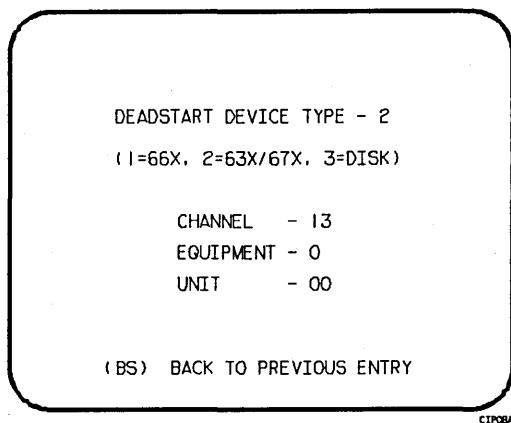

Display I-3-10. Alternate Deadstart

Enter the device type then press the carriage return key. The system then prompts you for channel, equipment, and unit numbers.

Default values are provided for the device parameters. The values are those specified in the default parameter block. The default parameter block is defined through option D, define default device parameters.

After the device information is entered, press the carriage return key to deadstart from the alternate device.

NOTE

Alternate deadstart from operating system deadstart tapes is not supported for model 800 computer systems. To load the operating system from a tape file, select option T, operating system file on tape, from the Operator Intervention display.

- D Define and Display Default Device Parameters. Select this option to assign default values to the channel, equipment, and unit numbers of a CIP tape deadstart device, disk deadstart device, alternate disk deadstart device, tape dump (EDD) device, or printer dump device. Default values are initially assigned to the device parameters when CIP is installed.

<u>Option</u>	<u>Description</u>
L	Display CIP Component Levels. Select this option to display the release levels of the CIP components: microcode, EI, SCD, DFT, NOS/VE programs, and MDD, and the full or empty status of the deadstart error log (DEL). An asterisk identifies components that have been installed manually.
I	Initialize Mainframe. Select this option to initialize the mainframe after power interruption or maintenance activity. The Initial Options display reappears with the following message on the bottom of the display: <p style="text-align: center;">ALL MAINFRAME MEMORIES WILL BE INITIALIZED FOR MSL/OS LOADS</p> Mainframe initialization, including initialization of central memory, PP memory, and maintenance registers, occurs when you select this option and then perform either an operating system load on a level 0, 1, or 2 (not 3) deadstart or select off-line maintenance option. Refer to part II, section 2 for procedures and additional information about this option.
C	Clear deadstart error log. Select this option to clear the data in the deadstart error log.
F	Clear central memory flaw table. Select this option to clear the data in the CM flaw table.
H	Clear the mainframe reconfiguration table. Select this option to clear the data in the mainframe reconfiguration table stored on disk.
A	Load the Monitor Display Driver. Select this option to execute MDD in a standalone mode (not concurrent with the operating system). When you specify A, the MDD Parameters display, display I-3-11, appears.

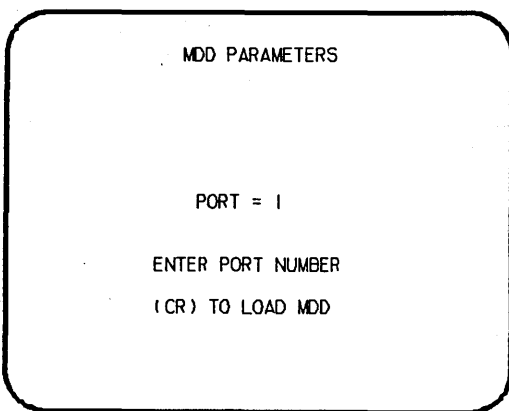

CIPMS

Display I-3-11. MDD Parameters

Option

Description

Enter the port number if different than the one displayed. Press the carriage return key to cause MDD to load. When you have finished using MDD, a deadstart is required. Refer to part III, section 1 for the uses of MDD.

This option is used to support the analysis of the state of a mainframe after encountering a system interrupt. It should only be selected after an operating system has been previously loaded. CTI loads MDD out of central memory (stored there on a system load) and issues the following message, if a checksum of the MDD program fails.

UNABLE TO LOAD MDD.

THE INTEGRITY OF CENTRAL MEMORY

DISPLAYS AND OPTIONS FOR DEADSTART FROM CIP TAPE

The CIP tape deadstart displays and options included in this subsection incorporate the following conventions:

- The default option on a menu display is the first option listed. The option can be selected automatically by pressing the carriage return key.
- Help information is provided for the Initial Options displays and the Build Deadstart Disk display. The Help displays supply brief information about the options. More detailed option information is given elsewhere in this section.
- Pressing the backspace key allows you to return to the previous display.

OVERVIEW

Figure I-3-2 provides an overview of the displays and options available during a deadstart from CIP tape on models 815 and 825.

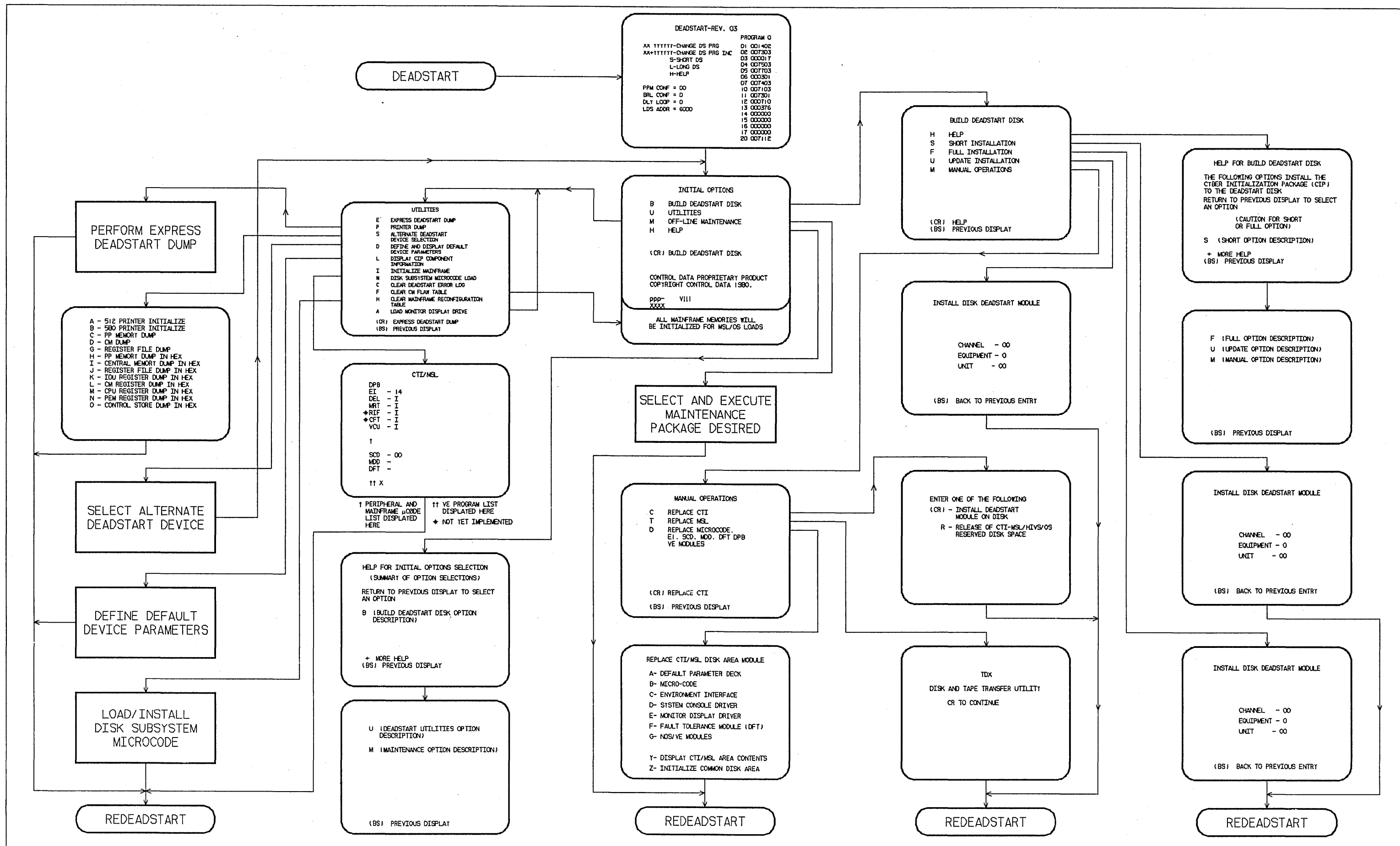

Figure I-3-2. Overview of Displays and Options for Deadstart
From CIP Tape (Models 815 and 825)

INITIAL OPTIONS DISPLAY

The Initial Options display, display I-3-12, is the first screen that appears after the deadstart program is initiated. When the deadstart program is set for deadstart from the CIP tape, the Initial Options display provides utilities to install the CIP to disk. A CIP tape deadstart also allows execution of several utilities from tape should the deadstart disk be unusable.

```
          INITIAL OPTIONS
          B  BUILD DEADSTART DISK
          U  UTILITIES
          M  OFF-LINE MAINTENANCE
          H  HELP

          (CR) BUILD DEADSTART DISK

          CONTROL DATA PROPRIETARY PRODUCT
          COPYRIGHT CONTROL DATA 1980.

          PPP-   VIII
          XXXX
```

CIP15

Display I-3-12. Initial Options From CIP Tape

<u>Option</u>	<u>Description</u>
(CR) or B	Build Deadstart Disk. This option allows you to install CIP to disk. The CIP modules must reside on the disk before an operating system deadstart can be performed. CIP modules are used to initialize the mainframe and establish the operating environment. Refer to CIP Installation earlier in this section.
U	Utilities. Select this option to: <ul style="list-style-type: none">• Perform an Express Deadstart Dump (dump memories and registers to tape).• Perform a printer dump.• Deadstart from a different device.• Define default device parameters.• Display CIP component levels.• Initialize the mainframe after power interruption or maintenance activity.• Load/install peripheral microcode.

Option

Description

- Clear deadstart error log.
- Load the Monitor Display Driver (MDD) in NOS/VE standalone mode.
- Clear the central memory flaw table.
- Clear the mainframe reconfiguration table (MRT).

M Off-Line Maintenance. This option is provided to enable the CE to execute hardware tests for preventive maintenance or hardware error diagnosis. Information about the option is included in the MSL 15X Reference Manual.

Execution of the hardware diagnostics from tape is much slower than from disk. Use tape only when your deadstart disk is not usable.

The contents of word 12 of the deadstart program also affect the M option. Refer to Setting Word 12 in part II, section 1.

H Help for Initial Options Selection. When the CC634B console is being used, press H or the HELP key for a description of the initial options.

The CIP level number, ppp- Vlll, is displayed at the bottom of the Initial Options displays, where ppp is mainframe type, and lll is CIP release level. The xxxx at the very bottom of the screen represents the PSR level.

BUILD DEADSTART DISK DISPLAY

The Build Deadstart Disk display, display I-3-13, appears when you select option B, build deadstart disk, from the Initial Options display. The Build Deadstart Disk display is available only when you deadstart from the CIP tape. This display provides the options that install the CIP to the deadstart disk. Refer to CIP Installation earlier in this section for installation procedures and displays.

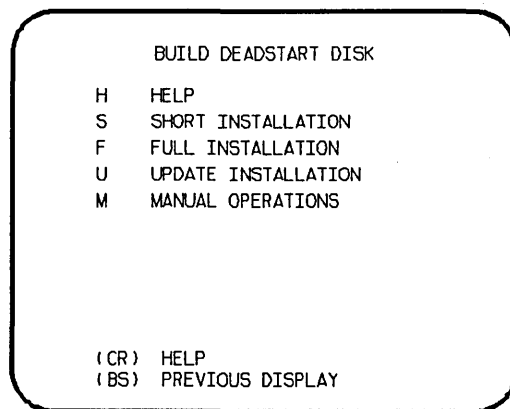

Display I-3-13. Build Deadstart Disk

<u>Option</u>	<u>Description</u>
(CR) or H	Help for Build Option Selection. When the CC634B console is being used, press H or the HELP key for a description of the build options.

CAUTION

The short and full installation options destroy all information on the deadstart disk, except for the disk microcode, before installing CIP. Before executing the short or full installation option, be sure you have a backup copy of any information on the deadstart disk that you want to preserve, including operating system permanent files and CE command buffers. After executing the short or full installation option, you must perform an operating system initialization of the disk.

- S Short Installation. Select this option to initialize the deadstart disk and then install the CIP to the deadstart disk. Some of the hardware diagnostics on the CIP will not be installed; only diagnostics needed most frequently by the CE are installed. Execute either the short or full installation option when you install CIP for the first time.
- F Full Installation. Select this option to initialize the deadstart disk and then install all of CIP to the deadstart disk. Execute either the short or full option when you install CIP for the first time.
- U Update Installation. Select this option to replace CIP on the deadstart disk some time after the short/full installation. The update option preserves operating system information on the deadstart disk.
- M Manual Operations. Select this option to perform emergency CIP component replacement at any time after CIP has been installed. Display I-3-14, the Manual Operations display, provides manual operation option selection.

MANUAL OPERATIONS DISPLAY

The Manual Operations display appears when you select option M, manual operations, from the Build Deadstart Disk display. Manual operations are available only when you deadstart from the CIP tape.

Manual operations provide manual replacement of individual CIP components, which may be required in the event of a critical problem. Refer to Emergency CIP Repair Procedures - Model 800 Computer Systems in part II, section 2 for repair and manual installation procedures. More detailed information about the manual operations is provided in the MSL 15X Reference Manual.

MANUAL OPERATIONS

C REPLACE CTI
T REPLACE MSL
D REPLACE MICROCODE,
EI, SCD, MDD, DFT DPB
VE MODULES

(CR) REPLACE CTI
(BS) PREVIOUS DISPLAY

CIPPCA

Display I-3-14. Manual Operations

<u>Option</u>	<u>Description</u>
(CR) or C	Replace CTI. Select this option to install the CTI component of CIP to the deadstart disk.

NOTE

This option provides the capability to release CTI-MSL/HIVS/OS disk space. For detailed procedures, see Build Deadstart Disk Operations in part II, section 2.

T	Replace MSL. Select this option to install the Maintenance Software Library component of CIP to the deadstart disk.
---	---

Option

Description

- D Replace microcode, EI, SCD, MDD, DFT, Default Device Parameters (DPB), or the NOS/VE modules.

NOTE

Select this option only after an initial install has been performed.

Select this option to replace microcode, EI, the CC634B System Console Driver (SCD), the Monitor Display Driver (MDD), Dedicated Fault Tolerance (DFT), default device parameters (DPB), or the NOS/VE boot modules, or to initialize the common disk area (CDA). When option D is selected, a prompt requests that you enter the disk channel and disk unit numbers. After you enter the channel and unit numbers or press the carriage return key to accept the default values shown, the CAU Initial Options display shown in display I-3-15 appears. Options A through G manually replace CIP components on the deadstart disk.

Select option Y on the CAU Options display to display the level numbers of the microcode and EI modules resident on the deadstart disk. If any module is manually replaced, an asterisk appears by the module name on this display.

REPLACE CTI/MSL DISK AREA MODULE

- A- DEFAULT PARAMETER DECK
- B- MICRO-CODE
- C- ENVIRONMENT INTERFACE
- D- SYSTEM CONSOLE DRIVER
- E- MONITOR DISPLAY DRIVER
- F- FAULT TOLERANCE MODULE (DFT)
- G- NOS/VE MODULES

- Y- DISPLAY CTI/MSL AREA CONTENTS
- Z- INITIALIZE COMMON DISK AREA

CIP22

Display I-3-15. CAU Initial Options

UTILITIES DISPLAY

Selecting the U option from the Initial Options display causes the Utilities display, display I-3-16, to appear.

UTILITIES

E EXPRESS DEADSTART DUMP
P PRINTER DUMP
S ALTERNATE DEADSTART
DEVICE SELECTION
D DEFINE AND DISPLAY DEFAULT
DEVICE PARAMETERS
L DISPLAY CIP COMPONENT
INFORMATION
I INITIALIZE MAINFRAME
M DISK SUBSYSTEM MICROCODE LOAD
C CLEAR DEADSTART ERROR LOG
F CLEAR CM FLAW TABLE
H CLEAR MAINFRAME RECONFIGURATION
TABLE
A LOAD MONITOR DISPLAY DRIVE

(CR) EXPRESS DEADSTART DUMP
(BS) PREVIOUS DISPLAY

CIP418

Display I-3-16. Utilities, Tape Deadstart

<u>Option</u>	<u>Description</u>
(CR) or E	Express Deadstart Dump (EDD). Select this option to dump to magnetic tape the contents of PP memories, central memory, unified extended memory, CPU hardware registers, maintenance registers, processor control store memories, and the tape and disk controlware. When the E option is selected, CTI checks the error status of all system elements and displays error messages for any errors before allowing the deadstart dump to continue. Refer to Performing an Express Deadstart Dump in part II, section 2 for procedures and information.
P	Dump to Printer. Select this option to dump central memory, PP memory, or maintenance register contents to a line printer. The Dump to Printer options display, display I-3-17, appears. You cannot return to the Utilities display from this display. You must redeadstart the system. When the P option is selected, CTI checks the error status of all system elements and displays error messages for any errors before allowing the deadstart dump to continue. Table I-3-4 shows the keyboard entries for performing a printer dump. Refer to Performing a Printer Dump in part II, section 2 for procedures and further information.

NOTE

When the E or P options are selected, CTI will check the error status of all the system elements. If errors are encountered, CTI will log the errors in the deadstart error log. If the deadstart error log is full, CTI will display the errors before allowing the deadstart to continue.

```

A - 512 PRINTER INITIALIZE
B - 580 PRINTER INITIALIZE
C - PP MEMORY DUMP
D - CM DUMP
G - REGISTER FILE DUMP
H - PP MEMORY DUMP IN HEX
I - CENTRAL MEMORY DUMP IN HEX
J - REGISTER FILE DUMP IN HEX
K - IOU REGISTER DUMP IN HEX
L - CM REGISTER DUMP IN HEX
M - CPU REGISTER DUMP IN HEX
N - PEM REGISTER DUMP IN HEX
O - CONTROL STORE DUMP IN HEX

```

CIP070

Display I-3-17. Dump to Printer Options

Table I-3-4. Keyboard Entries for a Printer Dump, Models 815 and 825 (Sheet 1 of 2)

Entry	Function
A	512 Printer Initialize. This option initializes the 512 printer image with the data necessary to print with a 512-1 print train.
B	580 Printer Initialize. This option initializes the 580 printer buffer image and format buffer image memories.
C	PP Memory Dump. This option provides an octal dump to printer of 12-bit PP memories and 16-bit PP memories with their associated R registers.
D	CM Dump. This option provides an octal dump to printer of a selected area of central memory.
G	Register File Dump. This option provides an octal dump to printer of the CPU register file contents.
H	PP Memory Dump in Hexadecimal. This option provides a hexadecimal dump to the printer of the PP memories.
I	Central Memory Dump in Hexadecimal. This option provides a hexadecimal dump to the printer of a selected area of central memory.
J	Register File Dump in Hexadecimal. This option provides a hexadecimal dump to the printer of the CPU register file contents.
K	IOU Register Dump in Hexadecimal. This option provides a hexadecimal dump to the printer of the IOU maintenance register contents.
L	CM Register Dump in Hexadecimal. This option provides a hexadecimal dump to the printer of the contents of the central memory maintenance registers.

Table I-3-4. Keyboard Entries for a Printer Dump, Models 815 and 825 (Sheet 2 of 2)

Entry	Function
M	<p>CPU Register Dump in Hexadecimal. This option provides a hexadecimal dump to the printer of the contents of the CPU maintenance registers. Respond to the message CPU NO = by entering the number of the CPU for which registers are to be dumped. If microcode is not executing, the program dumps only the hardware maintenance registers. In place of the software registers, the following message appears on the printer dump:</p> <p style="text-align: center;">MICROCODE HUNG</p>
N	<p>PEM Register Dump in Hexadecimal. This option provides a hexadecimal dump of the contents of the PEM registers.</p>
O	<p>Control Store Dump in Hexadecimal. This option provides a hexadecimal dump to the printer of the contents of control store. Respond to the message CPU NO = by entering the number of the CPU for which control store is to be dumped.</p>

Option

Description

- S Alternate Deadstart. Select this option to specify an alternate CIP tape unit or disk device from which to deadstart. The Alternate Deadstart display, display I-3-18, appears.

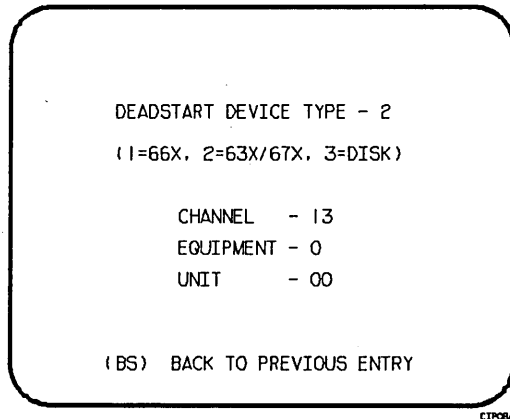

Display I-3-18. Alternate Deadstart

Enter the device type then press the carriage return key. The system then prompts you for channel, equipment, and unit numbers.

Option

Description

Default values are provided for the device parameters. The values are those specified in the default parameter block. The default parameter block is defined through option D, define default device parameters.

After the device information is entered, press the carriage return key to deadstart from the alternate device.

NOTE

Alternate deadstart from operating system deadstart tapes is not supported for model 800 computer systems. To load the operating system from a tape file, select option T, operating system file on tape, from the Operator Intervention display.

- D Define and Display Default Device Parameters. Select this option to assign default values to the channel, equipment, and unit numbers of a CIP tape deadstart device, disk deadstart device, alternate disk deadstart device, tape dump (EDD) device, or printer dump device. Default values are initially assigned to the device parameters when CIP is installed.
- L Display CIP Component Levels. Select this option to display the release levels of the CIP components: microcode, EI, SCD, DFT, NOS/VE programs, MDD, and the full or empty status of the deadstart error log (DEL). An asterisk identifies components that have been installed manually.
- I Initialize Mainframe. Select this option to initialize the mainframe after power interruption or maintenance activity. The Initial Options display reappears with the following message on the bottom of the display:
- ALL MAINFRAME MEMORIES WILL
BE INITIALIZED FOR MSL/OS LOADS
- Mainframe initialization, including initialization of central memory, PP memory, and maintenance registers, occurs when you select this option and then perform either an operating system load on a level 0, 1, or 2 (not 3) deadstart or select off-line maintenance option. Refer to part II, section 2 for procedures and additional information about this option.
- M Disk Subsystem Microcode Load. Select this option to load peripheral microcode into the 834/836 disk adapter and control module memory and install peripheral microcode onto specified drives. Refer to Loading and Installing Disk Subsystem Microcode From CIP Tape in part II, section 2 for procedures and additional information about this option.
- C Clear deadstart error log. Select this option to clear the data in the deadstart error log.
- F Clear central memory flaw table. Select this option to clear the data in the CM flaw table.
- H Clear the mainframe reconfiguration table. Select the option to clear the data in the mainframe reconfiguration table stored on disk.

Option

Description

- A Load the Monitor Display Driver. Select this option to execute MDD in a standalone mode (not concurrent with the operating system). When you specify A, the MDD Parameters display, display I-3-19, appears.

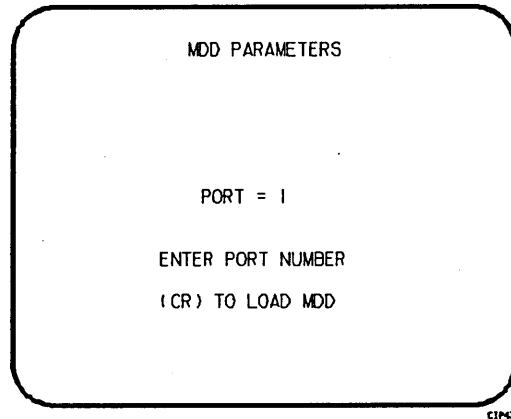

Display I-3-19. MDD Parameters

Enter the port number if different than the one displayed. Press the carriage return key to cause MDD to load. When you have finished using MDD, a deadstart is required. Refer to part III, section 1 for the uses of MDD.

This option is used to support the analysis of the state of a mainframe after encountering a system interrupt. It should only be selected after an operating system has been previously loaded. CTI loads MDD out of central memory (stored there on a system load) and issues the following message, if a checksum of the MDD program fails.

UNABLE TO LOAD MDD.

THE INTEGRITY OF CENTRAL MEMORY
HAS BEEN COMPROMISED.

CIP PROCEDURES, DISPLAYS, AND OPTIONS FOR CYBER 170/180 MODELS 835 THROUGH 860

4

This section includes automatic CIP installation procedures, operating system deadstart procedures, and descriptions of CIP displays and options available to users of CYBER 170/180 models 835, 845, and 855, and CYBER 180 models 840, 850, and 860.

CAUTION

For CYBER 170/180 systems using a NOS/VE version previous to 1.2.1, CIP should not be installed on a NOS/VE device. NOS/VE does not recognize CIP as a read-only disk area and will write over it.

CIP INSTALLATION

The CIP modules must be installed to disk for models 835 through 860. Select a disk unit in your configuration to be the deadstart disk. The installation process installs the CIP modules to the deadstart disk so that operating system information may also reside on the disk.

Install CIP to the deadstart disk or update CIP on the deadstart disk using the following procedure. The installation procedure requires dedicated machine time. At least one tape drive and one disk unit must be available. The procedure assumes that controlware has been loaded into the peripheral controller(s). If the controlware is not loaded, refer to part II, section 1 for coldstart instruction.

1. Mount the CIP tape on a tape drive.
2. Set the deadstart program for a deadstart from the CIP tape. Refer to part II, section 1.
3. Press the deadstart button (NOS or NOS/BE with a CC545 terminal). The Initial Options display appears.

NOTE

Deadstart from a CC634B terminal (required for NOS/VE standalone) is not normally supported for models 835 through 860.

Under certain conditions, users with both CC545 and CC634B consoles can initiate a deadstart by pressing the deadstart button on the CC545 or using the switch on the deadstart panel and have the displays appear on the CC634B console. For NOS/VE standalone, a CC634B terminal with option GK427A installed is required. This installs a deadstart button on the CC634B terminal. For details, refer to Deadstart Procedure Summaries and Setting Word 12 in part II, section 1.

4. Press the carriage return key to select the default option, build deadstart disk. The Build Deadstart Disk display appears.

CAUTION

Do not proceed until you have read all the instructions for step 5.

5. For first time installation of CIP tape select I, initial installation option, which initializes the deadstart disk and installs CIP. The initial installation option reserves 25 megabytes of disk storage for CIP.

NOTE

The initial installation option destroys all information on the deadstart disk, except the disk microcode, prior to installing CIP. Before executing the initial installation option, be sure you have a backup copy of any information on the deadstart disk that you want to preserve, including operating system permanent files and CE command buffers. After executing the initial installation option, you must perform an operating system initialization of the disk.

For installation of CIP some time after the initial installation, enter U to select the update option. The update option replaces CIP on the deadstart disk and preserves operating system information on the deadstart disk, including permanent files.

The CIP modules replaced during an Update are:

- CTI
- EI
- MSL (includes command buffers)
- Microcode
- MDD
- SCD
- DFT
- NOS/VE Programs

Information saved during an Update includes:

- Deadstart error log (DEL)
- Default parameter block
- Operating system pointers and permanent files
- NOS/VE system file pointers
- Mainframe reconfiguration table (MRT)

6. Enter the channel, equipment, and unit numbers of the deadstart disk when prompted. Follow each by pressing the carriage return key. Press only the carriage return key to select the displayed default value.
7. CIP installation is complete when the message INSTALLATION COMPLETE appears.

You can now perform an operating system load, off-line maintenance, default device parameter definition, or other deadstart utility operation. Refer to part II, section 2.

OPERATING SYSTEM DEADSTART

An operating system deadstart can be performed on models 835 through 860 only when CIP has been installed on disk. Procedures included here are for operating system deadstart when the deadstart program is set for deadstart from disk, which is known as disk deadstart.

Operating system tape deadstart is not supported for models 835, 845, and 855. Operating system load from a tape file, however, is supported for models 835, 845, and 855 through the disk deadstart process.

The operating system deadstart procedures require at least one disk unit and, when the operating system file is on tape, one tape unit. The procedures assume that controlware has been loaded into the peripheral controller(s). If the controlware is not loaded, refer to part II, section 1 for coldstart instruction.

DISK DEADSTART

This procedure assumes that:

- The deadstart program is set for deadstart from disk.
- CIP has been installed to disk. Refer to CIP Installation earlier in this section.

If the operating system file has also been installed to disk a complete disk deadstart can be performed. Refer to the NOS 2 Analysis Handbook, INSTALL command, to find out how to install the NOS file to disk. The NOS/BE level 0 deadstart process automatically installs the NOS/BE file on disk for use on following deadstarts. For NOS/VE standalone, refer to the NOS/VE Installation Reference manuals for installing NOS/VE to disk.

Operating System File on Disk

1. Press the deadstart button to initiate deadstart. The Initial Options display appears.

NOTE

Deadstart from a CC634B terminal (required for NOS/VE standalone) is not normally supported for models 835 through 860.

Under certain conditions, users with both CC545 and CC634B consoles can initiate a deadstart by pressing the deadstart button on the CC545 or using the switch on the deadstart panel and have the displays appear on the CC634B console. For NOS/VE standalone, a CC634B terminal with option GK427A installed is required. This installs a deadstart button on the CC634B terminal. For details, refer to Deadstart Procedure Summaries and Setting Word 12 in part II, section 1.

2. Press the carriage return key to select the default option, automatic OS load. The automatic option assumes that the deadstart program is set correctly on the deadstart panel for deadstart level (0, 1, 2, 3) and for CMRDECK selection (NOS), or for CMR selection (NOS/BE), or for DCFIL selection (NOS/VE).

If the deadstart program is set correctly, operating system deadstart is initiated.

3. If the deadstart program is not set correctly for these selections, select 0, operator intervention option. Operator intervention also allows reconfiguration of mainframe hardware components and execution of the hardware verification sequences. For specific information regarding operator intervention options refer to Displays and Options for Deadstart From Disk later in this section.

Operating System File on Tape or Alternate Disk

1. Press the deadstart button to initiate deadstart. The Initial Options display appears.

NOTE

Deadstart from a CC634B terminal (required for NOS/VE standalone) is not normally supported for models 835 through 860.

Under certain conditions, users with both CC545 and CC634B consoles can initiate a deadstart by pressing the deadstart button on the CC545 or using the switch on the deadstart panel and have the displays appear on the CC634B console. For NOS/VE standalone, a CC634B terminal with option GK427A installed is required. This installs a deadstart button on the CC634B terminal. For details, refer to Deadstart Procedure Summaries and Setting Word 12 in part II, section 1.

2. Enter 0 to select the operator intervention option. The Operator Intervention Option display appears.
3. If the deadstart program is not set correctly for deadstart level and for CMRDECK selection (NOS) or CMR selection (NOS/BE), or DCFIL selection (NOS/VE), enter P to select the deadstart parameters option, before proceeding. Operator intervention also allows reconfiguration of the mainframe hardware components and execution of hardware verification sequences. For specific information regarding operator intervention options, refer to Displays and Options for Deadstart From Disk later in this section.
4. Enter S to select tape or alternate disk deadstart.
 - a. Tape Deadstart
 1. Enter T to deadstart using a tape.
 2. Enter tape type, channel, equipment, and unit when prompted.†
 - b. Alternate Disk Deadstart
 1. Enter D to select alternate disk deadstart.
 2. Enter disk channel, equipment, and unit when prompted.†
5. Press the carriage return key. Operating system deadstart is initiated.†

† Applicable for NOS and NOS/BE deadstarts only. For NOS/VE deadstarts, the Operating System deadstart sequence is initiated upon selecting the D or T option. (Reference the NOS/VE Operations Manual for more information on NOS/VE Deadstarts.)

6. You will see messages indicating that NOS or NOS/BE is loading programs and running tests.

DISPLAYS AND OPTIONS FOR DEADSTART FROM DISK

The CIP disk deadstart displays and options included in this subsection incorporate the following conventions:

- The default option on a menu display is the first option listed. The option can be selected automatically by pressing the carriage return key.
- Help information is provided for the Initial Options displays and the Build Deadstart Disk display. The help displays supply brief information about the options. More detailed option information is given elsewhere in this section.
- Pressing the backspace key allows you to return to the previous display.

OVERVIEW

Figure I-4-1 presents an overview of the displays and options available during a deadstart from disk on models 835 through 860.

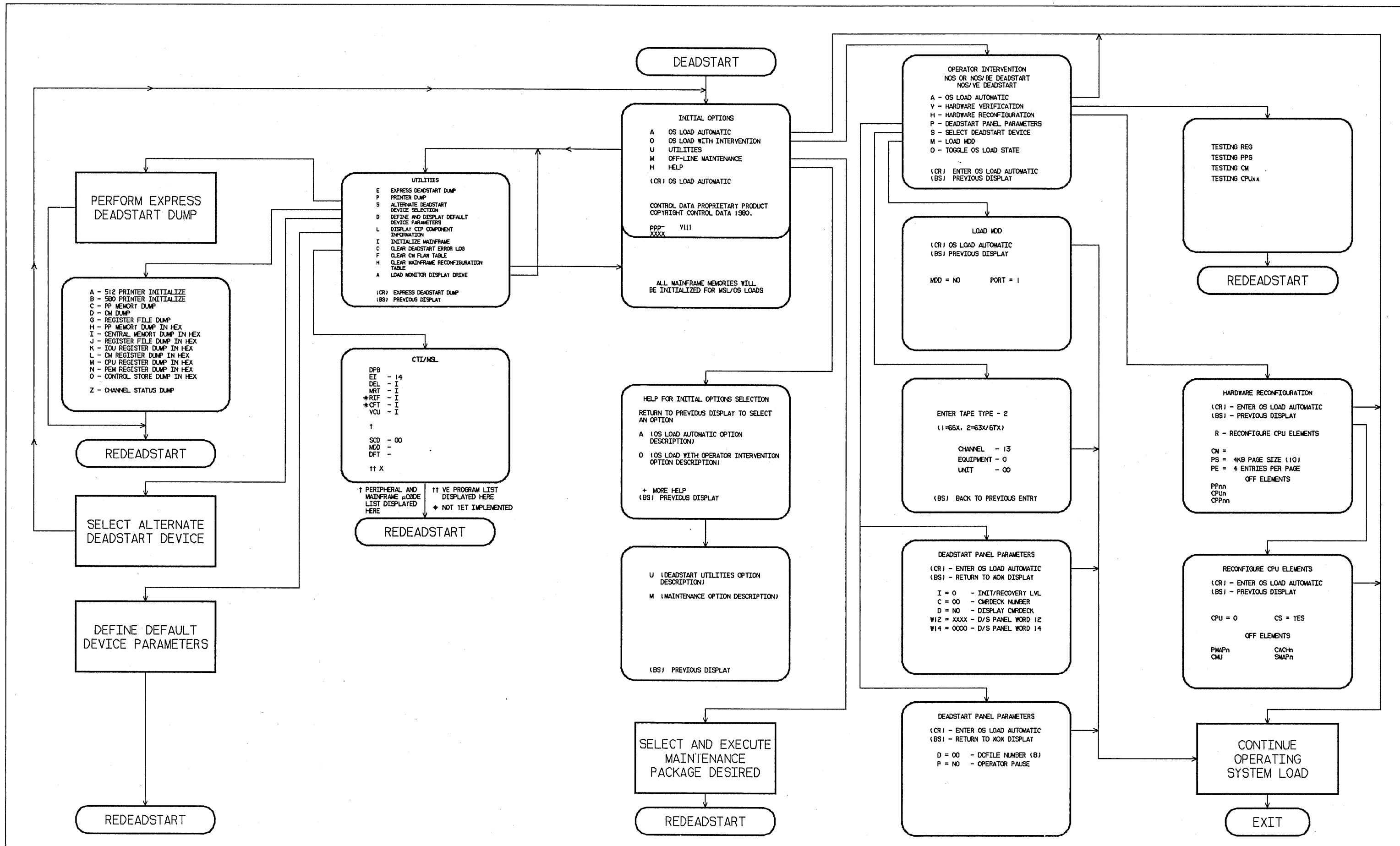

Figure I-4-1. Overview of Displays and Options for Deadstart From Disk (Models 835 through 860)

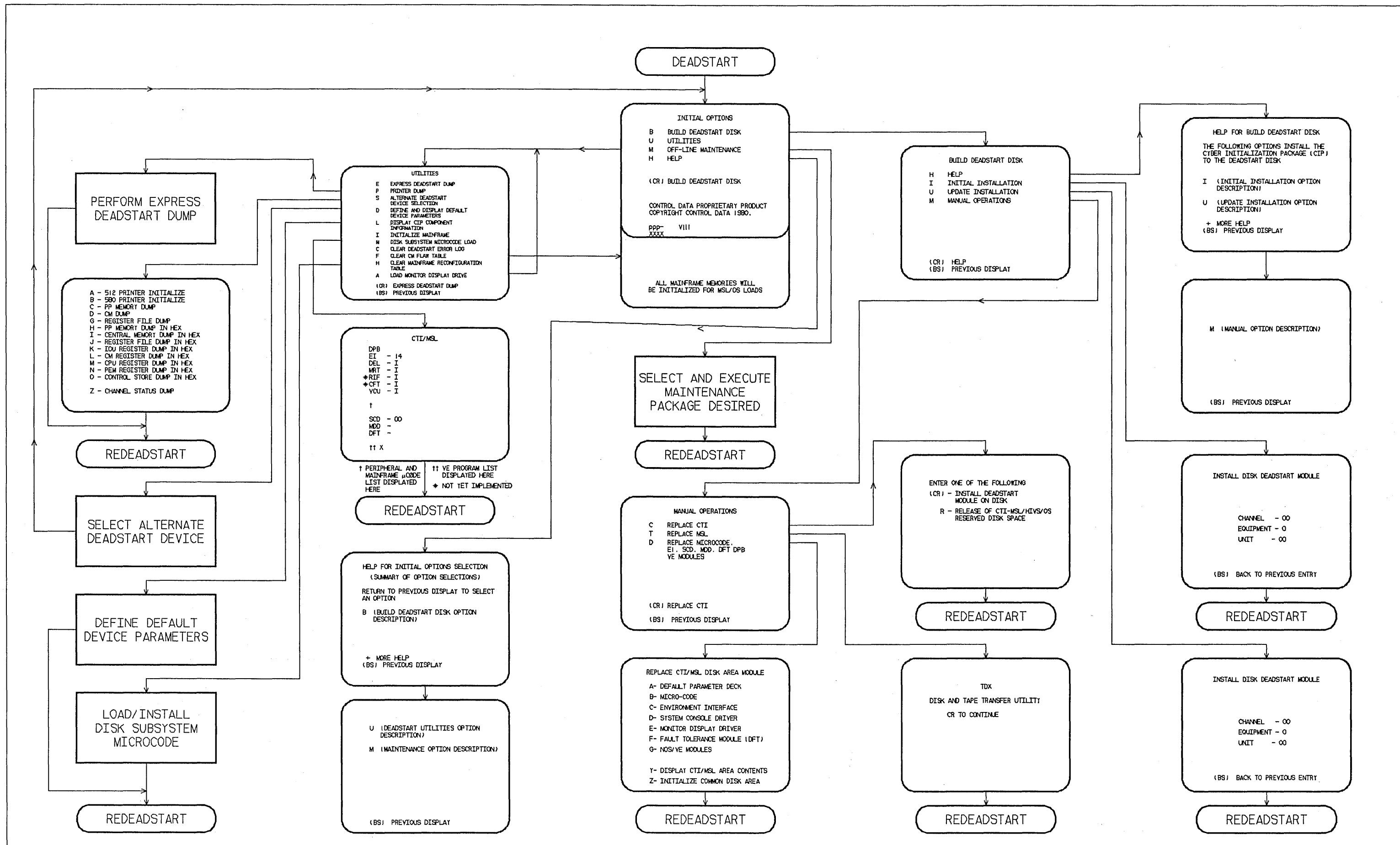
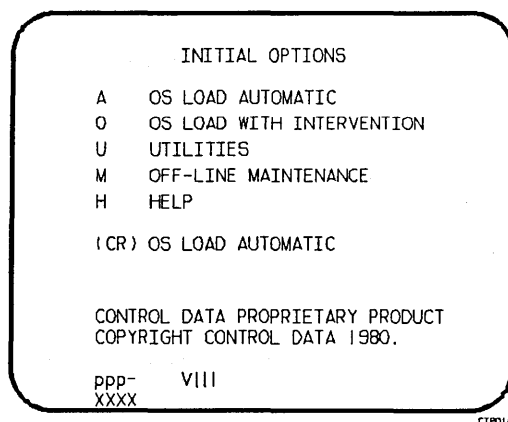

Figure I-4-2. Overview of Displays and Options for Deadstart From CIP Tape (Models 835 through 860)

INITIAL OPTIONS DISPLAY

The Initial Options display, display I-4-1, is the first screen that appears after deadstart is initiated. Deadstart is initiated on the models 835 through 860 by pressing the deadstart button.

The Initial Options display provides operating system load, execution of off-line maintenance, and deadstart utilities when the deadstart program is set for deadstart from disk.



Display I-4-1. Initial Options From Disk

<u>Option</u>	<u>Description</u>
(CR) or A	OS Load Automatic. The system initialization software assumes that CIP has been installed to the deadstart disk. The system loads modules from the deadstart disk into memory and the central processor to establish the operating environment. Then, confidence tests verify the ability of PP memory to hold simple data patterns and preset PP memory contents to all ones. The ENTER DATE and ENTER TIME prompts are displayed on the models 835 through 860 systems only under the following conditions I2 IOU systems: The operator has selected mainframe initialization and either: a. NOS/VE load, or b. The operating system being loaded supports CTI as primary source of current date and time. I4 IOU systems: The Two Port Mux wall clock data is invalid and either a or b above is true.

Option

Description

NOTE

The smallest unit of time that can be written to the Two Port Mux is minutes. If clock accuracy to within 1 second is desired, the operator should enter the desired seconds. However, this causes CTI to delay to the next minute before writing the clock and continuing the deadstart. Example: If the operator enters a time of 08:15:05, CTI delays for 55 seconds, and writes the clock with a time of 08:16:00. The informative message Updating Clock is added to the display during the delay.

If clock accuracy to within 1 minute is sufficient, the operator can enter 00 seconds and CTI writes the clock without delaying the deadstart.

Anytime the time entry is hh hours, 59 minutes, ss seconds, CTI writes the clock as hh:59:00. Example: If the operator enters 14:59:59, CTI writes the clock as 14:59:00.

Since I2 systems do not have a wall clock present in the Two Port Mux, any valid time entry is permitted and will be saved on the CIP deadstart device as entered without delaying the deadstart.

If the system detects a fatal error during confidence testing, CTI records the errors in the critical error log (CEL) if it is empty for later processing by the operating system. The following information appears on the left screen:

DEADSTART ABORTED - FATAL ERROR

```
eeee-nn  rrrr  =cc cc cc cc cc cc cc cc
          rrrr  =cc cc cc cc cc cc cc cc
          rrrr  =cc cc cc cc cc cc cc cc
```

Notation

Description

eeee-nn Name and logical number of the hardware that has the error.

Name

Hardware

IOU-00 Input/output unit.
MEM-00 Central memory.
PROC-0n Central processing unit. n=logical number.

rrrr Register name.

cc Register content in hexadecimal notation.

Inform a CE when a fatal error occurs.

<u>Option</u>	<u>Description</u>
O	OS Load With Operator Intervention. Select this option to execute the hardware verification sequences, to reconfigure mainframe hardware components, or to change the operating system deadstart level, or CMRDECK selection specified in the deadstart program. Refer the Operator Intervention display, display I-4-2, later in this section for more information.
U	Utilities. Select this option to: <ul style="list-style-type: none"> • Perform an Express Deadstart Dump (dump memories and registers to tape). • Perform a printer dump. • Deadstart from a different device. • Define default device parameters. • Display CIP component levels. • Initialize the mainframe after power interruption or maintenance activity. • Clear deadstart error log (DEL). • Load the Monitor Display Driver (MDD) in standalone mode. • Clear the central memory flaw table. • Clear the mainframe reconfiguration table (MRT). <p>Refer to the Utilities display, display I-4-8, later in this section for more information.</p>
M	Off-Line Maintenance. This option enables the CE to execute hardware tests for preventive maintenance or hardware error diagnosis. Information about the option is included in the MSL 15X Reference Manual. The contents of word 12 of the deadstart program also affect the M option. Refer to Setting Word 12 in part II, section 1.
H	Help for Initial Option Selection.

The CIP level, ppp- Vlll, is displayed at the bottom of the Initial Options display; ppp is mainframe type, and lll is the CIP version level. At the very bottom of the display, xxxx is the PSR level.

OPERATOR INTERVENTION DISPLAY

The Operator Intervention display, display I-4-2, appears when option 0, operator intervention, is selected at the Initial Options display.

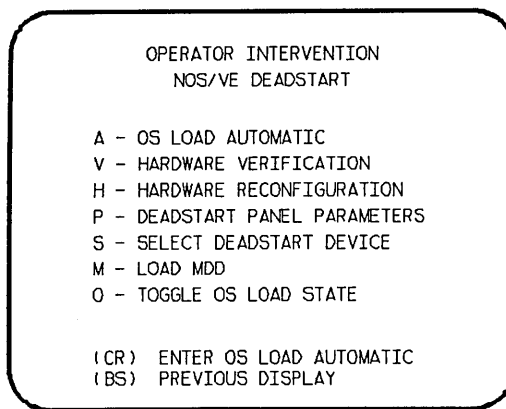
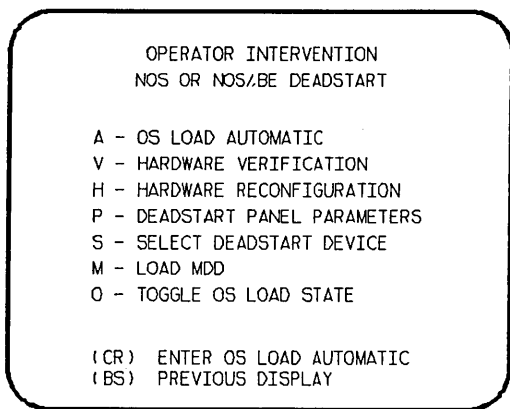

Display I-4-2. Operator Intervention

<u>Option</u>	<u>Description</u>
(CR) or A	OS Load Automatic. Select this option to perform an operating system load. Refer to the description of the OS load automatic option on the Initial Options display earlier in this section for more information.
V	Hardware Verification Sequence. Select this option to execute PP, CM, and CPU confidence tests. If you have selected either a level 0, 1, or 2 deadstart, central memory contents are changed when you execute this option. The V option cannot be executed if a level 3 deadstart is selected. You cannot test hardware that has been turned off via option H, hardware reconfiguration. The names of the tests used by HIVS for the models 835 through 860 are CMC, CT8, EJP, and MY1. Appendix E includes a brief description of each test. If an error condition occurs, one of the following messages appears: ERROR PP xx ERROR CM ERROR CPU xx ERROR REG

Option

Description

xx indicates the PP or CPU in error. Contact a CE.

Upon successful test completion, the system displays:

TESTING COMPLETE-DEADSTART

Initiate deadstart after testing to ensure that the system is returned to initial deadstart condition prior to system loading or recovery.

H Hardware Reconfiguration. Select this option to alter the mainframe hardware configuration. When selected, display I-4-3 appears.

```

      HARDWARE RECONFIGURATION
      (CR) - ENTER OS LOAD AUTOMATIC
      (BS) - PREVIOUS DISPLAY

      R - RECONFIGURE CPU ELEMENTS

      CM = †
      PS = 4KB PAGE SIZE (10)
      PE = 4 ENTRIES PER PAGE
           OFF ELEMENTS
      PPnn
      CPUh
      CPPnn

```

C1P04C

† IF NOS/VE DEADSTART, CM = MB CM SIZE (10); IF NOS or NOS/BE DEADSTART CM, = CM WORDS/100B.

Display I-4-3. Hardware Reconfiguration

The hardware reconfiguration display permits you to reconfigure central memory elements. To reconfigure CPU elements, enter an R while displaying this display to select the Reconfigure CPU Elements display. The Reconfigure CPU Elements display, shown in display I-4-4 permits you to reconfigure CPU elements.

Option

Description

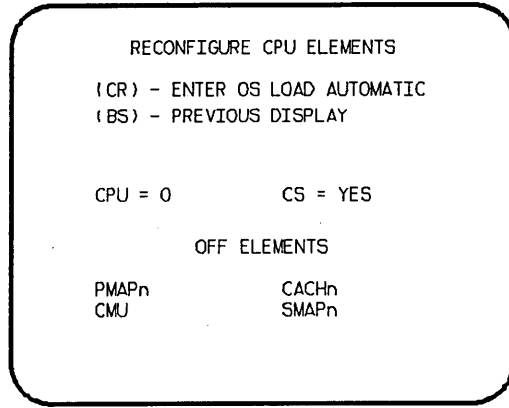

C1P408

Display I-4-4. Reconfigure CPU Elements

The default hardware configuration includes every hardware element available for use. To change the hardware configuration, enter the appropriate entry on the Hardware Reconfiguration display or Reconfigure CPU Elements display as described in table I-4-1. When you turn off an element, its identifier is added to the OFF ELEMENTS list on the display. Entries are in the form keyword=option.

Table I-4-1. Hardware Reconfiguration Entries, Models 835 through 860 (Sheet 1 of 3)

Keyword	Option	Display †	Function																											
CM= ††	nnnnnnn	*1	<p>Specifies the size, in octal, of central memory in hundreds of words. The following examples show the value you enter for nnnnnnn, given the central memory size.</p> <table><thead><tr><th>Central Memory Size in Decimal Words</th><th>Central Memory Size in Megabytes</th><th>nnnnnnn</th></tr></thead><tbody><tr><td>131K</td><td>1</td><td>4000</td></tr><tr><td>262K</td><td>2</td><td>10000</td></tr><tr><td>524K</td><td>4</td><td>20000</td></tr><tr><td>1048K</td><td>8</td><td>40000</td></tr><tr><td>2097K</td><td>16</td><td>100000</td></tr><tr><td>4195K †††</td><td>32 †††</td><td>200000</td></tr><tr><td>8390K †††</td><td>64 †††</td><td>400000</td></tr><tr><td>16780K †††</td><td>128 †††</td><td>1000000</td></tr></tbody></table> <p>If you enter CM=0 or do not enter the CM=nnnnnnn parameter, the system sets the maximum central memory size.</p>	Central Memory Size in Decimal Words	Central Memory Size in Megabytes	nnnnnnn	131K	1	4000	262K	2	10000	524K	4	20000	1048K	8	40000	2097K	16	100000	4195K †††	32 †††	200000	8390K †††	64 †††	400000	16780K †††	128 †††	1000000
Central Memory Size in Decimal Words	Central Memory Size in Megabytes	nnnnnnn																												
131K	1	4000																												
262K	2	10000																												
524K	4	20000																												
1048K	8	40000																												
2097K	16	100000																												
4195K †††	32 †††	200000																												
8390K †††	64 †††	400000																												
16780K †††	128 †††	1000000																												

Table I-4-1. Hardware Reconfiguration Entries, Models 835 through 860 (Sheet 2 of 3)

Keyword	Option	Display†	Function
			<p>If you specify a value for nnnnnnn that exceeds the amount of physical memory, the system sends the following message:</p> <p style="text-align: center;">UNAVAILABLE</p> <p>If you specify a central memory size that is not large enough for a system deadstart, the system sets the maximum central memory size and the following message appears:</p> <p style="text-align: center;">INVALID ENTRY</p>
CPU _n = ††	OFF/ON	*2	<p>Specifies the logical status of each available CPU. Values for n can be 0 or 1.</p> <p>On a two-CPU system, at least one must be ON.</p> <p>If you enter CPU0=OFF on a one-CPU system, the entry is a no-op; the system uses the CPU.</p>
CPU=	n	*2	<p>Specifies the CPU for which you are to reconfigure elements.</p>
PP _{nn} = ††	OFF/ON	*1	<p>Logically turn OFF/ON one or more peripheral processors. Acceptable values for nn are 3 through 11 (excluding 10) and, if you have them, 20 through 31. Ranges may be specified. For example, PP5-7=OFF.</p>
PMA _{Pn} = ††	OFF/ON	*2	<p>Specifies the logical status of each unit of the central processor page map.</p> <p>The value for n can be any number from 0 to 3. The value for n also can be in the form a-b (a through b); a and b can be any number from 0 to 3, and a is less than b.</p> <p>Turn OFF a page map unit only in the event of a hardware error. System performance degrades when a map unit is turned OFF.</p>
CACH _n = ††	OFF/ON	*2	<p>Specifies logical status of each central processor cache unit. Acceptable values for n are 0 through 3. Ranges may be specified. For example, CACH0-1=OFF.</p> <p>Turn OFF a cache unit only in the event of a hardware error. System performance degrades when a cache unit is turned off.</p>

Table I-4-1. Hardware Reconfiguration Entries, Models 835 through 860 (Sheet 3 of 3)

Keyword	Option	Display †	Function
SMAPn=††	OFF/ON	*2	Specifies logical status of each central processor segment map unit. Acceptable values for n are 0, 1, or 0-1. For example, SMAPO-1=OFF. Turn OFF a segment map unit only in the event of a hardware error. System performance degrades when a segment map unit is turned OFF.
CS=††	YES/NO	*2	Specifies whether the system should load the central processor microcode into control store memory. The default is YES for all levels of deadstart. If NO is specified, the system does not load microcode from the deadstart disk into control store; whatever is there is used.
CPPnn††	OFF/ON	*1	Logically turn OFF/ON one or more I4 DMA/CIO peripheral processors. Acceptable values for nn are 0-11. Ranges may be specified. For example, CPP 5-7=OFF. Values for nn must be octal.
PS=††	xx	*1	Specifies the NOS/VE page size for standalone or dual state deadstarts. The allowable page sizes in decimal kilobytes are 4, 8, 16, 32, and 64 (default=4).
PE=††	x	*1	Specifies the NOS/VE entries per page table page for standalone or dual state deadstarts. The allowable values are 2, 4, and 8 (default=4).
<p>†*1 = Hardware Reconfiguration Display; *2 = Reconfigure CPU Elements Display. †† These values are saved until changed for all deadstarts in the mainframe reconfiguration table for CYBER 180 mainframes. ††† Available on models 840, 850, and 860. Also available on models 845 and 855 with memory upgrade option installed.</p>			

Option

Description

P
(NOS or
NOS/BE)

Deadstart Panel Parameters for NOS or NOS/BE. Select this option to change any of the following: the deadstart level, the CMRDECK, or deadstart program words 12 and 14. The Deadstart Panel Parameters display, display I-4-5, appears.

Press the carriage return key to cause system deadstart processing to continue with no further intervention on your part. You cannot select additional options after this entry.

Press the backspace key to return to the Operator Intervention display.

Table I-4-2 lists the keyboard entries that you can make to change deadstart panel (program) parameters.

<u>Option</u>	<u>Description</u>
P (NOS/VE)	Deadstart Panel Parameters for NOS/VE. Select this option to change the DCFILE or the operator pause entry.

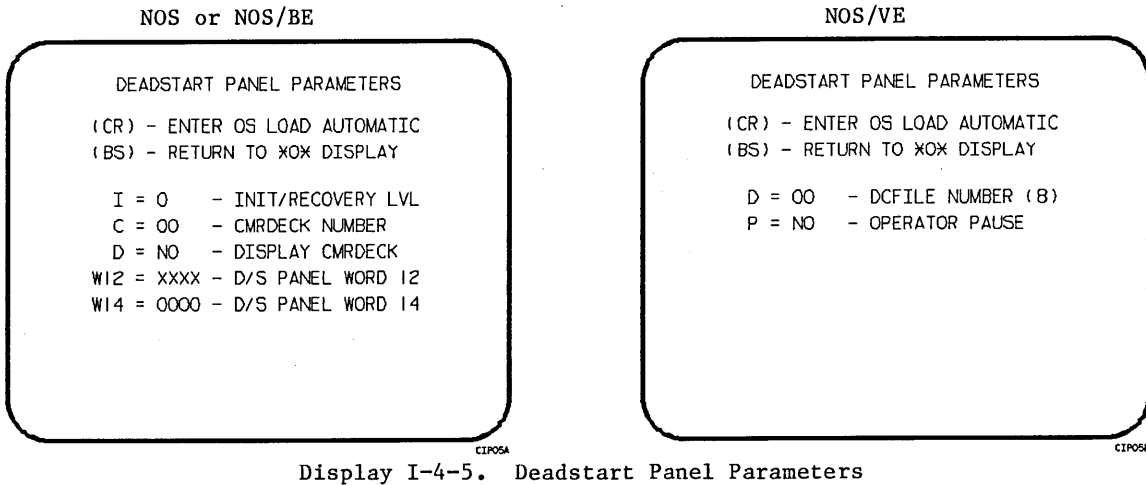

Display I-4-5. Deadstart Panel Parameters

Table I-4-2. Keyboard Entries for the Deadstart Panel Parameters Display, Models 835 through 860

Keyword	Function
I=x	Specifies the level of deadstart. The value of x can be 0, 1, 2, or 3.
C=xx	Specifies the CMRDECK (CMR for NOS/BE) number. The value of xx can be 0 through 77 octal. Refer to part II, section 1 for information about CMRDECK, CMR selection.
D=xxx	Entry is not used by NOS/BE. For NOS, specifies whether the CMRDECK is to be displayed. The value of xxx can be: YES for display CMRDECK. NO for do not display CMRDECK.
W12=xxxx	Specifies the value for deadstart program word 12. Refer to part II, section 1 for the proper setting.
W14=xxxx	Specifies the value for deadstart program word 14. Word 14 is reserved for the operating system or maintenance system.

Option

Description

S Select Deadstart Device. Select this option to specify an alternate disk or a tape device as the OS Deadstart Device (figure I-4-6).

Press the carriage return key to cause system deadstart processing to continue with no further intervention on your part. You cannot select additional options after this entry. The CIP disk device is therefore the OS device.

Press the backspace key to return to the Operator Intervention display.

Entry

Description

T Tape OS Deadstart. Select this option for a tape OS deadstart rather than from disk. For NOS or NOS/BE deadstarts, the system prompts you for tape device type, channel, equipment, and unit. For NOS/VE deadstarts, the OS load initiates upon selecting this option.

D Alternate Disk OS Deadstart. Select this option to choose an alternate

SELECT OS DEADSTART DEVICE
(CR) - CONTINUE OS LOAD
(BS) - PREVIOUS DISPLAY
T - TAPE DEADSTART
D - ALTERNATE DISK DEADSTART

CIP42A

SELECT OS DEADSTART DEVICE
(BS) - PREVIOUS DISPLAY

T - TAPE DEADSTART
D - ALTERNATE DISK DEADSTART
(CR) - DEFAULT DISK DEADSTART

CIP42B

ALL OPTIONS EXIT TO THE CONTINUE OPERATING
SYSTEM LOAD PATH.

ENTER TAPE TYPE - 2
(1=66X, 2=63X/67X)

CHANNEL - 13
EQUIPMENT - 0
UNIT - 00

(BS) BACK TO PREVIOUS ENTRY

CIP13

OS DISK DEVICE LOCATION

CHANNEL - 01
EQUIPMENT - 0
UNIT - 00

(BS) BACK TO PREVIOUS ENTRY

CIP08B

Display I-4-6. Deadstart Device

Option

Description

- M Load the Monitor Display Driver (MDD) Program. This value is saved in the MRT until changed for all CYBER 180 mainframes. Select this option to load and execute MDD concurrent with the operating system. The display shown in display I-4-7 appears.

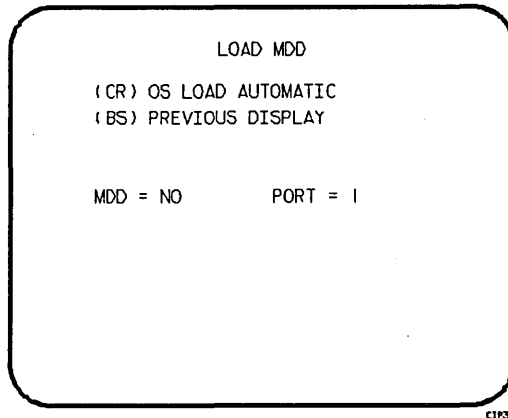

Display I-4-7. Load MDD

Direct the system to load MDD by entering:

MDD = YES

Select the port number of the two-port multiplexer that MDD uses by entering:

PORT = n

Parameter n is 0 or 1. The default port number is 1.

NOTE

Be sure the baud rate of the specified port of the two-port multiplexer is set properly for the communications being used.

- O Toggle the OS Load State to either a NOS/VE deadstart or a NOS or NOS/BE deadstart. The correct Load State is displayed below the Operator Intervention Display Header. This value is saved in the MRT until changed for all CYBER 180 mainframes.

Press the carriage return key to cause system deadstart processing to continue with no further intervention on your part.

Press the backspace key to return to the Operator Intervention display.

UTILITIES DISPLAY

Selecting the U option from the Initial Options display causes the Utilities display, display I-4-8, to appear.

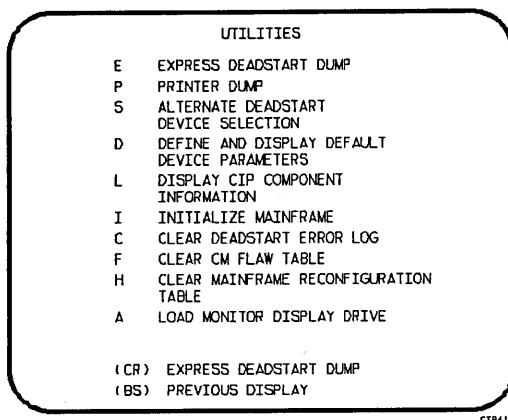

Display I-4-8. Utilities, Disk Deadstart

<u>Option</u>	<u>Description</u>
(CR) or E	Express Deadstart Dump (EDD). Select this option to dump to magnetic tape the contents of PP memories, central memory, unified extended memory, CPU hardware registers, maintenance registers, processor control store memories, and the tape and disk controlware. When the E option is selected, CTI checks the error status of all system elements and displays error messages for any errors before allowing the deadstart dump to continue. Refer to Performing an Express Deadstart Dump in part II, section 2 for further information.
P	Dump to Printer. Select this option to dump central memory, PP memory, or maintenance register contents to a line printer. The Dump to Printer Options display, display I-4-9, appears. You cannot return to the Utilities display from this display. You must redeadstart the system. When the P option is selected, CTI checks the error status of all system elements and displays error messages for any errors before allowing the deadstart dump to continue. Table I-4-3 lists the keyboard entries for performing a printer dump. Refer to Performing a Printer Dump in part II, section 2 for further information.

NOTE

When the E or P options are selected, CTI will check the error status of all the system elements. If errors are encountered, CTI will log the errors in the deadstart error log. If the deadstart error log is full, CTI will display the errors before allowing the deadstart to continue.

A - 512 PRINTER INITIALIZE
 B - 580 PRINTER INITIALIZE
 C - PP MEMORY DUMP
 D - CM DUMP
 G - REGISTER FILE DUMP
 H - PP MEMORY DUMP IN HEX
 I - CENTRAL MEMORY DUMP IN HEX
 J - REGISTER FILE DUMP IN HEX
 K - IOU REGISTER DUMP IN HEX
 L - CM REGISTER DUMP IN HEX
 M - CPU REGISTER DUMP IN HEX
 N - PEM REGISTER DUMP IN HEX
 O - CONTROL STORE DUMP IN HEX

 Z - CHANNEL STATUS DUMP

CIPOTA

Display I-4-9. Dump to Printer Options

Table I-4-3. Keyboard Entries for a Printer Dump, Models 835 through 860 (Sheet 1 of 2)

Entry	Function
A	512 Printer Initialize. This option initializes the 512 printer image with the data necessary to print with a 512-1 print train.
B	580 Printer Initialize. This option initializes the 580 printer buffer image and format buffer image memories.
C	PP Memory Dump. This option provides an octal dump to printer of 12-bit PP memories and 16-bit PP memories with their associated R registers.
D	CM Dump. This option provides an octal dump to printer of a selected area of central memory.
G	Register File Dump. This option provides an octal dump to printer of the CPU register file contents.
H	PP Memory Dump in Hexadecimal. This option provides a hexadecimal dump to the printer of the PP memories. If the IOU is an I4, the associated P, Q, K, and A register values will also be dumped.
I	CM Dump in Hexadecimal. This option provides a hexadecimal dump to the printer of a selected area of central memory.
J	Register File Dump in Hexadecimal. This option provides a hexadecimal dump to the printer of the CPU register file contents.
K	IOU Register File Dump in Hexadecimal. This option provides a hexadecimal dump to the printer of the IOU maintenance register contents. If the IOU is an I4, the CIO registers will also be dumped, if installed.

Table I-4-3. Keyboard Entries for a Printer Dump,
Models 835 through 860 (Sheet 2 of 2)

Entry	Function
L	CM Register Dump in Hexadecimal. This option provides a hexadecimal dump to the printer of the contents of the central memory maintenance registers.
M	<p>CPU Register Dump in Hexadecimal. This option provides a hexadecimal dump to the printer of the contents of the CPU maintenance registers. Respond to the message CPU NO = by entering the number of the CPU for which registers are to be dumped.</p> <p>If microcode is not executing, the program dumps only the hardware maintenance registers. In place of the software registers, the following message appears on the printer dump:</p> <p style="padding-left: 40px;">MICROCODE HUNG</p>
N	Control Store Dump in Hexadecimal. This option provides a hexadecimal dump to the printer of the contents of control store followed by a dump of shadow memory, if available. Respond to the message CPU NO = by entering the number of the CPU for which control store is to be dumped.
O	PEM Register Dump in Hexadecimal. This option provides hexadecimal dump of the contents of the PEM registers.
Z	Channel Status Dump. This option, available on I4 IOU's only, dumps the status of parity error disable, active, full, channel flag and channel error for NIO channels 00-31B, and, if installed, CIO channels 00-11B. A "0" in the resulting output indicates the corresponding status flag is clear and a "1" indicates the flag is set (I4 only).

Option

Description

- S Alternate Deadstart. Select this option to specify an alternate CIP tape unit or disk device from which to deadstart. The Alternate Deadstart display, display I-4-10, appears.

DEADSTART DEVICE TYPE - 2

(1=66X, 2=63X/67X, 3=DISK)

CHANNEL - 13

EQUIPMENT - 0

UNIT - 00

(BS) BACK TO PREVIOUS ENTRY

CIP08A

Display I-4-10. Alternate Deadstart

Option

Description

Enter the device type then press the carriage return key. The system then prompts you for channel, equipment, and unit numbers.

Default values are provided for the device parameters. The values are those specified in the default parameter block. The default parameter block is defined through option D, define default device parameters.

After the device information is entered, press the carriage return key to deadstart from the alternate device.

NOTE

Alternate deadstart from operating system deadstart tapes is not supported for model 800 computer systems. To load the operating system from a tape file, select option T, operating system file on tape, from the Operator Intervention display.

- D Define and Display Default Device Parameters. Select this option to assign default values to the channel, equipment, and unit numbers of a CIP tape deadstart device, disk deadstart device, alternate disk deadstart device, tape dump (EDD) device, or printer dump device. Arbitrary default values are initially assigned to the device parameters when CIP is installed.
- L Display CIP Component Levels. Select this option to display the release levels of the CIP components: microcode, EI, SCD, DFT, and MDD, NOS/VE programs and the full or empty status of the deadstart error log (DEL). An asterisk identifies components that have been installed manually.
- I Initialize Mainframe. Select this option to initialize the mainframe after power interruption or maintenance activity. The Initial Options display reappears with the following message on the bottom of the display:

ALL MAINFRAME MEMORIES WILL
BE INITIALIZED FOR MSL/OS LOADS

Mainframe initialization, including initialization of central memory, PP memory, and maintenance registers, occurs when you select this option and either perform an operating system load on a level 0, 1, or 2 (not 3) deadstart or select off-line maintenance. Refer to part II, section 2 for procedures and additional information about this option.
- C Clear deadstart error log. Select this option to clear the data in the deadstart error log.
- F Clear central memory flaw table. Select this option to clear the data in the CM flaw table.
- H Clear mainframe reconfiguration table. Select this option to clear the mainframe reconfiguration table data stored on disk.

Option

Description

A Load the Monitor Display Driver. Select this option to execute MDD in a standalone mode (not concurrent with the operating system).

When you specify A, the MDD Parameters display, display I-4-11, appears.

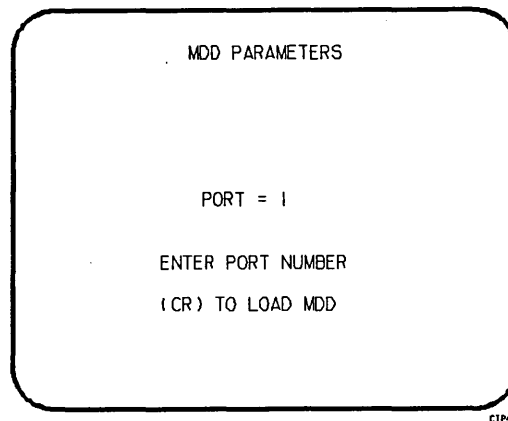

Display I-4-11. MDD Parameters

Enter the port number if different than the one displayed. Press the carriage return key to cause MDD to load. When you have finished using MDD, a deadstart is required. Refer to part III, section 1 for the uses of MDD.

This option is used to support the analysis of the state of a mainframe after encountering a system interrupt. It should only be selected after an operating system has been previously loaded. CTI loads MDD out of central memory (stored there on a system load) and issues the following message, if a checksum of the MDD program fails.

UNABLE TO LOAD MDD.

THE INTEGRITY OF CENTRAL MEMORY
HAS BEEN COMPROMISED.

DISPLAYS AND OPTIONS FOR DEADSTART FROM CIP TAPE

The CIP tape deadstart displays and options included in this subsection incorporate the following conventions:

- The default option on a menu display is the first option listed. The option can be selected automatically by pressing the carriage return key.
- Help information is provided for the Initial Options displays and the Build Deadstart Disk display. The Help displays supply brief information about the options. More detailed option information is given elsewhere in this section.
- Pressing the backspace key allows you to return to the previous display.

OVERVIEW

Figure I-4-2 provides an overview of the displays and options available during a deadstart from CIP tape on models 835 through 860.

INITIAL OPTIONS DISPLAY

The Initial Options display, display I-4-12, is the first screen that appears after deadstart is initiated. When the deadstart program is set for deadstart from the CIP tape, the Initial Options display provides utilities to install CIP to disk. A CIP tape deadstart also allows execution of several utilities from tape should the deadstart disk be unusable.

```
          INITIAL OPTIONS

          B   BUILD DEADSTART DISK
          U   UTILITIES
          M   OFF-LINE MAINTENANCE
          H   HELP

          (CR) BUILD DEADSTART DISK

          CONTROL DATA PROPRIETARY PRODUCT
          COPYRIGHT CONTROL DATA 1980.

          ppp-   VIII
          XXXX
```

CIP15

Display I-4-12. Initial Options From CIP Tape

<u>Option</u>	<u>Description</u>
(CR) or B	Build Deadstart Disk. This option allows you to install CIP to disk. The CIP modules must reside on the disk before an operating system deadstart can be performed. CIP modules are used to initialize the mainframe and establish the operating environment. Refer to CIP Installation earlier in this section.
U	Utilities. Select this option to: <ul style="list-style-type: none">• Perform an Express Deadstart Dump (dump memories and registers to tape).• Perform a printer dump.• Deadstart from a different device.• Define default device parameters.• Display CIP component levels.• Initialize the mainframe after power interruption or maintenance activity.• Load/install peripheral microcode.• Clear deadstart error log (DEL).

Option

Description

- Load the monitor display driver (MDD) in standalone mode.
- Clear the central memory flaw table.
- Clear the mainframe reconfiguration table (MRT).

M Off-Line Maintenance. This option is provided to enable the CE to execute hardware tests for preventive maintenance or hardware error diagnosis. Information about the option is included in the MSL 15X Reference Manual.

The contents of word 12 of the deadstart program also affect the M option. Refer to Setting Word 12 in part II, section 1.

Execution of the hardware diagnostics from tape is much slower than from disk. Use tape only when your deadstart disk is not usable.

H Help for Initial Options Selection.

The CIP level number, ppp- Vlll, is displayed at the bottom of the Initial Options display; ppp is mainframe type, and lll is CIP release level. At the very bottom of the display xxxx is the PSR level.

BUILD DEADSTART DISK DISPLAY

The Build Deadstart Disk display, display I-4-13, appears when you select option B, build deadstart disk, from the Initial Options display. The Build Deadstart Disk display is available only when you deadstart from the CIP tape. This display provides the options that install CIP to the deadstart disk. Turn to CIP Installation, earlier in this section, for CIP installation procedures and displays.

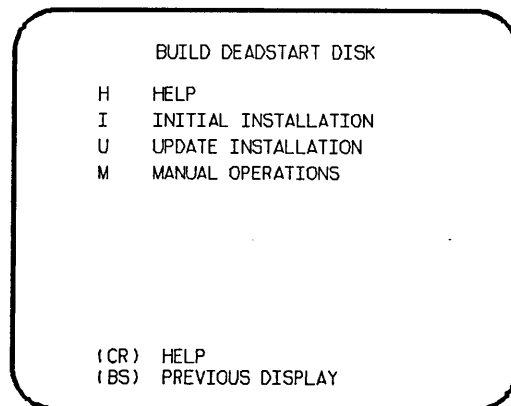

Display I-4-13. Build Deadstart Disk

<u>Option</u>	<u>Description</u>
(CR) or H	Help for Installation Option Selection.

CAUTION

The initial installation option destroys all information on the deadstart disk, except for the disk microcode, before installing CIP. Before executing the initial installation option, be sure you have a backup copy of any information on the deadstart disk that you want to preserve, including operating system permanent files and CE command buffers. After executing the initial installation option, you must perform an operating system initialization of the disk.

- I Initial Installation. Select this option to install CIP for the first time. The initial installation option initializes the deadstart disk and then installs CIP to the deadstart disk.
- U Update Installation. Select this option to replace CIP on the deadstart disk some time after the initial installation. The update option preserves operating system information on the deadstart disk.
- M Manual Operations. Select this option to perform emergency CIP component replacement at any time after CIP has been installed. Display I-4-14, the Manual Operations display, provides manual operation option selection.

MANUAL OPERATIONS DISPLAY

The Manual Operations display appears when you select option M, manual operations, from the Build Deadstart Disk display. Manual operations are available only when you deadstart from the CIP tape.

Manual operations provide manual installation of individual CIP components, which may be required in the event of a critical problem. Refer to Emergency CIP Repair Procedures - Model 800 Computer Systems in part II, section 2 for repair and manual installation procedures. More detailed information about the manual operations is provided in the MSL 15X Reference Manual.

MANUAL OPERATIONS

C REPLACE CTI
T REPLACE MSL
D REPLACE MICROCODE,
E1, SCD, MDD, DFT DPB
VE MODULES

(CR) REPLACE CTI
(BS) PREVIOUS DISPLAY

CIPROM

Display I-4-14. Manual Operations

<u>Option</u>	<u>Description</u>
(CR) or C	Replace CTI. Select this option to install the CTI component of CIP to the deadstart disk.

NOTE

This option provides the capability to release CTI-MSL/HIVS/OS disk space. For detailed procedures, refer to Build Deadstart Disk Operations in part II, section 2.

T	Replace MSL. Select this option to install the Maintenance Software Library component of CIP to the deadstart disk.
---	---

Option

Description

- D Replace microcode, EI, the CC634B System Console Driver (SCD), the Monitor Display Driver (MDD), Dedicated Fault Tolerance Module (DFT), Default Device Parameters (DPB) or NOS/VE boot modules.

NOTE

Select this option only after an initial install has been performed.

Select this option to replace microcode, EI, SCD, MDD, DFT, DPB, or the NOS/VE boot modules or to initialize the common disk area (CDA). When option D is selected, a prompt requests that you enter the disk channel and disk unit numbers. After you enter the channel and unit numbers or press the carriage return key to accept the default values shown, the CAU Initial Options display shown in display I-4-15 appears. Options A through G manually replace CIP modules on the deadstart disk.

Select option Y on the CAU Options display to display the level numbers of the microcode and EI modules resident on the deadstart disk. If any module has been manually replaced, an asterisk appears by the module name on this display.

REPLACE CTI/MSL DISK AREA MODULE

- A- DEFAULT PARAMETER DECK
- B- MICRO-CODE
- C- ENVIRONMENT INTERFACE
- D- SYSTEM CONSOLE DRIVER
- E- MONITOR DISPLAY DRIVER
- F- FAULT TOLERANCE MODULE (DFT)
- G- NOS/VE MODULES

- Y- DISPLAY CTI/MSL AREA CONTENTS
- Z- INITIALIZE COMMON DISK AREA

C1P22

Display I-4-15. CAU Initial Options

UTILITIES DISPLAY

Selecting the U option from the Initial Options display causes the Utilities display, display I-4-16, to appear.

UTILITIES	
E	EXPRESS DEADSTART DUMP
P	PRINTER DUMP
S	ALTERNATE DEADSTART DEVICE SELECTION
D	DEFINE AND DISPLAY DEFAULT DEVICE PARAMETERS
L	DISPLAY CIP COMPONENT INFORMATION
I	INITIALIZE MAINFRAME
M	DISK SUBSYSTEM MICROCODE LOAD
C	CLEAR DEADSTART ERROR LOG
F	CLEAR CM FLAW TABLE
H	CLEAR MAINFRAME RECONFIGURATION TABLE
A	LOAD MONITOR DISPLAY DRIVE
(CR)	EXPRESS DEADSTART DUMP
(BS)	PREVIOUS DISPLAY

CZP418

Display I-4-16. Utilities, Tape Deadstart

<u>Option</u>	<u>Description</u>
(CR) or E	Express Deadstart Dump (EDD). Select this option to dump to magnetic tape the contents of PP memories, central memory, unified extended memory, CPU hardware registers, maintenance registers, processor control store memories, and the tape and disk controlware. When the E option is selected, CTI checks the error status of all system elements and displays error messages for any errors before allowing the deadstart dump to continue. Refer to Performing an Express Deadstart Dump in part II, section 2 for procedures and further information.
P	Dump to Printer. Select this option to dump central memory, PP memory, or maintenance register contents to a line printer. The Dump to Printer Options display, display I-4-15, appears. You cannot return to the Utilities display from this display. You must redeadstart the system. When the P option is selected, CTI checks the error status of all system elements and displays error messages for any errors before allowing the deadstart dump to continue. Table I-4-4 shows the keyboard entries for performing a printer dump. Refer to Performing a Printer Dump in part II, section 2 for further information.

NOTE

When the E or P options are selected, CTI will check the error status of all the system elements. If errors are encountered, CTI will log the errors in the deadstart error log. If the deadstart error log is full, CTI will display the errors before allowing the deadstart to continue.

```

A - 512 PRINTER INITIALIZE
B - 580 PRINTER INITIALIZE
C - PP MEMORY DUMP
D - CM DUMP
G - REGISTER FILE DUMP
H - PP MEMORY DUMP IN HEX
I - CENTRAL MEMORY DUMP IN HEX
J - REGISTER FILE DUMP IN HEX
K - IOU REGISTER DUMP IN HEX
L - CM REGISTER DUMP IN HEX
M - CPU REGISTER DUMP IN HEX
N - PEM REGISTER DUMP IN HEX
O - CONTROL STORE DUMP IN HEX

Z - CHANNEL STATUS DUMP

```

CIPOTA

Display I-4-17. Dump to Printer Options

Table I-4-4. Keyboard Entries for a Printer Dump,
Models 835 through 860 (Sheet 1 of 2)

Entry	Function
A	512 Printer Initialize. This option initializes the 512 printer image with the data necessary to print with a 512-1 print train.
B	580 Printer Initialize. This option initializes the 580 printer buffer image and format buffer image memories.
C	PP Memory Dump. This option provides an octal dump to printer of 12-bit PP memories and 16-bit PP memories with their associated R registers.
D	CM Dump. This option provides an octal dump to printer of a selected area of central memory.
G	Register File Dump. This option provides an octal dump to printer of the CPU register file contents.
H	PP Memory Dump in Hexadecimal. This option provides a hexadecimal dump to the printer of the PP memories.
I	CM Dump in Hexadecimal. This option provides a hexadecimal dump to the printer of a selected area of central memory.
J	Register File Dump in Hexadecimal. This option provides a hexadecimal dump to the printer of the CPU register file contents.
K	IOU Register File Dump in Hexadecimal. This option provides a hexadecimal dump to the printer of the IOU maintenance register contents.
L	CM Register Dump in Hexadecimal. This option provides a hexadecimal dump to the printer of the contents of the central memory maintenance registers.

Table I-4-4. Keyboard Entries for a Printer Dump,
Models 835 through 860 (Sheet 2 of 2)

Entry	Function
M	<p>CPU Register Dump in Hexadecimal. This option provides a hexadecimal dump to the printer of the contents of the CPU maintenance registers. Respond to the message CPU NO = by entering the number of the CPU for which registers are to be dumped.</p> <p>If microcode is not executing, the program dumps only the hardware maintenance registers. In place of the software registers, the following message appears on the printer dump:</p> <p>MICROCODE HUNG</p>
N	<p>Control Store Dump in Hexadecimal. This option provides a hexadecimal dump to the printer of the contents of control store followed by a dump of shadow memory, if available. Respond to the message CPU NO = by entering the number of the CPU for which control store is to be dumped.</p>
O	<p>PEM Register Dump in Hexadecimal. This option provides hexadecimal dump of the contents of the PEM registers.</p>
Z	<p>Channel Status Dump. This option performs a dump of I4 I/O channel parity error disable, channel active, channel full, channel flag and channel error status flags for NIO channels 00 - 33B, and, if installed, CIO channels 00 - 11B. A "1" indicates the corresponding status flag is set, a "0" indicates the status flag is clear (I4 only).</p>

Option

Description

- S Alternate Deadstart. Select this option to specify an alternate CIP tape unit or disk device from which to deadstart. The Alternate Deadstart display, display I-4-18, appears.

```

DEADSTART DEVICE TYPE - 2
(1=66X, 2=63X/67X, 3=DISK)

CHANNEL - 13
EQUIPMENT - 0
UNIT - 00

(BS) BACK TO PREVIOUS ENTRY

```

Display I-4-18. Alternate Deadstart

Enter the device type then press the carriage return key. The system then prompts you for channel, equipment, and unit numbers.

Option

Description

Default values are provided for the device parameters. The values are those specified in the default parameter block. The default parameter block is defined through option D, define default device parameters.

After the device information is entered, press the carriage return key to deadstart from the alternate device.

NOTE

Alternate deadstart from operating system deadstart tapes is not supported for model 800 computer systems. To load the operating system from a tape file, select option T, operating system file on tape, from the Operator Intervention display.

- D Define and Display Default Device Parameters. Select this option to assign default values to the channel, equipment, and unit numbers of a CIP tape deadstart device, disk deadstart device, alternate disk deadstart device, tape dump (EDD) device, or printer dump device. Arbitrary default values are initially assigned to the device parameters when CIP is installed.
- L Display CIP Component Levels. Select this option to display the release levels of the CIP components: microcode, EI, SCD, DFT, NOS/VE programs, and MDD, and the full or empty status of the deadstart error log (DEL). An asterisk identifies components that have been installed manually.
- I Initialize Mainframe. Select this option to initialize the mainframe after power interruption or maintenance activity. The Initial Options display reappears with the following message on the bottom of the display:
- ALL MAINFRAME MEMORIES WILL
BE INITIALIZED FOR MSL/OS LOADS
- Mainframe initialization, including initialization of central memory, PP memory, and maintenance registers, occurs when you select this option and either perform an operating system load on a level 0, 1, or 2 (not 3) deadstart or select off-line maintenance. Refer to part II, section 2 for procedures and additional information about this option.
- M Disk Subsystem Microcode Load. Select this option to load peripheral microcode into the 834/836 disk adapter and control module memory and install peripheral microcode onto specified drives. Refer to Loading and Installing Disk Subsystem Microcode From CIP Tape in part II, section 2 for procedures and additional information about this option.
- C Clear deadstart error log (DEL). Select this option to clear the data in the deadstart error log.
- F Clear central memory flaw table. Select this option to clear the data in the CM flaw table.
- H Clear mainframe reconfiguration table (MRT). Select this option to clear the mainframe reconfiguration table data stored on disk.

Option

Description

A Load the Monitor Display Driver. Select this option to execute MDD in a standalone mode (not concurrent with the operating system).

When you specify A, the MDD Parameters display, display I-4-19, appears.

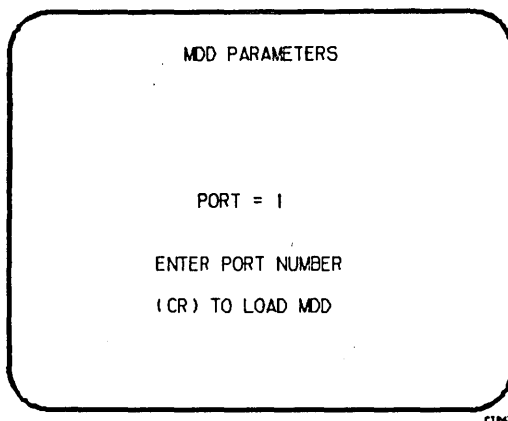

Display I-4-19. MDD Parameters

Enter the port number if different than the one displayed. Press the carriage return key to cause MDD to load. When you have finished using MDD, a deadstart is required. Refer to part III, section 1 for the uses of MDD.

This option is used to support the analysis of the state of a mainframe after encountering a system interrupt. It should only be selected after an operating system has been previously loaded. CTI loads MDD out of central memory (stored there on a system load) and issues the following message, if a checksum of the MDD program fails.

UNABLE TO LOAD MDD.

THE INTEGRITY OF CENTRAL MEMORY
HAS BEEN COMPROMISED.

CIP PROCEDURES, DISPLAYS, AND OPTIONS FOR CYBER 170 MODELS 865 AND 875 AND CYBER 170M MODEL 875

5

This section includes automatic CIP installation procedures, operating system deadstart procedures, and descriptions of CIP displays and options available to users of CYBER 170 models 865 and 875 and CYBER 170M model 875.

CIP INSTALLATION

The CIP modules must be installed to disk for models 865 and 875. Select a disk unit in your configuration to be the deadstart disk. The installation process installs the CIP modules to the deadstart disk so that operating system information may also reside on the disk.

Use the following procedure to install CIP to the disk or to update CIP on the deadstart disk. The installation procedure requires dedicated machine time. At least one tape drive and one disk unit must be available. The procedure assumes that controlware has been loaded into the peripheral controller(s). If the controlware is not loaded, refer to part II, section 1 for coldstart instruction.

1. Mount the CIP tape on a tape drive.
2. Set the deadstart program for a deadstart from the CIP tape. Refer to part II, section 1.
3. Press the deadstart button. The Initial Options display appears.
4. Press the carriage return key to select the default option, build deadstart disk. The Build Deadstart Disk display appears.

CAUTION

Do not proceed until you have read all the instructions for step 5.

5. For first time installation of the CIP tape select I, initial installation option, which initializes the deadstart disk and installs CIP. The initial installation option reserves 20 megabytes of disk storage for CIP.

NOTE

The initial installation option destroys all information on the deadstart disk, except the disk microcode, prior to installing CIP. Before executing the initial installation option, be sure you have a backup copy of any information on the deadstart disk that you want to preserve, including operating system permanent files and CE command buffers. After executing the initial installation option, you must perform an operating system initialization of the disk.

For installation of CIP some time after the initial installation, enter U to select the update option. The update option replaces CIP on the deadstart disk and preserves operating system information on the deadstart disk, including permanent files.

The CIP modules replaced during an Update are:

CTI
MSL (includes command buffers)

Information saved during an Update includes:

Default parameter block
Operating system pointers and permanent files

6. Enter the channel, equipment, and unit numbers of the deadstart disk when prompted. Follow each entry by pressing the carriage return key. Press only the carriage return key to select the displayed default value.
7. CIP installation is complete when the message INSTALLATION COMPLETE appears.

You can now perform an operating system load, off-line maintenance, default device parameter definition, or other deadstart utility operation. Refer to part II, section 2.

OPERATING SYSTEM DEADSTART

An operating system deadstart can be performed on models 865 and 875 only when CIP has been installed on disk. Procedures described next are for operating system deadstart when the deadstart program is set for deadstart from disk, which is known as disk deadstart. Operating system tape deadstart is not supported for model 800 computer systems. Operating system load from a tape file, however, is supported for model 800 computer systems through the disk deadstart process.

The operating system deadstart procedures require at least one disk unit and, when the operating system file is on tape, one tape unit. The procedures assume that controlware has been loaded into the peripheral controller(s). If the controlware is not loaded, refer to part II, section 1 for coldstart instruction.

DISK DEADSTART

This procedure assumes that:

- The deadstart program is set for deadstart from disk.
- CIP has been installed to disk. Refer to CIP Installation earlier in this section.

If the operating system file has also been installed to disk, a complete disk deadstart can be performed. Refer to the NOS 2 Analysis Handbook, INSTALL command, to find out how to install the NOS file to disk. The NOS/BE level 0 deadstart process automatically installs the NOS/BE file on disk for use on the following deadstarts.

Operating System File on Disk

1. Press the deadstart button to initiate deadstart. The Initial Options display appears.
2. Press the carriage return key to select the default option, automatic OS load. The automatic option assumes that the deadstart program is set correctly on the deadstart panel for deadstart level (0, 1, 2, 3) and for CMRDECK selection (NOS), or for CMR selection (NOS/BE).

If the deadstart program is set correctly, operating system deadstart is initiated.

3. If the deadstart program is not set correctly for these selections, enter 0 to select the operator intervention option. Operator intervention also allows reconfiguration of mainframe hardware components and execution of the hardware verification sequences. For specific information regarding operator intervention options, refer to Displays and Options for Deadstart From Disk later in this section.

Operating System File on Tape or Alternate Disk

1. Press the deadstart button to initiate deadstart. The Initial Options display appears.
2. Enter 0 to select the operator intervention option. The Operator Intervention display appears.
3. If the deadstart program is not set correctly for deadstart level and for CMRDECK selection (NOS) or CMR selection (NOS/BE), enter P to select the deadstart parameters option, before proceeding. Operator intervention also allows reconfiguration of the mainframe hardware components and execution of hardware verification sequences. For specific information regarding operator intervention options, refer to Displays and Options for Deadstart From Disk later in this section.
4. Enter S to select tape on alternate disk.
 - a. Tape Deadstart
 1. Enter T to deadstart using a tape.
 2. Enter tape type, channel, equipment, and unit when prompted.
 - b. Alternate Disk Deadstart
 1. Enter D to select alternate disk deadstart.
 2. Enter disk channel, equipment, and unit when prompted.
5. Press the carriage return key. Operating system deadstart is initiated.
6. You will see messages indicating that NOS or NOS/BE is loading programs or running tests.

DISPLAYS AND OPTIONS FOR DEADSTART FROM DISK

The CIP disk deadstart displays and options included in this subsection incorporate the following conventions:

- The default option on a menu display is the first option listed. The option can be selected automatically by pressing the carriage return key.
- Help information is provided for the Initial Options displays and the Build Deadstart Disk display. The Help displays supply brief information about the options. More detailed option information is given elsewhere in this section.
- Pressing the backspace key allows you to return to the previous display.

OVERVIEW

Figure I-5-1 provides an overview of the displays and options available during a deadstart from disk on models 865 and 875.

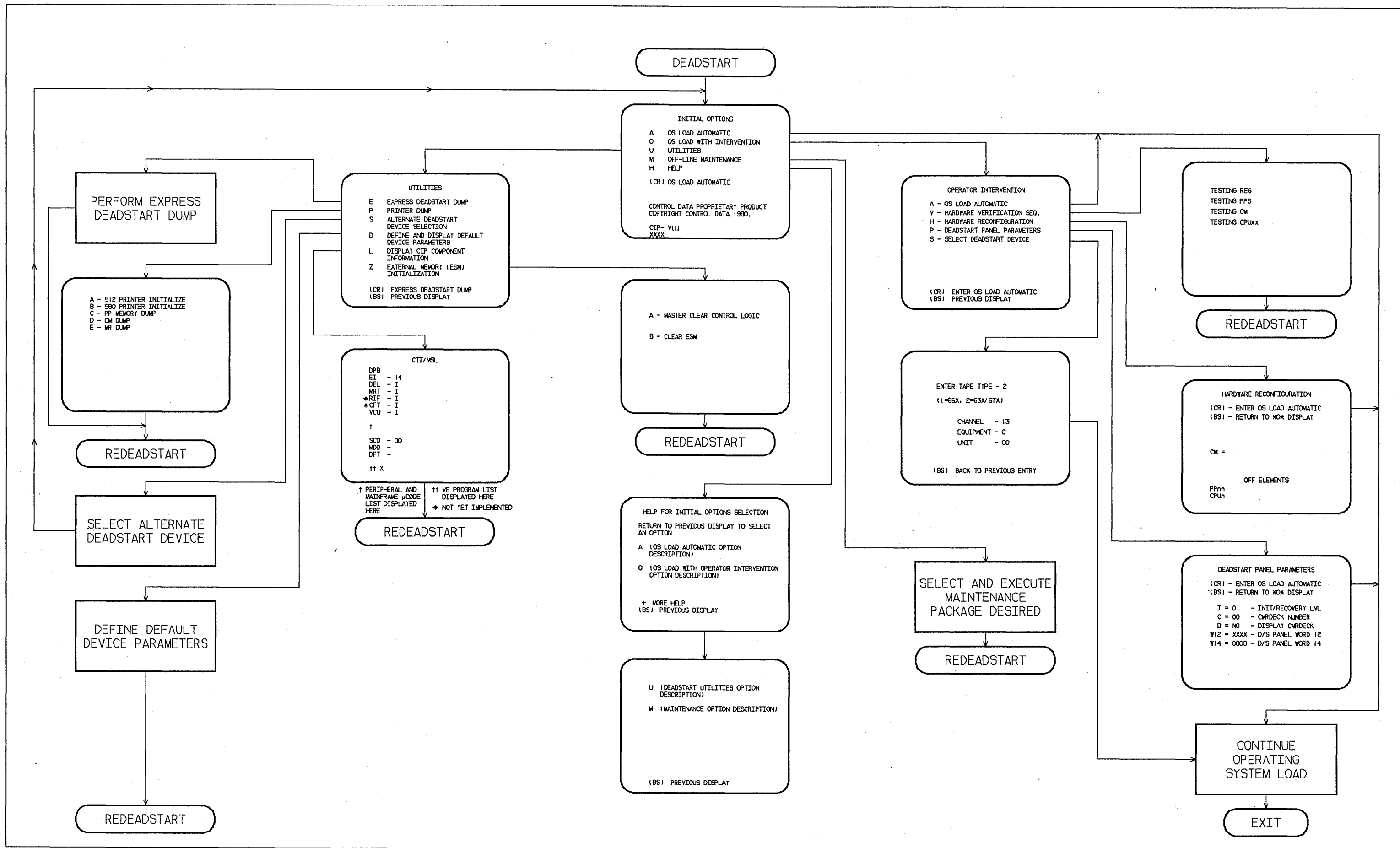
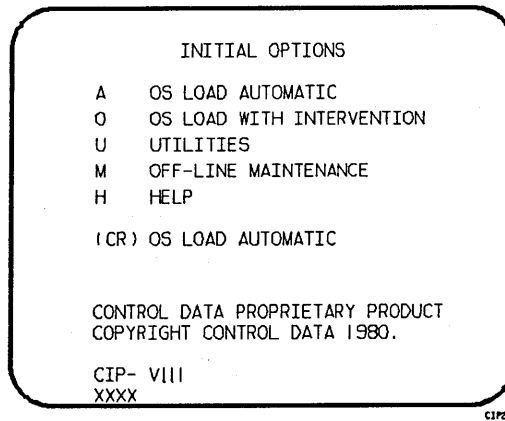

Figure I-5-1. Overview of Displays and Options for Deadstart
From Disk (Models 865 and 875)

INITIAL OPTIONS DISPLAY

The Initial Options display, display I-5-1, always appears first when a deadstart is initiated.

When the deadstart program is set for deadstart from disk, the Initial Options display provides operating system load, execution of off-line maintenance, and deadstart utilities.



Display I-5-1. Initial Options From Disk

Option

Description

(CR) or A OS Load Automatic. Select this option to load the operating system with no intervention on your part.

Before handoff is made to the operating system, confidence tests verify the ability of PP memory to hold simple data patterns and preset PP memory contents to all ones.

If the system detects a fatal error during confidence testing, the following information appears:

DEADSTART ABORTED - FATAL ERROR

```
MR-0-2      yyyy yyyy yyyy yyyy yyyy
MR-0-1      yyyy yyyy yyyy yyyy yyyy yyyy
MR-0-0      yyyy yyyy yyyy yyyy yyyy yyyy
```

yyyy is the contents of a word in the maintenance register, word 16 is the upper left word, and word 0 is the lower right word. A text explanation of the error appears below the register contents. Inform a CE.

Option

Description

O OS Load With Operator Intervention. Select this option to execute the hardware verification sequences, to reconfigure mainframe hardware components, or to change the operating system deadstart level or CMRDECK selection specified in the deadstart program. Refer to the Operator Intervention display, display I-5-2, later in this section for more information.

U Utilities. Select this option to:

- Perform an Express Deadstart Dump (dump memories and registers to tape).
- Perform a printer dump.
- Deadstart from a different device.
- Define default device parameters.
- Display CIP component information.
- Initialize external memory (ESM) after power interruption or maintenance activity.

Refer to the Utilities display, display I-5-6, later in this section for more information.

M Off-Line Maintenance. This option enables the CE to execute hardware tests for preventive maintenance or hardware error diagnosis. Information about the option is included in the MSL 140 Reference Manual. The contents of word 12 of the deadstart program also affect the M option. Refer to Setting Word 12 in part II, section 1.

H Help for Initial Option Selection.

The CIP version number, CIP- V111, is displayed at the bottom of the Initial Options display. At the bottom of the display, xxxx is the PSR level.

OPERATOR INTERVENTION DISPLAY

The Operator Intervention display, display I-5-2, appears when option 0, operator intervention, is selected at the Initial Options display.

OPERATOR INTERVENTION

A - OS LOAD AUTOMATIC
V - HARDWARE VERIFICATION SEQ.
H - HARDWARE RECONFIGURATION
P - DEADSTART PANEL PARAMETERS
S - SELECT DEADSTART DEVICE

(CR) ENTER OS LOAD AUTOMATIC
(BS) PREVIOUS DISPLAY

CIPOE

Display I-5-2. Operator Intervention

<u>Option</u>	<u>Description</u>
(CR) or A	OS Load Automatic. Select this option to perform an operating system load. Refer to the description of the OS load automatic option on the Initial Options display earlier in this section for more information.
V	Hardware Verification Sequence. Select this option to execute PP, CM, and CPU confidence tests. If you have selected either a level 0, 1, or 2 deadstart, central memory contents are changed when you execute this option. The V option cannot be executed if a level 3 deadstart is selected. You cannot test hardware that has been turned off via the hardware reconfiguration option. The names of the tests HIVS executes for the models 865 and 875 are CMC7, CT77, EJP, MY17, and PCX7. Appendix E includes a brief description of each test.

Option

Description

If an error condition occurs, one of the following messages appears:

ERROR PP xx
ERROR CM
ERROR CPU xx
ERROR EM
ERROR REG
MAINT.REG ERROR yyyy

xx indicates the PP, or CPU in error. Contact a CE.

yyyy indicates a maintenance register word 0 error. If the error is fatal, the system displays it on a subsequent deadstart. Contact a CE.

Upon successful test completion, the system displays:

TESTING COMPLETE--DEADSTART

Initiate deadstart after testing to ensure that the system is returned to initial deadstart condition prior to system loading or recovery.

- H Hardware Reconfiguration. Select this option to alter the mainframe hardware configuration. When selected, display I-5-3 appears.

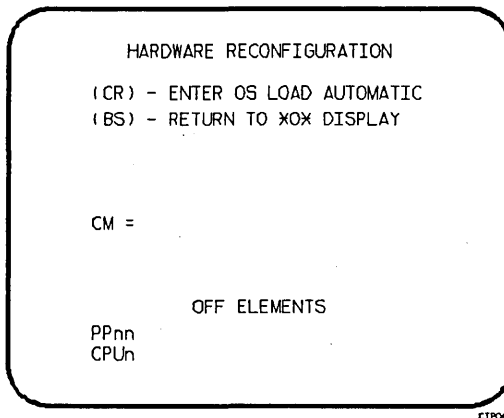

Display I-5-3. Hardware Reconfiguration

The default hardware configuration includes every hardware element available for use. To change the hardware configuration, enter the appropriate entry as described in table I-5-1. When you turn off an element, its identifier is added to the OFF ELEMENTS list on the display. Entries are in the form keyword=option.

Table I-5-1. Hardware Reconfiguration Entries, Models 865 and 875

Keyword	Option	Function																
CM=	nnnnnnn	<p>Specifies the size, in octal, of central memory in hundreds of words. The following examples show the value you enter for nnnnnnn, given the central memory size.</p> <table border="0" data-bbox="641 590 1088 829"> <tr> <td colspan="2" style="text-align: center;">Central Memory Size</td> </tr> <tr> <td style="text-align: center;">in 60-bit Decimal Words</td> <td style="text-align: center;">nnnnnnn</td> </tr> <tr> <td style="text-align: center;">98K</td> <td style="text-align: center;">3000</td> </tr> <tr> <td style="text-align: center;">262K</td> <td style="text-align: center;">10000</td> </tr> <tr> <td style="text-align: center;">524K</td> <td style="text-align: center;">20000</td> </tr> <tr> <td style="text-align: center;">1048K</td> <td style="text-align: center;">40000</td> </tr> <tr> <td style="text-align: center;">2097K</td> <td style="text-align: center;">100000</td> </tr> <tr> <td style="text-align: center;">4195K</td> <td style="text-align: center;">200000</td> </tr> </table> <p>If you enter CM=0 or do not enter the CM=nnnnnnn parameter, the system sets the maximum central memory size.</p> <p>If you specify a value for nnnnnnn that exceeds the amount of physical memory, the system sends the following message:</p> <p style="text-align: center;">UNAVAILABLE</p> <p>If you specify a central memory size that is not large enough for a system deadstart, the system sets the maximum central memory size and the following message appears:</p> <p style="text-align: center;">INVALID ENTRY</p>	Central Memory Size		in 60-bit Decimal Words	nnnnnnn	98K	3000	262K	10000	524K	20000	1048K	40000	2097K	100000	4195K	200000
Central Memory Size																		
in 60-bit Decimal Words	nnnnnnn																	
98K	3000																	
262K	10000																	
524K	20000																	
1048K	40000																	
2097K	100000																	
4195K	200000																	
CPU _n =	OFF/ON	<p>Specifies the logical status of each available CPU. Values for n can be 0 or 1.</p> <p>On a two-CPU system, at least one must be ON.</p> <p>If you enter CPU₀=OFF on a one-CPU system, the entry is a no-op; the system uses the CPU.</p>																
PP _{nn} =	OFF/ON	<p>Logically turn OFF/ON one or more peripheral processors. Acceptable values for nn are 3 through 11 (excluding 10) and, if you have them, 20 through 31. Ranges may be specified. For example, PP₅₋₇=OFF.</p>																
CEJ/MEJ=	OFF/ON	<p>Specifies logical status of CEJ/MEJ. NOS does not run with either CEJ/MEJ logically OFF or with the CEJ/MEJ deadstart panel switch set to DISABLE.</p>																

Option

Description

P Deadstart Panel Parameters. Select this option to change any of the following: the deadstart level, the CMRDECK, or deadstart program words 12 and 14. The Deadstart Parameters display, display I-5-4, appears.

Press the carriage return key to cause system deadstart processing to continue with no further intervention on your part. You cannot select additional options after this entry.

Press the backspace key to return to the Operator Intervention display.

Table I-5-2 shows the keyboard entries that you can make to change deadstart panel (program) parameters.

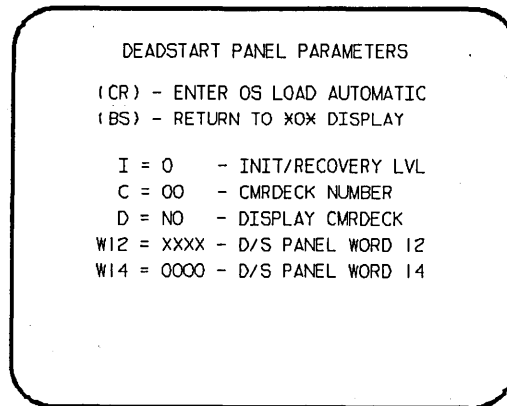

Display I-5-4. Deadstart Panel Parameters

Table I-5-2. Keyboard Entries for the Deadstart Panel Parameters Display, Models 865 and 875

Keyword	Function
I=x	Specifies the level of deadstart. The value of x can be 0, 1, 2, or 3.
C=xx	Specifies the CMRDECK (CMR, for NOS/BE) number. The value of xx can be any number from 0 to 77 octal. Refer to part II, section 1 for information about CMRDECK, CMR selection.
D=xxx	Entry is not used by NOS/BE. For NOS, specifies whether the CMRDECK is to be displayed. The value of xxx can be: YES for display CMRDECK. NO for do not display CMRDECK.
W12=xxxx	Specifies the value for deadstart program word 12. Consult a CE for information regarding use of this word.
W14=xxxx	Specifies the value for deadstart program word 14. Word 14 is reserved for the operating system or maintenance system.

<u>Option</u>	<u>Description</u>
S (NOS or NOS/BE)	Select Deadstart Device. Select this option to specify an alternate disk or a tape device as the OS Deadstart Device (display I-5-5). Press the carriage return key to cause system deadstart processing to continue with no further intervention on your part. You cannot select additional options after this entry. The CIP disk device is therefore the OS device. Press the backspace key to return to the Operator Intervention display.

<u>Entry</u>	<u>Description</u>
T	Tape OS Deadstart. Select this option for a tape OS deadstart rather than from disk. For NOS or NOS/BE deadstarts, the system prompts you for tape device type, channel, equipment, and unit.
D	Alternate Disk OS Deadstart. Select this option to choose an alternate disk device for the OS deadstart device. For NOS or NOS/BE deadstarts, the system prompts you for the disk channel, equipment, and unit.

SELECT OS DEADSTART DEVICE
(CR) - CONTINUE OS LOAD
(BS) - PREVIOUS DISPLAY
T - TAPE DEADSTART
D - ALTERNATE DISK DEADSTART

C1P42A

ENTER TAPE TYPE - 2
(1=66X, 2=63X/67X)

CHANNEL - 13
EQUIPMENT - 0
UNIT - 00

(BS) BACK TO PREVIOUS ENTRY

C1P13

OS DISK DEVICE LOCATION

CHANNEL - 01
EQUIPMENT - 0
UNIT - 00

(BS) BACK TO PREVIOUS ENTRY

C1P08B

Display I-5-5. Deadstart Device

UTILITIES DISPLAY

Selecting the U option from the Initial Options display causes the Utilities display, display I-5-6, to appear.

UTILITIES

E EXPRESS DEADSTART DUMP
P PRINTER DUMP
S ALTERNATE DEADSTART
DEVICE SELECTION
D DEFINE AND DISPLAY DEFAULT
DEVICE PARAMETERS
L DISPLAY CIP COMPONENT
INFORMATION
Z EXTERNAL MEMORY (ESM)
INITIALIZATION

(CR) EXPRESS DEADSTART DUMP
(BS) PREVIOUS DISPLAY

CIP25M

Display I-5-6. Utilities, Disk Deadstart

<u>Option</u>	<u>Description</u>
(CR) or E	Express Deadstart Dump (EDD). Select this option to dump to magnetic tape the contents of PP memories, central memory, unified extended memory, CPU hardware registers, maintenance registers, and the tape and disk controlware. When the E option is selected, CTI checks the error status of all system elements and displays error messages for any errors before allowing the deadstart dump to continue. Refer to Performing an Express Deadstart Dump in part II, section 2 for procedures and further information.
P	Dump to Printer. Select this option to dump central memory, PP memory, or maintenance register contents to a line printer. The Dump to Printer Options display, display I-5-7, appears. You cannot return to the Utilities display from this display. When the P option is selected, CTI checks the error status of all system elements and displays error messages for any errors before allowing the deadstart dump to continue. Table I-5-3 shows the keyboard entries for performing a printer dump. Refer to Performing a Printer Dump in part II, section 2 for procedures and further information.

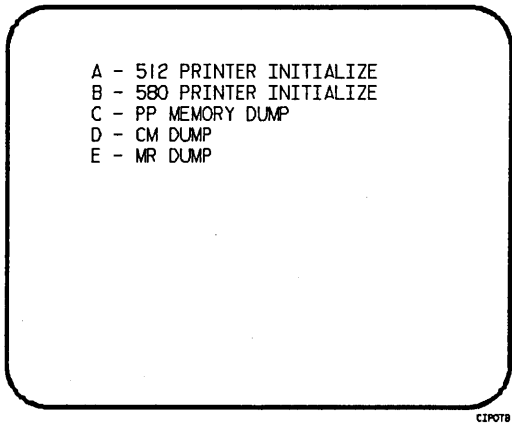

Display I-5-7. Dump to Printer Options

Table I-5-3. Keyboard Entries for a Printer Dump, Models 865 and 875

Entry	Function
A	512 Printer Initialize. This option initializes the 512 printer image with the data necessary to print with a 512-1 print train.
B	580 Printer Initialize. This option initializes the 580 printer buffer image and format buffer image memories.
C	PP Memory Dump. This option provides an octal dump to printer of 12-bit PP memories and 16-bit PP memories with their associated R registers.
D	CM Dump. This option provides an octal dump to printer of a selected area of central memory.
E	MR Dump. This option provides the ability to dump the contents of the maintenance register to the printer.

Option

Description

- S Alternate Deadstart. Select this option to specify an alternate CIP tape unit or disk device from which to deadstart. The Alternate Deadstart display, display I-5-8, appears.

```
DEADSTART DEVICE TYPE - 2
(1=66X, 2=63X/67X, 3=DISK)

CHANNEL - 13
EQUIPMENT - 0
UNIT - 00

(BS) BACK TO PREVIOUS ENTRY
```

CIP08A

Display I-5-8. Alternate Deadstart

Enter the device type then press the carriage return key. The system then prompts you for channel, equipment, and unit numbers.

Default values are provided for the device parameters. The values are those specified in the default parameters block. The default parameters block is defined through option D, define default device parameters.

After the device information is entered, press the carriage return key to deadstart from the alternate device.

NOTE

Alternate deadstart from OS deadstart tapes is not supported for model 800 computer systems. To load the operating system from a tape file, select option T, operating system file on tape, from the Operator Intervention display.

- D Define and Display Default Device Parameters. Select this option to assign default values to the channel, equipment, and unit numbers of a CIP tape deadstart device, disk deadstart device, alternate disk deadstart device, tape dump (EDD) device, or printer dump device. Default values are initially assigned to the device parameters when CIP is installed.

<u>Option</u>	<u>Description</u>
L	Display Release Levels of the CIP Components.
Z	Initialize External Memory (ESM). Select this option to execute the clear ESM utility, ZAP.

NOTE

This option should be performed after any power interruption or maintenance activity.

Refer to part II, section 2 for procedures and additional information about this option.

DISPLAYS AND OPTIONS FOR DEADSTART FROM CIP TAPE

The CIP tape deadstart displays and options included in this subsection incorporate the following conventions:

- The default option on a menu display is the first option listed. The option can be selected automatically by pressing the carriage return key.
- Help information is provided for the Initial Options displays and the Build Deadstart Disk display. The Help displays supply brief information about the options. More detailed option information is given elsewhere in this section.
- Pressing the backspace key allows you to return to the previous display.

OVERVIEW

Figure I-5-2 provides an overview of the displays and options available during a deadstart from CIP tape on models 865 and 875.

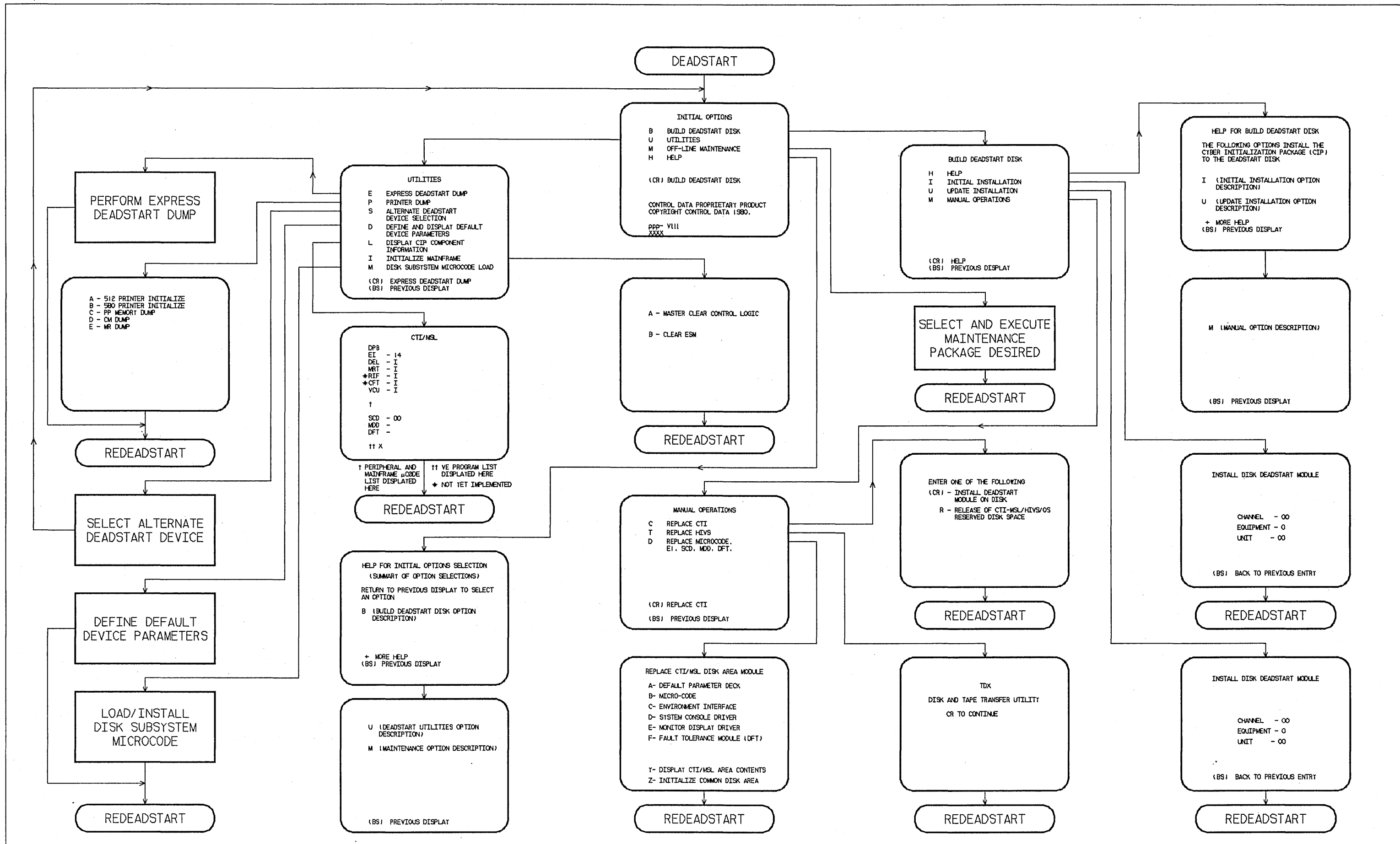
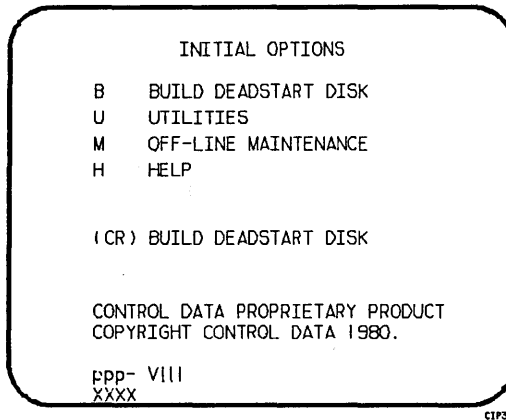

Figure I-5-2. Overview of Displays and Options for Deadstart From CIP Tape (Models 865 and 875)

INITIAL OPTIONS DISPLAY

The Initial Options display, display I-5-9, is the first screen that appears after you press the deadstart button. When you deadstart from the CIP tape, the Initial Options display provides utilities to install CIP to disk. A CIP tape deadstart also allows execution of several utilities from tape should the deadstart disk be unusable.



Display I-5-9. Initial Options From CIP Tape

<u>Option</u>	<u>Description</u>
(CR) or B	Build Deadstart Disk. This option allows you to install CIP to disk. CIP modules are used to initialize the mainframe and establish the operating environment. Refer to CIP Installation earlier in this section.
U	Utilities. Select this option to: <ul style="list-style-type: none">• Perform an Express Deadstart Dump (dump memories and registers to tape).• Perform a printer dump.• Deadstart from a different device.• Define default device parameters.• Display CIP component levels.• Initialize external memory (ESM) after power interruption or maintenance activity.• Load/install peripheral microcode.

Option

Description

M Off-Line Maintenance. This option is provided to enable the CE to execute hardware tests for preventive maintenance or hardware error diagnosis. Information about the option is included in the MSL 140 Reference Manual.

The contents of word 12 of the deadstart program also affect the M option. Refer to Setting Word 12 in part II, section 1 of this manual.

Execution of the hardware diagnostics from tape is much slower than from disk. Use tape only when your deadstart disk is not usable.

H Help for Initial Options Selection.

The CIP level number, ppp- Vlll, is displayed at the bottom of the Initial Options display. At the very bottom of the display, xxxx is the PSR level.

BUILD DEADSTART DISK DISPLAY

The Build Deadstart Disk display, display I-5-10, is presented on selection of option B, build deadstart disk, of the Initial Options display and is available only when you deadstart from the CIP tape. The Build Deadstart Disk display provides the options that install the CIP to the deadstart disk. Refer to CIP Installation, earlier in this section, for installation procedures and displays.

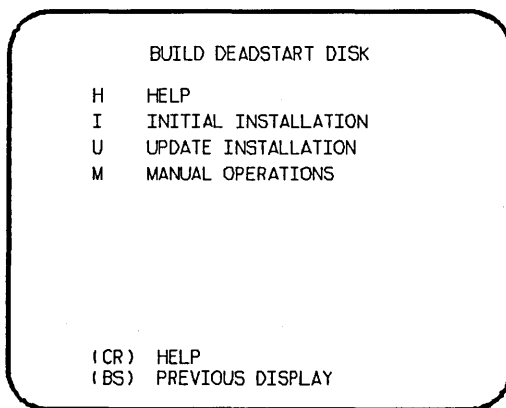

Display I-5-10. Build Deadstart Disk

<u>Option</u>	<u>Description</u>
(CR) or H	Help for Option Selection.

CAUTION

The initial installation option destroys all information on the deadstart disk except for the disk microcode before installing CIP. Before executing the initial installation option, be sure you have a backup copy of any information on the deadstart disk that you want to preserve, including operating system permanent files and CE command buffers. After executing the initial installation option, you must perform an operating system initialization of the disk.

- I Initial Installation. Select this option to install CIP for the first time. The initial installation option initializes the deadstart disk and then installs CIP to the deadstart disk.
- U Update Installation. Select this option to replace CIP on the deadstart disk some time after the initial installation. The update option preserves operating system information on the deadstart disk.
- M Manual Operations. Select this option only to perform emergency CIP component replacement. Display I-5-11, the Manual Operations display, provides manual operation option selection.

MANUAL OPERATIONS DISPLAY

The Manual Operations display appears when you select option M, manual operations, from the Build Deadstart Disk display. Manual operations are available only when you deadstart from the CIP tape.

Manual operations provide manual installation of individual CIP components, which may be required in the event of a critical problem. Refer to Emergency CIP Repair Procedures - Model 800 Computer Systems in part II, section 2 for repair and manual installation procedures. More detailed information about the manual operations is provided in the MSL 140 Reference Manual.

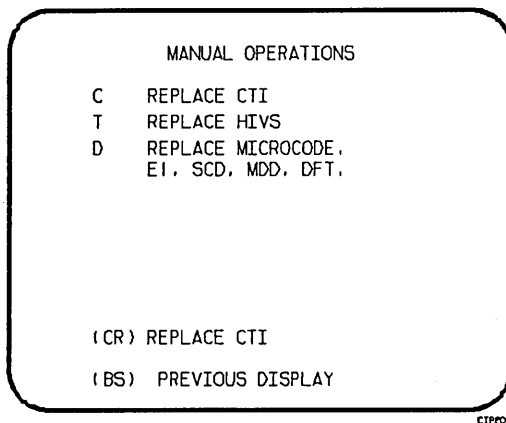

Display I-5-11. Manual Operations

<u>Option</u>	<u>Description</u>
(CR) or C	Replace CTI. Select this option to install the CTI component of CIP to the deadstart disk.

NOTE

This option provides the capability to release CTI-MSL/HIVS/OS disk space. For detailed procedures, refer to Build Deadstart Disk Operations in part II, section 2.

- T Replace MSL. Select this option to install the Maintenance Software Library component of CIP to the deadstart disk.
- D Replace Default Device Parameters.

Select the option to replace the default device parameters and peripheral microcode to the deadstart disk. Default device parameters are automatically installed when a CIP installation is performed. Refer to Utilities Display earlier in this section for information regarding default device parameter definition.

UTILITIES DISPLAY

Selecting the U option from the Initial Options display causes the Utilities display, display I-5-12, to appear.

```
          UTILITIES
E  EXPRESS DEADSTART DUMP
P  PRINTER DUMP
S  ALTERNATE DEADSTART
   DEVICE SELECTION
D  DEFINE AND DISPLAY DEFAULT
   DEVICE PARAMETERS
L  DISPLAY CIP COMPONENT
   INFORMATION
Z  EXTERNAL MEMORY (ESM)
   INITIALIZATION
M  DISK SUBSYSTEM MICROCODE LOAD
(CR) EXPRESS DEADSTART DUMP
(BS) PREVIOUS DISPLAY
```

CIP298

Display I-5-12. Utilities, Tape Deadstart

<u>Option</u>	<u>Description</u>
(CR) or E	Express Deadstart Dump (EDD). Select this option to dump to magnetic tape the contents of PP memories, central memory, unified extended memory, CPU hardware registers, maintenance registers, and the tape and disk controlware. When the E option is selected, CTI checks the error status of all system elements and displays error messages for any errors before allowing the deadstart dump to continue. Refer to Performing an Express Deadstart Dump in part II, section 2 for procedures and further information.
P	Dump to Printer. Select this option to dump central memory, PP memory, or maintenance register contents to a line printer. The Dump to Printer Options display, display I-5-13, appears. You cannot return to the Utilities display from this display. When the P option is selected, CTI checks the error status of all system elements and displays error messages for any errors before allowing the deadstart dump to continue. Table I-5-4 shows the keyboard entries for performing a printer dump. Refer to Performing a Printer Dump in part II, section 2 for procedures and further information.

```
A - 512 PRINTER INITIALIZE
B - 580 PRINTER INITIALIZE
C - PP MEMORY DUMP
D - CM DUMP
E - MR DUMP
```

CIP078

Display I-5-13. Dump to Printer Options

Table I-5-4. Keyboard Entries for a Printer Dump, Models 865 and 875

Entry	Function
A	512 Printer Initialize. This option initializes the 512 printer image with the data necessary to print with a 512-1 print train.
B	580 Printer Initialize. This option initializes the 580 printer buffer image and format buffer image memories.
C	PP Memory Dump. This option provides an octal dump to printer of 12-bit PP memories and 16-bit PP memories with their associated R registers.
D	CM Dump. This option provides an octal dump to printer of a selected area of central memory.
E	MR Dump. This option provides the ability to dump the contents of the maintenance register to the printer.

Option

Description

- S Alternate Deadstart. Select this option to specify an alternate CIP tape unit or disk device from which to deadstart. The Alternate Deadstart display, display I-5-14, appears.

```

DEADSTART DEVICE TYPE - 2
(1=66X, 2=63X/67X, 3=DISK)

CHANNEL - 13
EQUIPMENT - 0
UNIT - 00

(BS) BACK TO PREVIOUS ENTRY
    
```

CIP06A

Display I-5-14. Alternate Deadstart

Option

Description

Enter the device type then press the carriage return key. The system then prompts you for channel, equipment, and unit numbers.

Default values are provided for the device parameters. The values are those specified in the default parameters block. The default parameters block is defined through option D, define default device parameters.

After the device information is entered, press the carriage return key to deadstart from the alternate device.

NOTE

Alternate deadstart from OS deadstart tapes is not supported for model 800 computer systems. To load the operating system from a tape file, select option T, operating system file on tape, from the Operator Intervention display.

- D Define and Display Default Device Parameters. Select this option to assign default values to the channel, equipment, and unit numbers of a CIP tape deadstart device, disk deadstart device, alternate disk deadstart device, tape dump (EDD) device, or printer dump device. Default values are initially assigned to the device parameters when CIP is installed.
- L Display Release Levels of the CIP Components.
- Z Initialize External Memory (ESM). Select this option to execute the clear ESM utility, ZAP.

NOTE

This option should be performed after any power interruption or maintenance activity.

Refer to the clearing ESM procedure in part II, section 2 for procedures and additional information about this option.

- M Disk Subsystem Microcode Load. Select this option to load peripheral microcode into the 834/836 disk adapter and control module memory and install peripheral microcode onto specified drives. Refer to Loading and Installing Disk Subsystem Microcode From CIP Tape in part II, section 2 for procedures and additional information about this option.

CIP PROCEDURES, DISPLAYS, AND OPTIONS FOR NON-MODEL-800 COMPUTER SYSTEMS

6

This section includes automatic installation procedures, operating system deadstart procedures, and descriptions of CIP displays and options available to users of non-model-800 computer systems.

CIP INSTALLATION

CIP installation to disk is optional for initialization and deadstart of non-model-800 computer systems. Installation of the CIP to disk allows you to perform disk deadstarts.

For CIP installation to disk, select a disk unit in your configuration as the deadstart disk. Install or update CIP on the deadstart disk according to the following procedure.

The installation procedure requires dedicated machine time. At least one tape drive and one disk unit must be available. The procedure assumes that controlware has been loaded into the peripheral controller(s). If the controlware is not loaded, refer to part II, section 1 for coldstart instruction.

1. Mount the CIP tape on a tape drive.
2. Set the deadstart program for deadstart from the CIP tape. Refer to part II, section 1.
3. Press the deadstart button. The Initial Options display appears.
4. Press the carriage return key to select the default option, build deadstart disk. The Build Deadstart Disk display appears.

CAUTION

Do not proceed until you have read all the instructions for step 5.

5. For first-time installation of CIP tape, enter I to select the initial installation option, which initializes the deadstart disk and installs CIP. The initial installation option reserves 20 megabytes of disk storage for CIP.

NOTE

The initial installation option destroys all information on the deadstart disk except disk microcode prior to installing CIP. Before executing the initial installation option, be sure you have a backup copy of any information on the deadstart disk that you want to preserve, including operating system permanent files and CE command buffers. After executing the initial installation option, you must perform an operating system initialization of the disk.

For replacement of CIP some time after the initial installation, enter U to select the update option. The update option replaces CIP on the deadstart disk and preserves operating system information on the deadstart disk, including permanent files.

The CIP module replaced during an Update is:

CTI

Information saved during an Update includes:

Default parameter block
Operating system pointers and permanent files

6. Enter the channel, equipment, and unit numbers of the deadstart disk when prompted. Follow each entry by pressing the carriage return key. Press only the carriage return key to select the displayed default value.
7. CIP installation is complete when the message INSTALLATION COMPLETE appears.

You can now perform an operating system load, default device parameter definition, or other deadstart utility operation. Refer to part II, section 2.

OPERATING SYSTEM DEADSTART

An operating system deadstart can be performed when the deadstart file is on magnetic tape or on disk. Procedures included here are for operating system deadstart when the deadstart program is set for deadstart from disk, disk deadstart, and when the deadstart program is set for deadstart from tape, tape deadstart.

The operating system deadstart procedures require at least one disk unit and, when the operating system file is on tape, one tape unit. The procedures assume that controlware has been loaded into the peripheral controller(s). If the controlware is not loaded, refer to part II, section 1 for coldstart instructions.

Documentation follows for the two types of operating system deadstart:

- Disk Deadstart
- Operating System (OS) Tape Deadstart

DISK DEADSTART

This procedure assumes that:

- The deadstart program is set for deadstart from disk.
- CIP has been installed to disk. Refer to CIP Installation earlier in this section.

If the operating system file has also been installed to disk, a complete disk deadstart can be performed. Refer to the NOS 2 Analysis Handbook, INSTALL command, to find out how to install the NOS file to disk. The NOS/BE level 0 deadstart process automatically installs the NOS/BE file on disk for use on following deadstarts.

Operating System File on Disk

1. Press the deadstart button to initiate deadstart. The Initial Options display appears.
2. Press the carriage return key to select the default option, automatic OS load. The automatic option assumes that the deadstart program is set correctly on the deadstart panel for deadstart level (0, 1, 2, 3) and for CMRDECK selection (NOS) or for CMR selection (NOS/BE).

If the deadstart program is set correctly, operating system deadstart is initiated.

3. If the deadstart program is not set correctly for these selections, enter 0 to select the operator intervention option. Operator intervention also allows reconfiguration of mainframe hardware components and execution of the hardware verification sequences. For specific information regarding operator intervention options refer to Displays and Options for Deadstart From Disk or OS Tape later in this section.

Operating System File on Tape or Alternate Disk

1. Press the deadstart button to initiate deadstart. The Initial Options display appears.
2. Enter 0. The Operator Intervention display appears.
3. If the deadstart program is not set correctly for deadstart level and for CMRDECK selection (NOS) or CMR selection (NOS/BE), enter P to select the deadstart parameters option, before proceeding. Operator intervention also allows reconfiguration of the mainframe hardware components and execution of hardware verification sequences. For specific information regarding operator intervention options, refer to Displays and Options for Deadstart From Disk or OS Tape later in this section.
4. Enter S to select tape or alternate disk.
 - a. Tape Deadstart
 1. Enter T to deadstart using a tape.
 2. Enter tape type, channel, equipment, and unit when prompted.
 - b. Alternate Disk Deadstart
 1. Enter D to select alternate disk deadstart.
 2. Enter disk channel, equipment, and unit when prompted.
5. Press the carriage return key. Operating system deadstart is initiated.
6. You will see messages indicating that NOS or NOS/BE is loading programs and running tests.

OS TAPE DEADSTART

The deadstart program is set for deadstart from OS tape.

1. Mount operating system deadstart tape.
2. Press the deadstart button to initiate deadstart. The Initial Options display appears on the console screen.
3. Press the carriage return key to select the default option, automatic OS load.

The automatic option assumes that the deadstart panel is set correctly on the deadstart panel for deadstart level (0, 1, 2, 3) and for CMRDECK selection (NOS) or CMR selection (NOS/BE).

4. If the program is not set correctly for these selections, enter 0 to select the operator intervention option. Operator intervention also allows reconfiguration of mainframe hardware components. For specific information regarding Operator Intervention options, refer to Displays and Options for Deadstart From Disk or OS Tape, next.

DISPLAYS AND OPTIONS FOR DEADSTART FROM DISK OR OS TAPE

The deadstart displays and options included in this subsection are presented when a deadstart is initiated from a disk or from an OS tape. The displays incorporate the following conventions:

- The default option on a menu display is the first option listed. The option can be selected automatically by pressing the carriage return key.
- Help information is provided for the Initial Options displays and the Build Deadstart Disk display. The Help displays supply brief information about the options. More detailed option information is given elsewhere in this section.
- Pressing the backspace key allows you to return to the previous display.

OVERVIEW

Figure I-6-1 provides an overview of the displays and options available during a deadstart from disk or OS tape on non-model-800 computer systems.

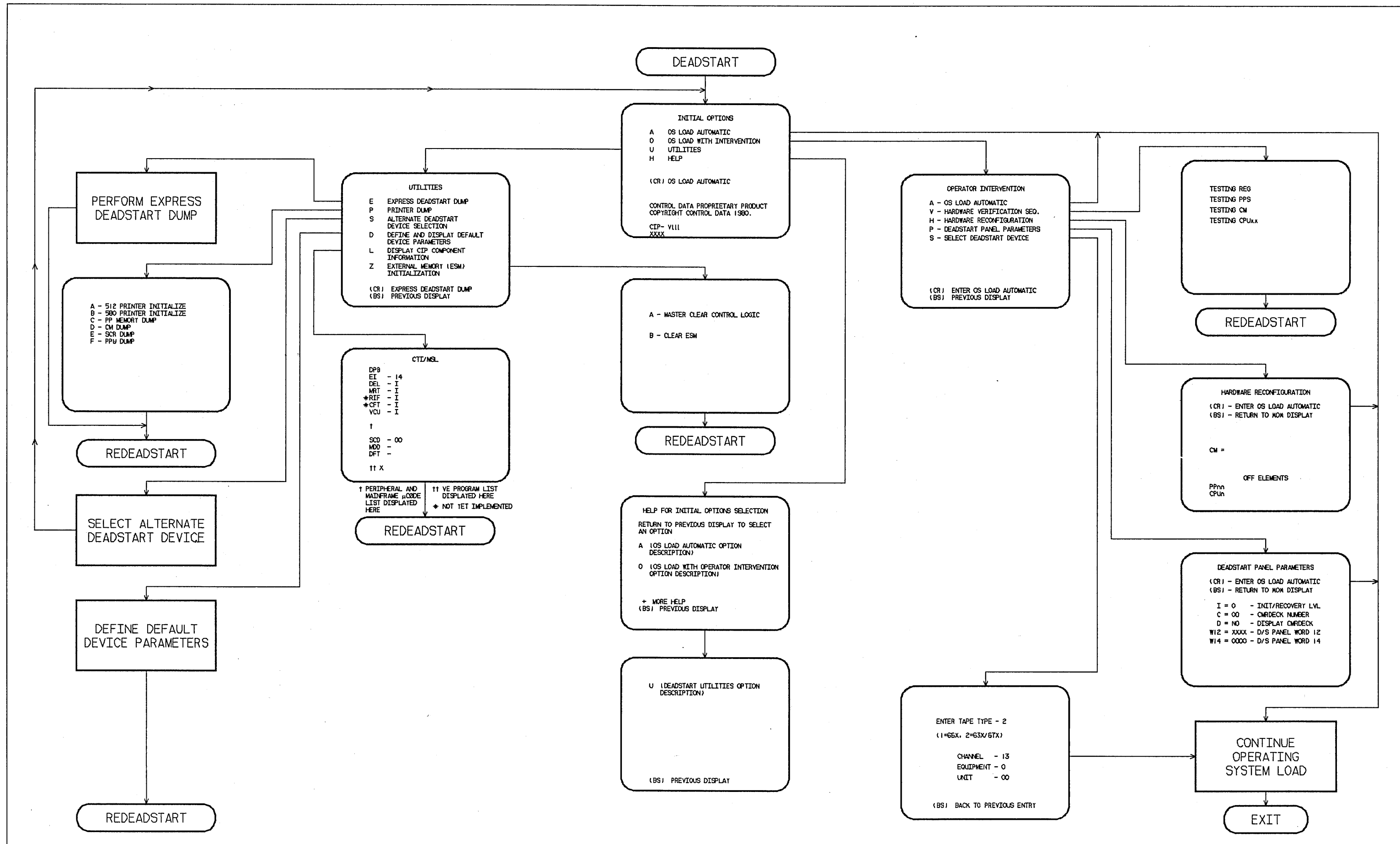

Figure I-6-1. Overview of Displays and Options for Deadstart
From Disk (Non-Model-800 Computer Systems)

INITIAL OPTIONS DISPLAY

The Initial Options display, display I-6-1, always appears first when a deadstart is initiated.

When the deadstart program is set for deadstart from disk or when the deadstart program is set for deadstart from the OS tape, the Initial Options display provides operating system load and deadstart utilities.

```
          INITIAL OPTIONS
A   OS LOAD AUTOMATIC
O   OS LOAD WITH INTERVENTION
U   UTILITIES
H   HELP

(CR) OS LOAD AUTOMATIC

CONTROL DATA PROPRIETARY PRODUCT
COPYRIGHT CONTROL DATA 1980.

CIP- VIII
XXXX
```

Display I-6-1. Initial Options From Disk or From OS Tape

<u>Option</u>	<u>Description</u>
(CR) or A	OS Load Automatic. Select this option to load the operating system with no intervention on your part. Before handoff is made to the operating system, memory confidence tests verify the ability of central memory and PP memory to hold simple data patterns, and then preset CM and PP memory contents to all ones. If the system detects a fatal error on a CYBER 170 mainframe during the confidence testing, the following information appears: DEADSTART ABORTED - FATAL ERROR SR-0-2 yyyy yyyy yyyy yyyy yyyy SR-0-1 yyyy yyyy yyyy yyyy yyyy yyyy SR-0-0 yyyy yyyy yyyy yyyy yyyy yyyy yyyy is the contents of a word in the SCR register; word 16 is the upper left word, and word 0 is the lower right word. A text explanation of the error appears below the register contents. Inform a CE.

<u>Option</u>	<u>Description</u>
0	OS Load With Operator Intervention. Select this option to execute the hardware verification sequences, to reconfigure mainframe hardware components, or to change the operating system deadstart level or CMRDECK selection specified in the deadstart program. Refer to the Operator Intervention display, display I-6-2, for more information.
U	Utilities. Select this option to: <ul style="list-style-type: none"> • Perform an Express Deadstart Dump (dump memories and registers to tape). • Perform a printer dump. • Deadstart from a different device. • Define default device parameters. • Display CIP component information. • Initialize external memory (ESM) after power interruption or maintenance activity.
H	Help for Initial Option Selection.

The CIP version number, CIP- V111, is displayed at the bottom of the Initial Options display. At the very bottom of the display, xxxx is the PSR level.

OPERATOR INTERVENTION DISPLAY

The Operator Intervention display, display I-6-2, appears when you select option 0, operator intervention, from the Initial Options display.

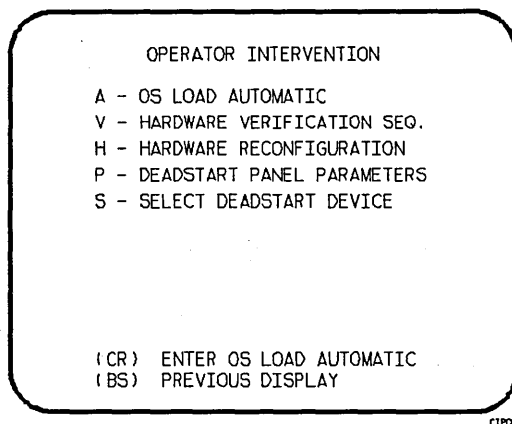

Display I-6-2. Operator Intervention

<u>Option</u>	<u>Description</u>
(CR) or A	OS Load Automatic. Select this option to perform an operating system load. Refer to the description of the OS Load Automatic option under Initial Options Display earlier in this section for more information.
V	Hardware Verification Sequence. Select this option to execute PP, CM, and CPU confidence tests.

If you have selected either a level 0, 1, or 2 deadstart, central memory contents are changed when you execute this option. The V option cannot be executed if a level 3 deadstart is selected.

You cannot test hardware that has been turned off via the hardware reconfiguration option.

The names of the tests used by HIVS are listed in table I-6-1. Appendix E provides a brief description of each test.

Upon successful test completion, the system displays:

TESTING COMPLETE-DEADSTART

Initiate deadstart after testing to ensure that the system is returned to initial deadstart condition prior to system loading or recovery.

Table I-6-1. HIVS Tests by Computer System

CYBER 70 Computer Systems	6000 Computer Systems, CYBER 170 Models 175, 740, 750, 760	CYBER 170 Models 171 through 174, 720, 730	CYBER 170 Model 176
CMC	CMC	CMC	BMEM
CT3	CT3	CT3	CMC
ECM	CT7	ECM	CT73
EJP	ECM	EJP	LCM4
IRT	EJP	MY1	PCX
MY1	MY1	PCX	SSMC
PCX	PCX		

Option

Description

H Hardware Reconfiguration. Select this option to alter the mainframe hardware configuration. When selected, display I-6-3 appears.

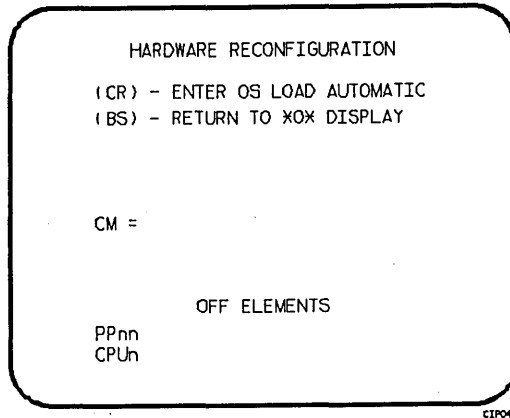

Display I-6-3. Hardware Reconfiguration

The default hardware configuration includes every hardware element available for use. To change the hardware configuration, enter the appropriate entry as described in table I-6-2. When you turn off an element, its identifier is added to the OFF ELEMENTS list on the display. Entries are in the form keyword=option.

Table I-6-2. Hardware Reconfiguration Entries, Non-Model-800 Computer Systems (Sheet 1 of 2)

Keyword	Option	Function
CM=	nnnnnnn	Specifies the size, in octal, of central memory in hundreds of words. The following examples show the value you enter for nnnnnnn, given the central memory size. Central Memory Size in 60-bit Decimal Words nnnnnnn 98K 3000 131K 4000 198K 6000 262K 10000

Table I-6-2. Hardware Reconfiguration Entries, Non-Model-800
Computer Systems (Sheet 2 of 2)

Keyword	Option	Function
		<p>If you enter CM=0 or do not enter the CM=nnnnnnn parameter, the system sets the maximum central memory size.</p> <p>If you specify a value for nnnnnnn that exceeds the amount of physical memory, the system sends the following message:</p> <p style="text-align: center;">UNAVAILABLE</p> <p>If you specify a central memory size that is not large enough for a system deadstart, the system sets the maximum central memory size and the following message appears:</p> <p style="text-align: center;">INVALID ENTRY</p>
CPUn=	OFF/ON	<p>Specifies the logical status of each available CPU. Values for n can be 0 or 1.</p> <p>On a two-CPU system, at least one must be ON.</p> <p>If you enter CPU0=OFF on a one-CPU system, the entry is a no-op; the system uses the CPU.</p>
PPnn=	OFF/ON	<p>Logically turn OFF/ON one or more peripheral processors. Acceptable values for nn are 3 through 11 (excluding 10) and, if you have them, 20 through 31. Ranges may be specified. For example, PP5-7=OFF.</p>
PPUnn=	OFF/ON	<p>Logically turn OFF/ON one or more of the model 176 first level peripheral processors (PPs). Acceptable values for nn are octal numbers 1 through 15. Ranges may be specified. For example, PPU 2-3=OFF.</p>
CEJ/MEJ=	OFF/ON	<p>Specifies logical status of CEJ/MEJ. NOS does not run with either CEJ/MEJ logically OFF or with the CEJ/MEJ deadstart panel switch set to DISABLE.</p>
CMU=	OFF/ON	<p>Specifies logical status of the compare/move unit hardware.</p>

Option

Description

P Deadstart Panel Parameters. Select this option to change any of the following: the deadstart level, the CMRDECK, or deadstart program words 12 and 14. The Deadstart Panel Parameters display, display I-6-4, appears.

Press the carriage return key if you want to cause system deadstart processing to continue with no further intervention on your part. You cannot select additional options after this entry.

Press the backspace key if you want to return to the Operator Intervention display.

Table I-6-3 shows the keyboard entries that you can make to change deadstart panel (program) parameters.

DEADSTART PANEL PARAMETERS

(CR) - ENTER OS LOAD AUTOMATIC
 (BS) - RETURN TO XOX DISPLAY

I = 0 - INIT/RECOVERY LVL
 C = 00 - CMRDECK NUMBER
 D = NO - DISPLAY CMRDECK
 W12 = XXXX - D/S PANEL WORD 12
 W14 = 0000 - D/S PANEL WORD 14

CZP05A

Display I-6-4. Deadstart Panel Parameters

Table I-6-3. Keyboard Entries for the Deadstart Panel Parameters Display,
 Non-Model-800 Computer Systems

Keyword	Function
I=x	Specifies the level of deadstart. The value of x can be 0, 1, 2, or 3.
C=xx	Specifies the CMRDECK (CMR, for NOS/BE) number. The value of xx can be 0 through 77 octal.
D=xxx	Refer to part II, section 1 for information about CMRDECK, CMR selection. Entry is not used by NOS/BE. For NOS, specifies whether the CMRDECK is to be displayed. The value of xxx can be: YES for display CMRDECK. NO for do not display CMRDECK.
W12=xxxx	Specifies the value for deadstart program word 12. Consult a CE for information regarding use of this word.
W14=xxxx	Specifies the value for deadstart program word 14. Word 14 is reserved for the operating system or maintenance system.

Option

Description

S
(NOS or
NOS/BE)

Select Deadstart Device. Select this option to specify an alternate disk or a tape device as the OS Deadstart Device (display I-6-5).

Press the carriage return key to cause system deadstart processing to continue with no further intervention on your part. You cannot select additional options after this entry. The CIP disk device is therefore the OS device.

Press the backspace key to return to the Operator Intervention display.

Entry

Description

- T Tape OS Deadstart. Select this option for a tape OS deadstart rather than from disk. For NOS or NOS/BE deadstarts the system prompts you for tape device type, channel, equipment and unit.

- D Alternate Disk OS Deadstart. Select this option to choose an alternate disk device for the OS deadstart device. For NOS or NOS/BE deadstarts, the system prompts you for the disk channel, equipment and unit.

SELECT OS DEADSTART DEVICE
(CR) - CONTINUE OS LOAD
(BS) - PREVIOUS DISPLAY
T - TAPE DEADSTART
D - ALTERNATE DISK DEADSTART

CIP42A

ENTER TAPE TYPE - 2
(1=66X, 2=63X/67X)

CHANNEL - 13
EQUIPMENT - 0
UNIT - 00

(BS) BACK TO PREVIOUS ENTRY

CIP13

OS DISK DEVICE LOCATION

CHANNEL - 01
EQUIPMENT - 0
UNIT - 00

(BS) BACK TO PREVIOUS ENTRY

CIP08B

Display I-6-5. Deadstart Device

UTILITIES DISPLAY

Selecting the U option from the Initial Options display causes the Utilities display, display I-6-6, to appear.

UTILITIES

E EXPRESS DEADSTART DUMP
P PRINTER DUMP
S ALTERNATE DEADSTART
DEVICE SELECTION
D DEFINE AND DISPLAY DEFAULT
DEVICE PARAMETERS
L DISPLAY CIP COMPONENT
INFORMATION
Z EXTERNAL MEMORY (ESM)
INITIALIZATION

(CR) EXPRESS DEADSTART DUMP
(BS) PREVIOUS DISPLAY

CTP25A

Display I-6-6. Utilities, Disk Deadstart

<u>Option</u>	<u>Description</u>
(CR) or E	Express Deadstart Dump (EDD). Select this option to dump to magnetic tape the contents of PP memories, central memory, hardware registers, and the tape and disk controlware. When the E option is selected, CTI checks the error status of all system elements and displays error messages for any errors before allowing the deadstart dump to continue. Refer to Performing an Express Deadstart Dump in part II, section 2 for procedures and further information.
P	Dump to Printer. Select this option to dump central memory, PP memory, or hardware register contents to a line printer. The Dump to Printer Options display, display I-6-7, appears. You cannot return to the Utilities display from this display. You must redeadstart the system. When the P option is selected, CTI checks the error status of all system elements and displays error messages for any errors before allowing the deadstart dump to continue. Table I-6-4 shows the keyboard entries for performing a printer dump. Refer to Performing a Printer Dump in part II, section 2 for procedures and further information.

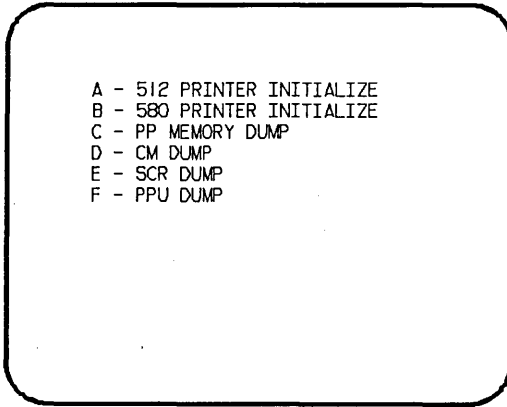

CIPSI

Display I-6-7. Dump to Printer Options

Table I-6-4. Keyboard Entries for a Printer Dump, Non-Model-800 Computer Systems

Entry	Function
A	512 Printer Initialize. This option initializes the 512 printer image with the data necessary to print with a 512-1 print train.
B	580 Printer Initialize. This option initializes the 580 printer buffer image and format buffer image memories.
C	PP Memory Dump. This option provides an octal dump to printer of 12-bit PP memories and 16-bit PP memories with their associated R registers.
D	CM Dump. This option provides an octal dump to printer of a selected area of central memory.
E	SCR Dump. This option provides the ability to dump the contents of the status control register to the printer.
F	PPU Memory Dump. This option provides an octal dump to printer of 12-bit PPU memories (CYBER 170 model 176 only).

Option

Description

S Alternate Deadstart. Select this option to specify an alternate tape unit or disk device from which to deadstart. The Alternate Deadstart display, display I-6-8, appears.

Enter the device type then press the carriage return key. The system then prompts you for channel, equipment, and unit numbers.

Default values are provided for the device parameters. The values are those specified in the default parameters block. The default parameters block is defined through option D, define default device parameters.

After the device information is entered, press the carriage return key to deadstart from the alternate device.

```
DEADSTART DEVICE TYPE - 2
(1=66X, 2=63X/67X, 3=DISK)

CHANNEL - 13
EQUIPMENT - 0
UNIT - 00

(BS) BACK TO PREVIOUS ENTRY
```

CIP08A

Display I-6-8. Alternate Deadstart

D Define and Display Default Device Parameters. Select this option to assign default values to the channel, equipment, and unit numbers of a tape deadstart device, disk deadstart device, alternate disk deadstart device, tape dump (EDD) device, or printer dump device. Default values are initially assigned to the device parameters when CIP is installed.

<u>Option</u>	<u>Description</u>
L	Display Release Levels of CIP Components.
Z	Initialize External Memory (ESM). Select this option to execute the clear ESM utility, ZAP.

NOTE

This option should be performed after any power interruption or maintenance activity.

Refer to part II, section 2 for procedures and additional information about this option.

DISPLAYS AND OPTIONS FOR DEADSTART FROM CIP TAPE

The displays and options included in this subsection are presented when a deadstart is initiated from a CIP tape. The displays incorporate the following conventions:

- The default option on a menu display is the first option listed. The option can be selected automatically by pressing the carriage return key.
- Help information is provided for the Initial Options displays and the Build Deadstart Disk display. The help displays supply brief information about the options. More detailed option information is given elsewhere in this section.
- Pressing the backspace key allows you to return to the previous display.

OVERVIEW

Figure I-6-2 provides an overview of the displays and options available during a deadstart from CIP tape on non-model-800 computer systems.

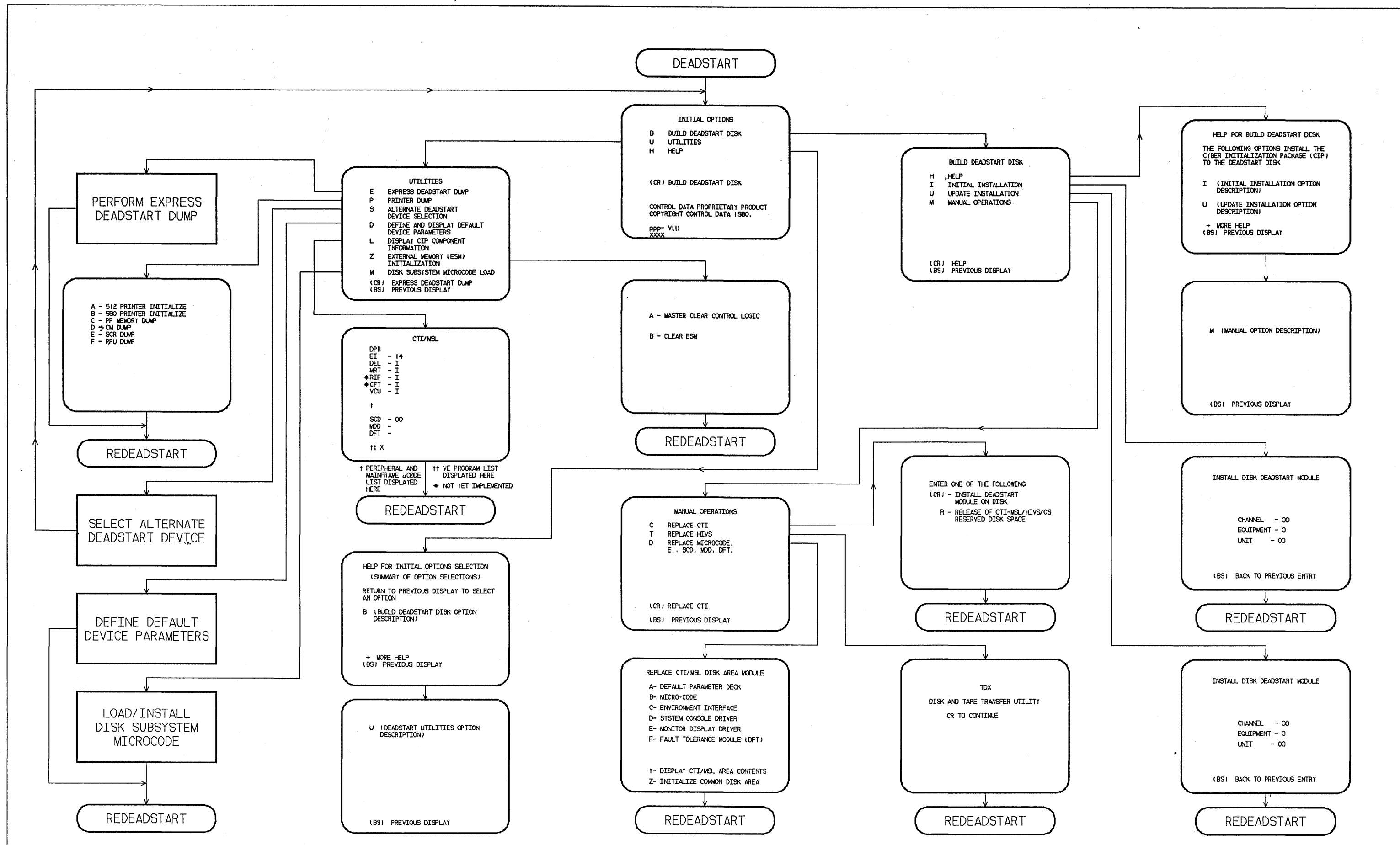
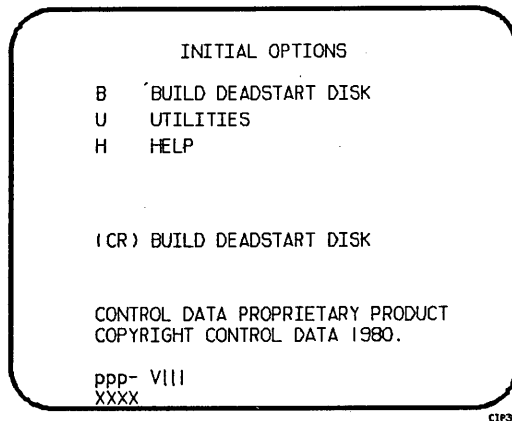

Figure I-6-2. Overview of Displays and Options for Deadstart From CIP Tape (Non-Model-800 Computer Systems)

INITIAL OPTIONS DISPLAY

The Initial Options display, display I-6-9, is the first screen that appears after deadstart is initiated. When the deadstart program is set for deadstart from the CIP tape, the Initial Options display provides utilities to install the CIP to disk. A CIP tape deadstart also allows execution of several utilities from tape should the deadstart disk be unusable.



Display I-6-9. Initial Options From CIP Tape

<u>Option</u>	<u>Description</u>
(CR) or B	Build Deadstart Disk. This option allows you to install the CIP to disk. CIP modules are used to initialize the mainframe and establish the operating environment. Refer to CIP Installation earlier in this section.
U	Utilities. Select this option to: <ul style="list-style-type: none">• Perform an Express Deadstart Dump (dump memories and registers to tape).• Perform a printer dump.• Deadstart from a different device.• Define default device parameters.• Display CIP component levels.• Initialize external memory (ESM) after power interruption or maintenance activity.• Load/install peripheral microcode.
H	Help for Initial Options Selection.

The CIP version number, ppp- Vlll, is displayed at the bottom of the Initial Options display. At the very bottom of the display, xxxx is the PSR level.

BUILD DEADSTART DISK DISPLAY

The Build Deadstart Disk display, display I-6-10, appears when you select option B, build deadstart disk, from the Initial Options display. The Build Deadstart Disk display is available only when you deadstart from the CIP tape. This display provides the options that install the CIP to the deadstart disk. Refer to CIP Installation earlier in this section for installation procedures and displays.

BUILD DEADSTART DISK

H HELP
I INITIAL INSTALLATION
U UPDATE INSTALLATION
M MANUAL OPERATIONS

^

(CR) HELP
(BS) PREVIOUS DISPLAY

C1926

Display I-6-10. Build Deadstart Disk

<u>Option</u>	<u>Description</u>
(CR) or H	Help for Option Selection.

CAUTION

The initial installation option destroys all information on the deadstart disk, except for the disk microcode, before installing CIP. Before executing the initial installation option, be sure you have a backup copy of any information on the deadstart disk that you want to preserve, including operating system permanent files. After executing the initial installation option you must perform an operating system initialization of the disk.

I	Initial Installation. Select this option to install CIP for the first time. The initial installation option initializes the deadstart disk and then installs CIP to the deadstart disk.
---	---

<u>Option</u>	<u>Description</u>
U	Update Installation. Select this option to replace CIP on the deadstart disk some time after the initial installation. The update option preserves operating system information on the deadstart disk.
M	Manual Operations. Select this option only to perform emergency CIP component replacement. The Manual Operations display, display I-6-11, provides manual operation option selection.

MANUAL OPERATIONS DISPLAY

The Manual Operations display appears when you select option M, manual operations, from the Build Deadstart Disk display. Manual operations are available only when you deadstart from the CIP tape.

Manual operations provide manual installation of individual CIP components, which may be required in the event of a critical problem.

MANUAL OPERATIONS

C REPLACE CTI
T REPLACE HIVS
D REPLACE MICROCODE,
EI, SCD, MDD, DFT.

(CR) REPLACE CTI
(BS) PREVIOUS DISPLAY

CIP008

Display I-6-11. Manual Operations

<u>Option</u>	<u>Description</u>
(CR) or C	Replace CTI. Select this option to replace the CTI component of CIP to the deadstart disk.

NOTE

This option provides the capability to release CTI-MSL/HIVS/OS disk space. For detailed procedures, refer to Build Deadstart Disk Operations in part II, section 2.

T	Replace HIVS. Select this option to replace the Hardware Initialization and Verification Software component of CIP to the deadstart disk.
---	---

<u>Option</u>	<u>Description</u>
D	Replace Default Device Parameters.

Select the option to replace the default device parameters and peripheral microcode to the deadstart disk. Default device parameters are automatically installed when a CIP installation is performed. Refer to Utilities Display earlier in this section for information regarding default device parameter definition.

UTILITIES DISPLAY

Selecting the U option from the Initial Options display causes the Utilities display, display I-6-12, to appear.

UTILITIES	
E	EXPRESS DEADSTART DUMP
P	PRINTER DUMP
S	ALTERNATE DEADSTART DEVICE SELECTION
D	DEFINE AND DISPLAY DEFAULT DEVICE PARAMETERS
L	DISPLAY CIP COMPONENT INFORMATION
Z	EXTERNAL MEMORY (ESM) INITIALIZATION
M	DISK SUBSYSTEM MICROCODE LOAD
(CR)	EXPRESS DEADSTART DUMP
(BS)	PREVIOUS DISPLAY

CIP99

Display I-6-12. Utilities, Tape Deadstart

<u>Option</u>	<u>Description</u>
(CR) or E	Express Deadstart Dump (EDD). Select this option to dump to magnetic tape the contents of PP memories, central memory, hardware registers, and the tape and disk controlware. When the E option is selected, CTI checks the error status of all system elements and displays error messages for any errors before allowing the deadstart dump to continue. Refer to Performing an Express Deadstart Dump in part II, section 2 for procedures and information.
P	Dump to Printer. Select this option to dump central memory, PP memory, or hardware register contents to a line printer. The Dump to Printer Options display, display I-6-13, appears. You cannot return to the Utilities display from this display. You must redeadstart the system. When the P option is selected, CTI checks the error status of all system elements and displays error messages for any errors before allowing the deadstart dump to continue. Table I-6-5 shows the keyboard entries for performing a printer dump. Refer to Performing a Printer Dump in part II, section 2 for procedures and further information.

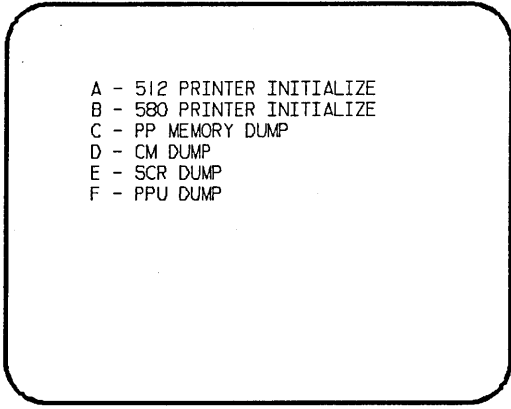

CI/PSI

Display I-6-13. Dump to Printer Options

Table I-6-5. Keyboard Entries for a Printer Dump, Non-Model-800 Computer Systems

Entry	Function
A	512 Printer Initialize. This option initializes the 512 printer image with the data necessary to print with a 512-1 print train.
B	580 Printer Initialize. This option initializes the 580 printer buffer image and format buffer image memories.
C	PP Memory Dump. This option provides an octal dump to printer of 12-bit PP memories and 16-bit PP memories with their associated R registers.
D	CM Dump. This option provides an octal dump to printer of a selected area of central memory.
E	SCR Dump. This option provides the ability to dump the contents of the status control register to the printer.
F	PPU Memory Dump. This option provides an octal dump to printer of 12-bit PPU memories (CYBER 170 model 176 only).

Option

Description

S Alternate Deadstart. Select this option to specify an alternate tape unit or disk device from which to deadstart. The Alternate Deadstart display, display I-6-14, appears.

Enter the device type then press the carriage return key. The system then prompts you for channel, equipment, and unit numbers.

Default values are provided for the device parameters. The values are those specified in the default parameters block. The default parameters block is defined through option D, define default device parameters.

After the device information is entered, press the carriage return key to deadstart from the alternate device.

```
DEADSTART DEVICE TYPE - 2
(1=66X, 2=63X/67X, 3=DISK)

CHANNEL - 13
EQUIPMENT - 0
UNIT - 00

(BS) BACK TO PREVIOUS ENTRY
```

CIP08A

Display I-6-14. Alternate Deadstart

D Define and Display Default Device Parameters. Select this option to assign default values to the channel, equipment, and unit numbers of a tape deadstart device, disk deadstart device, alternate disk deadstart device, tape dump (EDD) device, or printer dump device. Default values are initially assigned to the device parameters when CIP is installed.

L Display Release Levels of CIP Components.

Option

Description

Z Initialize External Memory (ESM). Select this option to execute the clear ESM utility, ZAP.

NOTE

This option should be performed after any power interruption or maintenance activity.

Refer to the clearing ESM procedure in part II, section 2 for procedures and additional information about this option.

M Disk Subsystem Microcode Load. Select this option to load peripheral microcode into the 834/836 disk adapter and control module memory and install peripheral microcode onto specified drives. Refer to Loading and Installing Disk Subsystem Microcode From CIP Tape in part II, section 2 for procedures and additional information about this option.

CIP PROCEDURES, DISPLAYS, AND OPTIONS FOR CYBER 180 MODEL 990

7

This section includes CIP automatic installation procedures, operating system deadstart procedures, and descriptions of CIP displays and options available to users of CYBER 180 model 990.

This section refers to the deadstart displays that are presented after deadstart is initiated. The initial deadstart display and use of the deadstart program are described in part II, section 1 of this handbook. Other displays referenced are described in part II, section 2 of this handbook.

CAUTION

For CYBER 170/180 systems using a NOS/VE version previous to 1.2.1, CIP should not be installed on a NOS/VE device. NOS/VE does not recognize CIP as a read-only disk area and will write over it.

CIP INSTALLATION

The CIP modules must be installed to disk for model 990. Select a disk unit in your configuration to be the deadstart disk. The installation process installs the CIP modules to the deadstart disk so that operating system information can also reside on the disk.

Complete the following procedure to initially install CIP to the deadstart disk or to update CIP on the deadstart disk. The installation procedure requires dedicated machine time. At least one tape drive and one disk unit must be available. The procedure assumes that controlware has been loaded into the peripheral controller(s). If the controlware is not loaded, refer to part II, section 1 of this handbook for coldstart instructions.

1. Mount the CIP tape on a tape drive.
2. Press the deadstart button on a CC545 to initiate deadstart from the tape. The Deadstart Options display appears.

If a CC634B with option GK427A is being used as the primary console (required for NOS/VE standalone), press deadstart button and go to step 3.

If a CDC CC634B is being used as the primary console, complete the following steps to bring up the Deadstart Options display:

- a. Press the RESET button to reinitialize the console.
 - b. Hold down the CTRL key while pressing the G key.
 - c. When the message *OPERATOR ACCESS ENABLED appears on the screen, hold down the CTRL key while pressing the R key.
3. Enter an S to select the short deadstart sequence if the deadstart program selected is for deadstart from CIP tape.

Otherwise, perform the following steps if the deadstart program selected is not for deadstart from CIP tape.

- a. Enter an M to select the Maintenance Options display.
- b. Enter or retrieve the deadstart from CIP tape program as described under Warmstart Procedure for Models 810, 815, 825, 830, and 990 in part II, section 1.
- c. Enter an S to select the short deadstart sequence.

NOTE

For model 990 mainframe sites with no maintenance contract, enter an I to initialize the disk and install CTI and HIVS. Although the CIP tape for such sites contains no off-line maintenance diagnostics, it must be installed to the deadstart disk.

4. Press the carriage return key to select the default option. The Build Deadstart Disk display appears.

CAUTION

Do not proceed until you have read all the instructions for step 5.

5. For first time installation of the CIP, enter either S, to select the short installation option, or enter F, to select the full installation option, based on the following information.

NOTE

The short and full installation options destroy all information on the deadstart disk, except for the disk microcode, prior to installing CIP. Before executing either the short or full installation option, be sure you have a backup copy of any information on the deadstart disk that you want to preserve, including operating system permanent files and CE command buffers.

After executing the short or full option, you must perform an operating system initialization of the disk.

- S The short installation option initializes the deadstart disk and then installs most of CIP. The CIP tape contains off-line maintenance diagnostics that the CE uses to execute mainframe tests for preventive maintenance or to diagnose a hardware error. The short option installs a predefined set of diagnostics (diagnostics that the CE uses frequently). Those used infrequently can be loaded and executed from the CIP tape when needed. The short installation option reserves 15 megabytes of disk storage for the CIP.
- F The full installation option initializes the deadstart disk and installs all of CIP. The full installation option reserves 25 megabytes of disk storage for CIP.

For reinstallation of CIP some time after the initial installation, enter U to select the update option.

- U The update option replaces CIP on the deadstart disk and preserves operating system information on the deadstart disk, including permanent files. The update option replaces CIP in the same mode, short or full, that was used when the deadstart disk was initialized.

The CIP modules replaced during an Update are:

- CTI
- EI
- MSL (includes command buffers)
- Microcode
- MDD
- SCD
- DFT
- NOS/VE Programs

Information saved during an Update includes:

- Deadstart error log (DEL)
- Default parameter block
- Operating system pointers and permanent files
- NOS/VE system file pointers
- Mainframe reconfiguration table (MRT)

6. Enter the channel, equipment, and unit numbers of the deadstart disk when prompted. Follow each entry by pressing the carriage return key. Press only the carriage return key to select the displayed default value.
7. CIP installation is complete when the message INSTALLATION COMPLETE appears.

You can now perform an operating system load, off-line maintenance, default deadstart device definition, or other deadstart utility operation. Refer to part II, section 2.

OPERATING SYSTEM DEADSTART

An operating system deadstart can be performed on model 990 only when CIP has been installed on disk. Procedures included here are for operating system deadstart when the deadstart program is set for deadstart from disk, which is known as disk deadstart. Operating system tape deadstart is not supported for model 990. Operating system load from a tape file, however, is supported for model 990 through the disk deadstart process.

The operating system deadstart procedures require at least one disk unit and, when the operating system file is on tape, one tape unit. The procedures assume that controlware has been loaded into the peripheral controller(s). If the controlware is not loaded, refer to part II, section 1 for coldstart instruction.

DISK DEADSTART

This procedure assumes that:

- The deadstart program shown as selected on the Deadstart Option display is set for deadstart from disk.
- CIP has been installed to disk. Refer to CIP Installation earlier in this section.

If the operating system file has also been installed to disk, a complete disk deadstart can be performed. Refer to the NOS 2 Analysis Handbook, INSTALL command, to find out how to install the NOS file to disk. The NOS/BE level 0 deadstart process automatically installs the NOS/BE file on disk for use on following deadstarts. For NOS/VE standalone refer to the NOS/VE Installation Reference Manual for procedures to install NOS/VE to disk.

Operating System File on Disk

1. Press the deadstart button on a CC545 display. The Deadstart Options display appears.

If a CC634B with option GK427A is being used as the primary console (required for NOS/VE standalone), press deadstart button and go to step 2.

If a CDC CC634B is being used as the primary console, complete the following steps to bring up the Deadstart Options display:

- a. Press the RESET button to reinitialize the console.
 - b. Hold down the CTRL key while pressing the G key.
 - c. When the message *OPERATOR ACCESS ENABLED appears on the screen, hold down the CTRL key while pressing the R key. The Deadstart Options display appears.
2. Enter S, then press the carriage return key. The Initial Options display appears.
 3. Press the carriage return key to select the default option, automatic OS load. This option assumes that the deadstart program is set correctly for deadstart level (0, 1, 2, 3) and for CMRDECK selection (NOS), or for CMR selection (NOS/BE), or for DCFILE selection (NOS/VE).

If the deadstart program is set correctly, operating system deadstart is initiated.

4. If the deadstart program is not set correctly for these selections, enter 0 to select the operator intervention option. Operator intervention also allows reconfiguration of mainframe hardware components and execution of the hardware verification sequences. For specific information regarding operator intervention options, turn to Displays and Options for Deadstart From Disk later in this section.

Operating System File on Tape or Alternate Disk

1. Press the deadstart button on a CC545 console. The Deadstart Options display appears.

If a CC634B is being used as the primary console, complete the following steps to bring up the Deadstart Options display:

- a. Press the RESET button to reinitialize the console.
 - b. Hold down the CTRL key while pressing the G key.
 - c. When the message *OPERATOR ACCESS ENABLED appears on the screen, hold down the CTRL key while pressing the R key.
2. Enter S or press the carriage return key. The Initial Options display appears.
 3. Enter 0 to select the operator intervention option. The Operator Intervention display appears.
 4. If the deadstart program is not set correctly for deadstart level and for CMRDECK selection (NOS), CMR selection (NOS/BE), or DCFILE selection (NOS/VE), enter P to select the deadstart parameters option, before proceeding. Operator intervention also allows reconfiguration of the mainframe hardware components and execution of hardware verification sequences. For specific information regarding operator intervention options, refer to Displays and Options for Deadstart From Disk, next.
 5. Enter S to select tape or alternate disk deadstart.
 - a. Tape Deadstart
 1. Enter T to deadstart using a tape.
 2. Enter tape type, channel, equipment, and unit when prompted.†
 - b. Alternate Disk Deadstart
 1. Enter D to select alternate disk deadstart.
 2. Enter disk channel, equipment, and unit when prompted.†
 6. Enter tape type, channel, equipment, and unit when prompted.
 7. Press the carriage return key. Operating System deadstart is initiated.†
 8. You will see messages showing that NOS or NOS/BE is loading programs and running tests.

† Applicable for NOS and NOS/BE deadstarts only. For NOS/VE deadstarts, the operating System deadstart sequence is initiated upon selecting the D or T option. (Reference the NOS/VE Operations Manual for more information on NOS/VE Deadstarts.)

DISPLAYS AND OPTIONS FOR DEADSTART FROM DISK

The CIP disk deadstart displays and options included in this section incorporate the following conventions:

- The default option on a menu display is the first option listed. The option can be selected automatically by pressing the carriage return key.
- Help information is provided for the Initial Options displays and the Build Deadstart Disk display. The Help displays supply brief information about the options. More detailed option information is given elsewhere in this section.
- Pressing the backspace key allows you to return to the previous display.

OVERVIEW

Figure I-7-1 provides an overview of the displays and options available during a deadstart from disk on model 990.



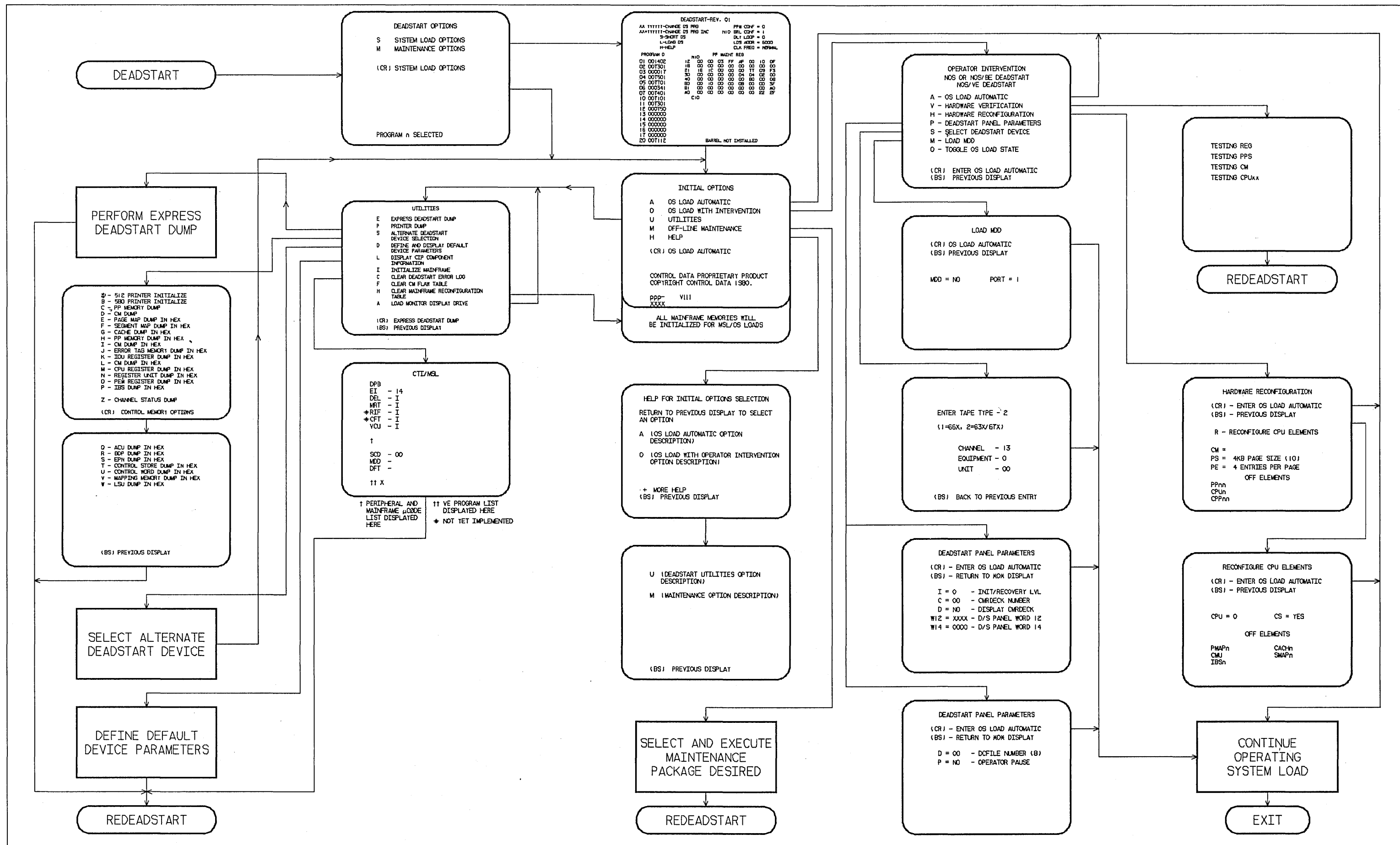
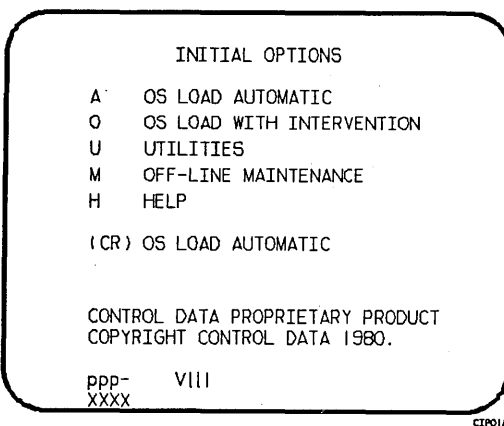

Figure I-7-1. Overview of Displays and Options for Deadstart From Disk (Model 990)

INITIAL OPTIONS DISPLAY

The Initial Options display, display I-7-1, is the first screen that appears after deadstart is initiated.

The Initial Options display provides operating system load, execution of off-line maintenance, and deadstart utilities when the deadstart program is set for deadstart from disk.



Display I-7-1. Initial Options From Disk

<u>Option</u>	<u>Description</u>
(CR) or A	<p>OS Load Automatic. The system initialization software assumes that CIP has been installed to the deadstart disk. The system loads modules from the deadstart disk into memory and the central processor to establish the operating environment. Then, confidence tests verify the ability of PP memory to hold simple data patterns and preset PP memory contents to all ones.</p> <p>If the system detects a fatal error during confidence testing, CTI records the errors in the deadstart error log (DEL), if it is empty, for later processing by the operating system. The following information appears on the left screen.</p>

DEADSTART ABORTED - FATAL ERROR

```

eeee-nn  rrrr      =cc cc cc cc cc cc cc cc
          rrrr      =cc cc cc cc cc cc cc cc
          rrrr      =cc cc cc cc cc cc cc cc
  
```

DEADSTART ABORTED - FATAL ERROR

```

eeee-nn  rrrr      =cc cc cc cc cc cc cc cc
          rrrr      =cc cc cc cc cc cc cc cc
          rrrr      =cc cc cc cc cc cc cc cc
  
```

<u>Notation</u>	<u>Description</u>								
eeee-nn	Name and logical number of the hardware that has the error.								
	<table border="0" style="margin-left: 40px;"> <thead> <tr> <th style="text-align: left;"><u>Name</u></th> <th style="text-align: left;"><u>Hardware</u></th> </tr> </thead> <tbody> <tr> <td>IOU-00</td> <td>Input/output unit.</td> </tr> <tr> <td>MEM-00</td> <td>Central memory.</td> </tr> <tr> <td>PROC-On</td> <td>Central processing unit. n=logical number.</td> </tr> </tbody> </table>	<u>Name</u>	<u>Hardware</u>	IOU-00	Input/output unit.	MEM-00	Central memory.	PROC-On	Central processing unit. n=logical number.
<u>Name</u>	<u>Hardware</u>								
IOU-00	Input/output unit.								
MEM-00	Central memory.								
PROC-On	Central processing unit. n=logical number.								
rrrr	Register name.								
cc	Register content in hexadecimal notation.								

Inform a CE when a fatal error occurs.

The ENTER DATE and ENTER TIME prompts are displayed on the models 835 through 860 systems only under the following conditions.

I2 IOU systems:

The operator has selected mainframe initialization and either:

- a. NOS/VE load, or
- b. The operating system being loaded supports CTI as primary source of current date and time.

I4 IOU systems:

The Two Port Mux wall clock data is invalid and either a or b above is true.

NOTE

The smallest unit of time that can be written to the Two Port Mux is minutes. If clock accuracy to within 1 second is desired, the operator should enter the desired seconds. However, this causes CTI to delay to the next minute before writing the clock and continuing the deadstart. Example: If the operator enters a time of 08:15:05, CTI delays for 55 seconds, and writes the clock with a time of 08:16:00. The informative message Updating Clock is added to the display during the delay.

If clock accuracy to within 1 minute is sufficient, the operator can enter 00 seconds and CTI writes the clock without delaying the deadstart.

Anytime the time entry is hh hours, 59 minutes, ss seconds, CTI writes the clock as hh:59:00. Example: If the operator enters 14:59:59, CTI writes the clock as 14:59:00.

<u>Option</u>	<u>Description</u>
0	OS Load With Operator Intervention. Select this option to execute the hardware verification sequences, to reconfigure mainframe hardware components, or to change the operating system deadstart level or CMRDECK selection specified in the deadstart program. Refer to the Operator Intervention display, display I-7-2, later in this section for more information.
U	Utilities. Select this option to: <ul style="list-style-type: none">• Perform an Express Deadstart Dump (dump memories and registers to tape).• Perform a printer dump.• Deadstart from a different device.• Define default device parameters.• Display CIP component levels.• Initialize the mainframe after power interruption or maintenance activity.• Clear deadstart error (DEL).• Load the monitor display driver (MDD) in NOS/VE standalone mode.• Clear the central memory flaw table.• Clear the mainframe reconfiguration table (MRT).

Option

Description

- Refer to the Utilities display, display I-7-8, later in this section for more information.
- M Off-Line Maintenance. This option enables the CE to execute hardware tests for preventive maintenance or hardware error diagnosis. Information about the option is included in the MSL 15X Reference Manual.
- The contents of word 12 of the deadstart program also affect the M option. Refer to Setting Word 12 in part II, section 1 of this manual.
- H Help for Initial Option Selection.
- When the CC634B console is being used, press H or the HELP key for a description of the initial options.

The CIP version number, ppp- Vlll, is displayed at the bottom of the Initial Options display: ppp is mainframe type and lll is the CIP release level. At the very bottom of the display, xxxx is the PSR level.

OPERATOR INTERVENTION DISPLAY

The Operator Intervention display, display I-7-2, appears when you select option 0, operator intervention, from the Initial Options display.

```

OPERATOR INTERVENTION
NOS OR NOS/BE DEADSTART

A - OS LOAD AUTOMATIC
V - HARDWARE VERIFICATION
H - HARDWARE RECONFIGURATION
P - DEADSTART PANEL PARAMETERS
S - SELECT DEADSTART DEVICE
M - LOAD MDD
O - TOGGLE OS LOAD STATE

(CR) ENTER OS LOAD AUTOMATIC
(BS) PREVIOUS DISPLAY
    
```

CIP33C

```

OPERATOR INTERVENTION
NOS/VE DEADSTART

A - OS LOAD AUTOMATIC
V - HARDWARE VERIFICATION
H - HARDWARE RECONFIGURATION
P - DEADSTART PANEL PARAMETERS
S - SELECT DEADSTART DEVICE
M - LOAD MDD
O - TOGGLE OS LOAD STATE

(CR) ENTER OS LOAD AUTOMATIC
(BS) PREVIOUS DISPLAY
    
```

CIP33B

Display I-7-2. Operator Intervention

<u>Option</u>	<u>Description</u>
(CR) or A	OS Load Automatic. Select this option to perform an operating system load. Refer to the description of the OS Load Automatic option on the Initial Options display, display I-7-1, earlier in this section for more information.
V	Hardware Verification Sequence. Select this option to execute PP, CM, and CPU confidence tests.
	If you have selected either a level 0, 1, or 2 deadstart, central memory contents are changed when you execute this option. The V option cannot be executed if a level 3 deadstart is selected.
	You cannot test hardware that has been turned off via option H, Hardware Reconfiguration.
	The names of the tests used by HIVS for the model 990 are CMC, CT8, EJP, and MY1. Appendix E includes a brief description of each test.
	If an error condition occurs, one of the following messages appears.
	<pre> ERROR PP xx ERROR CM ERROR CPU xx ERROR REG </pre>
	xx indicates the PP or CPU in error. Inform a CE.
	Upon successful test completion, the system displays:
	<pre> TESTING COMPLETE-DEADSTART </pre>
	Initiate deadstart after testing to ensure that the system is returned to initial deadstart condition prior to system loading or recovery.

Option

Description

H Hardware Reconfiguration. Select this option to alter the mainframe hardware configuration. When selected, display I-7-3 appears:

```

      HARDWARE RECONFIGURATION
      (CR) - ENTER OS LOAD AUTOMATIC
      (BS) - PREVIOUS DISPLAY

      R - RECONFIGURE CPU ELEMENTS

      CM = †
      PS = 4KB PAGE SIZE (10)
      PE = 4 ENTRIES PER PAGE
              OFF ELEMENTS
      PPnn
      CPUn
      CPPnn

```

CIP40C

†IF NOS/VE DEADSTART, CM = MB CM SIZE (10); IF NOS or NOS/BE DEADSTART, CM = CM WORDS/100B.

Display I-7-3. Hardware Reconfiguration

The hardware reconfiguration display permits you to reconfigure central memory elements. To reconfigure CPU elements, enter an R while displaying the Hardware Reconfiguration display to select the Reconfigure CPU Elements display. The Reconfigure CPU Elements display, shown in display I-7-4, permits you to reconfigure CPU elements.

```

      RECONFIGURE CPU ELEMENTS
      (CR) - ENTER OS LOAD AUTOMATIC
      (BS) - PREVIOUS DISPLAY

      CPU = 0          CS = YES

              OFF ELEMENTS
      PMAPn           CACHn
      CMJ             SMAPn
      IBSn

```

CIP40C

Display I-7-4. Reconfigure CPU Elements

The default hardware configuration includes every hardware element available for use. To change the hardware configuration, enter the appropriate entry on the Hardware Reconfiguration or Reconfigure CPU Elements display as described in table I-2-1. When you turn off an element, its identifier is added to the OFF ELEMENTS list on the display. Entries are in the form keyword=option.

Table I-7-1. Hardware Reconfiguration Entries, Model 990 (Sheet 1 of 3)

Keyword	Option	Display †	Function																											
CM=††	nnnnnnn	*1	<p>Specifies the size, in octal (for NOS or NOS/BE), of central memory in hundreds of words. The following examples show the value you enter for nnnnnnn, given the central memory size for NOS or NOS/BE.</p> <table border="0"> <thead> <tr> <th>Central Memory Size in Decimal Words</th> <th>Central Memory Size in Megabytes</th> <th>nnnnnnn</th> </tr> </thead> <tbody> <tr> <td>131K</td> <td>1</td> <td>4000</td> </tr> <tr> <td>262K</td> <td>2</td> <td>10000</td> </tr> <tr> <td>524K</td> <td>4</td> <td>20000</td> </tr> <tr> <td>1048K</td> <td>8</td> <td>40000</td> </tr> <tr> <td>2097K</td> <td>16</td> <td>100000</td> </tr> <tr> <td>4195K</td> <td>32†††</td> <td>200000</td> </tr> <tr> <td>8390K</td> <td>64†††</td> <td>400000</td> </tr> <tr> <td>16780K</td> <td>128†††</td> <td>1000000</td> </tr> </tbody> </table> <p>If you enter CM=0 or do not enter the CM=nnnnnnn parameter, the system sets the maximum central memory size.</p> <p>If you specify a value for nnnnnnn that exceeds the amount of physical memory, the system sends the following message:</p> <p style="text-align: center;">UNAVAILABLE</p> <p>If you specify a central memory size that is not large enough for a system deadstart, the system sets the maximum central memory size and the following message appears:</p> <p style="text-align: center;">INVALID ENTRY</p>	Central Memory Size in Decimal Words	Central Memory Size in Megabytes	nnnnnnn	131K	1	4000	262K	2	10000	524K	4	20000	1048K	8	40000	2097K	16	100000	4195K	32†††	200000	8390K	64†††	400000	16780K	128†††	1000000
Central Memory Size in Decimal Words	Central Memory Size in Megabytes	nnnnnnn																												
131K	1	4000																												
262K	2	10000																												
524K	4	20000																												
1048K	8	40000																												
2097K	16	100000																												
4195K	32†††	200000																												
8390K	64†††	400000																												
16780K	128†††	1000000																												
CPU _n =††	OFF/ON	*1	<p>Specifies the logical status of each available CPU. Values for n can be 0 or 1.</p> <p>On a two-CPU system, at least one must be ON.</p> <p>If you enter CPU₀=OFF on a one-CPU system, the entry is a no-op; the system uses the CPU.</p>																											
CPU=	n	*2	<p>Specifies the CPU for which you are to reconfigure elements.</p>																											
PP _{nn} =††	OFF/ON	*1	<p>Logically turn OFF/ON one or more peripheral processors. Acceptable values for nn are 3 through 11 (excluding 10) and, if you have them, 20 through 31. Ranges may be specified. For example, PP₅₋₇=OFF.</p>																											

Table I-7-1. Hardware Reconfiguration Entries, Model 990 (Sheet 2 of 3)

Keyword	Option	Display†	Function
CPPnn=††	OFF/ON	*1	<p>Logically turns OFF/ON one or more I4 CIO peripheral processors. Acceptable values for nn are 0 through 11B. Ranges may be specified. For example, CPP5-7=OFF.</p> <p>If the IOU installed is not an I4, the System displays the following message:</p> <p style="text-align: center;">INVALID ENTRY</p> <p>If the IOU is an I4, but no CIO PPs are installed, the system displays:</p> <p style="text-align: center;">UNAVAILABLE</p>
IBSn=††	OFF/ON	*2	<p>Specifies the logical status of each set of the central processor instruction buffer stack. The value for n can be any number from 0-3 or in the form a-b (a less than b). At least 1 set must be present or</p> <p style="text-align: center;">INVALID ENTRY will be displayed.</p>
PMapn=††	OFF/ON	*2	<p>Specifies the logical status of each unit of the central processor page map.</p> <p>The value for n can be any number from 0 to 3. The value for n also can be in the form a-b (a through b); a and b can be any number from 0 to 3, and a is less than b.</p> <p>Turn OFF a page map unit only in the event of a hardware error. System performance degrades when a map unit is turned OFF.</p>
CACHn=††	OFF/ON	*2	<p>Specifies logical status of each central processor cache unit. Acceptable values for n are 0 through 3. Ranges may be specified. For example, CACH0-1=OFF.</p> <p>Turn OFF a cache unit only in the event of a hardware error. System performance degrades when a cache unit is turned off.</p>
SMAPn=††	OFF/ON	*2	<p>Specifies logical status of each central processor segment map unit. Acceptable values for n are 0, 1, or 0-1. For example, SMAPO-1=OFF.</p>
PS=††	xx	*1	<p>Specifies the NOS/VE page size for standalone or dual state deadstarts. The allowable page sizes in decimal kilobytes are 4, 8, 16, 32, 64 and (default=4).</p>
PE=††	x	*1	<p>Specifies the NOS/VE entries per page table page for standalone or dual state deadstarts. The allowable values are 2, and 4, 7, and 8 (default=4).</p> <p>Turn OFF a segment map unit only in the event of a hardware error. System performance degrades when a segment map unit is turned OFF.</p>

Table I-7-1. Hardware Reconfiguration Entries, Model 990 (Sheet 3 of 3)

Keyword	Option	Display	Function
CS=††	YES/NO	*2	Specifies whether the system should load the central processor microcode into control store memory. The default is YES for all levels of deadstart. If NO is specified, the system does not load microcode from the deadstart disk into control store; whatever is there is used.
<p>†*1 = Hardware Reconfiguration Display; *2 = Reconfigure CPU Elements Display. ††These values are saved until changed for all deadstarts in the mainframe reconfiguration table for CYBER 180 mainframes. †††Available on models 840, 850, and 860. Also available on models 845 and 855 with memory upgrade option installed.</p>			

<u>Option</u>	<u>Description</u>
P (NOS or NOS/BE)	<p>Deadstart Panel Parameters for NOS or NOS/BE. Select this option to change any of the following: the deadstart level, the CMRDECK, or deadstart program words 12 and 14. The Deadstart Panel Parameters display, display I-7-5, appears.</p> <p>Press the carriage return key to cause system deadstart processing to continue with no further intervention on your part. You cannot select additional options after this entry.</p> <p>Press the backspace key to return to the Operator Intervention display.</p> <p>Table I-7-2 lists the keyboard entries that you can make to change deadstart panel (program) parameters.</p>
P (NOS/VE)	<p>Deadstart Panel Parameters for NOS/VE. Select this option to change the DCFILE or the operator pause entry.</p>

NOS or NOS/BE

NOS/VE

DEADSTART PANEL PARAMETERS

(CR) - ENTER OS LOAD AUTOMATIC
 (BS) - RETURN TO XOX DISPLAY

I = 0 - INIT/RECOVERY LVL
 C = 00 - CMRDECK NUMBER
 D = NO - DISPLAY CMRDECK
 W12 = XXXX - D/S PANEL WORD 12
 W14 = 0000 - D/S PANEL WORD 14

DEADSTART PANEL PARAMETERS

(CR) - ENTER OS LOAD AUTOMATIC
 (BS) - RETURN TO XOX DISPLAY

D = 00 - DCFILE NUMBER (8)
 P = NO - OPERATOR PAUSE

Display I-7-5. Deadstart Panel Parameters

Table I-7-2. Keyboard Entries for the Deadstart Panel Parameters Display, Model 990

Keyword	Function
	<u>NOS or NOS/BE</u>
I=x	Specifies the level of deadstart. The value of x can be 0, 1, 2, or 3.
C=xx	Specifies the CMRDECK (CMR for NOS/BE) number. The value of xx can be any number from 0 to 77 octal. Refer to the part II, section 1 for information about CMRDECK/CMR selection.
D=xxx	Entry is not used by NOS/BE. For NOS, specifies whether the CMRDECK is to be displayed. The value of xxx can be: YES for display CMRDECK. NO for do not display CMRDECK.
W12=xxxx	Specifies the value for deadstart program word 12. Refer to the part II, section 1 for the proper setting.
W14=xxxx	Specifies the value for deadstart program word 14. Word 14 is reserved for the operating system or maintenance system.
	<u>NOS/VE</u>
D=xx	Specifies the DCFILF number. The value of xx can be any number from 0 to 77 octal.
P=xx	Specifies whether a pause will be initiated for operator entries at the NOS/VE Deadstart Screen.

Option

Description

S Select Deadstart Device. Select this option to specify an alternate disk or a tape device as the OS Deadstart Device (display I-7-6).

Press the carriage return key to cause system deadstart processing to continue with no further intervention on your part. You cannot select additional options after this entry. The CIP disk device is therefore the OS device.

Press the backspace key to return to the Operator Intervention display.

Entry

Description

- T Tape OS Deadstart. Select this option for a tape OS deadstart rather than from disk. For NOS or NOS/BE deadstarts, the system prompts you for tape device type, channel, equipment, and unit. For NOS/VE deadstarts, the OS load initiates upon selecting this option.
- D Alternate Disk OS Deadstart. Select this option to choose an alternate disk device for the OS deadstart device. For NOS or NOS/BE deadstarts, the system prompts you for the disk channel, equipment, and unit. For NOS/VE deadstarts, the OS load initiates upon selecting this option.

NOS or NOS/BE

SELECT OS DEADSTART DEVICE

- (CR) - CONTINUE OS LOAD
- (BS) - PREVIOUS DISPLAY
- T - TAPE DEADSTART
- D - ALTERNATE DISK DEADSTART

CIP42A

NOS/VE

SELECT OS DEADSTART DEVICE

- (BS) - PREVIOUS DISPLAY

- T - TAPE DEADSTART
- D - ALTERNATE DISK DEADSTART
- (CR) - DEFAULT DISK DEADSTART

CIP42B

ALL OPTIONS EXIT TO THE CONTINUE OPERATING SYSTEM LOAD PATH.

ENTER TAPE TYPE - 2

(1=66X, 2=63X/67X)

CHANNEL - 13

EQUIPMENT - 0

UNIT - 00

(BS) BACK TO PREVIOUS ENTRY

CIP13

OS DISK DEVICE LOCATION

CHANNEL - 01

EQUIPMENT - 0

UNIT - 00

(BS) BACK TO PREVIOUS ENTRY

CIP08B

Display I-7-6. Deadstart Device

Option

Description

- M Load the Monitor Display Driver (MDD) Program. This value is saved in MRT for all CYBER 180 mainframes. Select this option to load MDD. The display shown in display I-7-7 appears.

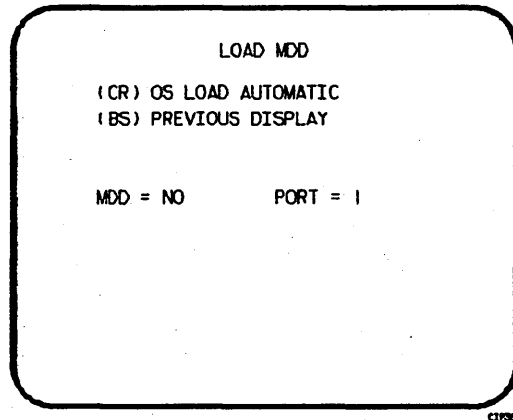

Display I-7-7. Load MDD

Direct the system to load MDD by entering:

MDD=YES

Select the port number of the two-port multiplexer that MDD uses by entering:

PORT = n

Parameter n is 0 or 1. The default port number is 0.

NOTE

Be sure the baud rate of the specified port of the two-port multiplexer is set properly for the communications being used.

Press the carriage return key to cause system deadstart processing to continue with no further intervention on your part.

Press the backspace key to return to the Operator Intervention display.

- 0 Toggle the OS Load State to either a NOS/VE deadstart or a NOS or NOS/BE deadstart. The correct Load State is displayed below the Operator Intervention Display Header. This value is saved in MRT for all CYBER 180 mainframes.

Press the carriage return key to cause system deadstart processing to continue with no further intervention on your part.

Press the backspace key to return to the Operator Intervention display.

UTILITIES DISPLAY

Selecting the U option from the Initial Options display causes the Utilities display, display I-7-8, to appear.

UTILITIES

E EXPRESS DEADSTART DUMP
P PRINTER DUMP
S ALTERNATE DEADSTART
DEVICE SELECTION
D DEFINE AND DISPLAY DEFAULT
DEVICE PARAMETERS
L DISPLAY CIP COMPONENT
INFORMATION
I INITIALIZE MAINFRAME
C CLEAR DEADSTART ERROR LOG
F CLEAR CM FLAW TABLE
H CLEAR MAINFRAME RECONFIGURATION
TABLE
A LOAD MONITOR DISPLAY DRIVE

(CR) EXPRESS DEADSTART DUMP
(BS) PREVIOUS DISPLAY

CIP41A

Display I-7-8. Utilities, Disk Deadstart

<u>Option</u>	<u>Description</u>
(CR) or E	Express Deadstart Dump (EDD). Select this option to dump to magnetic tape the contents of PP memories, central memory, unified extended memory, CPU hardware registers, maintenance registers, processor control store memories, and the tape and disk controlware. When the E option is selected, CTI checks the error status of all system elements and displays error messages for any errors before allowing the deadstart dump to continue. Refer to Performing an Express Deadstart Dump in part II, section 2 for procedures and further information.
P	Dump to Printer. Select this option to dump central memory, PP memory, or maintenance register contents to a line printer. When you specify P, the Dump to Printer Options display, display I-7-9, appears. You cannot return to the Utilities display from this display. You must redeadstart the system. When the P option is selected, CTI checks the error status of all system elements and displays error messages for any errors before allowing the deadstart dump to continue. Table I-7-3 shows the keyboard entries for performing a printer dump. Refer to Performing a Printer Dump in part II, section 2 for procedures and further information.

NOTE

When the E or P options are selected, CTI will check the error status of all the system elements. If errors are encountered, CTI will log the errors in the deadstart error log. If the deadstart error log is full, CTI will display the errors before allowing the deadstart to continue.

```

A - 512 PRINTER INITIALIZE
B - 580 PRINTER INITIALIZE
C - PP MEMORY DUMP
D - CM DUMP
E - PAGE MAP DUMP IN HEX
F - SEGMENT MAP DUMP IN HEX
G - CACHE DUMP IN HEX
H - PP MEMORY DUMP IN HEX
I - CM DUMP IN HEX
J - ERROR TAG MEMORY DUMP IN HEX
K - IOU REGISTER DUMP IN HEX
L - CM DUMP IN HEX
M - CPU REGISTER DUMP IN HEX
N - REGISTER UNIT DUMP IN HEX
O - PEM REGISTER DUMP IN HEX
P - IBS DUMP IN HEX

Z - CHANNEL STATUS DUMP

(CR) CONTROL MEMORY OPTIONS

```

CIP07C

```

Q - ACU DUMP IN HEX
R - BDP DUMP IN HEX
S - EPN DUMP IN HEX
T - CONTROL STORE DUMP IN HEX
U - CONTROL WORD DUMP IN HEX
V - MAPPING MEMORY DUMP IN HEX
W - LSU DUMP IN HEX

(BS) PREVIOUS DISPLAY

```

CIP10

Display I-7-9. Dump to Printer Options

Option

Description

S Alternate Deadstart. Select this option to specify an alternate CIP tape unit or disk device from which to deadstart. The Alternate Deadstart display, display I-7-10, appears.

```

DEADSTART DEVICE TYPE - 2
(1=66X, 2=63X/67X, 3=DISK)

CHANNEL - 13
EQUIPMENT - 0
UNIT - 00

(BS) BACK TO PREVIOUS ENTRY

```

CIP08A

Display I-7-10. Alternate Deadstart

Enter the device type and press the carriage return key. The system then prompts you for channel, equipment, and unit numbers.

Default values are provided for the device parameters. The values are those specified in the default parameter block. The default parameter block is defined through option D, define default device parameters.

After the device information is entered, press the carriage return key to deadstart from the alternate device.

Table I-7-3. Keyboard Entries for a Printer Dump, Model 990 (Sheet 1 of 2)

Entry	Function
A	512 Printer Initialize. This option initializes the 512 printer image with the data necessary to print with a 512-1 print train.
B	580 Printer Initialize. This option initializes the 580 printer buffer image and format buffer image memories.
C	PP Memory Dump. This option provides an octal dump to printer of 12-bit PP memories and 16-bit PP memories with their associated R registers. If the IOU is an I4, the Associated P, Q, K, and A register values will also be dumped.
D	CM Dump. This option provides an octal dump to printer of a selected area of central memory.
E	Page Map Dump in Hexadecimal. This option provides a hexadecimal dump to the printer of the CPU Page Map.
F	Segment Map Dump in Hexadecimal. This option provides a hexadecimal dump to the printer of the CPU Segment Map.
G	Cache Dump in Hexadecimal. This option provides a hexadecimal dump to the printer of the CPU Cache.
H	PP Memory Dump in Hexadecimal. This option provides a hexadecimal dump to the printer of the PP memories. If the IOU is an I4, the associated P, Q, K, and A register values will also be dumped.
I	CM Dump in Hexadecimal. This option provides a hexadecimal dump to the printer of a selected area of central memory.
J	Error Tag Memory Dump in Hexadecimal. This option provides a hexadecimal dump to the printer of the CPU Error Tag Memory contents.
K	IOU Register File Dump in Hexadecimal. This option provides a hexadecimal dump to the printer of the IOU maintenance register contents. If the IOU is an I4, the CIO registers will also be dumped, if installed.
L	CM Register Dump in Hexadecimal. This option provides a hexadecimal dump to the printer of the contents of the central memory maintenance registers.
M	<p>CPU Register Dump in Hexadecimal. This option provides a hexadecimal dump to the printer of the contents of the CPU maintenance registers. Respond to the message CPU NO = by entering the number of the CPU for which registers are to be dumped.</p> <p>If microcode is not executing, the program dumps only the hardware maintenance registers. In place of the software registers, the following message appears on the printer dump:</p> <p style="text-align: center;">MICROCODE HUNG</p>
N	PEM Register Dump in Hexadecimal. This option provides a hexadecimal dump of the contents of the PEM registers.

Table I-7-3. Keyboard Entries for a Printer Dump, Model 990 (Sheet 2 of 2)

Entry	Function
O	Control Store Dump in Hexadecimal. This option provides a hexadecimal dump to the printer of the contents of control store. Respond to the message CPU NO = by entering the number of the CPU for which control store is to be dumped.
P	IBS Dump in Hexadecimal. This option provides a hexadecimal dump to the printer of the CPU IBS contents.
Q	ACU Dump in Hexadecimal. This option provides a hexadecimal dump to the printer of the CPU ACU contents.
R	BDP Dump in Hexadecimal. This option provides a hexadecimal dump to the printer of the CPU BDP contents.
S	EPN Dump in Hexadecimal. This option provides a hexadecimal dump to the printer of the CPU EPN contents.
T	Control Store Dump in Hexadecimal. This option provides a hexadecimal dump to the printer of the contents of control store followed by a dump of shadow memory, if available.
U	Control Word Dump in Hexadecimal. This option provides a hexadecimal dump to the printer of CPU Control Word contents.
<div data-bbox="732 1100 821 1129" data-label="Section-Header"> <p>NOTE</p> </div> <div data-bbox="467 1159 1044 1262" data-label="Text"> <p>For any of the CPU Dump options respond to the message CPU NO = by entering the number of the CPU for which registers are to be dumped.</p> </div>	
V	Mapping Memory Dump in Hexadecimal. This option provides a hexadecimal dump to the printer of the CPU Mapping Memory control memory contents.
W	LSU Dump in Hexadecimal. This option provides a hexadecimal dump to the printer of the CPU LSU control memory contents.
Z	Channel Status Dump. This option, available on I4 IOU's only dumps the status of Parity Error Disable, Active, Full, Channel Flag, and Channel Error for NIO channels 00-31B and, if installed, CIO channels 00-11B. A "0" in the resulting output indicates the corresponding status flag is clear and a "1" indicates the status flag is set.

Option

Description

NOTE

Alternate deadstart from operating system deadstart tapes is not supported for model 800 computer systems. To load the operating system from a tape file, select option T, operating system file on tape, from the Operator Intervention display.

- D Define and Display Default Device Parameters. Select this option to assign default values to the channel, equipment, and unit numbers of a CIP tape deadstart device, disk deadstart device, alternate disk deadstart device, tape dump (EDD) device, or printer dump device. Default values are initially assigned to the device parameters when CIP is installed.
- L Display CIP Component Levels. Select this option to display the release levels of the CIP components: microcode, EI, SCD, DFT, MDD, VE programs and DFT, and the full or empty status of the deadstart error log (DEL). An asterisk identifies components that have been installed manually.
- I Initialize Mainframe. Select this option to initialize the mainframe after power interruption or maintenance activity. The Initial Options display reappears with the following message on the bottom of the display:
- ALL MAINFRAME MEMORIES WILL
BE INITIALIZED FOR MSL/OS LOADS
- Mainframe initialization, including initialization of central memory, PP memory, and maintenance registers, occurs when you select this option and then perform either an operating system load on a level 0, 1, or 2 (not 3) deadstart or select the off-line maintenance option. Refer to part II, section 2 for procedures and additional information about this option.
- C Clear deadstart error log (DEL). Select this option to clear the data in the deadstart error log.
- F Clear central memory flaw table. Select this option to clear the data in the CM flaw table.
- H Clear mainframe reconfiguration table (MRT). Select this option to clear the mainframe reconfiguration table data stored on disk.

Option

Description

A Load the Monitor Display Driver. Select this option to execute MDD in a standalone mode (not concurrent with the operating system).

When you specify A, the MDD Parameters display, display I-7-11, appears.

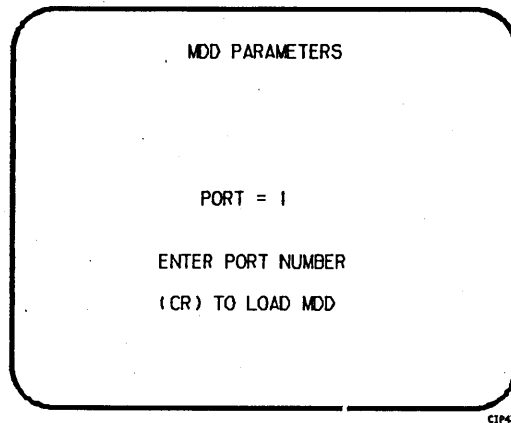

Display I-7-11. MDD Parameters

Enter the port number if different than the one displayed. Press the carriage return key to cause MDD to load. When you have finished using MDD, a deadstart is required. Refer to part III, section 1 for the uses of MDD.

This option is used to support the analysis of the state of a mainframe after encountering a system interrupt. It should only be selected after an operating system has been previously loaded. CTI loads MDD out of central memory (stored there on a system load) and issues the following message, if a checksum of the MDD program fails.

UNABLE TO LOAD MDD.

THE INTEGRITY OF CENTRAL MEMORY
HAS BEEN COMPROMISED.

DISPLAYS AND OPTIONS FOR DEADSTART FROM CIP TAPE

The CIP tape deadstart displays and options included in this subsection incorporate the following conventions:

- The default option on a menu display is the first option listed. The option can be selected automatically by pressing the carriage return key.
- Help information is provided for the Initial Options displays and the Build Deadstart Disk display. The Help displays supply brief information about the options. More detailed option information is given elsewhere in this section.
- Pressing the backspace key allows you to return to the previous display.

OVERVIEW

Figure I-7-2 provides an overview of the displays and options available during a deadstart from CIP tape on model 990.

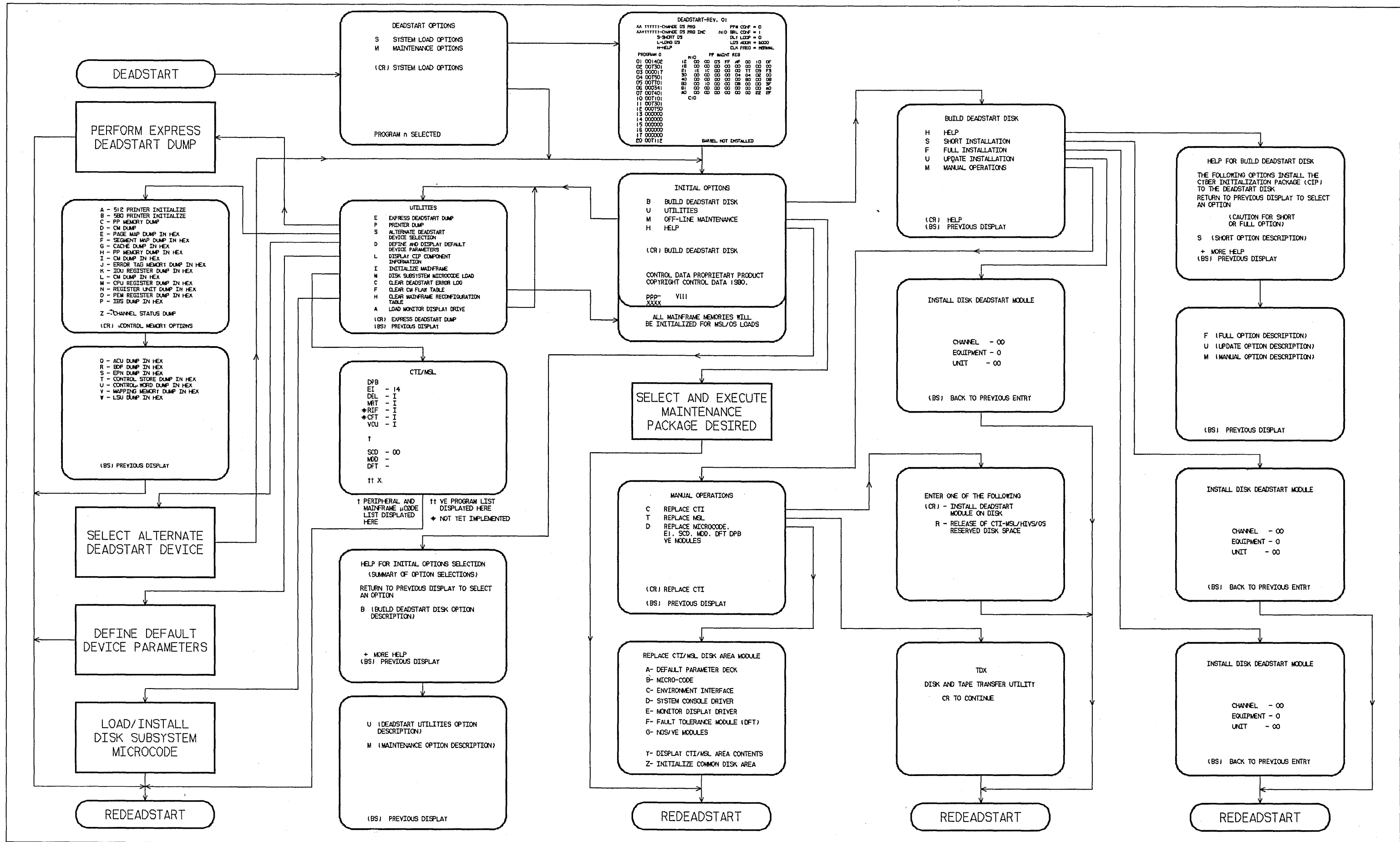

Figure I-7-2. Overview of Displays and Options for Deadstart From CIP Tape (Model 990)

INITIAL OPTIONS DISPLAY

The Initial Options display, display I-7-12, is the first screen that appears after the deadstart program is initiated. When the deadstart program is set for deadstart from the CIP tape, the Initial Options display provides utilities to install the CIP to disk. A CIP tape deadstart also allows execution of several utilities from tape should the deadstart disk be unusable.

```
          INITIAL OPTIONS
          B  BUILD DEADSTART DISK
          U  UTILITIES
          M  OFF-LINE MAINTENANCE
          H  HELP

          (CR) BUILD DEADSTART DISK

          CONTROL DATA PROPRIETARY PRODUCT
          COPYRIGHT CONTROL DATA 1980.

          ppp-  VIII
          xxxx
```

CIP15

Display I-7-12. Initial Options From CIP Tape

<u>Option</u>	<u>Description</u>
(CR) or B	Build Deadstart Disk. This option allows you to install CIP to disk. The CIP modules must reside on the disk before an operating system deadstart can be performed. CIP modules are used to initialize the mainframe and establish the operating environment. Refer to CIP Installation earlier in this section.
U	Utilities. Select this option to: <ul style="list-style-type: none">● Perform an Express Deadstart Dump (dump memories and registers to tape).● Perform a printer dump.● Deadstart from a different device.● Define default device parameters.● Display CIP component levels.● Initialize the mainframe after power interruption or maintenance activity.● Load/install peripheral microcode.

Option

Description

- Clear deadstart error log (DEL).
- Load the monitor display driver (MDD) in NOS/VE standalone mode.
- Clear the central memory flaw table.
- Clear the mainframe reconfiguration table (MRT).

M Off-Line Maintenance. This option is provided to enable the CE to execute hardware tests for preventive maintenance or hardware error diagnosis. Information about the option is included in the MSL 15X Reference Manual.

The contents of word 12 of the deadstart program also affect the M option. Refer to Setting Word 12 in part II, section 1 of this manual.

Execution of the hardware diagnostics from tape is much slower than from disk. Use tape only when your deadstart disk is not usable.

H Help for Initial Options Selection.

When the CC634B console is being used, press H or the HELP key for a description of the initial options.

The CIP version number, ppp- Vlll, is displayed at the bottom of the Initial Options display, where ppp is mainframe type and lll is CIP release level. At the very bottom of the display, xxxx is the PSR level.

BUILD DEADSTART DISK DISPLAY

The Build Deadstart Disk display, display I-7-13, appears when you select option B, build deadstart disk, from the Initial Options display. The Build Deadstart Disk display is available only when you deadstart from the CIP tape. This display provides the options that install the CIP to the deadstart disk. Refer to CIP Installation, earlier in this section, for CIP installation procedures and displays.

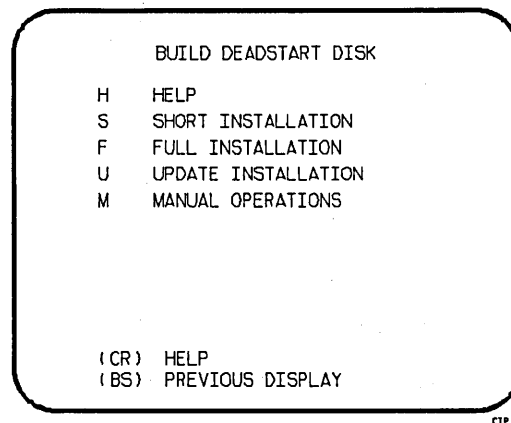

CIP16

Display I-7-13. Build Deadstart Disk

<u>Option</u>	<u>Description</u>
(CR) or H	Help for Build Option Selection. When the CC634B console is being used, press H or the HELP key for a description of the build options.

CAUTION

The short and full installation options destroy all information on the deadstart disk, except the disk microcode, before installing CIP. Before executing the short or full installation option, be sure you have a backup copy of any information on the deadstart disk that you want to preserve, including operating system permanent files and CE command buffers. After executing the short or full installation option, you must perform an operating system initialization of the disk.

- S Short Installation. Select this option to initialize the deadstart disk and then install the CIP to the deadstart disk. Some of the hardware diagnostics on the CIP will not be installed; only diagnostics needed most frequently by the CE are installed. Execute either the short or full installation option when you install CIP for the first time.
- F Full Installation. Select this option to initialize the deadstart disk and then install all of CIP to the deadstart disk. Execute either the short or full option when you install CIP for the first time.
- U Update Installation. Select this option to replace CIP on the deadstart disk some time after the short/full installation. The update option preserves operating system information on the deadstart disk.
- M Manual Operations. Select this option to perform emergency CIP component replacement at any time after CIP has been installed. Display I-7-14, the Manual Operations display, provides manual operation option selection.

MANUAL OPERATIONS DISPLAY

The Manual Operations display appears when you select option M, manual operations, from the Build Deadstart Disk display. Manual operations are available only when you deadstart from the CIP tape.

Manual operations provide manual replacement of individual CIP components, which may be required in the event of a critical problem. Refer to Emergency CIP Repair Procedures - Model 800 Computer Systems in part II, section 2 for repair and manual replacement procedures. More detailed information about manual operations is provided in the MSL 15X Reference Manual.

MANUAL OPERATIONS

C REPLACE CTI
T REPLACE MSL
D REPLACE MICROCODE,
EI, SCD, MDD, DFT DPB
VE MODULES

(CR) REPLACE CTI
(BS) PREVIOUS DISPLAY

CIPFOA

Display I-7-14. Manual Operations

<u>Option</u>	<u>Description</u>
(CR) or C	Replace CTI. Select this option to install the CTI component of CIP to the deadstart disk.

NOTE

This option provides the capability to release CTI-MSL/HIVS/OS disk space. For detailed procedures, see Build Deadstart Disk Operations in part II, section 2.

T	Replace MSL. Select this option to install the Maintenance Software Library component of CIP to the deadstart disk.
---	---

Option

Description

D Replace Mainframe microcode, EI, SCD, MDD, DFT, DPB, or the NOS/VE modules.

NOTE

Select this option only after an initial install has been performed.

Select this option to replace microcode, EI, the CC634B System Console Driver (SCD), the Monitor Display Driver (MDD), DFT, default device parameters (DPB), or the NOS/VE boot modules, or to initialize the common disk area (CDA). When option D is selected, you are prompted to enter the disk channel and disk unit numbers. After you enter the channel and unit numbers or press the carriage return key to accept the default values shown, the CAU Initial Options display shown in display I-7-15 appears. Options A through G manually replace CIP modules on the deadstart disk.

Select option Y on the CAU Options display to display the level numbers of the microcode and EI modules resident on the deadstart disk. If any module has been manually replaced, an asterisk appears by the module name on this display.

REPLACE CTI/MSL DISK AREA MODULE

- A- DEFAULT PARAMETER DECK
- B- MICRO-CODE
- C- ENVIRONMENT INTERFACE
- D- SYSTEM CONSOLE DRIVER
- E- MONITOR DISPLAY DRIVER
- F- FAULT TOLERANCE MODULE (DFT)
- G- NOS/VE MODULES

- Y- DISPLAY CTI/MSL AREA CONTENTS
- Z- INITIALIZE COMMON DISK AREA

CIP22

Display I-7-15. CAU Initial Options

UTILITIES DISPLAY

Selecting the U option from the Initial Options display causes the Utilities display, display I-7-16, to appear.

UTILITIES	
E	EXPRESS DEADSTART DUMP
P	PRINTER DUMP
S	ALTERNATE DEADSTART DEVICE SELECTION
D	DEFINE AND DISPLAY DEFAULT DEVICE PARAMETERS
L	DISPLAY CIP COMPONENT INFORMATION
I	INITIALIZE MAINFRAME
M	DISK SUBSYSTEM MICROCODE LOAD
C	CLEAR DEADSTART ERROR LOG
F	CLEAR CM FLAW TABLE
H	CLEAR MAINFRAME RECONFIGURATION TABLE
A	LOAD MONITOR DISPLAY DRIVE
(CR)	EXPRESS DEADSTART DUMP
(BS)	PREVIOUS DISPLAY

CIP418

Display I-7-16. Utilities, Tape Deadstart

<u>Option</u>	<u>Description</u>
(CR) or E	Express Deadstart Dump (EDD). Select this option to dump to magnetic tape the contents of PP memories, central memory, unified extended memory, CPU hardware registers, maintenance registers, processor control store memories, and the tape and disk controlware. When the E option is selected, CTI checks the error status of all system elements and displays error messages for any errors before allowing the deadstart dump to continue. Refer to Performing an Express Deadstart Dump in part II, section 2 for further information.
P	Dump to Printer. Select this option to dump central memory, PP memory, or maintenance register contents to a line printer. When you specify P, the Dump to Printer Options display, display I-7-17, appears. You cannot return to the Utilities display from this display. You must redeadstart the system. When the P option is selected, CTI checks the error status of all system elements and displays error messages for any errors before allowing the deadstart dump to continue. Table I-7-4 lists the keyboard entries for performing a printer dump. For more information refer to Performing a Printer Dump in part II, section 2.

NOTE

When the E or P options are selected, CTI will check the error status of all the system elements. If errors are encountered, CTI will log the errors in the deadstart error log. If the deadstart error log is full, CTI will display the errors before allowing the deadstart to continue.

A - 512 PRINTER INITIALIZE
 B - 580 PRINTER INITIALIZE
 C - PP MEMORY DUMP
 D - CM DUMP
 E - PAGE MAP DUMP IN HEX
 F - SEGMENT MAP DUMP IN HEX
 G - CACHE DUMP IN HEX
 H - PP MEMORY DUMP IN HEX
 I - CM DUMP IN HEX
 J - ERROR TAG MEMORY DUMP IN HEX
 K - IOU REGISTER DUMP IN HEX
 L - CM DUMP IN HEX
 M - CPU REGISTER DUMP IN HEX
 N - REGISTER UNIT DUMP IN HEX
 O - PEM REGISTER DUMP IN HEX
 P - IBS DUMP IN HEX

 Z - CHANNEL STATUS DUMP
 (CR) CONTROL MEMORY OPTIONS

CIP07C

Q - ACU DUMP IN HEX
 R - BDP DUMP IN HEX
 S - EPN DUMP IN HEX
 T - CONTROL STORE DUMP IN HEX
 U - CONTROL WORD DUMP IN HEX
 V - MAPPING MEMORY DUMP IN HEX
 W - LSU DUMP IN HEX

 (BS) PREVIOUS DISPLAY

CIP10

Display I-7-17. Dump to Printer Options

Table I-7-4. Keyboard Entries for a Printer Dump, Model 990 (Sheet 1 of 3)

Entry	Function
A	512 Printer Initialize. This option initializes the 512 printer image with the data necessary to print with a 512-1 print train.
B	580 Printer Initialize. This option initializes the 580 printer buffer image and format buffer image memories.
C	PP Memory Dump. This option provides an octal dump to printer of 12-bit PP memories and 16-bit PP memories with their associated R registers. If the IOU is an I4, the Associated P, Q, K, and A register values will also be dumped.
D	CM Dump. This option provides an octal dump to printer of a selected area of central memory.
E	Page Map Dump in Hexadecimal. This option provides a hexadecimal dump to the printer of the CPU Page Map.
F	Segment Map Dump in Hexadecimal. This option provides a hexadecimal dump to the printer of the CPU Segment Map.
G	Cache Dump in Hexadecimal. This option provides a hexadecimal dump to the printer of the CPU Cache.
H	PP Memory Dump in Hexadecimal. This option provides a hexadecimal dump to the printer of the PP memories. If the IOU is an I4, the associated P, Q, K, and A register values will also be dumped.
I	CM Dump in Hexadecimal. This option provides a hexadecimal dump to the printer of a selected area of central memory.

Table I-7-4. Keyboard Entries for a Printer Dump, Model 990 (Sheet 2 of 3)

Entry	Function
J	Error Tag Memory Dump in Hexadecimal. This option provides a hexadecimal dump to the printer of the CPU Error Tag Memory contents.
K	IOU Register File Dump in Hexadecimal. This option provides a hexadecimal dump to the printer of the IOU maintenance register contents. If the IOU is an I4, the CIO registers will also be dumped, if installed.
L	CM Register Dump in Hexadecimal. This option provides a hexadecimal dump to the printer of the contents of the central memory maintenance registers.
M	<p>CPU Register Dump in Hexadecimal. This option provides a hexadecimal dump to the printer of the contents of the CPU maintenance registers. Respond to the message CPU NO = by entering the number of the CPU for which registers are to be dumped.</p> <p>If microcode is not executing, the program dumps only the hardware maintenance registers. In place of the software registers, the following message appears on the printer dump:</p> <p style="padding-left: 40px;">MICROCODE HUNG</p>
N	PEM Register Dump in Hexadecimal. This option provides a hexadecimal dump of the contents of the PEM registers.
O	Control Store Dump in Hexadecimal. This option provides a hexadecimal dump to the printer of the contents of control store. Respond to the message CPU NO = by entering the number of the CPU for which control store is to be dumped.
P	IBS Dump in Hexadecimal. This option provides a hexadecimal dump to the printer of the CPU IBS contents.
Q	ACU Dump in Hexadecimal. This option provides a hexadecimal dump to the printer of the CPU ACU contents.
R	BDP Dump in Hexadecimal. This option provides a hexadecimal dump to the printer of the CPU BDP contents.
S	EPN Dump in Hexadecimal. This option provides a hexadecimal dump to the printer of the CPU EPN contents.
T	Control Store Dump in Hexadecimal. This option provides a hexadecimal dump to the printer of the contents of control store followed by a dump of shadow memory, if available.
U	Control Word Dump in Hexadecimal. This option provides a hexadecimal dump to the printer of CPU Control Word contents.
<div style="border: 1px solid black; display: inline-block; padding: 2px 10px; margin: 10px 0;">NOTE</div> <p>For any of the CPU Dump options respond to the message CPU NO = by entering the number of the CPU for which registers are to be dumped.</p>	

Table I-7-4. Keyboard Entries for a Printer Dump, Model 990 (Sheet 3 of 3)

Entry	Function
V	Mapping Memory Dump in Hexadecimal. This option provides a hexadecimal dump to the printer of the CPU Mapping Memory control memory contents.
W	LSU Dump in Hexadecimal. This option provides a hexadecimal dump to the printer of the CPU LSU control memory contents.
Z	Channel Status Dump. This option, available on I4 IOU's only dumps the status of Parity Error Disable, Active, Full, Channel Flag, and Channel Error for NIO channels 00-31B and, if installed, CIO channels 00-11B. A "0" in the resulting output indicates the corresponding status flag is clear and a "1" indicates the status flag is set.

Option

Description

- S Alternate Deadstart. Select this option to specify an alternate CIP tape unit or disk device from which to deadstart. The Alternate Deadstart display, display I-7-18, appears.

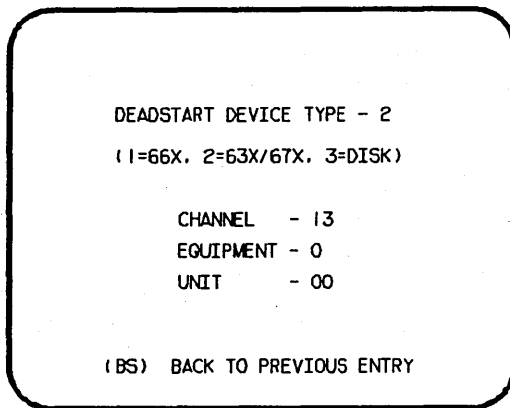

Display I-7-18. Alternate Deadstart

Enter the device type and press the carriage return key. The system then prompts you for channel, equipment, and unit numbers.

Default values are provided for the device parameters. The values are those specified in the default parameter block. The default parameter block is defined through option D, define default device parameters.

Option

Description

After the device information is entered, press the carriage return key to deadstart from the alternate device.

NOTE

Alternate deadstart from operating system deadstart tapes is not supported for model 800 computer systems. To load the operating system from a tape file, select option T, operating system file on tape, from the Operator Intervention display.

- D Define and Display Default Device Parameters. Select this option to assign default values to the channel, equipment, and unit numbers of a CIP tape deadstart device, disk deadstart device, alternate disk deadstart device, tape dump (EDD) device, or printer dump device. Default values are initially assigned to the device parameters when CIP is installed.
- L Display CIP Component Levels. Select this option to display the release levels of the CIP components: microcode, EI, SCD, MDD, NOS/VE programs, and DFT and the full or empty status of the deadstart error log (DEL). An asterisk identifies components that have been installed manually.
- I Initialize Mainframe. Select this option to initialize the mainframe after power interruption or maintenance activity. The Initial Options display reappears with the following message on the bottom of the display:
- ALL MAINFRAME MEMORIES WILL
BE INITIALIZED FOR MSL/OS LOADS
- Mainframe initialization, including initialization of central memory, PP memory, and maintenance registers, occurs when you select this option and then perform either an operating system load on a level 0, 1, or 2 (not 3) deadstart or select the off-line maintenance option. Refer to Performing a Power-On Initialization in part II, section 2 for procedures and additional information about this option.
- M Disk Subsystem Microcode Load. Select this option to load peripheral microcode into the 834/836 disk adapter and control module memory and install peripheral microcode onto specified drives. Refer to Loading and Installing Disk Subsystem Microcode From CIP Tape in part II, section 2 for procedures and additional information about this option.
- C Clear deadstart error log (DEL). Select this option to clear the data in the deadstart error log.
- F Clear central memory flaw table. Select this option to clear the data in the CM flaw table.
- H Clear mainframe reconfiguration table (MRT). Select this option to clear the mainframe reconfiguration table data stored on disk.

Option

Description

A

Load the Monitor Display Driver. Select this option to execute MDD in a standalone mode (not concurrent with the operating system).

When you specify A, the MDD Parameters display, display I-7-19, appears.

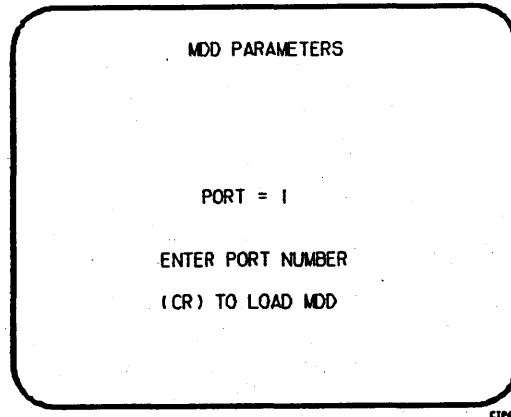

Display I-7-19. MDD Parameters

Enter the port number if different than the one displayed. Press the carriage return key to cause MDD to load. When you have finished using MDD, a deadstart is required. Refer to part III, section I for the uses of MDD.

This option is used to support the analysis of the state of a mainframe after encountering a system interrupt. It should only be selected after an operating system has been previously loaded. CTI will load MDD out of central memory (stored there on a system load) and issues the following message, if a checksum of the MDD program fails.

UNABLE TO LOAD MDD.

THE INTEGRITY OF CENTRAL MEMORY
HAS BEEN COMPROMISED.

PART II

DEADSTART PROCEDURE SUMMARIES

1

Deadstart is the process that makes the system operational and ready to process jobs. If you are using a CC545 console, you initiate the deadstart process by momentarily activating the deadstart switch. The recommended procedure is to press the deadstart button on the CC545 console. This executes the peripheral processor (PP) deadstart program.

For models 810, 815, 825, 830, and 990, in addition to support of deadstart from a CC545, deadstart from a CDC CC634B display terminal, which has been initialized to be the primary operator console, is also supported. Refer to appendix I for procedures to initialize a CC634B display terminal for use as a primary operator console. When a CC634B display terminal has been initialized for use as the primary operator console, complete the following steps to bring up the Deadstart Options display, display II-1-1, for a model 810 or 830 or the Maintenance Options display, display II-1-2, for the models 815 and 825.

1. Press the RESET button to reinitialize the console.
2. Hold down the CTRL key while pressing the G key.
3. When the message *OPERATOR ACCESS ENABLED appears on the screen, hold down the CTRL key while pressing the R key.

The deadstart program for models 810, 815, 825, 830, and 990 can then be entered or retrieved, and initiated from the Maintenance Options display. Refer to the appropriate models 810 and 830 or 815 and 825 or 990 hardware operator's guide.

The CC634B console is supported as the primary console for models 835 through 860 with the limitation that a deadstart (CTRL-G, CTRL-R) cannot be performed. To select the CC634B as the primary console you must set bit 2 of deadstart panel word 12 to a one. You then initiate a deadstart by using either the CC545 deadstart button or the deadstart switch on the deadstart panel.

There are two deadstart procedures: coldstart and warmstart. Coldstart is the procedure used to deadstart the system when the tape or disk controllers do not have controlware loaded. Warmstart is the procedure used when controlware is loaded and executing correctly. The CIP installation procedures and operating system deadstart procedures in part I, sections 2 through 6 are warmstart procedures.

In general, the procedure you use most often to deadstart is warmstart. Warmstart from mass storage, or a CDC 63X/667/669 Magnetic Tape Unit is possible after the disk controller or tape controller to be used is loaded with the proper controlware and the controlware is functioning. Warmstart is always possible from 677/679 Magnetic Tape Units.

Before you perform a warmstart, the following preliminary procedures might be required:

- Coldstart.
Loads the tape and disk controlware to their respective controllers.
- CIP installation to the disk.
Loads appropriate CIP modules (CTI, EI, HIVS/MSL, MDD, microcode, and SCD) to the disk.

If a coldstart is required, you must do it before any other procedure. In some instances, coldstart and warmstart are combined into a single procedure (for example, coldstart/warmstart of the CDC 834 Disk Subsystem).

A detailed description of the coldstart procedures follows. If you do not require this information, skip to Warmstart Procedure Summary later in this section.

NOTE

Attempts to perform deadstart from mass storage could be unsuccessful in configurations with shared access to controllers and drives. Conflicts can arise in both single and multiple mainframe configurations. In a multimainframe configuration, if another mainframe reserved the controller or drive, deadstart delays momentarily until the reservation is released. In a single mainframe configuration, if another channel reserved the drive, deadstart is unsuccessful. In this case, set the deadstart program for the other channel.

```
DEADSTART OPTIONS
S  SYSTEM LOAD OPTIONS
M  MAINTENANCE OPTIONS

(CR) SYSTEM LOAD OPTIONS

PROGRAM n SELECTED
```

CI137

Display II-1-1. Deadstart Options for Models 810, 830, and 990

MAINTENANCE OPTIONS
(REV. 03)

	PROGRAM 0†
XX YYYYYY-CHANGE DS PRG	01 001402
XX+YYYYYY-CHANGE DS PRG INC	02 007303
S-SHORT DS	03 000017
L-LONG DS	04 007503
H-HELP ††	05 007703
	06 000301
	07 007403
PPM CONF = 00 †††	10 007103
BRL CONF = 0 †††	11 007301
DLY LOOP = 0 †††	12 000710
LDS ADDR = 6000 ††	13 000376
CLF FREQ = NORMAL	14 000000
CM RECONF SW3 = C ††††	15 000000
SW4 = C SW5 = C ††††	16 000000
	17 000000
	20 007112

CDP388

† n is the number of the most recently used deadstart program number; the program contents are those most recently used to deadstart.

†† Refer to the models 815 and 825 and models 810 and 830 hardware operator's guides for explanation of these entries.

††† Define PP configuration. Refer to appendix G for information about reconfiguring PPs.

†††† Define CM configuration for models 810 and 830. Switches are numbered SW1, SW2, and SW3 for models with the memory upgrade option installed. Refer to appendix G for information about reconfiguring CM.

Display II-1-2. Maintenance Options for Models 810, 815, 825, and 830

COLDSTART PROCEDURE SUMMARIES

The coldstart procedures load the tape and disk controllers with controlware. The tape controlware can be loaded from a card reader or a tape unit depending on the type of controller.

The CDC 7021 Tape Controller for a 667/669 magnetic tape unit requires controlware loaded from a card reader. The CDC 7152 Tape Controller requires controlware loaded from either a card reader or a tape unit.

The CDC 7054 and 7154 Disk Controllers require controlware loaded from a card reader. The controlware for a CDC 7152 Disk Controller and the CDC 7155 Disk Controller (CDC 844-41/44 and 885-11/12 Disk Storage Units) can be loaded from either a card reader or a disk unit.

The CDC 834/836 Disk Subsystem controlware is loaded into the disk control module and disk adapter from the 834/836 disk or from tape.

Summaries of the procedures needed to perform a coldstart follow. These procedures apply to all mainframes except models 810, 815, 825, 830, and 990. For models 810, 815, 825, 830, and 990, refer to Coldstart Procedure Summary for Models 810, 815, 825, 830, and 990 later in this section. Use the appropriate summary as a checklist during deadstart. Detailed descriptions of all procedures in the deadstart process are provided throughout the remainder of this section.

This manual assumes that power is applied on all required equipment, and that the equipment is functioning properly. If at any time the system loses power or the equipment fails, consult the site analyst or CE.

COLDSTART OF TAPE CONTROLLERS FOR 667 OR 669 TAPE UNITS

Coldstart is necessary when subsequent deadstarts are from 667 or 669 magnetic tape units, if the controlware has not yet been loaded to the controller. The coldstart procedure contains a special program that reads the tape controller controlware, loads it to the controller, and then loads the deadstart tape.

Use the warmstart procedure after the controlware is loaded and functioning properly. After a coldstart from a card reader, the system loads the deadstart tape automatically; use a warmstart for subsequent deadstarts only. After a coldstart from a tape unit; however, you must perform a warmstart to load the system deadstart tape.

After a successful coldstart, you should immediately reset the deadstart program for a warmstart (except for models 810, 815, 825, 830, and 990, refer to Setting the Deadstart Panel for a Warmstart later in this section).

After initial loading of the controlware, there is no reason to perform a coldstart again if the tape subsystem is operating correctly.

Coldstart 7021/7152 Tape Controller From Card Reader

The following steps summarize the procedures necessary to coldstart a 7021 or 7152 tape controller from a card reader. Use this as a checklist during coldstart. Ensure that the card reader and the tape unit on which the deadstart tape is to be mounted are on different channels. The card reader must be on a channel without a PP (for example, channel 12 or 13).

1. Ensure that required mass storage devices have packs mounted and/or are available.
2. Mount the deadstart tape.
 - a. Ensure that the write-enable ring is not on the reel.
 - b. Mount the tape and ready the unit.
3. Set the deadstart program[†] for a coldstart from a card reader (refer to figure II-1-4 later in this section).
4. Set the mode switch to LOAD.^{††}
5. Press the deadstart button.
6. Insert card deck^{†††} in the card reader and activate card reader as follows:
 - a. Press MOTOR POWER.
 - b. Select AUTO MODE.
 - c. Press RELOAD MEMORY.
 - d. Press READY.
7. Continue with the deadstart process by selecting CIP options (refer to the Initial Options display for your model of computer system).

Coldstart 7152 Tape Controller From Tape Unit

The following steps summarize the procedures necessary to coldstart a 7152 tape controller from a 669 tape unit (coldstart of a 7152 tape controller from a 667 tape unit is not possible). Use this as a checklist during coldstart. Ensure that the 669 tape unit is set to a unit number between 10 and 17. The unit must be on a channel without a PP (for example, channel 12 or 13).

1. Mount controlware tape on the tape unit to be specified on the deadstart panel.
 - a. Ensure that the write-enable ring is not on the reel.
 - b. Mount the tape and ready the unit.
2. Set the deadstart program for a coldstart from tape unit (figure II-1-5).
3. Set the mode switch to LOAD.
4. Press the deadstart button. No display appears on the console. Unloading of the controlware tape indicates the controlware was loaded successfully.
5. Perform a warmstart to complete the deadstart operation.

[†] Refer to Coldstart Procedure for Models 810, 815, 825, 830, and 990 later in this section.

^{††} For all systems except models 810 through 860 and 990.

^{†††} For detailed information on the controlware deck, refer to the NOS 2 or NOS/BE Installation Handbook.

COLDSTART OF DISK CONTROLLERS FOR 844, 885-11/12, OR 895 DISK UNITS

Coldstart is necessary when deadstarting from 844, 885-11/12, or 895 disk units if the controlware is not yet loaded to the controller. The coldstart procedure contains a special program that reads the disk controller controlware, loads it to the controller, and then loads the deadstart file.

The procedure Coldstart 7054/7154/7152/7155/7165 Disk Controller From Card Reader described next loads all disk controllers. If the Maintenance Software Library (MSL) is available at your site, the procedure Coldstart 7152/7155/7165 Disk Controller From Disk Unit, described later in this section, loads the 7152, 7155, and 7165 disk controllers.

Use the warmstart procedure after the controlware is loaded and functioning properly. After a coldstart from a card reader, the system loads the deadstart tape automatically; use a warmstart for subsequent deadstarts only.

After a successful coldstart, you should immediately reset the deadstart program for a warmstart (refer to Setting the Deadstart Panel for a Warmstart later in this section).

After initial loading of the controlware, there is no reason to perform a coldstart again if the disk subsystem is operating correctly.

Coldstart 7054/7154/7152/7155/7165 Disk Controller From Card Reader

The following steps summarize the procedures necessary to coldstart a disk controller from a card reader. Use this as a checklist during coldstart. Ensure that the card reader and the disk unit on which the deadstart device is mounted are on different channels. The card reader must be on a channel without a PP (for example, channel 12 or 13).

1. Ensure that required mass storage devices have packs mounted and/or are available.
2. Mount the deadstart disk unit if using an 844 disk unit.
3. Set the deadstart program[†] for a coldstart from a card reader using 844 or 885-11/12 disk units (figure II-1-6).
4. Set the mode switch to LOAD.^{††}
5. Press the deadstart button.
6. Insert card deck^{†††} in card reader and activate card reader as follows:
 - a. Press MOTOR POWER.
 - b. Select AUTO MODE.
 - c. Press RELOAD MEMORY.
 - d. Press READY.
7. Continue with the deadstart process by selecting CIP options (refer to the Initial Options display for your model of computer system).

[†]Refer to Coldstart Procedure for Models 810, 815, 825, 830, and 990 later in this section.

^{††}For all systems except models 810 through 860 and 990.

^{†††}For detailed information on the controlware deck, refer to the NOS 2 or NOS/BE Installation Handbook.

Coldstart 7152/7155/7165 Disk Controller From Disk Unit

If controlware is loaded on a disk unit,[†] use this procedure to perform deadstart. The following steps summarize the procedures necessary to perform coldstart from a disk unit. Use this as a checklist during coldstart.

1. Ensure that required mass storage devices have packs mounted and/or are available.
2. Mount the deadstart disk unit if using an 844 disk unit.
3. Set the deadstart program^{††} for coldstart from a disk unit (figure II-1-6). Set the mode switch to LOAD.^{†††}
4. Press the deadstart button. The Initial Options from Disk display appears.
5. Continue with the deadstart process by selecting CIP options (refer to the Initial Options display for your model of computer system).

COLDSTART PROCEDURE SUMMARY FOR MODELS 810, 815, 825, 830, AND 990

The procedures to coldstart various controllers for models 810, 815, 825, 830, and 990 are similar to those for other computer systems except that models 810, 815, 825, 830, and 990 do not have a deadstart panel. The coldstart programs represented by the deadstart panel switch settings on models 835, 840, 845, 850, 855, or 860 must be entered through the console keyboard on models 810, 815, 825, 830, and 990 as octal numbers. Coldstart programs for models 810, 815, 825, 830, and 990 are identical to those for models 835, 840, 845, 850, 855, or 860 except where specifically noted.

In the various coldstart procedures described in this section, deadstarting a model 810, 830, or 990 brings up the Deadstart Options display shown in display II-1-1. Selecting option M on this display brings up the Maintenance Options display shown in display II-1-2. Selecting option S or pressing the carriage return key brings up the Initial Options display (refer to part I, section 2). Deadstarting on a model 815 or 825 brings up the Initial Deadstart Display shown in display II-1-2. The Deadstart Options display is not provided for models 815 and 825.

The bottom line of the Deadstart Options display (models 810, 830, and 990) identifies which deadstart program is selected and is to be executed. If this is not the desired deadstart program, enter M to bring up the Maintenance Options display.

The following paragraphs describe how to retrieve or modify the deadstart program for models 810, 815, 825, 830, and 990 using the Maintenance Options display.

If the coldstart program is already stored in the microprocessor, retrieve it by entering:

GP n

n is the number (0 through 2) of the stored program. You can change individual instructions in a program, such as unit number or other parameters, as described next. These changes are not retained across deadstarts unless the new program is stored as outlined later in this section.

[†] For more information on loading controlware to the disk, contact a CE.

^{††} For models 810, 815, 825, 830, and 990 refer to Coldstart Procedure for Models 810, 815, 825, 830, and 990, next.

^{†††} For all systems except models 810 through 860 and 990.

If the correct coldstart program is not stored or a new program is to be entered and stored, the program must be entered as octal numbers equivalent to the switch settings on deadstart panels for other models.

Enter the coldstart program represented by the switch settings shown in the related deadstart panel figure for your configuration by entering:

xx yyyyyy (or xx.yyyyyy, or xx,yyyyyy)

xx is the octal row number of the deadstart instruction and yyyyyy is the octal number equivalent of the actual instruction. When you enter a six-digit instruction, the first two digits of the instruction must be zeros. Leading zeros in both the octal row number and the instruction, however, need not be entered. For example, if the row number was 03 and the instruction was 00 1014, you could enter:

3 1014

and get the same setting as entering:

03 001014.

If you want the system to automatically increment the octal row number, the entry after which the increment is to occur is:

xx+yyyyyy

The + character indicates that the system is to automatically increment the octal row number. When the automatic increment is in effect, the system displays the next location after accepting the previous entry. Only the next instruction need be entered.

To cancel the automatic incrementing, press the left blank (erase) key after the octal row number appears.

To store a new program or a modified program, enter:

SP n

n is the number (0 through 2) of the program to be stored. If a program is already stored at the specified number, the new program replaces it.

After entering or retrieving the desired coldstart program, enter

S

then press the carriage return key to coldstart the controller.

Coldstart/Install 834/836 Disk Subsystem Microcode From CIP Tape

A special utility provides the capability of loading disk subsystem microcode into the 834 or 836 disk adapter and control module memory (coldstart) and of installing microcode onto the specified disk drives. Refer to Loading and Installing Disk Subsystem Microcode From CIP Tape in part II, section 2 for information about this utility. When microcode has been installed onto the disk, the Coldstart/Warmstart 834 or 836 Disk Subsystem From Disk procedure described next can be used.

Coldstart/Warmstart 834/836 Disk Subsystem From Disk

Use the following procedure to coldstart and warmstart an 834 or 836 Disk Subsystem. A coldstart loads controlware, which has been installed onto the disk, into the disk adapter and control module. Once the disk has been coldstarted, the warmstart occurs automatically.

1. Press the deadstart button on the CC545 display console to bring up the Maintenance Options display shown in display II-1-2.

When a CC634B display terminal is being used as the primary operator console, complete the following steps to bring up the Maintenance Options display:

- a. Press the RESET button to reinitialize the console.
 - b. Hold down the CTRL key while pressing the G key.
 - c. When the message *OPERATOR ACCESS ENABLED appears on the screen, hold down the CTRL key while pressing the R key.
2. For models 810, 830, and 990, the first display you see is the Deadstart Options display shown in display II-1-1.

If the program selected is the desired coldstart program, enter an L.

If the program selected is not the desired warmstart program, enter an M to bring up the Maintenance Options display shown in display II-1-2 and complete the following steps.

If the coldstart/warmstart program is already stored in microprocessor random access memory (RAM):

- a. Retrieve the coldstart program by entering GP n and then pressing the carriage return key. n is the RAM program number (0 through 2 octal).
 - b. Skip steps 3 and 4.
3. Enter the coldstart/warmstart program (figure II-1-8) using the console keyboard.
 4. Enter SP n if you want to store your program in RAM for future use. n (0 through 3 octal) is the RAM program number.
 5. Coldstart the disk controller by entering either S or L then pressing the carriage return key. The Initial Options display appears.

Coldstart 639 Tape Unit From Tape

Use the following procedure to coldstart a 639 Intelligent Small Tape Unit (ISMT) on a model 810, 830, or 990. This procedure is to be used when mainframe power has been turned off and the subsequent deadstart is to be from a tape unit. A coldstart loads peripheral microcode (controlware) from the CIP tape into the tape unit adapter. Once the tape unit has been coldstarted, the warmstart procedure, described previously, should be followed.

1. Apply power to the system and 639 tape unit.
2. Mount the CIP tape on the tape unit.
3. Ensure that the tape unit is placed on line.

4. If the system console is a CC634B display terminal, press the RESET button to reinitialize the system console. If the CC634B console has never been initialized, complete the steps given in appendix I to initialize the console.
5. Complete the following steps to bring up the Deadstart Options display shown in display II-1-1. When using a CC634B console:
 - a. Hold down the CTRL key while pressing the G key.
 - b. When the message *OPERATOR ACCESS ENABLED appears on the screen, hold down the CTRL key while pressing the R key.

Press the Deadstart button on the console when using a CC545 console.

6. Enter M to bring up the Maintenance Options display shown in display II-1-2.
7. If the coldstart program is already stored in microprocessor RAM:
 - a. Retrieve the coldstart program by entering GP n then pressing the carriage return key. n is the RAM program number (0 through 2 octal).
 - b. Skip steps 8 and 9.
8. Enter the coldstart program shown in figure II-1-9 or figure II-1-10 using the console keyboard.

Program entry is done by entering xx yyyyyy then pressing the carriage return key. xx (1 through 20 octal) is the location and yyyyyy (octal) is the instruction. The first two digits of the instruction should be zeros; however, leading zeros, both in the location and in the instruction, do not have to be entered. If you want the system to add an increment to the location automatically, enter xx+yyyyyy. When the automatic increment is in effect, the system displays the next location after accepting the previous entry. Then enter only the instruction. To terminate the automatic increment, press the erase key after the location appears.

9. Enter SP n if you want to store your program in RAM for future use. n (0 through 2 octal) is the RAM program number.
10. Coldstart as follows when using a CC634B console:
 - a. Hold down the CTRL key while pressing the G key.
 - b. Hold down the CTRL key while pressing the R key.

Press the Deadstart button on the console when using a CC545 console.

- c. Enter S to coldstart the tape unit. Upon receipt of the 60u function, the tape unit adapter:
 - Executes internal diagnostics.
 - Connects to the 639 ISMT.
 - Rewinds the tape unit.
 - Reads the 639 microcode record from tape.
 - Verifies the microcode ID and revision level.

- Performs a checksum of the microcode.
- Executes the microcode diagnostics.
- Rewinds the tape if all of the preceding items execute properly.

You will see the message SYSTEM INITIALIZATION IN PROGRESS.

To verify proper loading of the microcode or to identify the cause of a bad load, complete the following steps.

1. Wait for tape motion to stop or wait about 10 seconds if the tape did not move; then bring up the Deadstart Options display shown in display II-1-1. When using a CC634B console:
 - a. Hold down the CTRL key while pressing the G key.
 - b. Hold down the CTRL key while pressing the R key.

Press the deadstart button on the console when using a CC545 console.

2. Enter M to bring up the Maintenance Options display shown in display II-1-2.
3. Enter PR then press the carriage return key to bring up the PP Register display.
4. Examine the PP 00 line of the display. If P equals 0016, enter PM then press the carriage return key to bring up the PP Memory display. If location 0030 equals 1000, the microcode is loaded and initialized correctly and the tape unit is ready to use.

NOTE

This display shows the contents of PP registers for barrel 0. Press the + key to display the PP registers for barrel 1 if you have reconfigured PPs using the RB command.

5. If P does not equal 0016 on the PP Register display, or location 0030 does not equal 1000 on the PP Memory display, an error has occurred. Recheck the entries in the deadstart program and the status of the hardware to ensure you did not make an error when following the procedure. Retry the procedure, and if you are still unsuccessful, call a CE for help.

SETTING THE DEADSTART PANEL FOR A COLDSTART

The deadstart panel (for all models of the CYBER 170 Computer System except models 815, 825, 835, 845, and 855) contains a 16-by-12 matrix of toggle switches (see figure II-1-1). The matrix rows are numbered from 1 to 20₈. The CYBER 70 and 6000 Computer Systems deadstart panel (see figure II-1-2) contains a 12-by-12 matrix with rows numbered from 0001 to 0014₈.

Each row of switches represents a 12-bit PP instruction word in the deadstart program. Thus, by setting these switches in a prescribed manner, you create the program necessary to deadstart; this deadstart program is subsequently loaded into PPO memory. It is executed whenever you press the deadstart button.

The deadstart program:

- Identifies the tape/disk unit, controller, and channel number to be used to access the deadstart device (specified in words 1 through 10).
- Reads the first record from the deadstart file. This routine initiates the processing of the remainder of the deadstart file according to the options specified in the deadstart program (word 13).

Models 835 through 860 deadstart panel (see figure II-1-3) contains a 16-by-16 matrix of toggle switches with rows numbered from 1 to 20g. To deadstart model 835, set the four leftmost columns of switches (columns 2¹² through 2¹⁵) to the down position.

NOTE

All switches in columns 2¹² through 2¹⁵ must be in the down position for proper operation of models 835 through 860.

Use the 12 rightmost columns to set the 12-bit PP instruction words that are the deadstart program; this program is subsequently loaded into PPO memory. It is executed whenever you press the deadstart button.

For models 835 through 860, select one of these deadstart options:

<u>Option</u>	<u>Action</u>
No testing	Set the LONG/SHORT DEADSTART SEQUENCE switch to the down (short) position.
Confidence testing	Set the LONG/SHORT DEADSTART SEQUENCE switch to the up (long) position. This option destroys some information in PP memory (refer to Performing an Express Deadstart Dump in part II, section 2).
Extended deadstart testing	Set the LONG/SHORT DEADSTART SEQUENCE switch to the up (long) position and set the rightmost bit (2 ⁰) of word 12 to the up position. This option destroys some information in PP memory (refer to Performing an Express Deadstart Dump in part II, section 2).

For normal operator deadstarts, performing the confidence test and extended deadstart test is not necessary. These tests are usually done after maintenance is performed on the system. Refer to the appropriate hardware reference manual for more information on extended deadstart testing.

In the illustrations of the deadstart panel that accompany the following descriptions, switch position 1 (switch in up position) and switch position 0 (switch in down position) are mandatory settings. The switch positions for fields represented by alphabetic characters, however, are determined by each installation. Octal values entered on the models 810, 815, 825, 830, and 990 deadstart displays appear to the right of the panel illustrations.

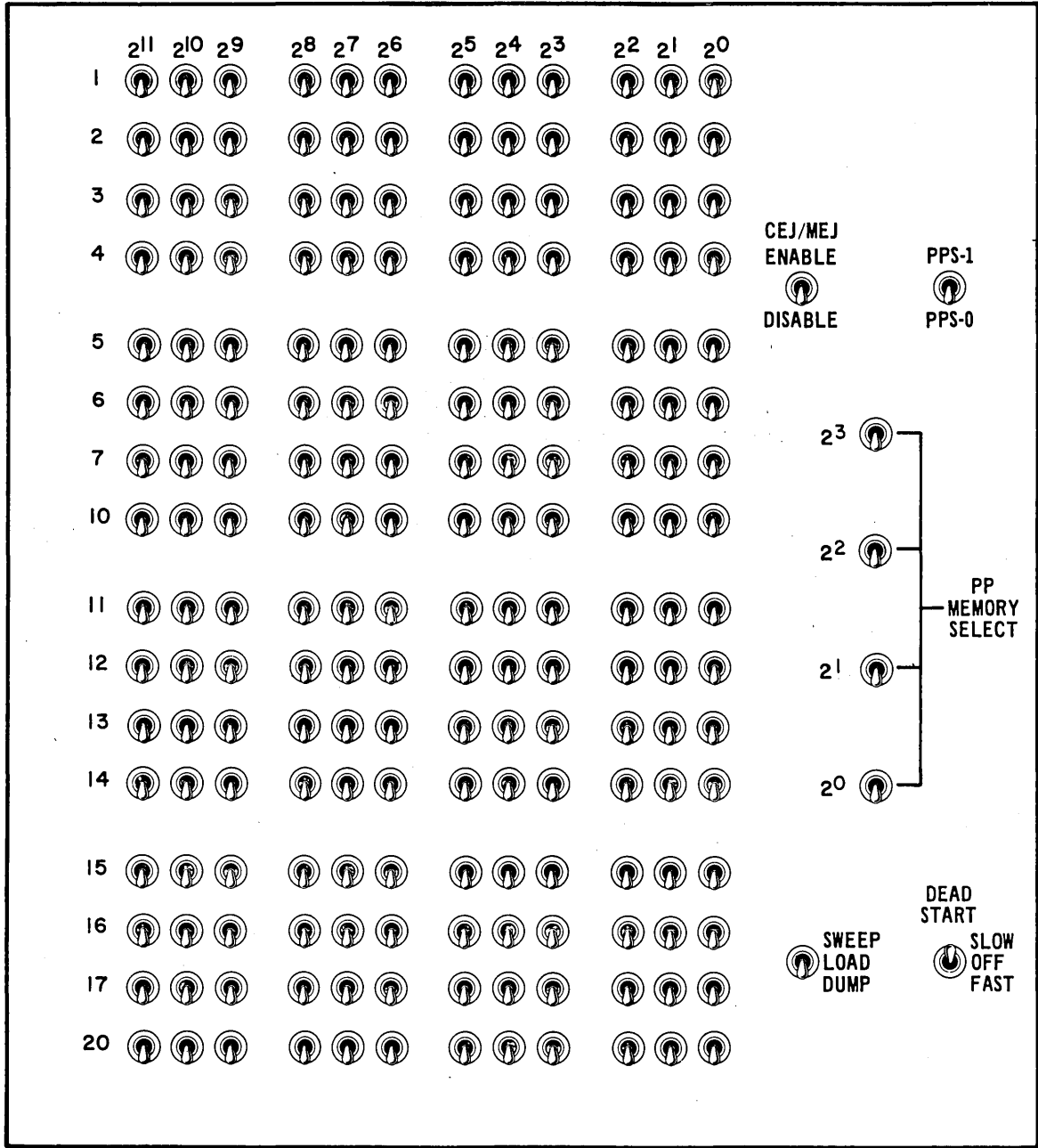

Figure II-1-1. CYBER 170 Computer Systems
(Except Models 815, 825, 835, 845, and 855) Deadstart Panel

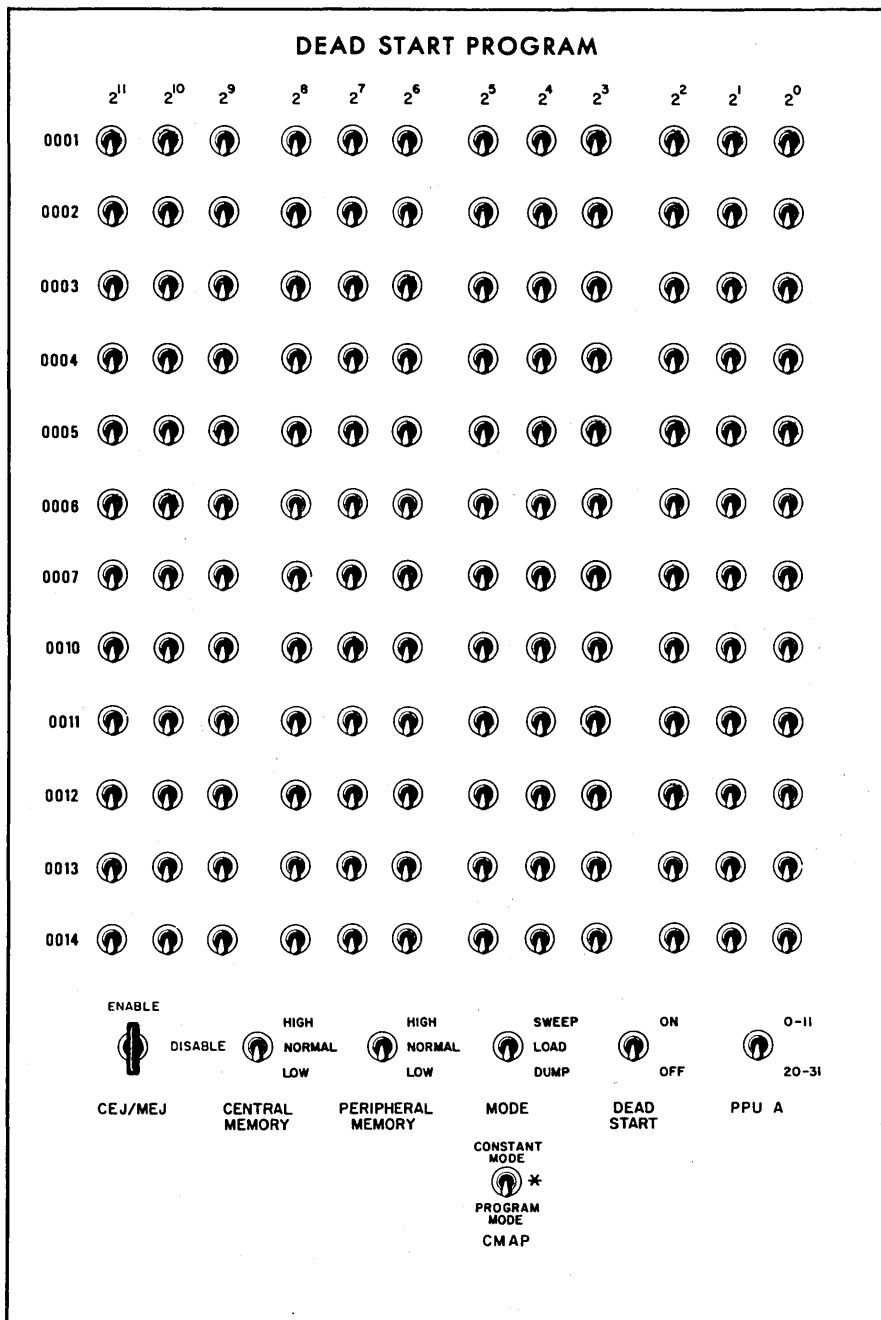

Figure II-1-2. CYBER 70/6000 Computer Systems Deadstart Panel

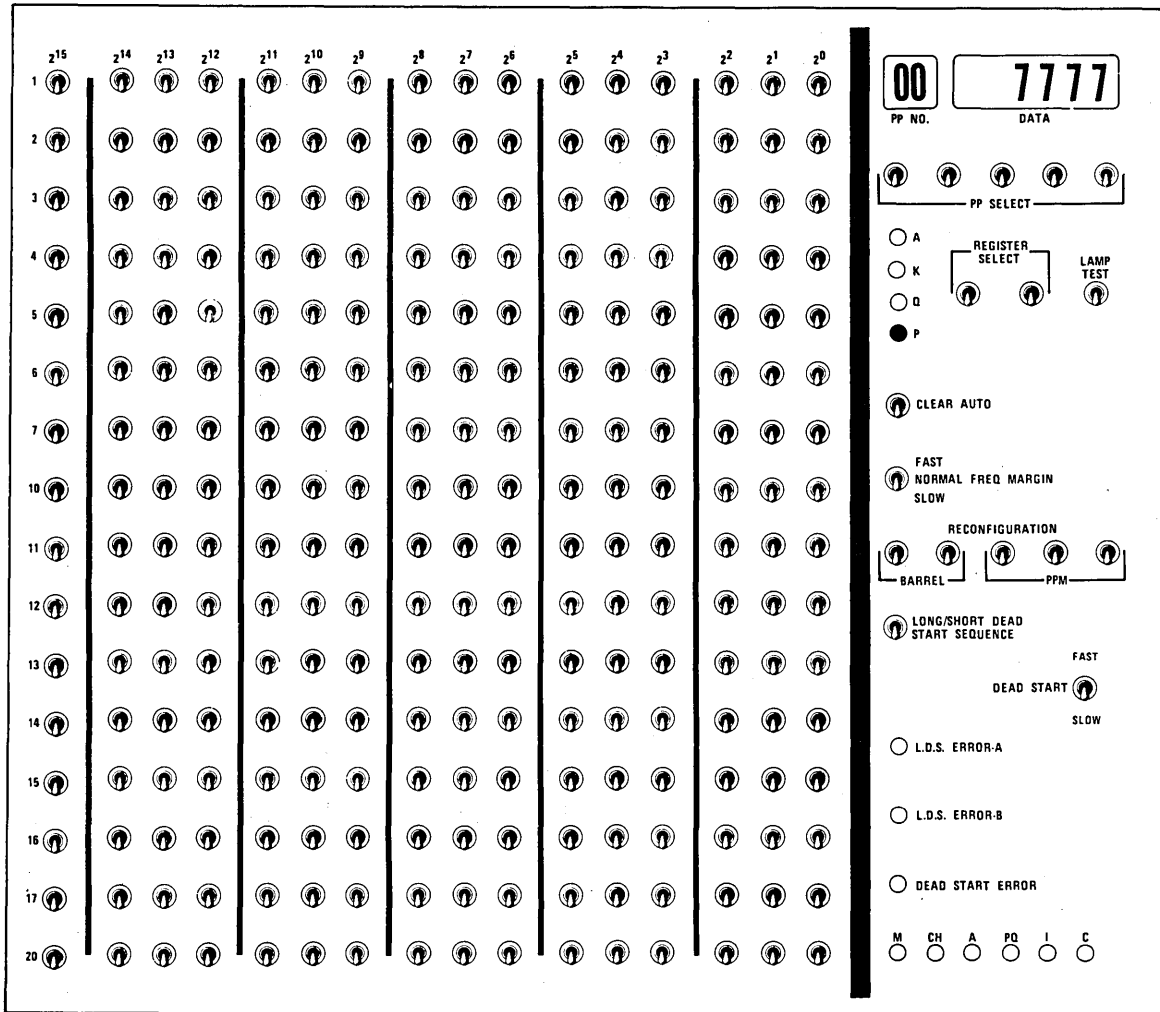

Figure II-1-3. Models 835 through 860 Deadstart Panel

NOTE

Before pressing the deadstart button, set the mode switch on the deadstart panel to LOAD (for all systems except models 810 through 860 and 990) and set the CMAP switch to CONSTANT MODE (for the CYBER 70 and 6000 Computer Systems).

For all computer systems except models 810 through 860 and 990, the CEJ/MEJ option is logically enabled by default. NOS does not run if the CEJ/MEJ option is disabled. For models 810 through 860 and 990, CEJ/MEJ is permanently enabled. You cannot turn it off.

For all computer systems except models 810 through 860 and 990, if there is no CEJ/MEJ switch or key or if it is physically set to the disable position on the deadstart panel and you do not logically override it via the Hardware Reconfiguration display (refer to the Operator Intervention display for your model of computer system), the system displays the following error message after you press the final carriage return for the the CTI options:

CEJ/MEJ OPTION NOT ENABLED
FOR CEJ/MEJ USAGE, ENABLE SWITCH
ON DEADSTART PANEL AND DEADSTART

(CR) FOR NON CEJ/MEJ USAGE

To choose the CEJ/MEJ option, enable the switch or key on the deadstart panel and deadstart again.

The preceding display also appears if the CEJ/MEJ switch or key fails, and you have not logically disabled it.

NOTE

For CYBER 70 and 6000 Computer Systems, turn the CEJ/MEJ key fully counterclockwise to enable CEJ/MEJ. Turn the key fully clockwise to disable CEJ/MEJ.

Descriptions of the panel settings for coldstart of tape and disk controllers and for the panel settings for word 13 of the deadstart panel follow.

Panel Settings for Coldstart of 7021/7152 Tape Controller From Card Reader

During coldstart from a card reader, the deadstart program:

- Identifies the controller and channel number used to access the card reader from which the controlware is to be read.
- Specifies the controller, channel, and unit number of the tape unit on which the deadstart tape is mounted.
- Reads the controlware card deck (this deck loads the tape controller).
- Processes the deadstart tape according to the options specified on the deadstart panel.

You identify the equipment necessary for the devices used during coldstart by setting the switches shown in the unshaded area of the deadstart panel (see figure II-1-4). This includes both the channel and controller number associated with the card reader and the channel, controller, and unit number of the tape unit.

	<u>Binary</u>				<u>Octal</u>
1	111	101	1cc	ccc	75cc
2	111	111	0cc	ccc	77cc
3	fff	000	000	000	f000
4	000	000	000	000	0000
5	111	111	0cc	ccc	77cc
6	001	100	000	000	1400
7	111	100	0cc	ccc	74cc
10	111	001	0cc	ccc	71cc
11	111	110	110	100	7664
12	000	000	0tt	ttt	00tt†
13	rrr	ppp	xxx	xxx	rpxx††
14	eee	010	11u	uuu	e2uu

† Refer to Setting Word 12 later in this section for information on performing deadstart testing for models 835, 845, and 855.
†† The instructions for setting the bits represented by these parameters are given under Setting Word 13 later in this section.

Figure II-1-4. Coldstart of 7021/7152 Tape Controller From Card Reader

Descriptions of the deadstart panel parameters follow.

<u>Parameter</u>	<u>Description</u>
cc ccc	Channel number used to access the card reader from which the controlware is to be read.
fff	Controller number to which the card reader is connected.
tt ttt	Channel number used to access the deadstart tape equipment.
rrr	Deadstart level.
ppp	Deadstart parameters.
xxx xxx	CMRDECK number (NOS), CMR number (NOS/BE).
eee	Controller number to which the tape unit is connected.
u uuu	Physical unit number of the tape unit on which the deadstart tape is mounted.

The card reader and the tape unit on which the deadstart tape is mounted must be on different channels. The card reader must be on a channel without a PP (for example, channel 12 or 13). Refer to appendix F to determine which channels in your hardware configuration do not have PPs.

The numbers are entered in binary form; each switch represents a bit in a 12-bit PP instruction word.

Refer to Setting Word 13 later in this section for detailed information on word 13 parameters. For models 835 through 860, set the four leftmost bit positions for each row to 0 (they are not shown in figure II-1-4).

After a successful coldstart, it is advised that you immediately reset the deadstart panel for a warmstart.

If the tape subsystem is functioning properly, there is no need to perform another coldstart after initially loading the controlware.

Panel Settings for Coldstart of 7152 Tape Controller From Tape Unit

During coldstart from a tape unit, the deadstart program:

- Identifies the channel and unit number of the tape unit on which the controlware tape is mounted and to be read.
- Reads the controlware tape, which loads the tape controller.

You identify the tape unit and the channel used to access the unit by setting the switches shown in the unshaded area of the deadstart panel (see figure II-1-5). The tape unit number must be between 10 and 17, and the unit must be on a channel without a PP (for example, channel 12 or 13). Refer to appendix F to determine which channels in your hardware configuration do not have PPs.

The numbers are entered in binary form; each switch represents a bit in a 12-bit PP instruction word. The remainder of the panel is not used. For models 810 through 860 and 990, set the four leftmost bit positions for each row to 0 (they are not shown in figure II-1-5).

Unloading of the controlware tape indicates that the controlware was loaded successfully. It is necessary to reset the deadstart panel for a warmstart immediately in order to proceed with loading the system deadstart tape.

	<u>Binary</u>				<u>Octal</u>
1	111	101	1tt	ttt	75tt
2	011	110	001	101	3615
3	001	000	001	100	1014
4	001	111	000	001	1701
5	000	101	111	110	0576
6	111	111	1tt	ttt	77tt
7	000	000	1tu	uuu	00uu
10	000	011	000	000	0300

Figure II-1-5. Coldstart of 7152 Tape Controller From Tape Unit

Descriptions of the deadstart panel parameters follow.

<u>Parameter</u>	<u>Description</u>
tt ttt	Channel number that accesses the controlware tape equipment.
u uuu	Physical unit number of the tape unit on which the controlware is mounted.

Panel Settings for Coldstart of 7054/7154/7152/7155/7165 Disk Controller From Card Reader

During coldstart from a card reader, the deadstart program:

- o Identifies the controller and channel number that accesses the card reader from which the controlware is to be read.
- o Specifies the controller, channel, and unit number of the drive on which the deadstart disk is mounted.
- o Reads the controlware card deck (this deck loads the disk controller).
- o Processes the deadstart tape according to the options specified on the deadstart panel.

You identify the equipment necessary for the devices used during coldstart by setting the switches shown in the unshaded area of the deadstart panel (see figure II-1-6). This includes the channel number and controller associated with the card reader and the channel, controller, and unit number of the disk unit.

The card reader and the drive on which the deadstart disk is mounted must be on different channels. The card reader must be on a channel without a PP (for example, channel 12 or 13). Refer to appendix F to determine which channels in your hardware configuration do not have PPs.

	<u>Binary</u>				<u>Octal</u>
1	111	101	1cc	ccc	75cc
2	111	111	0cc	ccc	77cc
3	fff	000	000	000	f000
4	000	000	000	000	0000
5	111	111	0cc	ccc	77cc
6	001	100	000	000	1400
7	111	100	0cc	ccc	74cc
10	111	001	0cc	ccc	71cc
11	111	110	110	100	7664
12	000	000	0tt	ttt	00tt †
13	rrr	ppp	xxx	xxx	rpxx ††
14	eee	011	uuu	uuu	e3uu

† Refer to Setting Word 12 later in this section for information on performing deadstart testing for models 835 through 860.
†† The instructions for setting the bits represented by these parameters are given under Setting Word 13 later in this section.

Figure II-1-6. Coldstart of Disk Controller From Card Reader

Descriptions of deadstart panel parameters follow.

<u>Parameter</u>	<u>Description</u>
cc ccc	Channel number used to access the card reader from which the controlware is to be read.
fff	Controller number to which the card reader is connected (4, 5, 6, or 7).
tt ttt	Channel number used to access the deadstart disk equipment.
rrr	Deadstart level.
ppp	Deadstart parameters.
xxx xxx	CMRDECK number (NOS), CMR number (NOS/BE).
eee	Controller number to which the disk unit is connected.
uuu uuu	Physical unit number of the drive on which the deadstart disk is mounted.

NOTE

When deadstarting from a 7054 or 7154 disk controller, incorrect panel settings, such as channel or unit numbers, can hang the controller. To free the controller, correct the panel settings and master clear the controller by pressing in the following sequence, the STOP, MASTER CLEAR, and GO buttons located inside the controller chassis.

The numbers are entered in binary form; each switch represents a bit in a 12-bit PP instruction word. For models 835 through 860, set the four leftmost bit positions for each row to 0 (they are not shown in figure II-1-6).

Refer to Setting Word 13 later in this section for detailed information on word 13 parameters.

After coldstart, it is advised that you immediately reset the deadstart panel for a warmstart.

If the disk subsystem is functioning properly, there is no need to perform another coldstart after initial loading of the controlware.

Panel Settings for Coldstart of 7152/7155/7165 Disk Controller From Disk Unit

During coldstart from a disk unit, the deadstart program:

- Identifies the controller and channel number used to access the disk unit from which the controlware is to be read.
- Specifies the controller, channel, and unit number of the drive on which the deadstart disk is mounted.
- Reads the controlware (this controlware loads the disk controller).
- Processes the deadstart file according to the options specified on the deadstart panel.

The equipment necessary for the devices used during coldstart is identified by setting the switches shown in the unshaded area of the deadstart panel (see figure II-1-7). This includes the channel number and controller associated with the disk unit and the channel, controller, and unit number of the drive.

	<u>Binary</u>				<u>Octal</u>
1	000	000	000	000	0000
2	111	101	1tt	ttt	75tt
3	111	111	0tt	ttt	77tt
4	eee	001	vvv	vvv	e1vv
5	111	111	0tt	ttt	77tt
6	eee	011	uuu	uuu	e3uu
7	111	100	0tt	ttt	74tt
10	111	001	0tt	ttt	71tt
11	111	011	000	001	7301
12	000	000	000	000	0000
13	rrr	ppp	xxx	xxx	rpxx†
14	000	000	000	000	0000

†The instructions for setting the bits represented by these parameters are given under Setting Word 13 later in this section.

Figure II-1-7. Coldstart of 7152/7155/7165 Disk Controller From Disk Unit

Descriptions of the deadstart panel parameters follow.

<u>Parameter</u>	<u>Description</u>
tt ttt	Channel number used to access the deadstart disk equipment.
eee	Controller number to which the disk unit is connected.
vvv vvv	Physical unit number of the disk drive from which the coldstart operation is to be completed.
uuu uuu	Physical unit number of the disk drive from which the warmstart operation is to be completed.
rrr	Deadstart level.
ppp	Deadstart parameters.
xxx xxx	CMRDECK number (NOS), CMR number (NOS/BE).

The disk unit must be on a channel with no PP (for example, channel 0, 12, or 13). Refer to appendix F to determine which channels in your hardware configuration do not have PPs.

The numbers are entered in binary form; each switch represents a bit in a 12-bit PP instruction word. For models 835 through 860, set the four leftmost bit positions for each row to 0 (they are not shown in figure II-1-7).

Refer to Setting Word 13 later in this section for detailed information on word 13 parameters.

After a successful coldstart, you should immediately reset the deadstart panel for a warmstart.

If the disk subsystem is functioning properly, there is no need to perform another coldstart after initial loading of the controlware.

Deadstart Program for Coldstart/Warmstart of 834/836 Disk Controller From Disk Unit

Use the program shown in figure II-1-8 when coldstarting and warmstarting an 834 or 836 disk controller on a model 810, 815, 825, 830, or 990 computer system.

	<u>Binary</u>				<u>Octal</u>
1	000	000	000	000	0000
2	111	101	1cc	ccc	75cc
3	111	111	0cc	ccc	77cc
4	000	001	uuu	Odd	01ud
5	111	111	0cc	ccc	77cc
6	000	101	uuu	Odd	05ud
7	111	100	0cc	ccc	74cc
10	111	001	0cc	ccc	71cc
11	111	011	000	001	7301
12	000	mmm	001	000	0m10
13	rrr	ppp	xxx	xxx	rpxx
14	000	000	000	000	0000
15	000	000	000	000	0000
16	000	000	000	000	0000
17	000	000	000	000	0000
20	111	001	001	010	7112

Figure II-1-8. Coldstart/Warmstart of 834/836 Disk From Disk Unit

Descriptions of the deadstart panel parameters follow.

<u>Parameter</u>	<u>Description</u>						
cc ccc	Channel number used to access the disk subsystem.						
uuu	Control module number (0 through 7).						
dd	Disk unit number (0 through 3).						
m	Defines memory as follows: <table border="0" style="margin-left: 40px;"> <tr> <td>1 = 1 Mbyte</td> <td>4 = 8 Mbytes</td> </tr> <tr> <td>2 = 2 Mbytes</td> <td>5 = 16 Mbytes</td> </tr> <tr> <td>3 = 4 Mbytes</td> <td>6 = 32 Mbytes</td> </tr> </table>	1 = 1 Mbyte	4 = 8 Mbytes	2 = 2 Mbytes	5 = 16 Mbytes	3 = 4 Mbytes	6 = 32 Mbytes
1 = 1 Mbyte	4 = 8 Mbytes						
2 = 2 Mbytes	5 = 16 Mbytes						
3 = 4 Mbytes	6 = 32 Mbytes						
rpxx	The instructions for setting the bits represented by these parameters are given under Setting Word 13 later in this section.						

Deadstart Program for Coldstart of 639 Tape Unit Controller From Tape

Use one of the programs shown in figures II-1-9 and II-1-10 when coldstarting a 639 tape unit controller on a model 810, 830, or 990 computer system.

	<u>Binary</u>				<u>Octal</u>
1	011	100	000	010	1402
2	111	011	0tt	ttt	73tt
3	000	000	001	111	0017
4	111	101	1tt	ttt	75tt
5	111	111	0tt	ttt	77tt
6	000	110	000	uuu	060u
7	001	101	000	000	1500
10	011	100	011	000	3430
11	111	111	0tt	ttt	77tt
12	000	000	001	010	0012
13	111	100	0tt	ttt	74tt
14	111	001	0tt	ttt	71tt
15	000	000	011	000	0030
16	000	011	000	000	0300
17	000	000	000	000	0000
20	111	001	001	010	7112

Notation	Description
tt ttt	Channel number used to access tape unit.
uuu	Tape unit number (0 through 3).

Figure II-1-9. Coldstart of 639 Tape Unit From Tape on Channel With a PP

	<u>Binary</u>				<u>Octal</u>
1	000	000	000	000	0000
2	000	000	000	000	0000
3	000	000	000	000	0000
4	111	101	1tt	ttt	75tt
5	111	111	0tt	ttt	77tt
6	000	110	000	uuu	060u
7	001	101	000	000	1500
10	011	100	011	000	3430
11	111	111	0tt	ttt	77tt
12	000	000	001	010	0012
13	111	100	0tt	ttt	74tt
14	111	001	0tt	ttt	71tt
15	000	000	011	000	0030
16	000	011	000	000	0300
17	000	000	000	000	0000
20	111	001	001	010	7112

Notation	Description
tt ttt	Channel number used to access tape unit.
uuu	Tape unit number (0 through 3).

Figure II-1-10. Coldstart of 639 Tape Unit From Tape on Channel With No PP

WARMSTART PROCEDURE SUMMARY

Warmstart is the deadstart procedure used when the controlware is loaded and functioning properly. Figure II-1-11 illustrates the warmstart procedure. Detailed information concerning all phases of the deadstart process follows.

The following steps summarize the procedures necessary to perform warmstart from a 639/66X/67X magnetic tape unit, 834/836 disk unit, 844 disk unit, or 885-11/12 disk unit. Use this as a checklist during warmstart.

For models 810, 815, 825, 830, and 990, steps 3 and 4 must be interchanged. For more complete information, refer to Warmstart Procedure for Models 810, 815, 825, 830, and 990 later in this section.

1. Ensure that required mass storage devices are available and that they have packs mounted.
2. Mount the deadstart tape or pack.
3. Set the deadstart panel for warmstart (refer to Setting the Deadstart Panel for a Warmstart later in this section).
 - a. Select the correct deadstart function.
 - b. Select the correct CMRDECK.
4. Press the deadstart button on a CC545, or when a CC634B display terminal is being used as the primary operator console, complete the following steps to bring up the Maintenance Options display shown in display II-1-2:
 - a. Press the RESET button to reinitialize the console.
 - b. Hold down the CTRL key while pressing the G key.
 - c. When the message *OPERATOR ACCESS ENABLED appears on the screen, hold down the CTRL key while pressing the R key.
 - d. For models 810, 830, and 990, enter S to bring up the Maintenance Options display.

If deadstarting from a spun-down 834 or 836 disk unit, the initial display will not appear until the drive has completed spinning up (about 30 seconds).

5. Select the correct CTI options.

NOTE

The CC634B console is supported as the primary console for models 835 through 860 with the limitation that a deadstart (CTRL-G, CTRL-R) cannot be performed. To select the CC634B as the primary console you must set bit 2 of deadstart panel word 12 to a one. You then initiate a deadstart by using either the CC545 deadstart button or the deadstart switch on the deadstart panel.

Continue with operating system initialization or MSL loading as described in the appropriate operating system operator's guide or MSL manuals.

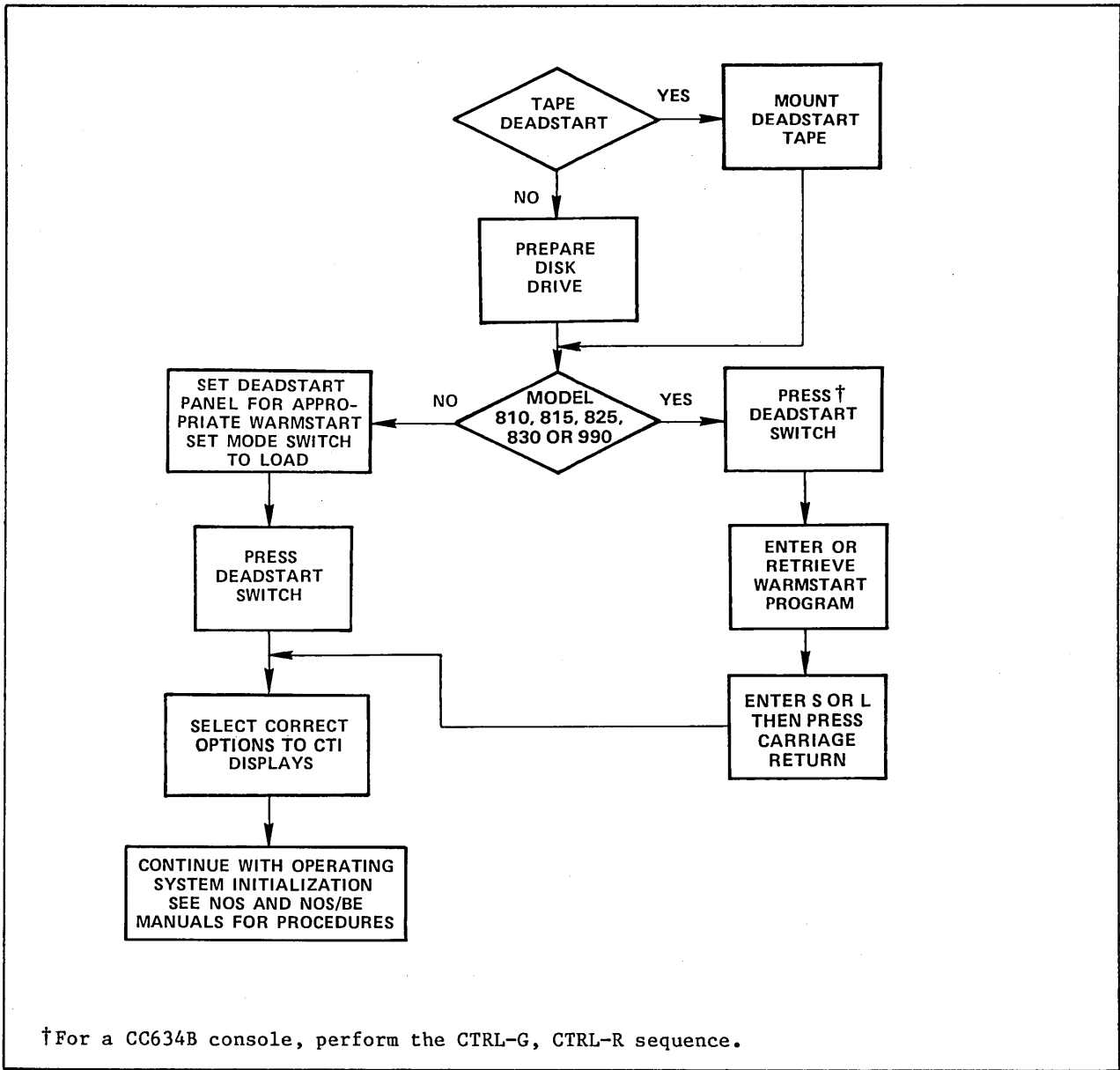

Figure II-1-11. Warmstart

WARMSTART PROCEDURE FOR MODELS 810, 815, 825, AND 830

The procedure to warmstart models 810, 815, 825, 830, and 990 is similar to other computer systems except that models 810, 815, 825, 830, and 990 do not have a deadstart panel. The warmstart programs represented by the deadstart panel switch settings on a model 835, 840, 845, 850, 855, and 860 are entered through the model 810, 815, 825, 830, and 990 console keyboard as octal numbers. Warmstart programs for the models 810, 815, 825, 830, and 990 are identical to those for models 835, 840, 845, 850, 855, and 860 except where specifically noted.

In the various warmstart procedures described in this section, deadstarting a model 810 or 830 brings up the Deadstart Options display shown in display II-1-1. Selecting option M on this display brings up the Maintenance Options display shown in display II-1-2. Selecting option S or pressing the carriage return key brings up the Initial Options display (refer to part I, section 2). Deadstarting on a model 815 or 825 brings up the Maintenance Options display shown in display II-1-2. The Deadstart Options display is not provided for models 815 and 825.

The bottom line of the Deadstart Options display (models 810, 830, and 990) identifies which deadstart program is selected and is to be executed. If this is not the desired deadstart program, enter M to bring up the Maintenance Options display.

The following paragraphs describe how to retrieve or modify the deadstart program for models 810, 815, 825, 830, and 990 using the Maintenance Options display.

If the warmstart program is already stored in the microprocessor, retrieve it by entering:

GP n

n is the number (0 through 3) of the stored program. You can change individual instructions in a program, such as unit number or other parameters, as described next. These changes are not retained across deadstarts unless this new program or a modified program is stored as described later in this section.

You can use the space bar to cycle through the stored programs. If the correct warmstart program is not stored or a new program is to be entered and stored, the program must be entered as octal numbers equivalent to the switch settings on the deadstart panels for other models.

Change the warmstart program represented by the switch settings shown in the related deadstart panel figure for your configuration by entering:

xx yyyyyy (or xx.yyyyyy, or xx,yyyyyy)

xx is octal row number of the deadstart instruction and yyyyyy is the octal number equivalent to the actual instruction. When you enter a six-digit instruction, the first two digits of the instruction must be zeros. Leading zeros in both the octal row number and the instruction, however, need not be entered. For example, if the row number was 03 and the instruction was 000017 you could enter:

3 17

and get the same setting as entering:

03 000017.

If you want the system to automatically increment the octal row number, the entry after which the increment is to occur is:

xx+yyyyyy

The + character indicates that the system is to automatically increment the octal row number. When the automatic increment is in effect, the system displays the next location after accepting the previous entry. Only the next instruction need be entered.

To cancel the automatic incrementing, press the left blank (erase) key after the octal row number appears.

To store a new program or a modified program, enter:

SP n

n is the number (0 through 3) of the program to be stored. If a program is already stored at the specified number, the new program replaces it.

After entering or retrieving the desired warmstart program, enter:

S

then press the carriage return key for a short deadstart sequence, or enter:

L

then press the carriage return key for a long deadstart sequence.

When system power is applied to a model 810, 815, 825, or 830 mainframe, the microprocessor automatically retrieves the warmstart program stored as program number 3 and initiates a long deadstart sequence. If you want this feature, store the warmstart program for your configuration as program number 3. If you do not want this feature, store the first word of program 3 as 000300. This instruction puts the program in PP0 into a loop. No deadstart activity occurs and no displays appear on the screen. You must press the deadstart button to bring up the initial deadstart display. You can then retrieve or enter the warmstart program you wish, and select a short or long deadstart sequence.

SETTING THE DEADSTART PANEL FOR A WARMSTART

There are two types of warmstart panel settings: one for a deadstart device connected to a channel with a PP and the other for a device connected to a channel without a PP. When the device is connected to a channel with a PP, two panel settings are different because CYBER 70/6000 panels have fewer switches.

NOTE

When deadstarting from a 7054 or 7154 disk controller, incorrect panel settings, such as channel or unit numbers, can hang the controller. To free the controller, correct the panel settings and master clear the controller by pressing, in the following sequence, the STOP, MASTER CLEAR, and GO buttons located inside the controller chassis.

The deadstart device on which the deadstart tape or disk pack is mounted, its associated controller, and the channel used to access this equipment are identified by setting the switches shown in the unshaded area of the deadstart panels illustrated in figures II-1-12, II-1-13, and II-1-14 (refer to appendix F to determine which channels in your hardware configuration do not have PPs).

	<u>Binary</u>				<u>Octal</u>
1	001	100	000	010	1402
2	111	011	0tt	ttt	73tt
3	000	000	001	111	0017
4	111	101	1tt	ttt	75tt
5	111	111	0tt	ttt	77tt
6	eee	ddd	ddd	ddd	eddd
7	111	100	0tt	ttt	74tt
10	111	001	0tt	ttt	71tt
11	111	011	000	001	7301
12	000	000	000	cfa	0000
13	rrr	ppp	xxx	xxx	rp [†] xx
14	000	000	000	000	0000
15	000	000	000	000	0000
16	000	000	000	000	0000
17	000	000	000	000	0000
20	111	001	001	010	7112

[†]The instructions for setting the bits represented by these parameters are given under Setting Word 13 later in this section.

Figure II-1-12. CYBER 170 and CYBER 180 Computer Systems Panel Settings for Warmstart From Channel With a PP (For Example, Channel 1, 2, or 11)

	<u>Binary</u>				<u>Octal</u>
1	001	100	000	010	1402
2	111	011	0tt	ttt	73tt
3	000	000	001	011	0013
4	111	101	1tt	ttt	75tt
5	111	111	0tt	ttt	77tt
6	eee	ddd	ddd	ddd	eddd
7	111	100	0tt	ttt	74tt
10	111	001	0tt	ttt	71tt
11	111	011	000	001	7301
12	rrr	ppp	xxx	xxx	rp [†] xx
13	000	000	000	000	0000
14	111	001	001	010	7112

[†]The instructions for setting the bits represented by these parameters are given under Setting Word 13 later in this section.

Figure II-1-13. CYBER 70 and 6000 Computer Systems Panel Settings for Warmstart From Channel With a PP (For Example, Channel 1, 2, or 11)

	<u>Binary</u>				<u>Octal</u>
1	000	000	000	000	0000
2	000	000	000	000	0000†
3	000	000	000	000	0000†
4	111	101	1tt	ttt	75tt†
5	111	111	0tt	ttt	77tt
6	eee	ddd	ddd	ddd	eddd††
7	111	100	0tt	ttt	74tt
10	111	001	0tt	ttt	71tt
11	111	011	000	001	7301
12	000	000	000	cfa	0000
13	rrr	ppp	xxx	xxx	rpxx†††
14	000	000	000	000	0000

†If a 6681 data channel converter is the first equipment on the channel, or if it precedes the deadstart device controller, words 2, 3, and 4 must be set as follows:

	<u>Binary</u>				<u>Octal</u>
2	111	101	1tt	ttt	75tt
3	111	111	0tt	ttt	77tt
4	010	001	000	000	2100

††eddd for tape; dddd for disk deadstart.
†††The instructions for setting the bits represented by these parameters are given under Setting Word 13 later in this section.

Figure II-1-14. Panel Settings for Warmstart
From Channel With No PP (For Example, Channel 0, 12, or 13)

Descriptions of the deadstart panel parameters follow.

<u>Parameter</u>	<u>Description</u>
tt ttt	Channel number used to access the deadstart equipment.
eee	Controller number to which the deadstart tape unit is connected.
ddd ddd ddd	Tape deadstart function; depends on device type as follows:
001 0lu uuu	639 tape units.
010 1lu uuu	66X tape units.
001 0lu uuu	677 tape units at 800 cpi and 679 tape units.
011 0lu uuu	677 tape units at 556 cpi.
u uuu	represents the physical unit number on which the deadstart tape is mounted.

<u>Parameter</u>	<u>Description</u>
ddd ddd ddd ddd	Disk deadstart function; depends on device type as follows.
000 011 uuu uuu	844 or 885-11/12 disk units.
000 011 ccc uuu	834 or 836 disk units. Control module self-checking diagnostics are executed. The initial options display usually appears in from 15 to 30 seconds.
000 101 ccc uuu	834 or 836 disk units. Control module self-checking diagnostics are not executed. The initial options display appears instantly.
011 011 uuu uuu	895 disk units.
	uuu uuu or uuu represents the physical unit number on which the deadstart disk is mounted. ccc represents the physical control module equipment number of the control module connected to the deadstart disk.
c	Specifies whether system displays are to appear on the CC545 or the CC634B.
f	If set, specifies that CTI does not initialize the alternate PP.
a	Specifies extended deadstart sequence option for models 810 through 860.
rrr	Deadstart level.
ppp	Deadstart parameters.
xxx xxx	CMR number (NOS/BE) or CMRDECK number (NOS).

The numbers are entered in binary form; each switch represents a bit in a 12-bit PP instruction word. For models 810 through 860, you must set the four leftmost bit positions for each row to 0 (they are not shown in figures II-1-12 and II-1-14).

Refer to Setting Word 13 later in this section for detailed information on word 12 (CYBER 70 and 6000 Computer Systems) and Word 13 parameters.

SETTING WORD 12

The f field in word 12 of the deadstart program allow you to enter the model type that HIVS/MSL 15X uses to select extended deadstart testing on models 810 through 860 and 990 only. A third field, a, determines whether or not the alternate PP is initialized when maintenance (M) is selected for all models of computer systems.

The switches that represent these fields are shown in the following illustration. The switches are set on the deadstart panel for models 835, 840, 845, 850, 855, and 860, or are entered as octal values through the model 810, 815, 825, 830, or 990 console.

0000	000	000	000	caf
------	-----	-----	-----	-----

Setting

Description

f Specifies the extended deadstart sequence option. If you set this bit and set the LONG/SHORT DEADSTART SEQUENCE switch on the deadstart panel to the up (long) position, (or you enter L after entering or retrieving the warmstart program for a model 810, 815, 825, or 830), the system loads and executes the extended deadstart sequence (EDS). If you do not set this bit or set the LONG/SHORT DEADSTART SEQUENCE switch to the down (short) position, (or enter S after entering or retrieving the warmstart program for a model 810, 815, 825, or 830), the extended deadstart sequence does not occur.

When this bit is set, parts of PP memories are destroyed. Refer to Performing an Express Deadstart Dump in part II, section 2 for more information.

NOTE

When you are coldstarting a tape or disk controller from a card reader, bit f is also used as part of the channel number of the card reader. Thus, the channel number of the card reader controls whether the extended deadstart sequence occurs when the LONG/SHORT DEADSTART SEQUENCE switch is in the up (long) position (you entered an L after loading the warmstart program for model 810, 815, 825, 830, or 990). If the channel number is an odd number (the 2⁰ bit is set), the extended deadstart sequence takes place. If the channel number is an even number (the 2⁰ bit is not set), the extended deadstart sequence does not take place.

c If set, specifies that the deadstart displays will appear on a CC634B console connected to port 0 of models 835 through 860. Deadstart is initiated by pressing the deadstart button on a CC545 or by using the switch on the deadstart panel. If c is clear, the deadstart is initiated at the CC545 or at the deadstart panel and the displays appear on the CC545.

Setting

Description

- a If clear when the off-line maintenance (M option) is selected from the Initial Options display, specifies that the alternate PP used for passing handoff data from CTI to the Maintenance Software Library (MSL) is to be initialized. If set when the M option is selected, CTI does not initialize the alternate PP. CTI always initializes the alternate PP when the OS load automatic (A option) or the OS load with operator intervention (O option) is selected from the Initial Options display.

SETTING WORD 13

Three unique fields exist in word 13 (word 12 on CYBER 70 and 6000 Computer Systems) of the deadstart program, which allow you to select the CMRDECK, the deadstart parameters, and the level of deadstart. The switches that represent these fields are shown in the following illustration. The switches are set on the deadstart panel for all models except models 810, 815, 825, and 830; and they are entered as octal values through the model 810, 815, 825, or 830 console.

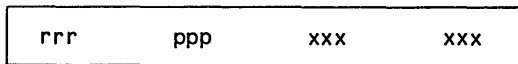

Setting

Description

- rrr Specifies the level of deadstart.
- ppp Specifies the deadstart parameters.
- xxx xxx Specifies the CMRDECK number (NOS) or CMR number (NOS/BE).

Selecting the Deadstart Level (NOS)

You can select one of four levels of deadstart by setting bits 11, 10, and 9 in word 13. The switches that represent this field of bits are shown in the unshaded area:



Value of rrr
(Bits 11-9)

Description

- 000 Indicates an initial or level 0 deadstart during which the system is loaded from the deadstart file. This is not considered a recovery deadstart although permanent files, queued files, and system dayfiles are recovered automatically unless those file types are initialized by the EQPDECK entry, INITIALIZE. If queued files are recovered, they are inactive (refer to the QREC utility in the NOS 2 Analysis Handbook for more information). An attempt to recover these files is made on all levels of system deadstart. A level 0 deadstart is normally specified:
- For the first deadstart following a period in which the system was either inoperative or used for purposes other than NOS operations.
 - When a system malfunction occurred and other levels of system deadstart prove ineffective.

If it is necessary to redeadstart the system (for example, due to system malfunction), it is recommended that you attempt a level 3 recovery deadstart. If you select level 0, the system is reloaded from the deadstart file. All central memory (except on models 810 through 860 and 990) and PP contents are destroyed by the memory confidence test.

- 001 Indicates a level 1 recovery deadstart during which the system, all jobs, and all active files are recovered from checkpoint information on mass storage. Permanent files are also recovered. You can do a level 1 deadstart only if the DSD command CHECK POINT SYSTEM (refer to the NOS 2 Operations Handbook) is successfully executed immediately prior to deadstart. A level 1 deadstart does not work if the contents of the extended memory are destroyed. Once a level 1 recovery deadstart begins, all central memory (except on models 810 through 860 and 990)[†] and PP contents are destroyed by the memory confidence test.

Normally you use a level 1 recovery deadstart to allow maintenance to be performed and then to resume normal processing. It is also useful in system test situations. Never use level 1 recovery deadstart to attempt recovery from a system malfunction or to preserve queue files.

[†]Central memory and extended memory are not destroyed on models 810 through 875 and 990 unless the V option is selected from the Operator Intervention display (refer to the Operator Intervention display for your model of computer system in part I of this manual).

Value of rrr
(Bits 11-9)

Description

010 Indicates a level 2 recovery deadstart during which all jobs and active files are recovered from checkpoint information on mass storage. No attempt is made to recover the system. Instead, the system is loaded from the deadstart file as in a level 0 deadstart. In all other respects, a level 2 recovery deadstart is identical to that described for a level 1 recovery deadstart. Once a level 2 recovery deadstart begins, all central memory (except on models 810 through 860 and 990)[†] and PP contents are destroyed by the memory confidence test.

Normally you use a level 2 recovery deadstart in system test situations; it is not recommended for the normal production environment.

011 Indicates a level 3 recovery deadstart during which all jobs, active files, and the system, with the exception of the library directory, are recovered from central memory tables. A level 3 deadstart is the only level that preserves the contents of central memory. If a deadstart level less than 3 is selected early in the deadstart process, a memory test pattern is written throughout central memory. To avoid inadvertent destruction of central memory contents when a level 3 deadstart is intended, it is recommended that you always select level 3 on the deadstart panel. If you need a deadstart level other than 3, you can specify the level by changing the Deadstart Parameters display. The library directory is recovered from mass storage. Permanent files are also recovered. A CHECKPOINT SYSTEM command must be issued prior to deadstart to prevent loss of SYSEDIT (system library modification) information. Only PP memory confidence testing occurs during a level 3 recovery deadstart; central memory is unaffected.

Normally you perform a level 3 recovery deadstart following an equipment malfunction (for example, channel or PP hung), providing central memory and mass storage remain intact. Unless you can determine that central memory is no longer reliable, you should attempt a level 3 recovery following a malfunction. If level 3 recovery fails, you must perform a level 0 deadstart.

NOTE

Attempting a level 1 or 2 recovery deadstart after a level 3 deadstart fails does not correctly recover system activity and can endanger system and permanent file integrity. You must perform a level 0 deadstart.

For additional information concerning levels of deadstart, refer to the NOS 2 Operations Handbook.

[†]Central memory and extended memory are not destroyed on models 810 through 875 and 990 unless the V option is selected from the Operator Intervention display (refer to the Operator Intervention display for your model of computer system in part I of this manual).

Selecting the Deadstart Level (NOS/BE)

You can select one of four levels of deadstart by setting bits 11, 10, and 9 in word 13. The switches that represent this field of bits are shown in the unshaded area:



Value of rrr
(Bits 11-9)

Description

000 Indicates an initial or level 0 deadstart during which the system loads the deadstart file from tape to disk before setting up the CMR libraries and directory. If CTI has been installed on a member of the system set that is turned on, you can perform an RMS deadstart on subsequent deadstarts. An RMS deadstart is not possible if the following message appears at postdeadstart:

FUTURE RMS D/S NOT POSSIBLE

For additional information about this message, refer to Entering Date and Time in the NOS/BE Operator's Guide.

Upon successful completion of a level 0 deadstart, you do not need to perform any further level 0 deadstarts.

001 Indicates a level 1 recovery deadstart, which sets the CMR libraries and directory from the deadstart file on disk. You normally specify a level 1 deadstart when:

- NOS/BE is being deadstarted after some other system has been using the mainframe.
- A system malfunction has occurred and a level 3 deadstart proves ineffective.

This level is the lowest level of deadstart that can use an RMS device as the deadstart device.

010 Indicates a level 2 recovery deadstart during which all jobs and active files are recovered from a checkpoint file on RMS. You can do a level 2 deadstart only if the DSD command CHECKPOINT was successfully processed earlier.

Extended memory contents are not saved when the system automatically enters IDLE mode. At level 627 of NOS/BE, the contents of extended memory are saved if the DSD command CHECKPOINT is entered by the operator.

You normally use a level 2 deadstart to perform maintenance and then resume normal processing. It is also useful in system test situations. A level 2 deadstart should never be used to attempt recovery from a system malfunction.

Value of rrr
(Bits 11-9)

Description

011

Indicates a level 3 recovery deadstart, which recovers the system including all jobs and active files from central memory tables.

A level 3 deadstart is the only level that preserves the contents of central memory. If a deadstart level less than 3 is selected early in the deadstart process, a memory test pattern is written throughout central memory. To avoid inadvertent destruction of central memory contents when a level 3 deadstart is intended, it is recommended that you always select level 3 on the deadstart panel. If you need a deadstart level other than 3, you can specify the level by changing the Deadstart Parameters display.

Normally you perform a level 3 recovery deadstart following an equipment malfunction (for example, channel or PP hung), providing central memory, mass storage, and extended memory remain intact. Unless you can determine that CMR, central memory, or RMS tables are not intact, or if a level 3 recovery fails, you must perform a level 1 deadstart. If the tables on the system set are inaccurate, perform a level 0 deadstart.

NOTE

Level 0 is the only level that deadstarts only from tape. In all other levels, the system can be deadstarted either from tape or disk (depending on the device selected by the deadstart panel settings). If the device is tape, any level deadstart can be performed after the warning FUTURE RMS D/S NOT POSSIBLE appears at postdeadstart time.

For additional information concerning levels of deadstart, refer to the NOS/BE Operator's Guide.

Selecting the Deadstart Parameters

You can select deadstart parameters to control miscellaneous deadstart functions by setting bits 8 through 6 in word 13. The switches that represent this field of bits are shown in the unshaded area:



Setting

Description

ppp

Specifies miscellaneous deadstart functions. Refer to table II-1-1.

Table II-1-1. Deadstart Parameters Switch Settings

Bit Number	Switch Position	Description
8	Down	Reserved for future use.
7	Down	Reserved for future use.
6=0	Down	For NOS, indicates that the CMRDECK or the level option display is not displayed during deadstart. Not used for NOS/BE.
6=1	Up	For NOS, indicates that the CMRDECK is displayed during levels 0, 1, and 2 deadstart. Level 3 options are displayed on a level 3 deadstart. Not used for NOS/BE.

When express deadstart dump dumps PP memory, the system destroys some contents of the PPO memory. You can save all the contents of the PPO memory by reconfiguring PPs. Refer to the Express Deadstart Dump option on the Utilities display for your model of computer system in part I of this manual and to appendix G for further information on how to reconfigure PPs.

Selecting the CMRDECK (NOS)

The CMRDECK defines the table sizes and other information to be used for system operations. Up to 64 CMRDECKs (numbered 0 through 778) can be included on the deadstart file.

NOTE

You can select the CMRDECK only during a level 0 (initial) deadstart. For a level 1 or 2 (recovery) deadstart, you must use the CMRDECK selected during the most recent level 0 deadstart. Refer to Selecting the Deadstart Level for either NOS or NOS/BE earlier in this section for information concerning the levels of deadstart.

The number of the selected CMRDECK is indicated by setting the switches (bits 5 through 0) in word 13 shown in the unshaded area:



<u>Setting</u>	<u>Description</u>
xxx xxx	Specifies the CMRDECK number (0 through 77g) to be used.

For example, if CMRDECK number 26g is selected, the corresponding switches on the deadstart panel are set as follows:

rrr ppp 010 110

0 indicates that the switch is in the down position; 1 indicates that the switch is in the up position. You can also specify the CMRDECK from the console keyboard by using the Deadstart Parameters display. Values entered from the Deadstart Parameters display take precedence over those specified on the deadstart panel. For example, bits 5 through 0 of word 13 on the deadstart panel (xxx xxx) could be set to select the CMRDECK most frequently used by an installation. A different CMRDECK could be selected by using the Deadstart Parameters display during a level 0 deadstart.

Selecting the CMR (NOS/BE)

The CMR defines the equipment configuration to be used for system operations. Up to 64 CMRs (numbered 0 through 77g) can be included on the deadstart file (numbered 0 through 77g). This provides an installation with the ability to select one of several equipment configurations when the system is deadstarted.

NOTE

You can select the CMR during a level 0 or level 1 deadstart. If it is necessary to perform a level 2 or level 3 deadstart, you must use the CMR number that was running at the time of the checkpoint (for a level 2 deadstart) or system malfunction (for a level 3 deadstart). Refer to Selecting the Deadstart Level for either NOS or NOS/BE earlier in this section for information concerning levels of deadstart.

The number of the CMR to be used is selected by setting the switches in word 13 (bits 5 through 0) shown in the unshaded area:



<u>Setting</u>	<u>Description</u>
xxx xxx	Specifies the CMR number (0 through 77 ₈) to be used.

For example, assume that CMR number 26₈ is to be used to define the equipment configuration at deadstart. In this case, the corresponding switches on the deadstart panel would be set as follows (0 indicates that the switch is in the down position; 1 indicates that the switch is in the up position):

xxx	xxx	010	110
-----	-----	-----	-----

It is not necessary to specify the CMR on the deadstart panel. In this case, the Deadstart Parameters display allows you to specify the CMR to be used from the console keyboard. In addition, values entered via the Deadstart Parameters display have precedence over those specified on the deadstart panel. For example, bits 0 through 5 of word 13 on the deadstart panel (xxx xxx) could be set to select the CMR most frequently used by an installation. Another CMR could then be selected when necessary using the Deadstart Parameters display during a level 0 or level 1 deadstart.

GENERAL CIP PROCEDURES

2

This section includes procedures that are generally independent of the computer system model or that apply to a range of models. Notes with the procedures indicate when model types are significant.

Most of the procedures included here use several of the displays and options offered by CIP. The starting point of a procedure is generally a deadstart operation, or a major options display such as the Initial Options display, the Utilities display, the Manual Operations display, and so forth.

EMERGENCY CIP REPAIR PROCEDURES—MODEL 800 COMPUTER SYSTEMS

If a critical problem exists with one of the CIP modules, a patch to fix the problem may be required. Patches are sent to the CE in the form of a new module, providing a critical PSR or critical TAR has been received from the site. Install the new module to the deadstart disk to replace the module with the problem. Use the individual CIP module installation procedures described next.

NOTE

The patched module is a temporary solution. Control Data will combine the patched module with the other CIP modules to form a new CIP level. The new CIP tape is then sent out as an FCO. Install the CIP FCO to the deadstart disk to replace the patched module.

Emergency CIP repair considerations:

- Manual operations can only be executed from the CIP tape.
- When manual operations options are used to install microcode or EI, the system appends an asterisk to the module name. The asterisk denotes to support personnel that the module has been modified. You display the module name by selecting option L, display CIP component information, from the Utilities display.
- Do not use the manual operations to mix components of CIPs of different levels; that is, do not install only the microcode from a new CIP.

Microcode released with the initial CIP release (November 1983) does not work with L149 (or before) CTI.

INSTALLING AN INDIVIDUAL CIP MODULE

Install the patched module using this procedure:

1. Mount the current CIP tape on a tape drive.
2. Mount the tape containing the patched module on another tape drive.
3. Set the deadstart program for a deadstart from the CIP tape.
4. Initiate deadstart. The Initial Options display appears.
5. Press the carriage return key to select the Build Deadstart Disk option. The Build Deadstart Disk display appears.
6. Enter an M to select manual operations. The Manual Operations display appears.
7. The next steps depend upon the type of module that was patched: EI, microcode, MSL, HIVS, or CTI. Use the following applicable procedure.

Replacing EI, Microcode, SCD, or MDD

1. Enter D while displaying the Manual Operations display to replace EI, microcode, System Console Driver (SCD), Monitor Display Driver (MDD), Default Parameter Block (DPB), NOS/VE modules, or the Dedicated Fault Tolerance module (DFT).
2. Enter:
 - a. The disk channel and unit number of the deadstart disk then press the carriage return key, or
 - b. The tape type, channel, equipment, and unit numbers of patched module tape then press the carriage return key.
3. Enter B to replace microcode, C to replace EI, D to replace CC634B SCD, E to replace MDD, F to replace DFT, or G to replace NOS/VE modules.
4. The patched module is installed to disk.
5. Initiate deadstart.

Replacing an MSL Module

1. Enter T while displaying the Manual Operations display to install MSL. The initial TDX display appears.
2. Press the carriage return key.
3. Enter the channel and unit of the deadstart disk.
4. Enter the device type, channel, equipment, and unit of the tape drive containing the patched MSL module then press the carriage return key. The TDX options display appears.
5. Enter A to build MSL on disk from tape. The MSL Installation options appear.
6. Enter F to perform a full installation in MSL/OS shared disk mode. The system asks you if you want to save command buffers.
7. Enter Y to save command buffers or N to load command buffers from tape.
8. Press the carriage return key when TDX displays:

```
COPY FROM
-CR- = 1st NAME
```
9. Press the carriage return key when TDX displays:

```
COPY THRU
-CR- = LAST NAME
```
10. Enter Y if you want TDX to perform a write verify function when transferring the data, or N for no verification. MSL installation is complete when TDX displays the last cylinder, track, and sector used for the copy.
11. Initiate deadstart.

Replacing an HIVS Module

1. Enter T while displaying the Manual Operations display to install HIVS (for sites with no maintenance contract).
2. Enter the channel and unit of the deadstart disk.
3. Enter the type, channel, equipment, and unit of the tape device containing the patched HIVS module then press the carriage return key.

When the message INSTALLATION COMPLETE appears, HIVS installation is complete.

4. Initiate deadstart.

Replacing a CTI Module

1. Enter C to install CTI. This warning message appears:

```
*WARNING*
PERMANENT FILES MAY BE LOST
IF CTI IS NOT ALREADY
INSTALLED ON THIS DEVICE
(CR) TO CONTINUE
```

2. Press the carriage return key to continue.
3. Enter the channel and unit of the deadstart disk.
4. Upon successful installation, the following messages appear:

```
INSTALL COMPLETE
(CR) TO PROCESS DIFFERENT DEVICE
```

5. Initiate deadstart.

INSTALLING A PATCH

If a site is unable to wait for a tape containing a new module, a patch may be required. Patches involve a tedious installation process and also are difficult for the site and Control Data to manage. Therefore, a patch is sent to a site only when an extreme circumstance requires it.

Patching considerations:

- Incorporating and installing a patch requires the use of several utilities. Microcode can only be patched using the TDX and CMSE utilities. CTI, EI, SCD, MDD, and HIVS/MSL should be modified with the BINEDIT utility. All of the modules must be installed to the deadstart disk by using the manual operations options.
- The TDX and CMSE utilities are documented in both MSL reference manuals. (Procedures are included in this section.) BINEDIT information is included in appendix H. Refer to the Manual Operations display for your model of computer system in part I of this manual.

The following procedures are for patch insertion.

Installing a Microcode Patch

A patch is incorporated into microcode using the CMSE (Common Maintenance Software Executive) as follows:

1. Mount the CIP tape that you last installed to the deadstart disk.
2. Initiate a deadstart from the CIP tape. The Initial Options display appears.
3. Enter M to select the off-line maintenance option. The initial CMSE display appears.
4. Enter TDX then press the carriage return key to load microcode to disk.
 - a. Enter the channel and unit numbers of the deadstart disk.
 - b. Enter the device type, channel, equipment, and unit numbers of the tape drive containing the CIP. The MSL option menu appears.
 - c. Enter C to add programs to disk.
 - d. Enter Y when TDX displays:
DUPLICATE NAME CHECK (Y/N)
 - e. Enter Y when TDX displays:
REPLACE DUPLICATE NAMES (Y/N)
 - f. Enter the seven-character microcode name when TDX displays:
COPY FROM
-CR-=1ST NAME

If you do not know the microcode name, select the L option (display CIP component information) of the Utilities display to find out.
 - g. Enter the same microcode name when TDX displays:
COPY THRU
-CR-=LAST NAME
5. Initiate a deadstart from disk and select the off-line maintenance option.
6. Press the carriage return key to initiate CMSE.
7. Insert patch into microcode using instructions provided with the patch.
8. Initiate deadstart and select the off-line maintenance option again.

9. Enter TDX then press the carriage return key to write new version of microcode to scratch tape.
 - a. Enter the channel and unit numbers of the deadstart disk.
 - b. Enter the device type, channel, equipment, and unit numbers of the tape drive containing a blank tape. The MSL option menu appears.
 - c. Enter E to copy programs to tape.
 - d. Enter the microcode name when TDX displays:

```
COPY FROM  
-CR- = 1ST NAME
```

- e. Enter the microcode name again when TDX displays:

```
COPY THRU  
-CR- = LAST NAME
```

10. Reinitiate deadstart from CIP tape. The Initial Options display appears.

Follow the procedures for installing an individual CIP module to install the new microcode module to the deadstart disk.

Installing a CTI, HIVS, SCD, MDD, or MSL Patch

In the event a patch must be installed against one of these components, a binary patch utility must be used.

If the operating system is operational, use the on-line binary patch utility, BINEDIT (refer to appendix H). BINEDIT executes on both NOS and NOS/BE.

Once the module has been patched using BINEDIT, write the new module to tape.

Follow the procedures for installing an individual CIP module to install the new module to the deadstart disk.

CIP UTILITY PROCEDURES

The procedures described next use one or more of the options offered on the Utilities display. The Utilities display may be accessed during either a deadstart from disk or deadstart from CIP tape operation.

PERFORMING AN EXPRESS DEADSTART DUMP (EDD)

Express Deadstart Dump (EDD) is an option offered on the Utilities display. It dumps the contents of PP memories, central memory, extended memory (on CYBER 170 Computer Systems), CPU hardware registers, status/control (S/C) registers (on CYBER 180 Computer Systems except models 815 through 990), maintenance registers (on models 815 through 990), processor control store (on models 810 through 990), and tape and disk (except FSC) controlware to magnetic tape.

The default tape density is 800 cpi for seven-track 667/677 tapes and 1600 bpi for nine-track 639/669/679 tapes. All tapes are written in S format and as one file.

NOTE

EDD dumps unified extended memory (UEM) for models 810 through 990 (and for models 865 and 875 that contain UEM). For all other CYBER 170 Computer Systems (including models 865 and 875 with external extended memory), you must dump extended memory separately.

When EDD dumps PP memories, it destroys some of the contents of the PPs. For all systems except models 810 through 990, the following locations are affected.

<u>PP</u>	<u>Locations</u>
PP0	0 through 52g and 4275g through 7777g.
PP1	0 through 7.
All other PPs	0 through 3 and 7771g through 7777g.

On models 810 through 990, the long deadstart sequence and the extended deadstart sequence destroy parts of PP memories. If you select EDD after selecting one of these deadstart sequences, some of the information dumped is not valid. The amount of information destroyed depends on whether EDD was preceded by a short deadstart or long deadstart sequence and the setting of bit 2⁰ in word 12 (EDS) of the deadstart program.

The following locations are affected:

<u>PP</u>	<u>Locations</u>	
	<u>Short Deadstart Sequence</u>	<u>Long Deadstart or Long Deadstart with EDS</u>
PP0	0 through 528, 42758 through 77778.	All memory destroyed.
PP1 through PP4	No loss.	All memory destroyed.
All other PPs	No loss.	No loss.

Also, if you deadstart from a channel of an active PP on models 810 through 990, that PP loses the contents in locations 0 and 1.

For all systems, if you want to dump the entire contents of PP0, you must reconfigure the PPs to deadstart from another PP or transfer the contents of PP0 to another PP before using EDD. When possible, reconfigure PPs. If you cannot reconfigure PPs, transfer the contents of PP0 to another PP prior to the dump as follows:

1. Choose a channel of an active PP to which the system can transfer the contents of PP0.
2. Enter the following deadstart panel program:

	<u>Binary</u>			<u>Octal</u>
word 1	010	000	000	2000
2	111	111	111	7776
3	111	011	ppp	73pp
4	000	000	000	0000
5	000	011	000	0300

pp is number of PP you chose to hold contents of PP0.

3. Initiate a short deadstart sequence to run the program described in step 2. System transfers contents of PP0 to PP you selected. Contents of that PP are destroyed by the transfer.
4. Reset deadstart program for the appropriate warmstart.

NOTE

If you have reconfigured PPs or transferred the contents of PP0, you must redeadstart to use EDD. Remember which PP has the contents of PP0, so when the system dumps PPs you know which PP to print to get contents of PP0.

The following EDD procedure assumes that a dump tape has been mounted on the tape unit and the tape unit is ready. This procedure also assumes you have deadstarted the system and have selected the Utilities display.

1. Enter E to start the dump process. The console displays:

```
EXPRESS DUMP DEVICE TYPE - m
```

```
1=667, 669 ( 800 BPI)
```

```
2=667      ( 800 BPI)
```

```
   639, 679 (1600 BPI)
```

```
3=639, 679 (6250 BPI)
```

The value m is the device type specified in the default parameter block of the CTI/MSL disk area. If the parameter block is not present, zeros are displayed.

NOTE

If 6250 bpi is selected and the dump tape is not mounted on a tape drive that can support 6250 bpi, the tape will be written at 1600-bpi tape density. This could result in reaching end-of-tape on small tape reels with a resulting bad dump tape. In such a case, the Express Deadstart Dump must be restarted. The integrity of some of the information obtained during the second dump is questionable.

2. Press the carriage return key to use the device type being displayed or enter a 1, 2, or 3 and then press the carriage return key to specify an alternate device. The console displays:

```
EXPRESS DUMP DEVICE TYPE - m
```

```
CHANNEL-cc
```

```
(BS) - BACK TO PREVIOUS ENTRY
```

The value cc is the channel specified in the default parameter block in the CTI/MSL disk area. If the parameter block is not present, zeros are displayed.

3. Press the carriage return key to use the channel being displayed or enter the two-digit channel number of the tape unit to which data is to be dumped and press the carriage return key. The console displays:

```
EXPRESS DUMP DEVICE TYPE - m
```

```
CHANNEL-cc
```

```
EQUIPMENT-e
```

```
(BS) - BACK TO PREVIOUS ENTRY
```

The value e is the equipment number specified in the default parameter block in the CTI/MSL disk area. If the default parameter block is not present, zeros are displayed.

4. Press the carriage return key to use the equipment number displayed or enter the equipment number and press the carriage return key. The console displays:

EXPRESS DUMP DEVICE TYPE - m

CHANNEL-cc

EQUIPMENT-e

UNIT-uu

(BS) - BACK TO PREVIOUS ENTRY

The value uu is the unit number specified in the default parameter block of the CTI/MSL disk area. If the default parameter block is not present, zeros are displayed.

5. Press the carriage return key to use the unit number displayed or enter the two-digit unit number and press the carriage return key. The console displays:

EXPRESS DUMP NUMBER = 00

6. If the system does not have a clock chip, EDD asks for the current days' date using the following display:

ENTER DATE - 00/00/00

(FORMAT YY/MM/DD)

(SPACE - SKIP FOR CHANGES)

(LEFT BLANK - ZERO ENTRY)

(BS) - BACK TO PREVIOUS ENTRY

7. The console next displays:

UNLOAD DUMP TAPE OPTION.

Y - UNLOAD TAPE AFTER DUMP.

N - REWIND TAPE AFTER DUMP.

(CR) - UNLOAD TAPE AFTER DUMP.

(BS) - BACK TO PREVIOUS ENTRY.

Press Y to have the dump tape unloaded after the dump is completed. Press N to have the tape rewound and ready when the dump is completed. The default is to have the tape unloaded.

8. For computer systems with the following configurations:

- All CYBER 170-7XX, CDC 6000, and CYBER 70.
- CYBER 170-8XX, CYBER 180-8XX and CYBER 990 with the ECS/ESM prompt bit set in the deadstart panel.

NOTE

The ECS/ESM prompt bit should be set only if access to extended memory is through the Low Speed Port. This bit is bit 28 of word 13 for all configurations except for CDC 6000 and CYBER to mainframes that are deadstarting on a channel with an active PP (any channel but 0, 12, 13, 32, and 33).

The console displays:

ECS/LCM/ESM DUMP OPTIONS

(CR) = DO NOT DUMP EXTENDED MEMORY.

NNNN = NUMBER OF 10000B WORD BLOCKS.

(BS) - BACK TO PREVIOUS ENTRY.

Status line
Keyboard input

This display indicates how much extended memory should be dumped. Keyboard input is shown on the keyboard input line.

Enter the number of 10000g word blocks of extended memory then press the carriage return key to dump extended memory or just press the carriage return key to skip this option.

If a nonzero value was specified in the previous display for the number of blocks of extended memory to dump and the ECS/ESM prompt bit is set in the deadstart panel, the following display appears:

EXTENDED MEMORY CHANNEL

(CR) = NO EM CHANNEL.

00 = CHANNEL TO DUMP EM.

(BS) = BACK TO PREVIOUS ENTRY.

This display prompts for the channel number for EDD to dump ECS/ESM.

9. The console next displays:

CONTROLWARE WILL BE DUMPED
FROM THE FOLLOWING CHANNELS

NONE (the channel numbers used are displayed here)

CONTROLWARE DUMP OPTIONS

DUMP = CH
DUMP CONTROLWARE
FROM SPECIFIED CHANNELS.

CLEAR = CH
DO NOT DUMP CONTROLWARE
FROM SPECIFIED CHANNELS.

(CR) PROCEED WITH DUMP.
(BS) - BACK TO PREVIOUS ENTRY.
Status line
Keyboard line

Channel numbers are added to this display as they are selected to be dumped.

10. Enter D, the channel number, and then press the carriage return key for each channel from which the controlware should be dumped. The system completes entry of the word DUMP and inserts the equal sign for you. The channel numbers are added to the list of channels to be dumped.

Enter C, the channel number, and then press the carriage return key to remove a channel from the list of channels to be dumped. The system completes entry of the word CLEAR and inserts an equal sign for you.

The default is no controlware will be dumped.

11. If the dump tape equipment is not ready, the console displays:

DUMP TAPE ON CHcc EQee UNuu NOT READY (CR WHEN READY)

cc Channel number.

ee Equipment number.

uu Unit number.

Ready the equipment then press the carriage return key to continue.

12. If the write ring is not on the tape, the console displays:

DUMP TAPE ON CHcc EQee UNuu NO WRITE RING (CR WHEN READY)

Insert the write ring then press the carriage return key.

13. When EDD reaches the end of a tape reel before dump completion, the following message is displayed:

DUMP TAPE ON CHcc EQee UNuu WAITING REELrr (CR WHEN READY)

cc = dump tape channel number.

ee = dump tape equipment number.

uu = dump tape unit number.

rr = dump tape reel number.

14. The following messages are issued when a dump tape to be written upon contains label information prohibiting such action.

VSN = vvvvvv NOT ACCESSIBLE

The message indicates that the Volume Accessibility Field in the existing VOL1 label is not blank. A different tape must be used.

VSN = vvvvvv FILE NOT EXPECTED

This message indicates that the HRD1 label contains an expiration date greater than today's date, as indicated by either the calendar/clock chip or operator input. An unlabeled or expired tape must be used.

15. The existing message, EXPRESS DUMP IN PROGRESS, (for a system containing a 721 console) has been augmented by the following message:

REEL nn, VSN = vvvvvv

where nn is the current reel number and vvvvvv is the volume serial number of the tape being written.

16. In the case where the tape controller does not load the character conversion tables correctly, EDD will hang and display the following message:

CHii Tj kTS CONVERSION TABLE LOAD ERRORS.
DEADSTART REQUIRED.

ii = dump tape channel number.
j = 7 for 7-track dump tape.
= 9 for 9-track dump tape.
k = M for MTS Tape Subsystem.
= A for ATS, 67X, FSC, CCC, or 63X Tape Subsystems.

Dumping to a tape on a different channel is required.

17. Press the carriage return key to initiate the dump.

When the CC634B console is being used for models 810 or 830, the following message is displayed:

EXPRESS DUMP IN PROGRESS

18. When the dump is complete, the console displays:

DUMP id COMPLETE

id is dump identifier entered during sequence.

On all systems except models 810 through 860, the following message is displayed if an extended memory dump was specified and extended memory was not able to be dumped:

DUMP id COMPLETE.
DEADSTART REQUIRED.
ECS/ESM NOT ACCESSIBLE.

On all systems the following message is displayed if one or more of the channels selected for the controlware dump options was not able to be dumped.

DUMP id COMPLETE.
DEADSTART REQUIRED.

CONTROL WAS NOT DUMPED
FROM THE FOLLOWING CHANNELS

nn	nn	nn	nn	nn	nn
nn	nn	nn	nn	nn	nn
nn	nn	nn	nn	nn	nn
nn	nn	nn	nn	nn	nn

nn is the channel number to be dumped. From 1 to 24 channel numbers may be displayed.

The ECS/ESM NOT ACCESSIBLE and the CONTROLWARE WAS NOT DUMPED messages may both be displayed if the conditions that cause them to be displayed exist simultaneously.

If an error occurred during the dump, one of the following messages appears.

ERROR IN (error)
FATAL TO DUMP OPERATION

or

DUMP SUCCESSFUL
equipment
(CR) TO SEE ERROR STATUS

<u>Error</u>	<u>Description</u>
UN	Unit errors.
EQ	Controller errors.
CH	Channel errors.

<u>Equipment</u>	<u>Description</u>
BC	Buffer controller.
CM	Central memory.
CPU	Central processor hardware registers.
ECS-LCM	Extended memory (except unified extended memory).
FLPP	First level peripheral processors (for model 176 only).
MMR†	Memory maintenance registers.
MR	Maintenance registers (for models 810 through 860).

† For models 810 through 860 and 990 only.

<u>Equipment</u>	<u>Description</u>
PCS†	Processor control store.
PEP†	Processor exchange package.
PMR†	Processor maintenance registers.
PP _i	Peripheral processors numbered consecutively ($0 \leq i \leq 17$).
PRF†	Processor register file.
SCR††	Status and control registers.

If you press the carriage return key following this display, the system displays general and detailed equipment status information.

NOTE

If a CPU is logically turned off, a flag indicating this is set in the dump and the CPU is not exchanged during EDD execution. If CPU0 is down on a one-CPU system, both CPU0 and CPU1 must be logically turned off at deadstart to avoid exchanging of the registers.

If you reconfigured PPs before the dump, reconfigure them back to their normal settings after system completes the dump.

PERFORMING A PRINTER DUMP

A printer dump is an option offered on the Utilities display. It dumps the contents (in octal or hexadecimal) of part or all of a PP memory, central memory, register files, IOU registers, CM registers, CP registers, S/C registers (except models 810 through 860), and control store buffers selected by the operator to a line printer.

CTI supports print capability on a 512-line printer and the 580-12, 580-16, 580-20, 580-120, 580-160, or 580-200 line printers using print array cartridges 596-1 through 596-6. Not all computer systems or operating systems, however, support these printers.

The following procedure assumes that your line printer is ready and that you have dead-started the system and selected the Utilities display.

1. Enter P. The console displays printer dump options. The options offered depend on the computer system model. Refer to the display shown in the section on displays and options for your model of computer system. You cannot return to the Utilities display from this display. You must redeadstart the system.

† For models 810 through 860 and 990 only.

†† Except models 810 through 860 and 990. For models 865 and 875, S/C registers are maintenance registers.

2. Select option A or B.

- A Select this option to initialize the 512 line printer buffer image with the data necessary to print with a 512-1 print train. The A parameter provides compatibility with previous systems.
- B Select this option to initialize the 580 line printer buffer image and format buffer image memories.

The console displays:

```
PRINTER CH = 12
```

3. Press the carriage return key to accept the default channel number, or enter desired printer channel number then press the carriage return key to select a different channel. The following line appears below the channel display:

```
PRINTER EQ = 5
```

4. Press the carriage return key to accept the equipment number for the line printer, or enter the equipment number for line printer, if different from the default value, then press the carriage return key.

If option A was selected initially, proceed to step 7.

If option B was selected initially, the following message appears:

```
1 = 596-1
2 = 596-2
3 = 596-3
4 = 596-4
5 = 596-5
6 = 596-6
TRAIN SELECT = 5
```

5. Press the carriage return key to select the default train selection shown on the last line, or enter the desired printer train number, if different from the default value, then press the carriage return key.

The following message appears (option B only):

```
SET FORMAT BUFFER Y OR N
  Y = YES
  N = NO
```

```
(DEFAULT = Y)
```

6. Press the carriage return key to accept the default selection, or enter the desired option, if different from default value, then press the carriage return key. If you select the Y option, the 580 print buffer and format buffer memories are initialized. If you select the N option, only the print buffer memory is initialized.

7. Enter the letter of a dump option then press the carriage return key. Depending upon your selection, you may be prompted to enter additional parameters. If so, respond to prompt as follows.

NOTE

Do not select option A or B after selecting any other options. If you do, the screen goes blank and you must deadstart.

<u>Prompt</u>	<u>Entry</u>
PP NO=	Number of PP to be dumped. Enter the number A then press the carriage return key to dump all PPs except PPO.
(NXX = NIO PP XX, CXX = CIO PP XX)	
PPU NO	Number of PPU to be dumped (CYBER 170 model 176 only). Enter the letter A then press the carriage return key if all PPU's are to be dumped.
START ADRS	Starting central memory address (1 through 10 octal digits, or 1 through 7 hexadecimal digits).
END ADRS	Last memory address to be dumped. (From 1 to 10 octal digits for octal dump; from 1 to 7 hexadecimal digits for hexadecimal dump).
SELECT ADDRESS MODE	Enter H for hexadecimal address entry or B for byte address (octal) entry mode.
CPU=	Enter CPU number (options G, J, M, and N).

Press the carriage return key. The system executes the option you selected and displays dump options.

8. Enter the letter of another option then press the carriage return key, or terminate the dump by redeadstarting system.
9. During the printer dump sequence, you may encounter an error informative message. Refer to appendix B for a directory of messages and responses.

Displayed for I4 only.

This prompt is displayed only on systems with multiple CPU's when both are available.

SELECTING AN ALTERNATE DEADSTART DEVICE

Option S of the Utilities display allows you to specify an alternate tape unit or disk device for the deadstart operation. Entries made during this option override words 2, 4, 5, 6, 7, and 10 of the deadstart program. Refer to part II, section 1 for a detailed description of the deadstart program parameters.

This procedure assumes you have deadstarted the system and have selected the Utilities display.

1. Enter S. The following display appears on left screen:

```
DEADSTART DEVICE TYPE - m
(1=66X, 2=63X/67X, 3=DISK)
```

2. m is the device type indicated on deadstart program (word 6). Press the carriage return key to use this device, or specify an alternate device type by entering its type number (1, 2, or 3) then pressing the carriage return key. The following line appears:

CHANNEL - cc

3. cc is the channel indicated on the deadstart program (words 2, 4, 5, 7, and 10). Press the carriage return key to use this channel, or specify an alternate channel by entering channel number then pressing the carriage return key. The following line appears:

EQUIPMENT - e

4. e is the equipment indicated on the deadstart program (word 6). Press the carriage return key to use this equipment, or specify an alternate equipment by entering equipment number then pressing the carriage return key. The following line appears:

UNIT - uu

5. uu is unit number indicated on the deadstart program (word 6). Press the carriage return key to use this unit, or enter the unit number then press the carriage return key to specify an alternate unit.

The system now deadstarts from the alternate device and the Initial Options display reappears.

MODIFY DEFAULT PARAMETERS

Option D allows the operator to define and change the default parameters used with the CTI routines. Following is the initial display for the A option.

DEFAULT PARAMETER PROCESSING.

EACH ENTRY WILL BE PROCESSED
WHEN A -CR- IS ENTERED.

SPECIAL KEY INPUTS

(+) - DISPLAY THE NEXT DEFAULT BLOCK.
(-) - DISPLAY THE PREVIOUS DEFAULT BLOCK.
BKSP - DELETE THE LAST CHARACTER.
CR - ENDS EACH ENTRY WRITES DEFAULTS TO DISK.

ALL ENTRIES ARE IN THE FORMAT:

XXXX

WHERE XXXX = 1 TO 10 ALPHA-
NUMERIC ENTRY DEFINING THE
PARAMETER TO BE PROCESSED.

(ENTER + TO CONTINUE.)

Enter a (+) character and follow it with a (CR). The first default block display appears:

DEADSTART TAPE DEFAULTS

ENTER TAPE TYPE.....01
(1 = 66X, 2 = 63X/67X)

Enter the proper tape type, if different from the displayed value, and follow it with a (CR). The following line is added to the display:

ENTER CHANNEL NUMBER....13

Enter the proper channel number, if different from the displayed value, and follow it with a (CR). The following line is added to the display:

ENTER EQUIPMENT NUMBER..00

Enter the proper equipment number, if different from the displayed value, and follow it with a (CR). The following line is added to the display:

ENTER UNIT NUMBER.....00

Enter the proper unit number, if different from the displayed value, and follow it with a (CR). The following lines are added to the display:

ENTER + TO CONTINUE

A (+) character causes the following default block display to appear:

EDD TAPE DUMP DEFAULTS

ENTER TAPE TYPE.....01
(1 = 66X, 2 = 63X/67X)

Enter the proper tape type, if different from the displayed value, and follow it with a carriage return. The following display results:

ENTER CHANNEL NUMBER....13

Enter the proper channel number, if different from the displayed value, and follow it with a carriage return. The following display results:

ENTER EQUIPMENT NUMBER..00

Enter the proper equipment number, if different from the displayed value, and follow it with a carriage return. The following display results:

ENTER UNIT NUMBER.....00

Enter the proper unit number, if different from the displayed value, and follow it with a carriage return. The following display results:

ENTER + OR - TO CONTINUE

A (+) character causes the next default block display to appear:

SYSTEM DISK DEFAULTS

ENTER CHANNEL NUMBER....01

Enter the proper channel number, if different from the displayed value, and follow it with a (CR). The following line is added to the display:

ENTER UNIT NUMBER..00

Enter the proper unit number, if different from the displayed value, and follow it with a (CR). The following line is added to the display:

ENTER + OR - TO CONTINUE

A (+) character causes the next default block display to appear:

ALTERNATE SYSTEM
DISK DEFAULTS

ENTER CHANNEL NUMBER....01

Enter the proper channel number, if different from the displayed value, and follow it with a (CR). The following line is added to the display:

ENTER UNIT NUMBER.....00

Enter the proper unit number, if different from the displayed value, and follow it with a (CR). The following line is added to the display:

ENTER + OR - TO CONTINUE

A (+) character causes the next default block display to appear:

MSL-HVS DISK DEFAULTS

ENTER CHANNEL NUMBER....01

Enter the proper channel number, if different from the displayed value, and follow it with a (CR). The following line is added to the display:

ENTER UNIT NUMBER.....00

Enter the proper unit number, if different from the displayed value, and follow it with a (CR). The following line is added to the display:

ENTER + OR - TO CONTINUE

A (+) character causes the next default block display to appear:

LINE PRINTER DUMP DEFAULTS

ENTER CHANNEL NUMBER....12

Enter the proper channel number, if different from the displayed value, and follow it with a (CR). The following line is added to the display:

ENTER EQUIPMENT NUMBER..07

Enter the proper equipment number, if different from the displayed value, and follow it with a (CR). The following lines are added to the display:

ENTER TRAIN TYPE.....04
(1 = 596-1, 2 = 596-2)
(3 = 596-3, 4 = 596-4)
(5 = 596-5, 6 = 596-6)

Enter the proper train type, if different from the displayed value, and follow it with a (CR). The following lines are added to the display:

FORMAT CONTROL MODE.....01
(1 = PROGRAMMABLE, 2 = FORMAT TAPE)

Enter the proper format control mode, if different from the displayed value, and follow it with a (CR).

Upon completion of the default parameter entry, the following message is displayed:

```
PARAMETER PROCESSING COMPLETE
ENTER (-), OR DEADSTART
```

PERFORMING A POWER-ON INITIALIZATION (MODELS 810 THROUGH 860 AND 990)

Use the following procedure to initialize a model 810 through 860 and 990 computer system after applying power to the mainframe or after performing a maintenance action. This procedure assumes that you have performed a long deadstart and have selected the Utilities display.

1. Enter I. The Initial Options display reappears with the following message at the bottom of the display:

```
ALL MAINFRAME MEMORIES WILL
BE INITIALIZED FOR MSL/OS LOADS
```

2. Enter one of the following:

CR To initialize the system (deadstart recovery level 0) and load the operating system. If the deadstart recovery level is 3, the following message is displayed:

```
LEVEL 3 RECOVERY NOT POSSIBLE
```

```
CENTRAL MEMORY INITIALIZATION
HAS BEEN SELECTED BY THE OPERATOR,
OR AUTOMATICALLY SET BY THE
HARDWARE.
```

```
DEADSTART AND SELECT A DIFFERENT
RECOVERY LEVEL, OR DO NOT SELECT
MAINFRAME INITIALIZATION.
```

Reset the deadstart program for a level 0 deadstart and initiate a deadstart.

NOTE

On I4 IOUs, bit 33 of the NIO EC register is defined as the "System Intialized" bit. This bit, when set, indicates the mainframe was initialized during a previous deadstart, and no unrecoverable errors were encountered. The bit is automatically cleared when power is applied to the system.

If the operator selects any O.S. load option on models 835 through 860, or model 990, and the IOU is an I4, CTI will check the state of the System Initialized bit. If the bit is set, no further action is taken. If the bit is clear, CTI sets an internal flag indicating mainframe initialization is to be performed, then checks the deadstart recovery level. If the recovery level is 3, the above message is displayed, and the deadstart is aborted.

- M To initialize the system, including the alternate PP, and load off-line maintenance software.

NOTE

Selecting the M option after selecting the I option is allowed only when word 12 of the deadstart program directs CTI to initialize the alternate PP. If word 12 of the deadstart program directs CTI not to initialize the alternate PP, the power on initialization aborts and CTI displays the informative message:
MS LOAD NOT POSSIBLE

ALTERNATE PP DISABLE IS SET, AND
CENTRAL MEMORY INITIALIZATION
HAS BEEN SELECTED BY THE OPERATOR,
OR AUTOMATICALLY SET BY THE
HARDWARE.

DEADSTART AND CLEAR ALTERNATE PP
DISABLE, OR DO NOT SELECT
MAINFRAME INITIALIZATION.

NOTE

On models 835 through 860, and model 990, if the IOU is an I4, CTI will clear the System Initialized bit in the NIO EC register when the operator selects the M option. If the operator selects an O.S. load on the next subsequent deadstart, CTI will force a mainframe initialization to be performed as described in the above NOTE. Under such conditions, a level 3 deadstart will be impossible.

3. If communication is lost with a PP during initialization, the following message is displayed.

PP xx NOT RESPONDING
DEADSTART ABORTED

Reinitiate deadstart, logically turn off the PP, and repeat the procedure.

CLEARING ESM (EXCEPT MODELS 810 THROUGH 860 AND 990)

The clear ESM option (Z) on the Utilities display provides the capability to master clear the ESM control logic or to clear ESM.

NOTE

This option should be selected after any power interruption or maintenance activity.

The following procedure assumes you have deadstarted the system and have selected the Utilities display.

1. Enter Z. The console displays:

A - MASTER CLEAR CONTROL LOGIC

B - CLEAR ESM

2. Enter A to master clear ESM control logic.

- a. The console displays:

ESM ACCESS CHANNEL =

- b. Enter a one- or two-digit octal channel number then press the carriage return key. If an invalid number is entered, the console displays:

INVALID CHANNEL ENTRY
(CR) TO RETRY

Press the carriage return key and reenter the channel number.

- c. Entry of a valid number causes the next line to be added to the display:

ESM ACCESS EQUIPMENT =

Enter one octal digit then press the carriage return key. If the system is unable to access ESM using the specified channel and equipment, the console displays:

UNABLE TO ACCESS PORT
(CR) TO RETRY

Press the carriage return key and reenter the channel and equipment numbers to retry.

- d. When the system accesses the side door port, one of the following messages is displayed:

MASTER CLEAR COMPLETE
(CR) TO RETURN TO OPTION DISPLAY

or

STATUS BIT ERROR

The STATUS BIT ERROR message indicates that the system is detecting an error when the side door port is statused following the master clear. Press the DEADSTART switch to return to the Initial Options display. If the message reappears, contact a CE.

3. Enter B to clear ESM. The console displays the following warning message:

```
*WARNING*
RECOVERY DEADSTART IMPOSSIBLE
IF THIS PROCESS CONTINUES.
(CR) TO CONTINUE, OR (BS)
TO SELECT ANOTHER OPTION.
```

- a. Press the carriage return key. The console displays:

```
AVAILABLE ESM =
```

- b. Enter the amount of ESM available (from one to eight octal digits) then press the carriage return key.

The system clears the specified amount of ESM by writing different patterns of zeros and ones.

When the process is complete, the console displays:

```
ESM CLEAR COMPLETE
LAST ADDRESS CLEARED = xxxxxxxx
(CR) TO RETURN TO OPTION DISPLAY.
```

- c. If the system is unable to access the specified available ESM, the console displays:

```
ERROR - ADDRESS OUT OF RANGE
LAST ADDRESS CLEARED = xxxxxxxx
(CR) TO RETURN TO OPTION DISPLAY
```

Press the carriage return key to clear the ESM options display. Reselect option b and reenter the ESM available address.

4. Press the DEADSTART switch to return to the Initial Options display.

LOADING AND INSTALLING DISK SUBSYSTEM MICROCODE FROM CIP TAPE

This procedure loads peripheral microcode into the 834/836 disk adapter and control module memory and installs peripheral microcode onto specified drives. The procedure assumes that the CIP tape containing the peripheral microcode has been mounted on a tape unit, that the system has been deadstarted from tape, and the Utilities display (option U of the Initial Options display) has been selected.

1. Enter M. The following display appears on the screen.

DISK DRIVE LOCATION

CHANNEL - cc

2. cc is initially zero. Press the carriage return key to accept channel 0, or specify an alternate channel by entering the channel number then pressing the carriage return key. The following line appears.

EQUIPMENT - e

3. e is initially zero and should remain zero for 834/836 drives. Press the carriage return key. The following line appears.

UNIT - cu

4. cu is initially zero. Press the carriage return key to use this cu (c=control module number, u=unit number), or enter the cu of an alternate drive then press the carriage return key.

The system now begins the peripheral microcode load/install process.

5. When the load/install process is complete, the following lines are displayed on the console.

<u>834</u>	<u>836</u>
INSTALLED	MA 462xx
MA462xx	MH 424xx
MH422xx	MD 424xx
MD422xx	

CR FOR NEXT DRIVE

xx is the peripheral microcode revision number.

6. Press the carriage return key to load/install peripheral microcode on another 834 or 836 drive. If no other drive is to be installed, then redeadstart. If you press the carriage return key, the following lines are displayed.

DISK DRIVE LOCATION

CHANNEL - cc

Repeat steps 2 through 6 for each 834/836 drive.

OPERATOR INTERVENTION PROCEDURES

The procedures included here use options offered on the Operator Intervention display. The Operator Intervention display may be accessed only during a deadstart from disk operation.

RUNNING HARDWARE VERIFICATION SEQUENCE (HIVS)

The hardware verification sequencer controls the execution of a set of go/no go tests of the peripheral processor subsystem (PPS), central memory (CM), and the central processor unit (CPU). The tests are taken from the Maintenance Software Library (MSL) and run under control of the sequencer using the capabilities of the common maintenance software executive (CMSE). The tests executed depend on the model of machine being tested. Refer to the description of the Hardware Verification display for your model of computer system in part I of this manual for a list of tests. Appendix E includes a brief description of each HIVS test.

Use this procedure to initiate the hardware verification sequence (HIVS). This procedure assumes you have deadstarted the system and have selected the Operator Intervention display.

NOTE

To do a level 3 recovery deadstart after verifying the hardware, you must set the deadstart program for a level 3 recovery prior to deadstart.

1. Enter V to select HIVS. The Hardware Verification Sequence display appears.

When a test is attempted on hardware that is turned OFF via CTI or is physically not present, the following messages display.

NO PP AVAILABLE
NO CM AVAILABLE
NO CP AVAILABLE
NO EM AVAILABLE

HIVS displays following messages during testing sequence:

TESTING REG
TESTING PPS
TESTING CM
TESTING CPU xx

If the test sequence completes without detecting errors, HIVS displays:

TESTING COMPLETE-DEADSTART

2. If an error is detected, HIVS displays one of the following error messages.

ERROR PP xx
ERROR CM
ERROR CPU xx
ERROR REG
SCR ERROR yyyy (CY70, CY170 865/875 only)

xx indicates the PP or CPU in error.

Refer to appendix B for a directory of error messages and responses.

RESETTING THE DEADSTART PARAMETERS

The P option of the Operator Intervention display provides a display of the contents of the words 12, 13, and 14 of the deadstart program. Parameters entered using this display override the following deadstart program parameters:

- Deadstart level
- CMRDECK number (NOS), CMR number (NOS/BE)
- Deadstart program words 12 and 14

For a detailed description of deadstart program parameters refer to part II, section 1.

Use this procedure to reset the deadstart program parameters. The procedure assumes you have deadstarted the system and have selected the Operator Intervention display.

1. Enter P. The console displays the Deadstart Parameters display.
2. Reset level of deadstart by entering:

I=x Value x is the deadstart level as follows:

<u>Level</u>	<u>Use</u>
0	Initial deadstart; it is used when recovery deadstart is impossible.
1	To resume normal processing following maintenance.
2	For system test only.
3	Following equipment malfunction.

3. Specify CMRDECK (NOS) or CMR (NOS/BE) number by entering:

C=xx

The value xx can range from 0 to 778.

4. Specify whether or not the NOS system load is to halt and display CMRDECK by entering:

<u>Entry</u>	<u>Description</u>
D=Y	Display CMRDECK.
D=N	Do not display CMRDECK.

Refer to part II, section 1 for instructions on modifying the CMRDECK.

NOTE

Steps 5 and 6 are for maintenance operations only and do not affect operating system deadstart.

5. Reset value of deadstart program word 12 by entering:

<u>Entry</u>	<u>Description</u>
W12=wxyf	wxyf defines size of UEM, CM size, CPU type (refer to Setting Word 12 in part II, section 1).

6. Reset value of deadstart program word 14 by entering:

<u>Entry</u>	<u>Description</u>
W14=ffff	This field is currently reserved for future use by maintenance software or operating system.

7. Press the carriage return key to accept the deadstart program parameters shown and continue the deadstart sequence. Press the backspace key to accept parameters and return to Operator Intervention display.

BUILD DEADSTART DISK OPERATIONS

The procedures described next use one or more of the options offered on the Build Deadstart Disk display and Manual Operations display. The Build Deadstart Disk display may be accessed only during a deadstart from CIP tape operation.

NOTE

This procedure should be used only after an initial install has been performed.

MANUALLY REPLACE MODULES ON THE DEADSTART DISK

Use the manual replacement procedure when you have modified the components of the CIP tape or when you need tests other than the predefined subset of tests.

Should the entire CIP require more disk space than is normally allocated in a shared-disk mode, you must edit the released binary tape or circumvent this limitation. Editing the CIP tape is the preferred method.

After you have edited the CIP binary tape, if necessary, perform the following steps to replace CIP components in a shared-disk mode.

NOTE

Omit steps 4, 7, 8, and 9 for mainframes other than models 810 through 860.

1. Ensure that the tape and disk controlware are present and functioning properly, and perform a system warmstart.
 - a. Mount the CIP tape without the write-enable ring and ready the unit.
 - b. Set the deadstart panel or program for a warmstart from tape. Refer to Warmstart Procedures Summary in part II, section 1. After a successful warmstart, the Initial Options display appears.

2. Replace CTI module on deadstart disk.

- a. Press the carriage return key or enter B while displaying the Initial Options display. The Build Deadstart Disk display appears.
- b. Enter M. The Manual Operations display appears.
- c. Enter C to install CTI. The following display appears:

```
ENTER ONE OF THE FOLLOWING
(CR) - INSTALL DEADSTART
      MODULE ON DISK
R    - RELEASE OF CTI-MSL/HIVS/OS
      RESERVED DISK SPACE
```

- d. Press the carriage return key. The system now requests channel, equipment, and unit numbers for the disk device. Enter channel, equipment, and unit number for device.
- e. Press the carriage return key. The following warning message appears:

```
*WARNING*
```

```
PERMANENT FILES WILL BE LOST IF CTI IS NOT
ALREADY INSTALLED ON THIS DEVICE
```

```
(CR) TO CONTINUE
```

- f. Press the carriage return key. The system now requests channel, equipment, and unit numbers of disk device.

The following message appears when CTI is loaded successfully:

```
INSTALL COMPLETE
(CR) TO PROCESS DIFFERENT DEVICE
```

- g. If your site has more than one system disk, press the carriage return key and repeat steps 2d through 2i for each disk (optional).
- h. Initiate deadstart to return to the Initial Options display. The version of CIP is indicated at the bottom of the display.

3. Replace CTI/MSL common disk area (CDA) modules.

- a. Press the carriage return key or enter B while displaying the Initial Options display. The Build Deadstart Disk display appears.
- b. Enter M. The Manual Operations display appears.
- c. Select the D option. Then enter the disk and tape channel and unit numbers as prompted by the display.

If the disk unit selected for the CDA utility is reserved by another controller, the following message appears:

```
DISK UNIT RESERVED
```

Clear the reserved status of the disk unit to initiate automatic retry.

If the disk selected for the CDA utility is a fixed module drive whose READ ONLY switch is set, the following message appears:

READ ONLY SELECTED.

Turn off the READ ONLY switch and press the carriage return key to initiate automatic retry.

4. Replace microcode on deadstart disk.
 - a. Enter B while displaying the CAU initial options display.
 - b. The CAU initial options display appears when modules have been replaced.
5. Replace default parameter deck on deadstart disk from CIP tape.
 - a. Enter A while displaying the CAU initial options display.
 - b. The CAU initial options display appears when modules have been replaced.
6. Replace environment interface (EI) on CTI/MSL disk area.
 - a. Enter C while displaying the CAU initial options display.
 - b. The CAU initial options display appears when installation is complete.
7. Replace CC634B System Console Driver (SCD) on the disk.
 - a. Enter D while displaying the CAU initial options display.
 - b. The CAU initial options display appears when installation is complete.
8. Replace Monitor Display Driver (MDD) on the disk.
 - a. Enter E while displaying the CAU initial options display.
 - b. The CAU initial options display appears when installation is complete.
9. Replace Dedicated Fault Tolerance (DFT) module on the disk.
 - a. Enter F while displaying the CAU initial options display.
 - b. The CAU initial options display appears when installation is complete.
10. Replace MSL module to disk.
 - a. Press the carriage return key or enter B while displaying the Initial Options display. The Build Deadstart Disk display appears.
 - b. Enter M. The Manual Operations display appears.
 - c. Enter T. The console displays:

TDX
DISK AND TAPE TRANSFER UTILITY
CR TO CONTINUE

- d. Press the carriage return key then enter TDX parameters as prompted. The TDX option display appears upon completion of these entries.
- e. Enter A to build MSL from tape.
- f. Enter F to select MSL/OS Shared Disk mode. Programs are installed at the predefined area of the disk.

The following message is displayed:

```
SAVE COMMAND BUFFER AREA  
Y = YES  N = NO
```

- g. Enter N in response to the above message (you do not have to press the carriage return key). TDX initializes the PNT and SRT and presents the following display:

```
COPY FROM  
-CR- = 1ST NAME
```

- h. Press the carriage return key to cause TDX to begin copying with the first program it encounters. When the COPY FROM selection is complete, TDX presents the following display:

```
COPY THRU  
-CR- = LAST NAME
```

- i. Press the carriage return key to instruct TDX to copy to the last program on the tape. For tape-to-disk copies, TDX has the ability to verify data written to disk. TDX presents the following display:

```
DATA VERIFY (Y/N)
```

- j. Enter Y. TDX transfers each program to the disk, displaying the name of each program as it is copied to the disk. TDX skips over any command buffers located on the tape. Upon completion of the copy operation, TDX displays the first cylinder, track, and sector used for the copy. Press the space bar to display the last available cylinder for the complete MSL build.

NOTE

If the SRT FULL message appears instead, the edited MSL is too large for the predefined disk area. You must either obtain permission to use more of the disk and install in maintenance only mode, or use an alternate tape editing method and install a partial MSL. In either case, you cannot continue from this point without deadstarting.

- k. Press the space bar to clear the display and display a reduced set of TDX options.
11. Install command buffers to disk.
- a. Enter B when the TDX options display is present. TDX presents the following display:

```
COPY FROM  
-CR- = 1ST NAME
```
 - b. Press the carriage return key to cause TDX to begin copying with the first command buffer it encounters. TDX then presents the following display:

```
COPY THRU  
-CR- = LAST NAME
```
 - c. Press the carriage return key to instruct TDX to copy to the last command buffer on the tape. For tape-to-disk copies, TDX has the ability to verify data written to disk. TDX presents the following display:

```
DATA VERIFY (Y/N)
```
 - d. Enter Y. TDX transfers each command buffer to the disk, displaying the name of each command buffer as it is copied to the disk. Upon completion of the copy operation, TDX displays the last cylinder, track, and sector used for the copy.
 - e. Press the space bar to clear the message and display a reduced set of TDX options.
12. The system is now ready to install the operating system.

PART III



COMMAND INDEX

AB
BY
CE
CX
DB
DC
DF
DH
DK
DM
DP
DR
DS
EB
EC
EK

III-1-8
III-1-21
III-1-10
III-1-11
III-1-4
III-1-4
III-1-15
III-1-5
III-1-18
III-1-5
III-1-12
III-1-9
III-1-17
III-1-8
III-1-8
III-1-20

ER
ES
HE
HP
IP
MC
RF
RP
RR
SD
SE
SP
SR
UC
+
-

III-1-10
III-1-19
III-1-22
III-1-13
III-1-12
III-1-11
III-1-14
III-1-13
III-1-22
III-1-16
III-1-14
III-1-14
III-1-21
III-1-11
III-1-7
III-1-7

MONITOR DISPLAY DRIVER (MDD)

1

MDD is a PP program that utilizes the Two Port Multiplexer on the CDC CYBER models 810 through 990 (excluding models 865 and 875) to provide a window to the hardware status. This program is built to run on the NOS, NOS/BE, or NOS/VE operating system. Once initiated, MDD detaches itself from the operating system until directed via the MDD console to terminate. MDD is not dependent on an operating system and should function if the operating system malfunctions due to hardware or software problems. As of the CIP level 5 release, MDD is central memory resident. The CYBER Initialization Package is responsible for loading MDD into central memory and providing the MDD directory.

MDD TERMINAL CONTROL

MDD is designed to allow sharing of the communications port (and any terminal connected to it). On a CDC 721 terminal if the user presses the F7 key, MDD releases the port (and thereby the terminal) if another driver wishes to use the port. If no other driver has signaled a request for the port, MDD responds with *IGNORED*. If a terminal other than a CDC 721 is used, the operator should enter an RS (Record Separator = 1E hexadecimal) and a lower case w.

COMMAND SYNTAX

MDD receives commands from the MDD console to:

- Display or change central memory (60 or 64 bit)
- Display, interpret, or change the contents of registers
- Display or change control store (64 or 128 bit)
- Display the DFT block or buffers
- Set flags to control DFT processing
- Stop or start PPs
- Stop or start a CPU

Using any of the display commands should have no effect on an operating system. Most MDD commands allow position dependent parameters, keywords, or a combination of both. This means that for the command whose syntax is:

```
DR element RN=register_number RC=repeat_count
```

where element can be one of the keywords I, M, or P. All of the following do the same thing.

```
DR i RN=30 RC=9
DR i 30 9
DR RN=30 i 9
```

The delimiter between parameters in MDD commands can be either a space or a comma. Parameters can be placed positionally with multiple commas. All of the examples below are correct.

```
DB AD=0,WC=10
DB,,WC=10
DB 0 10
DB,,10
```

MDD INITIALIZATION

MDD can be initiated on either Port 1 or Port 0 of the Two Port Mux. When MDD is initiated by NOS or NOS/BE, it can be directed to wait 15 minutes for the Carrier ON status to be detected and if not detected MDD terminates. When initiated by CTI or NOS/VE, MDD waits indefinitely for the Carrier ON status. MDD cannot be directed to go away if initiated by CIP or NOS/VE.

To bring up MDD via CTI:

```
Select option M - MDD
MDD=YES
PORT=port number desired
```

CAUTION

This mode should only be used to track problems associated with an operating system deadstart.

NOTE

When deadstarting a mainframe via the Two Port Mux, it is possible for the System Console Driver and MDD to share the same port. If this occurs, the operator needs to use the F7 key to toggle use of the terminal between these two functions.

To bring up MDD under NOS, type the following under DSD (make sure the console is unlocked):

```
X.MDD(d,p)
```

Where d and p are octal digits. If d is zero or not specified, MDD waits 15 minutes for the Carrier ON status to be detected from the Two Port Mux. If any other value is given for d, MDD never times out. If a one is given for p, MDD uses Port 0 of the Two Port Mux. If p is any other value or not specified, then Port 1 is used by MDD.

To bring up MDD under NOS/BE, type the following under DSD:

```
UNLOCK,passwd.  
MDD,D,n.  
LOCK.
```

If D is not specified, MDD waits 15 minutes for the Carrier ON status to be detected from the Two Port Mux. If D is specified, MDD does not time out. The n parameter follows the protocol for the p parameter in NOS.

To bring up MDD under NOS/VE (in a standalone mode), type the following:

```
SYSDEBUG  
LOAD_MDD d p  
RUN
```

Where d and p are a zero or one. For either value of d, MDD never times out. The port number desired should be entered for p.

CONVENTIONS

Delimiters	Only a comma or space may be used.
Parameter Options	These are listed in the explanatory text following the parameter, if applicable.
Required Parameters	These are listed in the explanatory text following the parameter, if applicable.
Parameter Defaults	These are listed in the explanatory text following the parameter, if applicable.

MDD COMMAND EXPLANATION AND SYNTAX

CENTRAL MEMORY DISPLAY COMMANDS

All of the central memory display commands save the address and word_count parameters. The default values for the address and word_count on the next central memory display are obtained from these values.

Display Bytes

Purpose The DB command displays 64-bit memory in 8-bit byte format (one word per line, eight groups of two hexadecimal digits per word).

Format DB
AD=byte_address
WC=word_count

Parameters AD

Starting byte address for the central memory display (hexadecimal). This value is rounded down to the nearest word boundary. The default value is zero or the address used by the most recent memory, control store, or DF command.

WC

Number of words to display (hexadecimal). The default is 8 or the most recently entered value.

Display CM

Purpose The DC command displays the least significant 60 bits of central memory in octal word format (one word per line, twenty octal digits per word).

Format DC
AD=octal_address
WC=word_count

Parameters AD

Starting word address for the central memory display (octal). The default value is zero or the address used by the most recent memory, control store, or DF command.

WC

Number of words to display (octal). The default is 8 or the most recently entered value.

Display Hexadecimal CM

Purpose The DH command displays 64-bit memory in hexadecimal word format (one word per line, sixteen hexadecimal digits per word).

Format DH
AD=word_address
WC=word_count

Parameters AD

Starting word address for the central memory display (hexadecimal). The default value is zero or the address used by the most recent memory, control store or DF command.

WC

Number of words to display (hexadecimal). The default is 8 or the most recently entered value.

Display Virtual Memory

Purpose The DM command can be used to display memory in a virtual environment. When first initiated, MDD initializes all of its default virtual memory parameters from the hardware registers. These values may be changed if desired. The memory is displayed by first displaying the segment number and the the memory in byte format (eight groups of two hexadecimal digits) with an eight-digit relative byte offset for an address. The Real Memory Address (RMA) for the first word displayed is saved to be used as the default for the DC, DH, and DB commands. This allows the user to determine the RMA for an arbitrary PVA by simply entering a DB, DH, or DC command. The PVA entered is retained as the default PVA for the next execution of the DM command.

NOTE

MP, JP, PT, PS, and PL are reinitialized when the SE command is entered.

Format DM

PVA=virtual_address
WC=word_count
xp=exchange_package
PTA=page_table_rma
BO=byte_offset
PS=page_size_mask
PL=page_table_length

Parameters PVA

Process Virtual Address to use as the starting memory address for the display. This is an eleven digit hexadecimal number consisting of three digits of segment number and eight digits of byte offset. The default is 0000000000 or the most recently entered value.

WC

The number of words to display (hexadecimal). This defaults to the previously used value.

xp/MPS

JPS

XPS

Exchange package address to be used to obtain the segment table address used in converting a PVA to a System Virtual Address (SVA) prior to searching the Page Table. Just specifying the keyword uses the value last specified for the keyword. Specifying xp=hex_address changes the value that is associated with the keyword xp. If this parameter is omitted, then the keyword last entered on a DM command is assumed. The initial defaults for MP and JP are the values of the monitor_state and job_process registers when MDD is started up.

PTA

Page Table address. The initial default is the page table address when MDD is started up. The default is changed by entering this parameter.

BO

Byte Offset. This parameter can be used if you wish to display a different offset in the same segment. If this parameter is used, then the PVA parameter should not be used.

PS

Page Size mask. Hexadecimal number for the new page size mask. The initial default is the page size mask when MDD is started up. The default is changed by entering this parameter.

PL

Page Table length. Hexadecimal number for the new Page Table length. The initial default is the page table length when MDD is started up. The default is changed by entering this parameter.

Display Next Central Memory Block

Purpose The + repeats the last CM display command using a new starting address. If no increment is given, then the CM displayed starts where the previous display ended. If the increment is specified, the starting address for the memory displayed is equal to the current_starting_address plus the increment.

Format +
 increment

Parameters increment

Optional starting_address increment when the CM display command is repeated. The increment is interpreted in the same manner as the word or byte count of the previous memory display command.

Display Previous Central Memory Block

Purpose The - repeats the last CM display command using a new starting address. If no decrement is given, then the CM displayed ends where the previous display started. If the decrement is specified, the starting address for the memory displayed is equal to the current_starting_address minus the decrement.

Format -
 decrement

Parameters decrement

Optional starting_address decrement when the CM display command is repeated. The decrement is interpreted in the same manner as the word or byte count of the previous memory display command.

CENTRAL MEMORY CHANGE COMMANDS

The following commands are used to change central memory. Each attempt to write central memory will check the address against the OS Bounds Register. If the write would cause an OS Bounds violation, the user is informed and the command is not executed. If the user does intend to cross this boundary he/she must use the AB command to toggle the OS Bounds Register and repeat the central memory write command.

Enter Bytes into Memory

Purpose The EB command changes memory one byte at a time for 1 to 33 bytes. The byte address is retained for successive memory display commands.

Format EB
D=byte_address
B1...Bn

Parameters AD

Starting byte address (hexadecimal) to be changed. The address is the exact byte address and need not be on a word boundary. The address must be specified.

B1...Bn

The new values for the bytes starting at the byte address specified by the AD parameter. Each value is a one- or two-digit hexadecimal number. One or more bytes may be changed at a time.

Enter Central Memory

Purpose The EC command changes one word of 60-bit memory to the specified octal value. The address changed is retained for successive memory display commands.

Format EC
AD=word_address
WV=word_value

Parameters AD

Word address (octal) to be changed. The address must be specified.

WV

The new value to be entered into the address given by AD. This is a 1- to 20-digit octal value, right justified. The default for this parameter is zero.

Write Across the Bounds Register

Purpose The AB command allows the user to toggle the side of the OS Bounds on which MDD resides.

Format AB

MAINTENANCE REGISTER DISPLAY COMMANDS

Display Maintenance Registers

Purpose The DR command displays either a single maintenance register, a list of consecutive registers, or a predefined list of registers in a specific element (IOU, memory, processor). The display consists of the register number (hexadecimal), the contents of the register in 16 hexadecimal digits, and a description of the register (only for the predefined list option).

Format DR
element
RN=register_number
RC=repeat_count

Parameters element/I
M
P

Identifies from which element to read the register(s). The only valid keys are: I for IOU, M for memory, and P for processor. The initial default is I. Once a value has been specified it becomes the default.

RN

Register Number to display (hexadecimal). If this parameter is omitted, the predefined list based on the element and mainframe model is used.

RC

Repeat Count (hexadecimal). This parameter when specified with the RN parameter defines the number of additional registers to display. This parameter has no effect if RN is not specified.

The default registers displayed depends upon which element is specified.

Enter New Maintenance Register Value

Purpose The ER command allows the user to change the value of a register in an element on the maintenance channel.

CAUTION

Not all registers can be safely changed while an operating system is up. Some registers cannot be written by MDD for hardware reasons. The user should be familiar with the register he/she is trying to alter as mistakes can lead to unpredictable and disastrous results.

Format ER
element
RN=register_number
RV=register_value

Parameters element/I
M
P

Identifies from which element to write the register. The only valid keys are: I for IOU, M for memory, and P for processor. The initial default is I or the most recently entered value.

RN

The required hexadecimal register number to change.

RV

Value to write into the register. This may be a 1- to 16-digit hexadecimal number. The value is written to the register right justified.

Clear Errors on Maintenance Element

Purpose The CE command clears errors on the specified element.

Format CE
element

Parameters element/I
M
P

The element for which the Clear Errors function is executed. The only valid keys are: I for IOU, M for memory, and P for processor. The default is the most recently entered value from an ER, DR, CX, or CE command.

Master Clear a Maintenance Element

Purpose The CX command master clears a specified element.

WARNING

This command should not be used if an operating system is functioning.

Format CX
element

Parameters element/I
M
P

The element for which the master clear function is executed. The only valid keys are: I for IOU, M for memory, and P for processor. The default is the most recently entered value from an ER, DR, CX, or CE command.

Interpret MCR Bit Settings

Purpose The MC command gives a brief description of each bit set in either the provided MCR value or from the live MCR register. If no parameter is supplied and no bits in the live MCR register are set, the user is informed that the register is clear.

Format MC
RV=mcr_contents

Parameters RV

The MCR register value to be interpreted. If not specified, then the current MCR is read and its contents are used.

Interpret UCR Bit Settings

Purpose The UC command gives a brief description of each bit set in either the provided UCR value or from the live UCR register. If no parameter is supplied and no bits in the live UCR register are set, the user is informed that the register is clear.

Format UC
RV=ucr_contents

Parameters RV

The UCR register value to be interpreted. If not specified, then the current UCR is read and its contents are used.

Display PP Register Values

Purpose The DP command displays the selected register for all the PPs in the machine. The registers are displayed as six-digit octal numbers, five to a line. The first line displays PPs 0 to 4. The second line displays PPs 5 to 11. The third line displays PPs 20 to 24 and the fourth line PPs 25 to 31.

Format DP
register

Parameters register/P
Q
K
A

Identifies which PP register to be displayed for each PP. The valid keys are: P for the program counter, Q for the Q register, K for current instruction, and A for the accumulator. The initial default is P or the most recently entered value.

Idle PP

Purpose The IP command idles the selected PP by doing a hardware idle on the PP. Once idled, the PP can only be restarted via MDD by execution of the RP command. The A register is destroyed during the restart.

Format IP
PP=pp_number
pp_type

Parameters PP

PP number to idle. This must be an octal number 0 to 11 or 20 to 31. This parameter is required.

pp_type/N
C

pp type is used to differentiate between NIO and CIOC PPs. The only valid keys are N for NIO and C for CIO. The initial default is N or the most recently entered value.

Restart PP at Specified Address

Purpose The RP command restarts a PP by deadstarting the PP and sending a new P register.

CAUTION

The deadstart load destroys words 0 and 1 as well as the A register of the specified PP.

Format RP
PP=pp_number
AD=starting_address
pp_type

Parameters PP
PP number to restart. This must be an octal number 0 to 11 or 20 to 31. The parameter is required.

AD

Address of first instruction to be executed. The address is an octal value from 0 to 7776. This parameter is required.

pp_type/N
C

pp_type is used to differentiate between NIO and CIO PP's. The only valid keys are N for NIO and C for CIO. The initial default is N or the most recently entered value.

Halt Processor

Purpose The HP command unconditionally halts the CPU. If used on a dual CPU systems, the CPU that is halted is the one specified by the SE command. The initial default is CPU 0.

CAUTION

The HP command should only be used by trained individuals that understand the hardware which they are using. For example, If the user enters the HP command before he/she enters an SD T ON command, DFT recognizes that CPU as being halted and attempts to restart it.

Format HP

Start Processor

Purpose The SP command attempts to restart the CPU by restarting the microcode. Depending on the reason the processor halted this may or may not be successful. A specific microcode address may (optionally) be supplied. If used on a dual CPU system, the CPU that is started is the one specified by the SE command. The initial default is CPU 0.

Format SP
AD=micro_code_address

Parameters AD
Optional four-digit hexadecimal microcode address. If no address is supplied, the CPU is restarted from where it was stopped.

Set CPU Value

Purpose The SE command specifies which CPU is used when entering DR, ER, RF, HP, SP, DS, DK, ES, EK, CX, CE, MC, and UC commands. It also resets the MP, JP, PT, PS, and PL values on the DM command to the appropriate values for the CPU selected.

Format SE
CP=n

Parameters CP
The number of the CPU to be used for future commands which reference CPU registers. Allowed values are zero or one. The initial default is zero.

Display the Register File for a Processor

Purpose The RF command displays the register file for the CPU which has been previously selected by the SE command.

NOTE

The CPU must be halted to execute this command on some models and must be running on others.

Format RF
AD=address
WC=word_count

Parameters AD
Hexadecimal register number to display. The default value is 0.
WC
The number of entries to display (hexadecimal). The default value is 10 or the most recently entered value from a DS, DK, or RF command.

DFT COMMANDS

Display DFT Block

Purpose The DF command displays the Dedicated Fault Tolerance (DFT) control block or the contents of a DFT maintenance register buffer. Invalid register entries are suppressed. If DFT has not set the verified (or rejected) flag, the message NO DFT is output to the terminal.

NOTE

The address of the DFT control block or buffer of interest is saved so the next memory display command also displays this portion of memory.

Format DF
MB=maintenance_register_buffer_number

Parameters MB
Maintenance buffer number to display (0 through F hexadecimal). If the number is beyond the number of buffers on the specific mainframe, the command terminates. If the buffer number entered is 20 (hexadecimal), then the Model Dependent Buffer is displayed.

Set DFT Flag

Purpose The SD command sets (or clears) a flag in the DFT control word to instruct DFT to freeze on (or process) corrected, uncorrected, or to ignore errors. If the uncorrected and/or the corrected error flag is set, and the appropriate error occurs, DFT halts all CPUs, logs errors, and waits for the flag to be cleared to clear the registers and restart all processors. If the flag to ignore errors is set, DFT stops reading maintenance registers thereby ignoring any errors until the flag is cleared. If DFT has not set the verified flag, the message DFT NOT VERIFIED is output to the terminal.

NOTE

The SD command may cause the OS Bounds to be toggled for MDD.

In order to cause DFT to halt all processing when any error occurs, the user must enter both the SD U ON and SD C ON commands.

Format SD
error_type
DFT_action

Parameters error_type/U
C

This keyword indicates which flag to set (or clear) in the DFT control word by MDD. The allowed values of U for uncorrected errors and C for corrected errors cause DFT to process errors as indicated above if the flag is set or to continue normal processing if the flag is clear. The default changes when a new value is entered.

DFT_action/ON
OF

The ON keyword sets the DFT flag and the OF keyword clears the flag. The initial default is OF. The default changes when a new value is entered.

CONTROL STORE COMMANDS

Display Eight-Byte Control Store

Purpose The DS command displays 64-bit control store.

NOTE

The processor must be halted to execute this command.

Format DS
 AD=address
 TC=type_code
 WC=word_count

Parameters AD

The four-digit hexadecimal address to begin displaying the control store memory. The default is 0 or the most recently entered value from an DS, DK, ES, EK, DF, or memory command.

TC

The one-digit type_code for the desired control store. The default is 0 or the most recently entered value from a DK, DS, EK, or ES command.

WC

The number of words of control store to display. The default value is 10 or the most recently entered value from a DB, DC, DH, DS, DK, or RF command.

Display Sixteen-Byte Control Store

Purpose The DK command displays 128-bit control store.

NOTE

The CPU must be halted to execute this command.

Format DK

AD=address
TC=type_code
WC=word_count

Parameters AD

The four-digit hexadecimal address to begin displaying the control store memory. The default is 0 or the most recently entered value from an DS, DK, ES, EK, DF, or memory command.

TC

The one-digit type_code for the desired control store. The default is 0 or the most recently entered value from a DK, DS, EK, or ES command.

WC

The number of words of control store to display. The default value is 10 or the most recently entered value from a DB, DC, DH, DS, DK, or RF command.

Enter Eight-Byte Control Store

Purpose The ES command changes a word in 64-bit control store. The new values are to be entered byte-wise and are entered left justified.

NOTE

The CPU must be halted to execute this command.

Format ES
AD=address
TC=type_code
B1...Bn

Parameters AD

The four-digit hexadecimal address to begin displaying the control store memory. This parameter is required.

TC

The one-digit type_code for the desired control store. The default is 0 or the most recently entered value from a DK, DS, EK, or ES command.

B1...Bn

The new values for the bytes starting at the byte address specified by the AD parameter. Each value is a one- or two-digit hexadecimal number. One or more bytes may be changed at a time.

Enter Sixteen-Byte Control Store

Purpose The EK command changes a word in 128-bit control store. The new values are to be entered byte-wise and are entered left justified.

NOTE

The CPU must be halted to execute this command.

Format EK
AD=address
TC=type_code
B1...Bn

Parameters AD

The four-digit hexadecimal address to begin displaying the control store memory. This parameter is required.

TC

The one-digit type_code for the desired control store. The default is 0 or the most recently entered value from a DK, DS, EK, or ES command.

B1...Bn

The new values for the bytes starting at the byte address specified by the AD parameter. Each value is a one- or two-digit hexadecimal number. One or more bytes may be changed at a time.

MISCELLANEOUS COMMANDS

Return MDD PP to the Operating System

Purpose The BY command causes MDD to give up the communications port and return the PP to the operating system. MDD must then be started from the operating system console. When MDD terminates it writes into bits 48 through 37 of word INML in central memory under NOS, or byte C.MDD in word T.ENGR under NOS/BE. The following status bits are set.

<u>Bit</u>	<u>Meaning</u>
0	Set if MDD was unable to access the maintenance channel.
1	Set if MDD was unable to access the channel to the two port mux.
2	Set if MDD was used to write into a maintenance register.
3	Set if MDD was used to write into central memory.

NOTE

If MDD was initiated by CIP or standalone NOS/VE, this command responds with *ILL* and MDD continues to function normally.

Format BY

Set Refresh Mode

Purpose MDD can be run in a refresh mode that allows the user to watch registers or memory change. In refresh mode, MDD outputs an 18 (hexadecimal) and a 0C (hexadecimal) to clear the screen for most CRT terminals. The terminal should be in page mode; when operating in this refresh mode, the cursor homes to lower left.

Format SR
mode

Parameters mode/ON
OF

ON sets MDD to display in refresh mode and OF sets the refresh mode off. The initial default value is off.

Set Refresh Rate

Purpose If MDD is operating in refresh mode, the RR command allows the user to set the refreshing rate faster or slower. This allows the user to adjust the refreshing rate to his/her needs by repeating this command.

Format RR
change

Parameters change/FA
SL

This parameter has two values. FA causes the displays to be updated more rapidly and SL slows down the refreshing rate. The initial default is FA.

Display MDDs Commands

Purpose The HE command allows the user to see a brief explanation of all of the commands which are available. If the command parameter is specified, MDD displays the syntax for that command. To accommodate different screen sizes, a pause is inserted into the output of the command list to allow the user time to read the information. Pressing any key at this time causes the list to continue.

Format HE
command

Parameters command

When this optional parameter is entered, MDD displays the syntax for the desired command. If an invalid command name is entered, MDD responds with *ILL* (see Other Messages to the Terminal).

ESC KEY

Purpose The ESC key allows the user to terminate the input of a command. When MDD receives a 1B (hexadecimal), it terminates any input it has received, outputs the message *IGNORED*, and waits for new input.

OTHER MESSAGES TO THE TERMINAL

<u>Message</u>	<u>Cause of Message</u>
CHANNEL 17 HUNG	MDD shares the maintenance channel with other utilities. If this channel is hung and MDD is unable to access it, the message CHANNEL 17 HUNG appears. When this happens, all commands which access this channel no longer function.
CLEARED	After MDD does a master clear (CX) of an element, the message CLEARED is displayed.
CPU x.	MDD has set the default CPU to the value indicated by x.
CPU 0. .	Value for a nonexistent CPU. MDD has reset to the default CPU of 0.
CPU # not found.	The SE command was given with a CP parameter.
DFT NOT VERIFIED	DFT has rejected the DFT block. The SD command will not function.
ERROR	MDD has encountered an error while it was attempting to read or write a maintenance register.
ERROR Handling inactive	MDD has set the desired flag in the DFT Control Word.
ERROR Handling active	MDD has cleared the desired flag in the DFT Control Word.
IGNORED	If the user wishes to abort a command, he/she may press the ESC key. MDD then ignores the previous input. Or the F7 key has been pressed and no other driver has signaled a request for the port.
ILL	If the user enters a command which MDD does not recognize or uses improper syntax, MDD responds with *ILL*. The previous input is ignored and the user should enter the proper command and syntax. MDD also follows this protocol if it detects a character it does not recognize (for example, @).
MDD Level xx Copyright CONTROL DATA 1985 CPU y	Each time MDD acquires access to the terminal via the two port multiplexer this message is displayed. This permits the user to confirm that he/she is communicating with MDD. The xx after the word level is incremented for each update to MDD. The value y after CPU indicates the default CPU number that MDD currently is using.
MEMORY WRITE WOULD CROSS OS BOUNDS	An attempt to execute an EB or EC command would cause MDD to violate the OS Bounds register. The user should enter the AB command and try again.
MR ERROR	MDD has encountered an error while trying to access channel 15.
NO DFT	The DFT PP has not verified (or rejected) the DFT control block. The DF and SD commands do not execute.

<u>Message Center</u>	<u>Cause of Message</u>
OS BOUNDS toggled for MDD	The next execution of an EB, EC, or SD command allows MDD to reset its side of the OS Bounds register if needed.
PAGE MISSING	MDD has searched the Page Table for an address specified by a DM command and has not found the page in central memory.
PP HALTED	Indicates MDD has halted a PP.
Press any key for more HELP	The listing of the commands available to MDD has been suspended. Any key pressed causes the output to continue.
PROCESSOR HALTED	MDD has halted the currently selected CPU.
Processor MUST be HALTED to read Control Store	To execute a DS or DK command the processor must be halted.
Processor MUST be HALTED to write control store	To execute a ES or EK command the processor must be halted.
PROCESSOR STARTED	MDD has started the currently selected CPU.
SEGMENT MISSING	The Segment number provided on a DM command is either invalid or has an invalid ASID.
WRITE WOULD CROSS MEMORY BOUNDS	An attempt to execute an EB or EC command would cause MDD to violate the Memory Bounds register. The user must know how to enable write and try again.

ERROR LOG/DAYFILE MESSAGES

<u>Message Center</u>	<u>Cause of Message</u>
MDD - BAD OVERLAY LOADED.	The central memory resident MDD has improper entry points. MDD will drop out. Alert status is set.
MDD - BYE COMMAND EXECUTED.	The MDD operator has entered the BY command and directed the PP to drop.
MDD-CONSOLE MUST BE UNLOCKED.	An attempt was made to bring MDD up when the operators console was in a locked state. The operator should unlock the console. MDD will drop out. An alert status is sent.
MDD-IMPROPER ACCESS ATTEMPT.	MDD was not initiated with the proper validation. MDD will drop out. An alert status is sent.
MDD - MR ERROR.	A maintenance register error was detected at initialization time. MDD will drop out. If no PPs are hung, the operator should attempt to bring MDD up again.
MDD - NOT ALLOWED ON THIS MAINFRAME	MDD will only run in a 180-8xx mainframe (865 and 875 excluded). MDD will drop out. An alert status is sent.
MDD - NOT FOUND IN CIP DIRECTORY	MDD has searched the central memory CTI directory and has not found the resident version of MDD. Either the CIP level is less than 5 or the operating system is not at a high enough level. MDD will drop out. An alert status is sent.
MDD - NOT USED.	The wait parameter for MDD was set to allow a timeout after 15 minutes and Carrier On had not been detected from the desired port of the Two Port Mux. MDD will drop out.
MDD - TPM NOT AVAILABLE.	MDD has not been allowed access to the Two Port Mux. MDD will drop out. An alert status is sent.
MDD - VALIDATED.	MDD has successfully validated itself and begun operation.

EXAMPLES OF MDD COMMAND USAGE

```
dr i
0 0000000000000000 SS
12 0000FFFAFFFF07 OI
18 0000000000000000 MASK REGISTER
21 1F1F1F1F000007FE OS BOUNDS
30 0000000000000009 EC
40 0000000000008800 STATUS
80 0000000000000000 FS1
81 0000000000000000 FS2
A0 0000000000000003 TM
```

Display register with default IOU registers.

```
dr m
00 0000000000000000 SS
12 0041000000000000 OI
20 0100000002000000 EC
21 400000000bf60000 MEM BOUNDS
A0 0000000000000000 CEL
A4 0000000000000000 UEL1
A8 0000000000000000 UEL2
```

Display register with default memory registers.

```
er m 21 0
21 0000000000000000
```

Disable Memory Bounds.

```
er m 21 400000000bf60000
21 400000000bf60000
```

Restore Memory Bounds.

```
dr p 61
61 0000000000FF8270
```

Display register 61 of the processor.

```
dm pva=500000000 mps wc=5
* SEGMENT *005
00000000 00 00 18 00 00 10 81 09
00000008 90 00 00 00 09 09 19 83
00000010 00 00 03 40 00 00 00 18
00000018 00 00 00 02 00 FF 89 D0
00000020 8D 01 00 4A 0E 12 AC DF J ,
```

Display the first five words of EI.

```
db
00FFFA000 00 00 18 00 00 10 81 09
00FFFA008 90 00 00 00 09 09 19 83
00FFFA010 00 00 03 40 00 00 00 18
00FFFA018 00 00 00 02 00 FF 89 D0
00FFFA020 8D 01 00 4A 0E 12 AC DF J ,
```

Display the same memory with the DB command.

```
dh
01FF400 0000180000108109
01FF408 9000000009091983
01FF410 0000034000000018
01FF418 000000200FF89D0
01FF420 8D01004A0E12ACDF J ,
```

Display the same memory with the DH command.
Note: the display address is given by word address instead of byte address.

```

dc
007772000 00006000000004100411 F DHDI
007772001 00000000001102214601 IBQ A
007772002 00000064000000000030 X
007772003 00000001000777704720 H P
007772004 64010004501604526017 A D ND O

```

Display the same memory with the DC command.

```

dh,17EF65,4
017EF65 0000000000AD870 p
017EF66 0100100100000B28 (
017EF67 00FF100100000B28 (
017EF68 FE00FFFF80000000

```

Display four words of memory in hexadecimal word format.
Note: The display address is given by word address.

```

+
017EF69 00001E070000F7C0 w
017EF6A 0000100000010200
017EF6B 0000100000000180
017EF6C 0000100000000000

```

Advance to the next block of memory.

```

db wc=1 ad=bf7b29
0BF7B28 00 00 10 00 00 0A 08 70 p

```

Display one word in byte format.
Note: Address was rounded down.

```

+30
0BF7B58 00 00 10 00 00 00 01 80

```

Advance the display by 30 (hexadecimal) bytes.

```

-B58
0BF7000 90 00 00 13 00 10 41 07

```

Display memory b58 bytes lower in memory.

```

eb bf7003 1 2 3b 4

```

Change memory byte-wise.

```

db
0BF7000 90 00 00 01 02 3B 04 07

```

Display memory just changed.

```

mc
MCR = CLEAR

```

Display current MCR register flags.

```

mc 8010
MCR = DUE, SIT,

```

Display bit definitions for MCR.

```

uc 9000
UCR = PRIV FAULT, PIT

```

Display bit definitions for UCR.

```

dp a
A REGISTERS
004000 000073 000127 000145 000153
000154 000001 000147 006421 005510
000022 000001 000002 000056 004276
001460 173542 004563 777771 003551

```

Display PP A registers.

```

he rr
RR [FA/SL]
he Display a list of commands

```

Display the syntax for the RR command.

DR DISPLAY REG. CONTENTS
 ER ENTER REG. CONTENTS
 CE CLEAR ERROR ON PORT
 CX MASTER CLEAR PORT
 RF DISPLAY REG. FILE
 DS DISPLAY CONTROL STORE
 DK DISPLAY CONTROL STORE
 ES ENTER CONTROL STORE
 EK ENTER CONTROL STORE
 DC DISPLAY MEMORY C170-WORD
 DH DISPLAY MEMORY C180-WORD
 DB DISPLAY MEMORY C180-BYTE
 SP START CONTROL STORE
 EB ENTER HEX BYTE[S]
 EC ENTER A C170 WORD
 DP DISPLAY PPU REG.
 IP IDLE PP
 RP RESTART PP AT A SPECIFIED ADDR.
 SR SET REFRESH

Press any key for more HELP

q
 MC EXPLAIN MCR BITS
 UC EXPLAIN UCR BITS
 DM DISPLAY MEMORY
 HP HALT PROCESSOR
 SE SET CPU VALUE
 SD SET DFT STATE FOR ERROR ACTIONS
 DF DISPLAY DFT CONTROL BLOCK
 BY RETURN MDD PP
 AB ALLOW WRITE ACROSS OS BOUNDS
 RR SET REFRESH RATE

Any key entered from terminal.

df
 000001040F030088
 001100000032000A
 001100000032002D
 0000000000000000
 0000000000000000
 0000000000000000
 0000000000000000
 000000000000000F
 000000000000001E
 DFT = DFT VERIFIED, C170 ERROR LOGGING,

Display the DFT Control Block.
 DFT control word
 SECDED ID table Ptr.
 Maintenance Reg. Buffer Ptr.
 Model Dependent Buffer Ptr.
 NOS/VE Buffer Ptr.
 C170 Resident Buffer Ptr.
 Maint. Reg. Buff. Control Word
 Maint. Reg. Buff. Control Word
 Maint. Reg. Buff. Control Word

df 1
 00 , 0000 , 00 , FLAGS =

sd t on
 ERROR Handling inactive

sd t of
 ERROR Handling active
 se 1
 CPU 1.

se 3
 CPU # not found
 CPU 0.

ab
OS BOUNDS toggled for MDD

by
ILL

This response comes from the CIP
version.

hp
PROCESSOR HALTED

sp
PROCESSOR STARTED

EB 345F8 44 33 4?*ILL*

Illegal character entered by
mistake.

REGISTERS DISPLAYED BY MDD

For the IOU, the following are displayed and labeled accordingly.

```
00 xxxxxxxxxxxxxxxxxxxx SS
12 xxxxxxxxxxxxxxxxxxxx OI
18 xxxxxxxxxxxxxxxxxxxx MASK REGISTER
21 xxxxxxxxxxxxxxxxxxxx OS BOUNDS
30 xxxxxxxxxxxxxxxxxxxx EC
40 xxxxxxxxxxxxxxxxxxxx STATUS
80 xxxxxxxxxxxxxxxxxxxx FS1
81 xxxxxxxxxxxxxxxxxxxx FS2
A0 xxxxxxxxxxxxxxxxxxxx TM
```

For an IOU - 4 the following CIO registers are also displayed.

```
16 xxxxxxxxxxxxxxxxxxxx OI
1C xxxxxxxxxxxxxxxxxxxx MASK REGISTER
25 xxxxxxxxxxxxxxxxxxxx OS BOUNDS
34 xxxxxxxxxxxxxxxxxxxx EC
44 xxxxxxxxxxxxxxxxxxxx STATUS
84 xxxxxxxxxxxxxxxxxxxx FS1
85 xxxxxxxxxxxxxxxxxxxx FS2
A4 xxxxxxxxxxxxxxxxxxxx TM
B0 xxxxxxxxxxxxxxxxxxxx C-CH 0
B1 xxxxxxxxxxxxxxxxxxxx C-CH 1
B2 xxxxxxxxxxxxxxxxxxxx C-CH 2
B3 xxxxxxxxxxxxxxxxxxxx C-CH 3
B4 xxxxxxxxxxxxxxxxxxxx C-CH 4
B5 xxxxxxxxxxxxxxxxxxxx C-CH 5
B6 xxxxxxxxxxxxxxxxxxxx C-CH 6
B7 xxxxxxxxxxxxxxxxxxxx C-CH 7
B8 xxxxxxxxxxxxxxxxxxxx C-CH 8
B9 xxxxxxxxxxxxxxxxxxxx C-CH 9
```

For memory, the defaults are:

```
00 xxxxxxxxxxxxxxxxxxxx SS
12 xxxxxxxxxxxxxxxxxxxx OI
20 xxxxxxxxxxxxxxxxxxxx EC
21 xxxxxxxxxxxxxxxxxxxx MEM BOUNDS
A0 xxxxxxxxxxxxxxxxxxxx CEL
A4 xxxxxxxxxxxxxxxxxxxx UEL1
A8 xxxxxxxxxxxxxxxxxxxx UEL2
```

For a 990 CPU, the following memory registers are also displayed or relabeled.

```
A0 xxxxxxxxxxxxxxxxxxxx CELO
A1 xxxxxxxxxxxxxxxxxxxx CEL1
A2 xxxxxxxxxxxxxxxxxxxx CEL2
A3 xxxxxxxxxxxxxxxxxxxx CEL3
A4 xxxxxxxxxxxxxxxxxxxx UEL1
A5 xxxxxxxxxxxxxxxxxxxx UEL2
A6 xxxxxxxxxxxxxxxxxxxx UEL3
A7 xxxxxxxxxxxxxxxxxxxx UEL4
```

For the CPU, the following list is displayed for all mainframes.

```
00 xxxxxxxxxxxxxxxxxxxx SS
30 xxxxxxxxxxxxxxxxxxxx DEC
31 xxxxxxxxxxxxxxxxxxxx S
40 xxxxxxxxxxxxxxxxxxxx P
41 xxxxxxxxxxxxxxxxxxxx MPS
42 xxxxxxxxxxxxxxxxxxxx MCR
43 xxxxxxxxxxxxxxxxxxxx UCR
48 xxxxxxxxxxxxxxxxxxxx PTA
49 xxxxxxxxxxxxxxxxxxxx PTL
4A xxxxxxxxxxxxxxxxxxxx PSM
51 xxxxxxxxxxxxxxxxxxxx MDW
61 xxxxxxxxxxxxxxxxxxxx JPS
62 xxxxxxxxxxxxxxxxxxxx SIT
80 xxxxxxxxxxxxxxxxxxxx PFS
```

In addition, the following registers are displayed for a series.

810, 830 CPU

```
81 xxxxxxxxxxxxxxxxxxxx PFS1
91 xxxxxxxxxxxxxxxxxxxx CSEL
93 xxxxxxxxxxxxxxxxxxxx MCEL
```

815, 825 CPU

```
93 xxxxxxxxxxxxxxxxxxxx MCEL
```

835 CPU

```
81 xxxxxxxxxxxxxxxxxxxx PFS1
92 xxxxxxxxxxxxxxxxxxxx CCEL
93 xxxxxxxxxxxxxxxxxxxx MCEL
```

845, 866 CPU

```
81 xxxxxxxxxxxxxxxxxxxx PFS
82 xxxxxxxxxxxxxxxxxxxx PFS
83 xxxxxxxxxxxxxxxxxxxx PFS
84 xxxxxxxxxxxxxxxxxxxx PFS
85 xxxxxxxxxxxxxxxxxxxx PFS
86 xxxxxxxxxxxxxxxxxxxx PFS
87 xxxxxxxxxxxxxxxxxxxx PFS
88 xxxxxxxxxxxxxxxxxxxx PFS
89 xxxxxxxxxxxxxxxxxxxx PFS
```

990 CPU

```
81 xxxxxxxxxxxxxxxxxxxx PFS
82 xxxxxxxxxxxxxxxxxxxx PFS
83 xxxxxxxxxxxxxxxxxxxx PFS
84 xxxxxxxxxxxxxxxxxxxx PFS
85 xxxxxxxxxxxxxxxxxxxx PFS
86 xxxxxxxxxxxxxxxxxxxx PFS
87 xxxxxxxxxxxxxxxxxxxx PFS
88 xxxxxxxxxxxxxxxxxxxx PFS
89 xxxxxxxxxxxxxxxxxxxx PFS
8A xxxxxxxxxxxxxxxxxxxx PFS
8B xxxxxxxxxxxxxxxxxxxx PFS
8C xxxxxxxxxxxxxxxxxxxx PFS
8D xxxxxxxxxxxxxxxxxxxx PFS
8E xxxxxxxxxxxxxxxxxxxx PFS
8F xxxxxxxxxxxxxxxxxxxx PFS
```

GLOSSARY

A

Address

The location of a word in memory. The location is designated by number or symbolic name.

Alphanumeric Characters

The letters of the alphabet (A through Z) and the digits (0 through 9).

Binary File

A noneditable file that contains a pre-compiled program.

Cache

A high-speed memory that resides in the central processor.

CAU

Refer to Common Disk Area Utility (CAU).

CDA

Refer to Common Disk Area (CDA).

Central Memory (CM)

The main storage device whose storage cells (words) can be addressed by a computer program and from which instructions and data can be loaded directly into registers. The instructions can be executed and the data can be manipulated from these registers.

Central Memory Resident (CMR)

The low address area of central memory reserved for tables, pointers, and subroutines necessary for operation of the operating system. It is never accessible to a user's central processor program. The remainder of central memory is allocated by monitor to jobs as they are selected on a priority basis for execution.

Central Processor Unit (CPU)

The high-speed arithmetic unit that performs the addition, subtraction, multiplication, division, incrementing, logical operations, and branching instructions needed to execute programs.

Channel Number

The number of the data channel on which a peripheral device controller can be accessed.

CIP

Refer to CYBER Initialization Package.

CM

Refer to Central Memory.

CMR

Refer to Central Memory Resident.

CMRDECK

A deadstart text deck used by the NOS operating system to configure the system.

CMSE

Refer to Common Maintenance Software Executive.

CMU

Refer to Compare/Move Unit.

Coldstart

Procedure used to deadstart if the tape or disk controller has not yet been loaded with controlware or the controlware is not running.

Common Disk Area (CDA)

The disk storage area that contains a default parameter block, EI, microcode, SCD, MDD, and CEL.

Common Disk Area Utility (CAU)

The utility program CTI uses to install default parameters, EI, SCD, MDD, and microcode in the common disk area.

Common Maintenance Software Executive (CMSE)

The MSL executive program.

Common Testing and Initialization (CTI)

Common deadstart process used to load the operating system and MSL. CTI is one of the modules provided on the CIP tape.

Compare/Move Unit (CMU)

The hardware that executes the CPU instructions for moving and comparing data fields consisting of strings of 6-bit characters.

Confidence Level Testing

Testing done by CTI, HIVS, long deadstart sequence (810, 815, 825, 830, 835, and 855 only) and extended deadstart sequence (models 810 through 860 only). These programs enter data in different parts of memory and then check to see if the patterns hold.

Controller

Hardware device that connects channels to peripheral devices. For example, a tape controller might connect up to eight tape units to one channel.

Controlware

A special type of software that resides in a peripheral controller. The controlware defines the functional characteristics of the controller.

CPU

Refer to Central Processor Unit.

CTI

Refer to Common Testing and Initialization.

CYBER Initialization Package (CIP)

A release mechanism that provides CTI, HIVS/MSL, EI, SCD, MDD, and microcode on a single tape.

Deadstart

The process of initializing the system by loading controlware, components of the CIP tape, and the operating system. Coldstart and warmstart are two forms of deadstart.

Default

A system-supplied value used when you do not supply the value.

Delimiter

A character used to separate statement elements, such as words and literal constants, or other strings of text.

Device

A tape or disk unit used during system deadstart or for utility operations.

DSD

Refer to Dynamic System Display.

Dump

The process of transferring the contents of memory and registers to tape or to a printer for analysis.

Dynamic System Display (DSD)

The operating system program that provides communication between the operator and the system by accepting control information typed on the console keyboard and by displaying to the operator information pertinent to all jobs known to the system. DSD is permanently assigned to peripheral processor 1.

ECS

Refer to Extended Core Storage and to Extended Memory.

EDD

Refer to Express Deadstart Dump.

EDIT

An on-line FORTRAN utility program that is used to edit the CIP binary release tape. EDIT runs under control of an operating system such as NOS or NOS/BE. The EDIT program is distributed with MSL.

EI

Refer to Environment Interface Program.

Environment Interface Program (EI)

EI is a component of CIP for models 810 through 860 and 990.

EQPDECK

A deadstart text deck that is used to describe the hardware configuration to the operating system.

Equipment Number

A number from 0 to 7 that identifies the setting on a peripheral device controller.

Equipment Status Table (EST)

A table built and used by the operating system. A list of all peripheral devices connected to the system. Each table entry indicates the status of a particular device. EST resides in CMR.

ESM

Refer to Extended Semiconductor Memory and to Extended Memory.

EST

Refer to Equipment Status Table.

Express Deadstart Dump (EDD)

A utility that may be run at deadstart time after a system malfunction has occurred. It generates the express deadstart dump file on magnetic tape.

Express Deadstart Dump (EDD) File

File that is generated on magnetic tape by the express deadstart dump utility. This file contains memory, hardware registers, and controller memory.

Extended Core Storage (ECS)

A type of extended memory that is an option available for 6000 Computer Systems, CYBER 70 Computer Systems, and CYBER 170 Computer Systems, except for models 176, 815, 825, 835, 845, and 855. Refer to Extended Memory.

Extended Memory

An additional portion of memory available as an option. This memory can be used for program and data storage, but not for program execution. Special hardware instructions exist for transferring data between central memory and extended memory. Extended memory consists of either extended core storage (ECS), large-core memory extended (LCME), extended semiconductor memory (ESM), or unified extended memory (UEM).

Extended Semiconductor Memory (ESM)

A type of extended memory that is an option available for 6000 Computer Systems, CYBER 70 Computer Systems, and CYBER 170 Computer Systems, except for models 176, 810, 815, 825, 830, 835, 845, and 855. Refer to Extended Memory.

FCA

Refer to Field Change Announcement.

FCO

Refer to Field Change Order.

Field Change Announcement (FCA)

A chart that communicates the levels of maintenance software, hardware, CYBER Initialization Package, and operating system that have been tested and certified by Control Data to function together correctly.

Field Change Order (FCO)

The directive to install changes in Control Data equipment after normal manufacturing process.

Field Length (FL)

The number of memory words assigned to a program.

File Name Table (FNT)

A system-managed table that contains the local file name and the file type of all active files in the system, and other job control information.

File Status Table (FST)

A system-managed table that contains information pertaining to a file's location on mass storage and other job control information. Each active file in the system has an FST entry. Refer also to File Name Table.

First Level Peripheral Processor (FLPP)

The processor that is connected directly to the CYBER 170 model 176 mainframe and operates synchronously with the mainframe.

FL

Refer to Field Length.

FLPP

Refer to First Level Peripheral Processor.

FNT

Refer to File Name Table.

FST

Refer to File Status Table.

Hardware Initialization and Verification Software (HIVS)

The software package that assists CTI during deadstart. It includes the Hardware Verification Sequencer (HVS) that provides deadstart confidence-level testing.

HIVS

Refer to Hardware Initialization and Verification Software.

HIVS-TDX

The tape-to-disk utility used to build HIVS on a disk from tape.

IOU

Input/output unit (models 810 through 875). IOU is a collection of all PPs, PP channels, and related hardware.

Large Central Memory Extended (LCME)

A type of extended memory that is an option available for model 176. Refer to Extended Memory.

LCME

Refer to Large Central Memory Extended.

Maintenance Register

A register used in error detection, logging, and recovery procedures for models 865 and 875 only.

Maintenance Software Library (MSL)

A set of tests, diagnostics, and utility programs that test system components, isolate malfunctions, and monitor machine states. MSL executes off-line to the operating system.

MDD

Refer to Monitor Display Driver.

Microcode

Programs residing in control memory or control memories that cause the hardware to execute the product set or diagnostic operations. Microcode is a component of CIP for models 810 through 860.

Monitor Display Driver (MDD)

A program that monitors maintenance registers during operating system operation.

MSL

Refer to Maintenance Software Library.

Multimainframe System

A network of physically and logically connected computer systems.

NOS

Network Operating System. A standard operating system for a CYBER 180, CYBER 170, CYBER 70, or 6000 Computer System.

NOS/BE

A standard operating system for a CYBER 180, CYBER 170, CYBER 70, or 6000 Computer System. It controls the execution of programs submitted through remote terminals and maintains normal batch processing operations for jobs submitted locally.

Operating System (OS)

The set of system programs that controls the execution of computer programs and provides scheduling, error detection, input/output control, accounting, compilation, storage assignment, and other related services.

OS

Refer to Operating System.

Performance Monitor Facility Register (PMF)

A hardware register used to record system performance. Sometimes referred to as the Performance Environment Monitor Register (PEM).

Peripheral Processor (PP)

The hardware unit within the host computer that performs physical input and output through the computer's data channels.

Peripheral Processor Unit (PPU)

The hardware unit within a mainframe that performs input and output using the mainframe data channels and operates synchronously with the mainframe. Sometimes referred to as a first level peripheral processor (FLPP).

Permanent File

A mass storage file that is cataloged by the system so its location and identification are always known to the system. They are protected by the system from unauthorized access according to privacy controls specified when they are created.

PMF

Refer to Performance Monitor Facility Register.

PP

Refer to Peripheral Processor.

PPU

Refer to Peripheral Processor Unit.

RA

Refer to Relative Address.

Relative Address (RA)

The absolute machine address in central memory of the first word of a loaded program.

S/C Register

Refer to Status/Control Register.

SCD

Refer to System Console Driver.

SI Tape

Refer to System Internal Tape.

SRT

Sector Reservation Table.

Status/Control (S/C) Register

A hardware register used in error detection, logging, and recovery procedures. This register is present on all CYBER 170 computer systems. For models 865 and 875, the S/C register is replaced by a maintenance register. Refer to Maintenance Register.

System Console Driver (SCD)

An operating system program that provides an interface between the operating system and a CC634B display terminal connected to a two-port multiplexer.

System Internal (SI) Tape

A magnetic tape with fixed length physical record units of 128 decimal central memory words for coded tape and 512 decimal central memory words for binary tape. An SI tape can be labeled or unlabeled, and written on seven-track or nine-track tape.

TDX

The tape-to-disk transfer utility used to build MSL on a disk from tape.

UEM

Refer to Unified Extended Memory.

Unified Extended Memory (UEM)

A type of extended memory that is available as an option for models 810 through 875. UEM differs from other types of extended memory in that it is a portion of central memory and not a separate memory unit. Refer to Extended Memory.

Unit Number

A number that identifies a hardware device. Used to identify a hardware device when more than one device can be connected to a controller.

Warmstart

Procedure used to deadstart if the tape or disk controller is loaded and the controlware is running.

Write Ring

A circular device inserted into a tape reel indicating to the tape unit that it can write on that reel. The operating system checks for the presence of a write ring if you request it.

CIP ERROR MESSAGES

B

This appendix contains an alphabetical listing of the error messages that may appear during a CIP operation. All messages are sorted according to the first nonvariable word or character. Messages beginning with special characters (such as hyphens or asterisks) are sorted as if the special characters were not present.

Messages issued by MSL are not included here. See the appropriate MSL reference manual.

<u>Message</u>	<u>Description</u>	<u>Reporting Module</u>
ALL CPUS OFF, OS LOAD IMPOSSIBLE	At least one CPU must be turned on for the OS load to proceed.	CTI
CEJ/MEJ OPTION NOT ENABLED FOR CEJ/MEJ USAGE, ENABLE SWITCH ON DEADSTART PANEL AND DEADSTART (CR) FOR NON CEJ/MEJ USAGE	Indicates the CEJ/MEJ switch is physically set to the disable position on the deadstart panel and is not logically disabled via the Hardware Reconfiguration display. Enable the switch on deadstart panel and redeadstart to continue.	MAD
CENTRAL PROCESSOR(S) NOT ACCESSIBLE VIA MAINTENANCE CHANNEL. DEADSTART AND SELECT OPTIONS U,I,U,E TO OBTAIN EXPRESS DEADSTART DUMP.	Express Deadstart Dump determined during its initialization that the central processor is not accessible via the maintenance channel and this inaccessibility would cause a bad dump to be performed. Redeadstart and reselect EDD as directed. Since this procedure clears some of the error bits in the maintenance registers, some maintenance register information will be lost. If you are unable to complete the dump, inform CE.	EDD
-NOTE-		
THIS PROCEDURE WILL RESULT IN THE PARTIAL LOSS OF MAINTENANCE REGISTER INFORMATION. IF UNABLE TO COMPLETE THE DUMP OPERATION AFTER PERFORMING THIS PROCEDURE CONTACT A CUSTOMER ENGINEER.		
CHANNEL ACTIVE ERROR	Channel active when it is supposed to be inactive.	EBL
CHANNEL nn PARITY ERROR.	Status/Control (S/C) register error. Inform CE.	DHE
CHANNEL yy UNIT xx NOT RESPONDING	Tape unit xx on channel yy is not responding to a read request. The unit either is not ready or does not exist.	EBL
CIP COMPONENT xxxx NOT FOUND	CTI cannot find CIP component xxxx in the common disk area. Reinstall CIP. If message persists, inform CE.	LMC, EEE, EBC

<u>Message</u>	<u>Description</u>	<u>Reporting Module</u>
CM ADDRESS PARITY ERROR.	S/C register error. Inform CE.	DHE
CM NOT ACTIVE - LEVEL 3 REC.	Memory initialization cannot be performed on a level 3 recovery.	MIP
CM UNAVAILABLE, (CR) TO RE-ENTER	Indicates that an address entered during a CM memory dump option is greater than the central memory size. Press the carriage return key and reenter the address.	HDP
CMC x PARITY ERROR.	S/C register error. Inform CE.	DHE
CMC PARITY ERROR.	S/C register error. Inform CE.	DHE
xxxxxxx COMMAND TOO LONG	Indicates that during a tape-to-disk copy, TDY has encountered a command to be placed on disk that has more than 60 (decimal) characters. The xxxxxxx in the message is the name of the program or command buffer where the faulty command was found. Pressing the space bar allows TDY to truncate the command to 60 (decimal) characters and continue the operation.	TDY
CON,CSaaaa,DSbbbb FCN,CSaaaa,DSbbbb WRT,CSaaaa,DSbbbb	When attempting to generate a dump tape, a connect reject (CON), function reject (FCN), or write error (WRT) was encountered. aaaa specifies the channel converter status. bbbb specifies the controller status.	EDD
COPY ERROR xxxxxxx	Indicates that during a copy operation, the program or command buffer xxxxxxx could not be copied successfully. Pressing the space bar allows TDY to skip to the next program or command buffer and resume copying.	TDY
CPU x NOT RESPONDING	CPU x did not respond to EI function request within 1-second time limit. Inform CE.	EEE
CPU x P REGISTER PARITY ERROR.	S/C register error. Inform CE.	DHE
CS=nnnn	Device communication error (data channel converter status). Inform CE.	I/O Driver
CSU x ADDRESS PARITY ERROR	S/C register error. Inform CE.	DHE
CSU x FAULT.	S/C register error. Inform CE.	DHE

<u>Message</u>	<u>Description</u>	<u>Reporting Module</u>
CTI CYLINDER OVERFLOW	Space available on the CTI cylinder was not enough to contain the entire CTI file. This problem may have been caused by disk errors. Reformatting the disk or changing packs may resolve the problem.	ICD
CTI/MSL DISK AREA FULL	Insufficient space in the common disk area to perform an update build. Redeadstart using the CIP tape and initialize the CDA by selecting the I option on the CAU Initial Options display.	
CTI PPxx NOT RESPONDING DEADSTART ABORTED	CTI cannot communicate with the PP selected as the alternate PP. Inform CE.	APP, MDD
DATA NOT AVAILABLE FROM APP	The data requested by CTI is not available from the alternate PP.	LMC, EEE
xxxxxxx DCC ERR STAT yyyy	Indicates that the status received from the data channel converter for a tape drive (60X or 65X) shows that an error condition exists. The xxxxxxx in this message is the name of the program or command buffer that TDX was working with when the error occurred, and yyyy is the octal status word. Pressing the space bar allows TDX to request the current status word.	TDX
DEADSTART ABORTED - FATAL ERROR	The system detected a fatal error during confidence testing. Inform CE.	DHE
DEADSTART SECTOR ERROR	Indicates TDX was unable to read or write the deadstart sector. A deadstart is required.	TDX
DISK BUSY	Indicates that the disk general status has responded busy to 10000 (octal) attempts by TDX to perform a seek to read or write. Pressing the space bar allows TDX to continue the read or write attempt.	TDX
DISK CONTROLLER RESERVED	Indicates that the disk controller general status shows the multiple access disk controller continues to be reserved to another PP channel following 20 (decimal) attempts 20 (decimal) attempts to connect to the unit. TDX continues to display the message and attempts the connect until successful or until a deadstart is performed.	TDX, ICD

<u>Message</u>	<u>Description</u>	<u>Reporting Module</u>
DISK CONTROLLER TRANSFER ERROR xxxxxxx	Indicates TDX was unable to output or input the expected number of words to or from the disk controller, but that the general status indicates no errors. The xxxxxxx is the name of the program or command buffer being copied. Pressing the space bar causes TDX to retry the transfer.	TDX
DISK ERR STAT yyyy xxxxxxx	Indicates that the status received from the disk drive shows that an error condition exists. The xxxxxxx in the message is the name of the program or command buffer that TDX was working with when the error occurred, and yyyy is the octal status word. Pressing the space bar allows TDX to continue the operation, through the result may not be reliable.	TDX
DISK FUNC REJ yyyy xxxxxxx	Indicates that a function sent to the disk controller has been rejected. The xxxxxxx in this message is the name of the program or command buffer that TDX was working with when the error occurred, and the yyyy is the octal value of the function code that was rejected. Pressing the space bar allows TDX to retry the operation.	TDX
DISK FUNCTION REJECT FUNCTION = xx	The indicated function code xx was not accepted by the disk controller. xx is the function code that was rejected. Press the carriage return key to attempt an error recovery operation.	CAU
DISK UNIT RESERVED	The general status indicates the disk unit has reserved status.	ICD,CAU
DISK READ ERROR INFORM CE	CTI was unable to access disk within a predetermined number of attempts. Inform CE.	EBL
DISK STATUS ERROR STATUS = xxxx	The general status word xxxx received from the disk indicates an error condition exists. Press the carriage return key to retry the operation.	CAU,LMC,EEE
DISK UNIT RESERVED	Indicates that the disk general status shows that the disk remains reserved to another controller following 20 (decimal) attempts to connect to the disk. TDX continues to display the message and attempts the connect until successful or until a deadstart is performed.	TDX

<u>Message</u>	<u>Description</u>	<u>Reporting Module</u>
DISPLAY SPACE UNAVAILABLE FOR ADDITIONAL ERRORS.	S/C or maintenance register error. Inform CE.	DHE
DSB NOT FOUND ON DEVICE. ENTER ALTERNATE DEVICE	The deadstart file does not contain the HVS module. Enter an alternate device or install the HVS module on the same device and redeadstart.	CTI
DUMP TAPE ON CHcc EQee UNuu NOT READY (CR WHEN READY)	The dump tape equipment for an express deadstart dump is not ready. Ready the equipment and press the carriage return key to continue.	EDD
DUMP TAPE ON CHcc EQee UNuu NO WRITE RING (CR WHEN READY)	The dump tape for an express deadstart dump does not contain a write ring. Insert a write ring and press the carriage return key to continue.	EDD
ECS ERROR.	S/C register error. Inform CE.	DHE
ELBP OUT OF RANGE	The external bootstrap loader parameter (ELBP) that determines whether to load the OS, HIVS, or MSL (if present) is out of range. Inform CE.	CTI
ELEMENT NOT ACCESSIBLE	Indicates that HDP is unable to access central memory, CPU, register files, or maintenance registers as required by the option.	HDP
ERROR - ADDRESS OUT OF RANGE	The system was unable to access the specified available memory during memory initialization. Press the carriage return key to clear the display.	ZAP
ERROR CM	The system detected an error in CM during hardware verification (HIVS). Inform CE.	HIVS
ERROR CPU xx	The system detected an error in CPU xx during hardware verification (HIVS). Inform CE.	HIVS
ERROR EM	The system detected an error in EM during hardware verification (HIVS) Inform CE.	HIVS
ERROR IN (error) FATAL TO DUMP OPERATION	An error occurred during an express deadstart dump operation. Press DEADSTART to retry the dump. If message reappears, inform CE.	EDD
ERROR IN EXECUTABLE AREA	A central memory parity error occurred prior to executing a test program in the CPU.	MIP

<u>Message</u>	<u>Description</u>	<u>Reporting Module</u>
ERROR IN SECOND PPS.	S/C register error. Inform CE.	DHE
ERROR PP xx	The system detected an error in PP xx during hardware verification (HIVS). Inform CE.	HIVS
ERROR PPU xx	The system detected an error in PPU xx during hardware verification (HIVS). Inform CE.	HIVS
ERROR REG	The system detected an error during hardware verification (HIVS). Inform CE.	HIVS
ERRORS OCCURRED DURING CENTRAL MEMORY INITIALIZATION. THE FOLLOWING ADDRESSES WERE THE FIRST FAILURES ENCOUNTERED.	An error occurred during central memory initialization. Inform CE.	EEE
FLAW CYL xxxx TRK yyyy SEC zzzz	Indicates that TDX has failed in four consecutive attempts to write data to a disk sector. The values in the message are the cylinder (xxxx), track (yyyy), and the sector (zzzz), which may not be written in. Pressing the space bar allows TDX to continue the copy with another sector. The bit of the flawed sector remains set in the SRT to ensure that TDX does not attempt to use the bad sector again.	TDX
FORMATTING ERROR	Indicates an error occurred while formatting the MSL area on an 895 Disk subsystem.	TDX
FUNCTION TIMEOUT, (CR) TO RETRY	Indicates that a function issued to the printer has not been accepted. Press the carriage return key to retransmit the function.	HDP
GS=nnnn	Device communication error (general status). Inform CE.	I/O Driver
HARDWARE VERIFICATION IS UNAVAILABLE WITH A LEVEL 3 DEADSTART (BS) PREVIOUS DISPLAY	HIVS can only be executed on a level 2 or less recovery.	OIP

<u>Message</u>	<u>Description</u>	<u>Reporting Module</u>
ILLEGAL BUILD SELECTION OS FILES COULD BE DESTROYED	Indicates the build option selected could cause operating system files to be destroyed because space previously allocated to the operating system is being used. Choose an installation mode that will not destroy operating system files or deadstart and release the disk space using CTI.	TDX
ILLEGAL ENTRY	The user entered an illegal parameter during parameter entry. Press the space bar to return to the parameter display and reenter the parameter.	TDX
IMPOSSIBLE TO INSTALL PROGRAMS AND SAVE COMMAND BUFFER AREA	The operator is saving a command buffer library at cylinder xxxxxxxx. TDX does not examine the two succeeding cylinders to find a suitable starting cylinder. Deadstart is required.	TDX
INCORRECT ENTRY-EQest	Incorrect equipment with EST ordinal est was specified. Clear message and reenter command.	CTI
INSTALL ABORTED DUE TO DEVICE ERROR INFORM CE (CR) TO PROCESS DIFFERENT DEVICE	Error encountered during installation. Press the carriage return key to select a device or deadstart to exit.	ICD
INSTALLATION COMPLETE DEADSTART IS REQUIRED	Indicates TDX has completed a disk build for automatic CIP tape installation. Deadstart to continue.	TDX
INSUFFICIENT LOGICALLY ON PPS, DEADSTART ABORTED	Too many PPs have been logically turned off to permit a successful deadstart.	EEE, EBL
INTER-PP DATA TRANSFER ERROR	Indicates the tape or disk driver is unable to output or input the expected number of words to or from the other driver. The xxxxxxxx is the name of the current program or command buffer. A deadstart is required.	TDX
INTERLOCK REG. CHANNEL FULL	For CYBER 70 only. Interlock register was detected as being full and should have been empty. Inform CE.	MIP
INVALID CHANNEL ENTRY	An invalid channel number was entered. Press the carriage return key and reenter the channel number.	ZAP
INVALID ENTRY	Illegal keyin. Pressing the left blank key clears the message.	All
INVALID ENTRY	Indicates that a character that is not a member of an accepted character set as been entered. Enter a valid character to clear the error.	HDP

<u>Message</u>	<u>Description</u>	<u>Reporting Module</u>
INVALID OPTION	Illegal option was selected.	All
INVALID PROGRAM NUMBER	Undefined CTI module requested.	DHE
INVALID SELECTION, (CR) TO RETRY	Indicates that the start address is larger than the end address for a CM memory dump option. Press the carriage return key and reenter the two addresses.	HDP
IOU MARGINS SELECTED (CR) TO CONTINUE	CTI detected IOU frequency margin status selected in the maintenance registers. Press the carriage return key to proceed or return the margin switch to normal position and deadstart.	EEE
IOU MARGINS SELECTED DEADSTART ABORTED	CTI detected IOU frequency margin selected in the maintenance registers. Inform CE.	CTI
IPL NOT FOUND	First record was read from the deadstart device and its name was not IPL.	ICD
LOAD ERROR DEADSTART ABORTED	An attempt to load a module from the Maintenance Software Library or the CTI/MSL disk area failed. Inform CE.	CTI
LOGGING MAINTENANCE REGISTERS.	Maintenance register errors and DHE is writing them to the critical error log.	DHE
MAINS POWER FAILURE.	S/C register error. Inform CE.	DHE
MAINTENANCE CHANNEL TIMEOUT (DEADSTART ABORTED) INFORM CE	Maintenance channel did not respond when an attempt was made to function or transfer data to a mainframe element. Inform CE.	EEE, MIP, LMC
MAINT. REG ERROR yyyy	The system detected an error in a maintenance register during hardware verification (HIVS). Inform CE.	HVS
MEMORY MARGINS SELECTED (CR) TO CONTINUE	CTI detected central memory margins status selected in the maintenance registers. Press the carriage return key to proceed, or return switch to normal and deadstart.	LMC
MEMORY MARGINS SELECTED DEADSTART ABORTED	CTI detected central memory margins status selected in the maintenance registers. Inform CE.	CTI
MEMORY NOT ACCESSIBLE	A memory element is not accessible via the maintenance channel.	MAD
MEMORY UNAVAILABLE	Selected value exceeds memory. Clear message and reenter command.	OIP
	Operator has attempted to set the logical state of an I4 CIO RP, but none are installed.	OIP

<u>Message</u>	<u>Description</u>	<u>Reporting Module</u>
MICROCODE INITIALIZATION ERROR (DEADSTART ABORTED) INFORM CE	Processor microcode failed to complete its initialization in the prescribed time limit. Inform CE.	LMC
MIN CONFIGURATION NOT AVAILABLE	The operator attempted to load microcode, EI, or both without the required minimum system elements. CTI also displays the count of each system element. Reconfigure hardware to at least the minimum configuration.	LMC
MODULE NOT ON LIBRARY DEADSTART ABORTED	An attempt to find a module on the Maintenance Software Library failed. Inform CE.	CTI
MONITOR CONDITION REGISTER=xxxx	During central memory initialization, a nonzero monitor condition register appeared in the job exchange package after reverting to monitor mode. Inform CE.	CTI
MORE S/C REGISTER ERRORS.	There were too many errors to fit on one screen.	MIP
MR-0-2 yyyy yyyy yyyy yyyy yyyy MR-0-1 yyyy yyyy yyyy yyyy yyyy yyyy MR-0-0 yyyy yyyy yyyy yyyy yyyy yyyy	The system detected a fatal error during confidence testing. Inform CE.	DHE
MS LOAD NOT POSSIBLE ALTERNATE PP DISABLE IS SET, AND CENTRAL MEMORY INITIALIZATION HAS BEEN SELECTED BY THE OPERATOR, OR AUTOMATICALLY SET BY THE HARDWARE.	Selection of the M option after selecting power-on initialization is only allowed when word 12 of the deadstart program directs CTI to initialize the alternate PP. Select the desired option and redeadstart.	IOQ
DEADSTART AND CLEAR ALTERNATE PP DISABLE, OR DO NOT SELECT MAINFRAME INITIALIZATION.		
MSL STARTING CYLINDER UNUSABLE	Indicates that the starting cylinder and the two succeeding cylinders are unsuitable for a maintenance-only installation. A deadstart is required to reattempt the installation at another cylinder.	TDX

<u>Message</u>	<u>Description</u>	<u>Reporting Module</u>
MSL STARTING CYLINDER UNUSABLE ENTER -CR- TO USE ALTERNATE CYLINDER yyyy OR RELOAD TDX AND SELECT A NEW CYLINDER	Indicates that the starting cylinder is unusable, although one of the two succeeding cylinders is suitable for the operation. The yyyy is the cylinder which TDX has found to be suitable. Entering a CR allows TDX to prepare cylinder yyyy for the operation. Entering any other character allows TDX to request another starting cylinder.	TDX

NOTE

If the user is saving a command buffer library at cylinder xxxx, TDX displays the message IMPOSSIBLE TO INSTALL PROGRAMS AND SAVE COMMAND BUFFER AREA and does not examine the two succeeding cylinders.

xxxxxxx NAME TOO LONG	Indicates that TDX has detected a program or command buffer name on tape that contains more than seven characters. The xxxxxxx in the message is the first seven characters of the name that is too long. Entering a space bar allows TDX to skip to the next program or command buffer and continue the operation.	TDX
NM=xxx	CTI module xxx not found.	I/O Driver
NO CM AVAILABLE	An HIVS test is selected for which hardware is turned OFF via CTI or is physically not present.	HIVS
NO CP AVAILABLE	An HIVS test is selected for which hardware is turned OFF via CTI or is physically not present.	HIVS
NO PP AVAILABLE	An HIVS test is selected for which hardware is turned OFF via CTI or is physically not present.	HIVS
xxxxxxx NO TAPE WRITE RING	Indicates that a disk-to-tape copy is being attempted and that no write ring is being detected on the tape. You may, upon seeing the NO TAPE WRITE RING message, unload and dismount the tape, insert a write ring into the tape hub, and mount and reload the tape. When you press the space bar, the tape is positioned at the beginning of tape and the copy proceeds. The xxxxxxx is the name of the program or command buffer with which TDX was working.	TDX

<u>Message</u>	<u>Description</u>	<u>Reporting Module</u>
xxxxxxx NOT COPIED - END OF TAPE	Indicates TDX encountered the end-of-tape while writing program xxxxxxxx in a disk to tape copy. TDX backspaced the tape and wrote end-of-information and file marks to the tape before displaying the message. A deadstart is required.	TDX
xxxxxxx NOT FOUND	Indicates that TDX has not been able to locate a program or command buffer for which it has been searching. The xxxxxxxx in this message is the name being searched for. In the case of a tape-to-disk copy, the TDX search is initiated by a COPY FROM request. In the case of a disk-to-tape copy, the TDX search may be initiated by either a COPY FROM or COPY THRU request. For a COPY THRU request, TDX begins the search with the program entered for the COPY FROM message. Pressing the space bar returns TDX to the copy message that contains the unknown name.	TDX
OFFLINE MAINTENANCE NOT AVAILABLE	The M option was selected from the Initial Options display after deadstart from a HIVS/CIP tape.	EBL
OPERATING SYSTEM FILE NOT FOUND ON DEVICE. ENTER ALTERNATE DEVICE	The deadstart file does not contain the operating system. Enter an alternate device or install the operating system on the same device and redeadstart.	EBL
LEVEL 3 RECOVERY NOT POSSIBLE CENTRAL MEMORY INITIALIZATION HAS BEEN SELECTED BY THE OPERATOR, OR AUTOMATICALLY SET BY THE HARDWARE. DEADSTART AND SELECT DIFFERENT RECOVERY LEVEL, OR DO NOT SELECT MAINFRAME INITIALIZATION.	A level 3 recovery is not possible when power on initialization is selected. On I4 IOUs, power on initialization will be set automatically by CTI following a system power up, or when the current deadstart immediately follows an MSL load. In this case, you must change the deadstart level to less than 3.	IOQ
PAGE TABLE AREA VERIFY ERROR, (DEADSTART ABORTED) INFORM CE	A data error was detected while doing a one/zeros page check of the central memory area in which the page table is built. Inform CE.	EEE
PARITY ERROR ON DATA RCVD FROM EXT CHANNEL.	S/C register error. Inform CE.	DHE
PARITY ERROR ON DATA XMTD FROM EXTERNAL PP.	S/C register error. Inform CE.	DHE

<u>Message</u>	<u>Description</u>	<u>Reporting Module</u>
PNT FULL xxxxxxx	Indicates that the disk PNT is full. The xxxxxxx in the message is the name of the program or command buffer that filled the PNT. A deadstart is required to clear this message.	TDX
PP HUNG, (CR) TO RETRY	Indicates that communication has been lost with the PP performing the memory dump to printer. Press the carriage return key to attempt to reestablish communication.	HDP
PPnn NOT RESPONDING - FATAL ERROR - DEADSTART ABORTED	PP will not accept idle loop package or a processor (CP or PP) has not completed execution within a predefined time period. Inform CE.	MIP, LMC
PPnn STOPPED ON PARITY ERROR - PPM.	S/C register error. Inform CE.	DHE
PP UNAVAILABLE, (CR) TO RE-ENTER	Indicates that the PP chosen for the PP memory dump option physically does not exist. Press the carriage return key and reenter the desired PP number.	HDP
PPU ERROR.	S/C register error. Inform CE.	DHE
PPU UNAVAILABLE, (CR) TO RE-ENTER	Indicates that the PPU chosen for the PPC memory dump option physically does not exist. Press the carriage return key and reenter the desired PPU number.	HDP
PRINTER BUSY	Indicates that the printer is busy. When the condition clears, the message is erased from the display and HDP execution continues automatically.	HDP
PRINTER NOT READY	Indicates that the printer is not ready to accept HDP output. When the condition clears, the message is erased from the display and HDP execution continues automatically.	HDP
PROCESSOR FAULT STATUS ERROR (DEADSTART ABORTED) INFORM CE	A fault status error was detected while the processor was being initialized. Inform CE.	EEE
PROCESSOR NOT ACCESSIBLE	A processor element is not accessible on the maintenance channel.	MAD
PROCESSOR NOT RESPONDING FATAL ERROR - (DEADSTART ABORTED) INFORM CE	A processor exists, but is not responding to functions on the maintenance channel. Inform CE.	MIP

<u>Message</u>	<u>Description</u>	<u>Reporting Module</u>
PROGRAM NOT ON TAPE - mne	The program name was not found when reading the tape.	CAU
READ DISASSY PARITY ERROR.	S/C register error. Inform CE.	DHE
READ PYRAMID PARITY ERROR.	S/C register error. Inform CE.	DHE
S/C REGISTER CHANNEL FULL - FATAL ERROR.	Inform CE.	MIP
S/C REGISTER ERRORS.	This is a header for an SCR error display.	MIP, LMC
SCR ERROR yyyy	The system detected an error in a S/C register during hardware verification (HIVS). Inform CE.	HIVS
SECEDED DOUBLE BIT ERROR - QUADRANT xx, CSU y.	S/C register error. Inform CE.	DHE
SECEDED SINGLE BIT ERROR - QUADRANT xx, CSU y.	S/C register error. Inform CE.	DHE
SHUTDOWN IMMINENT.	S/C register error. Inform CE.	DHE
SMU x ERROR.	S/C register error. Inform CE.	DHE
SR-0-2 yyyy yyyy yyyy yyyy yyyy. SR-0-1 yyyy yyyy yyyy yyyy yyyy yyyy. SR-0-0 yyyy yyyy yyyy yyyy yyyy yyyy. DEADSTART ABORTED - FATAL ERROR.	S/C register error. This message indicates that the system detected a fatal error during confidence testing. Inform CE.	DHE
SRT FULL xxxxxxxL	Indicates that the disk SRT has reserved the entire available area on the disk. The xxxxxxx in this message is the name of the program or command buffer that filled the disk. A deadstart is required to clear this message.	TDX
STATUS BIT ERROR	The system detected an error when the side door port was stasured following a master clear during memory initialization. Press the DEADSTART switch to return to the Initial Options display. If the message reappears, inform CE.	ZAP

<u>Message</u>	<u>Description</u>	<u>Reporting Module</u>
xxxxxxx TAPE ERR STAT yyyy	Indicates that the status received from the tape drive shows that an error condition exists. The xxxxxxx in this message is the name of the program or command buffer that TDX was working with when the error occurred, and yyyy is the octal status word. Pressing the space bar allows TDX to attempt to continue the operation, though the result may not be reliable.	TDX
xxxxxxx TAPE FUNC REJ yyyy	Indicates that a function sent to the tape drive or data channel converter (60X or 65X) has not been accepted. The xxxxxxx in this message is the name of the program or command buffer that TDX was working with when the error occurred, and the yyyy is the octal value of the function code that was rejected. TDX tries the operation three times (including timeouts) before displaying the message. Press the space bar to allow TDX to retry the operation.	TDX
TAPE STATUS ERROR STATUS = xxxx	The general status word xxxx received from the tape indicates an error condition exists. Press the carriage return key to retry.	CAU
xxxxxxx TAPE UNIT NOT READY	Indicates that the status received from the tape drive shows that the unit is not ready. The xxxxxxx is the name of the program or command buffer with which TDX was working. Correct the not ready condition without moving the tape and press the space bar to continue.	TDX
UNABLE TO ACCESS CPU VIA MAINTENANCE CHANNEL. ENTER (CR) TO CONTINUE, OR DEADSTART AND INFORM CE.	CTI was unable to access any CPU during initialization for printer dumps via HDP. Enter (CR) to perform PP or IOU register dumps only, or inform CE.	AEI
UNABLE TO ACCESS DISK (CR) TO PROCESS DIFFERENT DEVICE	Not able to access specified device. Press the carriage return key to select a different device or deadstart to exit.	SAD, ICD
UNABLE TO ACCESS PORT (CR) TO RETRY	The system was unable to access ESM during memory initialization using the specified channel and equipment. Press the carriage return key and reenter the channel and equipment numbers.	SAD, ZAP
UNABLE TO ACCESS TAPE (CR) TO PROCESS DIFFERENT DEVICE	Not able to access specified device. Press the carriage return key to select a different device or deadstart to exit.	SAD

<u>Message</u>	<u>Description</u>	<u>Reporting Module</u>
UNABLE TO INSTALL CIP READ ONLY SWITCH ACTIVE	An attempt to install CTI to an FMD disk drive, CTI found the read-only switch depressed. Toggle the read-only switch.	ICD
UNABLE TO PERFORM -UPDATE- INSTALL. COMMON DISK AREA NOT INITIALIZED. DEADSTART AND SELECT AN -INITIAL- CIP INSTALLATION.	With the release of CIP V006, an initial install is required before any other build can be executed. Subsequent CIP releases do not require this initial build.	IOQ
UNABLE TO EXECUTE COMMON DISK AREA REQUEST. CDA HAS NOT BEEN INITIALIZED. DEADSTART REQUIRED.	With the release of CIP V006, an initial install is required before any CDA utility can be executed. Subsequent CIP releases do not require this initial build.	CAU
UNABLE TO EXECUTE COMMON DISK AREA REQUEST. CDA HAS NOT BEEN INITIALIZED. (CR) FOR OPTION DISPLAY	With the release of CIP V006, an initial install is required before any CDA utility can be executed. Subsequent CIP releases do not require this initial build.	CAU
UNABLE TO LOAD MDD. THE INTEGRITY OF CENTRAL MEMORY HAS BEEN COMPROMISED.	MDD checksum failed.	CTI
UNAVAILABLE	Operator has attempted to set the logical state of an I4 CIO PP, but none are installed.	OIP
USER CONDITION REGISTER=xxxx	During central memory initialization, a nonzero user condition register appeared in the job exchange package after reverting to monitor mode. Inform CE.	CTI
UNUSABLE DISK	Indicates that the default starting cylinder for a HIVS installation is faulty. The operator must deadstart and perform the installation to a different device.	TDX
VERIFY CM DATA ERROR	Indicates CTI encountered errors when verifying EI data written to central memory. Inform CE.	EEE
WRITING MEMORY	Each available word of central memory is written with two patterns, checking for errors on each pass. The duration of the message is a function of central memory size.	CTI

FIELD CHANGE ANNOUNCEMENT (FCA) INTERPRETATION FOR MODEL 800 COMPUTER SYSTEMS

C

The purpose of the Field Change Announcement (FCA) chart is to communicate the levels of maintenance software, hardware, CYBER Initialization Package, and operating system software (system elements) that have been tested and certified by Control Data to function correctly together. Each model 800 computer system has its own FCA. The chart is distributed monthly to FCO distribution and Control Data Engineering Services support personnel, and also accompanies each FCO. FCOs are sent to the CE responsible for the site.

Each mainframe's FCA indicates the baseline components for the machine; that is, the system element levels for the machine at first field availability. The FCA index at that time is 1. A change in one of the system elements is reflected as a new line on the FCA. Only when the change requires a change to another system element or when microcode is changed is the FCA index incremented.

The chart presents the information in grid format, which allows for little verbal explanation. Short comments are provided on the form. Additional information is provided on the ARIES system, which is accessible by the CE.

Figure C-1 shows a sample FCA chart and includes abbreviated definitions of the chart entries.

Control Data certifies that the hardware at the current FCO level works with the current levels of maintenance software, the current level of the CIP, and current level of operating systems. Control Data also ensures that operating systems released within the last 12 months will work with the current hardware level. The levels of hardware and software that are certified to work together are commonly referred to as plug and play levels.

If you have questions regarding a particular combination of system components, contact Arden Hills Field Support [Controlnet 235-3074, 800-328-9567, or (612) 482-3074] for help.

HOW TO READ THE FIELD CHANGE ANNOUNCEMENT

The Applicable System: Mainframe used at your site.

CONTROL DATA CORPORATION
19-CONFIGURATION MANAGEMENT-88

FIELD CHANGE ANNOUNCEMENTS
PRODUCT 170-843

NO. 2029860
REV. 30
PAGE 3 OF 3
DATE 8-29-84

The Mainframe Index: A function of the FCO level of the mainframe that increases only when there is an interdependency requiring a change in another system element. Often the interdependent change required is using a new level of microcode or CIP tape, but any FCO that requires a change in another hardware or software element of the mainframe will cause the index to change.

Equipment Affected: List of all equipment into which an FCO is to be installed.

Series Code: Updated with ECO installation. Reflects old and new series code of the affected equipment.

PAK Type: Pak types affected by the FCO.

FCO Number: Includes alpha character design division code.

Corequisite FCO No: FCO that must be installed at the same time.

Prerequisite FCO No: FCO that must be installed before the current change.

System Installation Hours: The approximate time for FCO installation and checkout.

Plug and Play Levels: Release levels of CIP and operating systems that work together.

The last line: The latest combination of system elements* released and supported by Control Data is shown on the last line of the System FCA form. Note: customers should avoid using combinations not described on a single line on the Field Change Announcement form.

LINE NO	C A	SERIES CODE		DESCRIPTION & SYMPTOM	PAK TYPE	FCO INFORMATION					PLUG AND PLAY LEVELS				LINE NO										
		FROM	TO			FCO NO	CO-REQ FCO NO	PRE-REQ FCO NO	SYS INST HRS	ARIES MESS-AGE	CIP	CML	NOS 2.X	NOS BE		NOS VE									
				NUS/VE V1.1.1 LEVEL 613 RELEASE																					
3		AB115A	24 25	ADD BLOWER SCREEN																					28
3		6S137A	07 08	ADD BLOWER SCREEN																					29
3		6S137A	07 08	ADD BLOWER SCREEN																					30

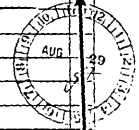

Figure C-1. How to Read the FCA Chart

PROBLEM REPORTING

D

The CIP contains hardware and software components. Hardware problems are reported differently than software problems: The TAR is the primary mechanism for reporting hardware problems; the PSR is the primary mechanism for reporting software problems. Eventually, one form will be used to report both types of problems. Until that time, report problems as you currently do:

- If a hardware problem occurs, write a TAR.
- If a software problem occurs (either maintenance software, deadstart-time software, or operating system software), write a PSR.

When CIP problems are fixed, the release vehicle of the solution is a new CIP release. Model 800 computer systems sites receive the new CIP as an FCO. Non-model-800 computer systems sites may order a new CIP tape at each release.

HARDWARE INITIALIZATION VERIFICATION SOFTWARE (HIVS) TESTS

E

The following tests, listed in alphanumeric order, are associated with the Hardware Initialization Verification Software (HIVS). Each test is briefly described.

BMEM - PPU MEMORY TEST

BMEM tests the ability of the PPU to run four word loops, with a data pattern included in the loop.

CMC - CENTRAL MEMORY CONFLICT PROGRAM

CMC compares one 12-bit word at a time with a known pattern until five words are checked. Those that do not compare produce an error message.

CMC7 - CENTRAL MEMORY CONFLICT TEST

CMC7 is similar to the CMC test. It is used with the CYBER 170 models 865 and 875.

CT3 - RANDOM INSTRUCTION TEST WITH SIMULATION

CT3 tests random instructions by generating random numbers to determine what values are used.

CT7 - CYBER 170, MODEL 175, RANDOM COMMAND TEST

CT7 tests the CPU control and the functional units. It generates and executes random instructions and operands, and checks the results against a second set of answers obtained from a simulator using other functional units.

CT73 - RANDOM INSTRUCTION TEST

CT73 is a random instruction test. In normal mode, it generates and executes random instruction sequences and random operands; it then checks the results against a second set of answers obtained from a simulator that uses other functional units. In ZIP mode, it forms a checksum from the output exchange package after each pass; it then adds this checksum to the checksum from the previous pass.

CT77 - RANDOM INSTRUCTION TEST

CT77 is similar to the CT73 test. It is used with CYBER 170 models 865 and 875.

CT8 - RANDOM INSTRUCTION TEST WITH SIMULATION

CT8 is similar to the CT3 test. It is used with models 810 through 860.

EJP - GO/NO GO EXCHANGE JUMP TEST

EJP is a go/no go test of the exchange hardware normally executed by HIVS. The test runs in any selected area of CM.

IRT - INTERLOCK REGISTER TEST

IRT tests the performance of the CYBER 70 Computer Systems interlock register and interlock channels.

LCM4 - LARGE-CORE MEMORY TEST

LCM4 detects large-core memory failures that originate in the marginal or defective LCM stack and/or logic circuits related to it.

MY1 - 65K AND 131K CENTRAL MEMORY TEST

MY1 performs data-only checks of central memory (65K and 131K). MY1 halts at address RA+132.

MY17 - 65K AND 131K CENTRAL MEMORY TEST

MY17 is similar to the MY1 test. It is used with CYBER 170 models 865 and 875.

PCX - PPU COMMAND TEST

PCX tests all instructions (other than I/O) in the PPs of the system. Each PP is checked using 100 instructions.

PCX7 - PPU COMMAND TEST

PCX7 is similar to the PCX test. It is used with CYBER 170 models 865 and 875.

SSMC - SMALL SEMICONDUCTOR CONTROL TEST

SSMC checks the control logic of the small semiconductor memory (SSM) and its related area. The test does not stress memory stack.

PERIPHERAL PROCESSOR (PP) CONFIGURATIONS

F

Table F-1 shows the channels that are not connected to an active PP for 6000 Computer Systems, CYBER 70 models 71, 72, 73, and 74, and CYBER 170 and CYBER 180 Computer Systems for the various PP configurations. A dash in the table indicates that the PP configuration for that system is not possible.

For 7, 8, 9, and 10 PP configurations, channels 0 through 13 (octal) are available. For 14, 17, and 20 PP configurations, channels 0 through 13 (octal) and 20 through 33 (octal) are available. Channel 0 is connected to an inactive PP. The other channels shown in table F-1 are not connected to a PP.

Table F-1. Channels That Are Not Connected to an Active PP

System	PP Configuration							
	7	8	9	10	14	15	17	20
6200	0, 5, 6, 7, 12, 13	0, 6, 7, 12, 13	0, 7, 12, 13	0, 12, 13	0, 3, 6, 7, 12, 13, 23, 26, 27, 32, 33	-	0, 12, 13, 23, 26, 27, 32, 33	-
6400	0, 5, 6, 7, 12, 13	0, 6, 7, 12, 13	0, 7, 12, 13	0, 12, 13	0, 3, 6, 7, 12, 13, 23, 26, 27, 32, 33	-	0, 12, 13, 23, 26, 27, 32, 33	0, 12, 13, 32, 33
6500, 6600, 6700	-	-	-	0, 12, 13	0, 3, 6, 7, 12, 13, 23, 26, 27, 32, 33	-	0, 12, 13, 23, 26, 27, 32, 33	0, 12, 13, 32, 33
CYBER 71, 72, 73, 74	-	-	-	0, 12, 13	0, 3, 6, 7, 12, 13, 23, 26, 27, 32, 33	-	0, 12, 13, 23, 26, 27, 32, 33	0, 12, 13, 32, 33
CYBER 170 Except Models 815, 825, 835, 845, and 855	-	-	-	0, 12, 13	0, 12, 13, 24, 25, 26, 27, 30, 31, 32, 33	-	0, 12, 13, 27, 30, 31, 32, 33	0, 12, 13, 32, 33
CYBER 170 Models 815, 825, 835, 845, and 855	-	-	-	0, 12, 13	-	0, 12, 13, 25, 26, 27, 30, 31, 32, 33	-	0, 12, 13, 32, 33
CYBER 180 Models 810 through 860 and 990	-	-	-	0, 12, 13	-	0, 12, 13, 25, 26, 27, 30, 31, 32, 33	-	0, 12, 13, 32, 33

MAINFRAME RECONFIGURATION

G

For most systems there are two types of reconfiguration possible: reconfiguration using CTI, and physical reconfiguration using the deadstart panel switches on the mainframe or on the Initial Deadstart display. The type of problem that has occurred determines which reconfiguration, if any, is possible. For information on reconfiguration using CTI refer to the Hardware Reconfiguration display for your model of computer system in this manual. Physical reconfiguration information is contained in this appendix.

When you have a hardware problem that does not allow deadstart to complete, you may want to change the system so that you can continue running. This can be done by reconfiguring the peripheral processors (PPs). Refer to PP Reconfiguration, next, for more information on deadstart panel PP reconfiguration. You can also decrease the amount of central memory, making a particular part of the memory inactive. Refer to CM Reconfiguration for CYBER 170 Computer Systems, later in this appendix for more information.

PP RECONFIGURATION

The system associates a number with each PP. For a given hardware configuration, the system always associates the same number with each PP. This number is called the logical PP number.

Reconfiguring the hardware causes a change in the logical PP number assignment. When the computer system is fully operational, logical PPO is associated with physical PPO memory. You can reconfigure the PPs by assigning a different physical PP as logical PPO using switches on the deadstart panel for all models except models 815 and 825. You can reconfigure PPs on models 815 and 825 by using the PP reconfiguration commands when the Initial Deadstart display appears on the console screen.

Within the hardware, PPs are grouped for orderly processing of PP instructions. Each group is called a barrel and has 4, 5, 7, or 10 PPs. Contact site personnel for more information on barrels.

For the standard physical configuration (except for models 810, 815, 825, 830, and 990), set the barrel switches to the first barrel and the PP switches (when present) to the first PP within the first barrel. For models 815 and 825, use the commands RB x and RP xx (refer to Model 810, 815, 825, 830, and 990 PP Reconfiguration later in this appendix). Normally, when the system is running, the deadstart panel (Initial Deadstart display for models 810, 815, 825, and 830) is set to the standard physical PP configuration. When you reconfigure, the logical numbers for all PPs change. For example, on a 20-PP system if you reconfigure so that PPO is the PP that was associated with physical PP number 20g in the standard configuration, the shift shown in figure G-1 occurs.

In the new configuration, the PP previously associated with the physical PP number 20g is now PPO. To get the reconfigured logical PP number assignments, exchange the numbers on the right of the first barrel in the first diagram of figure G-1 with the numbers on the right of the second barrel. This exchange is shown in the second diagram of figure G-1.

TURNING OFF PPs

You cannot turn off the hardware for PPs. Using CTI, you can logically turn off PPs capable of accepting the instruction needed to idle them. Refer to the Hardware Reconfiguration display in the section of this manual for your model of computer system.

Standard PP Configuration

First Barrel		Second Barrel	
0	0	20	20
1	1	21	21
2	2	22	22
3	3	23	23
4	4	24	24
5	5	25	25
6	6	26	26
7	7	27	27
10	10	30	30
11	11	31	31

Reconfiguration — PP0 is the PP that was PP20

First Barrel		Second Barrel	
0	20	20	0
1	21	21	1
2	22	22	2
3	23	23	3
4	24	24	4
5	25	25	5
6	26	26	6
7	27	27	7
10	30	30	10
11	31	31	11

The numbers on the left are the physical PP numbers associated with the PPs. The numbers on the right are the logical numbers the system associates with each PP.

Figure G-1. Sample Reconfiguration

PP0, 1, 2, and 10 must be on and functioning in order to deadstart. If one or more of these PPs are not functioning, you can reconfigure the PPs so that the system does not associate the bad PP with the logical PP numbers 0, 1, 2, or 10g. Then you can deadstart and turn off the bad PP. For example, on a 20-PP system under the standard PP configuration, if PP2 is not functioning you can reconfigure the PPs so that PP20 becomes PP0 (refer to figure G-2). The bad PP is now numbered 22g. You can turn off PP22 and continue operating.

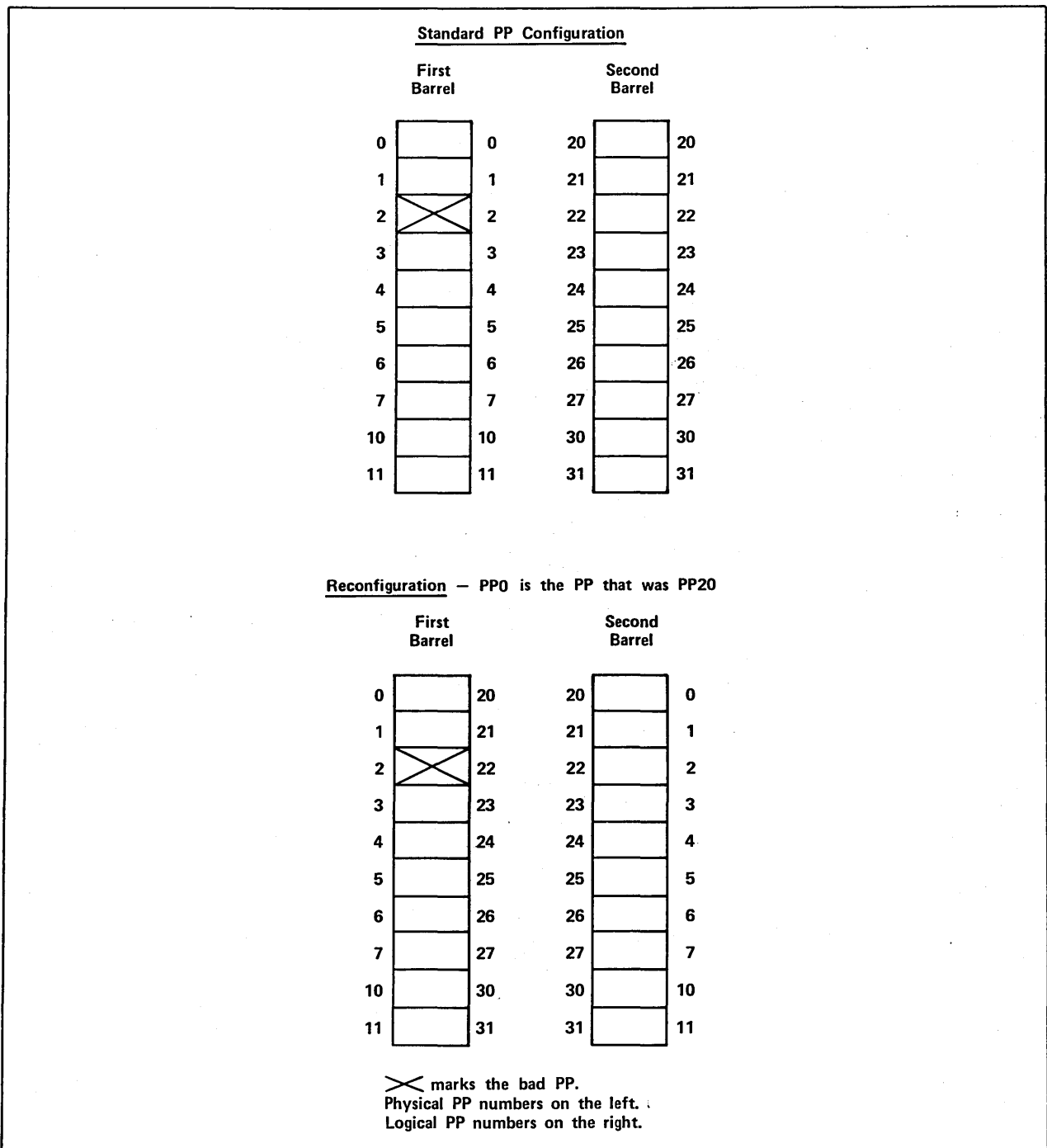

Figure G-2. Sample Reconfiguration for a Bad PP

CYBER 70/6000 COMPUTER SYSTEMS PP RECONFIGURATION

You can reconfigure the CYBER 70/6000 Computer Systems that have 14, 17, or 20 PPs (refer to table G-1). Use the deadstart panel switch labeled PPU-A to reconfigure PPs. For the standard PP configuration, the switch is in the up (0-11) position. Put the switch in the down (20-31) position to reconfigure the PPs. This shifts the logical PP numbers so that the system associates PPO with the PP that is PP20 in the standard PP configuration (refer to figure G-1). Using the PPU-A switch is the only way you can reconfigure the CYBER 70/6000 Computer Systems.

CYBER 170 COMPUTER SYSTEMS (EXCEPT MODELS 815, 825, 835, 845, AND 855) PP RECONFIGURATION

For a CYBER 170 Computer Systems (except models 815, 825, 835, 845, and 855) with 20 PPs, the most common way to reconfigure PPs is to use the deadstart panel switch labeled PPS-1 PPS-0; IOU-1 IOU-0 for models 865 and 875 (refer to table G-1). The 0 on the switch indicates the first barrel; the 1 indicates the second barrel. For the standard PP configuration, the switch is in the down (PPS-0 or IOU-0) position. To reconfigure, put it in the up (PPS-1 or IOU-1) position. This shifts the logical PP numbers so that the system associates PPO with the PP that is PP20 in the standard configuration (refer to figure G-1).

To reconfigure a CYBER 170 Computer Systems (except models 815, 825, 835, 845, and 855) with 10, 14, or 17 PPs, you must shift the logical PP numbers within barrel 0. You can do this using the PP MEMORY SELECT switches on the deadstart panel (refer to figure G-3).

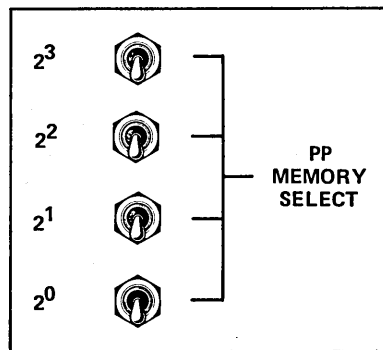

Figure G-3. PP MEMORY SELECT Switches

Choose the standard physical PP number that you want to become logical PPO. Set this number (using binary) on the PP MEMORY SELECT switches. For example, if you choose the number 5, you would set the switches as shown in figure G-4.

This causes the logical numbers of the PPs in the first diagram to shift five positions downward, the bottom numbers shifting to the top.

Table G-1. Deadstart PP Reconfiguration

<p>The following information appears in each box within the table:</p> <ol style="list-style-type: none"> 1. The possibility of reconfiguration: possible or not possible. 2. The name of the switch(es) or commands used for reconfiguration. 3. The shift of PPO that occurs when you reconfigure using the barrel switch(es) or RB x command. (PPO → PP20) means the system assigns PPO to the PP that was PP20 in the standard PP configuration.) <p>An X through a box means the given mainframe cannot have that number of PPs.</p>				
Number of PPs	CYBER Mainframes			
	6000 and 70	170 Except Models 815, 825, 835, 845, and 855	Models 810, 815, 825, and 830	Models 840, 850, 855, and 860†
10	1. Not possible.	1. Possible. 2. PP MEMORY SELECT switches.	1. Possible. 2. RP xx command. 3. No barrel reconfiguration.	1. Possible. 2. BARREL switches. 3. PPO → PP5.
14	1. Possible. 2. PPU-A switch. 3. PPO → PP20.	1. Possible. 2. PP MEMORY SELECT switches.	X	X
15	X	X	1. Possible. 2. RB x and RP xx commands. 3. PPO → PP20 (use RB1).	1. Possible. 2. BARREL switches. 3. PPO → PP20.††
17	1. Possible. 2. PPU-A switch. 3. PPO → PP20.	1. Possible. 2. PP MEMORY SELECT switches.	X	X
20	1. Possible. 2. PPU-A switch. 3. PPO → PP20.	1. Possible. 2. PPS-1 PPS-0.††† switch or IOU-1 IOU-0 switch. 3. PPO → PP20.	1. Possible. 2. RB x and RP xx commands. 3. PPO → PP20. (use RB1).	1. Possible. 2. BARREL switches. 3. PPO → PP20.††††
<p>†You can also reconfigure using the PPM switches. ††Set the BARREL switches to the second barrel (setting 01) to shift PPO to the PP that was PP20. †††You can also reconfigure using the PP MEMORY SELECT switches. ††††Set the BARREL switches to the third barrel (setting 10) to shift PPO to the PP that was PP20.</p>				

Standard PP Configuration for Barrel 0

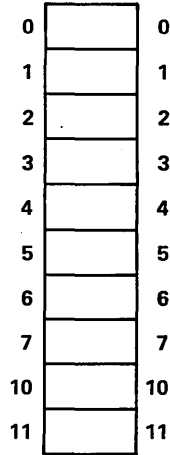

PP MEMORY SELECT
switches 2^3 through $2^0 = 0000$

Reconfiguration for Barrel 0

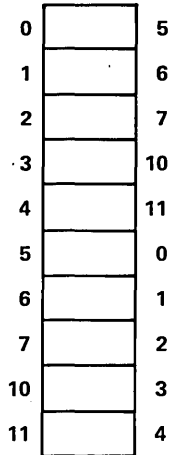

PP MEMORY SELECT
switches 2^3 through $2^0 = 0101$

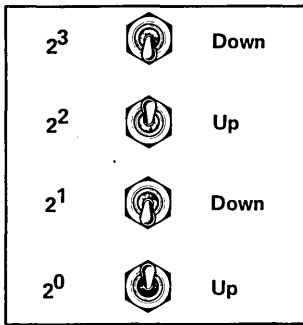

Physical numbers on the left.
Logical numbers on the right.

Figure G-4. Reconfiguration of Barrel 0 for CYBER 170 Computer Systems

After reconfiguration, each PP in barrel 0 has a new logical number. You can set the PP MEMORY SELECT switches to a number from 0 (setting 0000) to 11g (setting 1001). If you set the switches to any other number, no reconfiguration takes place.

You can also reconfigure CYBER 170 Computer Systems (except models 815, 825, 835, 845, and 855) that have 20 PPs by shifting logical numbers using the PP MEMORY SELECT switches. Set these switches as described in the previous paragraphs. When the PP MEMORY SELECT switches are set to 3 on a 20-PP system, the rotation shown in figure G-5 occurs.

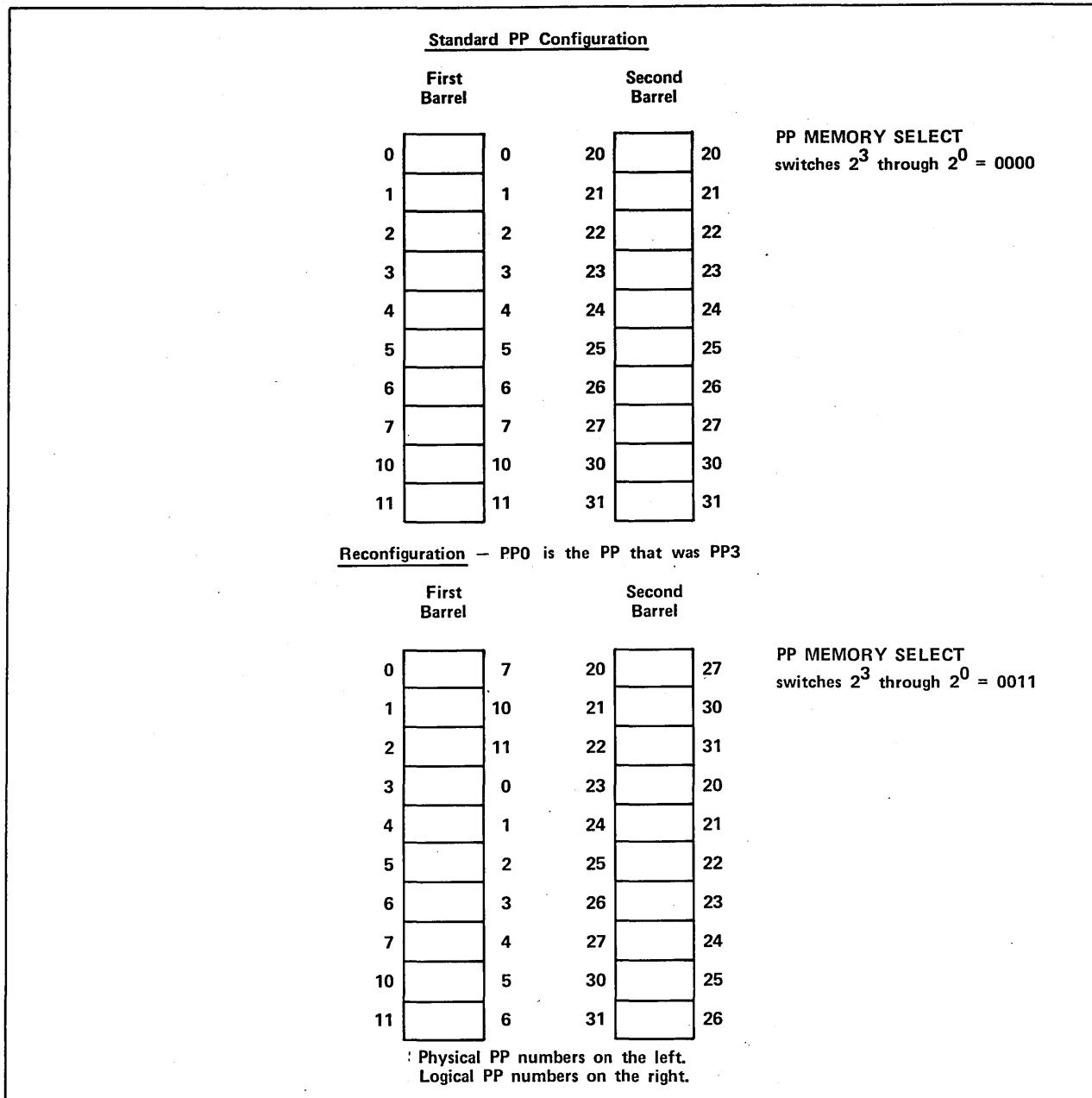

Figure G-5. Sample Reconfiguration Using the PP MEMORY SELECT Switches for CYBER 170 Computer Systems (Except Models 815, 825, 835, 845, and 855)

MODELS 835 THROUGH 860 PP RECONFIGURATION

For all models 835 through 860, the most common way to reconfigure PPs is to use the deadstart panel switches labeled BARREL (refer to table G-1). The barrels are numbered 0, 1, 10₂, and 11₂, where 0 refers to the first barrel, 1 the second, 10₂ the third, and 11₂ the fourth. For the standard PP configuration, the BARREL switches are set to 0.0. To reconfigure, set the BARREL switches to either 01, 10, or 11, depending on how many PPs you have (there are five PPs in each barrel). For example, to reconfigure on a 20-PP system, you can set the BARREL switches to the third barrel (setting 10). The shift shown in figure G-6 occurs.

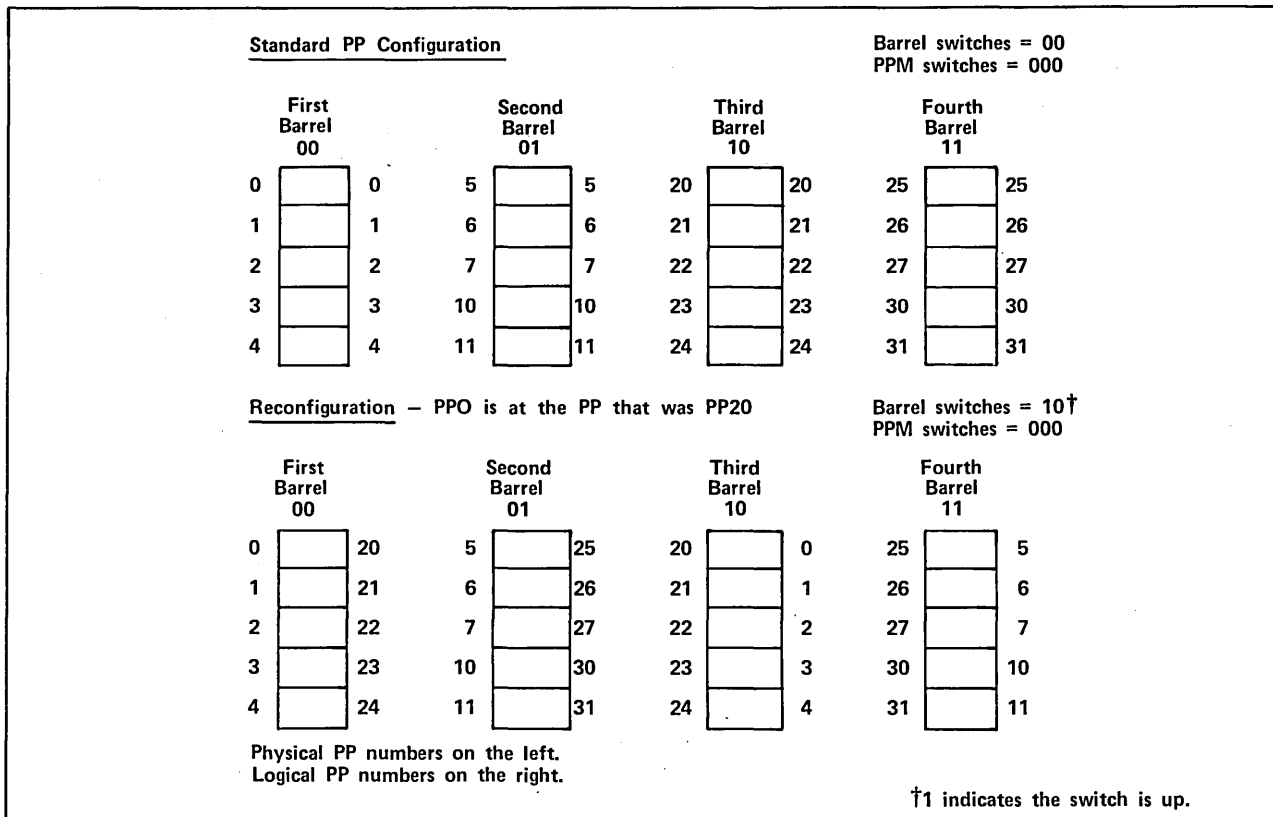

Figure G-6. Sample Model 835 through 860 PP Reconfiguration

The system associates logical PP0 with the PP that is PP20 in the standard PP configuration.

You can also reconfigure models 835, 845, and 855 computer systems by shifting logical PP numbers within each barrel. You can do this using the PPM switches on the deadstart panel (refer to figure G-7).

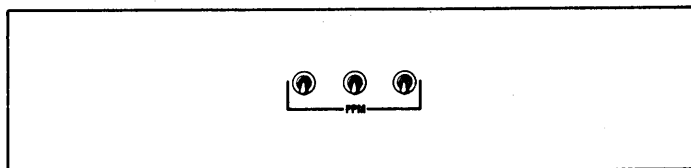

Figure G-7. PPM Switches

Choose the physical PP number that you want to become logical PPO (numbers 0 through 4). Set this number (using binary) on the PPM switches. For example, if you choose the number 3 you would set the switches as shown in figure G-8.

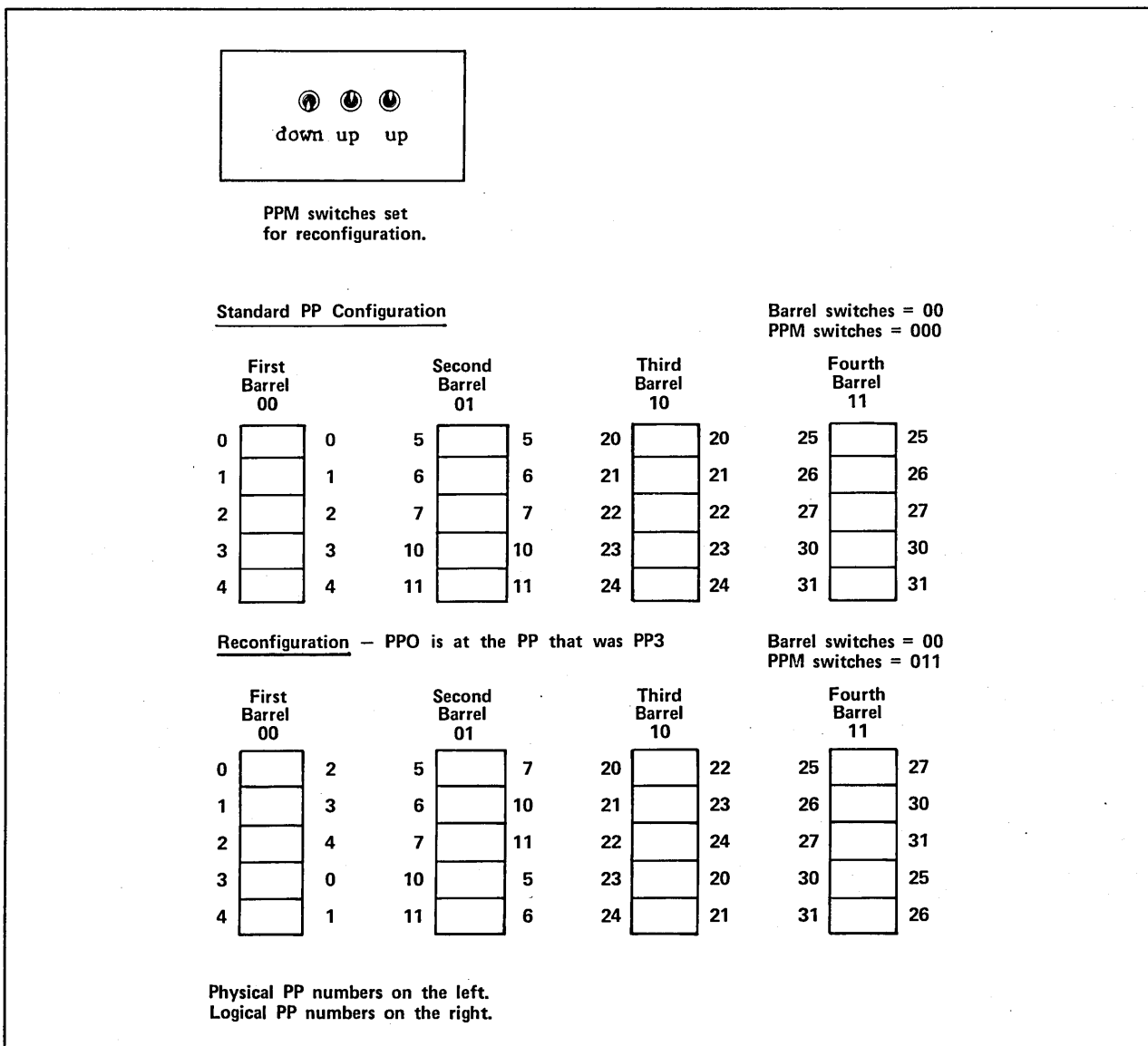

Figure G-8. Sample Model 835 through 860 Reconfiguration Using PPM Switches

MODELS 810, 815, 825, 830, AND 990 PP RECONFIGURATION

Models 810, 815, 825, 830, and 990 have one barrel if the system has 10 PPs and two barrels if the system has 15 or 20 PPs. To reconfigure the barrels, bring up the Initial Deadstart display and enter the command:

RB x

x is the number of the barrel (0 or 1) to be used as logical barrel 0 that contains PP0. The number typed appears in the message BRL CONF = near the top of the display. The other barrel becomes logical barrel 1 and contains PP20.

You can reconfigure PP memories within the barrels through the Initial Deadstart display by entering the command:

RP xx

xx is the number of the PP to be used as logical PP0 in the logical barrel 0. It also specifies which PP in logical barrel 1 is to be logical PP20. The value xx appears in the message PPM CONF = at the top of the deadstart display. Allowable values for xx vary with the number of PPs in the system.

RECONFIGURING 10-PP SYSTEM

A 10 PP system has only one barrel containing PPs 0 through 11g. You can reconfigure PPs only through the RP xx command. Legal values for xx are octal numbers from 0 to 11. The system rejects values out of this range, nonoctal numbers, and the RB command.

RECONFIGURING 15-PP SYSTEM

A system with 15 PPs has two barrels. In the standard configuration, barrel 0 contains PPs 0 through 11 and barrel 1 contains PPs 20 through 24. Using the RB x command results in interchanging PPs 0 through 4 and 20 through 24 between barrels. PPs 5 through 11 remain in barrel 0. You can reconfigure the PPs within barrels through the RP xx command. Allowable values for xx are 0 through 4. Figure G-9 illustrates PP reconfiguration for models 815 and 825 with a 15-PP system. Models 810 and 830 do not include a 15-PP configuration.

RECONFIGURING 20-PP SYSTEM

A system with 20 PPs has two barrels. In the standard configuration, barrel 0 contains PPs 0 through 11 and barrel 1 contains PPs 20 through 31.

Using the RB x command results in interchanging PPs 0 through 11 and 20 through 31 between barrels. You can reconfigure the PPs within barrels through the RP xx command. Allowable values for xx are octal numbers from 0 to 11. Figure G-10 illustrates PP reconfiguration for a 20-PP system using RB 1 and RP 03.

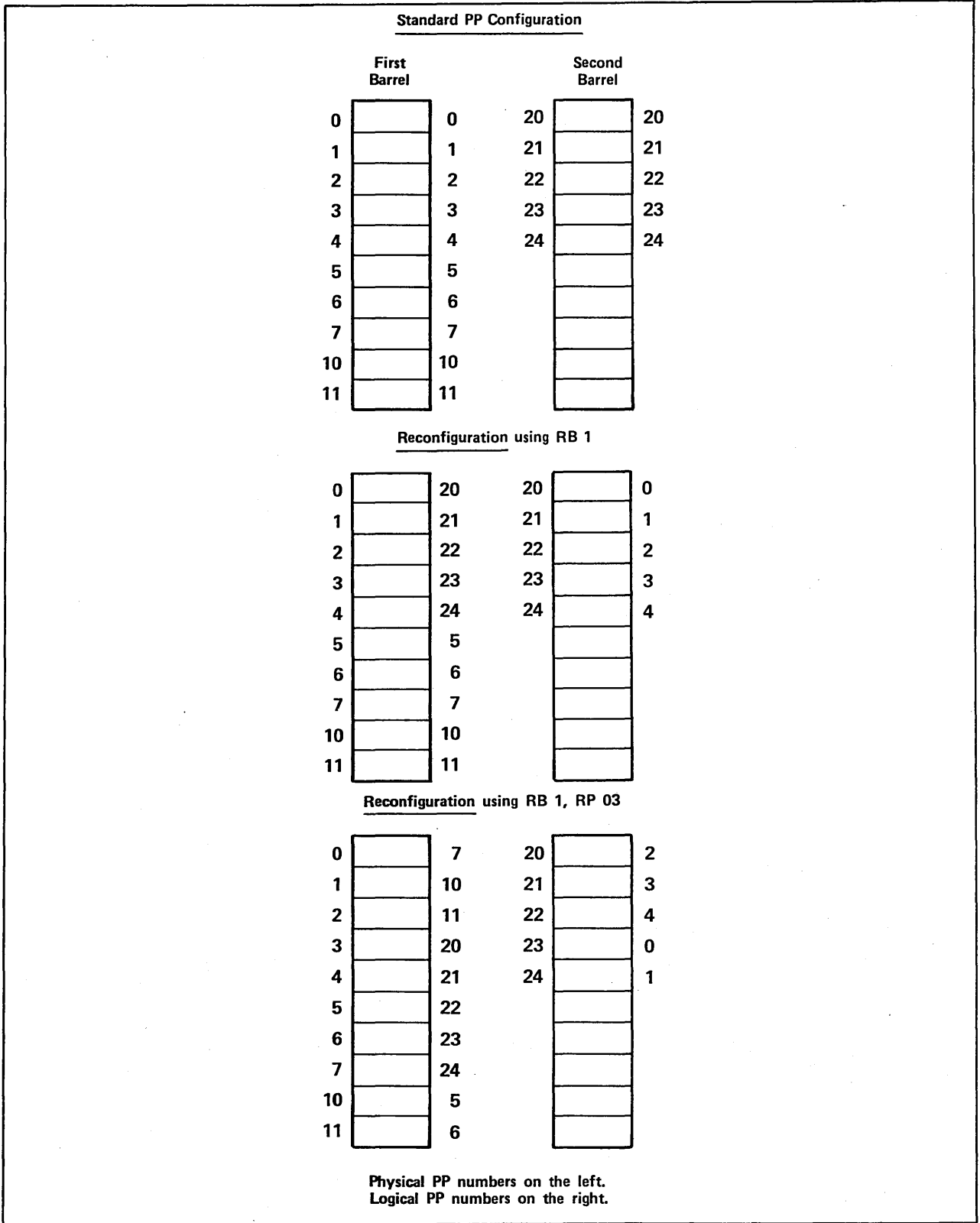

Figure G-9. Sample Reconfiguration for Models 815 and 825 With 15 PPs

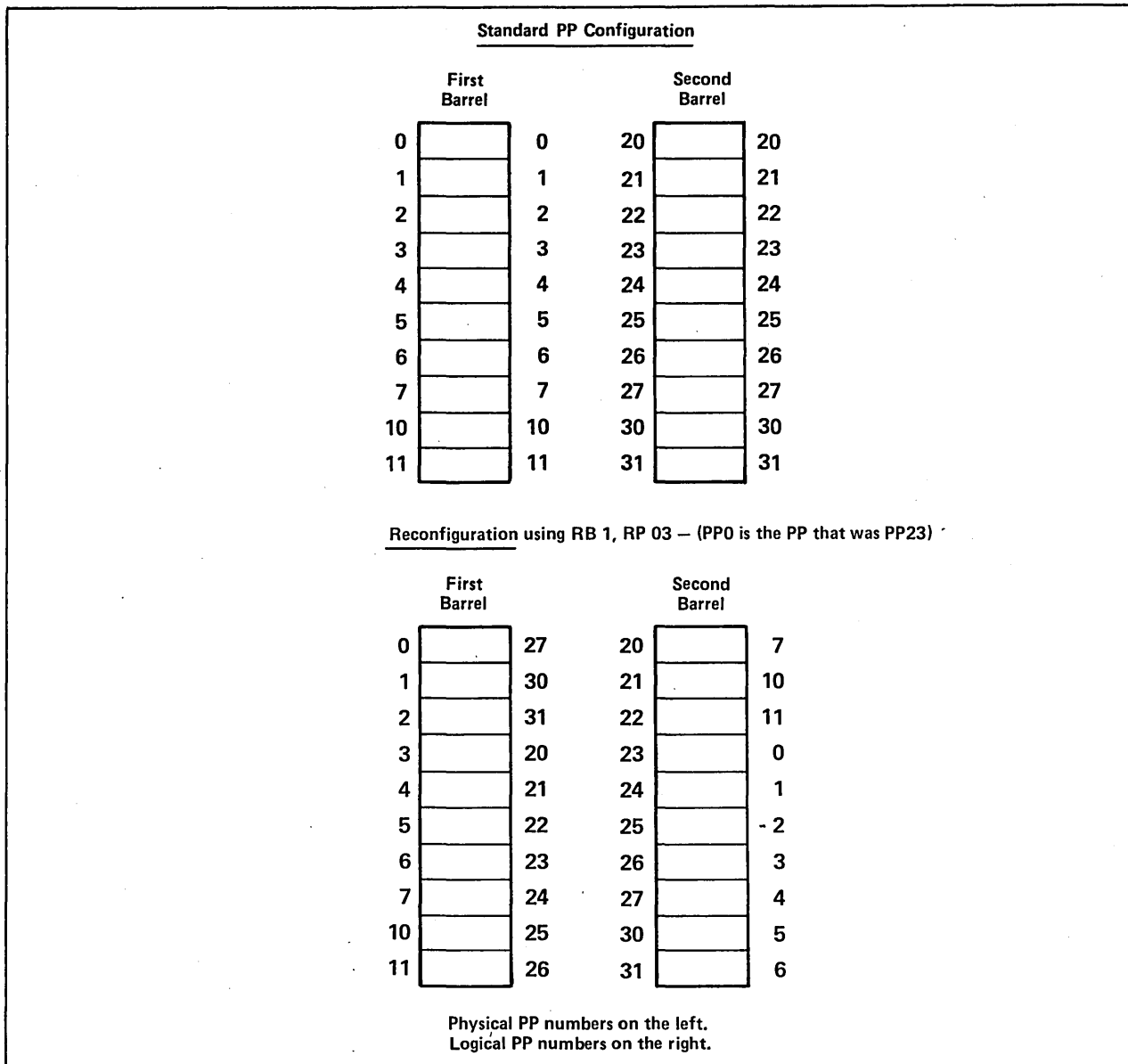

Figure G-10. Sample Reconfiguration for Models 810, 815, 825, 830, and 990 With 20 PPs

**CM RECONFIGURATION FOR CYBER 170 COMPUTER SYSTEMS
(EXCEPT MODELS 815, 825, 835, 845, AND 855)**

This subsection pertains to CYBER 170 Computer Systems (except models 815, 825, 835, 845, and 855). CM hardware reconfiguration cannot be done on 6000 or CYBER 70 Computer Systems. For CM software reconfiguration, refer to the Hardware Reconfiguration display for your model of computer system. Refer to CM Reconfiguration for models 815 through 860 later in this appendix for central memory reconfiguration information.

This documentation is valid for reconfiguring central memory down one step only. Any reconfiguration of more than one step down is not recommended.

When it is determined that central memory reconfiguration is desirable, you need to know the following information to reconfigure.

- The CYBER 170 model number.
- The normal total memory size.
- The quadrant number and CSU number (if applicable) of the defective section of memory (usually found in an S/C register† error message at deadstart).

To reconfigure central memory, use the following procedure:

1. Locate the CM configuration switches on the mainframe.
2. Locate the correct table for your CPU model (refer to tables G-2 through G-6).
3. Select from that table the correct grouping by locating the normal size of central memory from the CM Before Reconfiguration column.
4. Locate the correct line within the grouping by selecting the quadrant number (and CSU number if applicable) associated with the defective section of memory.
5. Determine the switch number order for the CM configuration switches (refer to figures G-11 and G-12).
6. Compare the settings of the CM configuration switches on your mainframe to the settings shown in the Normal Setting Switch Number column of the line identified in step 4.
7. If the CM configuration switches are shown in the Normal Setting Switch Number column, reset them to the setting shown in the Reconfiguration Setting Switch Number column and deadstart. If the CM configuration switches are not in the normal setting before the attempt to reconfigure, additional reconfiguration is not recommended.

†For models 865 and 875, S/C registers are maintenance registers.

Table G-2. CM Reconfiguration for Models 171, 172, 173, and 174

CPU Model	CM Before Reconfiguration	Quadrant	CSU	Normal Setting†							Reconfiguration Setting†							CM After Reconfiguration			
				Switch Number							Switch Number										
				1	2	3	4	5	6	7	1	2	3	4	5	6	7				
171 through 174	262K	3	1	0	0	0	0	0	0	0	0	0	0	0	1	0	0	0	196K		
		2	1	0	0	0	0	0	0	0	0	0	0	0	1	0	0	1			
		1	1	0	0	0	0	0	0	0	0	0	0	0	1	0	1	0			
		0	1	0	0	0	0	0	0	0	0	0	0	0	1	0	1	1			
		3	0	0	0	0	0	0	0	0	0	0	0	0	1	1	0	0			
		2	0	0	0	0	0	0	0	0	0	0	0	0	1	1	0	1			
		1	0	0	0	0	0	0	0	0	0	0	0	0	1	1	1	0			
		0	0	0	0	0	0	0	0	0	0	0	0	0	1	1	1	1			
196K	196K	1	1	0	0	0	1	0	0	0	1	0	0	0	0	1	0	131K			
		0	1	0	0	0	1	0	0	0	1	0	0	0	1	1					
		3	0	0	0	0	1	0	0	0	1	0	0	1	0	0					
		2	0	0	0	0	1	0	0	0	1	0	0	1	0	1					
		1	0	0	0	0	1	0	0	0	1	0	0	1	1	0					
		0	0	0	0	0	1	0	0	0	1	0	0	1	1	1					
131K	131K	3	0	1	0	0	0	0	0	0	1	0	0	1	1	0	0	98K			
		2	0	1	0	0	0	0	0	0	1	0	0	1	1	0	1				
		1	0	1	0	0	0	0	0	0	1	0	0	1	1	1	0				
		0	0	1	0	0	0	0	0	0	1	0	0	1	1	1	1				
98K	98K	2	0	1	0	0	1	0	0	0	1	1	0	0	1	0	1	65K			
		1	0	1	0	0	1	0	0	0	1	1	0	0	1	1	0				
		0	0	1	0	0	1	0	0	0	1	1	0	0	1	1	1				
65K	65K	1	0	1	1	0	0	0	0	0	1	1	1	0	1	1	0	49K			
		0	0	1	1	0	0	0	0	0	1	1	1	0	1	1	1				
49K	49K	1	0	1	1	0	1	0	0	0	1	1	1	0	1	1	0	32K			
		0	0	1	1	0	1	0	0	0	1	1	1	0	1	1	1				
32K	No reconfiguration possible																				

† 1 means up, 0 means down.

Table G-3. CM Reconfiguration for Model 175

CPU Model	CM Before Reconfiguration	Quadrant	CSU	Normal Setting†				Reconfiguration Setting†				CM After Reconfiguration	
				Switch Number				Switch Number					
				S ₀	S ₁	S ₂	S ₃	S ₀	S ₁	S ₂	S ₃		
175	262K	3	1	1	1	1	1	1	1	1	1	0	196K
		2	1	1	1	1	1	1	1	1	0	1	
		1	1	1	1	1	1	1	0	1	1	1	
		0	1	1	1	1	1	0	1	1	1	1	
		3	0	1	1	1	1	1	1	1	1	0	
		2	0	1	1	1	1	1	1	1	0	1	
		1	0	1	1	1	1	1	0	1	1	1	
		0	0	1	1	1	1	0	1	1	1	1	
	196K	2	1	1	1	1	0	1	1	0	0	0	131K
		1	1	1	1	1	0	1	0	1	0	0	
		0	1	1	1	1	0	0	1	1	0	0	
		2	0	1	1	1	0	1	1	0	0	0	
		1	0	1	1	1	0	1	0	1	0	0	
		0	0	1	1	1	0	0	1	1	1	0	
	131K	1	1	1	1	0	0	1	0	0	0	0	98K
		0	1	1	1	0	0	0	1	0	0	0	
		1	0	1	1	0	0	1	0	0	0	0	
		0	0	1	1	0	0	0	1	0	0	0	
	98K	1	1	1	1	0	0	1	0	0	0	0	65K
		0	1	1	1	0	0	Not possible					
1		0	1	1	0	0	1	0	0	0			
0		0	1	1	0	0	Not possible						
65K	No reconfiguration possible												

†1 means up, 0 means down.

Table G-4. CM Reconfiguration for Models 176, 740, 750, and 760

CPU Model	CM Before Reconfiguration	Quadrant	Normal Setting†				Reconfiguration Setting†				CM After Reconfiguration
			Switch Number				Switch Number				
			S ₀	S ₁	S ₂	S ₃	S ₀	S ₁	S ₂	S ₃	
176, 740, 750, 760	262K	3	1	1	1	1	1	1	1	0	196K
		2	1	1	1	1	1	1	0	1	
		1	1	1	1	1	1	0	1	1	
		0	1	1	1	1	0	1	1	1	
	196K	2	1	1	1	0	1	1	0	0	131K
		1	1	1	1	0	1	0	1	0	
		0	1	1	1	0	0	1	1	0	
	131K	1	1	1	0	0	1	0	0	0	65K
		0	1	1	0	0	0	1	0	0	

†1 means up, 0 means down.

Table G-5. CM Reconfiguration for Models 720 and 730

CPU Model	CM Before Reconfiguration	Quadrant	Normal Setting†					Reconfiguration Setting†					CM After Reconfiguration
			Switch Number 1 2 3 4 5					Switch Number 1 2 3 4 5					
720 and 730	262K	3	0	0	0	0	0	0	0	0	1	0	196K
		2	0	0	0	0	0	0	0	1	0	0	
		1	0	0	0	0	0	0	1	0	0	0	
		0	0	0	0	0	0	1	0	0	0	0	
196K	196K	2	0	0	0	1	0	0	0	1	1	0	131K
		1	0	0	0	1	0	0	1	0	1	0	
		0	0	0	0	1	0	1	0	0	1	0	
131K	131K	1	0	0	1	1	0	0	1	1	1	0	65K
		0	0	0	1	1	0	1	0	1	1	0	
98K	98K	1	0	0	1	1	1	0	1	1	1	0	65K
		0	No reconfiguration possible										

†1 means up, 0 means down.

Table G-6. CM Reconfiguration for Models 865 and 875

CPU Model	CM Before Reconfiguration	Quadrant	Normal Setting†				Reconfiguration Setting†				CM After Reconfiguration
			Switch Number S0 S1 S2 S3				Switch Number S0 S1 S2 S3				
865 and 875	1048K	3	1	1	1	1	1	1	1	0	786K
		2	1	1	1	1	1	1	0	1	
		1	1	1	1	1	1	0	1	1	
		0	1	1	1	1	0	1	1	1	
786K	786K	2	1	1	1	0	1	1	0	0	524K
		1	1	1	1	0	1	0	1	0	
		0	1	1	1	0	0	1	1	0	
524K	524K	1	1	1	0	0	1	0	0	0	262K
		0	1	1	0	0	0	1	0	0	

†1 means up, 0 means down.

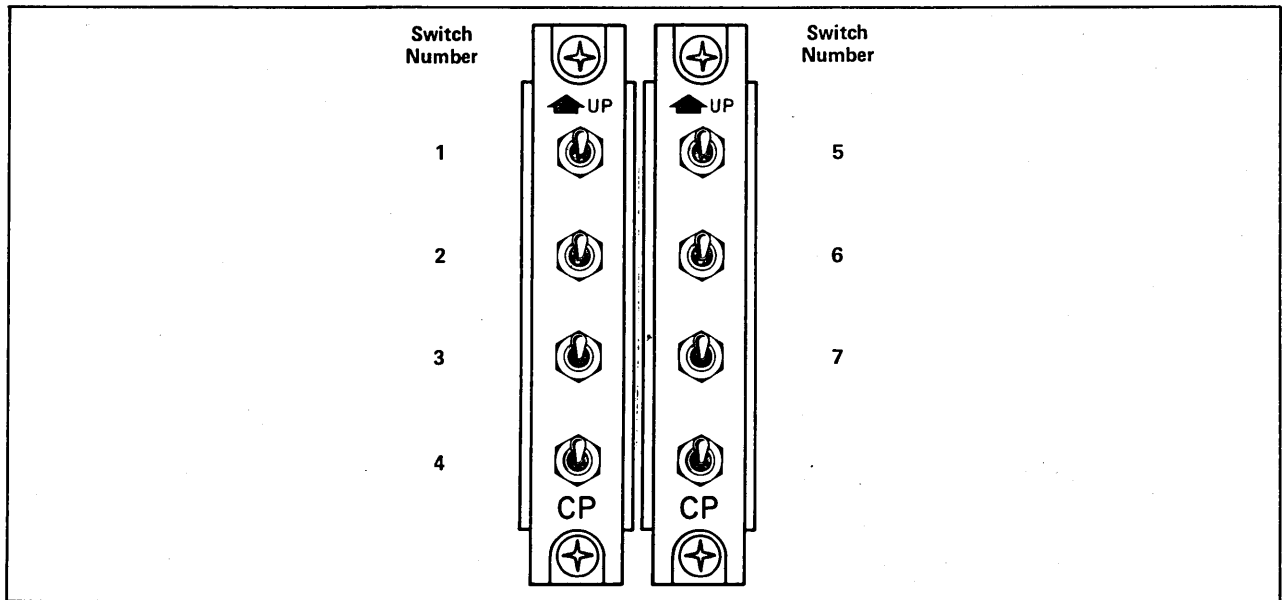

Figure G-11. Switch Numbering Scheme for CYBER 170 Computer Systems Models 171, 172, 173, 174, 720, and 730

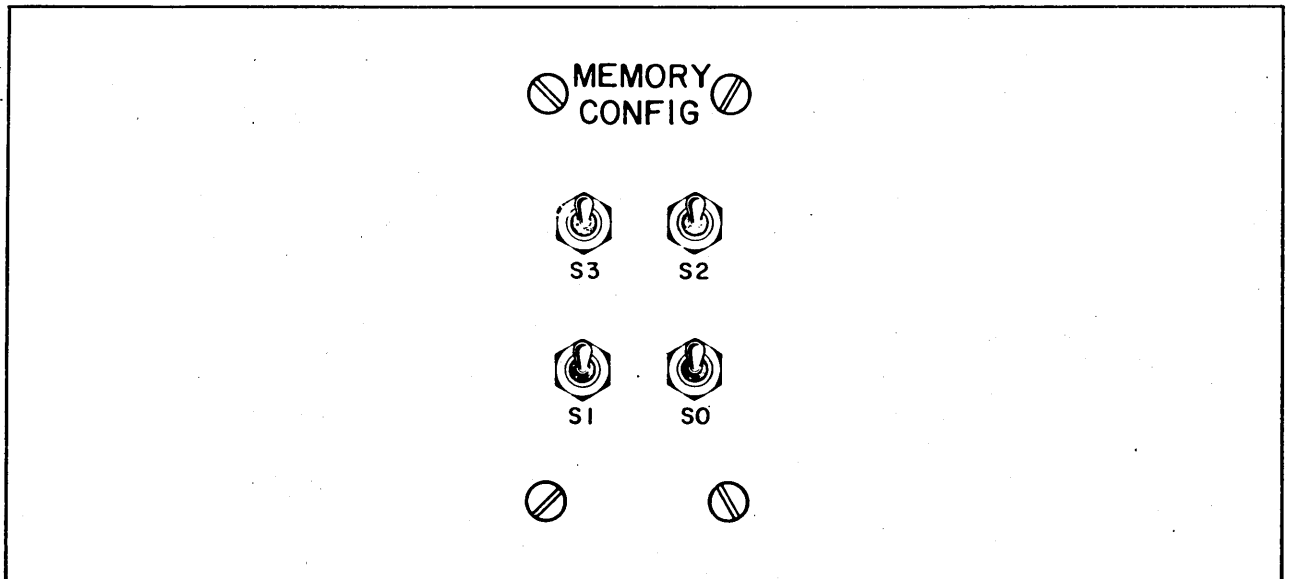

Figure G-12. Switch Numbering Scheme for CYBER 170 Computer Systems Models 175, 176, 740, 750, 760, 865, and 875

CM RECONFIGURATION FOR MODELS 810 AND 830

This subsection pertains to models 810 and 830. For CM reconfiguration using CTI, refer to the hardware reconfiguration display for your model of computer.

This documentation is valid for reconfiguring central memory down to the values shown in tables G-7 and G-9 only. Reconfiguration to values other than those shown in these tables is not recommended.

When reconfiguration is necessary or desirable, the following information is needed to reconfigure.

- The normal total memory size.
- The central memory address in the text portion of the CTI message DEADSTART ABORTED-FATAL ERROR.

Use the following procedure to reconfigure the central memory for the models 810 and 830.

1. Press the deadstart switch on a CC545 to bring up the Deadstart Options display. When a CC634B display terminal is being used as the primary operator console, complete the following steps to bring up the Deadstart Options display:
 - a. Press the RESET button to reinitialize the console.
 - b. Hold down the CTRL key while pressing the G key.
 - c. When the message *OPERATOR ACCESS ENABLED appears on the screen, hold down the CTRL key while pressing the R key.
2. Select the correct grouping from table G-7 or G-9 by locating the normal size of central memory from the CM Before Reconfiguration column.
3. Locate the correct line within the grouping by selecting the CM address shown with the CTI message.
4. If the display shows that all the CM configuration switches are centered (the display shows the letter C for each switch), reset them to the positions shown in the Reconfiguration Setting Switch Number column by entering:

SWx y

x is the switch number 2, 3, 4, 5, and y is C for center, U for up, and D for down. Then press the carriage return key.

If the switches are not centered before the attempt to reconfigure, additional reconfiguration is not recommended.

CM RECONFIGURATION FOR MODELS 815, 825, 835, 840, 845, 850, 855, 860, AND 990

This section pertains to models 815, 825, 835, 840, 845, 850, 855, and 860 only. For CM reconfiguration using CTI, refer to the Hardware Reconfiguration display for your model of computer system.

This documentation is valid for reconfiguring central memory down to the values shown in tables G-8, G-10, G-11, and G-12 only. Reconfiguration to values other than those shown in the tables is not recommended.

When reconfiguration is necessary or desirable, the following information is needed to reconfigure:

- The normal total memory size.
- The central memory address in the text portion of the CTI message DEADSTART ABORTED-FATAL ERROR (refer to OS load automatic (CR) option on the Initial Options display for your model of computer system).

Use the following procedure to reconfigure central memory.

1. Locate the CM reconfiguration switches on the mainframe.
2. Select from table G-8, G-10, G-11, or G-12 the correct grouping by locating the normal size of central memory from the CM Before Reconfiguration column.
3. Locate the correct line within the grouping by selecting the CM address shown with the CTI message.
4. If all of the CM reconfiguration switches (refer to figures G-13 and G-14 for models 815 and 825; figure G-15 for models 835, 845, and 855; and G-17 for model 990 without the memory upgrade option) are centered, reset them to the position shown in the Reconfiguration Setting Switch Number column and deadstart. If the switches are not centered before the attempt to reconfigure, additional reconfiguration is not recommended.

If all of the CM reconfiguration switches for models 840, 850, and 860 and models 845 and 855 memory upgrade option (refer to figure G-16) are down, reset them to the position shown in the Reconfiguration Setting Switch Number column and deadstart. The purpose of reconfiguration, in this case, is to move the block of memory containing the failing bit to an area of memory that is outside the portion being used in C170 state (0 - 1FF FFF). No part of memory is actually turned off; instead halves of blocks of memory are transposed.

Table G-7. CM Reconfiguration for Models 810 and 830 without Memory Upgrade Option

CM Before Reconfiguration	Normal Setting†			Address in CTI Message	Reconfiguration Setting			CM After Reconfiguration
	3	4	5		3	4	5	
4 Mbytes (524K Words)	C	C	C	< 0 3 F F F F F Σ 0 4 0 0 0 0 0	C	C	U	2 Mbytes (262K Words)
8 Mbytes (1048K Words)	C	C	C	< 0 7 F F F F F Σ 0 8 0 0 0 0 0	C	U	C	4 Mbytes (524K Words)
12 Mbytes (1572K Words)	C	C	C	< 0 F F F F F F F Σ 1 0 0 0 0 0 0	U	C	C	4 Mbytes (524K Words) 8 Mbytes (1048K Words)
16 Mbytes (2097K Words)	C	C	C	< 0 F F F F F F F Σ 1 0 0 0 0 0 0	U	C	C	8 Mbytes (1048K Words)

†C means switch is centered, U means up, and D means down.

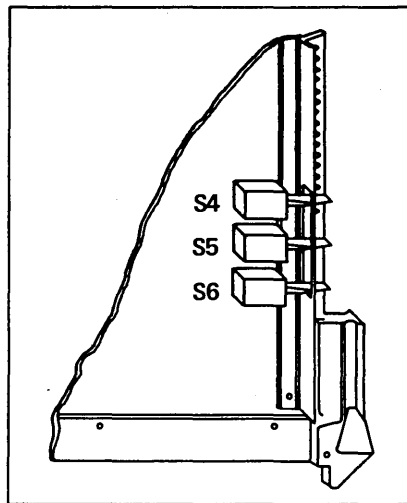

Figure G-13. Switch Numbering Scheme for Models 815 and 825 without Memory Upgrade Option

Table G-8. CM Reconfiguration for Models 815 and 825 without Memory Upgrade Option

CM Before Reconfiguration	Normal Setting†	Address in CTI Message	Reconfiguration Setting	CM After Reconfiguration
	Switch Number 4 5 6		Switch Number 4 5 6	
2 Mbytes (262K Words)	C C C	\leq 0 1 F F F F \geq 0 2 0 0 0 0	C C U C C D	1 Mbytes (131K Words)
4 Mbytes (524K Words)	C C C	\leq 0 3 F F F F \geq 0 4 0 0 0 0	C U C C D C	2 Mbytes (262K Words)
6 Mbytes (786K Words)	C C C	\leq 0 7 F F F F \geq 0 8 0 0 0 0	U C C D C C	2 Mbytes (262K Words) 4 Mbytes (524K Words)
8 Mbytes (1048K Words)	C C C	\leq 0 7 F F F F \geq 0 8 0 0 0 0	U C C D C C	4 Mbytes (524K Words)

†C means switch is centered, U means up, and D means down.

Table G-9. CM Reconfiguration for Models 810, 815, 825, and 830 with Memory Upgrade Option

CM Before Reconfiguration	Normal Setting†	Address in CTI Message	Reconfiguration Setting	CM After Reconfiguration
	Switch Number 1 2 3		Switch Number 1 2 3	
16 Mbytes (2097K Words)	C C C	\leq 0 F F F F F F \geq 1 0 0 0 0 0	C C C C C D	8 Mbytes (1049K Words) 8 Mbytes (1049K Words)
32 Mbytes (4195K Words)	C C C	\leq 1 F F F F F F \geq 2 0 0 0 0 0	C U C C D C	16 Mbytes (2097K Words) 16 Mbytes (2097K Words)

†C means switch is centered, U means up, and D means down. Switch 1 is not used.

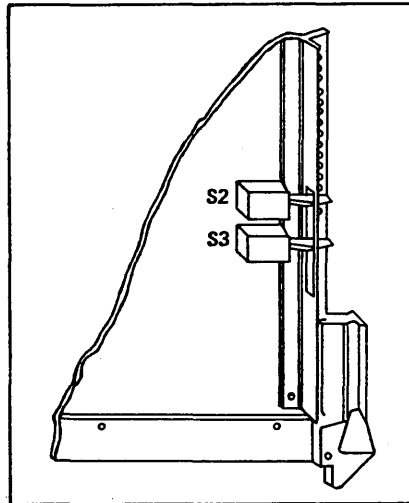

Figure G-14. Switch Numbering Scheme for Models 815 and 825 with Memory Upgrade Option.

Table G-10. CM Reconfiguration for Models 835, 845, and 855 without Memory Upgrade Option

CM Before Reconfiguration	Normal Setting†	Address in CII Message	Reconfiguration Setting†	CM After Reconfiguration
	Switch Number 3 4 5 6		Switch Number 3 4 5 6	
4 Mbytes (524K Words)	C C C C	\leq 0 3 F F F F \geq 0 4 0 0 0 0	C C U C C C D C	2 Mbytes (262K Words)
8 Mbytes (1048K Words)	C C C C	\leq 0 7 F F F F \geq 0 8 0 0 0 0	C U C C C D C C	4 Mbytes (524K Words)
12 Mbytes (1572K Words)	C C C C	\leq 0 F F F F F F \geq 1 0 0 0 0 0	U C C C D C C C	4 Mbytes (524K Words) 8 Mbytes (1048K Words)
16 Mbytes (2097K Words)	C C C C	\leq 0 F F F F F F \geq 1 0 0 0 0 0	U C C C D C C C	8 Mbytes (1048K Words)

†C means switch is centered, U means up, and D means down.

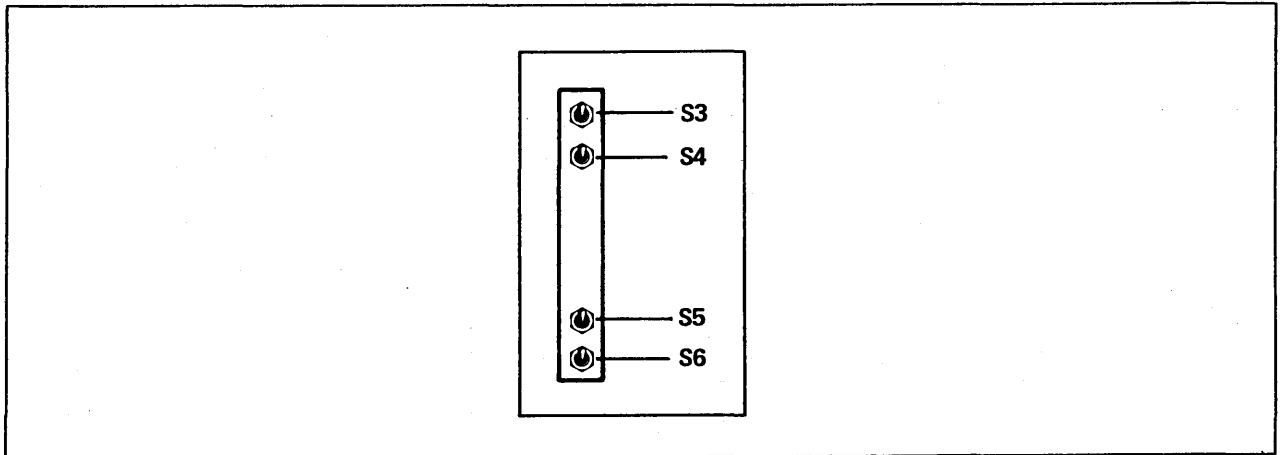

Figure G-15. Switch Numbering Scheme for Models 835, 845, and 855 without Memory Upgrade Option

Table G-11. CM Reconfiguration for Models 845 and 855 with Memory Upgrade Option and for Models 840, 850, and 860

CM Before Reconfiguration	Address in CTI Message	Reconfiguration Setting						Error Free CM After Reconfiguration
		Switch Number						
		0 Bit 37	1 Bit 38	2 Bit 39	3 Bit 40	4 Bit 41	5 Bit 42	
16 Mbytes (2097K Words)	≤ 0 F F F F F F	D	D	D	U	D	D	8 Mbytes (1049K Words) 8 Mbytes (1049K Words)
	≥ 1 0 0 0 0 0	D	D	D	D	D	D	
32 Mbytes (4195K Words)	≤ 1 F F F F F F	D	D	U	D	D	D	16 Mbytes (2097K Words)
64 Mbytes (8390K Words)	≤ 1 F F F F F F	D	U	D	D	D	D	32 Mbytes (4195K Words)
128 Mbytes (16780K Words)	≤ 1 F F F F F F	U	D	D	D	D	D	64 Mbytes (8390K Words)
NOTE								
The normal setting of all switches is down.								

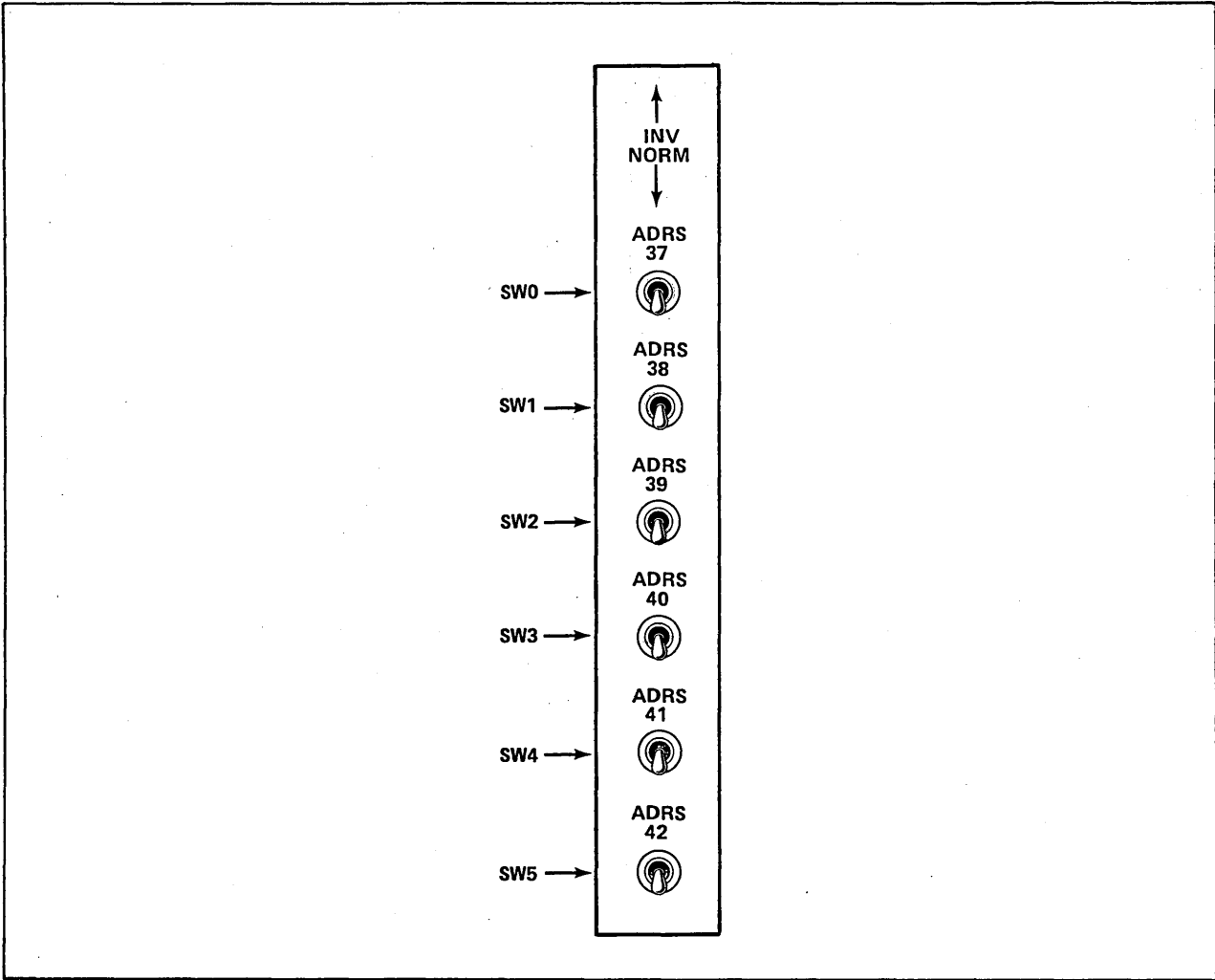

Figure G-16. Switch Numbering Scheme for Models 845 and 855 with Memory Upgrade Option and for Models 840, 850, and 860

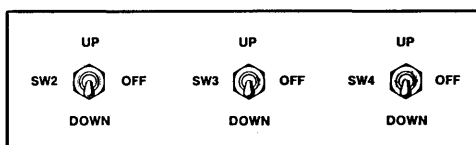

Figure G-17. Switch Numbering Scheme for Model 990

Table G-12. CM Reconfiguration for Model 990

Original CM		Reconfigured CM						
Size	Address Range	Size	Location of Failing CM			Reconfiguration Setting		
Words (MB)		Words	RMA Bit 39	RMA Bit 40	RMA Bit 41	SW2	SW3	SW4
1049K (8MB)	0-3 777 777	524K (4MB)	X	X	0	-	-	U
		524K (4MB)	X	X	1	-	-	D
2097K (16MB)	0-7 777 777	1049K (8MB)	X	0	X	-	U	-
		1049K (8MB)	X	1	X	-	D	-
3146K (24MB)	0-13 777 777	1049K (8MB)	0	0	X	-	U	-
		1049K (8MB)	0	1	X	-	D	-
		2097K (16MB)	1	0	X	D	-	-
4195K (32MB)	0-17 777 777	2097K (16MB)	0	X	X	U	-	-
		2097K (16MB)	1	X	X	D	-	-
			(1)			(2)		
Notes: 1. CM remaining can be further reconfigured by setting additional configuration switches. 2. U equals up, D equals down, and dash (-) equals center position.								

BINARY PATCH UTILITY

H

BINEDIT is the on-line patch utility that enables you to patch selected records in CTI, MSL, or HIVS. BINEDIT must run under the control of an operating system (on-line). Refer to Emergency CIP Repair Procedures - Model 800 Computer Systems in part II, section 2 for directions on installing a patched module on the disk.

ON-LINE BINARY PATCH UTILITY (BINEDIT)

BINEDIT is called by a command in a batch job, by an operator under DIS, or by a command from a terminal. BINEDIT accepts interactive directive input when called from a terminal.

The format of the BINEDIT command is:

BINEDIT,P=oldrec,N=newrec,I=dir,L=list,A.

Parameters are order independent.

<u>Parameter</u>	<u>Description</u>
oldrec	Reads old records from file oldrec. The default file name is OLD.
newrec	Writes new records on file newrec. The default file name is NEW.
dir	Gets directives from next record on file dir. The default file name is INPUT.
list	Lists output on file list. The default file name is OUTPUT.
A	Aborts after encountering any error (fatal or nonfatal). If A is omitted, BINEDIT aborts only when it encounters fatal errors.

BINEDIT DIRECTIVES

BINEDIT directives identify the record and the corresponding words to be patched within the record. The directives can reside in file INPUT or in any local file. BINEDIT directives have special format restrictions:

- A prefix character must appear in character position 1 of all directives, although the directive following a REPLACE directive has no prefix character. The prefix character must be an asterisk (*), unless explicitly changed by a PREFIX directive.
- The directive name must begin in character position 2. The directive following a REPLACE directive has no directive name.

- The directive name and the parameters are separated by characters having 6-bit display code values greater than 548; that is, none of the following is a valid separator:

A through Z 0 through 9 + - * / () \$ =

- Numeric parameter fields are decimal unless otherwise indicated.
- Embedded blanks are not permitted within a parameter, but any number of blanks can follow the directive name and any of its parameters.
- Only the directive following the REPLACE directive can span lines.
- Parameters are order dependent.
- The directive identifier (dirid) must appear in character positions 73 through 80.

Under the following directive header, dirid represents the directive identifier.

<u>Directive</u>		<u>Function</u>
pNAME,rtype/rname,rident,rcksum	dirid	Processes the binary record from the old record file (oldrec) whose record type matches rtype and whose name matches rname. Legal record types are in PP code (12-bit) or in absolute central processor (CP) code (60-bit ABS or OVL). If no record is found, a fatal error occurs. This directive terminates any previous NAME processing.
or		
pN,rtype/rname,rident,rcksum	dirid	

<u>Parameter</u>	<u>Description</u>
p	Prefix character.
rtype	Record type; must be PP or CP.
rname	Record name.
rident	Record identifier.
rcksum	Record checksum.
dirid	Directive identifier.

Parameters rident and rcksum are optional. If specified, rident is compared with the record patch identifier in the DATE field of the loader prefix (PRFX or 7700) table. rcksum is compared with the calculated checksum of the record read from oldrec. If either set does not match, BINEDIT writes an informative message and continues, unless the A parameter was specified on the BINEDIT command.

<u>Directive</u>		<u>Function</u>								
pIDENT,patchid	dirid	Writes the patch identifier patchid in the DATE field of the loader prefix table of the record written to the new record file (newrec). If no IDENT directive is encountered, a patch identifier of all blanks is written.								
or										
pI,patchid	dirid									
		<table border="0"> <thead> <tr> <th><u>Parameter</u></th> <th><u>Description</u></th> </tr> </thead> <tbody> <tr> <td>p</td> <td>Prefix character.</td> </tr> <tr> <td>patchid</td> <td>Patch identifier.</td> </tr> <tr> <td>dirid</td> <td>Directive identifier.</td> </tr> </tbody> </table>	<u>Parameter</u>	<u>Description</u>	p	Prefix character.	patchid	Patch identifier.	dirid	Directive identifier.
<u>Parameter</u>	<u>Description</u>									
p	Prefix character.									
patchid	Patch identifier.									
dirid	Directive identifier.									
pCHKSUM,chksum	dirid	Compares the expected checksum with the calculated checksum of the record written to the new record file (newrec). If they do not match, an informative message appears.								
or										
pC,chksum	dirid									
		<table border="0"> <thead> <tr> <th><u>Parameter</u></th> <th><u>Description</u></th> </tr> </thead> <tbody> <tr> <td>p</td> <td>Prefix character.</td> </tr> <tr> <td>chksum</td> <td>Expected checksum.</td> </tr> <tr> <td>dirid</td> <td>Directive identifier.</td> </tr> </tbody> </table>	<u>Parameter</u>	<u>Description</u>	p	Prefix character.	chksum	Expected checksum.	dirid	Directive identifier.
<u>Parameter</u>	<u>Description</u>									
p	Prefix character.									
chksum	Expected checksum.									
dirid	Directive identifier.									
p/ comments	dirid	Copies the comments field to the output list file. The comments field cannot exceed 69 characters.								
		<table border="0"> <thead> <tr> <th><u>Parameter</u></th> <th><u>Description</u></th> </tr> </thead> <tbody> <tr> <td>p</td> <td>Prefix character.</td> </tr> <tr> <td>comments</td> <td>User's comments.</td> </tr> <tr> <td>dirid</td> <td>Directive identifier.</td> </tr> </tbody> </table>	<u>Parameter</u>	<u>Description</u>	p	Prefix character.	comments	User's comments.	dirid	Directive identifier.
<u>Parameter</u>	<u>Description</u>									
p	Prefix character.									
comments	User's comments.									
dirid	Directive identifier.									
pPREFIX,char	dirid	Changes the prefix character in character position 1 to char for subsequent directives. The default is an asterisk (*); a blank is not a valid entry for char.								
or										
pP,char	dirid									
		<table border="0"> <thead> <tr> <th><u>Parameter</u></th> <th><u>Description</u></th> </tr> </thead> <tbody> <tr> <td>p</td> <td>Prefix character.</td> </tr> <tr> <td>char</td> <td>New prefix character.</td> </tr> <tr> <td>dirid</td> <td>Directive identifier.</td> </tr> </tbody> </table>	<u>Parameter</u>	<u>Description</u>	p	Prefix character.	char	New prefix character.	dirid	Directive identifier.
<u>Parameter</u>	<u>Description</u>									
p	Prefix character.									
char	New prefix character.									
dirid	Directive identifier.									

<u>Directive</u>		<u>Function</u>								
pREAD,altdir	dirid	Stops BINEDIT from reading directives from file dir and initiates reading them from file altdir at its current position. File altdir is read until end-of-record is encountered, after which BINEDIT resumes reading file dir. A fatal error occurs if this directive appears on file altdir.								
		<table border="0"> <thead> <tr> <th><u>Parameter</u></th> <th><u>Description</u></th> </tr> </thead> <tbody> <tr> <td>p</td> <td>Prefix character.</td> </tr> <tr> <td>altdir</td> <td>Additional directive file.</td> </tr> <tr> <td>dirid</td> <td>Directive identifier.</td> </tr> </tbody> </table>	<u>Parameter</u>	<u>Description</u>	p	Prefix character.	altdir	Additional directive file.	dirid	Directive identifier.
<u>Parameter</u>	<u>Description</u>									
p	Prefix character.									
altdir	Additional directive file.									
dirid	Directive identifier.									
pREPLACE,fwa	dirid	Replaces words beginning at the first word address fwa of the the record to be patched with the words in the next directive. The length of the record is extended if fwa is equal to the last word address plus 1 (lwa+1). fwa must be greater than the value specified in the preceding REPLACE directive for this record group. By default, fwa is octal. The postradix D specifies that fwa is decimal. If the next directive does not contain a list of words for replacement, a fatal error occurs.								
or										
pR,fwa	dirid	<table border="0"> <thead> <tr> <th><u>Parameter</u></th> <th><u>Description</u></th> </tr> </thead> <tbody> <tr> <td>p</td> <td>Prefix character.</td> </tr> <tr> <td>fwa</td> <td>First word address of the record to be patched as it would appear if the word were loaded into memory.</td> </tr> <tr> <td>dirid</td> <td>Directive identifier.</td> </tr> </tbody> </table>	<u>Parameter</u>	<u>Description</u>	p	Prefix character.	fwa	First word address of the record to be patched as it would appear if the word were loaded into memory.	dirid	Directive identifier.
<u>Parameter</u>	<u>Description</u>									
p	Prefix character.									
fwa	First word address of the record to be patched as it would appear if the word were loaded into memory.									
dirid	Directive identifier.									
word ₁ ,word ₂ ,...,word _n .	dirid	Immediately follows a REPLACE directive and provides the new content for the record being patched. word _i is either a 4-digit number (12-bit PP code) or a 20-digit number (60-bit absolute CP code). By default, word _i is octal. The postradix D indicates a decimal entry. A maximum of 10 decimal digits can be specified for CP code. Although no parameter word _i can span lines, the modification directive itself can do so. A period must follow word _n .								

Directive

Function

The word_i parameters replace words in the record beginning at address fwa, specified in the REPLACE directive. The length of the record is increased if the modifications extend beyond the last word address plus 1 (lwa+1).

<u>Parameter</u>	<u>Description</u>
word _i	Replacement for a word on the file oldrec.
dirid	Directive identifier.

BINEDIT EXAMPLE

Assume that an error has been found in the first CTI record, IPL, and that the SHN 6 instruction at address 2403 is to be replaced by one SHN 4 instruction. The following NOS Version 2 job patches the record and writes it to a file, which you can use as input to create a new deadstart tape or a system library file. CURRENT is the permanent file that contains the CTI module.

<u>Job</u>	<u>Comments</u>
job command. USER,username,password,familyname. CHARGE,*. GET,CURRENT. BINEDIT,P=CURRENT,N=NEWIPL.	Causes BINEDIT to patch records on CURRENT and to write the modified records to NEWIPL. Patching directives are to be read from the next record.
REWIND,CURRENT,NEWIPL. LIBEDIT,P=CURRENT,B=NEWIPL,N=CURRNT2.	Creates a library file containing the patched records and a permanent file containing the updated version of CTI.
SAVE,CURRNT2. --eor-- *IDENT 060580A	CTI01.1 Specifies the patch identifier.
*NAME PP/IPL, 04/16/80 , 1617	CTI01.2 Identifies the record to be patched.
*/ THIS PATCH FIXES PSR CTI01	CTI01.3 Inserts a comment.
*/	CTI01.4
*REPLACE 2403	CTI01.5 Identifies address to be patched.
1004.	CTI01.6 Identifies the new content of the address specified on REPLACE directive.
*CHKSUM 3612	CTI01.7 Specifies the expected checksum.
--eor-- *REPLACE IPL	This LIBEDIT directive creates a new library file CURRNT2 with the patched IPL record.
--eoi--	

BINEDIT generates the following list output:

<u>Output</u>	<u>Comment</u>
*IDENT 060580A	CTI01.1
*NAME PP/IPL, 04/16/80 , 1617	CTI01.2
*/ THIS PATCH FIXES PSR CTI01	CTI01.3
*/	CTI01.4
*REPLACE 2403	CTI01.5
1004.	CTI01.6
*CHKSUM 3612	CTI01.7
EDITING BEGUN	
BEGIN PATCH OF PP/IPL OLD IDENT = 04/16/80	Informative messages documenting the record and associated addresses patched by BINEDIT.
CONTENTS OF ADDRESS 2403 CHANGED	
FROM 1006 TO 1004	
CHECKSUM CHANGED OLD CHECKSUM=1617 NEW CHECKSUM=3612	
END PATCH OF PP/IPL NEW IDENT=060580A	
EDITING COMPLETE	

BINEDIT ERROR MESSAGES

Upon detecting an error, BINEDIT may display one of the following messages.

<u>Message</u>	<u>Description</u>
NO NAME DIRECTIVE	A NAME directive must appear before the CHKSUM, REPLACE, and modification directives. Ensure that a NAME directive precedes the other directives and retry.
NO REPLACE DIRECTIVE	You must specify a REPLACE directive. Specify a REPLACE directive and retry.
NO TERMINATOR	The last word of each modification directive must terminate with a nonblank separator in or before column 72. If this is the last modification line, the terminator must be a nonblank separator other than a period.
OLD CHECKSUM MISMATCH	The expected checksum specified on the NAME directive does not match the calculated checksum of the unmodified record read from the old record file. Refer to the contents of the OLD CHECKSUM in the preceding CHECKSUM CHANGED line of the output report. BINEDIT aborts only if the A parameter appears in the BINEDIT command. If the job aborted, ensure that the two checksums match and rerun; otherwise, no action is required.
PARAMETER TRUNCATED xxxx	An optional parameter contains too many characters. xxxx is the parameter in truncated form. BINEDIT aborts only if the A parameter appears in the BINEDIT command. If the job aborted, ensure that the parameter in question has a proper character length and rerun job; otherwise, no action is required.

Message

Description

RECORD NOT FOUND rtype/rname

The system could not find on the old record file a record matching the name (rname) and type (rtype) defined in the NAME directive.

Ensure that the name and type of records defined in the NAME directive match those of the records in the old record file and retry.

(

(

CC634B CONSOLE INITIALIZATION

I

Before a CC634B console can be configured as a primary console, you must first establish its operational state by installing a specific subset of its parameters. Although the initial installation procedure is somewhat lengthy, once you have performed it, you can accomplish the same results by pressing the RESET button on the console.

The following lists are parameters that require initialization.

Terminal Installation Parameters:

F4 Configuration (binary value)

Bit 1 = 1: Auto select enabled

F6 Auto Select Mode (octal value)

First character = 1: CYBER mode selected

CYBER Mode Installation Parameters:

F2 Configuration (binary value)

Bit 1 = 1: Mode execution enabled

Bit 6 = 0: Host interface

F3 Configuration (binary value)

Bit 3 = 0: Host communications to have 7 data bits (excluding parity)

Bit 4 = 1: Parity in host communications enabled

Bit 5 = 1: Parity is even/mark

Bit 6 = 0: Words in host communications to have 1 stop bit

F4 Configuration (binary value)

Bit 1 = 1: DTR switched off during local operations

Bit 2 = 0: RTS constant

F5 Configuration (binary value)

Bit 1 = 0: Pacing disabled

Bit 2 = 1: Bias enabled

F6 Operation Default Parameters (hexadecimal value):

First hexadecimal character (binary power of 2 representation)

- Bit 2⁰ = 0: On-line
- Bit 2¹ = 0: Printer deselected

Second hexadecimal character (binary power of 2 representation)

- Bit 2³ = 1: Large CYBER

Third hexadecimal character (binary power of 2 representation)

- Bit 2⁰ = 0: Background dark
- Bit 2¹ = 0: Cursor line
- Bit 2² = 0: Cursor blink

Fourth hexadecimal character (binary power of 2 representation)

- Bit 2⁰ = 1: Full duplex
- Bit 2¹ = 0: 80 characters per line
- Bit 2² = 1: 30 lines
- Bit 2³ = 0: Transparent feature off

F9 Default File Number, Transmit/Receive Baud Rate (hexadecimal value):

Third character is transmit baud rate in bits per second (bps) as follows:

<u>Value</u>	<u>Baud Rate</u>	<u>Value</u>	<u>Baud Rate</u>
4	300 bps	8	2400 bps
5	600 bps	9	4800 bps
6	1200 bps	A	9600 bps
7	1800 bps	B	19200 bps

Fourth character is receive baud rate. Refer to transmit baud rate for values.

NOTE

This procedure assumes that the CC634B display terminal with no internal options installed is connected to a two-port multiplexer and is operational.

Complete the following steps to initialize a CC634B console.

1. Turn on the console. The Mode Selection display appears on the screen. This display consists of a row of 10 lighted blocks across the bottom of the screen. Go to step 3. If the Mode Selection display does not appear, complete step 2.
2. If the console has been previously configured to automatically select an operational mode, the Mode Selection display does not appear. In this situation, wait 60 seconds for a load time-out to occur. After 60 seconds, the Mode Selection display should appear. If it does not, complete the following steps.
 - a. Press the SETUP key.
 - b. Press the F10 key twice.

The Mode Selection display should now appear.

3. Hold down the CTRL key while you press the SETUP key. The default terminal installation parameters appear in a row of lighted blocks on the screen. Refer to the 721-21/31 Owner's Manual listed in the preface for a description of this display.

NOTE

A small blinking light (cursor) appears in the F2 block. The cursor highlights where the next character you type on the keyboard will appear on the screen.

4. Press the F4 key to position the cursor under the F4 block (CONFIG).
5. Press the I key to set auto select enabled.
6. Press the F6 key to position the cursor under the F6 block (AS X Y).
7. Press the I key to select mode 1, CYBER mode.
8. Press the COPY key to write the terminal installation parameters into nonvolatile memory. This makes the changes permanent. The cursor moves to the F9 block.
9. Press the F10 key and then press the I key to select operating mode 1 (CYBER mode) and display the Installation Parameters.
10. Press the F2 key, if necessary, to position the cursor under the F2 block (CONFIG).
11. Enter the value lxxxx0 in the F2 block.
 - a. Press the I key to enable mode 1, CYBER mode.
 - b. Press the space bar until the cursor is under the sixth or rightmost position, then press the 0 (zero) key to select host interface.
12. Press the F3 key, if necessary, to position the cursor under the F3 block (CONFIG).

13. Enter the value xx0110 in the F3 block.
 - a. Space to the third position of the F3 block. Press the 0 (zero) key to select host to have 7 data bits.
 - b. With the cursor in the fourth position, press the 1 key to select host parity enabled.
 - c. With the cursor in the fifth position, press the 1 key to select host parity even/mark.
 - d. With the cursor in the sixth position, press the 0 (zero) key to select host words have 1 stop bit.
14. Press the F4 key, if necessary, to position the cursor under the F4 block (CONFIG).
15. Enter the value 10xxxx in the F4 block.
 - a. With the cursor in the first position, press the 1 key to select data terminal ready (DTR) signal switched off.
 - b. With the cursor in the second position, press the 0 (zero) key to select request to send (RTS) signal on constantly when DTR or data set ready signals drop.
16. Press the F5 key to position the cursor under the F5 block (CONFIG).
17. Enter the value 0lxxxx in the F5 block.
 - a. With the cursor in the first position, press the 0 (zero) key to select pacing disabled.
 - b. With the cursor in the second position, press the 1 key to select bias enabled.
18. Press the F6 key to position the cursor under the F6 block (OPR DF). Four hexadecimal characters are displayed.
19. Enter the value 0C05 in the F6 block.
20. Press the F9 key to position the cursor under the F9 block (DF T R).
21. Press the space bar twice to position the cursor under the third hexadecimal character (under the T).
22. Enter the proper transmit line speed/ baud rate from the following table:

<u>Entry</u>	<u>Baud Rate</u>
4	300 bps
5	600 bps
6	1200 bps
7	1800 bps
8	2400 bps
9	4800 bps
A	9600 bps†
B	19200 bps

† A baud rate of 19200 bps is generally used when the CC634B is used as the primary console.

23. With the cursor under the fourth hexadecimal character (under the R), enter the proper receive line speed/ baud rate using the table in step 22.

The blocks you changed should now be displayed at the bottom of the screen as follows:

F	RETURN	F	CONFIG	F	CONFIG	F	CONFIG	F	CONFIG	F	OPR DG
1		2	lxxxx0	3	xx0110	4	10xxxx	5	010000	6	0C05

24. Press the COPY key to write the mode installation parameters into nonvolatile memory. This makes the changes permanent. The cursor moves to the F10 block.
25. Press the F1 key twice to return the console to CYBER mode.

Installation of parameters required to support automatic initialization of the CC634B console is now complete.

COMMENT SHEET

MANUAL TITLE: Control Data CYBER Initialization Package (CIP)
User's Handbook

PUBLICATION NO.: 60457180

REVISION: F

NAME: _____

COMPANY: _____

STREET ADDRESS: _____

CITY: _____ STATE: _____ ZIP CODE: _____

This form is not intended to be used as an order blank. Control Data Corporation welcomes your evaluation of this manual. Please indicate any errors, suggested additions or deletions, or general comments below (please include page number references).

Please Reply No Reply Necessary

CUT ALONG LINE

AA3419 REV. 4/79 PRINTED IN U.S.A.

NO POSTAGE STAMP NECESSARY IF MAILED IN U.S.A.

FOLD

FOLD



NO POSTAGE
NECESSARY
IF MAILED
IN THE
UNITED STATES

BUSINESS REPLY MAIL
FIRST CLASS PERMIT NO. 8241 MINNEAPOLIS, MINN.

POSTAGE WILL BE PAID BY

CONTROL DATA CORPORATION

Technology and Publications Division
4201 North Lexington Avenue
St. Paul, Minnesota 55126-6198

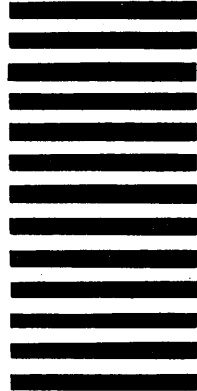

CUT ALONG LINE

FOLD

FOLD

CORPORATE HEADQUARTERS, P.O. BOX 0, MINNEAPOLIS, MINN 55440
SALES OFFICES AND SERVICE CENTERS IN MAJOR CITIES THROUGHOUT THE WORLD

LITHO IN U.S.A.