

# **CONTROL DATA®**

## **MODEL 3290-D DISPLAY EQUIPMENT**

- General Description
- Operation
- Programming

**CONTROL DATA**

**HARDWARE REFERENCE MANUAL**

MODEL 3290-D  
DISPLAY EQUIPMENT  
HARDWARE REFERENCE MANUAL

SECTIONS IN THIS MANUAL:

- Section I — General Description
- Section II — Operation
- Section III — Programming

Any comments concerning this  
publication should be addressed to:

Control Data Corporation  
Technical Publication Department  
2401 North Fairview Avenue  
St. Paul, Minnesota 55113

Publication No. 82122900  
April 1968  
Changed October 1968

© Copyright 1968  
Control Data Corporation  
PRINTED IN USA





## FOREWORD

This manual contains information to guide personnel in operating the CONTROL DATA Model 3290-D Display Equipment. This manual explains the operation of the display equipment from a user's point of view and bridges the gap between the more detailed customer engineering publications for each device.

Discussion in this manual is arranged in three basic sections. A brief outline of each section follows:

Section I, General Description — contains functional, operational, physical descriptions, and electrical data.

Section II, Operation — lists controls and their functions and explains operating procedures through use of the controls.

Section III, Programming — gives programming aspects of the display equipment. Information is provided on function codes, status codes, interface signals, word formats, etc.

For a more detailed description of the equipment described herein, reference the Model 211-G, H, J, K, L, P Display Station Reference/Customer Engineering Manual (publication number 82117800), Model 218-F, G Printer Station Reference/Customer Engineering Manual (publication number 82132900), and Model 3290-D (with 215-B Poller and including Option 10033-C) Customer Engineering Manual, Books 1 through 4 (publication numbers 82123000, 82123100, 82135600, 82123200, and 82123300, respectively).

## TABLE OF CONTENTS

| <u>Section</u> |                                    | <u>Page</u> |
|----------------|------------------------------------|-------------|
| I              | — GENERAL DESCRIPTION              |             |
|                | Operational Description            | 1-1         |
|                | Functional Description             | 1-2         |
|                | Environmental Conditions           | 1-4         |
|                | Physical Data                      | 1-4         |
|                | Display Controller Electrical Data | 1-6         |
|                | Display Station Electrical Data    | 1-7         |
|                | Printer Station Electrical Data    | 1-7         |
|                | Convenience Outlets                | 1-9         |
| II             | — OPERATION                        |             |
|                | Controls                           | 2-1         |
|                | Display Controller                 | 2-1         |
|                | Display Station                    | 2-5         |
|                | Printer Station                    | 2-8         |
|                | Operating Procedures               | 2-9         |
|                | Turn On/Turn Off                   | 2-10        |
|                | Typical Operation Sequence         | 2-10        |
| III            | — PROGRAMMING                      |             |
|                | Interface Signal Lines             | 3-1         |
|                | Data Lines (12)                    | 3-1         |
|                | Parity Line                        | 3-1         |
|                | Connect Line                       | 3-1         |
|                | Function Line                      | 3-3         |
|                | Read Line                          | 3-3         |
|                | Write Line                         | 3-4         |
|                | Data Signal Line                   | 3-4         |
|                | Master Clear Line                  | 3-4         |
|                | Channel Busy Line                  | 3-4         |
|                | Negate BCD Conversion Line         | 3-4         |

## TABLE OF CONTENTS (CONT)

| <u>Section</u>                                   | <u>Page</u> |
|--|-------------|
| III —  |             |
| Reply Line                                       | 3-4         |
| Reject Line                                      | 3-5         |
| Suppress Assembly/Disassembly Line               | 3-5         |
| End of Record Line                               | 3-6         |
| Parity Error Line                                | 3-6         |
| Status Lines (12)                                | 3-6         |
| Interrupt Lines (8)                              | 3-6         |
| Interface Control Codes                          | 3-6         |
| Connect Code                                     | 3-7         |
| Function Codes                                   | 3-7         |
| Status Codes                                     | 3-7         |
| Interrupts                                       | 3-11        |
| Symbol Data                                      | 3-12        |
| Word Formats                                     | 3-14        |
| Read/Write Operations                            | 3-19        |
| Read Operation Initiated by a Requesting Station | 3-20        |
| Read Operation Initiated by the Computer         | 3-21        |
| Write Operation to a Local Display Station       | 3-21        |
| Write Operation to Poller                        | 3-21        |
| Programming Aids                                 | 3-22        |
| Programming Restrictions                         | 3-22        |
| Poller Translation                               | 3-23        |
| Interface Signals                                | 3-23        |
| Poller Control Codes                             | 3-26        |
| Symbol Subset                                    | 3-28        |
| Message Format                                   | 3-30        |
| Error Processing                                 | 3-35        |
| Poller Symbol Repertoire                         | 3-36        |
| APPENDIX I — CONVERSION TABLES                   | 1A-1        |
| ALPHABETICAL INDEX                               | I           |

## LIST OF ILLUSTRATIONS

| <u>Section</u> | <u>Figure</u>                                      | <u>Page</u> |
|----------------|--|-------------|
| I              | — GENERAL DESCRIPTION                              |             |
|                | 1-1 Typical Set of Display Equipment               | 1-0         |
|                | 1-2 Display Station Functional Diagram             | 1-3         |
|                | 1-3 Display Equipment Block Diagram                | 1-6         |
|                | 1-4 Display Controller Physical Data               | 1-7         |
|                | 1-5 Display Station Physical Data                  | 1-8         |
|                | 1-6 Printer Station Physical Data                  | 1-8         |
| II             | — OPERATION  |             |
|                | 2-1 Display Controller Maintenance Panel           | 2-1         |
|                | 2-2 Auxiliary Maintenance Panel                    | 2-3         |
|                | 2-3 A-C Control Panel                              | 2-3         |
|                | 2-4 Display Controller Interface Panel             | 2-4         |
|                | 2-5 Data Set Interface Panel                       | 2-4         |
|                | 2-6 Display Station                                | 2-5         |
|                | 2-7 Display Station Keyboard                       | 2-6         |
|                | 2-8 Printer Station Typewriter Controls            | 2-9         |
|                | 2-9 Typical Operation Sequence Flow Diagram        | 2-11        |
| III            | — PROGRAMMING                                      |             |
|                | 3-1 Computer/Display Controller Interface Lines    | 3-2         |
|                | 3-2 Connect Code                                   | 3-7         |
|                | 3-3 Symbol Code Quick Reference Chart              | 3-14        |
|                | 3-4 Connect Sequence                               | 3-17        |
|                | 3-5 Function Sequence                              | 3-18        |
|                | 3-6 Simplified Read Timing                         | 3-20        |
|                | 3-7 Simplified Write Timing                        | 3-21        |
|                | 3-8 Poller Interface Signals                       | 3-24        |
|                | 3-9 General Message Format                         | 3-30        |
|                | 3-10 Symbol and Function Codes, Binary Translation | 3-37        |



## LIST OF TABLES

| <u>Section</u> | <u>Table</u>                                    | <u>Page</u> |
|----------------|---|-------------|
| I              | — GENERAL DESCRIPTION                           |             |
|                | 1-1 Display Controller Environmental Conditions | 1-5         |
|                | 1-2 Display Station Environmental Conditions    | 1-5         |
|                | 1-3 Printer Station Environmental Conditions    | 1-5         |
| II             | — OPERATION                                     |             |
|                | 2-1 Maintenance Panel Controls and Indicators   | 2-2         |
|                | 2-2 Turn On/Turn Off Procedures                 | 2-10        |
| III            | — PROGRAMMING                                   |             |
|                | 3-1 Display Controller Function Codes           | 3-8         |
|                | 3-2 Display Controller Status Conditions        | 3-10        |
|                | 3-3 Display Controller Interrupts               | 3-12        |
|                | 3-4 Symbol Repertoire                           | 3-13        |
|                | 3-5 Word Formats                                | 3-15        |
|                | 3-6 Control Codes                               | 3-26        |
|                | 3-7 Symbol Subset Conversion to Computer        | 3-29        |
|                | 3-8 Symbol Subset Conversion from Computer      | 3-29        |
|                | 3-9 Messages Sent by the Poller                 | 3-31        |
|                | 3-10 Messages Received by the Poller            | 3-33        |

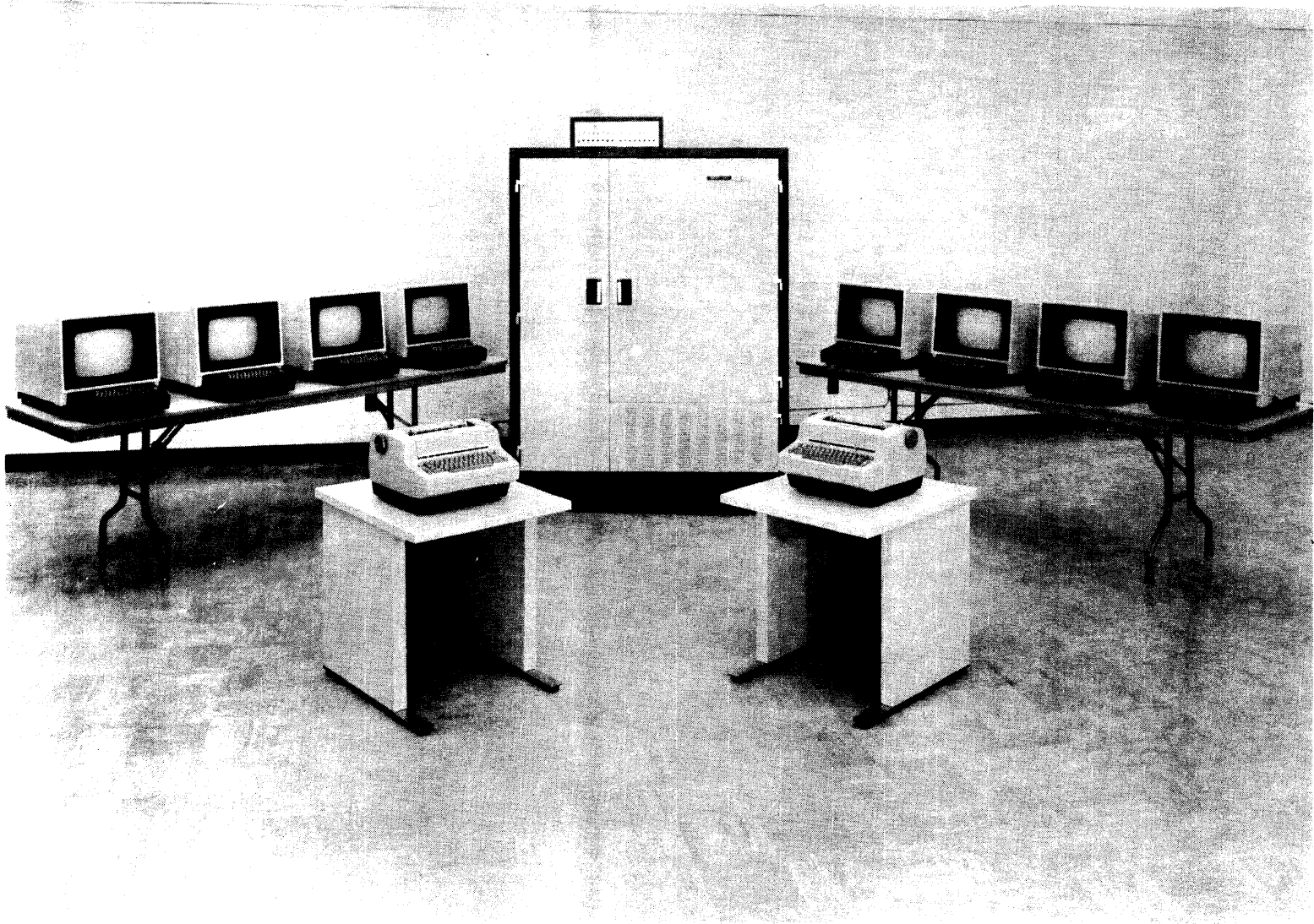

Figure 1-1. Typical Set of Display Equipment

## SECTION I

## GENERAL DESCRIPTION

The display equipment, designed for use with a CONTROL DATA 3000 Series computer, consists of a Display Controller and a combination (not to exceed 12) of Display Stations, Printer Stations, and pollers.

A typical set of display equipment is shown in figure 1-1. The display equipment provides access to data storage and computational capabilities of a central computer complex by means of inquiry and retrieval Display Stations. To obtain hardcopy records of displayed messages, transfer data to an associated off-line Printer Station. The poller allows communications between the computer and remote sites.

The Display Stations and/or Printer Stations may be located as far as 1000 feet from the Display Controller. A Display Station and its associated logic circuitry must be employed for every Printer Station used; however, one Printer Station may serve more than one Display Station. The poller assembly controls communications between the 3000 Series computer and a remote terminal Display Controller. Communications between the poller assembly and the remote Display Controller take place over conventional phone lines utilizing a DATA-PHONE \* Data Set 201A or 201B.

OPERATIONAL DESCRIPTION.

Data is entered on the Display Station 14-inch (diagonal measurement) cathode ray tube (crt) screen from the computer at an approximate rate of 50,000 symbols per second and from the Display Station keyboard at operator typing speeds. Standard display format is 20 lines of 50 symbols per line within a nominal 8-inch-wide by 6-inch-high raster area. An optional display format is available with 13 lines of 80 symbols per line.

Symbol intensity is adjustable and the P4 phosphor-coated crt makes displays clearly legible in normal office lighting. Data presented on the display screen is refreshed at a flicker-free rate of 50 cycles per second. Symbol dimensions are nominally 1/8-inch wide by 1/4-inch high.

---

\* Trademark of AT&T

An entry marker, displayed as an underline, conveniently indicates to the operator where the next symbol will appear. The entry marker can be positioned anywhere within the 8 by 6 inch viewing area and moves automatically across the page as each symbol is typed, or inserted by the computer. At the end of a line, the entry marker automatically moves to the first symbol position in the next line down. When it reaches the end of the last line on the page, it automatically moves to the first symbol position in the upper left corner of the screen.

Positioning the entry marker at the end of the print message and depressing the keyboard PRINT key transmits displayed messages to an associated Printer Station. Data from the top of the screen to the entry marker position is transmitted to the Printer Station and typed out at the rate of 15.5 symbols per second on continuous strip paper 9-7/8 inches wide and perforated for folding and tearing at 11-inch intervals.

#### FUNCTIONAL DESCRIPTION.

The remainder of Section I describes in more detail primary Display Controller, Display Station, and Printer Station functions.

The Display Controller consists of an interface, central control and symbol generator assembly, station driver assemblies, printer driver assemblies, and may contain up to two poller assemblies. On diagrams and some figures the central control and symbol generator assembly is referred to as CBU, station drivers as SDU's and printer drivers as PCU's.

The interface enables Display Controller communications with a 3000 Series computer. Two cables (up to 200 feet long), identified as "A" and "B", provide the data link between the computer and Display Controller. Twisted-pair signal lines, contained in cables A and B, are described under interface signals in Section III.

Symbol generation, timing, and data flow gating logic are contained in the central control and symbol generator assembly. Video pulse trains, representing symbols, are developed in the symbol generator. These pulse trains are made available to each station driver. The station driver selects the proper pulse train and transmits it to the crt where it is displayed by unblanking the beam in a 5 by 7 dot matrix. Symbol dimensions are, nominally, 1/8-inch wide by 1/4-inch high. Each station driver contains logic circuitry controlling the operation of a Display Station. It receives data from the Display Station keyboard and the central control symbol generator assembly. All data sent to the station driver is stored in an associated

10-millisecond magnetostrictive delay-line memory. All stored data is assembled and decoded in each station driver, fed to the Display Station, and displayed on the crt. The display remains visible as long as stored data is continually refreshed on the crt. Figure 1-2 is a functional diagram of the Display Station.

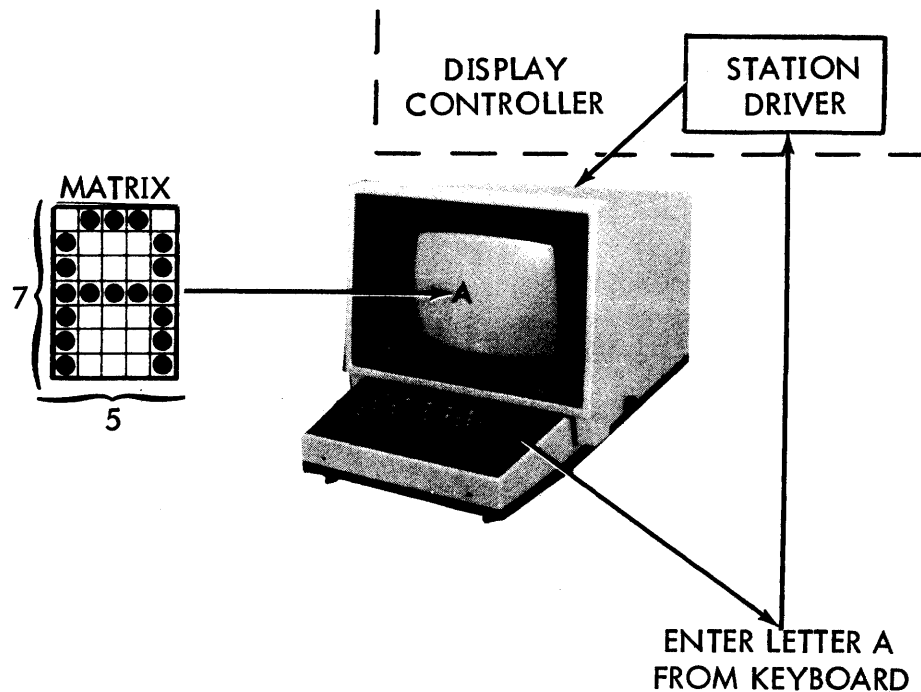

Figure 1-2. Display Station Functional Diagram

One symbol requires 16.8 microseconds to display while one line is displayed in 991.2 microseconds. Twenty lines of 50 symbols, therefore, require 19.824 milliseconds allowing 9 symbol times for horizontal retrace. Thirteen lines of 80 symbols require 19.437 milliseconds.

A printer driver contains the Printer Station control logic. Data from the station driver assembly register is translated and sent to the printer driver. Printer control and priority control logic are in the printer driver. One Printer Station can serve as an output device for up to 10 Display Stations if one poller is used or it can be used for an output device for up to 9 Display Stations if two pollers are used.

Each Printer Station contains a Selectric \* typewriter; depressing the PRINT key at a Display Station activates the typewriter. If the PRINT keys at several Display Stations associated with a Printer Station are depressed while the Printer Station is busy printing, the requests are processed in order of lowest Display Station number. Type set is designated "Data No. 1" \*\* and type spacing is 10 symbols per inch in a line with 6 lines per inch. The printer uses a black fabric ribbon to type symbols on a 9-7/8-inch-wide continuous strip paper. The paper is perforated for folding and tearing at 11-inch intervals. Feed holes are 9-3/8 inches apart and spaced 1/2 inch in the longitudinal direction.

Printout is accomplished at the following speeds: print one symbol, 64.5 milliseconds; carriage return, 129.0 milliseconds; shift, 64.5 milliseconds; and space, 64.5 milliseconds.

The Display Controller may contain a maximum of two pollers. Data is sent to or from the remote stations via the poller in 8-bit serial codes. The Data Set synchronizes all received or transmitted data. A poller controls the remote site's requests to transfer data by periodically polling (scanning) them in sequential order.

#### ENVIRONMENTAL CONDITIONS.

The Display Controller operates at normal room temperature but has a blower assembly housing located beneath the logic chassis assemblies for specific cooling of the logic chassis. The Display Stations and Printer Stations also operate at normal room temperature but are cooled by radiation and convection. Tables 1-1 through 1-3 list specific environmental limitations for all three units.

#### PHYSICAL DATA.

The display equipment configuration may consist of no more than 12 Display Stations, Printer Stations, and pollers. No more than two pollers may be employed, so the maximum display equipment configuration that would be possible locally would be a combination of ten Display Stations and/or Printer Stations with two pollers. The pollers are capable of communicating with up to 16 remote Display Controllers. Refer to figure 1-3.

---

\* IBM Trademark.

\*\* IBM Classification.

TABLE 1-1. DISPLAY CONTROLLER ENVIRONMENTAL CONDITIONS

| CONDITION         | OPERATIONAL<br>Normal/Standby | NONOPERATIONAL<br>Storage/Transit (Note 1) |
|-------------------|-------------------------------|--|
| Temperature       | +65 F to +85 F                | -30 F to +150 F                            |
| Relative Humidity | 10 to 90%                     | 0 to 100% (Note 2)                         |
| Altitude          | -1000 to +10,000 feet         | -1000 to +15,000 feet                      |

Note 1 — packed for shipment.

Note 2 — includes condensation in the form of moisture or frost.

TABLE 1-2. DISPLAY STATION ENVIRONMENTAL CONDITIONS

| CONDITION         | OPERATIONAL<br>Normal/Standby | NONOPERATIONAL<br>Storage/Transit (Note 1) |
|-------------------|-------------------------------|--|
| Temperature       | +65 F to +100 F               | -65 F to +160 F                            |
| Relative Humidity | 40 to 60%                     | 10 to 90% (Note 2)                         |
| Altitude          | 8,000 feet                    | 12,000 feet                                |

Note 1 — packed for shipment.

Note 2 — includes condensation in the form of moisture or frost.

TABLE 1-3. PRINTER STATION ENVIRONMENTAL CONDITIONS

| CONDITION         | OPERATIONAL<br>Normal/Standby | NONOPERATIONAL<br>Storage/Transit (Note 1) |
|-------------------|-------------------------------|--|
| Temperature       | +60 F to +100 F               | -30 F to +150 F                            |
| Relative Humidity | 10 to 90%                     | 5 to 100% (Note 2)                         |
| Altitude          | -1000 to +10,000 feet         | -1000 to +15,000 feet                      |

Note 1 — packed for shipment.

Note 2 — includes condensation in the form of moisture or frost.

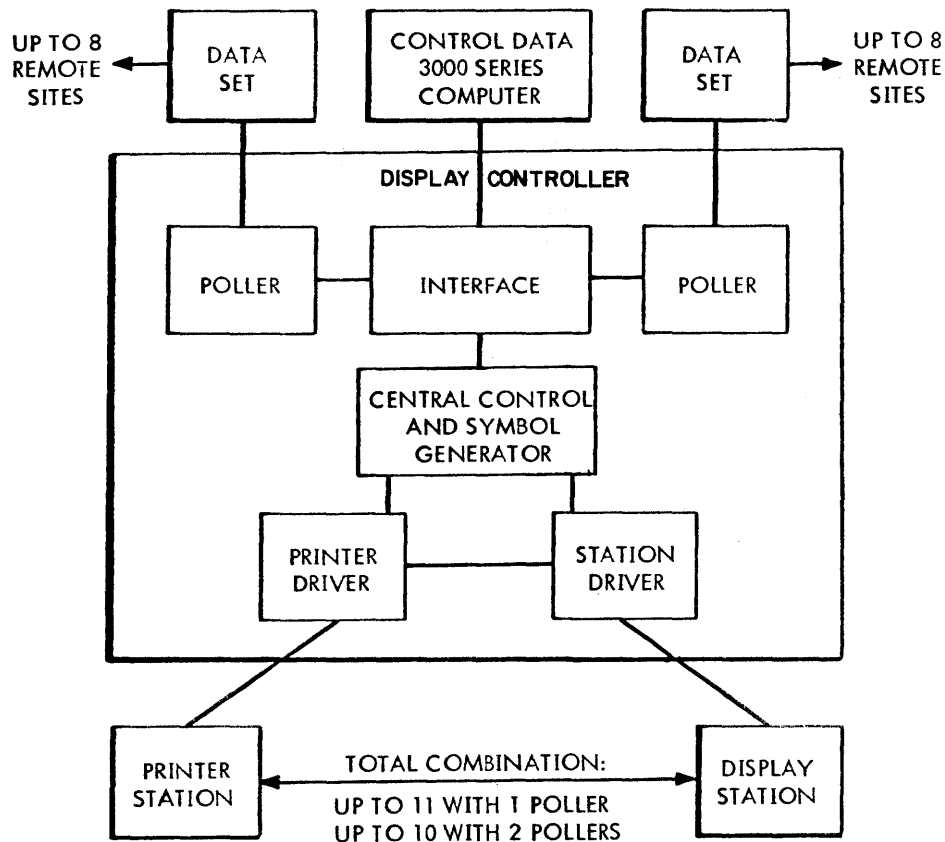

Figure 1-3. Display Equipment Block Diagram

Physical construction of the display equipment incorporates latest recognized factors in engineering, convenience, and safety to operating personnel. Figures 1-4 through 1-6 show the dimensions and approximate weight of the Display Controller, Display Station, and Printer Station respectively.

DISPLAY CONTROLLER ELECTRICAL DATA.

The Display Controller requires 57 to 63 Hz, 187 to 216 volts, 3-phase alternating current of 8 amperes. Each station driver or printer driver requires 0.4 ampere in addition to that required for the Display Controller.



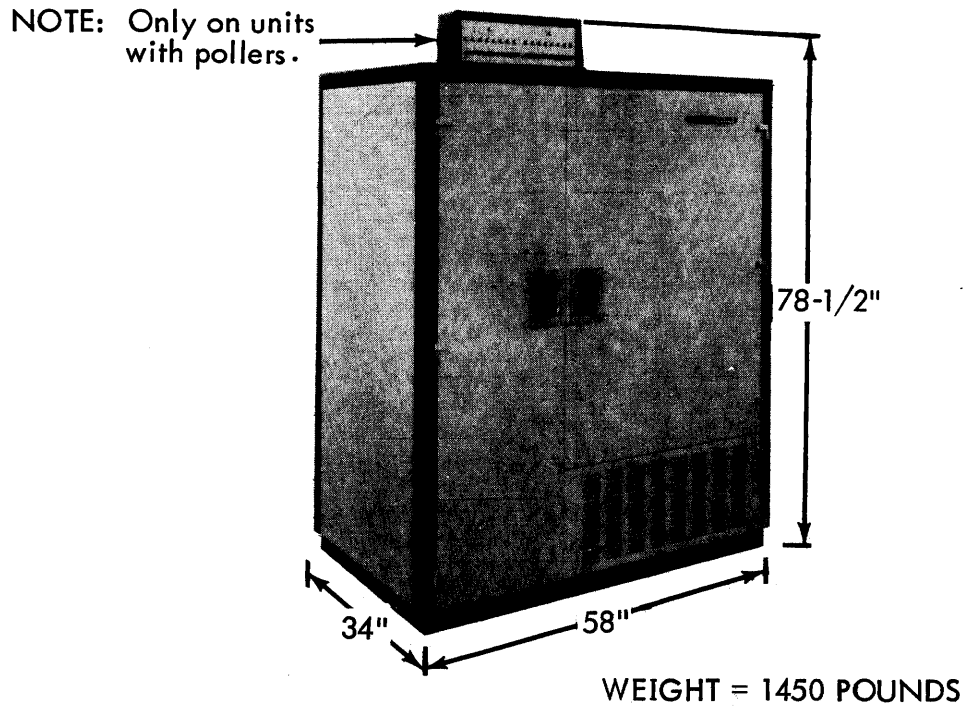

Figure 1-4. Display Controller Physical Data

#### DISPLAY STATION ELECTRICAL DATA.

The Display Station requires 115/230-volt, 50/60-Hz, 3-wire, single-phase power. Power expended is 130 watts with heat dissipation of 465 Btu per hour. Voltage potentials in the Display Station range from -16 volts dc to 10 kilovolts.

#### PRINTER STATION ELECTRICAL DATA.

The Printer Station requires 120-volt, single-phase, 60-Hz power. It has a maximum current rating of 1.0 ampere, dissipates 400 Btu per hour, and is cooled by radiation and convection.

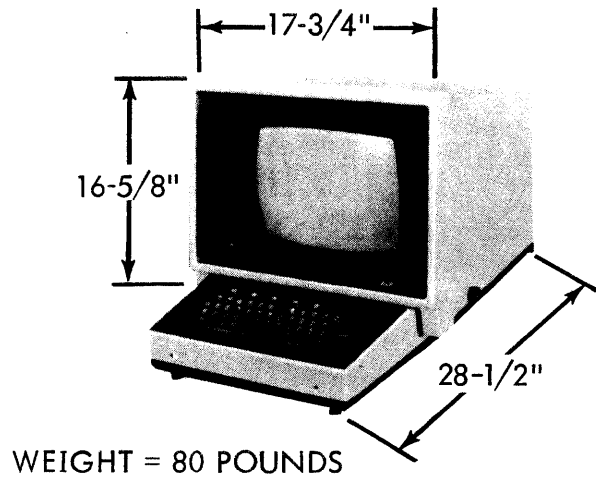

Figure 1-5. Display Station Physical Data

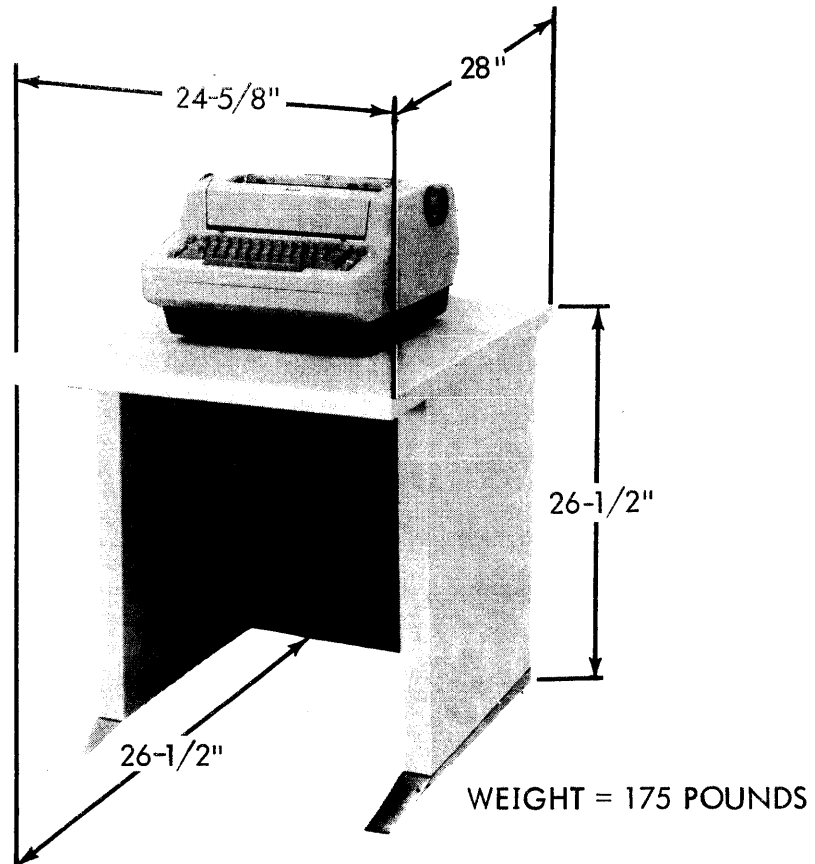

Figure 1-6. Printer Station Physical Data

CONVENIENCE OUTLETS.

To facilitate the use of test equipment during periods of maintenance, Control Data requires that a convenience outlet be available within 15 feet of each system component cabinet. The outlets may be located in the walls or raised floor panels and must not be obstructed by storage racks or other furniture. The receptacles shall be of the single-phase grounded type, installed according to local electrical codes. For 60-hertz installations, the nominal voltage shall be 120 volts. For 50-hertz installations, the nominal voltage shall be 220, 230, or 240 volts, as dictated by the single-phase power available at the site.

## SECTION II

### OPERATION

This section contains a list of controls for operation and maintenance of the display equipment and also contains information on data inquiry, and turn on/turn off procedures.

#### CONTROLS.

Display Equipment controls are divided into three groups: Display Controller, Display Station, and Printer Station. Following paragraphs explain control usage within each group.

The Display Controller maintenance panel controls apply power and enable checking the display equipment operational sequence. Display Station controls apply power and adjust crt intensity. The Display Station keyboard enters data into the display equipment and controls its destination. Printer Station controls apply power to the hardcopy printer.

#### DISPLAY CONTROLLER.

Figure 2-1 shows the Display Controller maintenance panel. Table 2-1 explains the callouts.

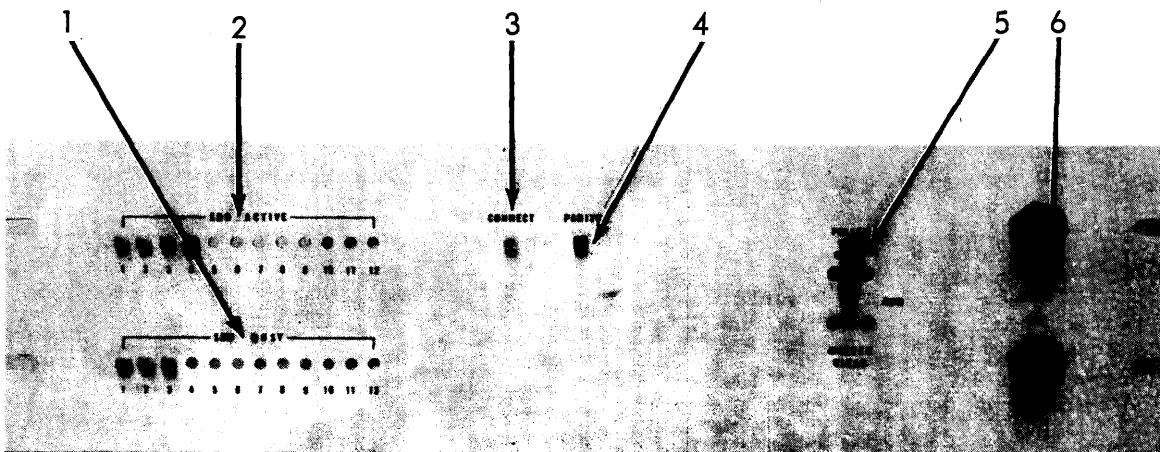

Figure 2-1. Display Controller Maintenance Panel

TABLE 2-1. MAINTENANCE PANEL CONTROLS AND INDICATORS

| CALLOUT | CONTROL NAME                        | CONTROL TYPE               | FUNCTION  |
|---------|-------------------------------------|----------------------------|---|
| 1       | SDU BUSY<br>1 through 12            | Indicators<br>white        | Indicates the print busy status of each Display Station.  |
| 2       | SDU ACTIVE<br>1 through 12          | Indicators<br>white        | Indicates the input/output status of each Display Station.  |
| 3       | CONNECT                             | Indicator<br>white         | Indicates the Display Controller is connected to the computer by a computer connect code.   |
| 4       | PARITY                              | Indicator<br>red           | Indicates the Display Controller has detected a transmission parity error.  |
| 5       | POLLER TEST/<br>RUN/MASTER<br>CLEAR | Lever switch<br>3-position | POLLER TEST — allows communications between remote site and poller.<br>RUN — enables normal Display Controller operation.<br>MASTER CLEAR — clears Display Controller logic and all data from the delay-line memory within each station driver. |
| 6       | POWER ON/OFF                        | Two push-<br>buttons       | Turns Display Controller cabinet power on and off.  |

The auxiliary maintenance panel (figure 2-2) contains a toggle switch and a light for each of the sixteen possible remote sites (8 for each poller). The corresponding site address for each switch is labeled directly below the switch. If a switch is in the down position, the corresponding remote site receives a poll message from the poller. If it is in the up position, its site address is not polled in the poller sequence.

The indicator for each site, located directly above the switch, illuminates when a poll message is initiated to its corresponding remote site. The indicator extinguishes when the poller receives an errorless message from that site. If a particular indicator remains illuminated indefinitely, there is a communications

problem between that site and the poller. The switch corresponding to this indicator should then be placed in the up position. This will extinguish the light and remove the site from the system.

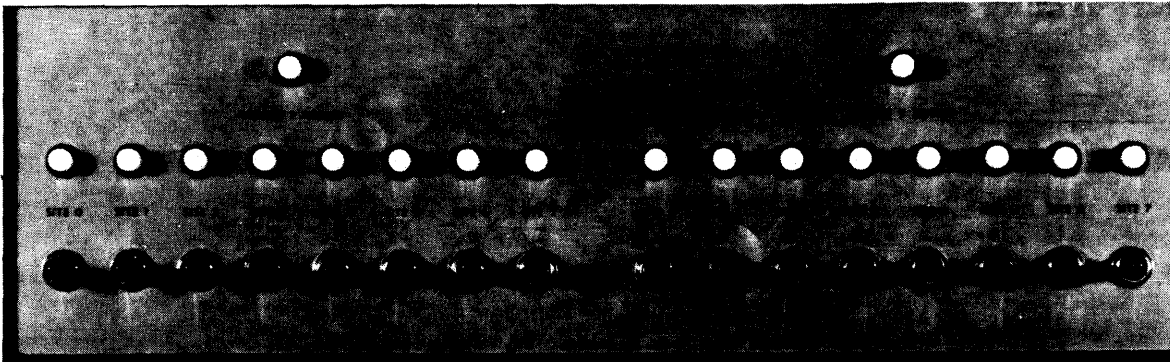

Figure 2-2. Auxiliary Maintenance Panel

Circuit breaker CB1 on the a-c control panel (figure 2-3) applies primary 208-volt, 3-phase power to the Display Controller. Also on this panel are two 120-volt ac convenience outlets and a meter, M1, which indicates the total number of hours power has been applied to the Display Controller. The six fuses located on the panel provide circuit protection for the power supplies, blower assembly, and convenience outlets.

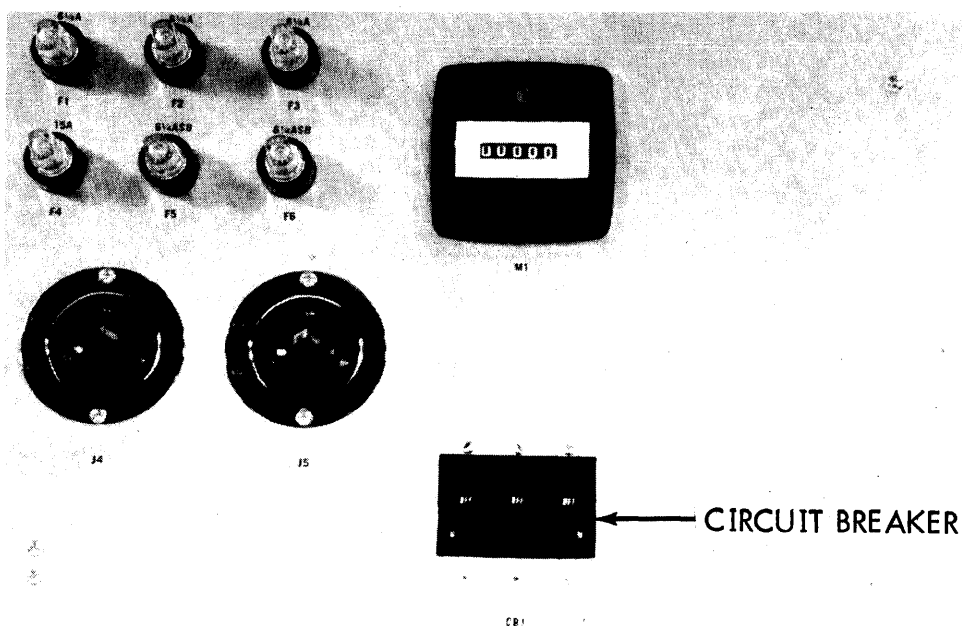

Figure 2-3. A-C Control Panel

The interface panel contains the EQUIPMENT SELECTOR rotary switch (figure 2-4) for selecting a specific external equipment address 0 through 7 for the Display Controller. The switch setting also determines which interrupt line to the computer is used. Four receptacles are provided for connecting the Display Controller to the computer; only two are used at one time. The other two should be terminated if not in use.

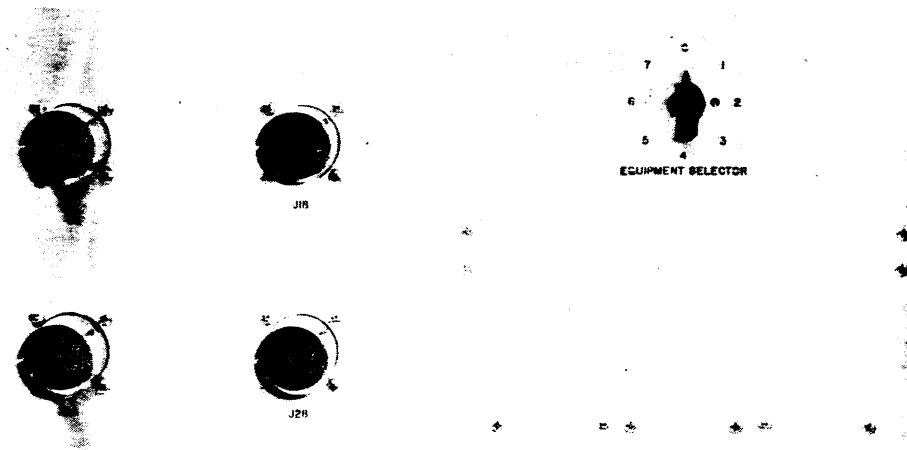

Figure 2-4. Display Controller Interface Panel

Figure 2-5 shows the Data Set interface panel. This panel provides the power and data outlets for two pollers. J1 and J2 are the data cable receptacles while J3 and J4 provide 120-volt ac, 60 Hz power to the Data Set.

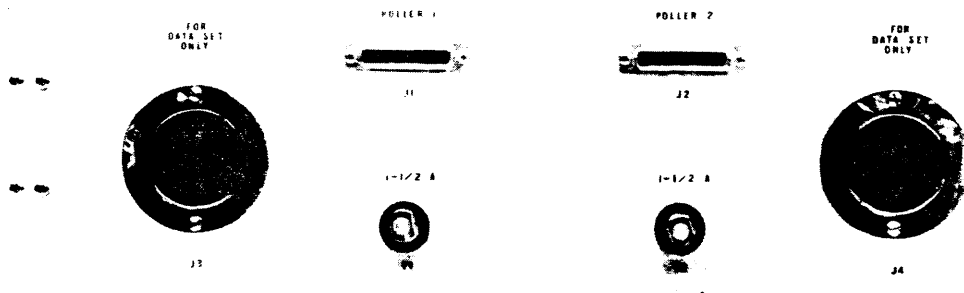

Figure 2-5. Data Set Interface Panel

**DISPLAY STATION.**

Rotating the ON/OFF/INTENSITY control, located on the right side of the Display Station, toward the rear of the cabinet turns the Display Station on; further rotation increases the intensity of the displayed symbols. The ON/OFF/INTENSITY control being off does not prevent communication on the interface between the computer and the delay-line memory and does not disable keys on the keyboard, except the SHIFT key. Figure 2-6 shows the Display Station and figure 2-7 shows the Display Station keyboard.

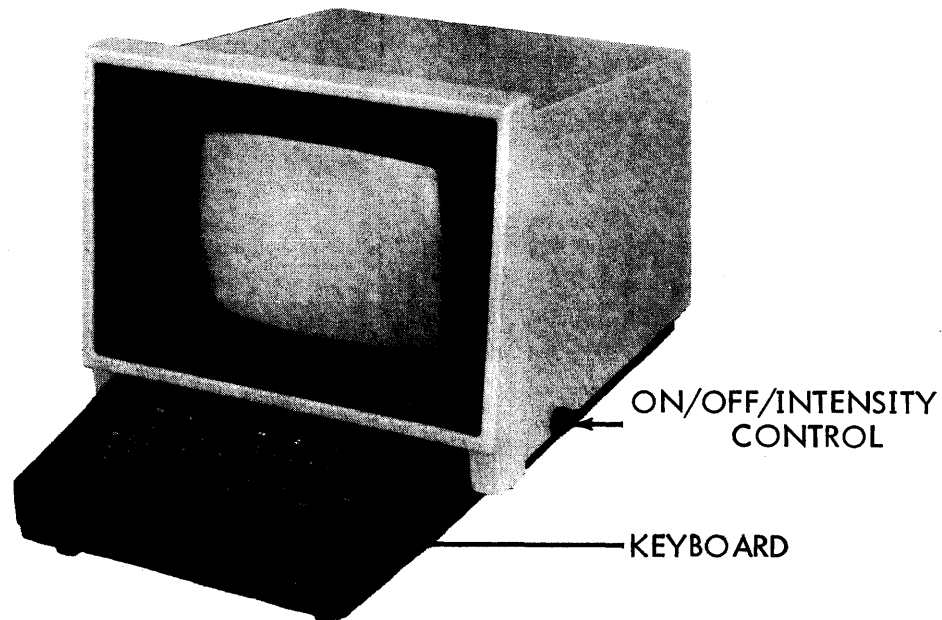

Figure 2-6. Display Station

Four rows of keys on the Display Station keyboard enter symbols into the delay line for display on the crt. Depression of a key enters the code for the symbol indicated on the key into memory at the position of the entry marker, generates the symbol on the crt, and advances the entry marker. The keyboard is inoperative during the following intervals:

- (a) SEND key is depressed until the end of a read message from or a write message to that station.
- (b) PRINT key depressed until printout is complete. The CLEAR key is not locked out during printout.



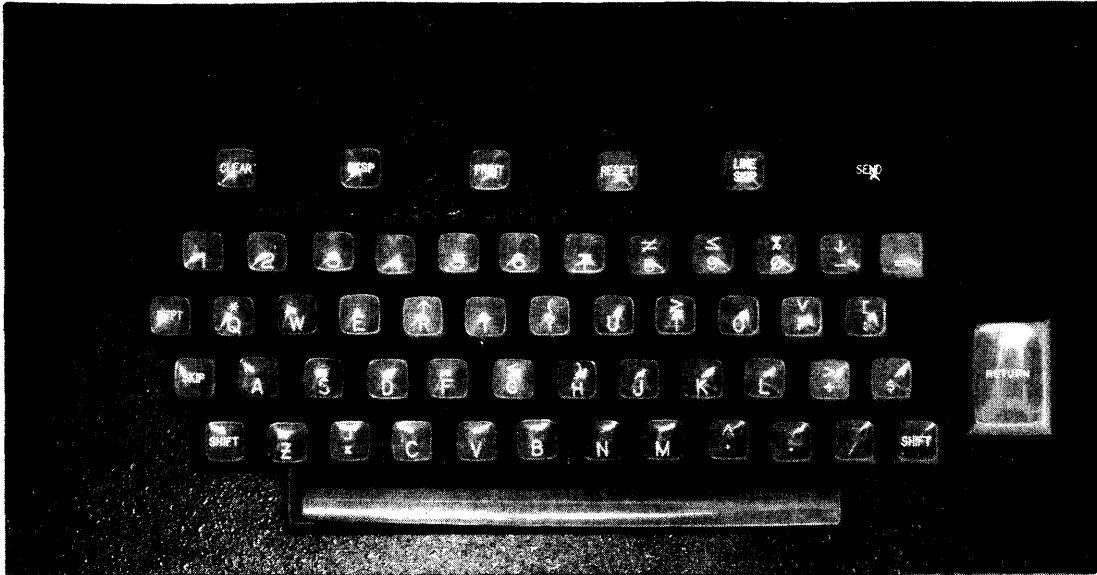

Figure 2-7. Display Station Keyboard

- (c) The station is connected and the Channel Busy signal is a logical 1.
- (d) Reset function or reset clear function is being performed by the Display Station.

The following list explains the operation of the control keys.

Clear.

Depress the CLEAR key to clear all data from the delay line and from the crt. The entry marker moves to the upper left corner of the screen. This operation prevents sending or receiving data from the time the key is depressed until 16.8 microseconds to 20 milliseconds after the key is released. (The time variation is due to latency characteristics of the delay line).

Reset.

Depress the RESET key to move the entry marker to the upper left corner without affecting data. This operation prevents sending or receiving data from the time the key is depressed until 16.8 microseconds to 20 milliseconds after the key is released.

Shift.

Continued depression of either SHIFT key enables entry of the upper symbol on the two-symbol keys. Operation of the single-symbol keys is not affected by the SHIFT keys; all alphabetic symbols are displayed in uppercase form. The SHIFT keys are nonlocking.

Space.

Operating the SPACE key stores a space code in the delay line at the position of the entry marker and advances the entry marker. Data is not affected.

Skip.

Depress the SKIP key to move the entry marker one space forward. Data is unchanged.

Repeat.

Operating the REPT key in conjunction with another key enables a repeated action of that key's character/function. CLEAR, PRINT, RESET, SEND, and SHIFT keys are not affected by the REPT key.

Backspace.

The BKSP key moves the entry marker one space back without changing data. Backspace is accomplished in 10 milliseconds minimum to 90 milliseconds maximum, during which time no data can be transferred on the data channel.

### Line Skip.

Depress the LINE SKIP key to advance the entry marker to the beginning of the next line. Line skip is accomplished in 151.2 microseconds minimum to 1 millisecond maximum, during which time no data is transferred between a connected Display Station and the computer.

### Return.

Operation of the RETURN key inserts a carriage return code at the entry marker position and moves the entry marker to the first symbol position on the next line. The carriage return is displayed as a superscript dash (<sup>^</sup>). The return takes from 151.2 microseconds (if the entry marker is at the end of a line) to 1 millisecond (if the entry marker is at the beginning of a line), during which time no data can be transferred between the Display Station and the computer.

### Send.

The SEND key stores an end of message symbol (elevated <sup>Δ</sup>) at the entry marker position and moves the entry marker to the upper left corner. Data transfer is prevented during the time (16.8 microseconds minimum to 20 milliseconds maximum) the entry marker is moving.

### Print.

Operation of the PRINT key stores an end of print code (') at the entry marker position, moves the entry marker to the upper left corner, and initiates printout of data from the upper left corner to the end of print code on an associated Printer Station. The keyboard, except for the CLEAR key, is disabled during printout. During printout, the Display Station is not ready to the computer.

## PRINTER STATION.

Figure 2-8 shows the Printer Station typewriter controls. Note the location of the ON/OFF switch to the right of the keyboard. A multipaper adjustment (top left) provides even printing for carbon copies. Remaining controls are common

to an electric typewriter and include the following: platen knobs for manually advancing the paper, a line space lever for single or double spacing, a paper release lever, left and right visible margin stops, an impression selector lever which adjusts the striking force of the typing element, a tab set and clear control, tab key, index key, shift keys, margin release, space bar, etc.

Refer to the IBM Selectric Manual supplied with the equipment for more detailed information about the typewriter.

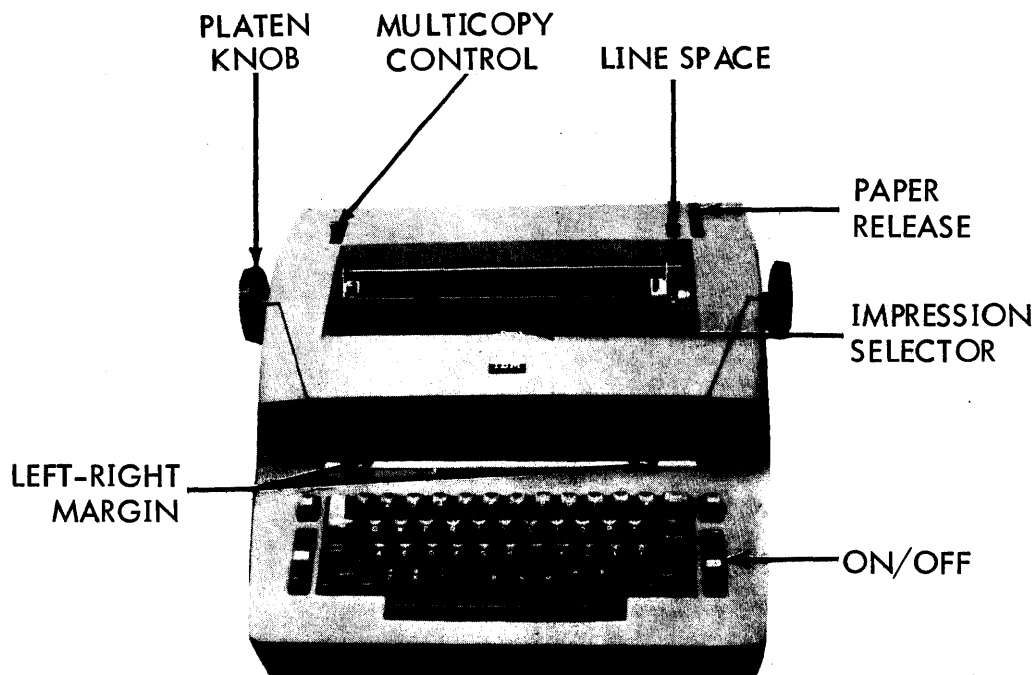

Figure 2-8. Printer Station Typewriter Controls

### OPERATING PROCEDURES.

The remainder of this section describes normal operating procedures for the display equipment. Included are turn on/turn off procedures followed by a typical operation sequence.

TURN ON/TURN OFF.

Turn on/turn off procedures are listed in table 2-2. For precautionary measures, it is recommended the steps be followed in the order listed.

TABLE 2-2. TURN ON/TURN OFF PROCEDURES

| STEP            | LOCATION           | OPERATION  |
|-----------------|--------------------|--|
| <u>TURN ON</u>  |                    |  |
| 1               | Display Controller | Place the POWER ON/OFF switch in the ON position. Move RUN/MASTER CLEAR switch to MASTER CLEAR position, then to RUN position.   |
| 2               | Display Stations   | Rotate the ON/OFF/INTENSITY control to the ON position. Depress the CLEAR key. After a 30-second warmup period, rotate ON/OFF/INTENSITY control until the entry marker is visible. |
| 3               | Printer Stations   | Depress the ON/OFF rocker switch to the ON position.   |
| <u>TURN OFF</u> |                    |  |
| 1               | Printer Stations   | Depress the ON/OFF rocker switch to the OFF position.  |
| 2               | Display Stations   | Rotate the ON/OFF/INTENSITY control to the OFF position.   |
| 3               | Display Controller | Place the POWER ON/OFF switch in the OFF position.   |

TYPICAL OPERATION SEQUENCE.

Figure 2-9 is a flow diagram depicting a typical operation sequence. Depress the CLEAR key on the Display Station keyboard to clear the display screen. The operator then enters data via data entry keys. When data is properly composed, it may be sent to the computer by actuation of the SEND key, or to a Printer Station, which shares memory with the Display Station, by depressing the PRINT key.

The computer may respond to properly transmitted data by sending the requested data or a message acknowledging receipt of the transmitted data. The operator may then print the reply data, or edit it (eg, filling in information on a blank form, or updating stored data), and transmit the edited data back to the computer.

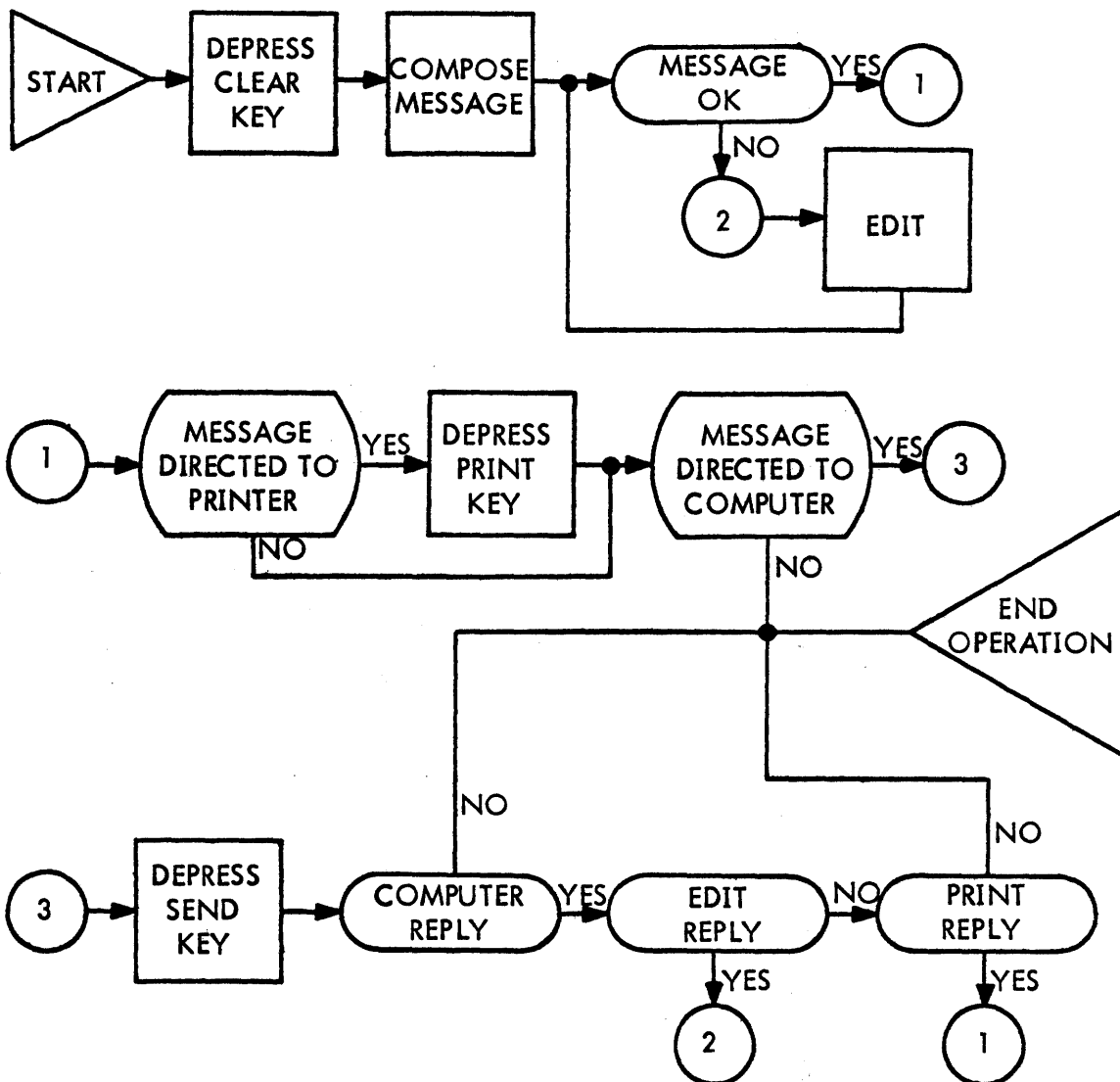

Figure 2-9. Typical Operation Sequence Flow Diagram

## SECTION III

### PROGRAMMING

This section describes programming aspects of the display equipment. It provides a complete description of signals, function and status codes, interrupts, symbol data, word formats, various read/write operations, and programming aids for both interface and poller assemblies.

#### INTERFACE SIGNAL LINES.

The Display Controller operates from the standard (12 bit) 3000 Series standard communications channels. Figure 3-1 shows the interconnecting data and control lines between the computer communications channel and the Display Controller. Following is a description of each line or group of lines.

#### DATA LINES (12).

There are 12 bidirectional data lines. During a read operation (input to the computer), these data lines carry data, 12 bits at a time, from the Display Controller to the computer. During a write operation (output from the computer), the data lines carry data from the computer to the Display Controller. The data lines also are used to transmit the 12-bit connect and function codes associated with Connect and Function signals, respectively.

#### PARITY LINE.

A parity bit accompanies each 12 bits of data, connect code, and function code transmitted between the computer and the Display Controller. Odd parity is used, ie, the total number of 1's transmitted is always an odd number.

#### CONNECT LINE.

A Connect signal is sent to the Display Controller when a 12-bit connect code is available on the data lines. The Display Controller connects only if the following conditions are met:

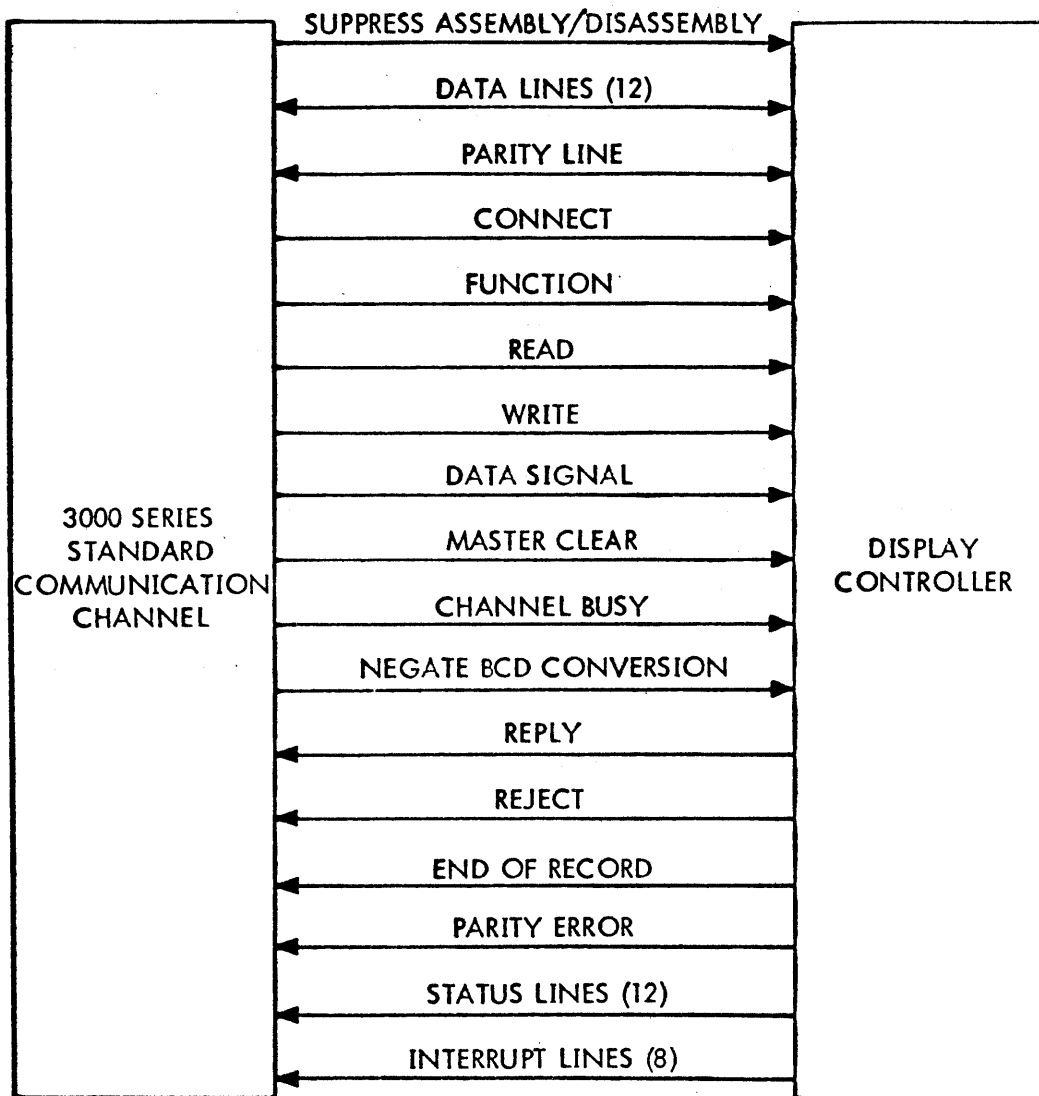

Figure 3-1. Computer/Display Controller Interface Lines

- (a) The most significant 3 bits of the connect code must match the number setting of the EQUIPMENT SELECTOR switch.
- (b) Display Controller power is on.
- (c) The RUN/MASTER CLEAR switch is in the RUN position.
- (d) Parity is correct.



No response is returned when a parity error exists on the connect code; however, the red PARITY error indicator on the Display Controller maintenance panel (figure 2-1) lights on all Display Controllers and external equipment controllers associated with that communications channel. After a delay of 100 microseconds, the communications channel generates its own internal Reject signal.

Once a Display Controller is connected to the computer, it remains connected until the communications channel initiates a disconnect. To perform a disconnect, send any connect code with the upper 3 bits not matching the Display Controller EQUIPMENT SELECTOR switch setting, a Master Clear signal, or a release function code.

#### FUNCTION LINE.

A Function signal is sent to the Display Controller when a 12-bit function code is available on the data lines (function codes are listed under interface control codes). If the Display Controller is connected to the computer and is capable of executing the specified function at the time it receives the Function signal, it initiates the function and returns a Reply signal. If the Display Controller cannot perform the function, it returns a Reject signal. The Function signal and 12-bit function code drop when a Reply or Reject signal is returned. If a Reply or Reject signal is not returned within 100 microseconds, the computer generates its own internal reject.

The specified function is not performed if a parity error exists on the function code; however, a Parity Error signal is returned by the Display Controller and the red PARITY error indicator on the Display Controller maintenance panel (figure 2-1) lights.

Once a function code is accepted by the Display Controller, all other function codes are locked out until the first one is acted upon. The Display Controller does not hold or stack up the function codes; a Reply or Reject signal is returned within 5 microseconds. If a second function code is received which specifies the same function as the previous function code, the second function code is rejected unless the function can be performed immediately a second time.

#### READ LINE.

A Read signal transmitted to the Display Controller directs the Display Controller to begin reading data from a specified Display Station memory.

**WRITE LINE.**

A Write signal transmitted to the Display Controller directs the Display Controller to begin writing data into a specified Display Station memory.

**DATA SIGNAL LINE.**

A Data signal is sent from the computer to the Display Controller for each 12-bit data word during read and write operations. The Data signal drops when a Reply (or End of Record) signal is transmitted by the Display Controller.

During a read operation, the Data signal indicates that the computer is ready to accept a 12-bit data word from the Display Controller. During a write operation, the Data signal indicates that the computer placed a 12-bit data word on the data lines.

**MASTER CLEAR LINE.**

A Master Clear signal sent from the computer returns the Display Controller to its initial clear condition and starts the polling operation.

**CHANNEL BUSY LINE.**

A Channel Busy signal is sent to the Display Controller when the computer communications channel is active during a read or write operation.

**NEGATE BCD CONVERSION LINE.**

When the Negate BCD Conversion signal is a logical 1, external BCD codes are used; when the Negate BCD Conversion signal is a logical 0, internal BCD codes are used. Refer to Symbol Data in this section.

**REPLY LINE.**

The Display Controller transmits a Reply signal in response to the following:

- (a) A connect code having no parity error and containing a matching Display Controller EQUIPMENT SELECTOR switch equipment select code and proper select code.
- (b) A function code received with no parity error if the Display Controller is capable of executing the specified function at the time it receives the Function signal.
- (c) During a write operation after the Display Controller has read a data word.
- (d) During a read operation when the Display Controller has a word on the data lines (see End of Record signal for exception).

The Reply signal drops when the Connect, Function, or Data signal drops.

#### REJECT LINE.

The Display Controller transmits a Reject signal in response to the following:

- (a) A connect code (with no parity error) specifying a nonexistent or busy station.
- (b) A function code (with no parity error) specifying an illegal function.
- (c) A function code (with no parity error) which cannot be performed within 5 microseconds after receipt of the Function signal (refer to programming aids for such conditions).
- (d) An alert function to a poller that had its alert request status cleared, or an alert function to any station other than a poller.

#### SUPPRESS ASSEMBLY/DISASSEMBLY LINE.

During a read operation, the Suppress Assembly/Disassembly signal forces the Display Controller to assemble logical 0's in bits 6 through 11 of each 12-bit data byte. In a write operation, bits 6 through 11 are not used when the Suppress Assembly/Disassembly line is enabled. The signal has no effect on the address word during a read operation initiated by an interrupt.

#### END OF RECORD LINE.

The Display Controller transmits an End of Record signal (instead of a Reply signal) in response to the next Data signal following transmission of EOM signal. The End of Record signal drops when the Data signal drops. If the Read signal drops before the read operation completes, the End of Record signal is not transmitted because the remaining data is not transmitted.

#### PARITY ERROR LINE.

The Display Controller transmits a Parity Error signal when a parity error occurs on a function code or write operation. No Parity Error signal is generated for a parity error occurring on a connect code or read operation. During a write operation, a parity error on one word of a 12-bit byte results in display of both words as parity error symbols when the Suppress signal equals 0.

#### STATUS LINES (12).

The Display Controller places information on the 12 available status lines following a connect operation to indicate its operating conditions to the computer. Display equipment status remains enabled to the computer until a disconnect is sent from the computer. The computer may sample the status lines at any time. Status bits are listed under interface control codes.

#### INTERRUPT LINES (8).

Each Display Controller and external equipment controller attached to a given computer communications channel is assigned to one of eight separate interrupt lines selected by the EQUIPMENT SELECTOR switch. The interrupt line indicates to the computer that a predetermined condition has been reached. The interrupting condition can be determined by program sampling the status lines following transmission of an Interrupt signal if connected.

#### INTERFACE CONTROL CODES.

Interface control codes include connect, function, and status codes. The connect code is used in addressing the display equipment. Function codes, with

the exception of reset, alert, and release, set up and remove interrupt conditions in the Display Controller. Status codes indicate what conditions exist at the Display Controller. Following is a description of the connect code, display equipment function codes, and status line assignments.

### CONNECT CODE.

The connect code is 12 bits long and is transmitted to the Display Controller on the 12 data lines along with a Connect signal on the connect line. The Display Controller interprets the connect code (figure 3-2) as follows:

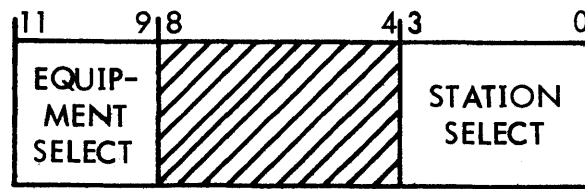

Figure 3-2. Connect Code

Bits 9 through 11 designate the number setting of the Display Controller EQUIPMENT SELECTOR switch. The station select portion of the connect code allows selection of a Display Station or poller or selection of a Display Station or poller that caused an interrupt. Bits 4 through 8 are not interpreted.

### FUNCTION CODES.

Function codes are 12 bits long and are transmitted to the Display Controller on the data lines along with a Function signal on the function line. Table 3-1 lists and describes Display Controller function codes.

### STATUS CODES.

Twelve status lines are available for indicating display equipment operating conditions to the computer. The computer may sample these lines at any time.

TABLE 3-1. DISPLAY CONTROLLER FUNCTION CODES

| OCTAL CODE | FUNCTION   | DESCRIPTION   |
|------------|--|---|
| 0000       | Release  | Disconnects the Display Controller from the computer and clears all interrupt selections and parity error indications. Also master clears a poller if the poller is connected.  |
| 0010       | Reset Entry Marker                                     | Positions the entry marker on selected Display Station or poller to upper left corner to prepare for a read or write. The Display Station or poller indicates busy status for 3.2 microseconds to 20 milliseconds after receipt of the function. Generally precedes a write or computer-initiated read.                                 |
| 0011       | Reset-Clear  | Similar to a reset entry marker function except data is cleared from the delay line. When addressed to a poller, the function does not clear the delay line but clears existing send requests. The Display Station or poller indicates busy status for 20 to 40 milliseconds upon receipt. Generally precedes a write to local station. |
| 0020       | Select Interrupt for Ready and Not Busy (Note 1)       | Allows generation of an interrupt when printer operation completes. Reselection removes an interrupt resulting from a previous selection.   |
| 0021       | Clear Interrupt Enable for Ready and Not Busy (Note 1) | Removes interrupt and selection resulting from code 0020.   |
| 0022       | Select Interrupt on End of Operation (Note 1)          | Allows generation of an interrupt when the read or write operations or a reset or a reset clear operation completes. Reselection removes interrupt resulting from a previous operation.   |

TABLE 3-1. DISPLAY CONTROLLER FUNCTION CODES (CONT)

| OCTAL CODE | FUNCTION                                     | DESCRIPTION   |
|------------|--|---|
| 0023       | Clear Interrupt on End of Operation (Note 1) | Removes interrupt and selection resulting from code 0022.   |
| 0024       | Select Alert Interrupt                       | Allows generation of an interrupt upon completion of an alert message by a poller. Reselection removes an interrupt resulting from a previous operation.  |
| 0025       | Clear Alert Interrupt                        | Clears interrupt and selection due to code 0024.  |
| 0026       | Select Station Interrupt (Note 1)            | Allows generation of an interrupt if a SEND key on a Display Station is depressed, if a poller receives a read message in response to a poll message or if an error is indicated. Reselection removes an interrupt resulting from a previous selection if a read or write operation is performed on the interrupting station prior to reselection. Stacking of station interrupts is possible and, if more than one station has had its SEND key depressed, another interrupt occurs immediately after reselection. |
| 0027       | Clear Station Interrupt (Note 1)             | Removes interrupt and selection resulting from code 0026.   |
| (Note 2)   | Alert Poller                                 | Instructs connected poller to send an alert message to the addressed remote site and station. Alert occurs in the polling sequence. If the alert is sent to a local station, it is rejected.  |

Note 1 — affect all stations simultaneously.

Note 2 — 1XXXXXXX0011 binary.

Table 3-2 identifies status conditions, lines, and octal codes characteristic of the Display Controller. The computer may sample any single status line or group of lines.

All conditions listed in table 3-2 except send request and print request, are general status conditions; ie, the computer connects only to the Display Controller and any existing station before sampling status. Lines 0, 2, 3, 4, 5, and 10 are on a per station basis, ie, a specific station must be referred to before sampling status. Lines not listed in table 3-2 are not used.

TABLE 3-2. DISPLAY CONTROLLER STATUS CONDITIONS

| LINE | OCTAL CODE | CONDITION          | DESCRIPTION   |
|------|------------|--------------------|---|
| 0    | XXX1       | Ready              | The Display Controller is ready when power is on and the RUN/MASTER CLEAR switch is in the RUN position. A particular station may become not ready if an operator depresses the PRINT key and the printer begins printout.            |
| 1    | XXX2       | Busy               | The Display Controller is busy when the Channel Busy and the Read signal or Write signal is active, or when the reset or reset-clear function is executed. The Display Station keys are inoperative during a read or write operation. |
| 2    | XXX4       | Send Request       | Indicates on a per station basis that an operator depressed the SEND key or that a connected poller has a read message or a message in error.   |
| 3    | XX1X       | Print Request      | Indicates on a per station basis that a print operation is requested by the station or it is performing a print operation.  |
| 4    | XX2X       | Poll Message Error | Indicates that the connected poller was unable to receive an expected response to a poll message in three attempts.   |



TABLE 3-2. DISPLAY CONTROLLER STATUS CONDITIONS (CONT)

| LINE | OCTAL CODE | CONDITION                    | DESCRIPTION   |
|------|------------|------------------------------|---|
| 5    | XX4X       | Alert Request                | A connected poller is ready to process an alert function from the computer. Any previous alert function has been processed.   |
| 6    | X1XX       | Station Interrupt            | Indicates that a station interrupt was caused by depressing one or more SEND keys, or that a poller detected a message in error or received a read message.   |
| 7    | X2XX       | Ready and Not Busy Interrupt | Indicates that a ready and not busy interrupt was generated when print-out completed and that the ready and not busy interrupt was selected.  |
| 8    | X4XX       | End of Operation Interrupt   | Indicates that an interrupt was generated by the end of a read/write operation, reset, or reset-clear function. A new function, or read or write operation may be initiated following the end of operation interrupt. |
| 9    | 1XXX       | Alert Interrupt              | Interrupt generated by completion of an Alert message to a remote site.   |
| 10   | 2XXX       | Poller Error                 | Error condition after three attempted write, clear-write, write-reset, or alert messages to a remote site from the connected poller.  |

#### INTERRUPTS.

The interrupt permits the display equipment to indicate to the computer certain preprogrammed conditions. The computer can selectively activate or deactivate these interrupt conditions.

Four conditions generate an interrupt and four function codes enable these interrupts to the computer for the Display Controller. Table 3-3 lists the interrupt conditions, enabling functions, and disabling functions. Refer to the specific enabling function code (table 3-2) for a complete description of the interrupt condition.

TABLE 3-3. DISPLAY CONTROLLER INTERRUPTS

| INTERRUPT          | FUNCTION CODE |         |
|--------------------|---------------|---------|
|                    | ENABLE        | DISABLE |
| Ready and Not Busy | 0020          | 0021    |
| End of Operation   | 0022          | 0023    |
| Alert              | 0024          | 0025    |
| Station            | 0026          | 0027    |

The computer must first connect to a specific Display Station before issuing any interrupt enable function codes. Normally, status is checked immediately following the connect. If the computer desires to perform a reset operation (function code 0010), or a read or write operation, and wants to be informed when the operation is completed, it transmits function code 0022 (interrupt on end of operation) prior to the operation.

An end of printout operation can interrupt the computer if the ready and not busy interrupt is enabled. After connecting to a specific Display Station and finding the station busy executing a printout, the computer has the option to discontinue the printout or select the interrupt on ready and not busy condition (function code 0020). Even though the function code is directed to a specific Display Station, it enables a station interrupt from any Display Station satisfying the ready and not busy condition.

If the computer wants to receive the data from a local Display Station, function code 0026 (station interrupt enable) is transmitted. An interrupt transmits when the SEND key on this station, or any other Display Station, is depressed.

Upon receiving an interrupt from the display equipment, the computer normally connects to the Display Controller and samples status to determine what caused the interrupt. It can immediately perform a read operation following a connect word having a select code 0000 if the interrupt is a station interrupt. A write operation or other interrupt requires connecting to a specific station before beginning the operation. After servicing an interrupt, the interrupt line may be cleared by reselecting or deselecting the same interrupt except station interrupt.

### SYMBOL DATA.

The display equipment symbol repertoire includes the alphabet in uppercase, arabic numerals (0 through 9), punctuation marks, and special symbols.

Table 3-4 presents the Display Controller symbol repertoire in alphabetic and numeric order. Figure 3-3 shows two quick reference charts for locating a

TABLE 3-4. SYMBOL REPERTOIRE

| SYMBOL | BCD |     | SYMBOL                   | BCD |     | SYMBOL | BCD                         |     |    |    |
|--------|-----|-----|--------------------------|-----|-----|--------|-----------------------------|-----|----|----|
|        | EXT | INT |                          | EXT | INT |        | EXT                         | INT |    |    |
| A      | 61  | 21  |                          | X   | 27  | 67     | Comma                       | ,   | 33 | 73 |
| B      | 62  | 22  |                          | Y   | 30  | 70     | Left paren                  | (   | 34 | 74 |
| C      | 63  | 23  |                          | Z   | 31  | 71     | Parity error                | ■   | 35 | 75 |
| D      | 64  | 24  | Colon                    | :   | 00  | 12     | End of<br>print (Note)      | '   | 36 | 76 |
| E      | 65  | 25  |                          | 1   | 01  | 01     | Logical OR                  | ^   | 37 | 77 |
| F      | 66  | 26  |                          | 2   | 02  | 02     | Hyphen                      | -   | 40 | 40 |
| G      | 67  | 27  |                          | 3   | 03  | 03     | Logical<br>AND              | ∨   | 52 | 52 |
| H      | 70  | 30  |                          | 4   | 04  | 04     | Dollar sign                 | \$  | 53 | 53 |
| I      | 71  | 31  |                          | 5   | 05  | 05     | Asterisk                    | *   | 54 | 54 |
| J      | 41  | 41  |                          | 6   | 06  | 06     | Arrow up                    | ↑   | 55 | 55 |
| K      | 42  | 42  |                          | 7   | 07  | 07     | Arrow down                  | ↓   | 56 | 56 |
| L      | 43  | 43  |                          | 8   | 10  | 10     | Greater than                | >   | 57 | 57 |
| M      | 44  | 44  |                          | 9   | 11  | 11     | Plus                        | +   | 60 | 20 |
| N      | 45  | 45  |                          | ∅   | 12  | 00     | Less than                   | <   | 72 | 32 |
| O      | 46  | 46  | Equal                    | =   | 13  | 13     | Period                      | .   | 73 | 33 |
| P      | 47  | 47  | Not equal                | ≠   | 14  | 14     | Right paren                 | )   | 74 | 34 |
| Q      | 50  | 50  | Less than or<br>equal to | ≤   | 15  | 15     | Greater than<br>or equal to | ≥   | 75 | 35 |
| R      | 51  | 51  | Percent                  | %   | 16  | 16     | Carriage<br>return (Note)   | -   | 76 | 36 |
| S      | 22  | 62  | Left bracket             | [   | 17  | 17     | End of<br>message           | Δ   | 77 | 37 |
| T      | 23  | 63  | Space                    |     | 20  | 60     |                             |     |    |    |
| U      | 24  | 64  | Right diagonal           | /   | 21  | 61     |                             |     |    |    |
| V      | 25  | 65  | Right bracket            | ]   | 32  | 12     |                             |     |    |    |
| W      | 26  | 66  |                          |     |     |        |                             |     |    |    |

Note — displayed as superscript, does not print.

|     |            |     |       |   |   |    |   |   |   |   |
|-----|------------|-----|-------|---|---|----|---|---|---|---|
|     |            | n → |       |   |   |    |   |   |   |   |
| m ↓ | INT<br>BCD | 0   | 1     | 2 | 3 | 4  | 5 | 6 | 7 |   |
|     | EXT<br>BCD | 0   | 1     | 2 | 3 | 4  | 5 | 6 | 7 |   |
|     | 0          | 0   | :     | 1 | 2 | 3  | 4 | 5 | 6 | 7 |
|     | 1          | 1   | 8     | 9 | 0 | =  | ≠ | ≤ | % | [ |
|     | 6          | 2   | SPACE | / | S | T  | U | V | W | X |
|     | 7          | 3   | Y     | Z | ] | ,  | ( | █ |   | Λ |
|     | 4          | 4   | -     | J | K | L  | M | N | O | P |
|     | 5          | 5   | Q     | R | V | \$ | * | ↑ | ↓ | > |
|     | 2          | 6   | +     | A | B | C  | D | E | F | G |
|     | 3          | 7   | H     | I | < | .  | ) | ≥ | - | Δ |

PARITY ERROR

END OF PRINT

CARRIAGE RETURN

END OF MESSAGE

**NOTE:**

00 internal BCD equals 12 external BCD  
 00 external BCD equals 12 internal BCD

Figure 3-3. Symbol Code Quick Reference Chart

symbol when given the 6-bit octal or BCD code. A two-digit code of the form m/n uniquely specifies each code, eg, external BCD code 65 represents the letter E.

Standard display format is 20 lines of 50 symbols per line with an optional display format of 13 lines of 80 symbols available. The Display Station INTENSITY/ON/OFF switch adjusts symbol intensity. Symbol size is adjustable internally and is normally set to generate symbols 1/8-inch wide by 1/4-inch high.





WORD FORMATS.

The display word format is 6 bits. Each 6-bit word specifies a symbol code or control code as listed in the symbol repertoire table.

Besides the display word format, there are five 12-bit interface word formats. The connect, function, data, and station word are transmitted on the data lines and are identified by a signal transmitted on a corresponding signal line. The status word is enabled to the computer on the status lines whenever the Display Controller is connected to the computer.

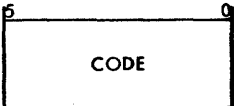
Table 3-5 lists all word formats and identifies the distinguishing signal where applicable.

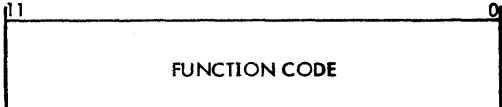
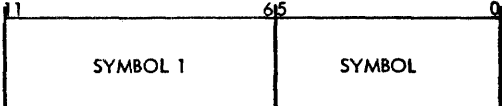
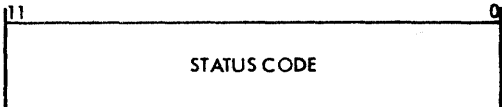
TABLE 3-5. WORD FORMATS

| WORD           | FORMAT   | SIGNAL   |
|----------------|--|----------|
| Display        |   | —        |
| Connect        |  | Connect  |
| Function       |  | Function |
| Data           |  | Data     |
| Status         |  | —        |
| Station        |  | Data     |
| Alert Function |  | Function |

The connect word contains information which directs the Display Controller to connect the computer data channel to the designated Display Station or poller. Bits 9 through 11, the equipment select code, designates the equipment number which may be chosen on the EQUIPMENT SELECTOR switch. Bits 0 through 3 (the station select code) are used to select the specific local Display Station or poller with which the computer is to communicate. A station select code of 0001 through 1100 binary designates the corresponding numbered Display Station or poller. A station select code of 0000 binary indicates that the computer requests a check of status conditions, or requests to communicate with the lowest numbered Display Station causing an interrupt. If no interrupt is present, connection is prevented.

Figure 3-4 shows the sequence of events upon receipt of a Connect signal. If the Display Controller is in a ready state, parity is checked upon receipt of the Connect signal. A parity error at this time illuminates the PARITY indicator and the display equipment disconnects in approximately 1 microsecond. Assuming parity is correct, the EQUIPMENT SELECTOR switch setting is compared to the equipment select code. If the two do not compare, a disconnect is performed in about 1 microsecond. An exact comparison allows the status lines to be enabled. After comparing the equipment select code, the Display Controller examines the station select code to see if it is addressing an existing Display Station or poller. If the device is non-existent or busy, a Reject signal is transmitted to the computer no sooner than 2 microseconds after the condition is detected. Assuming the Display Station or poller exists and is not busy, the Display Controller responds with a Reply signal in about 2 microseconds.

If the station select code contains all 0's and an interrupt condition is not pending, a Reject signal is sent to the computer. An interrupt condition at this time draws a Reply signal response from the Display Controller and the interrupting Display Station or poller is connected. The computer then reads at least one word (the station word) and normally continues the read operation until all of that station's data is read. If the interrupt condition is nonexistent, a connect is made to the Display Controller for reading Display Controller status only. No read or write operation is performed.

Once connected, the Display Controller is ready to perform any function desired by the computer in addition to a read or write operation. Figure 3-5 shows the sequence of events upon receipt of a Function signal. If the Display Controller is not connected, it takes no action in response to a Function signal.

An assembly/disassembly register in the Display Controller handles packing and unpacking chores for read and write operations respectively. The most significant 6 bits of the data word are always filled or emptied first. If the computer enables the Suppress Assembly/Disassembly line, the most significant 6 bits would

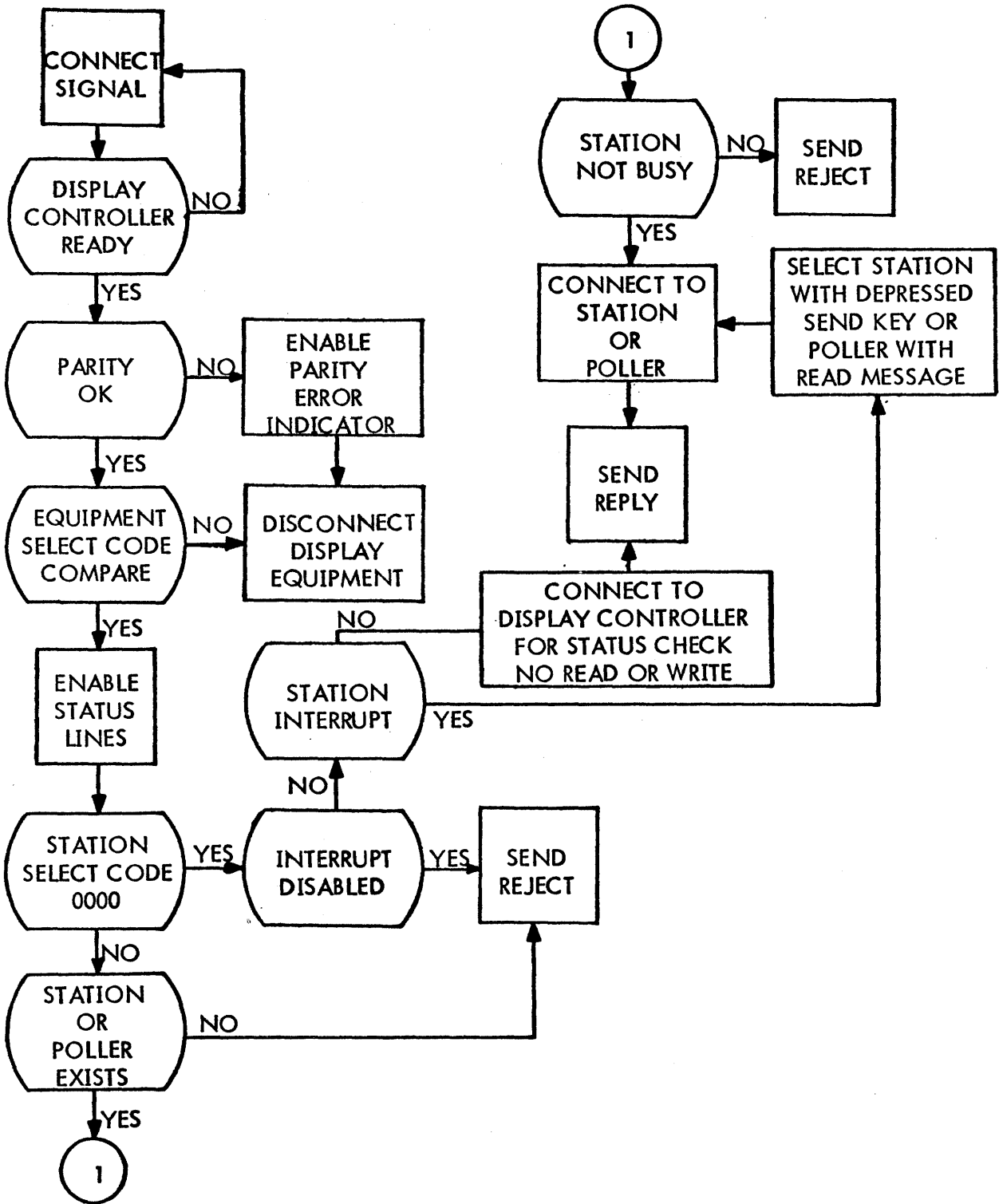

Figure 3-4. Connect Sequence

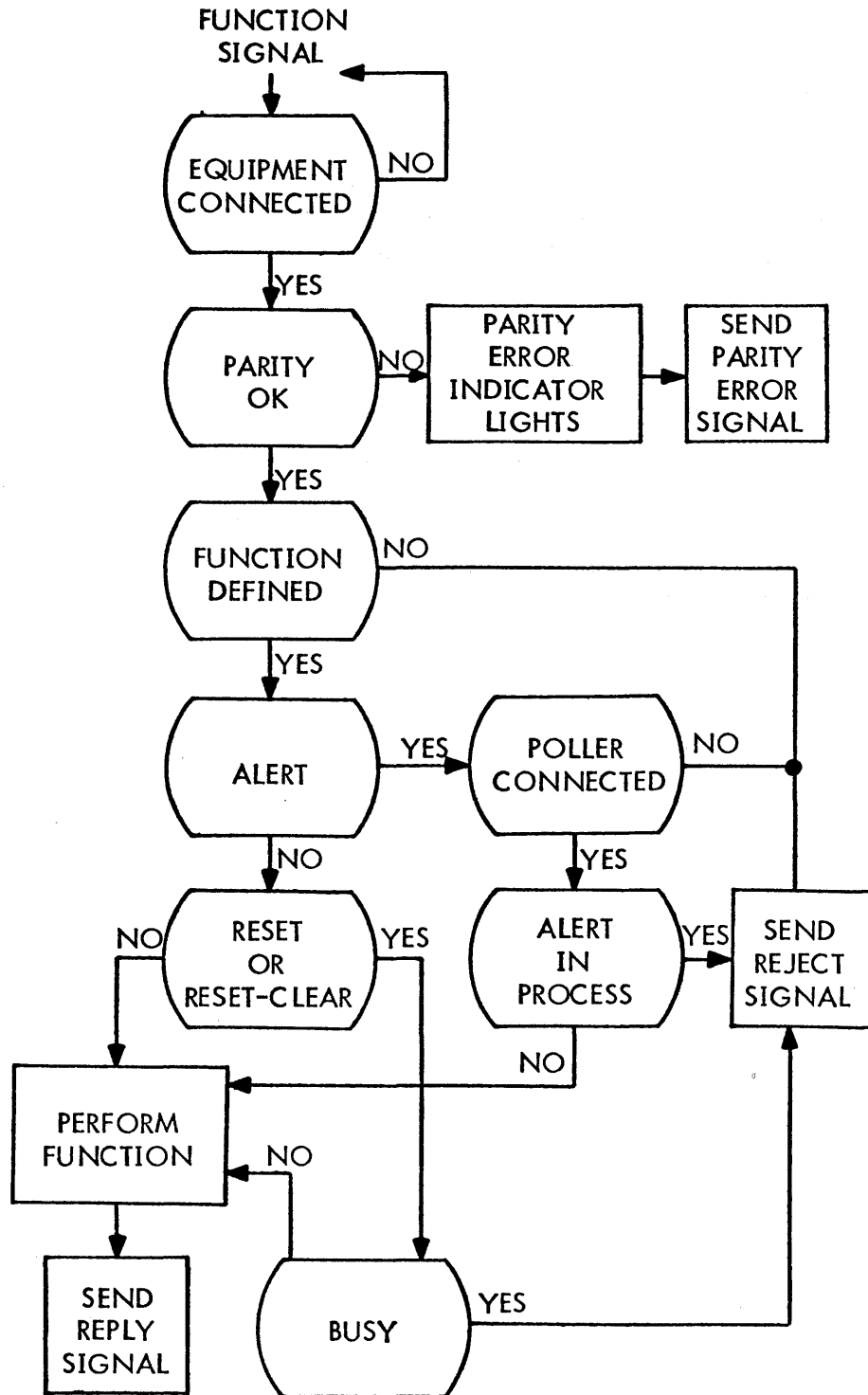

Figure 3-5. Function Sequence



neither be filled or emptied for the duration of the signal. The least significant 6 bits are unaffected; therefore, data transmission takes place in the form of one 6-bit word at a time.

### READ/WRITE OPERATIONS.

Read or write operations to or from a local Display Station may be performed any time at the discretion of the computer, after checking status. The computer-initiated action takes priority over the operator. If a read or write operation is initiated during a period when an operator is composing a message from the keyboard, the operator's keyboard is locked out and computer operation takes over. A read or write operation to a Display Station performing a printout results in termination of the printout and the read or write operation is performed at the specified Display Station.

The Display Controller allows the computer to enable an interrupt on an end of printout condition. Following connection to a specific Display Station and sampling status, print request status (line 3) is enabled if the Display Station requests a print operation or if it is presently performing a printout. Not ready status indicates the Display Station is actually performing a printout. Using function code 0020 octal, the computer may enable the select interrupt on ready and not busy condition. Upon completing printout, an interrupt is sent to the computer and status line 7 (ready and not busy interrupt) is made active. The 0020 function code enables an interrupt to generate when any Display Station completes printout.

Computer read and write operations do not take priority in the poller. The poller scans the remote stations to determine if a SEND key is depressed. If this condition exists, the selected station transmits a read message to the poller. After storing the message in memory, the poller generates a send request and the computer responds with a read operation. In response to the read message, the computer must send a write message to the selected poller. The poller then relays this message to the remote station.

The alert function turns on the ALERT light and audible alarm at the remote station; the SEND key must be depressed to turn them off. The subsequent read message enables the computer to perform a write operation.

Read operations may be initiated from the local or remote Display Stations by an operator depressing the SEND key or from the computer by programmed instructions (local Display Station only). A write operation is initiated only from the computer. Following is a description of read and write operations.

READ OPERATION INITIATED BY A REQUESTING STATION.

A requesting station is a local Display Station at which a SEND key was depressed, or a poller which received a read message from a remote station. At a requesting station an end of message symbol is inserted at the entry marker position, the entry marker is moved to the upper left corner, and a station interrupt is initiated if the station interrupt is enabled by the computer. The computer responds to the interrupt with a connect word containing a station select code of 00 octal. The Display Controller then connects to the requesting station in scanning sequence and activates the status lines. The computer must perform a read operation to clear the send request. If a read operation is not performed, the station interrupt is sent again upon receipt of the station interrupt enable.

The station word (shown in table 3-5), containing the number of the scanner selected requesting station, is sent in response to the first Data signal during a station-interrupt initiated read operation. If the selected requesting station is a poller, the remote site and station are indicated in bits 4 through 10. Successive words after the station word contain data stored in the delay line starting at the entry marker position.

When the end of message code is detected, it is sent to the computer in a data word. In response to the next Data signal following an end of message code, the End of Record signal accompanied by an all-zero data word is sent instead of the Reply signal. The Read signal terminates the read operation and becomes disabled for more than 200 nanoseconds. Data may therefore be read beyond the end of message code if the Read signal remains enabled. Figure 3-6 shows simplified read operation timing.

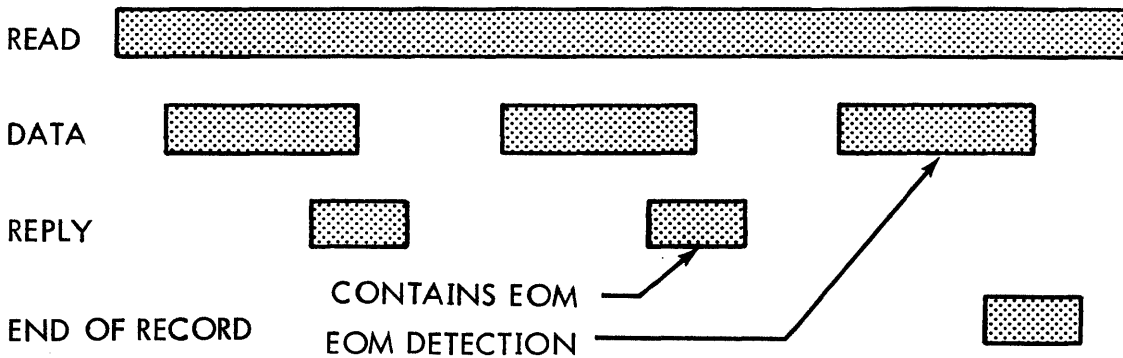

Figure 3-6. Simplified Read Timing

If successive read operations are performed without resetting the entry marker (such as repetitive one-word reads) one symbol is lost each time the Read signal is dropped.

#### READ OPERATION INITIATED BY THE COMPUTER.

The computer may initiate a read operation at any time the connected local Display Station or poller is not busy. Discretion is required in the use of this operation since it prevents entry of data by a Display Station operator. After connecting, the entry marker may be moved to the upper left corner by the reset function or may be left at its current position. In response to the Read and Data signals, data words are sent along with the Reply signal. A read operation performed on a connect to a specific station does not send the station word.

#### WRITE OPERATION TO A LOCAL DISPLAY STATION.

Data may be written into a connected station at any time the station is not busy. After connecting and checking status, the computer sends data words to be written on the crt starting at the position of the entry marker. A reset or reset-clear function may move the entry marker to the upper left corner before writing data. Sequential symbols in data words are written from left to right and from top to bottom on the crt. After the last symbol is written in the lower right corner, the entry marker moves to the upper left corner and data writing may continue, with the later data replacing data written earlier. Figure 3-7 shows simplified write operation timing.

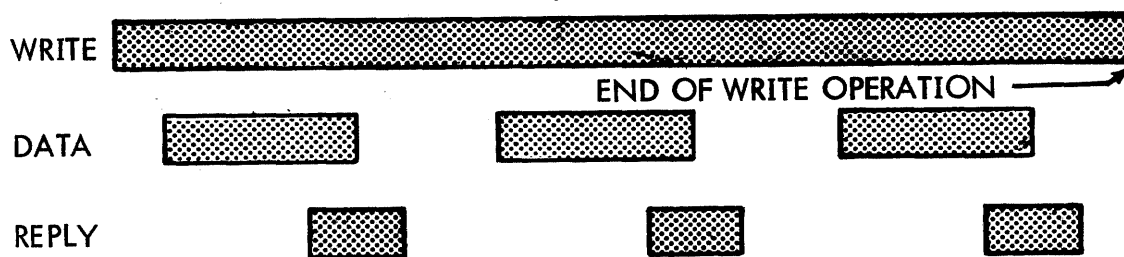

Figure 3-7. Simplified Write Timing

#### WRITE OPERATION TO A POLLER.

Data is always transferred to a poller after a read operation from the poller. After connecting to the poller and checking status, the computer sends data words

to be written into the poller memory starting at the position of the entry marker. The entry marker is always at start-of-memory after any computer read operation.

A reset function immediately preceding a write to the poller results in a write-reset message from the poller to the remote station; a reset-clear function results in a clear-write message. No function results in write message. Sequential symbols in data words are written into the poller memory. The poller is informed that it is to send the message when the Write signal drops. The write, write-reset, or clear-write message is sent to the remote station which had just previously sent a read message.

#### PROGRAMMING AIDS.

Following are several points concerning display equipment timing:

- (a) The Display Controller is busy for 33 microseconds after the last Reply signal is sent at the end of a write operation.
- (b) The Display Controller is busy from 3.2 microseconds to 20 milliseconds after receipt of a reset function.
- (c) If a read or write operation follows a reset function which transmits an interrupt upon completion, 20-millisecond delay (after the end of operation interrupt is sent) occurs before the first data word is stored or read from memory.
- (d) One symbol time is 16.8 microseconds. Each data word contains two symbols and requires 33.6 microseconds. The delay-line memory cycle time is 20 milliseconds. During a read or write operation, successive data words must follow within 33.6 microseconds (time required to read or write two symbols) or a 20-millisecond delay occurs between bytes due to delay line latency characteristics.

#### PROGRAMMING RESTRICTIONS.

- (a) It is necessary to read at least two 12-bit words to clear the send ff when a connect is issued after an interrupt.
- (b) There should not be any unsolicited read or write operations (poller only).
- (c) Sending an end of print message to a Display Station initiates operation of its associated Printer Station(s).

### POLLER TRANSLATION.

The poller converts all codes and signals to a format which is compatible with Data Set operation. Signals transmitted between the poller and the Data Set meet or exceed the minimum of EIA Standard RS-232. A negative voltage of greater than -6 volts represents a logical 1; a positive voltage greater than +6 volts represents a logical 0. Half duplex, 2- or 4-wire operation, DATA-PHONE Data Set 201A or 201B service is required. Private communications lines are necessary and no provision is made for automatic ringing or answering.

A single-phase, 120-volt, 60-Hz, three-wire outlet from the Display Controller is supplied for the Data Set, so the same ground bus is used for both. This measure is necessary to prevent impulse noise potentials which might otherwise develop and cause data errors.

The poller sends and receives data in an 8-bit code which is transmitted serially over Send Data and Receive Data lines. These bits are synchronized with the Serial Clock Receive and Serial Clock Transmit signals. Data Set 201A operates at 2000 baud, Data Set 201B at 2400 baud.

### INTERFACE SIGNALS.

Figure 3-8 shows interface signals between the Data Set and the poller. The arrows indicate signal origin. Following paragraphs provide an elaboration on the signals shown in figure 3-8.

#### Send Data.

The Send Data signal originates in the poller and contains serial data. Positive polarity represents a logical 0 and negative polarity represents a logical 1. Data bits are provided to the Data Set at the time of positive transition of the Serial Clock Transmit signal.

#### Request to Send.

The poller makes the Request to Send signal positive when a transmit operation is desired. Placing a negative potential on the line returns the Data Set to a receive condition.

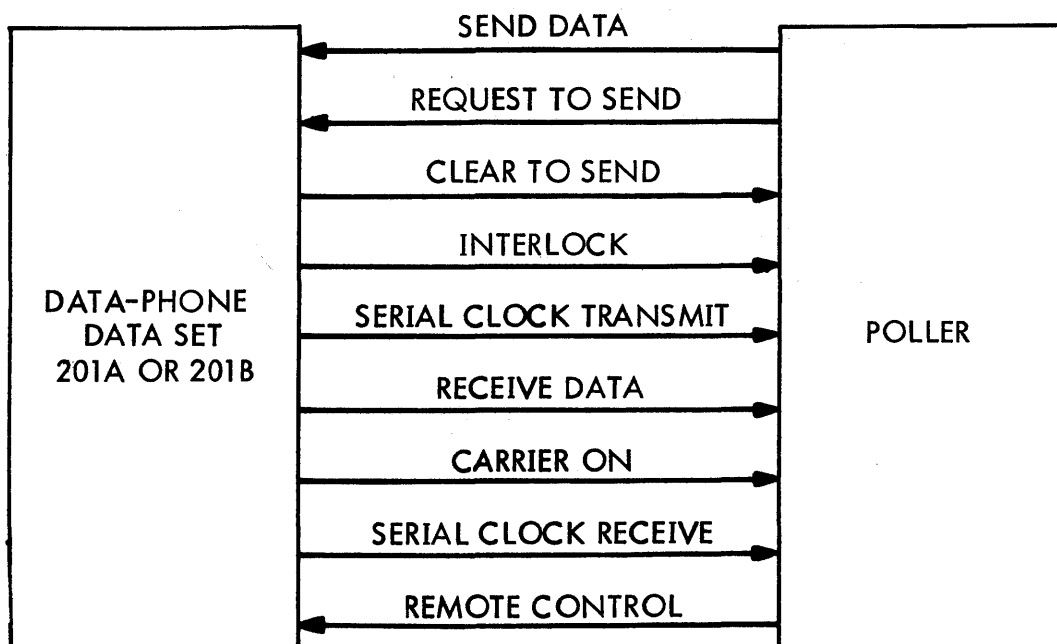

Figure 3-8. Poller Interface Signals

Clear to Send.

The Data Set makes the Clear to Send signal positive in response to a Request to Send signal from the poller. The amount of time elapsed between the leading edge of the Request to Send and the leading edge of Clear to Send is determined by the Data Set strapping options. The Data Set makes the Clear to Send signal negative when the Request to Send signal drops.

Interlock.

A +6 volts on the Interlock Line indicates that the Data Set is ready to send or receive data. A 0-volt signal indicates that the Data Set is not in an operating condition.

### Serial Clock Transmit.

The Serial Clock Transmit signal is a symmetrical square wave of +6 volts to -6 volts amplitude originating in the Data Set which is used to synchronize the acceptance of data by the Data Set. Data is placed on the Send Data line at the time of the positive transition of the Serial Clock Transmit signal and is sampled by the Data Set at the time of negative transition.

### Receive Data.

The Receive Data signal contains serial binary data which is synchronized with the Serial Clock Receive signal. Positive polarity is defined as a logical 0 and negative polarity as a logical 1.

### Carrier On.

A positive potential at the Carrier On terminal indicates that the Data Set is receiving the carrier. A negative potential indicates that no carrier is being received. The Carrier On signal changes from negative to positive within 9 milliseconds after carrier appears at the receiver terminal.

### Remote Control.

A positive potential indicates that the poller is ready to communicate with the Data Set.

### Serial Clock Receive.

The Serial Clock Receive signal is a symmetrical square wave of +6 volts to -6 volts amplitude. The square wave is synchronized with the receiver timing circuits. Data bits on the Receive Data line are initiated synchronously with the positive transition of the Serial Clock Receive signal and are sampled at the negative transition.

## POLLER CONTROL CODES.

The basic poller codes are eight bits long and are used for communication between the poller and the remote sites. The most significant bit, which is received last serially, is the parity bit. Parity is odd. The following paragraphs list poller codes. Table 3-6 lists control codes and their octal translation.

TABLE 3-6. CONTROL CODES

| <u>DESCRIPTION</u>                   | <u>7-BIT OCTAL TRANSLATION</u> |
|--------------------------------------|--------------------------------|
| Start of Message (SOM)               | 001                            |
| USASCII End of Message (USASCII EOM) | 003                            |
| Poll                                 | 005                            |
| Acknowledge (ACK)                    | 006                            |
| Alert                                | 007                            |
| Reset-Write                          | 014                            |
| Write                                | 021                            |
| Clear-Write                          | 022                            |
| Read                                 | 023                            |
| Synchronization (SYNC)               | 026                            |
| Reject                               | 030                            |

Start of Message.

The start of message code indicates that the next 7-bit word contains the site address. The start of message code follows the synchronization codes. It is both initiated and received by the poller.

Alert.

The poller initiates the alert code when instructed by the computer. The alert code designates a message which turns on the ALERT light on the addressed remote site Display Station.



### USASCII End of Message .

The USASCII end of message code indicates that the previous word was the last word of data. The word following the USASCII end of message code is the message parity word. This code is both initiated and received by the poller.

### Message Parity .

Message parity is applicable from the start of message through the USASCII end of message code, and excludes all sync codes. The message parity code is odd. The parity bit is excluded.

### Poll .

The poller initiates the poll code which designates the poll message. The poll message instructs the remote site to respond with a read message if a SEND key has been depressed or a read request active is set or a reject message if the above two conditions do not exist.

### Acknowledge .

The acknowledge code originates at a remote site and designates a message which acknowledges receipt of a write, reset-write, clear-write, or alert message with no errors.

### Reset-Write .

The poller transmits the reset-write code when instructed by the computer. The code designates a message which instructs the addressed display equipment to write data starting at the upper left corner. The reset-write code is followed by 12 sync codes to allow time for the entry marker to reset.

### Write .

The poller initiates the write code when instructed by a computer message. The message contains data to be written on the remote crt starting at the current entry marker position.

Clear-Write.

The poller initiates the clear-write code when instructed by the computer. This code designates a message which instructs the addressed Display Station to clear data from the crt and write the contained data starting at the upper left corner. The poller transmits 12 sync codes following the clear-write code to allow time for the entry marker to reset.

Read.

The read code originates at a remote site and designates a message containing data on the Display Station crt which is to be sent to the computer.

Synchronization.

The poller receives and transmits the sync code. Four sync codes are transmitted at the beginning of each message to assure receiver synchronization. These codes are not considered for purposes of message parity.

Sync codes also act as synchronization idles when contained within the message structure (reset-write and clear-write).

Reject.

The reject code originates at a remote site. This code designates a message which informs the poller that a SEND key was not depressed, a read request active was not set before receipt of the poll message, or because of a busy condition, a write, reset-write or clear-write was rejected.

## SYMBOL SUBSET.

The symbol subset codes (codes with bit 5 or 6 a logical 1, but not both) are stored in the delay-line memory and specify data presented or are displayed on the crt of a Display Station at a remote site. These codes are the data sent in read, write, reset-write, and clear-write messages.

An escape code (76) followed by any code other than carriage return, E1, E2, or E3 codes will be converted to a space code (20 external BCD or 60 internal BCD). Refer to tables 3-7 and 3-8.

TABLE 3-7. SYMBOL SUBSET CONVERSION TO COMPUTER

| INTERNAL CODE | EXTERNAL CODE | ESCAPE CODE RECEIVED |
|---------------|---------------|----------------------|
| 36            | 76            | 76 01 (CR)           |
| 37            | 77            | 76 02 (E1)           |
| 76            | 36            | 76 40 (E2)           |
| 75            | 35            | 76 41 (E3)           |

TABLE 3-8. SYMBOL SUBSET CONVERSION FROM COMPUTER

| INTERNAL BCD | EXTERNAL BCD | ESCAPE CODE SENT |
|--------------|--------------|------------------|
| 36           | 76           | 76 01 (CR)       |
| 37           | 77           | 76 02 (E1)       |
| 76           | 36           | 76 40 (E2)       |
| 75           | 35           | 76 41 (E3)       |

#### Station Address.

The station address code designates the remote site Display Station to which a poller is communicating. The station address in a read message is retained by the poller and sent to the computer. The next write, reset-write, or clear-write message from the computer to the poller is automatically sent to the Display Station from which the read message was received.

#### Site Address.

The site address code designates the remote site to which a message is addressed or from which a message is received. The remote sites polled are designated by site address switches on the Display Controller auxiliary maintenance panels. Polling takes place in numerical order.

MESSAGE FORMAT.

Messages received and sent by the poller consist of several codes. The general message format is shown in figure 3-9. All messages transmitted are preceded by four sync codes to assure synchronization recovery on the receiving end. The start of message code designates that the next code is the first word of the message. The site address and station address follow in that order. The control code defines the command or data which follows. Data to or from a remote Display Station may consist of 1 to 1040 words. The USASCII end of message code designates that the previous word was the last word of the message. The message parity code follows the end of message code. Message parity is applicable from the start of message through the end of message code inclusive and excludes all sync codes. Specific messages sent and received are listed in tables 3-9 and 3-10.

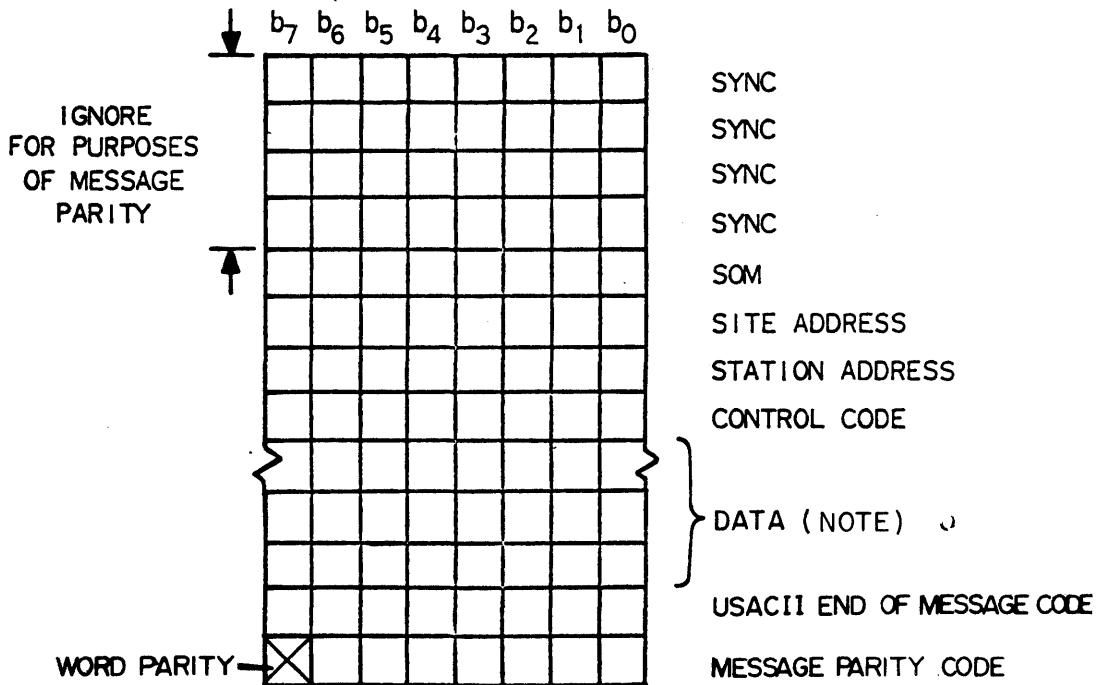

NOTE: 1-1000 WORDS (50X20) DISPLAY FORMAT).  
 1-1040 WORDS (80X13) DISPLAY FORMAT).

Figure 3-9. General Message Format

Synchronization.

After the Data Set turns on the Carrier On signal, data input from the Data Set is fed into a buffer register. After each data bit is received, the contents of the buffer register is examined to determine if the code is a sync code. When two

TABLE 3-9. MESSAGES SENT BY THE POLLER

| <u>MESSAGE</u> |  | <u>CODE</u>   |
|----------------|--|---|
| Alert          | SYNC<br>↓<br>SYNC<br>START OF MESSAGE<br>SITE ADDRESS<br>STATION ADDRESS<br>ALERT<br>USASCII END OF MESSAGE<br>MESSAGE PARITY      | 4 Total   |
| Poll           | SYNC<br>↓<br>SYNC<br>START OF MESSAGE<br>SITE ADDRESS<br>STATION ADDRESS<br>POLL<br>USASCII END OF MESSAGE<br>MESSAGE PARITY       | 4 Total   |
| Write          | SYNC<br>↓<br>SYNC<br>START OF MESSAGE<br>SITE ADDRESS<br>STATION ADDRESS<br>WRITE<br>↓<br>USASCII END OF MESSAGE<br>MESSAGE PARITY | 4 Total<br><br><br><br><br><br><br>1 to 1000* words of data |
| Clear-Write    | SYNC<br>↓<br>SYNC<br>START OF MESSAGE<br>SITE ADDRESS<br>STATION ADDRESS   | 4 Total   |

\* 1040 words if 80 by 13 display format

TABLE 3-9. MESSAGES SENT BY THE POLLER (CONT)

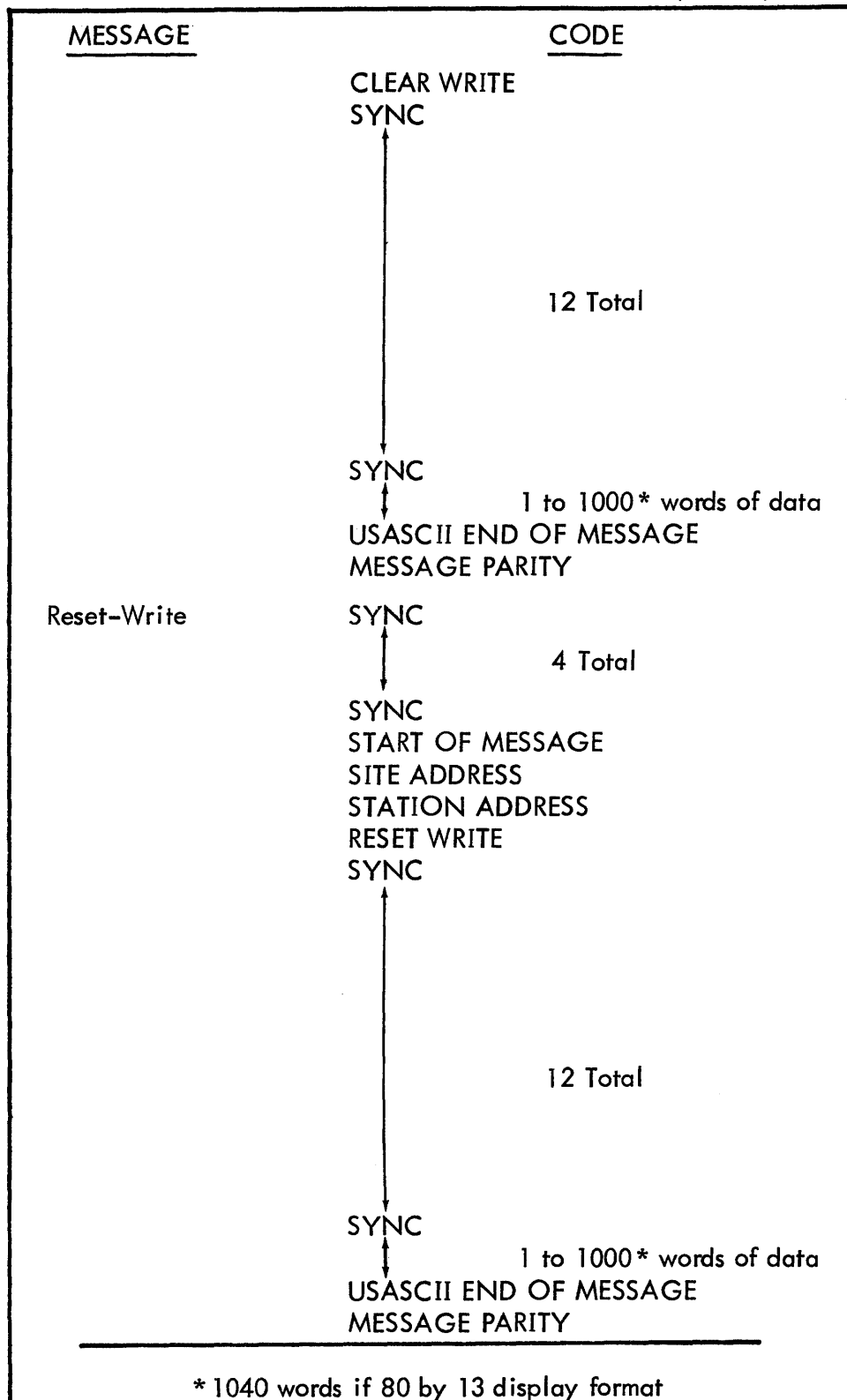

TABLE 3-10. MESSAGES RECEIVED BY THE POLLER

| <u>MESSAGE</u> |                        | <u>CODE</u>              |
|----------------|------------------------|--------------------------|
| Reject         | SYNC                   | 4 Total                  |
|                | ↓                      |                          |
| Read           | SYNC                   | 4 Total                  |
|                | ↓                      |                          |
| Acknowledge    | SYNC                   | 4 Total                  |
|                | ↓                      |                          |
|                | START OF MESSAGE       |                          |
|                | SITE ADDRESS           |                          |
|                | STATION ADDRESS        |                          |
|                | REJECT                 |                          |
|                | USASCII END OF MESSAGE |                          |
|                | MESSAGE PARITY         |                          |
|                | ↓                      |                          |
|                | START OF MESSAGE       |                          |
|                | SITE ADDRESS           |                          |
|                | STATION ADDRESS        |                          |
|                | READ                   |                          |
|                | ↓                      | 1 to 1000* words of data |
|                | USASCII END OF MESSAGE |                          |
|                | MESSAGE PARITY         |                          |
|                | ↓                      |                          |
|                | START OF MESSAGE       |                          |
|                | SITE ADDRESS           |                          |
|                | STATION ADDRESS        |                          |
|                | ACKNOWLEDGE            |                          |
|                | USASCII END OF MESSAGE |                          |
|                | MESSAGE PARITY         |                          |

\* 1040 words if 80 by 13 display format

consecutive sync codes are detected, the poller assembles the next 8 bits and examines the contents to detect the start of message code. Unless at least two successive sync codes followed by a start of message code are detected, the poller again searches for the same pattern.

### Alert Message.

The computer cannot directly send a write, reset-write, or clear-write message to be written on a remote Display Station. It can indicate to a remote display equipment that the computer has a message to be written by initiating an alert message. The alert message is initiated by the computer as an alert function to the poller.

At the time the poller would normally poll a site, it determines if an alert function was received for that site. The poller then sends an alert message instead of a poll message. The remote Display Station, upon receipt of an alert message, lights the ALERT indicator and responds with an acknowledge message. Operator action (depress SEND key) is necessary before a write message can be sent.

### Polling.

The following description of the poller operation assumes that no error occurred while being transmitted over the DATA-PHONE and that the remote site is operating properly.

The poller is normally in a poll status during which time it sends periodic and sequential poll messages to the sites. If a SEND key is depressed at a site, the remote display equipment responds with a read message. If a SEND key is not depressed, the remote display equipment responds with a reject message. If a read message is received, it is transferred to the computer as a message from a local station would be transferred. The poller responds with a reset-write, write, or clear-write message addressed to the Display Station at which the SEND key was depressed. The poller sends the message to the remote Display Station. The remote display equipment responds to the reset-write, write, or clear-write message with an acknowledge message which completes the communication.

### Reject Message.

The reject message is a reply from a remote site to a poll message indicating that a SEND key was not depressed. The reject message also is used to inform the poller that the previous write, clear-write, reset-write or alert function was not performed. The poller interprets this as an error.



Read Message .

The read message is a reply from a remote site to a poll message indicating a SEND key was depressed. The data, read from the crt, begins at the upper left corner and terminates with the data subset end of message code. The read message enables send request status and the station interrupt. The computer then reads the site address and station address in the station word. After reading the station word, the computer may continue to read the rest of the data in the message or may send a write message immediately. The computer reading a data word clears the send request.

Write Message .

The write message contains data from the computer to be written on the crt of a remote Display Station, starting at the present or reset entry marker position. A write, reset-write, or clear-write message is always sent in reply to a read message (with correct parity) from a remote site. After receiving a write message with correct channel parity from the computer, the poller switches to transmit and transfers the data to a remote site.

Acknowledge Message .

If the message is an acknowledge in response to an alert message, alert request and poll interrupt status are set. The computer, upon reading status, is informed that the alert message was received by the remote Display Station. An acknowledge response to a write, reset-write, or clear-write message turns the site indicator off and the polling resumes.

## ERROR PROCESSING.

Errors may arise between the sending of a message to a remote site and receiving a message from a remote site. The poller recognizes these errors:

- (a) Lack of response before time out.
- (b) Parity error in a received message.
- (c) An unexpected response such as a read message in response to a write message.

Any one of the error conditions causes the message to be retransmitted. The message is transmitted up to three times in attempting to get an error-free response. If, after three transmissions, an error-free response cannot be obtained, the poller ceases trying to communicate with that remote site.

If three attempts to successfully communicate an alert message to a remote display equipment fail, the Interrupt signal is enabled and the poller resumes polling. When the computer selects the poller, poll interrupt, poller error, and alert request status are indicated.

Three unsuccessful attempts to communicate a write, write-reset, or clear-write message to a remote site results in an Interrupt signal. Selection of the poller indicates poller error, station interrupt, and send request status. The computer must then read the station word. The computer may reread the station word, if it contained a parity error, by reconnecting to station 0. In order to clear the status bits and resume polling, it is necessary that the computer send a release function.

If a poll message cannot be successfully communicated in three attempts, the Interrupt signal is, again, enabled. When the poller is connected, it indicates send request, poll failure, and station interrupt status. The computer then reads the station word.

#### POLLER SYMBOL REPERTOIRE.

The poller communicates with a 7-bit code plus parity. The least significant bit (bit 0) is received first, and bit 7 is parity.

Codes with bit 6 or bit 5 (but not both) a logical 1 are stored in the delay-line memory associated with the connected poller. These codes are the data sent in read, write, reset-write, and clear-write communications with the remote sites. Remaining codes specify various functions, site address, and station address. Figure 3-10 lists symbol and function codes according to their binary translation.

|                |                |                |                                  | NOTE 1             |                 |                 |        | DATA SUBSET |       |                               |    |  |  |
|----------------|----------------|----------------|----------------------------------|--------------------|-----------------|-----------------|--------|-------------|-------|-------------------------------|----|--|--|
|                |                |                | b <sub>6</sub>                   | 0                  | 0               | 0               | 0      | 1           | 1     | 1                             | 1  |  |  |
|                |                |                | b <sub>5</sub>                   | 0                  | 0               | 1               | 1      | 0           | 0     | 1                             | 1  |  |  |
| b <sub>3</sub> | b <sub>2</sub> | b <sub>1</sub> | b <sub>4</sub><br>b <sub>0</sub> | 0                  | 1               | 0               | 1      | 0           | 1     | 0                             | 1  |  |  |
| 0              | 0              | 0              | 0                                |                    |                 | - MINUS<br>(E2) | +      | :           | BLANK | STATION<br>ADDRESS<br>ON POLL | 0  |  |  |
| 0              | 0              | 0              | 1                                | SOM                | WRITE           | J<br>(E3)       | A      | 1<br>(CR)   | /     | 1                             | 1  |  |  |
| 0              | 0              | 1              | 0                                |                    | CLEAR-<br>WRITE | K               | B      | 2<br>(E1)   | S     | 2                             | 2  |  |  |
| 0              | 0              | 1              | 1                                | US<br>ASCII<br>EOM | READ            | L               | C      | 3           | T     | 3                             | 3  |  |  |
| 0              | 1              | 0              | 0                                |                    |                 | M               | D      | 4           | U     | 4                             | 4  |  |  |
| 0              | 1              | 0              | 1                                | POLL               |                 | N               | E      | 5           | V     | 5                             | 5  |  |  |
| 0              | 1              | 1              | 0                                | ACK                | SYNC            | O               | F      | 6           | W     | 6                             | 6  |  |  |
| 0              | 1              | 1              | 1                                | ALERT              |                 | P               | G      | 7           | X     | 7                             | 7  |  |  |
| 1              | 0              | 0              | 0                                |                    | REJECT          | Q               | H      | 8           | Y     | 8                             | 8  |  |  |
| 1              | 0              | 0              | 1                                |                    |                 | R               | I      | 9           | Z     | 9                             | 9  |  |  |
| 1              | 0              | 1              | 0                                |                    |                 | V               | <      | β           | ]     | 10                            | 10 |  |  |
| 1              | 0              | 1              | 1                                |                    |                 | \$              | .      | =           | ,     | 11                            | 11 |  |  |
| 1              | 1              | 0              | 0                                |                    |                 | *               | )      | ≠           | (     | 12                            | 12 |  |  |
| 1              | 1              | 0              | 1                                |                    |                 | ↑               | ≥      | ≤           |       |                               |    |  |  |
| 1              | 1              | 1              | 0                                |                    |                 | ↓               | ESCAPE | %           |       |                               |    |  |  |
| 1              | 1              | 1              | 1                                |                    |                 | >               |        | [           | ^     |                               |    |  |  |

NOTES:

1. Set aside for USASCII control codes.
2. The lower portion of the four two-symbol data subset blocks are the interpretation of the codes when they immediately follow an escape code.

Figure 3-10. Symbol and Function Codes, Binary Translation

TABLE 1A-1. POWERS OF 2

| $2^n$        | $n$ | $2^{-n}$                                  |  |  |  |  |  |  |  |  |  |  |
|--------------|-----|---|--|--|--|--|--|--|--|--|--|--|
| 1            | 0   | 1.0                                       |  |  |  |  |  |  |  |  |  |  |
| 2            | 1   | 0.5                                       |  |  |  |  |  |  |  |  |  |  |
| 4            | 2   | 0.25                                      |  |  |  |  |  |  |  |  |  |  |
| 8            | 3   | 0.125                                     |  |  |  |  |  |  |  |  |  |  |
| 16           | 4   | 0.0625                                    |  |  |  |  |  |  |  |  |  |  |
| 32           | 5   | 0.03125                                   |  |  |  |  |  |  |  |  |  |  |
| 64           | 6   | 0.015625                                  |  |  |  |  |  |  |  |  |  |  |
| 128          | 7   | 0.0078125                                 |  |  |  |  |  |  |  |  |  |  |
| 256          | 8   | 0.00390625                                |  |  |  |  |  |  |  |  |  |  |
| 512          | 9   | 0.001953125                               |  |  |  |  |  |  |  |  |  |  |
| 1024         | 10  | 0.0009765625                              |  |  |  |  |  |  |  |  |  |  |
| 2048         | 11  | 0.00048828125                             |  |  |  |  |  |  |  |  |  |  |
| 4096         | 12  | 0.000244140625                            |  |  |  |  |  |  |  |  |  |  |
| 8192         | 13  | 0.0001220703125                           |  |  |  |  |  |  |  |  |  |  |
| 16384        | 14  | 0.00006103515625                          |  |  |  |  |  |  |  |  |  |  |
| 32768        | 15  | 0.000030517578125                         |  |  |  |  |  |  |  |  |  |  |
| 65536        | 16  | 0.0000152587890625                        |  |  |  |  |  |  |  |  |  |  |
| 131072       | 17  | 0.00000762939453125                       |  |  |  |  |  |  |  |  |  |  |
| 262144       | 18  | 0.000003814697265625                      |  |  |  |  |  |  |  |  |  |  |
| 524288       | 19  | 0.0000019073486328125                     |  |  |  |  |  |  |  |  |  |  |
| 1048576      | 20  | 0.00000095367431640625                    |  |  |  |  |  |  |  |  |  |  |
| 2097152      | 21  | 0.000000476837158203125                   |  |  |  |  |  |  |  |  |  |  |
| 4194304      | 22  | 0.0000002384185791015625                  |  |  |  |  |  |  |  |  |  |  |
| 8388608      | 23  | 0.00000011920928955078125                 |  |  |  |  |  |  |  |  |  |  |
| 16777216     | 24  | 0.000000059604644775390625                |  |  |  |  |  |  |  |  |  |  |
| 33554432     | 25  | 0.0000000298023223876953125               |  |  |  |  |  |  |  |  |  |  |
| 67108864     | 26  | 0.00000001490116119384765625              |  |  |  |  |  |  |  |  |  |  |
| 134217728    | 27  | 0.000000007450580596923828125             |  |  |  |  |  |  |  |  |  |  |
| 268435456    | 28  | 0.0000000037252902984619140625            |  |  |  |  |  |  |  |  |  |  |
| 536870912    | 29  | 0.00000000186264514923095703125           |  |  |  |  |  |  |  |  |  |  |
| 1073741824   | 30  | 0.000000000931322574615478515625          |  |  |  |  |  |  |  |  |  |  |
| 2147483648   | 31  | 0.0000000004656612873077392578125         |  |  |  |  |  |  |  |  |  |  |
| 4294967296   | 32  | 0.00000000023283064365386962890625        |  |  |  |  |  |  |  |  |  |  |
| 8589934592   | 33  | 0.000000000116415321826934814453125       |  |  |  |  |  |  |  |  |  |  |
| 17179869184  | 34  | 0.0000000000582076609134674072265625      |  |  |  |  |  |  |  |  |  |  |
| 34359738368  | 35  | 0.00000000002910383045673370361328125     |  |  |  |  |  |  |  |  |  |  |
| 68719476736  | 36  | 0.000000000014551915228368851808640625    |  |  |  |  |  |  |  |  |  |  |
| 137438953472 | 37  | 0.0000000000072759576141834259033203125   |  |  |  |  |  |  |  |  |  |  |
| 274877906944 | 38  | 0.00000000000363797880709171295166015625  |  |  |  |  |  |  |  |  |  |  |
| 549755813888 | 39  | 0.000000000001818989403545858475830078125 |  |  |  |  |  |  |  |  |  |  |

TABLE 1A-2. OCTAL-DECIMAL CONVERSION TABLE (SHEET 1 OF 4)

|      | 0    | 1    | 2    | 3    | 4    | 5    | 6    | 7    |  |                   |
|------|------|------|------|------|------|------|------|------|--|-------------------|
| 0000 | 0000 | 0001 | 0002 | 0003 | 0004 | 0005 | 0006 | 0007 |  |                   |
| 0010 | 0008 | 0009 | 0010 | 0011 | 0012 | 0013 | 0014 | 0015 |  |                   |
| 0020 | 0016 | 0017 | 0018 | 0019 | 0020 | 0021 | 0022 | 0023 |  |                   |
| 0030 | 0024 | 0025 | 0026 | 0027 | 0028 | 0029 | 0030 | 0031 |  |                   |
| 0040 | 0032 | 0033 | 0034 | 0035 | 0036 | 0037 | 0038 | 0039 |  |                   |
| 0050 | 0040 | 0041 | 0042 | 0043 | 0044 | 0045 | 0046 | 0047 |  |                   |
| 0060 | 0048 | 0049 | 0050 | 0051 | 0052 | 0053 | 0054 | 0055 |  |                   |
| 0070 | 0056 | 0057 | 0058 | 0059 | 0060 | 0061 | 0062 | 0063 |  |                   |
|      |      |      |      |      |      |      |      |      |  |                   |
| 0100 | 0064 | 0065 | 0066 | 0067 | 0068 | 0069 | 0070 | 0071 |  |                   |
| 0110 | 0072 | 0073 | 0074 | 0075 | 0076 | 0077 | 0078 | 0079 |  |                   |
| 0120 | 0080 | 0081 | 0082 | 0083 | 0084 | 0085 | 0086 | 0087 |  |                   |
| 0130 | 0088 | 0089 | 0090 | 0091 | 0092 | 0093 | 0094 | 0095 |  |                   |
| 0140 | 0096 | 0097 | 0098 | 0099 | 0100 | 0101 | 0102 | 0103 |  |                   |
| 0150 | 0104 | 0105 | 0106 | 0107 | 0108 | 0109 | 0110 | 0111 |  |                   |
| 0160 | 0112 | 0113 | 0114 | 0115 | 0116 | 0117 | 0118 | 0119 |  |                   |
| 0170 | 0120 | 0121 | 0122 | 0123 | 0124 | 0125 | 0126 | 0127 |  |                   |
|      |      |      |      |      |      |      |      |      |  |                   |
| 0200 | 0128 | 0129 | 0130 | 0131 | 0132 | 0133 | 0134 | 0135 |  |                   |
| 0210 | 0136 | 0137 | 0138 | 0139 | 0140 | 0141 | 0142 | 0143 |  |                   |
| 0220 | 0144 | 0145 | 0146 | 0147 | 0148 | 0149 | 0150 | 0151 |  |                   |
| 0230 | 0152 | 0153 | 0154 | 0155 | 0156 | 0157 | 0158 | 0159 |  |                   |
| 0240 | 0160 | 0161 | 0162 | 0163 | 0164 | 0165 | 0166 | 0167 |  |                   |
| 0250 | 0168 | 0169 | 0170 | 0171 | 0172 | 0173 | 0174 | 0175 |  |                   |
| 0260 | 0176 | 0177 | 0178 | 0179 | 0180 | 0181 | 0182 | 0183 |  |                   |
| 0270 | 0184 | 0185 | 0186 | 0187 | 0188 | 0189 | 0190 | 0191 |  |                   |
|      |      |      |      |      |      |      |      |      |  |                   |
| 0300 | 0192 | 0193 | 0194 | 0195 | 0196 | 0197 | 0198 | 0199 |  |                   |
| 0310 | 0200 | 0201 | 0202 | 0203 | 0204 | 0205 | 0206 | 0207 |  |                   |
| 0320 | 0208 | 0209 | 0210 | 0211 | 0212 | 0213 | 0214 | 0215 |  |                   |
| 0330 | 0216 | 0217 | 0218 | 0219 | 0220 | 0221 | 0222 | 0223 |  |                   |
| 0340 | 0224 | 0225 | 0226 | 0227 | 0228 | 0229 | 0230 | 0231 |  |                   |
| 0350 | 0232 | 0233 | 0234 | 0235 | 0236 | 0237 | 0238 | 0239 |  |                   |
| 0360 | 0240 | 0241 | 0242 | 0243 | 0244 | 0245 | 0246 | 0247 |  |                   |
| 0370 | 0248 | 0249 | 0250 | 0251 | 0252 | 0253 | 0254 | 0255 |  |                   |
|      |      |      |      |      |      |      |      |      |  |                   |
| 0400 | 0256 | 0257 | 0258 | 0259 | 0260 | 0261 | 0262 | 0263 |  | 0000 0000         |
| 0410 | 0264 | 0265 | 0266 | 0267 | 0268 | 0269 | 0270 | 0271 |  | to to             |
| 0420 | 0272 | 0273 | 0274 | 0275 | 0276 | 0277 | 0278 | 0279 |  | 0777 0511         |
| 0430 | 0280 | 0281 | 0282 | 0283 | 0284 | 0285 | 0286 | 0287 |  | (Octal) (Decimal) |
| 0440 | 0288 | 0289 | 0290 | 0291 | 0292 | 0293 | 0294 | 0295 |  |                   |
| 0450 | 0296 | 0297 | 0298 | 0299 | 0300 | 0301 | 0302 | 0303 |  |                   |
| 0460 | 0304 | 0305 | 0306 | 0307 | 0308 | 0309 | 0310 | 0311 |  |                   |
| 0470 | 0312 | 0313 | 0314 | 0315 | 0316 | 0317 | 0318 | 0319 |  |                   |
|      |      |      |      |      |      |      |      |      |  |                   |
| 0500 | 0320 | 0321 | 0322 | 0323 | 0324 | 0325 | 0326 | 0327 |  |                   |
| 0510 | 0328 | 0329 | 0330 | 0331 | 0332 | 0333 | 0334 | 0335 |  |                   |
| 0520 | 0336 | 0337 | 0338 | 0339 | 0340 | 0341 | 0342 | 0343 |  |                   |
| 0530 | 0344 | 0345 | 0346 | 0347 | 0348 | 0349 | 0350 | 0351 |  |                   |
| 0540 | 0352 | 0353 | 0354 | 0355 | 0356 | 0357 | 0358 | 0359 |  |                   |
| 0550 | 0360 | 0361 | 0362 | 0363 | 0364 | 0365 | 0366 | 0367 |  |                   |
| 0560 | 0368 | 0369 | 0370 | 0371 | 0372 | 0373 | 0374 | 0375 |  |                   |
| 0570 | 0376 | 0377 | 0378 | 0379 | 0380 | 0381 | 0382 | 0383 |  |                   |
|      |      |      |      |      |      |      |      |      |  |                   |
| 0600 | 0384 | 0385 | 0386 | 0387 | 0388 | 0389 | 0390 | 0391 |  |                   |
| 0610 | 0392 | 0393 | 0394 | 0395 | 0396 | 0397 | 0398 | 0399 |  |                   |
| 0620 | 0400 | 0401 | 0402 | 0403 | 0404 | 0405 | 0406 | 0407 |  |                   |
| 0630 | 0408 | 0409 | 0410 | 0411 | 0412 | 0413 | 0414 | 0415 |  |                   |
| 0640 | 0416 | 0417 | 0418 | 0419 | 0420 | 0421 | 0422 | 0423 |  |                   |
| 0650 | 0424 | 0425 | 0426 | 0427 | 0428 | 0429 | 0430 | 0431 |  |                   |
| 0660 | 0432 | 0433 | 0434 | 0435 | 0436 | 0437 | 0438 | 0439 |  |                   |
| 0670 | 0440 | 0441 | 0442 | 0443 | 0444 | 0445 | 0446 | 0447 |  |                   |
|      |      |      |      |      |      |      |      |      |  |                   |
| 0700 | 0448 | 0449 | 0450 | 0451 | 0452 | 0453 | 0454 | 0455 |  |                   |
| 0710 | 0456 | 0457 | 0458 | 0459 | 0460 | 0461 | 0462 | 0463 |  |                   |
| 0720 | 0464 | 0465 | 0466 | 0467 | 0468 | 0469 | 0470 | 0471 |  |                   |
| 0730 | 0472 | 0473 | 0474 | 0475 | 0476 | 0477 | 0478 | 0479 |  |                   |
| 0740 | 0480 | 0481 | 0482 | 0483 | 0484 | 0485 | 0486 | 0487 |  |                   |
| 0750 | 0488 | 0489 | 0490 | 0491 | 0492 | 0493 | 0494 | 0495 |  |                   |
| 0760 | 0496 | 0497 | 0498 | 0499 | 0500 | 0501 | 0502 | 0503 |  |                   |
| 0770 | 0504 | 0505 | 0506 | 0507 | 0508 | 0509 | 0510 | 0511 |  |                   |
|      |      |      |      |      |      |      |      |      |  |                   |
| 1000 | 0512 | 0513 | 0514 | 0515 | 0516 | 0517 | 0518 | 0519 |  | 1000 0512         |
| 1010 | 0520 | 0521 | 0522 | 0523 | 0524 | 0525 | 0526 | 0527 |  | to to             |
| 1020 | 0528 | 0529 | 0530 | 0531 | 0532 | 0533 | 0534 | 0535 |  | 1777 1023         |
| 1030 | 0536 | 0537 | 0538 | 0539 | 0540 | 0541 | 0542 | 0543 |  | (Octal) (Decimal) |
| 1040 | 0544 | 0545 | 0546 | 0547 | 0548 | 0549 | 0550 | 0551 |  |                   |
| 1050 | 0552 | 0553 | 0554 | 0555 | 0556 | 0557 | 0558 | 0559 |  |                   |
| 1060 | 0560 | 0561 | 0562 | 0563 | 0564 | 0565 | 0566 | 0567 |  |                   |
| 1070 | 0568 | 0569 | 0570 | 0571 | 0572 | 0573 | 0574 | 0575 |  |                   |
|      |      |      |      |      |      |      |      |      |  |                   |
| 1100 | 0576 | 0577 | 0578 | 0579 | 0580 | 0581 | 0582 | 0583 |  |                   |
| 1110 | 0584 | 0585 | 0586 | 0587 | 0588 | 0589 | 0590 | 0591 |  |                   |
| 1120 | 0592 | 0593 | 0594 | 0595 | 0596 | 0597 | 0598 | 0599 |  |                   |
| 1130 | 0600 | 0601 | 0602 | 0603 | 0604 | 0605 | 0606 | 0607 |  |                   |
| 1140 | 0608 | 0609 | 0610 | 0611 | 0612 | 0613 | 0614 | 0615 |  |                   |
| 1150 | 0616 | 0617 | 0618 | 0619 | 0620 | 0621 | 0622 | 0623 |  |                   |
| 1160 | 0624 | 0625 | 0626 | 0627 | 0628 | 0629 | 0630 | 0631 |  |                   |
| 1170 | 0632 | 0633 | 0634 | 0635 | 0636 | 0637 | 0638 | 0639 |  |                   |
|      |      |      |      |      |      |      |      |      |  |                   |
| 1200 | 0640 | 0641 | 0642 | 0643 | 0644 | 0645 | 0646 | 0647 |  |                   |
| 1210 | 0648 | 0649 | 0650 | 0651 | 0652 | 0653 | 0654 | 0655 |  |                   |
| 1220 | 0656 | 0657 | 0658 | 0659 | 0660 | 0661 | 0662 | 0663 |  |                   |
| 1230 | 0664 | 0665 | 0666 | 0667 | 0668 | 0669 | 0670 | 0671 |  |                   |
| 1240 | 0672 | 0673 | 0674 | 0675 | 0676 | 0677 | 0678 | 0679 |  |                   |
| 1250 | 0680 | 0681 | 0682 | 0683 | 0684 | 0685 | 0686 | 0687 |  |                   |
| 1260 | 0688 | 0689 | 0690 | 0691 | 0692 | 0693 | 0694 | 0695 |  |                   |
| 1270 | 0696 | 0697 | 0698 | 0699 | 0700 | 0701 | 0702 | 0703 |  |                   |
|      |      |      |      |      |      |      |      |      |  |                   |
| 1300 | 0704 | 0705 | 0706 | 0707 | 0708 | 0709 | 0710 | 0711 |  |                   |
| 1310 | 0712 | 0713 | 0714 | 0715 | 0716 | 0717 | 0718 | 0719 |  |                   |
| 1320 | 0720 | 0721 | 0722 | 0723 | 0724 | 0725 | 0726 | 0727 |  |                   |
| 1330 | 0728 | 0729 | 0730 | 0731 | 0732 | 0733 | 0734 | 0735 |  |                   |
| 1340 | 0736 | 0737 | 0738 | 0739 | 0740 | 0741 | 0742 | 0743 |  |                   |
| 1350 | 0744 | 0745 | 0746 | 0747 | 0748 | 0749 | 0750 | 0751 |  |                   |
| 1360 | 0752 | 0753 | 0754 | 0755 | 0756 | 0757 | 0758 | 0759 |  |                   |
| 1370 | 0760 | 0761 | 0762 | 0763 | 0764 | 0765 | 0766 | 0767 |  |                   |
|      |      |      |      |      |      |      |      |      |  |                   |
| 1400 | 0768 | 0769 | 0770 | 0771 | 0772 | 0773 | 0774 | 0775 |  |                   |
| 1410 | 0776 | 0777 | 0778 | 0779 | 0780 | 0781 | 0782 | 0783 |  |                   |
| 1420 | 0784 | 0785 | 0786 | 0787 | 0788 | 0789 | 0790 | 0791 |  |                   |
| 1430 | 0792 | 0793 | 0794 | 0795 | 0796 | 0797 | 0798 | 0799 |  |                   |
| 1440 | 0800 | 0801 | 0802 | 0803 | 0804 | 0805 | 0806 | 0807 |  |                   |
| 1450 | 0808 | 0809 | 0810 | 0811 | 0812 | 0813 | 0814 | 0815 |  |                   |
| 1460 | 0816 | 0817 | 0818 | 0819 | 0820 | 0821 | 0822 | 0823 |  |                   |
| 1470 | 0824 | 0825 | 0826 | 0827 | 0828 | 0829 | 0830 | 0831 |  |                   |
|      |      |      |      |      |      |      |      |      |  |                   |
| 1500 | 0832 | 0833 | 0834 | 0835 | 0836 | 0837 | 0838 | 0839 |  |                   |
| 1510 | 0840 | 0841 | 0842 | 0843 | 0844 | 0845 | 0846 | 0847 |  |                   |
| 1520 | 0848 | 0849 | 0850 | 0851 | 0852 | 0853 | 0854 | 0855 |  |                   |
| 1530 | 0856 | 0857 | 0858 | 0859 | 0860 | 0861 | 0862 | 0863 |  |                   |
| 1540 | 0864 | 0865 | 0866 | 0867 | 0868 | 0869 | 0870 | 0871 |  |                   |
| 1550 | 0872 | 0873 | 0874 | 0875 | 0876 | 0877 | 0878 | 0879 |  |                   |
| 1560 | 0880 | 0881 | 0882 | 0883 | 0884 | 0885 | 0886 | 0887 |  |                   |
| 1570 | 0888 | 0889 | 0890 | 0891 | 0892 | 0893 | 0894 | 0895 |  |                   |
|      |      |      |      |      |      |      |      |      |  |                   |
| 1600 | 0896 | 0897 | 0898 | 0899 | 0900 | 0901 | 0902 | 0903 |  |                   |
| 1610 | 0904 | 0905 | 0906 | 0907 | 0908 | 0909 | 0910 | 0911 |  |                   |
| 1620 | 0912 | 0913 | 0914 | 0915 | 0916 | 0917 | 0918 | 0919 |  |                   |
| 1630 | 0920 | 0921 | 0922 | 0923 | 0924 | 0925 | 0926 | 0927 |  |                   |
| 1640 | 0928 | 0929 | 0930 | 0931 | 0932 | 0933 | 0934 | 0935 |  |                   |
| 1650 | 0936 | 0937 | 0938 | 0939 | 0940 | 0941 | 0942 | 0943 |  |                   |
| 1660 | 0944 | 0945 | 0946 | 0947 | 0948 | 0949 | 0950 | 0951 |  |                   |
| 1670 | 0952 | 0953 | 0954 | 0955 | 0956 | 0957 | 0958 | 0959 |  |                   |
|      |      |      |      |      |      |      |      |      |  |                   |
| 1700 | 0960 | 0961 | 0962 | 0963 | 0964 | 0965 | 0966 | 0967 |  |                   |
| 1710 | 0968 | 0969 | 0970 | 0971 | 0972 | 0973 | 0974 | 0975 |  |                   |
| 1720 | 0976 | 0977 | 0978 | 0979 | 0980 | 0981 | 0982 | 0983 |  |                   |
| 1730 | 0984 | 0985 | 0986 | 0987 | 0988 | 0989 | 0990 | 0991 |  |                   |
| 1740 | 0992 | 0993 | 0994 | 0995 | 0996 | 0997 | 0998 | 0999 |  |                   |
| 1750 | 1000 | 1001 | 1002 | 1003 | 1004 | 1005 | 1006 | 1007 |  |                   |
| 1760 | 1008 | 1009 |      |      |      |      |      |      |  |                   |

TABLE 1A-2. OCTAL-DECIMAL CONVERSION TABLE (SHEET 2 OF 4)

|         |           | 0    | 1    | 2    | 3    | 4    | 5    | 6    | 7    |      |      | 0    | 1    | 2    | 3    | 4    | 5    | 6    | 7    |
|---------|-----------|------|------|------|------|------|------|------|------|------|------|------|------|------|------|------|------|------|------|
| 2000    | 1024      | 2000 | 1024 | 1025 | 1026 | 1027 | 1028 | 1029 | 1030 | 1031 | 2400 | 1280 | 1281 | 1282 | 1283 | 1284 | 1285 | 1286 | 1287 |
| to      |           | 2010 | 1032 | 1033 | 1034 | 1035 | 1036 | 1037 | 1038 | 1039 | 2410 | 1288 | 1289 | 1290 | 1291 | 1292 | 1293 | 1294 | 1295 |
| 2777    | 1535      | 2020 | 1040 | 1041 | 1042 | 1043 | 1044 | 1045 | 1046 | 1047 | 2420 | 1296 | 1297 | 1298 | 1299 | 1300 | 1301 | 1302 | 1303 |
| (Octal) | (Decimal) | 2030 | 1048 | 1049 | 1050 | 1051 | 1052 | 1053 | 1054 | 1055 | 2430 | 1304 | 1305 | 1306 | 1307 | 1308 | 1309 | 1310 | 1311 |
|         |           | 2040 | 1056 | 1057 | 1058 | 1059 | 1060 | 1061 | 1062 | 1063 | 2440 | 1312 | 1313 | 1314 | 1315 | 1316 | 1317 | 1318 | 1319 |
| Octal   | Decimal   | 2050 | 1064 | 1065 | 1066 | 1067 | 1068 | 1069 | 1070 | 1071 | 2450 | 1320 | 1321 | 1322 | 1323 | 1324 | 1325 | 1326 | 1327 |
| 10000   | 4096      | 2060 | 1072 | 1073 | 1074 | 1075 | 1076 | 1077 | 1078 | 1079 | 2460 | 1328 | 1329 | 1330 | 1331 | 1332 | 1333 | 1334 | 1335 |
| 20000   | 8192      | 2070 | 1080 | 1081 | 1082 | 1083 | 1084 | 1085 | 1086 | 1087 | 2470 | 1336 | 1337 | 1338 | 1339 | 1340 | 1341 | 1342 | 1343 |
| 30000   | 12288     | 2100 | 1088 | 1089 | 1090 | 1091 | 1092 | 1093 | 1094 | 1095 | 2500 | 1344 | 1345 | 1346 | 1347 | 1348 | 1349 | 1350 | 1351 |
| 40000   | 16384     | 2100 | 1096 | 1097 | 1098 | 1099 | 1100 | 1101 | 1102 | 1103 | 2510 | 1352 | 1353 | 1354 | 1355 | 1356 | 1357 | 1358 | 1359 |
| 50000   | 20480     | 2120 | 1104 | 1105 | 1106 | 1107 | 1108 | 1109 | 1110 | 1111 | 2520 | 1360 | 1361 | 1362 | 1363 | 1364 | 1365 | 1366 | 1367 |
| 60000   | 24576     | 2130 | 1112 | 1113 | 1114 | 1115 | 1116 | 1117 | 1118 | 1119 | 2530 | 1368 | 1369 | 1370 | 1371 | 1372 | 1373 | 1374 | 1375 |
| 70000   | 28672     | 2140 | 1120 | 1121 | 1122 | 1123 | 1124 | 1125 | 1126 | 1127 | 2540 | 1376 | 1377 | 1378 | 1379 | 1380 | 1381 | 1382 | 1383 |
|         |           | 2150 | 1128 | 1129 | 1130 | 1131 | 1132 | 1133 | 1134 | 1135 | 2550 | 1384 | 1385 | 1386 | 1387 | 1388 | 1389 | 1390 | 1391 |
|         |           | 2160 | 1136 | 1137 | 1138 | 1139 | 1140 | 1141 | 1142 | 1143 | 2560 | 1392 | 1393 | 1394 | 1395 | 1396 | 1397 | 1398 | 1399 |
|         |           | 2170 | 1144 | 1145 | 1146 | 1147 | 1148 | 1149 | 1150 | 1151 | 2570 | 1400 | 1401 | 1402 | 1403 | 1404 | 1405 | 1406 | 1407 |
|         |           | 2200 | 1152 | 1153 | 1154 | 1155 | 1156 | 1157 | 1158 | 1159 | 2600 | 1408 | 1409 | 1410 | 1411 | 1412 | 1413 | 1414 | 1415 |
|         |           | 2210 | 1160 | 1161 | 1162 | 1163 | 1164 | 1165 | 1166 | 1167 | 2610 | 1416 | 1417 | 1418 | 1419 | 1420 | 1421 | 1422 | 1423 |
|         |           | 2220 | 1168 | 1169 | 1170 | 1171 | 1172 | 1173 | 1174 | 1175 | 2620 | 1424 | 1425 | 1426 | 1427 | 1428 | 1429 | 1430 | 1431 |
|         |           | 2230 | 1176 | 1177 | 1178 | 1179 | 1180 | 1181 | 1182 | 1183 | 2630 | 1432 | 1433 | 1434 | 1435 | 1436 | 1437 | 1438 | 1439 |
|         |           | 2240 | 1184 | 1185 | 1186 | 1187 | 1188 | 1189 | 1190 | 1191 | 2640 | 1440 | 1441 | 1442 | 1443 | 1444 | 1445 | 1446 | 1447 |
|         |           | 2250 | 1192 | 1193 | 1194 | 1195 | 1196 | 1197 | 1198 | 1199 | 2650 | 1448 | 1449 | 1450 | 1451 | 1452 | 1453 | 1454 | 1455 |
|         |           | 2260 | 1200 | 1201 | 1202 | 1203 | 1204 | 1205 | 1206 | 1207 | 2660 | 1456 | 1457 | 1458 | 1459 | 1460 | 1461 | 1462 | 1463 |
|         |           | 2270 | 1208 | 1209 | 1210 | 1211 | 1212 | 1213 | 1214 | 1215 | 2670 | 1464 | 1465 | 1466 | 1467 | 1468 | 1469 | 1470 | 1471 |
|         |           | 2300 | 1216 | 1217 | 1218 | 1219 | 1220 | 1221 | 1222 | 1223 | 2700 | 1472 | 1473 | 1474 | 1475 | 1476 | 1477 | 1478 | 1479 |
|         |           | 2310 | 1224 | 1225 | 1226 | 1227 | 1228 | 1229 | 1230 | 1231 | 2710 | 1480 | 1481 | 1482 | 1483 | 1484 | 1485 | 1486 | 1487 |
|         |           | 2320 | 1232 | 1233 | 1234 | 1235 | 1236 | 1237 | 1238 | 1239 | 2720 | 1488 | 1489 | 1490 | 1491 | 1492 | 1493 | 1494 | 1495 |
|         |           | 2330 | 1240 | 1241 | 1242 | 1243 | 1244 | 1245 | 1246 | 1247 | 2730 | 1496 | 1497 | 1498 | 1499 | 1500 | 1501 | 1502 | 1503 |
|         |           | 2340 | 1248 | 1249 | 1250 | 1251 | 1252 | 1253 | 1254 | 1255 | 2740 | 1504 | 1505 | 1506 | 1507 | 1508 | 1519 | 1510 | 1511 |
|         |           | 2350 | 1256 | 1257 | 1258 | 1259 | 1260 | 1261 | 1262 | 1263 | 2750 | 1512 | 1513 | 1514 | 1515 | 1516 | 1517 | 1518 | 1519 |
|         |           | 2360 | 1264 | 1265 | 1266 | 1267 | 1268 | 1269 | 1270 | 1271 | 2760 | 1520 | 1521 | 1522 | 1523 | 1524 | 1525 | 1526 | 1527 |
|         |           | 2370 | 1272 | 1273 | 1274 | 1275 | 1276 | 1277 | 1278 | 1279 | 2770 | 1528 | 1529 | 1530 | 1531 | 1532 | 1533 | 1534 | 1535 |
| 3000    | 1536      | 3000 | 1536 | 1537 | 1538 | 1539 | 1540 | 1541 | 1542 | 1543 | 3400 | 1792 | 1793 | 1794 | 1795 | 1796 | 1797 | 1798 | 1799 |
| to      |           | 3010 | 1544 | 1545 | 1546 | 1547 | 1548 | 1549 | 1550 | 1551 | 3410 | 1800 | 1801 | 1802 | 1803 | 1804 | 1805 | 1806 | 1807 |
| 3777    | 2047      | 3020 | 1552 | 1553 | 1554 | 1555 | 1556 | 1557 | 1558 | 1559 | 3420 | 1808 | 1809 | 1810 | 1811 | 1812 | 1813 | 1814 | 1815 |
| (Octal) | (Decimal) | 3030 | 1560 | 1561 | 1562 | 1563 | 1564 | 1565 | 1566 | 1567 | 3430 | 1816 | 1817 | 1818 | 1819 | 1820 | 1821 | 1822 | 1823 |
|         |           | 3040 | 1568 | 1569 | 1570 | 1571 | 1572 | 1573 | 1574 | 1575 | 3440 | 1824 | 1825 | 1826 | 1827 | 1828 | 1829 | 1830 | 1831 |
|         |           | 3050 | 1576 | 1577 | 1578 | 1579 | 1580 | 1581 | 1582 | 1583 | 3450 | 1832 | 1833 | 1834 | 1835 | 1836 | 1837 | 1838 | 1839 |
|         |           | 3060 | 1584 | 1585 | 1586 | 1587 | 1588 | 1589 | 1590 | 1591 | 3460 | 1840 | 1841 | 1842 | 1843 | 1844 | 1845 | 1846 | 1847 |
|         |           | 3070 | 1592 | 1593 | 1594 | 1595 | 1596 | 1597 | 1598 | 1599 | 3470 | 1848 | 1849 | 1850 | 1851 | 1852 | 1853 | 1854 | 1855 |
|         |           | 3100 | 1600 | 1601 | 1602 | 1603 | 1604 | 1605 | 1606 | 1607 | 3500 | 1856 | 1857 | 1858 | 1859 | 1860 | 1861 | 1862 | 1863 |
|         |           | 3110 | 1608 | 1609 | 1610 | 1611 | 1612 | 1613 | 1614 | 1615 | 3510 | 1864 | 1865 | 1866 | 1867 | 1868 | 1869 | 1870 | 1871 |
|         |           | 3120 | 1616 | 1617 | 1618 | 1619 | 1620 | 1621 | 1622 | 1623 | 3520 | 1872 | 1873 | 1874 | 1875 | 1876 | 1877 | 1878 | 1879 |
|         |           | 3130 | 1624 | 1625 | 1626 | 1627 | 1628 | 1629 | 1630 | 1631 | 3530 | 1880 | 1881 | 1882 | 1883 | 1884 | 1885 | 1886 | 1887 |
|         |           | 3140 | 1632 | 1633 | 1634 | 1635 | 1636 | 1637 | 1638 | 1639 | 3540 | 1888 | 1889 | 1890 | 1891 | 1892 | 1893 | 1894 | 1895 |
|         |           | 3150 | 1640 | 1641 | 1642 | 1643 | 1644 | 1645 | 1646 | 1647 | 3550 | 1896 | 1897 | 1898 | 1899 | 1900 | 1901 | 1902 | 1903 |
|         |           | 3160 | 1648 | 1649 | 1650 | 1651 | 1652 | 1653 | 1654 | 1655 | 3560 | 1904 | 1905 | 1906 | 1907 | 1908 | 1909 | 1910 | 1911 |
|         |           | 3170 | 1656 | 1657 | 1658 | 1659 | 1660 | 1661 | 1662 | 1663 | 3570 | 1912 | 1913 | 1914 | 1915 | 1916 | 1917 | 1918 | 1919 |
|         |           | 3200 | 1664 | 1665 | 1666 | 1667 | 1668 | 1669 | 1670 | 1671 | 3600 | 1920 | 1921 | 1922 | 1923 | 1924 | 1925 | 1926 | 1927 |
|         |           | 3210 | 1672 | 1673 | 1674 | 1675 | 1676 | 1677 | 1678 | 1679 | 3610 | 1928 | 1929 | 1930 | 1931 | 1932 | 1933 | 1934 | 1935 |
|         |           | 3220 | 1680 | 1681 | 1682 | 1683 | 1684 | 1685 | 1686 | 1687 | 3620 | 1936 | 1937 | 1938 | 1939 | 1940 | 1941 | 1942 | 1943 |
|         |           | 3230 | 1688 | 1689 | 1690 | 1691 | 1692 | 1693 | 1694 | 1695 | 3630 | 1944 | 1945 | 1946 | 1947 | 1948 | 1949 | 1950 | 1951 |
|         |           | 3240 | 1696 | 1697 | 1698 | 1699 | 1700 | 1701 | 1702 | 1703 | 3640 | 1952 | 1953 | 1954 | 1955 | 1956 | 1957 | 1958 | 1959 |
|         |           | 3250 | 1704 | 1705 | 1706 | 1707 | 1708 | 1709 | 1710 | 1711 | 3650 | 1960 | 1961 | 1962 | 1963 | 1964 | 1965 | 1966 | 1967 |
|         |           | 3260 | 1712 | 1713 | 1714 | 1715 | 1716 | 1717 | 1718 | 1719 | 3660 | 1968 | 1969 | 1970 | 1971 | 1972 | 1973 | 1974 | 1975 |
|         |           | 3270 | 1720 | 1721 | 1722 | 1723 | 1724 | 1725 | 1726 | 1727 | 3670 | 1976 | 1977 | 1978 | 1979 | 1980 | 1981 | 1982 | 1983 |
|         |           | 3300 | 1728 | 1729 | 1730 | 1731 | 1732 | 1733 | 1734 | 1735 | 3700 | 1984 | 1985 | 1986 | 1987 | 1988 | 1989 | 1990 | 1991 |
|         |           | 3310 | 1736 | 1737 | 1738 | 1739 | 1740 | 1741 | 1742 | 1743 | 3710 | 1992 | 1993 | 1994 | 1995 | 1996 | 1997 | 1998 | 1999 |
|         |           | 3320 | 1744 | 1745 | 1746 | 1747 | 1748 | 1749 | 1750 | 1751 | 3720 | 2000 | 2001 | 2002 | 2003 | 2004 | 2005 | 2006 | 2007 |
|         |           | 3330 | 1752 | 1753 | 1754 | 1755 | 1756 | 1757 | 1758 | 1759 | 3730 | 2008 | 2009 | 2010 | 2011 | 2012 | 2013 | 2014 | 2015 |
|         |           | 3340 | 1760 | 1761 | 1762 | 1763 | 1764 | 1765 | 1766 | 1767 | 3740 | 2016 | 2017 | 2018 | 2019 | 2020 | 2021 | 2022 | 2023 |
|         |           | 3350 | 1768 | 1769 | 1770 | 1771 | 1772 | 1773 | 1774 | 1775 | 3750 | 2024 | 2025 | 2026 | 2027 | 2028 | 2029 | 2030 | 2031 |
|         |           | 3360 | 1776 | 1777 | 1778 | 1779 | 1780 | 1781 | 1782 | 1783 | 3760 | 2032 | 2033 | 2034 | 2035 | 2036 | 2037 | 2038 | 2039 |
|         |           | 3370 | 1784 | 1785 | 1786 | 1787 | 1788 | 1789 | 1790 | 1791 | 3770 | 2040 | 2041 | 2042 | 2043 | 2044 | 2045 | 2046 | 2047 |

TABLE 1A-2. OCTAL-DECIMAL CONVERSION TABLE (SHEET 3 OF 4)

|      | 0    | 1    | 2    | 3    | 4    | 5    | 6    | 7    |      | 0    | 1    | 2    | 3    | 4    | 5    | 6    | 7    |      | 0    | 1 | 2 | 3 | 4 | 5 | 6 | 7 |  | 0 | 1 | 2 | 3 | 4 | 5 | 6 | 7 |  |  |  |  |  |  |
|------|------|------|------|------|------|------|------|------|------|------|------|------|------|------|------|------|------|------|------|---|---|---|---|---|---|---|--|---|---|---|---|---|---|---|---|--|--|--|--|--|--|
| 4000 | 2048 | 2049 | 2050 | 2051 | 2052 | 2053 | 2054 | 2055 | 4400 | 2304 | 2305 | 2306 | 2307 | 2308 | 2309 | 2310 | 2311 | 4000 | 2048 |   |   |   |   |   |   |   |  |   |   |   |   |   |   |   |   |  |  |  |  |  |  |
| 4010 | 2056 | 2057 | 2058 | 2059 | 2060 | 2061 | 2062 | 2063 | 4410 | 2312 | 2313 | 2314 | 2315 | 2316 | 2317 | 2318 | 2319 | 4010 | 2056 |   |   |   |   |   |   |   |  |   |   |   |   |   |   |   |   |  |  |  |  |  |  |
| 4020 | 2064 | 2065 | 2066 | 2067 | 2068 | 2069 | 2070 | 2071 | 4420 | 2320 | 2321 | 2322 | 2323 | 2324 | 2325 | 2326 | 2327 | 4020 | 2064 |   |   |   |   |   |   |   |  |   |   |   |   |   |   |   |   |  |  |  |  |  |  |
| 4030 | 2072 | 2073 | 2074 | 2075 | 2076 | 2077 | 2078 | 2079 | 4430 | 2328 | 2329 | 2330 | 2331 | 2332 | 2333 | 2334 | 2335 | 4030 | 2072 |   |   |   |   |   |   |   |  |   |   |   |   |   |   |   |   |  |  |  |  |  |  |
| 4040 | 2080 | 2081 | 2082 | 2083 | 2084 | 2085 | 2086 | 2087 | 4440 | 2336 | 2337 | 2338 | 2339 | 2340 | 2341 | 2342 | 2343 | 4040 | 2080 |   |   |   |   |   |   |   |  |   |   |   |   |   |   |   |   |  |  |  |  |  |  |
| 4050 | 2088 | 2089 | 2090 | 2091 | 2092 | 2093 | 2094 | 2095 | 4450 | 2344 | 2345 | 2346 | 2347 | 2348 | 2349 | 2350 |      | 4050 | 2088 |   |   |   |   |   |   |   |  |   |   |   |   |   |   |   |   |  |  |  |  |  |  |
| 4060 | 2096 | 2097 | 2098 | 2099 | 2100 | 2101 | 2102 | 2103 | 4460 | 2352 | 2353 | 2354 | 2355 | 2356 | 2357 | 2358 |      | 4060 | 2096 |   |   |   |   |   |   |   |  |   |   |   |   |   |   |   |   |  |  |  |  |  |  |
| 4070 | 2104 | 2105 | 2106 | 2107 | 2108 | 2109 | 2110 | 2111 | 4470 | 2360 | 2361 | 2362 | 2363 | 2364 | 2365 | 2366 |      | 4070 | 2104 |   |   |   |   |   |   |   |  |   |   |   |   |   |   |   |   |  |  |  |  |  |  |
| 4100 | 2112 | 2113 | 2114 | 2115 | 2116 | 2117 | 2118 | 2119 | 4500 | 2368 | 2369 | 2370 | 2371 | 2372 | 2373 | 2374 |      | 4100 | 2112 |   |   |   |   |   |   |   |  |   |   |   |   |   |   |   |   |  |  |  |  |  |  |
| 4110 | 2120 | 2121 | 2122 | 2123 | 2124 | 2125 | 2126 | 2127 | 4510 | 2376 | 2377 | 2378 | 2379 | 2380 | 2381 | 2382 |      | 4110 | 2120 |   |   |   |   |   |   |   |  |   |   |   |   |   |   |   |   |  |  |  |  |  |  |
| 4120 | 2128 | 2129 | 2130 | 2131 | 2132 | 2133 | 2134 | 2135 | 4520 | 2384 | 2385 | 2386 | 2387 | 2388 | 2389 | 2390 |      | 4120 | 2128 |   |   |   |   |   |   |   |  |   |   |   |   |   |   |   |   |  |  |  |  |  |  |
| 4130 | 2136 | 2137 | 2138 | 2139 | 2140 | 2141 | 2142 | 2143 | 4530 | 2392 | 2393 | 2394 | 2395 | 2396 | 2397 | 2398 |      | 4130 | 2136 |   |   |   |   |   |   |   |  |   |   |   |   |   |   |   |   |  |  |  |  |  |  |
| 4140 | 2144 | 2145 | 2146 | 2147 | 2148 | 2149 | 2150 | 2151 | 4540 | 2400 | 2401 | 2402 | 2403 | 2404 | 2405 | 2406 |      | 4140 | 2144 |   |   |   |   |   |   |   |  |   |   |   |   |   |   |   |   |  |  |  |  |  |  |
| 4150 | 2152 | 2153 | 2154 | 2155 | 2156 | 2157 | 2158 | 2159 | 4550 | 2408 | 2409 | 2410 | 2411 | 2412 | 2413 | 2414 |      | 4150 | 2152 |   |   |   |   |   |   |   |  |   |   |   |   |   |   |   |   |  |  |  |  |  |  |
| 4160 | 2160 | 2161 | 2162 | 2163 | 2164 | 2165 | 2166 | 2167 | 4560 | 2416 | 2417 | 2418 | 2419 | 2420 | 2421 | 2422 |      | 4160 | 2160 |   |   |   |   |   |   |   |  |   |   |   |   |   |   |   |   |  |  |  |  |  |  |
| 4170 | 2168 | 2169 | 2170 | 2171 | 2172 | 2173 | 2174 | 2175 | 4570 | 2424 | 2425 | 2426 | 2427 | 2428 | 2429 | 2430 |      | 4170 | 2168 |   |   |   |   |   |   |   |  |   |   |   |   |   |   |   |   |  |  |  |  |  |  |
| 4200 | 2176 | 2177 | 2178 | 2179 | 2180 | 2181 | 2182 | 2183 | 4600 | 2432 | 2433 | 2434 | 2435 | 2436 | 2437 | 2438 |      | 4200 | 2176 |   |   |   |   |   |   |   |  |   |   |   |   |   |   |   |   |  |  |  |  |  |  |
| 4210 | 2184 | 2185 | 2186 | 2187 | 2188 | 2189 | 2190 | 2191 | 4610 | 2440 | 2441 | 2442 | 2443 | 2444 | 2445 | 2446 |      | 4210 | 2184 |   |   |   |   |   |   |   |  |   |   |   |   |   |   |   |   |  |  |  |  |  |  |
| 4220 | 2192 | 2193 | 2194 | 2195 | 2196 | 2197 | 2198 | 2199 | 4620 | 2448 | 2449 | 2450 | 2451 | 2452 | 2453 | 2454 |      | 4220 | 2192 |   |   |   |   |   |   |   |  |   |   |   |   |   |   |   |   |  |  |  |  |  |  |
| 4230 | 2200 | 2201 | 2202 | 2203 | 2204 | 2205 | 2206 | 2207 | 4630 | 2456 | 2457 | 2458 | 2459 | 2460 | 2461 | 2462 |      | 4230 | 2200 |   |   |   |   |   |   |   |  |   |   |   |   |   |   |   |   |  |  |  |  |  |  |
| 4240 | 2208 | 2209 | 2210 | 2211 | 2212 | 2213 | 2214 | 2215 | 4640 | 2464 | 2465 | 2466 | 2467 | 2468 | 2469 | 2470 |      | 4240 | 2208 |   |   |   |   |   |   |   |  |   |   |   |   |   |   |   |   |  |  |  |  |  |  |
| 4250 | 2216 | 2217 | 2218 | 2219 | 2220 | 2221 | 2222 | 2223 | 4650 | 2472 | 2473 | 2474 | 2475 | 2476 | 2477 | 2478 |      | 4250 | 2216 |   |   |   |   |   |   |   |  |   |   |   |   |   |   |   |   |  |  |  |  |  |  |
| 4260 | 2224 | 2225 | 2226 | 2227 | 2228 | 2229 | 2230 | 2231 | 4660 | 2480 | 2481 | 2482 | 2483 | 2484 | 2485 | 2486 |      | 4260 | 2224 |   |   |   |   |   |   |   |  |   |   |   |   |   |   |   |   |  |  |  |  |  |  |
| 4270 | 2232 | 2233 | 2234 | 2235 | 2236 | 2237 | 2238 | 2239 | 4670 | 2488 | 2489 | 2490 | 2491 | 2492 | 2493 | 2494 |      | 4270 | 2232 |   |   |   |   |   |   |   |  |   |   |   |   |   |   |   |   |  |  |  |  |  |  |
| 4300 | 2240 | 2241 | 2242 | 2243 | 2244 | 2245 | 2246 | 2247 | 4700 | 2496 | 2497 | 2498 | 2499 | 2500 | 2501 | 2502 |      | 4300 | 2240 |   |   |   |   |   |   |   |  |   |   |   |   |   |   |   |   |  |  |  |  |  |  |
| 4310 | 2248 | 2249 | 2250 | 2251 | 2252 | 2253 | 2254 | 2255 | 4710 | 2504 | 2505 | 2506 | 2507 | 2508 | 2509 | 2510 |      | 4310 | 2248 |   |   |   |   |   |   |   |  |   |   |   |   |   |   |   |   |  |  |  |  |  |  |
| 4320 | 2256 | 2257 | 2258 | 2259 | 2260 | 2261 | 2262 | 2263 | 4720 | 2512 | 2513 | 2514 | 2515 | 2516 | 2517 | 2518 |      | 4320 | 2256 |   |   |   |   |   |   |   |  |   |   |   |   |   |   |   |   |  |  |  |  |  |  |
| 4330 | 2264 | 2265 | 2266 | 2267 | 2268 | 2269 | 2270 | 2271 | 4730 | 2520 | 2521 | 2522 | 2523 | 2524 | 2525 | 2526 |      | 4330 | 2264 |   |   |   |   |   |   |   |  |   |   |   |   |   |   |   |   |  |  |  |  |  |  |
| 4340 | 2272 | 2273 | 2274 | 2275 | 2276 | 2277 | 2278 | 2279 | 4740 | 2528 | 2529 | 2530 | 2531 | 2532 | 2533 | 2534 |      | 4340 | 2272 |   |   |   |   |   |   |   |  |   |   |   |   |   |   |   |   |  |  |  |  |  |  |
| 4350 | 2280 | 2281 | 2282 | 2283 | 2284 | 2285 | 2286 | 2287 | 4750 | 2536 | 2537 | 2538 | 2539 | 2540 | 2541 | 2542 |      | 4350 | 2280 |   |   |   |   |   |   |   |  |   |   |   |   |   |   |   |   |  |  |  |  |  |  |
| 4360 | 2288 | 2289 | 2290 | 2291 | 2292 | 2293 | 2294 | 2295 | 4760 | 2544 | 2545 | 2546 | 2547 | 2548 | 2549 | 2550 |      | 4360 | 2288 |   |   |   |   |   |   |   |  |   |   |   |   |   |   |   |   |  |  |  |  |  |  |
| 4370 | 2296 | 2297 | 2298 | 2299 | 2300 | 2301 | 2302 | 2303 | 4770 | 2552 | 2553 | 2554 | 2555 | 2556 | 2557 | 2558 |      | 4370 | 2296 |   |   |   |   |   |   |   |  |   |   |   |   |   |   |   |   |  |  |  |  |  |  |
| 5000 | 2560 | 2561 | 2562 | 2563 | 2564 | 2565 | 2566 | 2567 | 5400 | 2816 | 2817 | 2818 | 2819 | 2820 | 2821 | 2822 |      | 5000 | 2560 |   |   |   |   |   |   |   |  |   |   |   |   |   |   |   |   |  |  |  |  |  |  |
| 5010 | 2568 | 2569 | 2570 | 2571 | 2572 | 2573 | 2574 | 2575 | 5410 | 2824 | 2825 | 2826 | 2827 | 2828 | 2829 | 2830 |      | 5010 | 2568 |   |   |   |   |   |   |   |  |   |   |   |   |   |   |   |   |  |  |  |  |  |  |
| 5020 | 2576 | 2577 | 2578 | 2579 | 2580 | 2581 | 2582 | 2583 | 5420 | 2832 | 2833 | 2834 | 2835 | 2836 | 2837 | 2838 |      | 5020 | 2576 |   |   |   |   |   |   |   |  |   |   |   |   |   |   |   |   |  |  |  |  |  |  |
| 5030 | 2584 | 2585 | 2586 | 2587 | 2588 | 2589 | 2590 | 2591 | 5430 | 2840 | 2841 | 2842 | 2843 | 2844 | 2845 | 2846 |      | 5030 | 2584 |   |   |   |   |   |   |   |  |   |   |   |   |   |   |   |   |  |  |  |  |  |  |
| 5040 | 2592 | 2593 | 2594 | 2595 | 2596 | 2597 | 2598 | 2599 | 5440 | 2848 | 2849 | 2850 | 2851 | 2852 | 2853 | 2854 |      | 5040 | 2592 |   |   |   |   |   |   |   |  |   |   |   |   |   |   |   |   |  |  |  |  |  |  |
| 5050 | 2600 | 2601 | 2602 | 2603 | 2604 | 2605 | 2606 | 2607 | 5450 | 2856 | 2857 | 2858 | 2859 | 2860 | 2861 | 2862 |      | 5050 | 2600 |   |   |   |   |   |   |   |  |   |   |   |   |   |   |   |   |  |  |  |  |  |  |
| 5060 | 2608 | 2609 | 2610 | 2611 | 2612 | 2613 | 2614 | 2615 | 5460 | 2864 | 2865 | 2866 | 2867 | 2868 | 2869 | 2870 |      | 5060 | 2608 |   |   |   |   |   |   |   |  |   |   |   |   |   |   |   |   |  |  |  |  |  |  |
| 5070 | 2616 | 2617 | 2618 | 2619 | 2620 |      |      |      |      |      |      |      |      |      |      |      |      |      |      |   |   |   |   |   |   |   |  |   |   |   |   |   |   |   |   |  |  |  |  |  |  |

TABLE 1A-2. OCTAL-DECIMAL CONVERSION TABLE (SHEET 4 OF 4)

|                               |                                 | 0    | 1    | 2    | 3    | 4    | 5    | 6    | 7    |      |
|-------------------------------|---------------------------------|------|------|------|------|------|------|------|------|------|
| 6000<br>to<br>6777<br>(Octal) | 3072<br>to<br>3583<br>(Decimal) | 6000 | 3072 | 3073 | 3074 | 3075 | 3076 | 3077 | 3078 | 3079 |
|                               |                                 | 6010 | 3080 | 3081 | 3082 | 3083 | 3084 | 3085 | 3086 | 3087 |
|                               |                                 | 6020 | 3088 | 3089 | 3090 | 3091 | 3092 | 3093 | 3094 | 3095 |
|                               |                                 | 6030 | 3096 | 3097 | 3098 | 3099 | 3100 | 3101 | 3102 | 3103 |
|                               |                                 | 6040 | 3104 | 3105 | 3106 | 3107 | 3108 | 3109 | 3110 | 3111 |
|                               |                                 | 6050 | 3112 | 3113 | 3114 | 3115 | 3116 | 3117 | 3118 | 3119 |
|                               |                                 | 6060 | 3120 | 3121 | 3122 | 3123 | 3124 | 3125 | 3126 | 3127 |
|                               |                                 | 6070 | 3128 | 3129 | 3130 | 3131 | 3132 | 3133 | 3134 | 3135 |
| Octal<br>10000 - 20480        | Decimal<br>4096 - 28672         | 6100 | 3136 | 3137 | 3138 | 3139 | 3140 | 3141 | 3142 | 3143 |
|                               |                                 | 6110 | 3144 | 3145 | 3146 | 3147 | 3148 | 3149 | 3150 | 3151 |
|                               |                                 | 6120 | 3152 | 3153 | 3154 | 3155 | 3156 | 3157 | 3158 | 3159 |
|                               |                                 | 6130 | 3160 | 3161 | 3162 | 3163 | 3164 | 3165 | 3166 | 3167 |
|                               |                                 | 6140 | 3168 | 3169 | 3170 | 3171 | 3172 | 3173 | 3174 | 3175 |
|                               |                                 | 6150 | 3176 | 3177 | 3178 | 3179 | 3180 | 3181 | 3182 | 3183 |
|                               |                                 | 6160 | 3184 | 3185 | 3186 | 3187 | 3188 | 3189 | 3190 | 3191 |
|                               |                                 | 6170 | 3192 | 3193 | 3194 | 3195 | 3196 | 3197 | 3198 | 3199 |
| 6200<br>to<br>6270            |                                 | 6200 | 3200 | 3201 | 3202 | 3203 | 3204 | 3205 | 3206 | 3207 |
|                               |                                 | 6210 | 3208 | 3209 | 3210 | 3211 | 3212 | 3213 | 3214 | 3215 |
|                               |                                 | 6220 | 3216 | 3217 | 3218 | 3219 | 3220 | 3221 | 3222 | 3223 |
|                               |                                 | 6230 | 3224 | 3225 | 3226 | 3227 | 3228 | 3229 | 3230 | 3231 |
|                               |                                 | 6240 | 3232 | 3233 | 3234 | 3235 | 3236 | 3237 | 3238 | 3239 |
|                               |                                 | 6250 | 3240 | 3241 | 3242 | 3243 | 3244 | 3245 | 3246 | 3247 |
|                               |                                 | 6260 | 3248 | 3249 | 3250 | 3251 | 3252 | 3253 | 3254 | 3255 |
|                               |                                 | 6270 | 3256 | 3257 | 3258 | 3259 | 3260 | 3261 | 3262 | 3263 |
| 6300<br>to<br>6370            |                                 | 6300 | 3264 | 3265 | 3266 | 3267 | 3268 | 3269 | 3270 | 3271 |
|                               |                                 | 6310 | 3272 | 3273 | 3274 | 3275 | 3276 | 3277 | 3278 | 3279 |
|                               |                                 | 6320 | 3280 | 3281 | 3282 | 3283 | 3284 | 3285 | 3286 | 3287 |
|                               |                                 | 6330 | 3288 | 3289 | 3290 | 3291 | 3292 | 3293 | 3294 | 3295 |
|                               |                                 | 6340 | 3296 | 3297 | 3298 | 3299 | 3300 | 3301 | 3302 | 3303 |
|                               |                                 | 6350 | 3304 | 3305 | 3306 | 3307 | 3308 | 3309 | 3310 | 3311 |
|                               |                                 | 6360 | 3312 | 3313 | 3314 | 3315 | 3316 | 3317 | 3318 | 3319 |
|                               |                                 | 6370 | 3320 | 3321 | 3322 | 3323 | 3324 | 3325 | 3326 | 3327 |
| 6400<br>to<br>6470            |                                 | 6400 | 3328 | 3329 | 3330 | 3331 | 3332 | 3333 | 3334 | 3335 |
|                               |                                 | 6410 | 3336 | 3337 | 3338 | 3339 | 3340 | 3341 | 3342 | 3343 |
|                               |                                 | 6420 | 3344 | 3345 | 3346 | 3347 | 3348 | 3349 | 3350 | 3351 |
|                               |                                 | 6430 | 3352 | 3353 | 3354 | 3355 | 3356 | 3357 | 3358 | 3359 |
|                               |                                 | 6440 | 3360 | 3361 | 3362 | 3363 | 3364 | 3365 | 3366 | 3367 |
|                               |                                 | 6450 | 3368 | 3369 | 3370 | 3371 | 3372 | 3373 | 3374 | 3375 |
|                               |                                 | 6460 | 3376 | 3377 | 3378 | 3379 | 3380 | 3381 | 3382 | 3383 |
|                               |                                 | 6470 | 3384 | 3385 | 3386 | 3387 | 3388 | 3389 | 3390 | 3391 |
| 6500<br>to<br>6570            |                                 | 6500 | 3392 | 3393 | 3394 | 3395 | 3396 | 3397 | 3398 | 3399 |
|                               |                                 | 6510 | 3400 | 3401 | 3402 | 3403 | 3404 | 3405 | 3406 | 3407 |
|                               |                                 | 6520 | 3408 | 3409 | 3410 | 3411 | 3412 | 3413 | 3414 | 3415 |
|                               |                                 | 6530 | 3416 | 3417 | 3418 | 3419 | 3420 | 3421 | 3422 | 3423 |
|                               |                                 | 6540 | 3424 | 3425 | 3426 | 3427 | 3428 | 3429 | 3430 | 3431 |
|                               |                                 | 6550 | 3432 | 3433 | 3434 | 3435 | 3436 | 3437 | 3438 | 3439 |
|                               |                                 | 6560 | 3440 | 3441 | 3442 | 3443 | 3444 | 3445 | 3446 | 3447 |
|                               |                                 | 6570 | 3448 | 3449 | 3450 | 3451 | 3452 | 3453 | 3454 | 3455 |
| 6600<br>to<br>6670            |                                 | 6600 | 3456 | 3457 | 3458 | 3459 | 3460 | 3461 | 3462 | 3463 |
|                               |                                 | 6610 | 3464 | 3465 | 3466 | 3467 | 3468 | 3469 | 3470 | 3471 |
|                               |                                 | 6620 | 3472 | 3473 | 3474 | 3475 | 3476 | 3477 | 3478 | 3479 |
|                               |                                 | 6630 | 3480 | 3481 | 3482 | 3483 | 3484 | 3485 | 3486 | 3487 |
|                               |                                 | 6640 | 3488 | 3489 | 3490 | 3491 | 3492 | 3493 | 3494 | 3495 |
|                               |                                 | 6650 | 3496 | 3497 | 3498 | 3499 | 3500 | 3501 | 3502 | 3503 |
|                               |                                 | 6660 | 3504 | 3505 | 3506 | 3507 | 3508 | 3509 | 3510 | 3511 |
|                               |                                 | 6670 | 3512 | 3513 | 3514 | 3515 | 3516 | 3517 | 3518 | 3519 |
| 6700<br>to<br>6770            |                                 | 6700 | 3520 | 3521 | 3522 | 3523 | 3524 | 3525 | 3526 | 3527 |
|                               |                                 | 6710 | 3528 | 3529 | 3530 | 3531 | 3532 | 3533 | 3534 | 3535 |
|                               |                                 | 6720 | 3536 | 3537 | 3538 | 3539 | 3540 | 3541 | 3542 | 3543 |
|                               |                                 | 6730 | 3544 | 3545 | 3546 | 3547 | 3548 | 3549 | 3550 | 3551 |
|                               |                                 | 6740 | 3552 | 3553 | 3554 | 3555 | 3556 | 3557 | 3558 | 3559 |
|                               |                                 | 6750 | 3560 | 3561 | 3562 | 3563 | 3564 | 3565 | 3566 | 3567 |
|                               |                                 | 6760 | 3568 | 3569 | 3570 | 3571 | 3572 | 3573 | 3574 | 3575 |
|                               |                                 | 6770 | 3576 | 3577 | 3578 | 3579 | 3580 | 3581 | 3582 | 3583 |
| 7000<br>to<br>7777<br>(Octal) | 3584<br>to<br>4095<br>(Decimal) | 7000 | 3584 | 3585 | 3586 | 3587 | 3588 | 3589 | 3590 | 3591 |
|                               |                                 | 7010 | 3592 | 3593 | 3594 | 3595 | 3596 | 3597 | 3598 | 3599 |
|                               |                                 | 7020 | 3600 | 3601 | 3602 | 3603 | 3604 | 3605 | 3606 | 3607 |
|                               |                                 | 7030 | 3608 | 3609 | 3610 | 3611 | 3612 | 3613 | 3614 | 3615 |
|                               |                                 | 7040 | 3616 | 3617 | 3618 | 3619 | 3620 | 3621 | 3622 | 3623 |
|                               |                                 | 7050 | 3624 | 3625 | 3626 | 3627 | 3628 | 3629 | 3630 | 3631 |
|                               |                                 | 7060 | 3632 | 3633 | 3634 | 3635 | 3636 | 3637 | 3638 | 3639 |
|                               |                                 | 7070 | 3640 | 3641 | 3642 | 3643 | 3644 | 3645 | 3646 | 3647 |
| 7100<br>to<br>7170            |                                 | 7100 | 3648 | 3649 | 3650 | 3651 | 3652 | 3653 | 3654 | 3655 |
|                               |                                 | 7110 | 3656 | 3657 | 3658 | 3659 | 3660 | 3661 | 3662 | 3663 |
|                               |                                 | 7120 | 3664 | 3665 | 3666 | 3667 | 3668 | 3669 | 3670 | 3671 |
|                               |                                 | 7130 | 3672 | 3673 | 3674 | 3675 | 3676 | 3677 | 3678 | 3679 |
|                               |                                 | 7140 | 3680 | 3681 | 3682 | 3683 | 3684 | 3685 | 3686 | 3687 |
|                               |                                 | 7150 | 3688 | 3689 | 3690 | 3691 | 3692 | 3693 | 3694 | 3695 |
|                               |                                 | 7160 | 3696 | 3697 | 3698 | 3699 | 3700 | 3701 | 3702 | 3703 |
|                               |                                 | 7170 | 3704 | 3705 | 3706 | 3707 | 3708 | 3709 | 3710 | 3711 |
| 7200<br>to<br>7270            |                                 | 7200 | 3712 | 3713 | 3714 | 3715 | 3716 | 3717 | 3718 | 3719 |
|                               |                                 | 7210 | 3720 | 3721 | 3722 | 3723 | 3724 | 3725 | 3726 | 3727 |
|                               |                                 | 7220 | 3728 | 3729 | 3730 | 3731 | 3732 | 3733 | 3734 | 3735 |
|                               |                                 | 7230 | 3736 | 3737 | 3738 | 3739 | 3740 | 3741 | 3742 | 3743 |
|                               |                                 | 7240 | 3744 | 3745 | 3746 | 3747 | 3748 | 3749 | 3750 | 3751 |
|                               |                                 | 7250 | 3752 | 3753 | 3754 | 3755 | 3756 | 3757 | 3758 | 3759 |
|                               |                                 | 7260 | 3760 | 3761 | 3762 | 3763 | 3764 | 3765 | 3766 | 3767 |
|                               |                                 | 7270 | 3768 | 3769 | 3770 | 3771 | 3772 | 3773 | 3774 | 3775 |
| 7300<br>to<br>7370            |                                 | 7300 | 3776 | 3777 | 3778 | 3779 | 3780 | 3781 | 3782 | 3783 |
|                               |                                 | 7310 | 3784 | 3785 | 3786 | 3787 | 3788 | 3789 | 3790 | 3791 |
|                               |                                 | 7320 | 3792 | 3793 | 3794 | 3795 | 3796 | 3797 | 3798 | 3799 |
|                               |                                 | 7330 | 3800 | 3801 | 3802 | 3803 | 3804 | 3805 | 3806 | 3807 |
|                               |                                 | 7340 | 3808 | 3809 | 3810 | 3811 | 3812 | 3813 | 3814 | 3815 |
|                               |                                 | 7350 | 3816 | 3817 | 3818 | 3819 | 3820 | 3821 | 3822 | 3823 |
|                               |                                 | 7360 | 3824 | 3825 | 3826 | 3827 | 3828 | 3829 | 3830 | 3831 |
|                               |                                 | 7370 | 3832 | 3833 | 3834 | 3835 | 3836 | 3837 | 3838 | 3839 |
| 7400<br>to<br>7470            |                                 | 7400 | 3840 | 3841 | 3842 | 3843 | 3844 | 3845 | 3846 | 3847 |
|                               |                                 | 7410 | 3848 | 3849 | 3850 | 3851 | 3852 | 3853 | 3854 | 3855 |
|                               |                                 | 7420 | 3856 | 3857 | 3858 | 3859 | 3860 | 3861 | 3862 | 3863 |
|                               |                                 | 7430 | 3864 | 3865 | 3866 | 3867 | 3868 | 3869 | 3870 | 3871 |
|                               |                                 | 7440 | 3872 | 3873 | 3874 | 3875 | 3876 | 3877 | 3878 | 3879 |
|                               |                                 | 7450 | 3880 | 3881 | 3882 | 3883 | 3884 | 3885 | 3886 | 3887 |
|                               |                                 | 7460 | 3888 | 3889 | 3890 | 3891 | 3892 | 3893 | 3894 | 3895 |
|                               |                                 | 7470 | 3896 | 3897 | 3898 | 3899 | 3900 | 3901 | 3902 | 3903 |
| 7500<br>to<br>7570            |                                 | 7500 | 3904 | 3905 | 3906 | 3907 | 3908 | 3909 | 3910 | 3911 |
|                               |                                 | 7510 | 3912 | 3913 | 3914 | 3915 | 3916 | 3917 | 3918 | 3919 |
|                               |                                 | 7520 | 3920 | 3921 | 3922 | 3923 | 3924 | 3925 | 3926 | 3927 |
|                               |                                 | 7530 | 3928 | 3929 | 3930 | 3931 | 3932 | 3933 | 3934 | 3935 |
|                               |                                 | 7540 | 3936 | 3937 | 3938 | 3939 | 3940 | 3941 | 3942 | 3943 |
|                               |                                 | 7550 | 3944 | 3945 | 3946 | 3947 | 3948 | 3949 | 3950 | 3951 |
|                               |                                 | 7560 | 3952 | 3953 | 3954 | 3955 | 3956 | 3957 | 3958 | 3959 |
|                               |                                 | 7570 | 3960 | 3961 | 3962 | 3963 | 3964 | 3965 | 3966 | 3967 |
| 7600<br>to<br>7670            |                                 | 7600 | 3968 | 3969 | 3970 | 3971 | 3972 | 3973 | 3974 | 3975 |
|                               |                                 | 7610 | 3976 | 3977 | 3978 | 3979 | 3980 | 3981 | 3982 | 3983 |
|                               |                                 | 7620 | 3984 | 3985 | 3986 | 3987 | 3988 | 3989 | 3990 | 3991 |
|                               |                                 | 7630 | 3992 | 3993 | 3994 | 3995 | 3996 | 3997 | 3998 | 3999 |
|                               |                                 | 7640 | 4000 | 4001 | 4002 | 4003 | 4004 | 4005 | 4006 | 4007 |
|                               |                                 | 7650 | 4008 | 4009 | 4010 | 4011 | 4012 | 4013 | 4014 | 4015 |
|                               |                                 | 7660 | 4016 | 4017 | 4018 | 4019 | 4020 | 4021 | 4022 | 4023 |
|                               |                                 | 7670 | 4024 | 4025 | 4026 | 4027 | 4028 | 4029 | 4030 | 4031 |
| 7700<br>to<br>7770            |                                 | 7700 | 4032 | 4033 | 4034 | 4035 | 4036 | 4037 | 4038 | 4039 |
|                               |                                 | 7710 | 4040 | 4041 | 4042 | 4043 | 4044 | 4045 | 4046 | 4047 |
|                               |                                 | 7720 | 4048 | 4049 | 4050 | 4051 | 4052 | 4053 | 4054 | 4055 |
|                               |                                 | 7730 | 4056 | 4057 | 4058 | 4059 | 4060 | 4061 | 4062 | 4063 |
|                               |                                 | 7740 | 4064 | 4065 | 4066 | 4067 | 4068 | 4069 | 4070 | 4071 |
|                               |                                 | 7750 | 4072 | 4073 | 4074 | 4075 | 4076 | 4077 | 4078 | 4079 |
|                               |                                 | 7760 | 4080 | 4081 | 4082 | 4083 | 4084 | 4085 | 4086 | 4087 |
|                               |                                 | 7770 | 4088 | 4089 | 4090 | 4091 | 4092 | 4093 | 4094 | 4095 |



TABLE 1A-3. OCTAL-DECIMAL FRACTION CONVERSION TABLE (SHEET 1 OF 3)

| OCTAL | DEC.    | OCTAL | DEC.    | OCTAL | DEC.    | OCTAL | DEC.    |
|-------|---------|-------|---------|-------|---------|-------|---------|
| .000  | .000000 | .100  | .125000 | .200  | .250000 | .300  | .375000 |
| .001  | .001953 | .101  | .126953 | .201  | .251953 | .301  | .376953 |
| .002  | .003906 | .102  | .128906 | .202  | .253906 | .302  | .378906 |
| .003  | .005859 | .103  | .130859 | .203  | .255859 | .303  | .380859 |
| .004  | .007812 | .104  | .132812 | .204  | .257812 | .304  | .382812 |
| .005  | .009765 | .105  | .134765 | .205  | .259765 | .305  | .384765 |
| .006  | .011718 | .106  | .136718 | .206  | .261718 | .306  | .386718 |
| .007  | .013671 | .107  | .138671 | .207  | .263671 | .307  | .388671 |
| .010  | .015625 | .110  | .140625 | .210  | .265625 | .310  | .390625 |
| .011  | .017578 | .111  | .142578 | .211  | .267578 | .311  | .392578 |
| .012  | .019531 | .112  | .144531 | .212  | .269531 | .312  | .394531 |
| .013  | .021484 | .113  | .146484 | .213  | .271484 | .313  | .396484 |
| .014  | .023437 | .114  | .148437 | .214  | .273437 | .314  | .398437 |
| .015  | .025390 | .115  | .150390 | .215  | .275390 | .315  | .400390 |
| .016  | .027343 | .116  | .152343 | .216  | .277343 | .316  | .402343 |
| .017  | .029296 | .117  | .154296 | .217  | .279296 | .317  | .404296 |
| .020  | .031250 | .120  | .156250 | .220  | .281250 | .320  | .406250 |
| .021  | .033203 | .121  | .158203 | .221  | .283203 | .321  | .408203 |
| .022  | .035156 | .122  | .160156 | .222  | .285156 | .322  | .410156 |
| .023  | .037109 | .123  | .162109 | .223  | .287109 | .323  | .412109 |
| .024  | .039062 | .124  | .164062 | .224  | .289062 | .324  | .414062 |
| .025  | .041015 | .125  | .166015 | .225  | .291015 | .325  | .416015 |
| .026  | .042968 | .126  | .167968 | .226  | .292968 | .326  | .417968 |
| .027  | .044921 | .127  | .169921 | .227  | .294921 | .327  | .419921 |
| .030  | .046875 | .130  | .171875 | .230  | .296875 | .330  | .421875 |
| .031  | .048828 | .131  | .173828 | .231  | .298828 | .331  | .423828 |
| .032  | .050781 | .132  | .175781 | .232  | .300781 | .332  | .425781 |
| .033  | .052734 | .133  | .177734 | .233  | .302734 | .333  | .427734 |
| .034  | .054687 | .134  | .179687 | .234  | .304687 | .334  | .429687 |
| .035  | .056640 | .135  | .181640 | .235  | .306640 | .335  | .431640 |
| .036  | .058593 | .136  | .183593 | .236  | .308593 | .336  | .433593 |
| .037  | .060546 | .137  | .185546 | .237  | .310546 | .337  | .435546 |
| .040  | .062500 | .140  | .187500 | .240  | .312500 | .340  | .437500 |
| .041  | .064453 | .141  | .189453 | .241  | .314453 | .341  | .439453 |
| .042  | .066406 | .142  | .191406 | .242  | .316406 | .342  | .441406 |
| .043  | .068359 | .143  | .193359 | .243  | .318359 | .343  | .443359 |
| .044  | .070312 | .144  | .195312 | .244  | .320312 | .344  | .445312 |
| .045  | .072265 | .145  | .197265 | .245  | .322265 | .345  | .447265 |
| .046  | .074218 | .146  | .199218 | .246  | .324218 | .346  | .449218 |
| .047  | .076171 | .147  | .201171 | .247  | .326171 | .347  | .451171 |
| .050  | .078125 | .150  | .203125 | .250  | .328125 | .350  | .453125 |
| .051  | .080078 | .151  | .205078 | .251  | .330078 | .351  | .455078 |
| .052  | .082031 | .152  | .207031 | .252  | .332031 | .352  | .457031 |
| .053  | .083984 | .153  | .208984 | .253  | .333984 | .353  | .458984 |
| .054  | .085937 | .154  | .210937 | .254  | .335937 | .354  | .460937 |
| .055  | .087890 | .155  | .212890 | .255  | .337890 | .355  | .462890 |
| .056  | .089843 | .156  | .214843 | .256  | .339843 | .356  | .464843 |
| .057  | .091796 | .157  | .216796 | .257  | .341796 | .357  | .466796 |
| .060  | .093750 | .160  | .218750 | .260  | .343750 | .360  | .468750 |
| .061  | .095703 | .161  | .220703 | .261  | .345703 | .361  | .470703 |
| .062  | .097656 | .162  | .222656 | .262  | .347656 | .362  | .472656 |
| .063  | .099609 | .163  | .224609 | .263  | .349609 | .363  | .474609 |
| .064  | .101562 | .164  | .226562 | .264  | .351562 | .364  | .476562 |
| .065  | .103515 | .165  | .228515 | .265  | .353515 | .365  | .478515 |
| .066  | .105468 | .166  | .230468 | .266  | .355468 | .366  | .480468 |
| .067  | .107421 | .167  | .232421 | .267  | .357421 | .367  | .482421 |
| .070  | .109375 | .170  | .234375 | .270  | .359375 | .370  | .484375 |
| .071  | .111328 | .171  | .236328 | .271  | .361328 | .371  | .486328 |
| .072  | .113281 | .172  | .238281 | .272  | .363281 | .372  | .488281 |
| .073  | .115234 | .173  | .240234 | .273  | .365234 | .373  | .490234 |
| .074  | .117187 | .174  | .242187 | .274  | .367187 | .374  | .492187 |
| .075  | .119140 | .175  | .244140 | .275  | .369140 | .375  | .494140 |
| .076  | .121093 | .176  | .246093 | .276  | .371093 | .376  | .496093 |
| .077  | .123046 | .177  | .248046 | .277  | .373046 | .377  | .498046 |

TABLE 1A-3. OCTAL-DECIMAL FRACTION CONVERSION TABLE (SHEET 2 OF 3)

| OCTAL   | DEC.    | OCTAL   | DEC.    | OCTAL   | DEC.    | OCTAL   | DEC.    |
|---------|---------|---------|---------|---------|---------|---------|---------|
| .000400 | .000976 | .000500 | .001220 | .000600 | .001464 | .000700 | .001708 |
| .000401 | .000980 | .000501 | .001224 | .000601 | .001468 | .000701 | .001712 |
| .000402 | .000984 | .000502 | .001228 | .000602 | .001472 | .000702 | .001716 |
| .000403 | .000988 | .000503 | .001232 | .000603 | .001476 | .000703 | .001720 |
| .000404 | .000991 | .000504 | .001235 | .000604 | .001480 | .000704 | .001724 |
| .000405 | .000995 | .000505 | .001239 | .000605 | .001483 | .000705 | .001728 |
| .000406 | .000999 | .000506 | .001243 | .000606 | .001487 | .000706 | .001731 |
| .000407 | .001003 | .000507 | .001247 | .000607 | .001491 | .000707 | .001735 |
| .000410 | .001007 | .000510 | .001251 | .000610 | .001495 | .000710 | .001739 |
| .000411 | .001010 | .000511 | .001255 | .000611 | .001499 | .000711 | .001743 |
| .000412 | .001014 | .000512 | .001258 | .000612 | .001502 | .000712 | .001747 |
| .000413 | .001018 | .000513 | .001262 | .000613 | .001506 | .000713 | .001750 |
| .000414 | .001022 | .000514 | .001266 | .000614 | .001510 | .000714 | .001754 |
| .000415 | .001026 | .000515 | .001270 | .000615 | .001514 | .000715 | .001758 |
| .000416 | .001029 | .000516 | .001274 | .000616 | .001518 | .000716 | .001762 |
| .000417 | .001033 | .000517 | .001277 | .000617 | .001522 | .000717 | .001766 |
| .000420 | .001037 | .000520 | .001281 | .000620 | .001525 | .000720 | .001770 |
| .000421 | .001041 | .000521 | .001285 | .000621 | .001529 | .000721 | .001773 |
| .000422 | .001045 | .000522 | .001289 | .000622 | .001533 | .000722 | .001777 |
| .000423 | .001049 | .000523 | .001293 | .000623 | .001537 | .000723 | .001781 |
| .000424 | .001052 | .000524 | .001296 | .000624 | .001541 | .000724 | .001785 |
| .000425 | .001056 | .000525 | .001300 | .000625 | .001544 | .000725 | .001789 |
| .000426 | .001060 | .000526 | .001304 | .000626 | .001548 | .000726 | .001792 |
| .000427 | .001064 | .000527 | .001308 | .000627 | .001552 | .000727 | .001796 |
| .000430 | .001068 | .000530 | .001312 | .000630 | .001556 | .000730 | .001800 |
| .000431 | .001071 | .000531 | .001316 | .000631 | .001560 | .000731 | .001804 |
| .000432 | .001075 | .000532 | .001319 | .000632 | .001564 | .000732 | .001808 |
| .000433 | .001079 | .000533 | .001323 | .000633 | .001567 | .000733 | .001811 |
| .000434 | .001083 | .000534 | .001327 | .000634 | .001571 | .000734 | .001815 |
| .000435 | .001087 | .000535 | .001331 | .000635 | .001575 | .000735 | .001819 |
| .000436 | .001091 | .000536 | .001335 | .000636 | .001579 | .000736 | .001823 |
| .000437 | .001094 | .000537 | .001338 | .000637 | .001583 | .000737 | .001827 |
| .000440 | .001098 | .000540 | .001342 | .000640 | .001586 | .000740 | .001831 |
| .000441 | .001102 | .000541 | .001346 | .000641 | .001590 | .000741 | .001834 |
| .000442 | .001106 | .000542 | .001350 | .000642 | .001594 | .000742 | .001838 |
| .000443 | .001110 | .000543 | .001354 | .000643 | .001598 | .000743 | .001842 |
| .000444 | .001113 | .000544 | .001358 | .000644 | .001602 | .000744 | .001846 |
| .000445 | .001117 | .000545 | .001361 | .000645 | .001605 | .000745 | .001850 |
| .000446 | .001121 | .000546 | .001365 | .000646 | .001609 | .000746 | .001853 |
| .000447 | .001125 | .000547 | .001369 | .000647 | .001613 | .000747 | .001857 |
| .000450 | .001129 | .000550 | .001373 | .000650 | .001617 | .000750 | .001861 |
| .000451 | .001132 | .000551 | .001377 | .000651 | .001621 | .000751 | .001865 |
| .000452 | .001136 | .000552 | .001380 | .000652 | .001625 | .000752 | .001869 |
| .000453 | .001140 | .000553 | .001384 | .000653 | .001628 | .000753 | .001873 |
| .000454 | .001144 | .000554 | .001388 | .000654 | .001632 | .000754 | .001876 |
| .000455 | .001148 | .000555 | .001392 | .000655 | .001636 | .000755 | .001880 |
| .000456 | .001152 | .000556 | .001396 | .000656 | .001640 | .000756 | .001884 |
| .000457 | .001155 | .000557 | .001399 | .000657 | .001644 | .000757 | .001888 |
| .000460 | .001159 | .000560 | .001403 | .000660 | .001647 | .000760 | .001892 |
| .000461 | .001163 | .000561 | .001407 | .000661 | .001651 | .000761 | .001895 |
| .000462 | .001167 | .000562 | .001411 | .000662 | .001655 | .000762 | .001899 |
| .000463 | .001171 | .000563 | .001415 | .000663 | .001659 | .000763 | .001903 |
| .000464 | .001174 | .000564 | .001419 | .000664 | .001663 | .000764 | .001907 |
| .000465 | .001178 | .000565 | .001422 | .000665 | .001667 | .000765 | .001911 |
| .000466 | .001182 | .000566 | .001426 | .000666 | .001670 | .000766 | .001914 |
| .000467 | .001186 | .000567 | .001430 | .000667 | .001674 | .000767 | .001918 |
| .000470 | .001190 | .000570 | .001434 | .000670 | .001678 | .000770 | .001922 |
| .000471 | .001194 | .000571 | .001438 | .000671 | .001682 | .000771 | .001926 |
| .000472 | .001197 | .000572 | .001441 | .000672 | .001686 | .000772 | .001930 |
| .000473 | .001201 | .000573 | .001445 | .000673 | .001689 | .000773 | .001934 |
| .000474 | .001205 | .000574 | .001449 | .000674 | .001693 | .000774 | .001937 |
| .000475 | .001209 | .000575 | .001453 | .000675 | .001697 | .000775 | .001941 |
| .000476 | .001213 | .000576 | .001457 | .000676 | .001701 | .000776 | .001945 |
| .000477 | .001218 | .000577 | .001461 | .000677 | .001705 | .000777 | .001949 |

TABLE 1A-3. OCTAL-DECIMAL FRACTION CONVERSION TABLE (SHEET 3 OF 3)

| OCTAL   | DEC.    | OCTAL   | DEC.    | OCTAL   | DEC.    | OCTAL   | DEC.    |
|---------|---------|---------|---------|---------|---------|---------|---------|
| .000000 | .000000 | .000100 | .000244 | .000200 | .000488 | .000300 | .000732 |
| .000001 | .000003 | .000101 | .000247 | .000201 | .000492 | .000301 | .000736 |
| .000002 | .000007 | .000102 | .000251 | .000202 | .000495 | .000302 | .000740 |
| .000003 | .000011 | .000103 | .000255 | .000203 | .000499 | .000303 | .000743 |
| .000004 | .000015 | .000104 | .000259 | .000204 | .000503 | .000304 | .000747 |
| .000005 | .000019 | .000105 | .000263 | .000205 | .000507 | .000305 | .000751 |
| .000006 | .000022 | .000106 | .000267 | .000206 | .000511 | .000306 | .000755 |
| .000007 | .000026 | .000107 | .000270 | .000207 | .000514 | .000307 | .000759 |
| .000010 | .000030 | .000110 | .000274 | .000210 | .000518 | .000310 | .000762 |
| .000011 | .000034 | .000111 | .000278 | .000211 | .000522 | .000311 | .000766 |
| .000012 | .000038 | .000112 | .000282 | .000212 | .000526 | .000312 | .000770 |
| .000013 | .000041 | .000113 | .000286 | .000213 | .000530 | .000313 | .000774 |
| .000014 | .000045 | .000114 | .000289 | .000214 | .000534 | .000314 | .000778 |
| .000015 | .000049 | .000115 | .000293 | .000215 | .000537 | .000315 | .000782 |
| .000016 | .000053 | .000116 | .000297 | .000216 | .000541 | .000316 | .000785 |
| .000017 | .000057 | .000117 | .000301 | .000217 | .000545 | .000317 | .000789 |
| .000020 | .000061 | .000120 | .000305 | .000220 | .000549 | .000320 | .000793 |
| .000021 | .000064 | .000121 | .000308 | .000221 | .000553 | .000321 | .000797 |
| .000022 | .000068 | .000122 | .000312 | .000222 | .000556 | .000322 | .000801 |
| .000023 | .000072 | .000123 | .000316 | .000223 | .000560 | .000323 | .000805 |
| .000024 | .000076 | .000124 | .000320 | .000224 | .000564 | .000324 | .000808 |
| .000025 | .000080 | .000125 | .000324 | .000225 | .000568 | .000325 | .000812 |
| .000026 | .000083 | .000126 | .000328 | .000226 | .000572 | .000326 | .000816 |
| .000027 | .000087 | .000127 | .000331 | .000227 | .000576 | .000327 | .000820 |
| .000030 | .000091 | .000130 | .000335 | .000230 | .000579 | .000330 | .000823 |
| .000031 | .000095 | .000131 | .000339 | .000231 | .000583 | .000331 | .000827 |
| .000032 | .000099 | .000132 | .000343 | .000232 | .000587 | .000332 | .000831 |
| .000033 | .000102 | .000133 | .000347 | .000233 | .000591 | .000333 | .000835 |
| .000034 | .000106 | .000134 | .000350 | .000234 | .000595 | .000334 | .000839 |
| .000035 | .000110 | .000135 | .000354 | .000235 | .000598 | .000335 | .000843 |
| .000036 | .000114 | .000136 | .000358 | .000236 | .000602 | .000336 | .000846 |
| .000037 | .000118 | .000137 | .000362 | .000237 | .000606 | .000337 | .000850 |
| .000040 | .000122 | .000140 | .000366 | .000240 | .000610 | .000340 | .000854 |
| .000041 | .000125 | .000141 | .000370 | .000241 | .000614 | .000341 | .000858 |
| .000042 | .000129 | .000142 | .000373 | .000242 | .000617 | .000342 | .000862 |
| .000043 | .000133 | .000143 | .000377 | .000243 | .000621 | .000343 | .000865 |
| .000044 | .000137 | .000144 | .000381 | .000244 | .000625 | .000344 | .000869 |
| .000045 | .000141 | .000145 | .000385 | .000245 | .000629 | .000345 | .000873 |
| .000046 | .000144 | .000146 | .000389 | .000246 | .000633 | .000346 | .000877 |
| .000047 | .000148 | .000147 | .000392 | .000247 | .000637 | .000347 | .000881 |
| .000050 | .000152 | .000150 | .000396 | .000250 | .000640 | .000350 | .000885 |
| .000051 | .000156 | .000151 | .000400 | .000251 | .000644 | .000351 | .000888 |
| .000052 | .000160 | .000152 | .000404 | .000252 | .000648 | .000352 | .000892 |
| .000053 | .000164 | .000153 | .000408 | .000253 | .000652 | .000353 | .000896 |
| .000054 | .000167 | .000154 | .000411 | .000254 | .000656 | .000354 | .000900 |
| .000055 | .000171 | .000155 | .000415 | .000255 | .000659 | .000355 | .000904 |
| .000056 | .000175 | .000156 | .000419 | .000256 | .000663 | .000356 | .000907 |
| .000057 | .000179 | .000157 | .000423 | .000257 | .000667 | .000357 | .000911 |
| .000060 | .000183 | .000160 | .000427 | .000260 | .000671 | .000360 | .000915 |
| .000061 | .000186 | .000161 | .000431 | .000261 | .000675 | .000361 | .000919 |
| .000062 | .000190 | .000162 | .000434 | .000262 | .000679 | .000362 | .000923 |
| .000063 | .000194 | .000163 | .000438 | .000263 | .000682 | .000363 | .000926 |
| .000064 | .000198 | .000164 | .000442 | .000264 | .000686 | .000364 | .000930 |
| .000065 | .000202 | .000165 | .000446 | .000265 | .000690 | .000365 | .000934 |
| .000066 | .000205 | .000166 | .000450 | .000266 | .000694 | .000366 | .000938 |
| .000067 | .000209 | .000167 | .000453 | .000267 | .000698 | .000367 | .000942 |
| .000070 | .000213 | .000170 | .000457 | .000270 | .000701 | .000370 | .000946 |
| .000071 | .000217 | .000171 | .000461 | .000271 | .000705 | .000371 | .000949 |
| .000072 | .000221 | .000172 | .000465 | .000272 | .000709 | .000372 | .000953 |
| .000073 | .000225 | .000173 | .000469 | .000273 | .000713 | .000373 | .000957 |
| .000074 | .000228 | .000174 | .000473 | .000274 | .000717 | .000374 | .000961 |
| .000075 | .000232 | .000175 | .000476 | .000275 | .000720 | .000375 | .000965 |
| .000076 | .000236 | .000176 | .000480 | .000276 | .000724 | .000376 | .000968 |
| .000077 | .000240 | .000177 | .000484 | .000277 | .000728 | .000377 | .000972 |

## ALPHABETICAL INDEX

|   | <u>Subject</u>               | <u>Page</u> |
|---|------------------------------|-------------|
| C | — Channel Busy Line          | 3-4         |
|   | — Connect Code               | 3-7         |
|   | — Connect Line               | 3-1         |
|   | — Controls                   | 2-1         |
| D | — Data Lines (12)            | 3-1         |
|   | — Data Signal Line           | 3-4         |
|   | — Display Controller         | 2-1         |
|   | — Display Station            | 2-5         |
| E | — End of Record Line         | 3-6         |
|   | — Error Processing           | 3-35        |
| F | — Function Codes             | 3-7         |
|   | — Function Line              | 3-3         |
|   | — Functional Description     | 1-2         |
| I | — Interface Control Codes    | 3-6         |
|   | — Interface Signal Lines     | 3-1         |
|   | — Interrupt Lines (8)        | 3-6         |
|   | — Interrupts                 | 3-11        |
| M | — Master Clear Line          | 3-4         |
|   | — Message Format             | 3-30        |
| N | — Negate BCD Conversion Line | 3-4         |
| O | — Operating Procedures       | 2-9         |
|   | — Operational Description    | 1-1         |
| P | — Parity Error Line          | 3-6         |
|   | — Parity Line                | 3-1         |
|   | — Poller Symbol Repertoire   | 3-36        |
|   | — Poller Translation         | 3-23        |
|   | — Poller Interface Signals   | 3-23        |

## ALPHABETICAL INDEX (CONT)

|   | <u>Subject</u>                                   | <u>Page</u> |
|---|--|-------------|
| P | — Poller Control Codes                           | 3-26        |
|   | Programming Aids                                 | 3-22        |
|   | Programming Restrictions                         | 3-22        |
| R | — Read Line                                      | 3-3         |
|   | Read Operation Initiated by a Requesting Station | 3-20        |
|   | Read Operation Initiated by the Computer         | 3-21        |
|   | Read/Write Operations                            | 3-19        |
|   | Reject Line                                      | 3-5         |
|   | Reply Line                                       | 3-4         |
| S | — Status Codes                                   | 3-7         |
|   | Status Lines (12)                                | 3-6         |
|   | Suppress Assembly/Disassembly Line               | 3-5         |
|   | Symbol Data                                      | 3-12        |
| T | — Typical Operation Sequence                     | 2-10        |
| W | — Word Formats                                   | 3-14        |
|   | Write Line                                       | 3-4         |
|   | Write Operation to a Local Display Station       | 3-21        |
|   | Write Operation to a Poller                      | 3-21        |