

Electronics®

LIBRARY
UNIVERSITY of TENN. MED. UNITS
MEMPHIS

WID 2/9/72

DEC 12 1967

Programing LSI arrays: page 90

All-transistor kilowatt amplifier: page 100

Special report, semiconductors in Japan: page 107

December 11, 1967

\$1.00

A McGraw-Hill Publication

Below: Jun-ichi Nishizawa,
pioneer in solid state, page 117





"SPECIAL" CUSTOM BUILT FILTERS

TO YOUR SPECIFICATIONS

ILLUSTRATED ARE TYPICAL SPECIAL FILTERS

RANGE OF FREQUENCIES ON SPECIAL UNITS
IS FROM 0.1 CYCLE TO 400 MC.

Over thirty years of experience in the design and production of special filters have resulted in UTC being a first source for difficult units. Present designs both military and commercial incorporate a wide variety of core structures, winding methods, and capacitors to provide maximum performance, stability, and reliability. Fully experienced, top engineering talent backed by complete environmental testing and life testing facilities assure the highest standard in the industry. Full analysis and evaluation of materials are conducted in UTC's Material and Chemical Laboratories. Rigid quality control measures coordinated with exhaustive statistical findings and latest production procedures results in the industry's highest degree of reliability.

MILITARY AND COMMERCIAL TYPES FOR EVERY PHASE OF THE ELECTRONICS ART

POWER TRANSFORMERS • AUDIO TRANSFORMERS • INDUCTORS • PULSE TRANSFORMERS • ELECTRIC WAVE FILTERS • LUMPED CONSTANT DELAY LINES • HIGH Q COILS • MAGNETIC AMPLIFIERS • SATURABLE REACTORS • REFERENCE UNITS

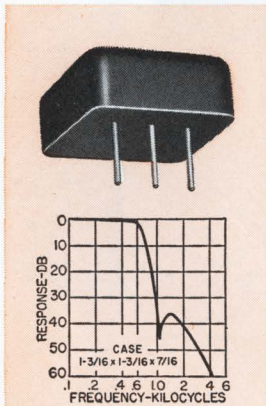

560 \sim Telemetering low pass filter. Available from 400 \sim to 70 KC. \pm 7.5% bandwidth flat to 1 db. Attenuation greater than 35 db beyond the 2nd harmonic of \sim 7.5% frequency. Impedance 47K ohms. MIL-F-18327B. Wt. 0.8 oz.

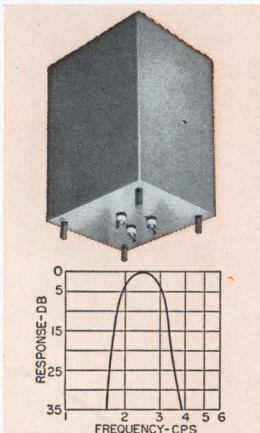

Low frequency band pass filter. Designed for 2.5 cps center frequency. At 2 to 3 cps within 3 db. At 1.5 cps and lower, and 4 cps and higher, greater than 30 db. Source and Load 10K ohms. Size: 4 x 4-11/16 x 6". MA MIL case, MIL-F-18327B.

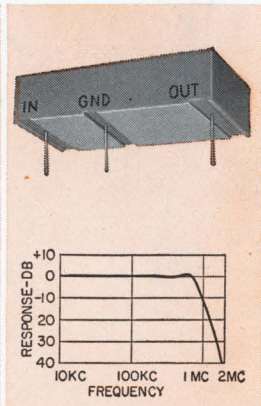

High frequency low pass filter. Zero to 700 KC within 1 db. 1.95 mc to 10 mc 40 db minimum. Source and Load 1000 ohms. Molded flat construction for printed circuit applications. Size: 1 x 2 x 1/2"; Wt: 1 oz. MIL-F-18327B.

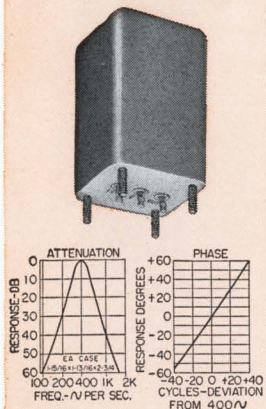

Band pass 400 cycle Gaussian filter. Linear phase response in pass band. Attenuation 380 cps to 420 cps within 0.5 db. 2nd harmonic down 25 db. 3rd harmonic down 45 db. Source and load 5K ohms. MIL-F-18327B Wt., 0.9 lbs.

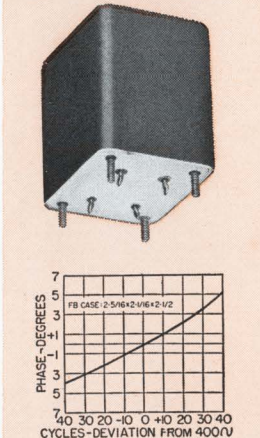

Minimum phase shift 400 cycle band pass filter. Within \pm 1.5 db 370 to 430 cycles, greater than 45 db beyond 1100 cycles. 1K ohms to 100K ohms. MIL-F-18327B; 1 lb.

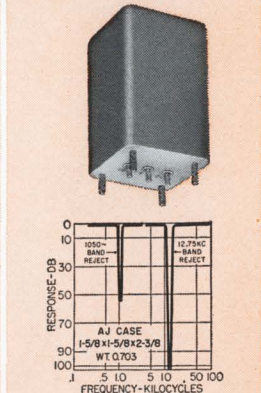

Band reject filters (two shown). The 1050 \sim filter has 50 db attenuation and is only 3 db at 950 and 1150 cycles. The 12.75 KC filter has more than 100 db attenuation and is only 3 db at 10.8 and 15 KC. Source and load 600 ohms, both are MIL-F-18327B.

Write for catalog of over
1,300 UTC TOP QUALITY
STOCK ITEMS
IMMEDIATELY AVAILABLE
from your local distributor.



UNITED TRANSFORMER CO.

DIVISION OF TRW INC. • 150 VARICK STREET, NEW YORK, N. Y. 10013
IN CANADA: A. C. SIMMONDS & SONS LIMITED, AGINCOURT, ONTARIO

FOUR DECADES IN ONE SWEEP

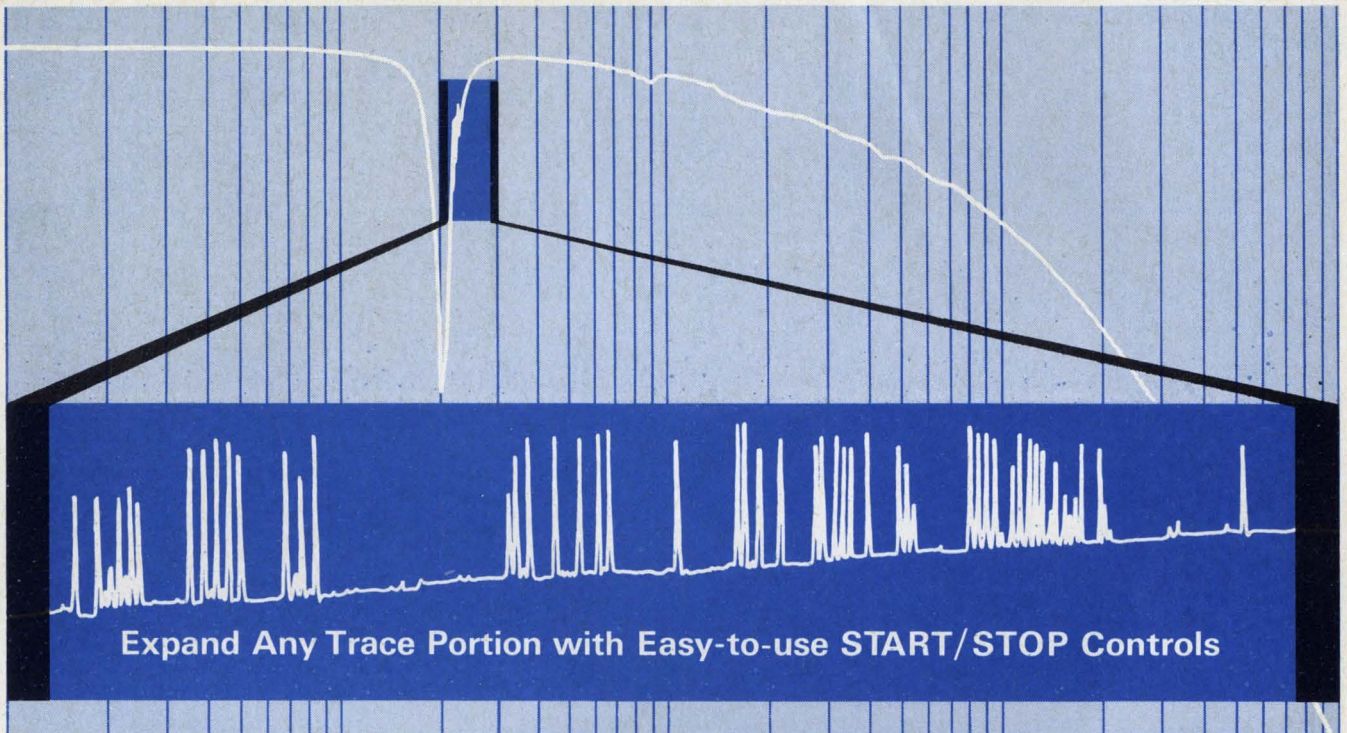

Expand Any Trace Portion with Easy-to-use START/STOP Controls

For the first time, you can sweep four decades without switching ranges. The new hp 3305A Plug-In with the hp 3300A Function Generator sweeps logarithmically in any of three ranges from 0.1 Hz to 100 kHz for narrow or wide band testing.

Easy-to-set calibrated START and STOP frequency controls establish sweep end points with $\pm 10\%$ accuracy. The manual sweep can be used for close inspection of any point on the trace. It can also be used for accurate frequency identification.

You can adjust START/STOP controls to bracket any portion of the response curve, without readjusting the X-axis of the oscilloscope or X-Y recorder.

Continuously adjustable sweep time of 0.01 sec to 100 seconds is slow enough for accurate response testing of high-Q devices and fast enough for good visual displays of wide band responses. For flicker-free viewing of slow sweeps, use the hp 141A Variable Persis-

tence Oscilloscope. The hp 7562A Logarithmic Converter can be used as a detector (narrow band sweep can have as much as 80 dB dynamic range).

For ease of automated testing, frequency can be externally programmed and the sweep trigger also externally controlled.

For the complete story on the new hp 3305A Sweep Plug-In and the hp 3300A Function Generator, call your hp field engineer. Or, write to Hewlett-Packard, Palo Alto, California 94304. Europe: 54 Route des Acacias, Geneva. Price: hp 3300A Function Generator, \$625; hp 3305A Sweep Plug-In, \$975.

097/18

HEWLETT  PACKARD
S I G N A L S O U R C E S

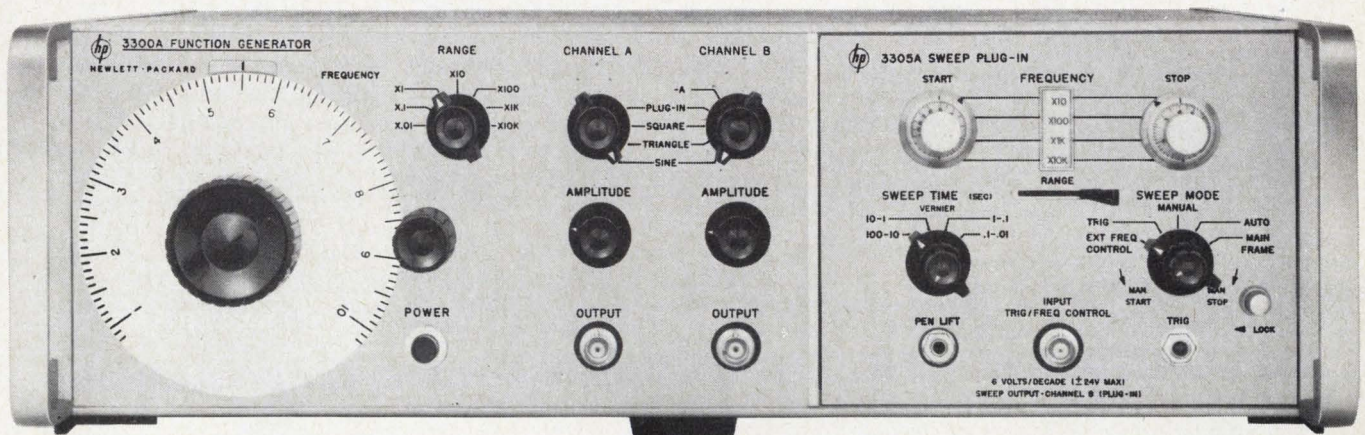

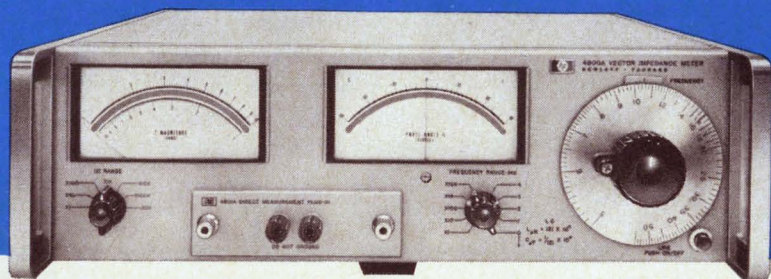
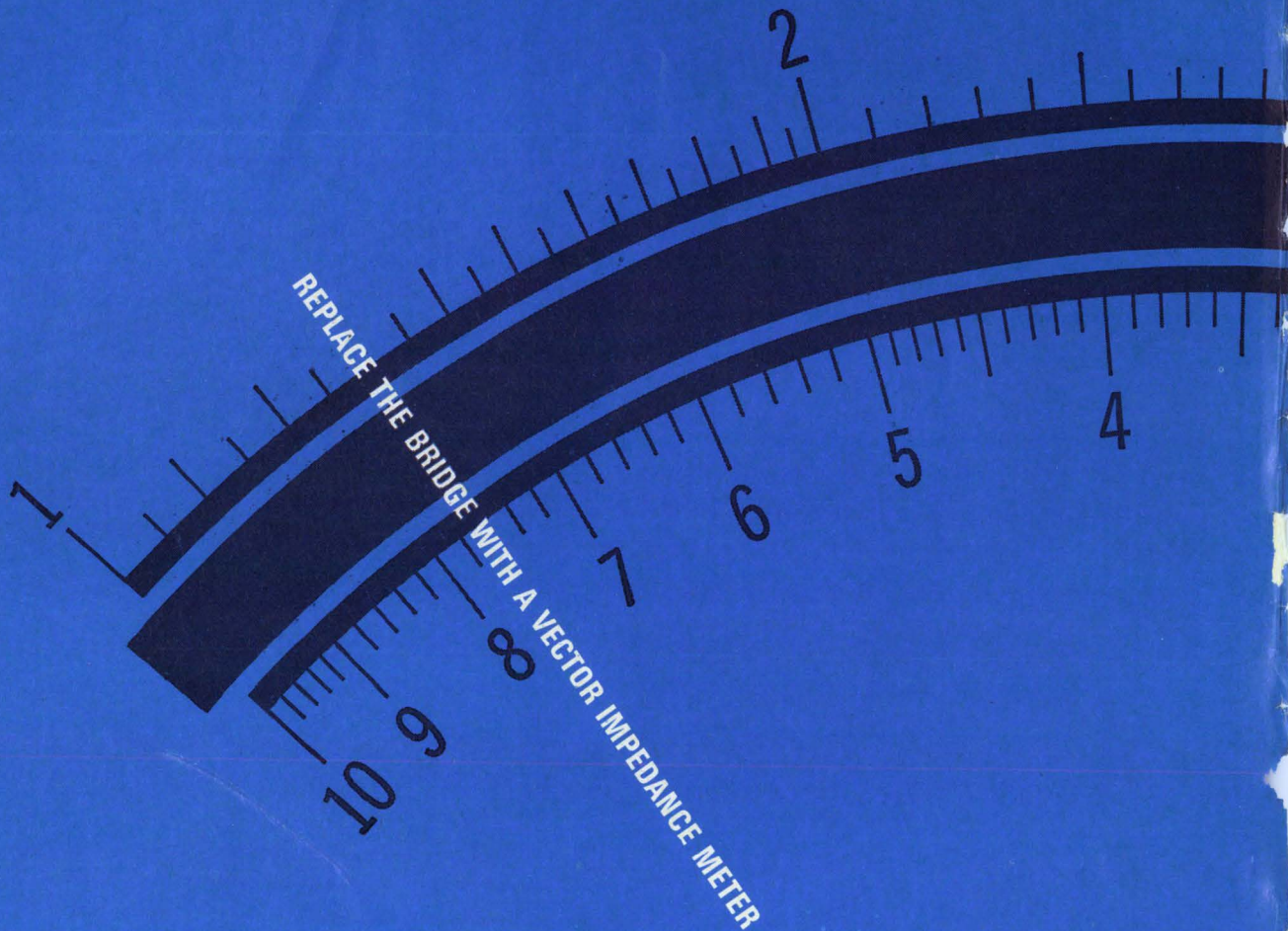

Vector Impedance Meter makes measurements in seconds

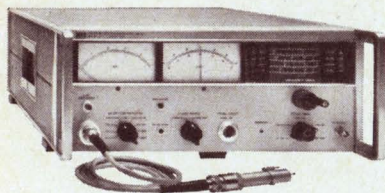

MODEL 4815A OFFERS DIRECT READOUT OF HIGH FREQUENCIES IN OPERATING CIRCUITS

The 4815A offers direct readout of impedance and phase angle measurements from 500 kHz to 108 MHz with continuous tuning. Probe on five-foot cable simplifies in-circuit measurements. Price: \$2,650.00. Complete specifications are yours on request.

Circle 2 on reader service card

Now there's no excuse for not making all the impedance measurements that previously have been too bothersome to make. The Hewlett-Packard 4800A Impedance Meter eliminates bridge balancing and nulling. It does for AC measurement what the ohmmeter does for DC testing. Just plug it in and read it. The 4800A may be mechanically swept to produce measurements over its full frequency range. You get direct readings of impedance and phase angle from 5 Hz to 500 kHz. Analog outputs of frequency, impedance and phase are available for X-Y recording.

The 4800A is an all solid-state integrated vector impedance system that reads out directly in Z and θ . Low-level signal strength prevents overloading of the test component. Price: \$1,650.00. For complete specifications, contact your local Hewlett-Packard field engineer or write: Hewlett-Packard, Green Pond Road, Rockaway, N.J. 07866.

HEWLETT  PACKARD

IMPEDANCE INSTRUMENTS

1071B

News Features

Probing the News

- 149 **Crime fighting in real time**
155 **Intelsat 3: coming or going?**
161 **Santa's helpers shun electronics**

Electronics Review

- 45 **Components: Brush off**
45 **Advanced technology: Unmasked**
47 **Medical electronics: Sound thinking**
47 **Space electronics: Band practice**
50 **Consumer electronics: Pop op amp; The quiet one**
52 **Companies: Hands across the sea**
54 **Avionics: Introspective radar**
56 **Manufacturing: Take-apart laser**
58 **Materials: Reclamation project**
60 **For the record**

Electronics Abroad

- 253 **France: A gauntlet thrown; Ahead in infrared**
254 **Japan: Around the bend; High-octane GaAs**
255 **The Netherlands: A better weigh**
256 **Great Britain: Place in the sun**
256 **West Germany: Hazy market**
259 **Sweden: Care-full computer**

New Products

- 177 **Digital voltmeter dissects waveforms**
182 **New components review**
182 **New components: Monolithic op amps show it can be done; The jig is up—down if need be**
193 **New semiconductors review**
193 **New semiconductors: UJT offers a choice; Matched FET's—a winning hand**
202 **New instruments review**
202 **New instruments: Heat can't hide from this thermocouple; Testing plated wire for memories' sake**
209 **New subassemblies review**
209 **New subassemblies: Putting the squeeze on recorded data; Making a splash with ink spray**
215 **New microwave review**
215 **New microwave: A strong case for low loss**
219 **New production equipment review**
219 **New production equipment: Side-by-side crimping; Printed circuits without etching; Low-melting solder puts call through**

Title R registered U.S. Patent Office; © copyright 1967 by McGraw-Hill Inc. All rights reserved, including the right to reproduce the contents of this publication, in whole or in part.

Technical articles

- Computers 90** **Programmable logic arrays—cheaper by the millions**
A technique makes large-scale integration feasible even for short production runs
Sven E. Wahlstrom, Stanford Research Institute
- Circuit design 96** **Designer's casebook**
▪ Multivibrator sensitivity improved by MOS FETS
▪ Magnetic resonance limits zener diode current
▪ Dividing the frequency of an oscillator by 10
▪ Symmetrical gate delivers narrow pulses
- Communications 100** **Transistors share the load in a kilowatt amplifier**
Summing the outputs of transistor modules yields the first high-power solid state amplifier
C.H. Wood Jr., A.W. Morse, and G.R. Brainerd, Westinghouse Electric Corp.
- Special Report 107** **Japanese Technology**
- 108 **Small loss of face yields big gain in semiconductors**
Japanese engineers hope to leapfrog their U.S. counterparts
- 110 **Tailoring the device to suit the need**
Development is aimed at satisfying requirements that are peculiarly Japanese
Takuya Kojima, Electrical Communications Laboratory, NTT
- 117 **Optoelectronics goes digital (cover)**
Injection lasers are arranged as high-speed logic gates
Jun-ichi Nishizawa, Tohoku University
- 125 **Gunn devices are on target—but short of a bull's-eye**
The Japanese push continuous-wave oscillators, but low power stalls commercial use
Takanori Okoshi, University of Tokyo

Departments

- | | | | |
|----|------------------------|-----|------------------------|
| 4 | Readers Comment | 46 | Index of activity |
| 8 | People | 67 | Washington Newsletter |
| 14 | Meetings | 227 | New Books |
| 16 | Meeting Preview | 234 | Technical Abstracts |
| 23 | Commentary | 240 | New Literature |
| 25 | Electronics Newsletter | 247 | Newsletter from Abroad |

Electronics

Editor-in-Chief: Lewis H. Young

Associate managing editors

Technical: Donald Christiansen
News: Robert Henkel
Copy: Sally Powell

Senior associate editors

Joseph Mittleman, Stephen E. Scrupski, Harry R. Karp

Department editors

Advanced technology: Stephen E. Scrupski
Avionics & Space: Alfred Rosenblatt
Computers: Wallace B. Riley
Communications: William Bucci
Consumer electronics: John D. Drummond
Design theory: Joseph Mittleman
Industrial electronics: Harry R. Karp
Instrumentation: Carl Moskowitz
New Products: William P. O'Brien, Stephen Fields
Solid state: Mark B. Leeds
Staff writer: Peter Schuyten

Section editors

Electronics abroad: Arthur Erikson
Electronics review: Stanley Zarowin
New Products: H. Thomas Maguire
Probing the news: Eric Aiken

Regional bureaus

Domestic

Boston: James Brinton, manager; Robin Carlson
Los Angeles: Lawrence Curran, manager; June Ranill
New York: Howard Wolff, manager
San Francisco: Walter Barney, manager
Washington: Robert Skole, manager; William D. Hickman, Paul Dickson, Patricia C. Hoehling

Foreign

Bonn: John Gosch
London: Michael Payne
Tokyo: Charles Cohen

Copy editors

James Chang, Frederick Corey

Graphic design

Art director: Saul Sussman
Assistant art directors: Ann Mella, Valerie Betz
Production editor: Arthur C. Miller

Editorial secretaries: Claire Benell, Lynn Emery, Kay Fontana, Patricia Gardner, Lorraine Longo
Barbara Razulis, Frances Vacca

McGraw-Hill News Service

Director: John Wilhelm; **Atlanta:** Fran Ridgway; **Chicago:** James Rubenstein;
Cleveland: Arthur Zimmerman; **Dallas:** Marvin Reid;
Detroit: J. Wirgo; **Houston:** Robert E. Lee; **Los Angeles:** Michael Murphy, Gerald Parkinson
Pittsburgh: Louis Gomolak
San Francisco: William F. Arnold
Seattle: Ray Bloomberg; **Washington:** Arthur L. Moore, Charles Gardner,
Herbert W. Cheshire, Seth Payne, Warren Burkett, James Canan, William Small

McGraw-Hill World News Service

Bonn: John Johnsrud; **Hong Kong:** Don Kirk; **London:** John Shinn;
Mexico City: Bruce Cross; **Milan:** Ronald Taggiasco;
Moscow: Howard Rausch; **Paris:** Peter Kilborn;
Rio de Janeiro: Wes Perry; **Tokyo:** Marvin Petal

Reprints: Susan Nugent

Circulation: Milton Drake

Publisher: Gordon Jones

Electronics: December 11, 1967, Vol. 40, No. 25

Published every other Monday by McGraw-Hill, Inc. Founder: James H. McGraw 1860-1948.
Printed at 99 North Broadway, Albany, N.Y. 12207; second class postage paid at Albany, N.Y.

Executive, editorial, circulation and advertising addresses: McGraw-Hill Building, 330 W. 42nd Street
New York, N. Y. 10036. Telephone (212) 971-3333. Teletype TWX N.Y. 710-581-4235. Cable address:
MCGRAWHILL N.Y.

Subscriptions solicited only from those professionally engaged in electronics technology. Subscription rates:
qualified subscribers in the United States and possessions and Canada, \$8.00 one year, \$12.00 two years,
\$16.00 three years; all other countries \$25.00 one year. Non-qualified subscribers in the U. S. and
possessions and Canada, \$25.00 one year; all other countries \$50.00. Air freight service to Japan \$50.00
one year. Single copies: United States and possessions and Canada, \$1.00; all other countries, \$1.75.

Officers of McGraw-Hill Publications: Joseph H. Allen, President; Bayard E. Sawyer, Executive Vice-President;
J. Elton Tuohig, Senior Vice-President-Operations; Vice Presidents: John R. Callahan, Editorial;
John M. Holden, Marketing; Paul F. Cowie, Circulation; Angelo R. Venezian, Production; Jerome D. Luntz,
Planning & Development; Robert M. Wilhelm, Controller.

Officers of the Corporation: Donald C. McGraw, Chairman of the Board; Shelton Fisher, President;
L. Keith Goodrich, Robert E. Slaughter, Executive Vice Presidents; Donald C. McGraw, Jr.,
Senior Vice-President; John J. Cooke, Vice-President & Secretary; John L. McGraw,
Vice-President & Treasurer.

Title © registered in U.S. Patent Office; © Copyright 1967 by McGraw-Hill, Inc. All rights reserved. The contents
of this publication may not be reproduced either in whole or in part without the consent of copyright owner.

Subscribers: The publisher, upon written request to our New York office from any subscriber,
agrees to refund that part of the subscription price applying to copies not yet mailed.
Please send change of address notices or complaints to Fulfillment Manager; subscription
orders to Circulation Manager, Electronics at address below. Change of address notices
should provide old as well as new address, including postal zip code number. If possible,
attach address label from recent issue. Allow one month for change to become effective.

Postmaster: Please send form 3579 to Fulfillment Manager, Electronics,
P.O. Box 430, Hightstown, New Jersey 08520

Readers Comment

No paper tigers

To the Editor:

As one who has been closely associated with the NASA technology utilization program since its inception, I question the item "NASA pushing space spin-offs" in the Washington Newsletter [Oct. 2, p. 63].

The NASA Office of Technology Utilization (not Office of Space Technology Utilization) did not issue "more than 1,000 Tech Briefs last month." Also, its normal annual output of these briefs has averaged considerably less than this number over the approximately four years since March 1964, when the first Tech Brief (B64-10001) was issued. I believe that the peak monthly issuance (with perhaps one exception) of Tech Briefs has not exceeded one-tenth of the figure quoted.

It should be realized that Tech Briefs are supposed to represent potentially useful innovations "spun-off" from the NASA space effort into specialized industrial, scientific, and commercial sectors of the general economy. The enormity of the task of screening the potential spin-off material (novel and apparently useful ideas, processes, and hardware) from the reported run-of-the-mill outpouring of the NASA multibillion R&D activities must be fully recognized. One thousand significant, publishable Tech Brief items per month, or even per year, would be rejected as a reasonable goal by knowledgeable technologists.

Established NASA space missions and expenditures can be justified objectively following systematic program reviews by the cognizant, goal-conscious technical, administrative, and legislative authorities. Pressure for "switching to a harder sell on space 'spin-offs' to shine up its (NASA's) image" by way of Tech Briefs as a subterfuge cannot have the support of informed NASA officials.

Such pressure for numbers can only lead to a serious sacrifice of standards in reporting the results of NASA's outstanding scientific and engineering efforts. NASA, like every

gates

5

nsec

flip-flops

60

MHz

**Increase your system speed.
Sprague SSL* is the fastest saturated
logic. And it's pin compatible
with series 8000.
You should call us fast.**



*For additional information on
Sprague SSL Super-Speed Logic, write to:
Semiconductor Division
Sprague Electric Company
115 Northeast Cutoff
Worcester, Mass. 01606*

*Trademark for Super-Speed Logic

SPRAGUE WORCESTER... the world's finest microcircuit facility



'Sprague' and '®' are registered trademarks of the Sprague Electric Co.

If you buy HP counters, we have news for you.

Systron-Donner makes advanced counter instrumentation that has no equivalent in the HP catalog. That's why it pays to check with Systron-Donner before you buy. You'll find equipment with unique capability like:

1. A plug-in that will extend your counter's frequency range to 15 GHz – measuring FM and pulsed RF as well as CW and AM. The only way to get the full dc to 15 GHz range in one cabinet. No calculations. Displays final answer.

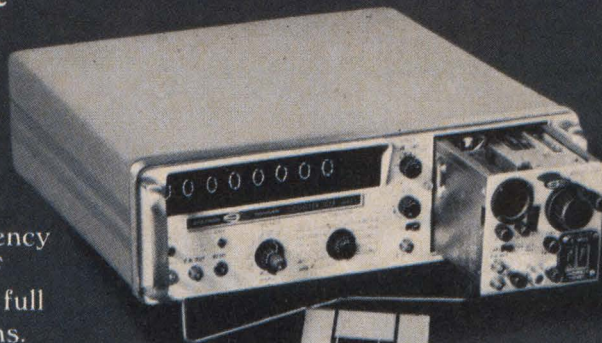

1.

3.

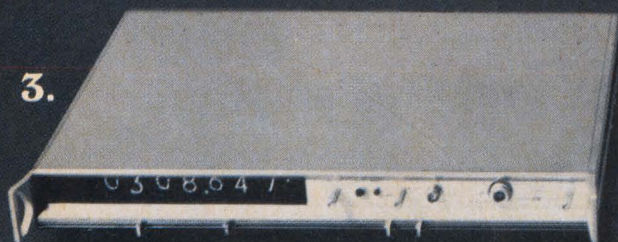

3. "Thin Line" counters that take only 1 1/4" of rack space. Built with ultra-reliable integrated circuits to give you automatic frequency measurements – dc to 100 MHz or 0.3 to 12.4 GHz.

These are the highlights of expandable systems that will make just about any measurement possible with counters. The accuracy of our basic 50 MHz and 100 MHz counters is unsurpassed. (Time base aging rate is only 5 parts in 10¹⁰ per 24 hrs.) All devices to extend the range or add functions are convenient plug-ins – not rack mounts. The newest are a prescaler to extend counter range to 350 MHz and a heterodyne converter to measure noisy signals in the 0.2 to 3 GHz range.

Are you surprised that Systron-Donner is a step ahead of HP in counter technology? How else could we stay in business?

Systron-Donner Corporation, 888 Galindo Street, Concord, California 94520

2.

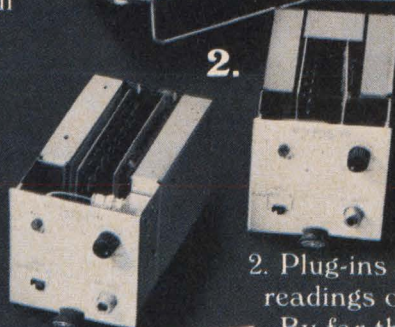

2. Plug-ins that produce automatic readings of microwave frequencies. By far the most compact and economical equipment for producing automatic readings in the 0.3 to 3 GHz band or the 3 to 12.4 GHz band.



Send for catalog.



SYSTRON  DONNER

Circle 6 on reader service card

other national agency, cannot submit to the tactics of the hard-sell advertisers, if it is to retain the respect of the American scientific and technical communities.

J. Pearlstein

Arlington, Va.

▪ NASA's goal for 1967 is 1,000 briefs. Electronics' source at NASA said "1,000 last month"—when he meant last year.

Forerunner moved to rear

To the Editor:

The article "Righter light" [Sept. 18, p. 44] implies that the potential of matched light sources as laser pumps is going to waste and that such sources cannot even be tested as laser pumps because work on them is not being supported by the Government. Your taxpaying readers may be pleased to learn that research on matched light sources for laser pumping is being given Government support and that successful demonstrations of laser pumping have already been made with these light sources.

The Army Electronics Command has supported for some time work at the Westinghouse Research Laboratories to demonstrate the efficacy of such lamps (also called "spectral additive lamps") as laser pumps. The "forerunner" shown in the photograph on page 45 of your article is actually a rear-runner; using a different lamp geometry, Westinghouse successfully demonstrated laser pumping using a spectral additive lamp over a year ago.

Further work at Westinghouse, sponsored by the Army Electronics Command, has included other successful demonstrations that additives in mercury arc discharges pro-

vide significant enhancement in laser efficiency.

Successful attempts to adapt additive spectral enhancement techniques to laser pumping have profited greatly from the extensive research and development which has recently been carried out in several large lamp manufacturing firms to develop new high efficiency sources for illumination. The major difference is that for laser pumping one desires a narrow emission in a selected spectral region from the lamp while for illumination a broad spectrum in the visible is desired.

R. D. Haun Jr.

Manager

Quantum Electronics R&D
Westinghouse Electric Corp.
Pittsburgh

Different ways home

To the Editor:

You have probably had many comments already about "Sunday pilots . . . not having vhf omni . . ." [Sept. 18, p. 266].

Most all planes that have a radio at all have omni also, and each of the two most popular radios of the past five years has a localizer built in as well.

I'm glad they have a direction finder; my question is how does it compare to the ones the FAA is using?

Walton Ferris Jr.

Palo Alto, Calif.

▪ The FAA equipment works on both uhf channels for military aircraft and vhf channels for civil aircraft. The new West German equipment handles civil aircraft only and uses monopole antenna elements rather than dipoles.

Galvanometer with brains

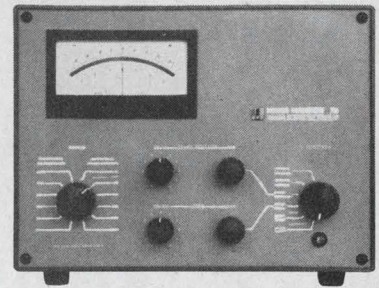

ESI has combined the best features of the classic galvanometer and the modern electronic voltmeter in the Model 900 Nanovolt Galvanometer.

How do you create a galvanometer with true nanovolt sensitivity that is really *practical* to use . . . an instrument that doesn't require hours of delicate dial twiddling, trapdoor adjustments or experimental hook-ups?

You give it brains. Brains in the form of feedback circuits that automatically control speed of response and damping for each of its 12 calibrated ranges. *Our Model 900 Nanovolt Galvanometer operates from any source resistance without changes in speed of response or damping characteristics.* Noise is less than 2 nanovolts for any source impedance.

The instrument consists of two units—the control unit shown above, which is the brains of the outfit, and a galvanometer unit. The Model 900 is ideal for use with high-accuracy and high-resolution potentiometers and bridges; for the calibration of thermo-couples, strain gauges, thermopiles, standard cells and the like. It also has applications in the measurement of tiny voltages or currents in experimental chemistry, physics, biology or medicine. A fixed input resistance of 1 kilohm allows calibrated ranges for *both* voltages and current.

Through solid state circuitry, we've been able to combine the best of two worlds in the Model 900. It has the high sensitivity and ac rejection of mechanical galvanometers. But it also has the multiple calibrated ranges, meter readout, and operation simplicity of modern electronic voltmeters. It's an honest nanovoltmeter with high sensitivity and complete guarding to simplify measurements in the microvolt area.

You'll have more time to use your own brains if your galvanometer has some of its own.

ESI, 13900 NW Science Park Dr.
Portland, Oregon 97229.

Electro Scientific Industries **esi**

SUBSCRIPTION SERVICE

Please include an Electronics Magazine address label to insure prompt service whenever you write us about your subscription.

Mail to: Fulfillment Manager
Electronics
P.O. Box 430
Hightstown, N.J. 08520

To subscribe mail this form with your payment and check new subscription renew my present subscription

Subscription rates: qualified subscribers in the U.S.: 1 year \$8; two years, \$12; three years, \$16. Non-qualified: 1 year \$25. Subscription rates for foreign countries available on request.

CHANGE OF ADDRESS

ATTACH LABEL HERE

If you are moving, please let us know five weeks before changing your address. Place magazine address label here, print your new address below.

name _____

address _____

city _____

state _____

zip code _____

Now—a solid tantalum capacitor unbeatable at 1 MHz!



Designed particularly for computer and high frequency power supply circuits, the THF has exceptional high frequency characteristics.

At 1 MHz, it has half the impedance and double the ripple current capacity of MIL-C-26655 solid tantalum capacitors.

Across the entire frequency band, capacitance change and dissipation factor are lower than standard types. Temperature stability is excellent from -80° to $+125^{\circ}\text{C}$.

Hermetically sealed construction. Available in MIL case sizes C and D, in all capacitance values, 6 through 50 volts.

For data and samples, write Mallory Capacitor Company, a division of P. R. Mallory & Co. Inc., Indianapolis, Ind. 46206.

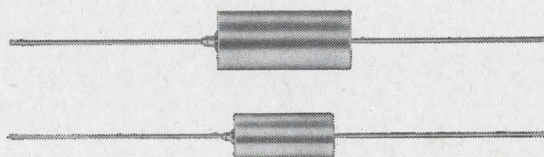

Actual Size



People

November was an important month for **Theodore H. Maiman**. First his early work with ruby lasers was recognized with a patent, some $6\frac{1}{2}$ years after it was applied for. Then he resigned as president of the Korad Corp., the Santa Monica, Calif., laser manufacturing firm he founded in 1962. Korad is being absorbed into its parent organization, the Union Carbide Corp.



Theodore Maiman

Maiman, 40, says Korad will become the laser department within Union Carbide's Electronics division about Jan. 1, and he did not want to be part of the larger corporation. He is considering several offers from universities and industry to do research work. He will also be "very seriously looking into the possibility of founding a new company."

Maiman will get no cash benefits from the laser patent, which is assigned to the Hughes Aircraft Co., where he was employed when he first made a ruby laser work in May 1960. He believes the patent award will trigger tests of the validity of a patent granted early in 1960 to Charles H. Townes and Arthur Schawlow covering optical and infrared masers. Townes was at Columbia University and Schawlow at Bell Telephone Laboratories when they developed the concept on which their patent was granted.

Made it work. The theory outlined in that patent certainly is in doubt, Maiman asserts. "Patents are supposed to contain information that can be used by a person skilled in the art to make the principles work." He maintains that no one has been able to produce a functioning laser based on the earlier patent, "and it isn't because incompetent people have been trying it."

National Semiconductor Corp., less than a year after moving West, is expanding rapidly—both in new

Performance inversely proportional to price.

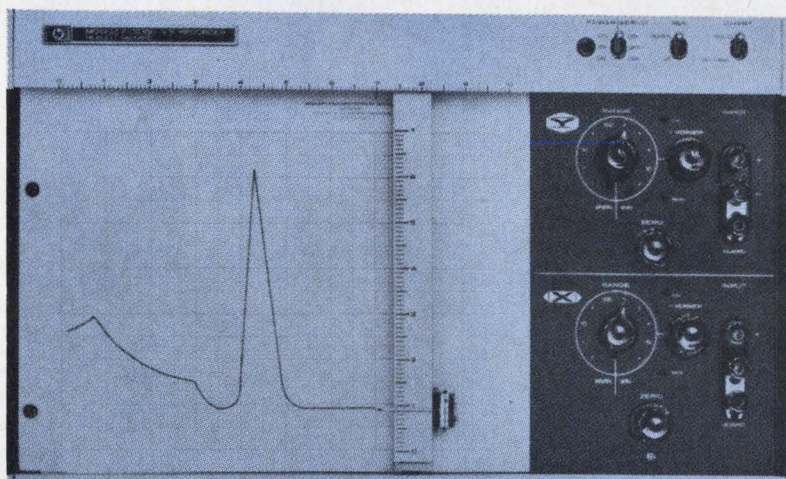

**The prices
are very low.**

No need to restrict your applications when using X-Y recorders. The new Hewlett-Packard 7035B (8½"x 11") and the 7005B (11"x 17") X-Y Recorders offer you dynamic performance better than ever before on low-cost recorders. Now applications are extended to microwave sweep testing with the same reliability and performance. These recorders have high input impedance, floating, guarded input and 0.2% accuracy at full scale. Sensitivity

from 1 mv/inch to 10 V/inch. No interaction between channels, with independent servo system for each axis, and the exclusive AUTOGRIP paper holddown reduces maintenance to occasional wiping of the surface. Bench or rack-mount. Price: 7035B, \$945; 7005B, \$1195.

For more information call your local HP field engineer or write Hewlett-Packard, Palo Alto, Calif. 94304; Europe: 54 Route des Acacias, Geneva.

HEWLETT  PACKARD
GRAPHIC RECORDERS

Do you have this new capacitor data?

People

products and manpower. Latest to join the ranks of the Santa Clara, Calif., manufacturer are **Robert A. Hirschfeld**, an expert in high-frequency linear devices, and **Thomas R. Thorkelson**, an expert in digital devices.

Hirschfeld, 27, comes from Amelco Semiconductor, a subsidiary of Teledyne Inc., and Thorkelson, 31, moves over from Texas Instruments.

Hirschfeld takes over as section head in the linear integrated-circuit department. "We're not sure yet how much we will second-source



R.A. Hirschfeld



T.R. Thorkelson

or originate," he says, "but we're committing ourselves to the communications circuit business."

Says Hirschfeld: "The state of the market is such that there is little other than radio- and intermediate-frequency amplifiers. The state of the art, however, is far more advanced." He will investigate circuit functions and change a number of them. For example, he thinks there may be better ways to perform those now done by transistors.

It is but isn't. Thorkelson is now in product marketing, managing the transistor-transistor-logic (TTL) line. For now, he points out, "we've accepted a second-source position with TTL, but we have some devices coming up that Texas Instruments doesn't have." Says Thorkelson: "We want to present an image of similarity." National's DM7501, for example, resembles TI's 5473 except that its construction is monolithic, its guaranteed clock skew is 15 nanoseconds instead of 10, and it is sealed hermetically.

Thorkelson says National is developing an interface circuit between semiconductor and TTL levels.

DIPPED MICAS . . . for entertainment and commercial equipment

Single-film silvered-mica capacitors cost less than stacked mica or ceramic types. These capacitors are rated at 300 WVDC and have good stability and retrace characteristics over their operating temperature range of -55°C to $+85^{\circ}\text{C}$. Capacitance values from 10 to 360 pF, $\pm 5\%$ are available. Put this quality and performance into your next design. Ask for Engineering Bulletin 1010.

CIRCLE READER SERVICE NUMBER 506

SPARK GAPS and GAP CAPACITORS . . . for TV tube protection

Spark gaps and gap capacitors suppress transient voltage surges and protect your expensive picture tube and allied circuitry. Spark gaps are available in 1.5 kV and 2.5 kV ratings with less than .75 pF capacitance. The gap capacitor is an air gap in parallel with a .01 μF disc capacitor. All Sprague spark gaps and gap capacitors are 100% tested to insure your circuitry. Use them to protect your picture tube warranty. Ask for Engineering Bulletin 6145.

CIRCLE READER SERVICE NUMBER 507

DISC CERAMICS . . . for general, temperature-compensating, and low-voltage applications in industrial, commercial, and consumer equipment

Cera-mite® general application discs for bypass and coupling at low cost. Nine disc sizes from .300 to .875 inches have 100, 250, 500, and 1000 WVDC ratings, in standard or temperature-stable formulations. Dual-section discs have up to .022 μF @ 1000 V. Ask for Engineering Bulletin 6101D.

CIRCLE READER SERVICE NUMBER 508

Cera-mite temperature-compensating discs for controlled capacitance change with temperature in R-F oscillators, precision amplifiers, timing circuits, other critical applications. Select from ten linear temperature coefficients from NPO to N2200. Capacitance values from 1 to 2200 pF with 1000 WVDC ratings are available, plus popular values at 3000, 4000, and 5000 WVDC for TV yoke circuits. Mini-fied units in 250 WVDC ratings may be obtained with capacitance values ranging from 22 to 990 pF. Ask for Engineering Bulletin 6102B.

CIRCLE READER SERVICE NUMBER 509

Hypercon® ultra-high capacitance discs for low-voltage circuits. Replace electrolytics with non-polar Hypercon capacitors only a fraction as large. The 2.2 μF , 3 volt disc has a diameter of .875 inches; the 0.1 μF , 25 volt unit measures .750 inches. Ask for Engineering Bulletin 6141F.

CIRCLE READER SERVICE NUMBER 510

For bulletins in which you are interested, write
Technical Literature Service, Sprague Electric Co.,
35 Marshall St., North Adams, Mass. 01247

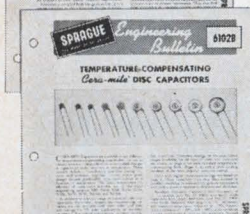

SPRAGUE COMPONENTS

CAPACITORS
TRANSISTORS
RESISTORS
INTEGRATED CIRCUITS
THIN-FILM MICROCIRCUITS
INTERFERENCE FILTERS

PACKAGED COMPONENT ASSEMBLIES
FUNCTIONAL DIGITAL CIRCUITS
MAGNETIC COMPONENTS
PULSE TRANSFORMERS
CERAMIC-BASE PRINTED NETWORKS
PULSE-FORMING NETWORKS



Sprague and *®* are registered trademarks of the Sprague Electric Co.



AT VOA-GREENVILLE, N.C., MACHLETT ML-7482 VAPOR COOLED TRANSMITTING TUBES HAVE JUST LOGGED 645,000 HOURS.

Where dependable, high power counts—
as at the Voice of America's 4.8
megawatt Greenville, N. C., relay station—
specify Machlett transmitting tubes.

Available now: the new short form
catalog from The Machlett Laboratories,
Inc., 1063 Hope Street, Stamford,
Conn. 06907.

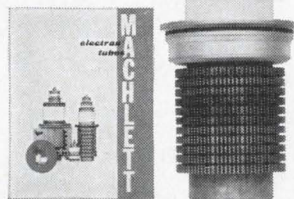

RAYTHEON

THE MACHLETT LABORATORIES, INC.

A SUBSIDIARY OF RAYTHEON COMPANY

Win \$1,000



 Hint No. 1
"It was a very good year"
for MOTOROLA
Integrated Circuits

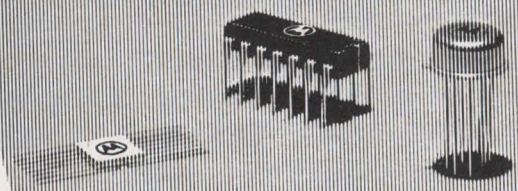

-where the priceless ingredient is care!



In Motorola's "It was a very good year" Integrated Circuits Contest

Here's your chance to win \$1,000 cash. And, it's almost as easy as writing your own name! Simply fill out the coupon below with your best guesses of the number of standard integrated circuits Motorola has formally introduced this year through its franchised distributors, in each linear and logic family.

HERE ARE SOME ADDITIONAL HINTS TO HELP YOU WIN \$1,000

- As of October 31, Motorola has introduced 11 new MDTL logic circuits this year. More to come!
- As of November 30, Motorola has introduced 18 MECL integrated logic circuits. Still more on the way!
- Motorola has introduced 15 MTTL integrated logic circuits as of November 15 — and still more coming!

The entry that provides the exact or most nearly exact figures for each circuit category, and the resulting correct grand total, will be declared the winner. In case of ties, the Grand Prize will be divided equally among the winners. (Decision of the Motorola judges will be final, of course.)

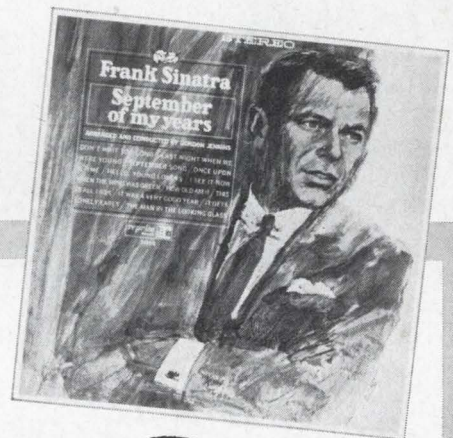

I think that Motorola will have introduced the following numbers of new integrated circuits during the past year:

Circuit Family	Number of Circuits:	Circuit Family	Number of Circuits:
MDTL (diode-transistor logic)	_____	MHTL (high-threshold logic)	_____
MRTL (resistor-transistor logic)	_____	I/C Operational Amplifiers	_____
MTTL (transistor-transistor logic)	_____	I/C Diff./Sense Amplifiers	_____
MECL (emitter-coupled logic)	_____	I/C Video, RF & IF Amplifiers	_____

GRAND TOTAL.....

NAME _____ TITLE _____
 COMPANY _____ DIV/DEPT _____
 ADDRESS _____
 CITY _____ STATE _____ ZIP CODE _____

Bonus Prizes

Everyone who guesses the correct grand total (even though the individual circuit categories may be inaccurate) will receive a copy of the Frank Sinatra stereo album, that features "It Was a Very Good Year." So, enter your guesses now (one per entrant, please) . . . just make sure that your entry is postmarked no later than December 23, 1967. Winning totals will be announced after the contest closes.

MOTOROLA Semiconductors

P. O. BOX 955, PHOENIX, ARIZONA 85001

Employees of Motorola Semiconductor Products Inc. and Motorola Inc., Semiconductor Products division, and its distributors are not eligible. Contest is void where prohibited by law or by participant's company policy.

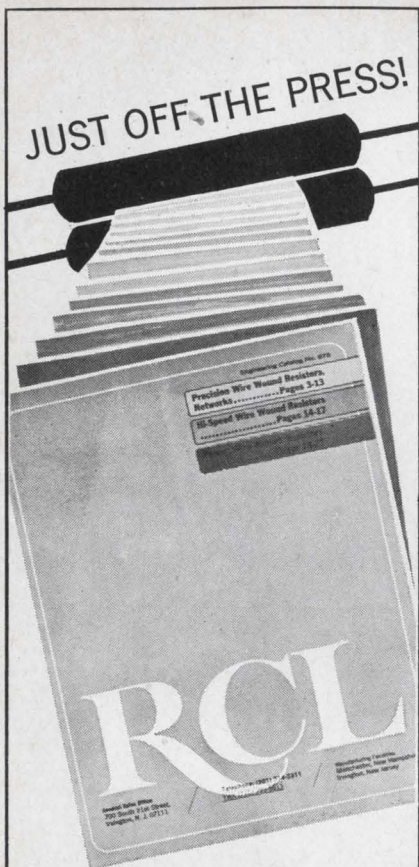

JUST OFF THE PRESS!

RCL's NEW RESISTOR CATALOG

the industry's most extensive and most accurate compilation of engineering information on wire-wound resistors

PRECISION/HI-SPEED POWER/WIRE-WOUND RESISTORS

including: beryllium oxide core power resistors . . . 22 special temperature coefficients from -50 PPM to $+6000$ PPM . . . sub-miniature precision resistors . . . ladder and summing networks.

Write for your free copy today!

RCL

ELECTRONICS, INC.
700 South 21st Street
Irvington, New Jersey 07111

Meetings

Symposium on Reliability, IEEE; Sheraton-Boston Hotel, Boston, Jan. 16-18.

Power Meeting, IEEE; Statler-Hilton Hotel, New York, Jan. 28-Feb. 2.

Aerospace and Electronic Systems Convention, IEEE; International Hotel, Los Angeles, Feb. 13-15.*

International Solid-State Circuits Conference, IEEE; Sheraton Hotel, Philadelphia, Feb. 14-16.

Scintillation and Semiconductor Counter Symposium, IEEE; Shoreham Hotel, Washington, Feb. 28-March 1.

International Convention and Exhibition, IEEE; New York Coliseum and New York Hilton Hotel, New York, March 18-21.

Symposium on Microwave Power, International Microwave Power Institute; Statler Hilton Hotel, New York, March 21-23.

Joint Railroad Conference, IEEE; Conrad Hilton Hotel, Chicago, March 27-28.

International Magnetics Conference, IEEE; Sheraton Park Hotel, Washington, April 3-5.

Business Aircraft Meeting and Engineering Display, Society of Automotive Engineers; Broadview Hotel, Wichita, Kan., April 3-5.

Telemetry Conference, IEEE; Shamrock Hilton Hotel, Houston, April 9-11.

International Pulse Symposium, International Federation of Automatic Control; Budapest, Hungary, April 9-11.

Symposium on Law Enforcement Science and Technology, Illinois Institute of Technology Research; Chicago, April 16-18.

Southwestern Conference and Exhibition, IEEE; Sheraton Lincoln Hotel, Houston, April 17-19.

Frequency Control Symposium, U.S. Army Electronics Command; Shelburne Hotel, Atlantic City, N.J., April 22-24.

Region III Meeting, IEEE; Fontainebleau Motor Hotel, New Orleans, April 22-24.

Relay Conference, National Association of Relay Manufacturers and School of Electrical Engineering, Oklahoma State University; Stillwater, Okla., April 23-24.

Short Courses

Data communications, American University's Center for Technology and Administration, Washington, Feb. 5-8; \$175 fee.

Precision and accuracy in measurements and calibration, Department of Commerce, National Bureau of Standards, Washington, Feb. 12-15; \$100 fee.

Electronic circuit design by computers, National Electronics Conference, Pleasant Run Lodge, St. Charles, Ill., Feb. 19-21; \$375 fee.

Call for papers

Microelectronic Packaging and Interconnection Conference, Society of Automotive Engineers; Rickey's Hyatt House Hotel, Palo Alto, Calif., Nov. 20-22. **Dec. 29** is deadline for submission of abstracts to D.H. O'Neill, Society of Automotive Engineers, 485 Lexington Ave., New York 10017

Meeting of the Avionics Panel of the Advisory Group for Aerospace Research and Development on Techniques for Data Handling in Tactical Systems, Avionics Panel of the Advisory Group for Aerospace Research and Development; Amsterdam, Netherlands, Sept. 1968. **March 1** is deadline for submission of abstracts to Dr. Irving J. Gabelman, program manager, Advanced Studies Group, RADC (EMD) Griffiss AFB, N.Y. 13440

Association for Computing Machinery Conference and Exposition, Association for Computing Machinery; Las Vegas, Aug. 27-29. **March 1** is deadline for submission of papers to Marvin W. Ehlers, program chairman, Ehlers, Maremont & Co., Inc., 57 West Grand Ave., Chicago. 60610

* Meeting preview on page 16.

THE connector THING

A periodical periodical designed to further the sales of Microdot Inc. connectors and cables. Published entirely in the interest of profit.

Everybody wins! Play Microdot Historical

In the words of Virginia Woolf, it's time for fun and games.

For this new national pastime, you simply need a smattering of history, mythology and current events. And some information about Microdot's cable products. We'll supply you with the latter. For the rest, go listen to Walter Cronkite.

We got started on this activity while we were sitting around one evening with a bottle of Slivovitz (we ran out of Scotch), trying to think of memorable ways to remind you of the various unique features of Microdot cables. Like —

Like our Mini-Noise cable — reduces noise voltage from shock and vibration by a factor of more than 100 to 1 compared to untreated cable. This makes possible the transmission of extremely faint signals through coax cable without audio frequency noise. Off-the-shelf.

Like our microminiature coax cable — uses a fine silver-plated copper steel-covered wire. You get 50 ohm impedance, and even with the addition of dielectric, outer shield and protective jacket, the nominal O.D. does not exceed .080". And we can get that O.D. down to .025" in a range of hundreds of different cables.

Like our new complete in-house capability to produce precision quality multi-conductor cables, which includes twisting, extruding, shielding and jacketing — the whole deal. All under one roof. And we can cable hundreds of conductors into one unit.

Like we're the only one to produce a high temperature, low weight, low capacitance coax cable through the use of a cellular Teflon dielectric. Especially suited to the requirements of video tape recorders.

Like Microdot's Twinaxial cable — to be used when you need to send two signals from a single source which must both terminate at the same point. No need to use two coax cables; therefore lower cost and greater flexibility.

Now when you think of cables, you think of cablegrams. And when you drink a lot of Slivovitz, it sort of takes you back through time and you come up with stuff like this:



Low noise Spaghetti-Gram:

"You lose. Signed, Calvin Coolidge!"

High temperature Spaghetti-Gram:

"Julius, honey, ain't nobody home tonight but me. Signed, Cleopatra!"

Miniature size Spaghetti-Gram:

"Cancel that order for bras. Signed, Twiggy!"

Dual shield Spaghetti-Gram:

"I can lick any guy in the joint. Signed, Brunhilde!"

Large size multiconductor Spaghetti-Gram:

"Send more elephants. Signed, Hannibal!"

Get the idea. You can use any of the features of any of our cable products, such as low noise (Mini-Noise), special requirements (Multiconductors), high temperature, low weight, and, of course, small size. You don't really need the Slivovitz. It works well even with Sanka.

About the fork

No, Melvin, we won't explain the relationship between cable and spaghetti. We call

it a cable fork, and if you don't want to use it for eating cables that's your problem. The manufacturer describes this

handy gadget as a "revolutionary breakthrough that leaps forward from antiquated hand labor to the modern machine age!" We won't try to top that. We'll just explain that you stick it into the pasta and then turn the little handle to save getting spaghetti all over your celluloid collar.

Want one for your very own? Okay. Just send us a Microdot Spaghetti-Gram scribbled on company stationery and taking off from any of the product features we've discussed. We'll send you a beautiful cable fork along with more literature on our cable products than we care to mention.

But hurry. We've already run out of Slivovitz. It won't be long before we run out of cable forks. (That means offer is limited.)

But hurry. We've already run out of Slivovitz. It won't be long before we run out of cable forks. (That means offer is limited.)



MICRODOT INC.
220 Pasadena Avenue
South Pasadena, Calif. 91030.

Mini-Noise is a registered trade-mark of Microdot Inc. Cable Fork is open to question.

Computers and automata

Computers and communications will get the lion's share of attention at the ninth annual Winter Convention on Aerospace and Electronic Systems (Wincon) Feb. 13 to 15 at the International Hotel in Los Angeles. There will be three sessions on computers, including the Von Neumann general panel session, which will be chaired by Eugene Fubini, a vice president of the International Business Machines.

Theme of the Von Neumann session is Automata—Their Past, Present and Potential. Arthur W. Burks, chairman of the communications sciences department at the University of Michigan, will discuss self-reproducing automata, taking a philosophical look at future approaches to computer design that will produce machines at least as complex as the computer itself. Today's machines produce outputs substantially less complex than the machines. Herman H. Goldstine, director of scientific development at IBM's Data Processing division, will analyze what must be done to make computers less susceptible to shutdown when component failures occur. Herbert Simon, a professor at Carnegie-Mellon University, will discuss artificial intelligence.

Two other computer sessions will deal with future trends, one from the producer's point of view and the other from the user's.

In one of two unclassified communications sessions, Sigmund Reiger, a vice president of the Communications Satellite Corp., will discuss traffic projections and distribution of anticipated international service through 1975, covering both satellite and cable-transmission techniques. As part of the same session, CBS Laboratories engineer James Parker will consider advances in technology needed to meet increasing communications demands.

Another unclassified communications session will focus on projected technology, including wideband cable systems, digital communications techniques, direct broadcast satellites, and urban communications systems.

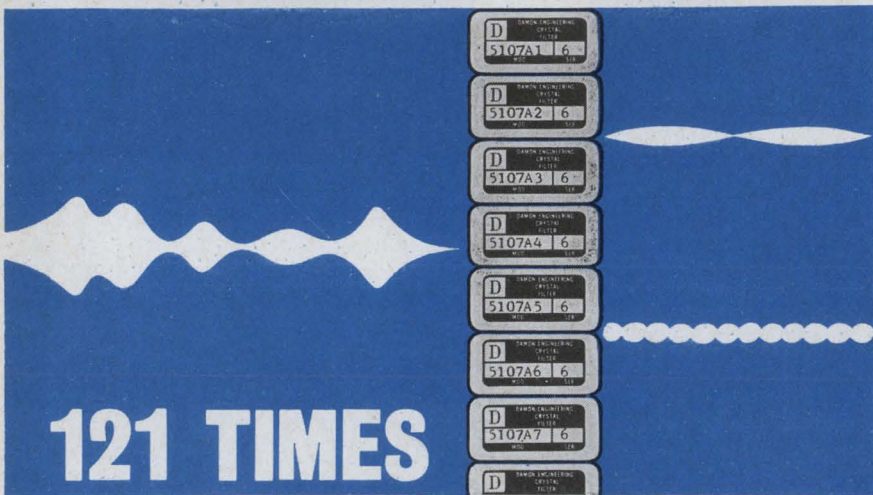
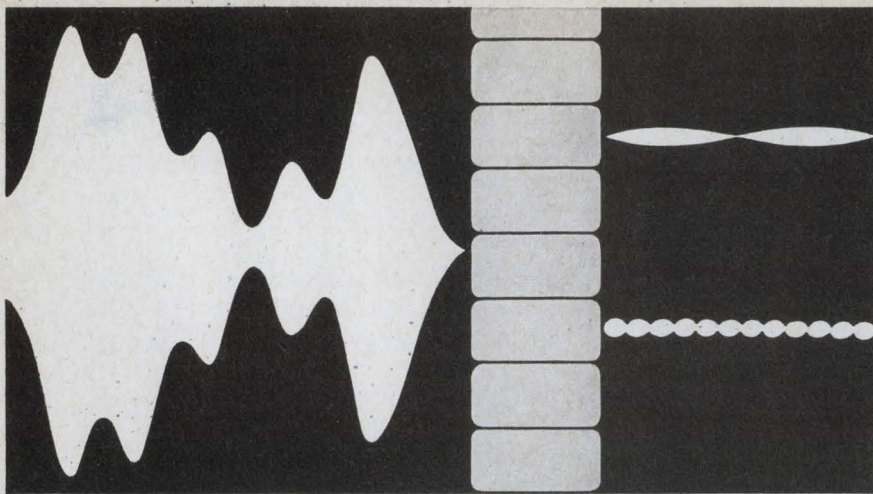

**121 TIMES
LESS DRIVE
POWER**
with Contiguous Comb
Filter Sets
by Damon



Typical Contiguous Comb Crystal Filter, Model 5107A is 1 1/16" L x 3/16" W x 7/8" H.

Damon has produced a bank of 200 contiguous comb crystal filters that requires a total of 6.6 watts of drive power to obtain 10 milliwatts from each of the Gaussian (non-overshoot) response filters. This is only 1/121 of the 800 watts of drive power normally required to achieve the same output using conventional resistive padding techniques.

This significant achievement is the result of two advances in crystal filter technology: high efficiency contiguous comb crystal filters combined with new synthesis techniques. These advances permit the adherence to both frequency and time response specifications and offer a

new concept in the design of radar and other spectrum-based systems. Contiguous comb crystal filter banks are also the most reliable, efficient, compact and economical precision systems available for multichannel signal processing of all kinds.

Write for data on Gaussian Response Contiguous Comb Crystal Filters to Damon Engineering, Inc., Needham Heights, Mass. 02194, Tel. (617) 449-0800.

DAMON



115V
NL

100V
NL

100V
FL

130V
FL

130V
NL

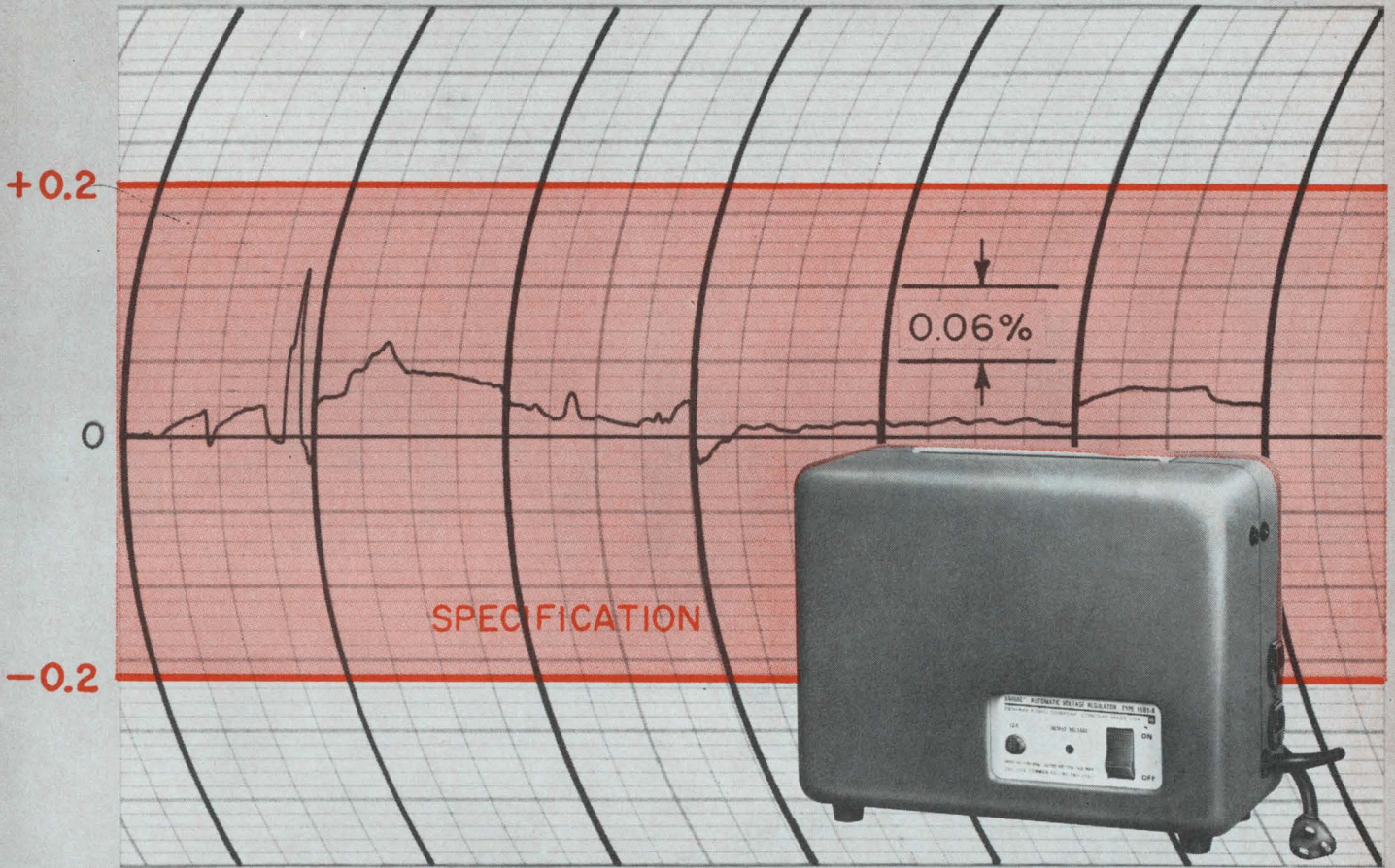

1591 Variac® Automatic Voltage Regulator, \$295 in U.S.A. (115 V)

NOW... a low-cost line-voltage regulator for every bench ... for every rack

High performance, proven reliability, small size, and low cost are the key words that identify GR's new 1-kVA line-voltage regulator.

By performance we mean that this regulator will maintain a 115-volt output (adjustable from 105 to 125 volts) within ± 0.2 percent for *simultaneous variations* of: input-line voltage from 100 to 130 volts, load from no load to full load, power factor from 1.0 to 0 leading or lagging, and line frequency over a range of $\pm 10\%$.

By reliability we mean continued high performance even under conditions far worse than those any regulator is likely to encounter in actual use. The tests indicated on the above chart were performed on a randomly selected unit that had already been subjected to a one-year, round-the-clock life test plus an accelerated life test in which the input signal was modulated at a 3.5-hertz rate. At the time this recording was made, the motor-gear train, Variac® autotransformer, and control circuitry had been subjected to 10 million oscillations

while operating at nearly full-load rating. No lubrication or adjustments were required.

By small size we mean $12\frac{3}{4} \times 9\frac{1}{2} \times 5\frac{3}{8}$ inches and a weight of 17 pounds for the portable model.

By low cost we mean a price of \$295 for a single portable model; rack and 230-volt models are slightly higher. Quantity discounts are available for all models.

Because there is no distortion added to the input waveform, average and peak voltage values are held as constant as the rms value. Response time is 6 cycles + 1.5 cycles per volt under worst conditions for the 115-volt model.

For complete information, write General Radio Company, W. Concord, Mass. 01781; telephone (617) 369-4400; TWX (710) 347-1051.



GENERAL RADIO

Circle 17 on reader service card

nobody else,

that's who

delivers all these epoxies.

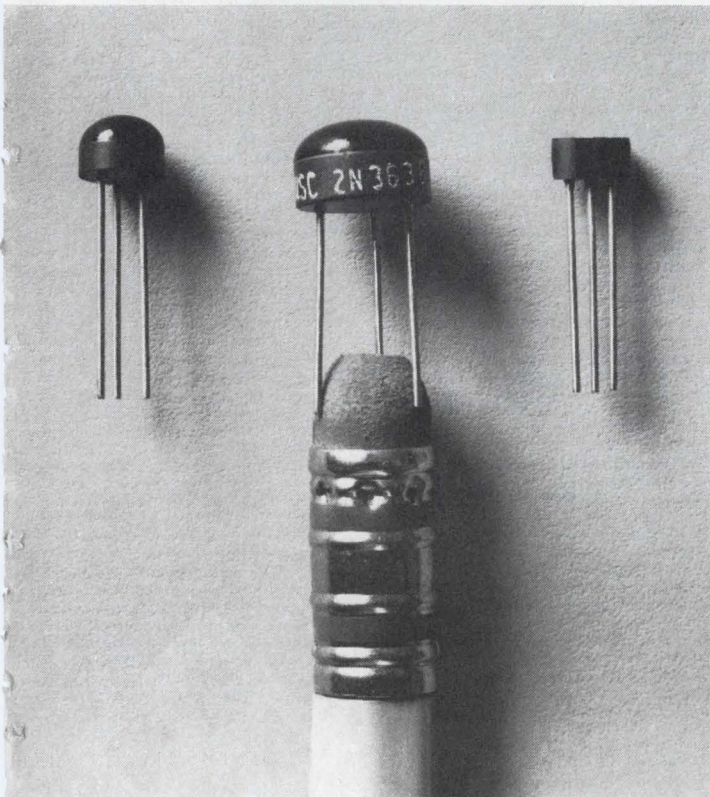

TO-105, TO-106, or In-Line. We make them all. From us, you get what you *need*, not just what we have to offer. Choose from over 100 different small signal, medium-power silicon transistors, either NPN or PNP.

So why waste a lot of time skipping between company A which offers only one epoxy package and company B or C which only makes one or two other types?

We're big in the epoxy business and getting bigger, but who knows it. Write for data and distributor list, then tell your friends.

National Semiconductor Corporation, 2975 San Ysidro Way, Santa Clara, California 95051 (408) 245-4320.

National Semiconductor

First...



TYPE SMDH 0 - 50 MHz

PROGRAMMABLE DECADE RF SIGNAL GENERATOR (FREQUENCY SYNTHESIZER)



First With Commercial Frequency Synthesizer First With True UHF Synthesizer (0.47-1.0 GHz) **NOW, FIRST WITH PROGRAMMABLE RF SIGNAL GENERATOR**

In 1954 Rohde & Schwarz introduced a new type of signal source, continuously variable in frequency but with crystal stability. We called it the Type XUA Frequency Synthesizer. Hundreds of these instruments found homes in leading laboratories and production centers throughout the U.S.A. Most of them are still fully on the job. Since then we have developed 15 other models, including a complete series of Exciters for communications control of transmitters and high quality receivers.

We now take great pride in announcing our **Type SMDH**, an instrument which sets new standards of performance. This unit is more than just another synthesizer; it is a Programmable RF Signal Generator from 0-50 MHz. It provides variable calibrated output voltages (0.1 μ V-2.5V), modulation capability (AM & FM), and excellent stability (1 x 10⁻⁹/day). Since many applications of a synthesizer involve frequency multiplication, we have designed the Type SMDH to have the highest spectral purity -- 100 dB. To achieve this, a completely new method of internal shielding had to be developed. Also a new modular frequency standard was required with 130 dB signal/noise.

To meet the demands of automatic check-out systems and high speed production testing, we made the instrument programmable. Using a standard 10-line code, we can provide a new frequency in 100 μ s maximum time. We can actually "switch" frequencies in 20 μ s like other synthesizers; however, let's make an honest appraisal. In addition to switching the digits, there is time required for the command (the old frequency is still on during the command time), and filter recovery time to assure full spectral purity. This is true for any synthesizer. Also we've designed a Programmable Attenuator, Type DPHP, with a range of 0-99.9 dB using the 10-line code. You can now have the capability of both programmable frequency and level.

Another important feature is our eight digit, in-line display tube readout. Remember when industry abandoned the hard-to-read staggered column readout on counters? Our readout is operative even in the programming mode. This feature provides a visual check, verifying the program. It spots any operator or equipment error. Switch from program to manual control with a program still on the line without any ambiguity in output frequency. Careful elimination of ground loops makes this possible.

We do not utilize phase locked loops which impair short term stability. Our reference holds $\pm 3 \times 10^{-11}$ /second. Included is an interpolation oscillator which can be used for search applications (continuously variable to 1.1 MHz) or as a vernier to the crystal digit decades. It provides an in-line numeric read-out from 0-111 with an additional 50 division vernier. Typical stability is one-half division on the vernier scale. Another feature is switchable automatic leveling to 0.5 dB. Type SMDH is all-silicon solid state design utilizing modular construction for easy servicing. An optional battery supply is available. Yet with all of the features of this Programmable RF Signal Generator, it is competitively priced with 50 MHz synthesizers.

For communication applications, our new No. 280 Programmable Exciter incorporates those specifications and features required for transmitter and receiver control, with the price savings passed on to the customer.

R & S maintains its philosophy of a well-balanced design — meaning the optimizing of all significant specifications. Judging from advertising, it appears that everyone is making frequency synthesizers today. But really good synthesizer design is a very tricky business. We should know; we've been designing them for 15 years — and after all, Rohde & Schwarz is still the leader. We're trying to maintain a stock position for immediate delivery, but with all its features and specifications we expect a heavy demand.

ROHDE & SCHWARZ
111 LEXINGTON AVENUE, PASSAIC, N. J. 07055 • 201 - 773-8010

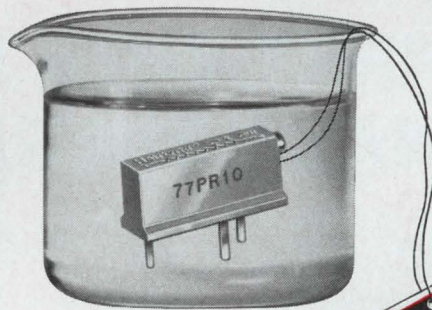

Inquiries outside the U.S.A. should be made to: Rohde & Schwarz, Muehldorfstrasse 15, Munchen 8, West Germany

Designed Sealed Delivered



Helipot's New Model 77P Cermet Trimming Potentiometer

Here's the new Model 77P, the first low-cost, general purpose trimmer with a sealed housing and cermet resistance element! DESIGNED to wider performance parameters than any other adjustment potentiometer in its price range. It is directly interchangeable with competitive Models 3067 and 3068—SEALED to permit p.c. board solvent cleaning and potting without trimmer contamination or failure—DELIVERED from local stock at the low list price of \$1.95. In large quantities, Model 77P sells for as little as \$1.10. ■ Compare Model 77P specifications with those of unsealed trimmers, then call your local Helipot representative for an evaluation sample.

	 Helitrim Model 77P	 Model 3067 Wirewound	 Model 3068 Carbon
Resistance Range, ohms	10 - 2 meg	50 - 20K	20K - 1 meg
Resolution	Essentially Infinite	1.7 (100) to 0.3 (20K)	Essentially Infinite
Sealing	Yes	No	No
Power Rating, watts	0.75	0.5	0.2
Maximum Operating Temp. °C	105	85	85

Beckman®

INSTRUMENTS, INC.

HELIPOT DIVISION

FULLERTON, CALIFORNIA • 92634

INTERNATIONAL SUBSIDIARIES: GENEVA; MUNICH; GLENROTHES, SCOTLAND; TOKYO; PARIS; CAPETOWN; LONDON; MEXICO CITY

Commentary

Nippon at our heels

The semiconductor is the essential ingredient of Japan's electronics business. Many Japanese believe, and probably rightly, that their country would not occupy second place in world electronics activity—behind the U.S.—if it weren't for the quick acceptance of the transistor by Japanese engineers in the early 1950's.

So semiconductor technology has become the most important concern of Japanese electronics firms, and a look at progress in that technology supplies a tip to what's happening with Japanese companies and products. The special report on page 107 shows that the Japanese are picking their R&D projects carefully to augment their already considerable strengths with new discrete, optoelectronic, and bulk-effect devices.

There's a lot to be learned from what the Japanese are doing. Although they still build on others' basic technology, most notably American, they tend to add unique twists to processing and design and are particularly ingenious in finding new applications. They are adept at spotting strategic gaps in product lines.

In fact, the Japanese start in semiconductors can be traced back to that unusual ingenuity. When U.S. engineers were applying transistors only to computers and military gear, it was the Japanese who first saw the potential of transistorized consumer products. They started the transistor-radio craze and used solid state devices in phonographs, television sets and tape recorders.

The Japanese remain a force to be reckoned with in the consumer products field, and they are also building an impressive record in the area of solid state communications. The communications networks growing throughout Asia bear a clearly identifiable made-in-Japan look.

Many U.S. companies are envious of the integrated structure Japanese industry enjoys, a structure that would send the Justice Department rushing to courtrooms if it were copied here. The key is that every firm in Japan knows a lot about what everybody else is doing in fundamental research (though production techniques are pro-

prietary and are closely guarded).

The ubiquitous Ministry of International Trade and Industry (MITI) maintains close scrutiny over research and development, frowning on duplication of projects.

Japanese financial resources are skimpy—most companies are financed by bank debt rather than stockholders' equity—and if the management of a company doesn't discourage duplication of research efforts, MITI will step in. Through government laboratories it operates and universities, the agency keeps tabs on what every company is doing. It helps parcel out research projects and encourages many of them even though paying only a small percentage of the cost.

Since many equipment companies are also semiconductor producers, the engineers who design and produce semiconductors for these firms work within the same corporate structure as do the engineers designing the end products. Top management pressures these engineers to exchange information, and equipment designers who tend to be more conservative than semiconductor engineers, aren't allowed to hold up the adoption of new devices.

Since the managements of most Japanese companies still view their research laboratories as incubators for new products, most of what American engineers would call pure research takes place at Japanese universities.

So, for a comprehensive report on work in optoelectronics, the place to go is Tohoku University in Sendai [p. 117]; advanced communications research has top priority at Tokyo University, and what's happening in Japan with Gunn and other bulk-effect devices is learned quickest from the school's researchers [p. 125]; and for a rundown on more prosaic devices, particularly those designed for high-frequency communications applications, the place to go is the Electrical Communications Laboratory of the Nippon Telegraph & Telephone Public Corp. [p. 110].

Impressive as the Japanese effort is, the men of Nippon are not perfect. They are following U.S. manufacturers down one garden path: the road to overcapacity. Incurably optimistic, Japanese semiconductor producers have expanded and expanded manufacturing capacity. Last year's unit sales remained relatively stable, but output capacity climbed sharply. And Japan next year will undergo a typically American experience: widespread price-cutting to stimulate sales of discrete semiconductors.

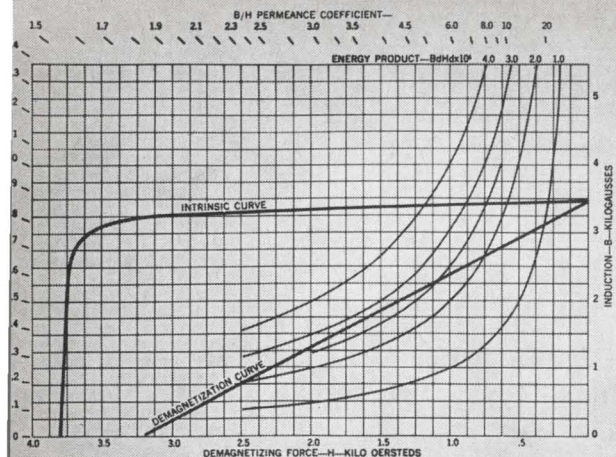

With a coercive force of 3200 oersteds, Indox 7 has a higher resistance to demagnetization than any commercially available magnetic material except costly platinum-cobalt. It also has a high peak energy product and high intrinsic coercive force.

New Indox 7 requires no critical materials, is light weight and has high electrical resistance. Indox 7 opens new possibilities for designs and applications where greater resistance to demagnetization is required, or where the

magnet length is limited compared to the magnet area.

Indiana General pioneered ceramic magnets, developed the first ceramic magnet for PM motors, and continues its leadership in magnet technology with this new high in ceramic magnet materials. For a copy of the new bulletin on Indox 7, write Mr. C. H. Repenn, Manager of Sales, Magnet Division, Indiana General Corporation, Valparaiso, Indiana.

INDIANA GENERAL 

**When it comes to resisting demagnetization,
new Indox[®] 7 is in a class by itself.
Summa Cum Oersteds.**



Electronics Newsletter

December 11, 1967

Intelsat 3 woes make Comsat weigh Hughes bid . . .

Development problems with the Intelsat 3 satellite next month may force Comsat to buy an upgraded version of the Intelsat 2—the workhorse of the International Telecommunications Satellite Consortium.

The possibility of falling back on Hughes Aircraft's earlier proposal for a souped-up Intelsat 2 arose after a quick trip to TRW Systems, the Intelsat 3 builder, by top Comsat officials [see p. 155]. They are understood to have given TRW until late this month to solve the Intelsat 3 problems, but insiders say Comsat's management isn't very optimistic.

Intelsat's Interim Committee, briefed last week on the situation, has directed a Comsat technical team to take a hard look at Intelsat 3 work and set a realistic delivery date, and another team to go over the Intelsat 2.5 design with Hughes. Both will report within two weeks. If Comsat decides it wants to buy the Hughes craft, the committee will hold an emergency meeting early in January. Intelsat 3 delivery, originally set for March, has slipped to August.

The problems in the Intelsat 3, which is slated for Comsat's first global system, currently revolve around the communications subsystem being built by ITT, Comsat sources say. If the Hughes satellites are purchased, it could mean that Comsat will cut back its six-satellite order with TRW.

. . . to supply improved Intelsat 2

If Comsat decides to order the upgraded Intelsat 2—dubbed 2.5—from Hughes, it will buy two of the craft at a price of about \$4 million each. Hughes has promised Comsat that it can deliver the first one by next July.

The Intelsat 2.5 design would incorporate up to 1,000 channels, against the 240 of the Intelsat 2. Hughes has claimed that the craft would be "comparable to the Intelsat 3 global system." The 2.5, an improvement of the Hughes 303A design, would use an electronically despun, phased-array antenna to boost Intelsat 2's 15.5 dbw of effective radiated power to 25 dbw, according to earlier plans [Electronics, May 2, 1966, p. 86]. An improved transponder that would quadruple the bandwidth from 125 megahertz to 500 Mhz has also been proposed.

Lighter lighting from RCA

The semiconductor spotlight may soon focus on markets so far untouched by solid state technology: illumination on highways, in factories and offices, and movie and television studios. At RCA, in fact, switching and control circuits using power transistor and thyristor devices will soon be introduced, substantially reducing the bulk of lighting systems and bringing other benefits as well.

RCA's Electronic Components and Devices division has developed a number of new regulator circuits for these jobs, employing new power semiconductors that have high enough voltage (200 to 300 volts) and current (1 to 5 amperes) ratings to handle lighting and low enough price tags to compete with conventional gear. Present regulator circuitry consists of inductor-capacitor filter networks, but these heavy, large arrangements have drawbacks: the regulation they provide is barely adequate and a strobe-effect (flicker) occurs whenever line voltage makes a transition through zero potential.

RCA's circuits consists of a rectifier, a filter, and a variable on-time switching regulator, plus a novel feedback arrangement that uses a

Electronics Newsletter

series inductor. The new approach cuts ballast size and weight sharply, provides smoother regulation, and, because of a built-in memory capability, eliminates the strobe effect.

\$5,000 tester for linear IC's

Engineers in Grumman Aircraft Engineering's microelectronics department have developed a low-cost (under \$5,000), universal tester for linear integrated circuits. It's the first relatively inexpensive unit capable of performing dynamic as well as d-c measurements, and accommodating differential, operational, and communication-type amplifier circuits.

Instrumentation for linear circuits has been scant. The few systems on the market are priced at \$40,000 and up, and usually measure only a few parameters on a static basis. The Grumman unit, which performs 22 parameter measurements, contains a programing matrix and has provisions for hook-up to either vacuum-tube voltmeters or crt's.

The equipment will probably be marketed by mid-1968. The company, new to both IC making and instrumentation manufacture, hasn't yet decided whether to build and market the gear itself.

Competition for the 703 in hi-fi's

With Fairchild Semiconductor's #A 703E and RCA's CA 3012 (a more complex f-m/i-f amplifier than the 703) now widely used by the leading high-fidelity component makers, rival linear IC producers are starting to take aim at the hi-fi market with competitive devices.

Amelco Semiconductor is already marketing its 911C, which set makers say is similar in characteristics and circuit configuration to Fairchild's 703E. And Philco-Ford has begun sampling its PA 770339, and Raytheon is sampling its RM 703T; both are copies of the 703.

As a further fillip, one semiconductor firm is working on an automatic-gain control version of the 703; the currently available 703's lack agc.

Electronic detector of diabetes sought

The Public Health Service's National Center for Chronic Disease Control is looking for an electronic diabetes-screening device that could be used instead of a chemical analyzer to determine glucose levels in the blood. Although now specifically seeking proposals for a portable chemical analyzer that could process 60 to 120 samples per hour and would cost less than \$2,000, the center would prefer a device that could detect a diabetic condition through a sensor applied to the body. One possible approach, according to a medical electronics specialist, would be to measure the fluorescence that can be produced in an ear lobe.

FAA immunity ruling seen aiding push for air safety

Even sharper demand for significant improvement in air-traffic control and collision-avoidance systems is expected as a result of a new FAA ruling that is expected to foster more-frequent reporting of near mid-air crashes. The ruling, granting immunity to the pilots and the traffic controllers—when they are at fault—should lead to the compilation of solid statistics on air-traffic congestion sought by the agency.

Pentagon to cut Asia stockpiling

Purchases of many kinds of electronic parts and equipment by the Defense Department will begin tapering off in the next few months in an effort to reduce overstocks in Southeast Asia. Items found to be in excess include avionics, radios, radars, and replacement parts for these items.

TTL Trends

from Texas Instruments

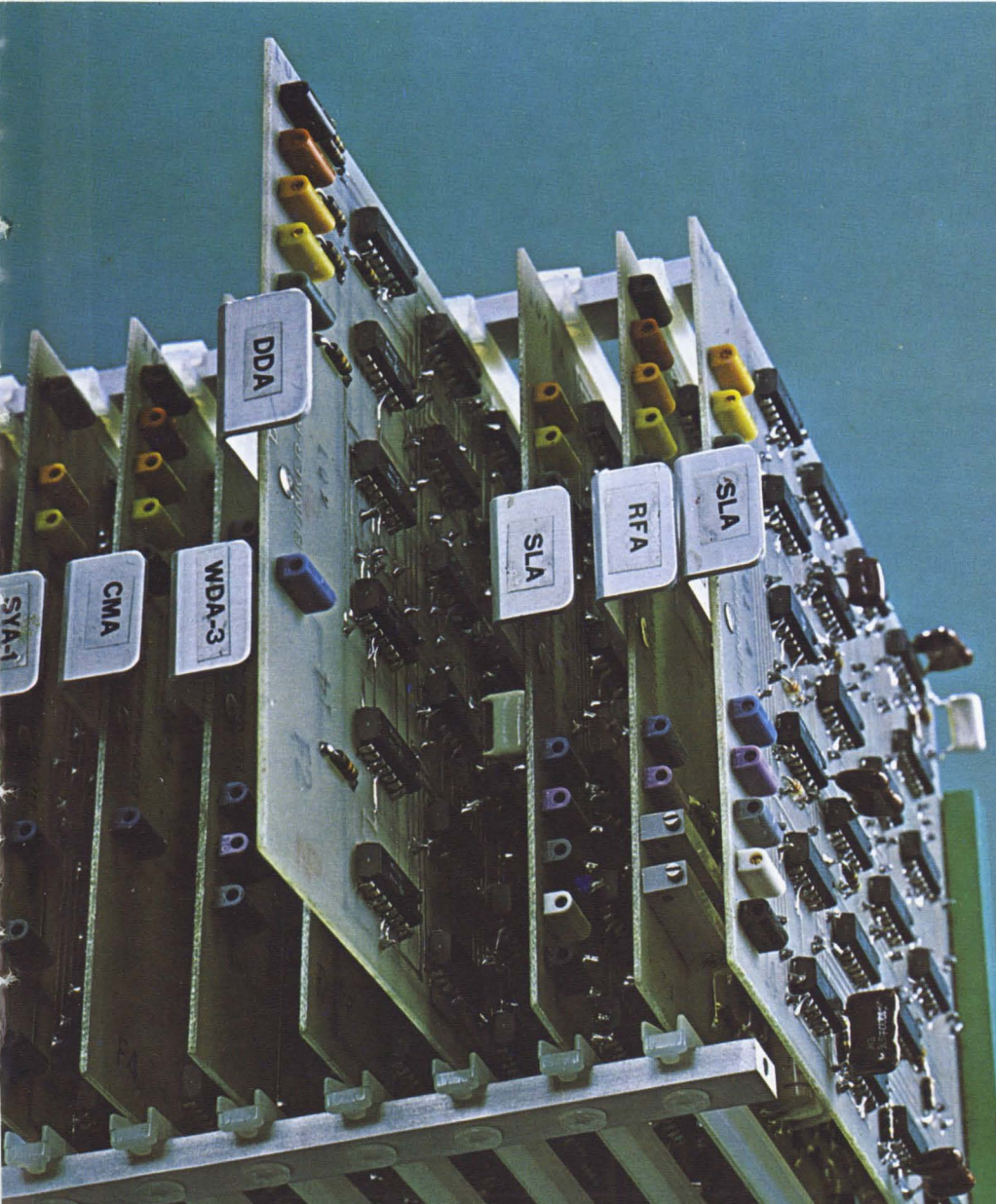

This rack contains electronics for the new Bunker-Ramo 2100 machine tool numerical control system. By using Series 74 TTL complex-function ICs from Texas Instruments, B-R keeps costs far below that of other systems of similar capability. At the same time, the already high reliability is further increased by an order of magnitude, while noise immunity and computing speed capability are also greatly improved (see page B). Many OEMs are building greater business opportunities for tomorrow by going with the complex-function TTL trend in their product designs today.

Why Bunker-Ramo chose TTL complex functions for new NC systems



These low-cost numerical control systems offer as standard most of the functions normally found in far more expensive equipment. They are the first such systems to employ ICs for all non-power functions. Shown with Dean W. Freed, General

Manager of the NC Division, the Bunker-Ramo 2100 (right) is a two-axis positioning and straight-cut control, while the 2200 (left) is a three-axis positioning and straight-cut control, with optional two-axis incremental slope and arc capability.

Series 74 complex-function TTL integrated circuits from Texas Instruments have enabled Bunker-Ramo to further improve reliability and performance, while reducing size and cost of the numerical control systems shown above.

Series 74 TTL offered many performance as well as cost advantages. These included higher noise immunity and faster speed, plus

the economies made possible by complex-function circuits.

High noise immunity

Since numerical control systems usually operate in an electrically noisy environment, the high noise tolerance (typically one volt) and the low input impedance (70 to 150 ohms) of Series 74 circuits are big

advantages. Bunker-Ramo engineers found that this reduced shielding and line-filtering requirements, while simplifying many associated design problems.

High speed

TTL's high speed gives important design advantages, even though today's NC systems often do not

Quality analysis... TI reliability starts here!



Any really successful reliability program must start with correcting the causes of failure *before they occur in the field*, and TI's Reliability Analysis Laboratory... established in 1962... has been examining the "where, what, when, how and why" aspects of IC failures for more than five years.

This lab has facilities to analyze each individual element within even the most complex integrated circuit and can duplicate failure mechanisms under precisely controlled conditions.

Typical of these quality-analysis studies is the X-ray video monitoring facility shown at the left. This important analytical tool permits full 360° observations in both vertical and horizontal planes. It reveals failure mechanisms that might otherwise escape detection.

Following identification of failures, the analysis is forwarded to a corrective-action group. Here, TI's in-depth technical resources—including physicists, chemists, and metallurgists, as well as research, design, and manufacturing engineers—are focused on the problem. After evaluation of all data and reports, necessary corrective actions are undertaken.

Quality analysis is only one of many steps taken by TI to ensure reliability of integrated circuits. Other important steps are described in a new 16-page brochure in full color... *Total Reliability at TI*. Check number 205 on the TI information service card for your copy.



TEXAS INSTRUMENTS
INCORPORATED

require all the speed available. While clock rates of 4 MHz are common today, 20 MHz and up are possible with TTL. To the user, this reserve speed gives an extra measure of performance insurance ... and longer productivity before obsolescence.

In addition, B-R found that the extra speed of TTL also made possible simpler circuitry. For example, a function that would have had to be performed in parallel fashion with lower speed logic can now be performed in serial fashion with Series 74 TTL. This results in fewer circuits and a simpler, less expensive, more reliable system.

20 percent fewer ICs

The complex-function circuits available in the Series 74 line also made possible a 20 percent reduction in package (and circuit board) count. Since the cost of any system is largely proportional to the number of elements used, Bunker-Ramo designers were able to realize important economies.

For example, a decade counter is often made up from four J-K flip flops and a gate...perhaps three packages. Bunker-Ramo used a single SN7490N instead. Since about 40 decade counters are used in a typical NC system, the savings in integrated circuit and circuit board costs are substantial.

Improved reliability

By using Series 54/74 ICs in the new 2100 and 2200 NC systems, Bunker-Ramo engineers found that they were able to surpass reliability standards established

by existing discrete-component designs, since the number of soldered connections were substantially reduced. Also, B-R engineers could place more functions on each circuit board...reducing the number of circuit boards by about 20 percent and further improving reliability.

You get a broader choice of complex-function circuits in Series 54/74 from TI

Complex-function circuits to add, count, store, decode, and perform many other jobs are available in TI's Series 54/74 TTL line...industry's most complete logic family. These complex-function ICs can help you achieve the same kinds of performance and economic advantages realized by Bunker-Ramo.

For a comprehensive data book describing all Series 54/74 complex-function ICs, just check 201 on the TI information service card.

Counters

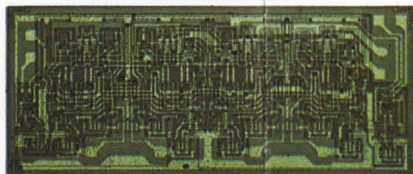

TI offers counters capable of dividing by 2, 3, 4, 5, 6, 8, 10, 12, and 16 at typical rates of 18 MHz. When used singly or in combination, they can perform most division or counting functions that might be required. Furthermore, they afford tremendous reductions in package count, soldered connections, and

costs. In addition to the SN7490Ns used by B-R, SN7492 divide-by-twelve counters and SN7493 four-bit binary counters are available. As may be required by the application, each of these devices offers the flexibility of several alternative interconnection arrangements in the system circuitry.

Adders

If you need adders, TI offers a broad selection. SN7480 is a high-speed, single-bit binary full adder with complementary inputs, complementary sum outputs, and inverted carry output.

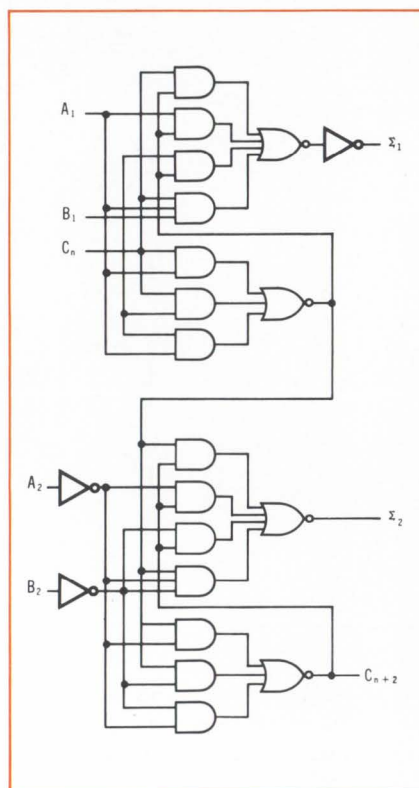

Do ICs really cut costs?

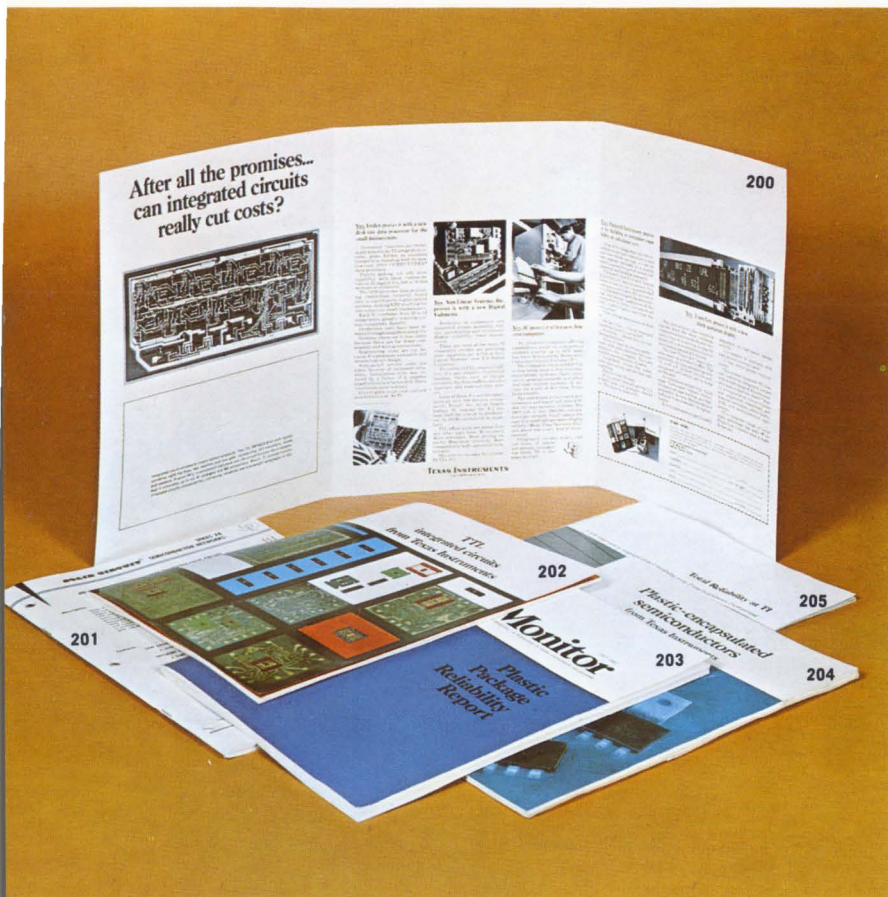

The answer is an emphatic yes! That's no promise. It's a fact... with proof to back it up.

We've gathered some of the proof in the folder pictured at the left. This 6-page brochure describes how other industrial manufacturers have achieved revolutionary product advances with ICs. Like these OEMs, you too can significantly reduce equipment size and weight . . . make major performance improvements... achieve new systems capability... *dramatically reduce costs!* For your copy, check No. 200 on the TI information service card.

But that's not all! Check number 202 for the 48-page brochure that contains performance, application, and catalog information on all 180 Series 54/74 TTL ICs.

An 84-page report provides results of TI's "Tougher-than-military" testing program. It's yours for the asking. Check number 203.

A new 24-page color brochure that gives information on all plastic-encapsulated semiconductors — including Series 54/74 ICs — is also available. Check No. 204.

Please send the following:

- | | |
|--|--|
| 200 <input type="checkbox"/> 6-page case history brochure | 203 <input type="checkbox"/> 84-page IC plastic package reliability report |
| 201 <input type="checkbox"/> 48-page complex-function IC data book | 204 <input type="checkbox"/> 24-page plastic S-C brochure |
| 202 <input type="checkbox"/> 48-page TTL brochure | 205 <input type="checkbox"/> 16-page "Total Reliability at TI" |

NAME _____
 TITLE _____
 COMPANY _____
 ADDRESS _____
 CITY _____ STATE _____ ZIP _____



To get the literature you want, check the appropriate numbers, fill out the card, and drop it in the mail. If you prefer, circle the same numbers on the magazine Reader Service card.

THESE LITTLE ERIE EMI FILTERS

ARE RESPONSIBLE FOR FILTERING
OUT NOISE IN THE GUIDANCE SYSTEM . . .



... ABOARD GRUMMAN'S LUNAR MODULE

ERIE — GRUMMAN'S CHOICE FOR EMI FILTERS

These superior EMI FILTERS passed Grumman's critical qualification requirements — including random vibration and high transient withstanding capability. Most of these very small filters weigh less than 10 grams, and their inherent reliability make Erie a natural selection as Grumman's filter source.

Bonded Filter Stock . . . inventories under lock and key in our Quality Control Department . . . is available for LM subcontractors or for other critical programs requiring Established Reliability Filters.

The typical 100 Vdc rated Erie Filter will provide an insertion loss of 67 db @ 150 kHz. A broad line of ERIE FILTERS is available — including MULTIPLE SECTION FILTERS and special configurations for STRIP LINE applications. Custom filters for your applications can be designed. Why not call in an Erie Filter specialist for your project?



Write for new catalog 9000 . . . ERIE ELECTRONIC FILTERS

Another Series of Components in Erie's Project "ACTIVE"
Advanced Components Through Increased Volumetric Efficiency

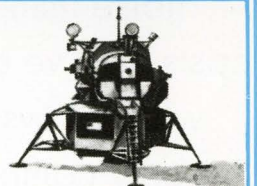

ERIE

TECHNOLOGICAL

PRODUCTS, INC.



Erie, Pennsylvania

Thanks to an ancient shepherd named Magnes, Amelco brings you the only complete high-voltage logic family in the world.

Thousands of years ago, according to Pliny the Elder, a shepherd named Magnes discovered the phenomenon of magnetism. High Noise Immunity Logic developed by Amelco owes much to Mr. Magnes. Magnetic fields are used to measure the mobility of silicon material. This important magnetic measure ensures that the raw materials used to create HNIL provide the fastest possible logic for high level operation. Then, throughout production, quality control and cost economy depend on the use of magnetic ink to isolate those devices which fail to meet operating standards. Fastidious control in the development and production of HNIL guarantees a superb product with consistent high-voltage performance.

This important new line developed by Amelco guarantees unexcelled noise immunity, reduced can count, and overall reduction of systems costs. We've come a long way since Magnes discovered magnetism. But who knows, without his discovery, Amelco may not have brought you the only complete high-voltage logic family available in the world today.

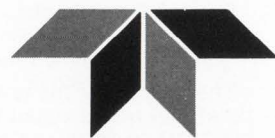

For quality in quantity
AMELCO SEMICONDUCTOR

A TELEDYNE COMPANY



This painting by Kenneth Riley is one in the collection "Innovators and Leaders in the Science of Electricity," commissioned by Amelco Semiconductor. The paintings in this collection illustrate the dramatic achievements and discoveries of some of the forefathers of electronics . . . Magnes, Volta, Franklin, Henry, Edison, Shockley. The entire collection will soon be made available in handsome prints suitable for framing. They will serve as a reminder of the tradition handed down by these famous men, and as a reminder that among the leaders and innovators in the world of electronics today one name is of particular current significance. That name—Amelco.

**WE
AT
COOK
ELECTRIC
ARE
OUT
TO
CHANGE
YOUR
OUTLOOK...**

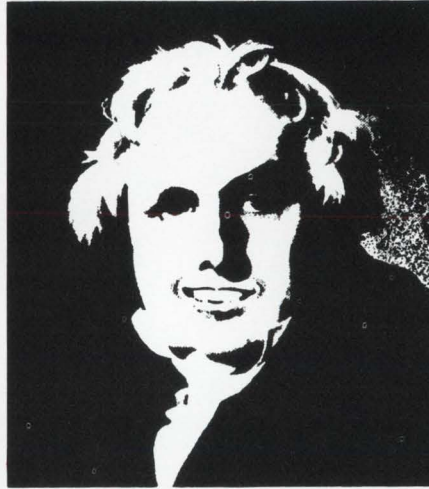
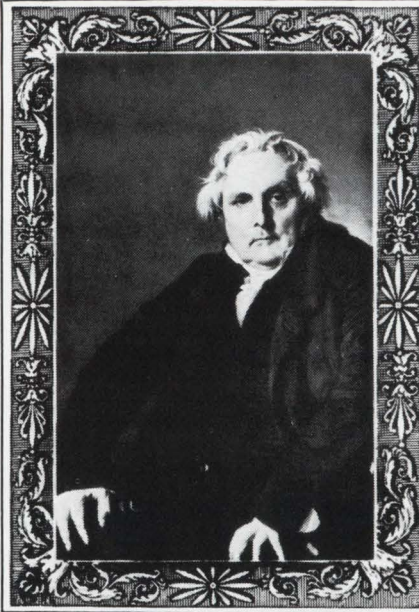

About sales and sales people. About service and delivery deadlines. About quality you can depend on. About new products to meet new requirements before the need becomes an emergency. For example, our relays and pressure switches have been solving industrial problems for 20 years... ranging from small manufacturing operations to the national space program.

Whether you need a component replacement today, or a specially-designed unit to meet a future need, count on us. We specialize in having solutions on hand before problems arise.

And if you're tired of promises unkept and delivery dates unmet, we invite you to investigate the production and service facilities of Cook Electric. You'll find it's good business. With us, performance comes before promise.



**COOK
ELECTRIC**

AUTOMATIC CONTROLS DIVISION

200 E. DANIELS ROAD • PALATINE, ILLINOIS 60067 • 312-359-2100

tricky tapers...

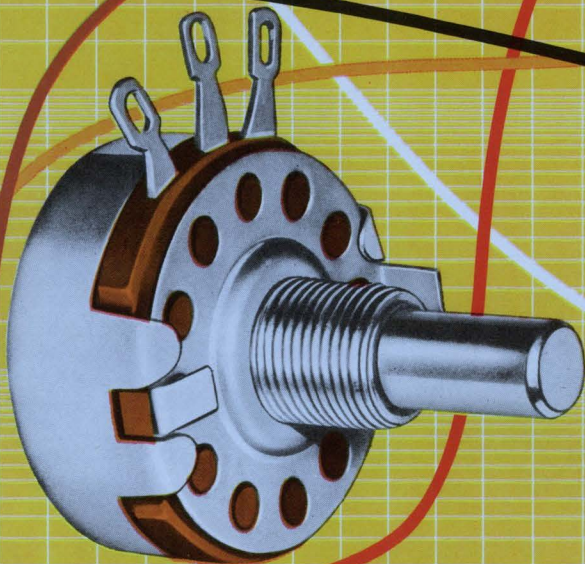

Allen-Bradley Type J
hot molded variable resistor
shown twice actual size

Allen-Bradley Type J potentiometers offer tapers designed to your special needs!

■ When standard tapers fail to provide the control you desire, Allen-Bradley Type J potentiometers have the unique capability to provide a virtually limitless variety of curves to meet your specialized requirements. While not a precision device that is continuously taper-trimmed to very close tolerances, Allen-Bradley's control of the resistance-rotation characteristics during production assures a high degree of conformity.

Allen-Bradley Type J potentiometers have a solid hot molded resistance track made by an exclusive process which was pioneered and perfected by A-B. This solid resistance track assures smooth adjustment at all times—with none of the discrete changes in resistance that are encountered in wire-wound units. And being essentially noninductive, Type J controls can be applied in high frequency circuits where wire-wound units are useless.

Furthermore, A-B's solid molded resistance track assures low noise and long life. On accelerated tests, Type J potentiometers exceed 100,000 complete operations with less than 10% change in resistance.

For more complete details, please write: Allen-Bradley Co., 110 W. Greenfield Ave., Milwaukee, Wis. 53204. In Canada: Allen-Bradley Canada Limited. Export Office: 630 Third Ave., New York, N.Y., U.S.A. 10017.

ADDITIONAL ALLEN-BRADLEY HOT MOLDED VARIABLE RESISTORS

TYPE G CONTROLS are only 1/2" in diameter. Quiet, stepless operation. Rated 1/2 watt at 70°C. Values to 5 megohms. Type L are similar in construction but rated 1/2 watt at 100°C.

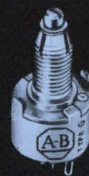

TYPE F TRIMMERS are for mounting directly on printed wiring boards by means of their terminals. Rated 1/4 watt at 70°C. Values to 5 megohms. Type O are similar but rated 0.4 watt at 70°C.



TYPE R ADJUSTABLE RESISTORS for trimming applications are built to withstand environmental extremes. Only 1 1/4" in length. Have stepless adjustment. Watertight and can be encapsulated. Rated 1/4 watt at 70°C. Values to 2.5 megohms. Type N for less severe environments are rated 1/3 watt at 50°C.



ALLEN-BRADLEY
QUALITY ELECTRONIC COMPONENTS



IF YOUR PLATES DON'T LOOK LIKE THIS . . .

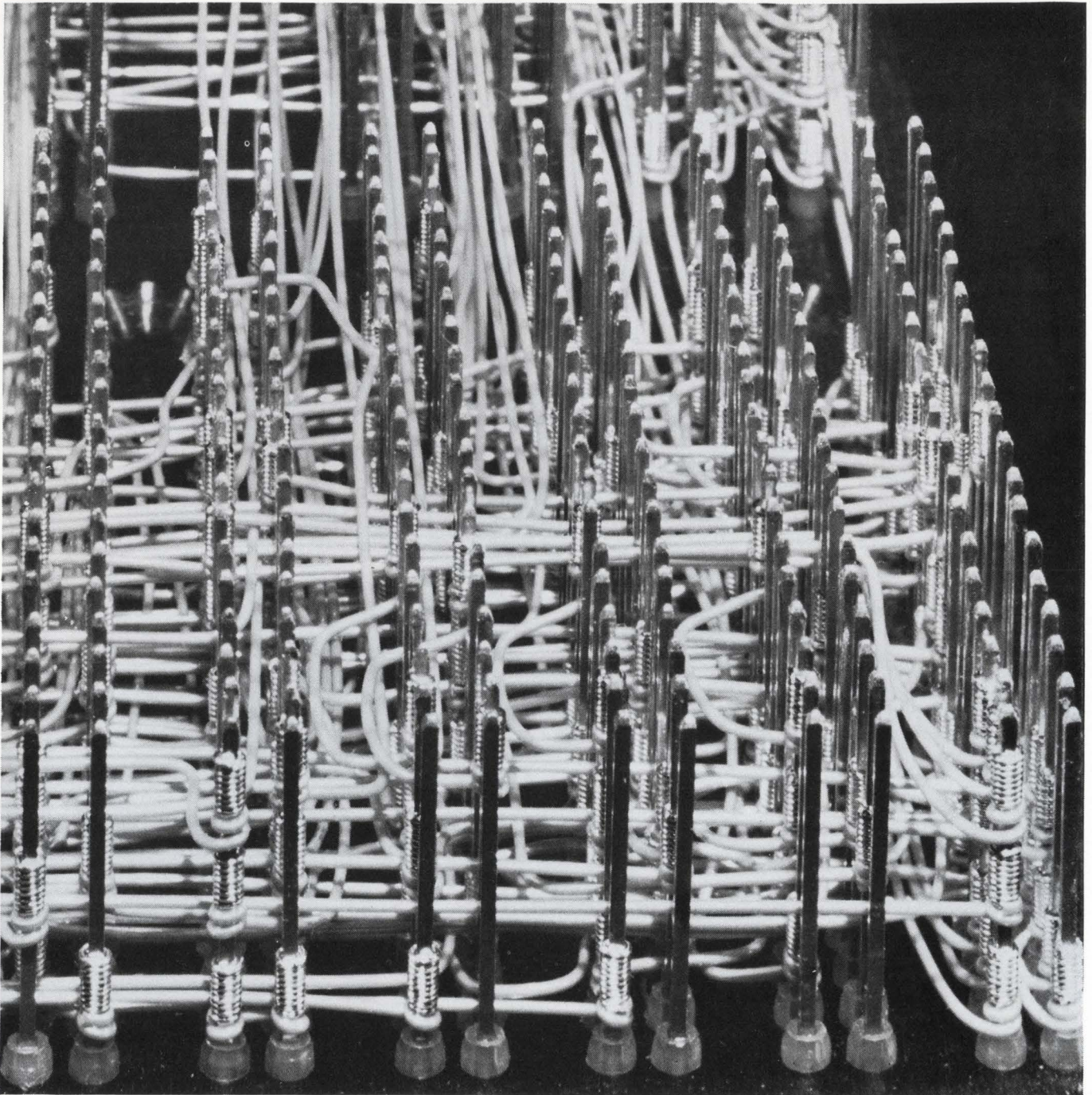

THEY SHOULD!

. . . and can, if they're Elco Variplates.*

The wired side of a plate doesn't just want to look pretty. It has to look pretty. Here's why.

The wire wrapping method of termination is mechanically stronger and far more economical than the old soldered method. Programmed wire wrapping machinery eliminates the possibility of human error. Wires can be dressed for maximum density and elimination of cross-talk. Three-level termination and ease of future wiring changes are more practical benefits.

Beauty is more than skin deep, and that's where Elco comes in. Programmed wrapping equipment demands tight tolerances. The plates must be

hole-punched accurately. When you're punching hundreds (or thousands) of holes, the metal expansion rate can be a large factor. Stand-offs must align perfectly and be pull-out proof. Our precision machining achieves guaranteed, micro-inch tolerances.

And Elco's complete line of component connectors offers you more design freedom than you need. Our vast array of connector styles, sizes and contact configurations can fill your functional needs.

So, if your plates don't look like ours, give us a holler. Elco Corporation, Willow Grove, Pa. 19090; (215) 659-7000. Where your design expectations take shape.

*TRADEMARK

*Elco
Connector
Technology . . .
20 years
young*



“we have used many millions of Allen-Bradley hot molded resistors. The uniformity of quality from one shipment to the next is truly astounding. There can be no question about the reliability of these resistors.”

Wang Laboratories

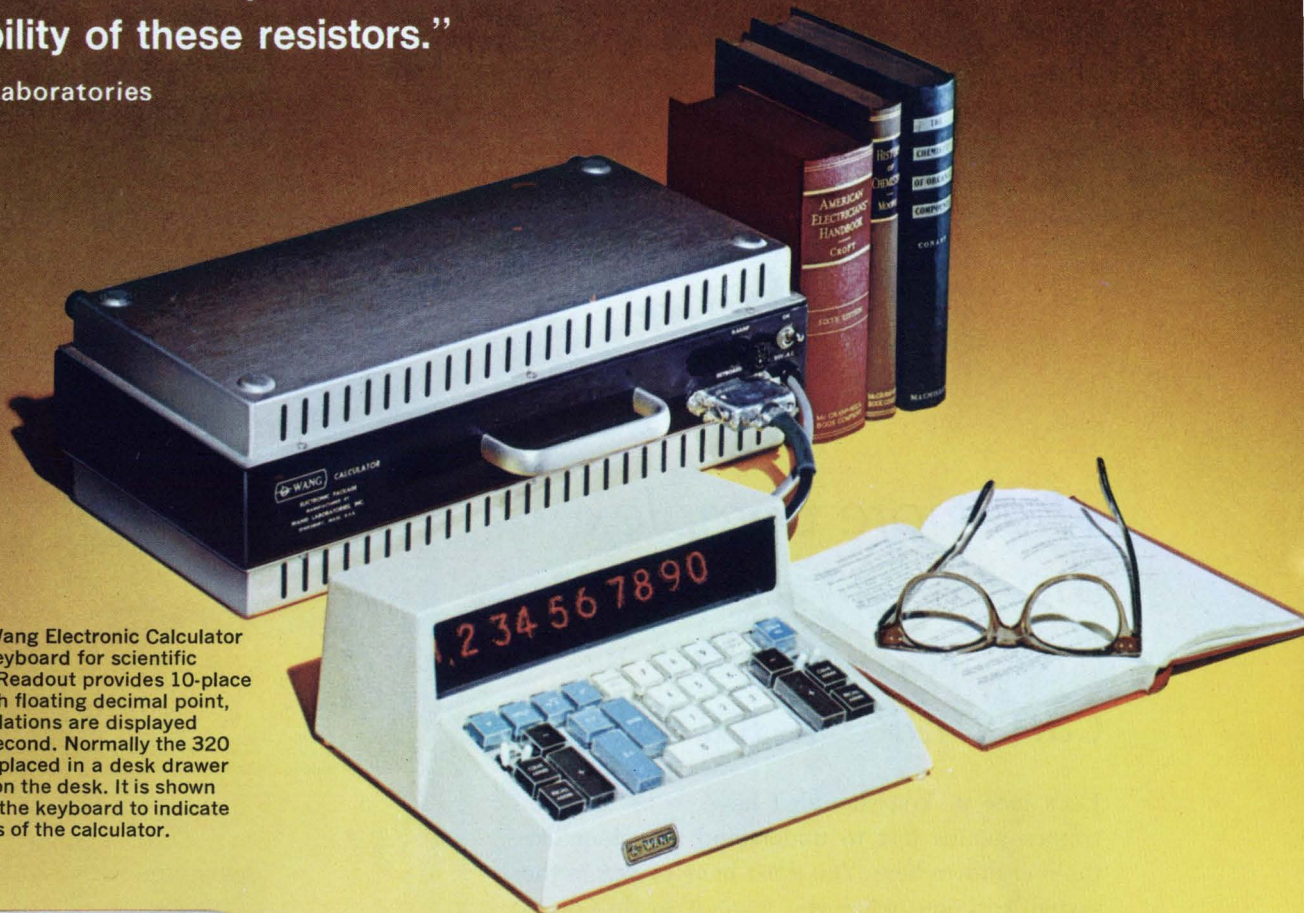

Model 320 Wang Electronic Calculator with 320K keyboard for scientific application. Readout provides 10-place accuracy with floating decimal point, and all calculations are displayed in one millisecond. Normally the 320 calculator is placed in a desk drawer rather than on the desk. It is shown here next to the keyboard to indicate compactness of the calculator.

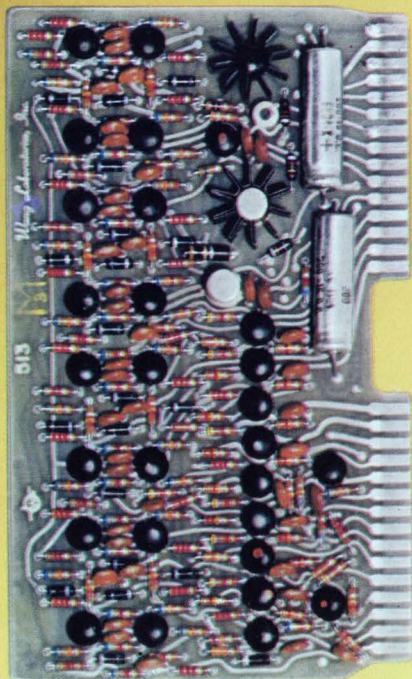

One of the printed circuit cards from the Model 320 calculator. All resistors on this card are Allen-Bradley Type CB 1/4 watt hot molded resistors.

To insure the extremely accurate and high speed operation of the 300 Series Wang Electronic Calculators, all components are selected with utmost care. Thus, it was only natural that Allen-Bradley hot molded resistors were chosen for this most exacting application.

Composition resistors, not produced by the technique of hot molding used by Allen-Bradley—using completely automatic machines—cannot equal the quality and uniformity of production for which the hot molded Allen-Bradley resistors have a worldwide reputation. The precise control during manufacture results in such uniformity of one A-B resistor to the next—million after million—that long term resistor performance can be accurately predicted. There is no record of any Allen-Bradley hot molded resistor having failed catastrophically.

Let the experience of the engineers at Wang Laboratories become your

own experience. Allen-Bradley fixed and variable hot molded resistors will do exactly as well for you as they have done for all other users. For complete specifications, please write for Technical Bulletin 5000: Allen-Bradley Co., 222 W. Greenfield Ave., Milwaukee, Wis. 53204. In Canada: Allen-Bradley Canada Limited. Export Office: 630 Third Ave., New York, N. Y., U.S.A. 10017.



TYPE BB 1/8 WATT

TYPE CB 1/4 WATT

TYPE EB 1/2 WATT

TYPE GB 1 WATT

TYPE HB 2 WATTS

HOT MOLDED FIXED RESISTORS are available in all standard resistance values and tolerances, plus values above and below standard limits. Shown actual size.



ALLEN-BRADLEY
QUALITY ELECTRONIC COMPONENTS



*The more complex
the data system gets,
the simpler Cimron
can make it for you!*

Let's face it. You shouldn't have to be an electronics genius just to understand a system like the one shown here. You don't have to *design* the system to know what you want it to do—or to use it. That's where Cimron comes in. And the more complex the problem, the simpler Cimron can make it for you. That's what we're here for. To provide the expertise in this specialized field so you don't have to do it yourself.

The Model 1130 Production Test Applications System shown here monitors 100 channels of input signals, measures and records the data. It happens to employ a Cimron DVM with converters, a scanner, a serializer and a digital recorder. It could have been designed to solve your special problems as easily. For help, call Cimron collect at (714) 276-3200, or write Department A-113, 1152 Morena Boulevard, San Diego, California 92110.

CIMRON[®]
A Division of
Lear Siegler, Inc.



Five reasons why so many engineers specify Sigma relays.

Longer mechanical life

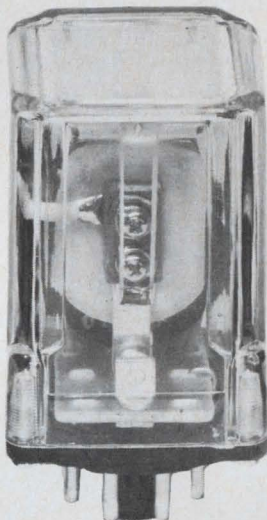

Series 50

Better conductivity

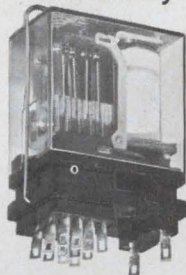

Series 62

Price: 75¢



Series 65

Faster installation



Series 67

Solid-state design

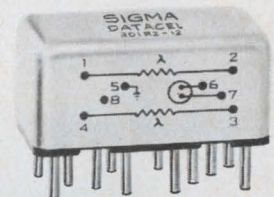

Datacel®

And there are more reasons why each of these Sigma relays give you superior performance:

New Series 50: Rated for at least 10 million mechanical operations and fully recognized under the U.L. component program. These 1, 2 and 3 pole, 5 and 10 amp relays also feature an exclusive contact base design that extends contact life.

New Series 62: The larger contacts of this new Series (.093" & .058" dia.) assure excellent conductivity. And it has a thicker base for greater contact stability than other 2, 4 and 6 pole, 2 amp relays.

New Series 65: In addition to low price economy, this new 1 amp SPDT relay provides superior switching performance through its precision knife-edge hinge armature design. It has greater mechanical strength and better thermal stability than similar competitive types.

New Series 67: It not only assures faster in-

stallation with its simple snap-in socket but will outperform other 4PDT, 3 amp, AC-DC relays in life, adjustment stability and thermal resistance.

New solid-state Datacel®: This optoelectronic switching device provides greater reliability and complete input-output circuit isolation. It also features AC-DC capability, compact construction and broad application versatility.

We'd like to give you one of these relays or any standard Sigma type. It's the best way we know to prove what we say about Sigma relay performance. Just fill in and return the post-paid reply card—or the Reader Service Card. We'll send you the new Sigma relay catalog and a "free relay" request form. Return the form and your Sigma representative will see that you get the relay you need.

Need fast delivery? The Sigma Line is available off-the-shelf from your Sigma distributor.



SIGMA INSTRUMENTS INC

Assured Reliability With Advanced Design / Braintree, Mass. 02185

Sigma Instruments (Canada) Ltd., P.O. Box 43, Toronto 18

Investigate Random or Periodic Processes with Correlation Function Computers

Correlation functions occupy a cardinal position in modern information theory and are basic to the analysis of random or periodic processes and the complex signals they produce. In many application areas, autocorrelation analysis allows noisy periodic or random signals to be defined, whereas crosscorrelation can determine the degree of conformity between two different noisy signals as a function of their mutual delay.

PAR™ Models 100 or 101 Correlation Function Computers simultaneously compute 100 points of the auto- or crosscorrelation function in real time over delay spans from 100 microseconds to 10 seconds. The Model 101 includes the capability for insertion of fixed delay increments ahead of the 100 computed points of the function, thereby providing greater resolution. The correlation function readout which may be obtained continuously as it is computed, is available at various rates consistent with the speed of the external readout device, e.g. oscilloscope or X-Y recorder.

Vibration analysis, radio astronomy, laser research, geophysics, radar, plasma physics, aero- and hydrodynamics, and biophysics are only a few of the fields where correlation techniques are useful.

Price of the Model 100 is \$8,500. The Model 101 is priced at \$9,500 to \$12,900. Export prices are approximately 5% higher (except Canada).

For additional information, write Princeton Applied Research Corporation, Department D, P.O. Box 565, Princeton, New Jersey 08540 or call 609-924-6835.

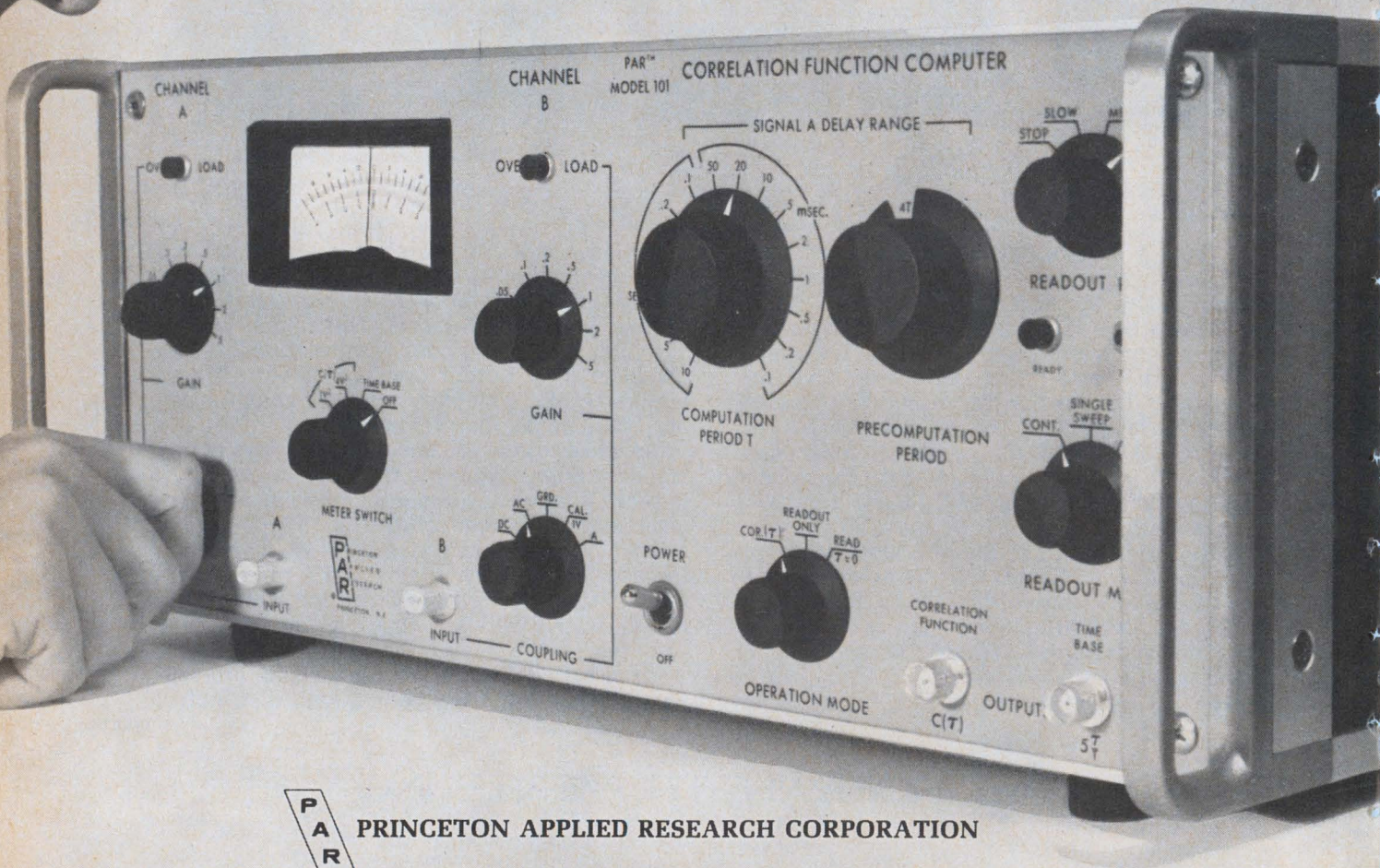

PRINCETON APPLIED RESEARCH CORPORATION

Components

Brush off

The carbon brush for d-c motors, like nature, abhors a vacuum. It cannot survive in space for more than a few seconds. The vacuum causes the brush to "weld" to whatever surface it touches. But because of the nature of the power sources in space—batteries, solar energy—d-c motors are, for all practical purposes, the only choice. The need, then, is for a brushless d-c motor, and NASA has been working on such designs for five years.

In the latest model, engineers at NASA's Goddard Space Flight Center have developed an optoelectronic commutator to replace the motor's brushes.

The optoelectronic scheme gives the engineers more than just the opportunity to get rid of the brushes. It—along with a unique magnetic configuration—provides them a motor with a wide range of both speed and torque.

For commutation of the armature coil, a disk at one end of the shaft has alternate black and white areas. A light beam directed at the disk is reflected to six photodiodes. The disk thus acts as a shutter and, as the shaft rotates, light strikes the diodes in sequence. Output of the diodes goes to switching transistors, and amplified current is fed back to the armature to develop two magnetic fields that interact with the rotor field to create torque.

NASA's newest version, developed by Aeroflex Laboratories Inc. of Plainview, N. Y., is called the variable-field brushless d-c motor. Pancake-shaped field and armature coils are stationary and both are concentric to the axis of the rotor. At each end of the rotor

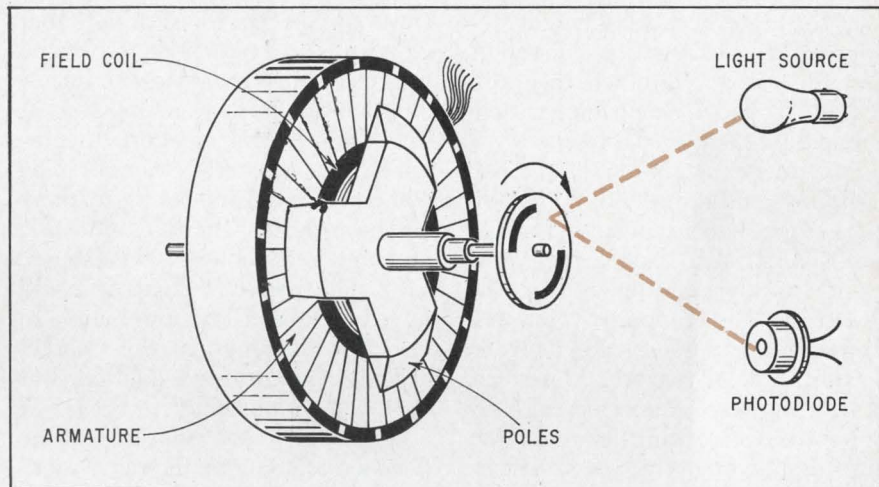

Optoelectronic commutation. In a new variable-field d-c brushless motor with stationary coils, shuttered light beam commutates rotor field.

shaft are salient poles, which rotate in planes parallel to the flat surface of the pancakes.

The d-c energized field coil generates an axial magnetic field, which travels along the shaft, through the poles, and into the commutated armature. Thus, the only rotating part is the slim rotor shaft and its thin poles.

Others in works. Meanwhile, five d-c brushless motors developed earlier by Sperry Farragut division of the Sperry Rand Corp. under NASA sponsorship are being readied for long-term flight application in earth orbit on the Air Force's ov-113 satellite, now scheduled for launch in early March.

The Sperry Farragut version, using a permanent magnet rotor, does not have the range of speeds needed for some applications.

The prototype of the Aeroflex variable-field d-c brushless motor is rated at 28 volts d-c and draws up to 2 amperes. Speed can be adjusted from 0 to 2,400 revolutions per minute. The prototype's torque is rated at 0.5 foot-pounds per ampere. With a time constant of 1.2 milliseconds, the motor can

be fully reversed in 3 milliseconds. Now under test at Goddard, the motor, at most speeds, operates at about 50% efficiency.

"So far," reports Philip A. Studer, under whose direction it has been developed and tested, "the variable field d-c brushless motor has proven to be highly reliable. But there are still some questions as to how well it will perform at higher power."

Even while the motor is being tested, Goddard engineers are eyeing a variety of space tasks for it. Studer mentions driving of solar panels and despinning of antennas, in which torque is the controlled variable, and attitude-control and moment-gyro systems, in which both speed and torque adjustment are significant.

Advanced technology

Unmasked

"For Sale: One laser-operated integrated-circuit masking camera, never used. Cost one million dol-

lars, new. Make offer to Spectra-Physics Corp.”

That ad has not appeared. But after two years of development work and the reported investment of more than a million dollars, the Mountain View, Calif., laser company has decided to abandon its masking camera project. The reason, says Herbert M. Dwight Jr., Spectra-Physics' new president, is that “we have examined the project and found it is no longer economically feasible.”

Spectra-Physics, a relatively small company, had apparently bitten off more than it could chew. Dwight and Kenneth A. Ruddock, vice president, frankly admitted that it was the loss of the company's competitive edge that led to the decision to quit. The David W. Mann Co. of Burlington, Mass., has already announced a masking camera much less complex than the Spectra-Phys-

ics system but much more available. With a total potential market estimated by some sources at only 10 to 20 cameras a year, at some \$150,000 per system, Spectra-Physics could not afford to share sales with anyone and still hope to recoup its investment.

Time and money. One source close to Spectra-Physics said that although an engineering prototype was tested last summer, another 18 months of effort were needed, at the current level of effort, to produce a marketable system. (The company had 25 persons working on the project.) “It was a question of time and money,” this source said. “If Spectra-Physics could have invested a lot more money to get the system on the market quickly it might have paid off. But that wasn't possible.”

Apparently contributing to the decision to abandon the camera was

the fact that the company is completing a less-than-successful financial year.

Single step. The Spectra-Physics camera was by far the most complex of any developed for IC mask-making. It had nine lenses, so that all of the masks necessary for the production of a given circuit could be made with a single step-and-repeat operation. By contrast, the Mann model, and the one developed for in-house use at the Hewlett-Packard Corp., have only one lens.

The nine-lens system would result in better registration of the masks and in savings in time. But Spectra-Physics may have been a victim of its own passion for perfection; one person familiar with the project feels that the company set its goals far too high. “They were trying to build a Rolls-Royce, and they should have been building a Buick,” he said.

One goal set by Spectra-Physics at the beginning of the project was 10-microinch accuracy in the stepping function. At that time, such accuracy was several times better than that of existing equipment; since then the conventional equipment has achieved accuracy comparable to that of the laser system.

But the big advantage of the Spectra-Physics camera was in the optics. The lenses were modified to work near the ultraviolet line so that photoresist could be exposed directly. Normally, the masks are exposed onto an emulsion, which is used to make contact prints on metal. Direct exposure permits greater resolution, Ruddock explains. The Spectra-Physics camera could make 500-line pairs over a large field of view (70 square millimeters).

Unplugged. “We're wondering now what to do with the lens,” Ruddock said. “You can't just plug it into another system: for one thing, it requires a mercury vapor lamp instead of a tungsten lamp.”

Abandonment of the camera project coincided with reshuffle of top management at Spectra-Physics and was the first step in a revision of marketing strategy. “We are going to focus our product development on laser-oriented work in sup-

Electronics Index of Activity

December 11, 1967

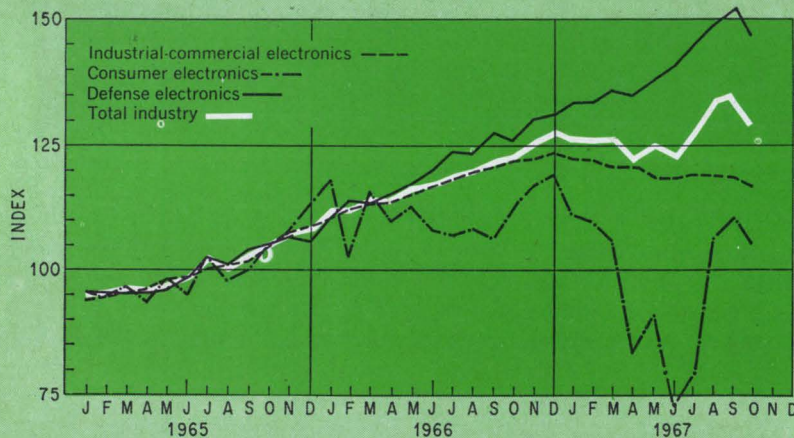

Segment of Industry	Oct. 1967	Sept. 1967*	Oct. 1966
Consumer electronics	105.1	110.3	111.9
Defense electronics	147.0	152.7	125.8
Industrial-commercial electronics	116.8	118.1	121.7
Total Industry	131.3	135.2	122.2

Electronics production dropped in October after a five-month rise. The overall index slipped 3.9 points but was still 9.1 points ahead of the October 1966 level. Output in all sectors of the industry fell, with the biggest month-to-month decline in defense electronics. Part of the 5.7% drop in this area reflected a temporary leveling-off in defense spending. Consumer volume was down by 5.2 points and industrial-commercial output by 1.3 points.

Indexes chart pace of production volume for total industry and each segment. The base period, equal to 100, is the average of 1965 monthly output for each of the three parts of the industry. Index numbers are expressed as a percentage of the base period. Data is seasonally adjusted.
* Revised

port of less expensive and more reliable helium-neon and argon lasers," Dwight said. (The company has also stopped work on the carbon-dioxide laser which it showed earlier this year.)

When Dwight assumed the presidency of the company, Robert C. Rempel left that position to become vice president and technical director. The change, Dwight indicated, was more apparent than real. "It was really a formal recognition of what our responsibilities had become," he said. Dwight was formerly a vice president and treasurer.

Medical electronics

Sound thinking

Conventional hearing tests, where the subjects don earphones and indicate whether they can hear certain recorded sounds, are fine for adults and children capable of communicating. But for those incapable of replying, accurate testing has been almost impossible. However, a Princeton, N.J., firm, the Princeton Applied Research Corp., has developed a research instrument that doesn't depend on a reply—at least not a conscious one.

Instead, the instrument, called an evoked-response audiometer, is built around an electroencephalographic (EEG) device. The EEG signals are involuntary electrical

waves generated by the brain, and changes in their patterns can often be tied to specific motor or psychological stimuli. The principle behind the Princeton instrument is that perceived sound produces a predictable EEG wave form.

Pinpointing components. The problem is picking out the significant components of the wave form from the many in a complex EEG signal. The firm's feat was to develop a technique of detecting that portion of the wave that corresponds to the perception of sound. For this, it uses a signal-averaging computer.

The audiometer-system design was based on the suggestions of Dr. Hallowell Davis of the Central Institute for the Deaf in St. Louis, Mo., whose work on evoked responses was supported by a grant from the Federal Public Health Service.

In addition to the computer, the instrument includes a programmer, a tone generator, a strip-chart recorder, and an EEG amplifier. The computer is basically a modified version of the company's Waveform Eductor. It averages the noise components of the responses to zero while averaging the other components common to the same time segment of the EEG signal to a stable value.

In preparing for a run, the audiometer operator sets the desired stimulus characteristics—frequency, intensity, pulse rate, duration, and rise and fall times; and the desired processing parameters

—integrating time constant, gain, window width, and high- and low-frequency rolloffs. The operator can choose either manual or automatic control of the number and repetition rate of pulses, and the speed of the chart.

Stop and go. In the automatic mode, the audiometer operates at the preset rate and records both the raw and processed signals at low chart speeds. It speeds up the chart drive by a factor of 125 for the median and final two pulses, then erases the computer memory and resets itself for the next run. However, the operator may interrupt the run at any point and then resume it after a pause without affecting the total count. Also, he may call for an additional high-speed recording at any point during the run without affecting the program.

Recording pulses at a very low chart speed is used to monitor gross anomalies in the raw signal, such as those caused by the movement of an electrode. Although the low-speed recording yields no detail, it provides an amplitude envelope in which gross variations are easily detected. The corresponding envelope for the processed signal is convenient for observing the buildup of the evoked signal with time. The actual waveforms used for analysis are those obtained during the high-speed recordings at the middle and the end of each run.

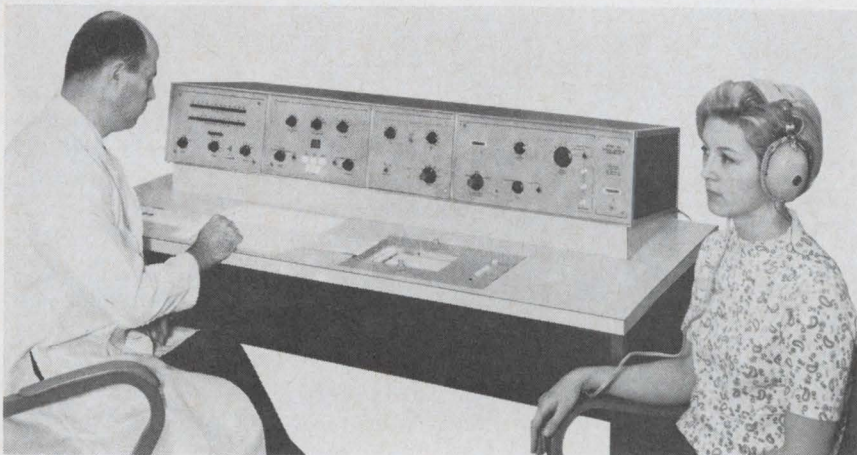

Now hear this. A subject's brain waves are monitored to determine whether she can hear sounds produced by this hearing-test equipment.

Space electronics

Band practice

With the Apollo program behind schedule, crews at the unified S-band tracking stations around the world have had few opportunities to develop and maintain a practiced hand in operating their gear. And with so much riding on the man-on-the-moon project, NASA has decided to loft an S-band transponder to keep the crews in condition. This week (Dec. 13) the space agency is to launch the 40-pound satellite that will ride piggyback

on the Thor-Delta vehicle that will loft a Pioneer space probe.

The transponder is one of two designed and built by the systems group of TRW Inc. under a \$550,000 contract from NASA's Goddard Space Flight Center. To the tracking gear on the ground, it will look like the Apollo command module, providing the crews with an opportunity to both test their hand and check their electronic equipment.

The Test and Training Satellite (TTS) program is the result of an unsolicited proposal that lay dormant until the Apollo program fell behind. Then, last April, the space agency asked TRW to proceed on its proposal.

Something borrowed. The TTS program, says Harold Adelson, has drawn on technology developed for three other TRW programs: Pioneer, the Environmental Research Satel-

lite (ERS) series, and the space-ground link subsystem (SGLS). Adelson is assistant director of the research applications laboratory at TRW Systems, Redondo Beach, Calif. The firm is prime contractor to NASA for Pioneer and is building the ERS series and some SGLS flight hardware for the Air Force. The octahedral TTS package is essentially an ERS satellite. Its five-element, S-band omnidirectional slotted array antenna is one-half of a Pioneer antenna, says Ralph Miller of the information transmission department, where the S-band transponder was built.

The satellite will have an orbital apogee of 324 nautical miles, and a perigee of 166 miles. It will replace aircraft formerly used as spacecraft simulators. "The aircraft are expensive to maintain," notes Adelson, "and you can't check all the stations with them. With this satellite, each

station will be able to acquire it, track it until it disappears, then hand it over to the next station."

He explains that the satellite uses a passive magnetic stabilization system to keep the spacecraft axis horizontal to the earth. Principal parts of the system are a bar magnet and hysteresis rods to dampen any oscillations that occur. The effective radiated power is "a little better than half a watt," notes Adelson. "To produce this, we have to put in 17 watts when the transponder is working. Solar panels deliver five watts, and a nickel-cadmium battery supplies the remainder."

Ground trigger. Adelson says the transponder has two modes. In the ready mode, it is quiet until it receives an S-band signal on a frequency of 2,101.8-megahertz. It then retransmits the signal to the sending station at 2,282.5 Mhz. In the coherent, noncoherent mode, the transponder transmits a non-coherent S-band signal at all times, which allows automatic acquisition by the ground stations. The received signal is retransmitted coherently, without any change in modulation. Either mode can be triggered by ground command.

Miller says the ground stations can send up any baseband or any modulation, and the transponder "will turn it around."

"The coherent feature means they can do ranging or determine range rate, and can send up telemetry or voice and get it back. We have enough power onboard to turn these signals around at altitudes up to 1,500 nautical miles," he explains.

A 1.25-Mhz subcarrier will accommodate voice transmissions, while telemetry signals will be placed on a 1.024-Mhz subcarrier. A standard NASA/Air Force pseudo-random noise code is used for ranging.

A diplexer—also borrowed from the Pioneer program—permits simultaneous reception and transmission using only one antenna. The transponder receiver has a minimum sensitivity of -125 decibels, which yields a good signal-to-noise ratio on the up-link about 50 db;

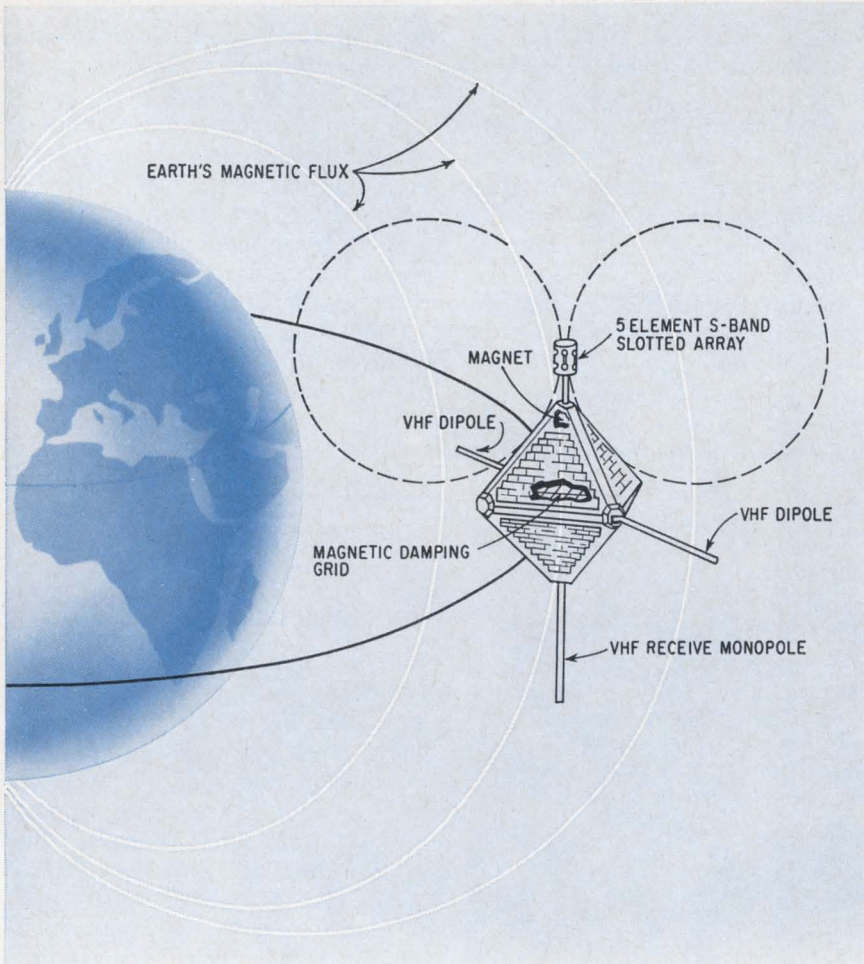

Workout. Satellite generates S-band signals to keep Apollo tracking crews in practice for the moon launch.

TRW ANNOUNCES NEW MILITARY MYLARS



14-59

Up to 72% smaller than MIL-C-25C paper capacitors!

MIL-C-19978B/2 reduces capacitor size drastically—down to .125" diameter by 1/2" long. At the same time electrical characteristics are upgraded sharply.

MIL-C-19978B/2 hermetically sealed mylar* capacitors are available now from TRW with immediate delivery in production quantities.

- **REDUCED SIZE**—35% to 72% smaller than MIL-C-25C.
- **VOLTAGE CHOICE**—30V, 50V, 100V, 200V, 600V, 1000V.
- **CAPACITANCE CHOICE**—.001 mfd through 10.0 mfd.
- **TOLERANCE CHOICE**—±10%, ±5%, ±2%, ±1%.

Product information is available from TRW Capacitor Division, TRW INC., Box 1000, Ogallala, Nebraska. Phone (308) 284-3611. TWX: 910-620-0321.

*Du Pont registered trademark

TRW®

that on the down-link depends on whether the signal carries voice, telemetry or ranging data.

Turn off. Electronic subsystems besides the main payload—the transponder—include a command receiver and decoder, and a house-keeping telemetry system. The telemetry information will be carried at 136 Mhz via a dipole whip antenna to NASA space tracking and data acquisition network stations that control the satellite. Commands from these stations will be detected, using a monopole whip antenna, and received at 149 Mhz in the command receiver. Adelson says the commands used are basically those that turn the transponder on and off.

Integrated circuits are used extensively in the spacecraft's electronics, except for the transponder. The satellite is designed for an orbital life of seven months. The second launch is tentatively scheduled about six months after the first, probably riding piggyback aboard another Pioneer probe.

Consumer electronics

Pop up amp

The integrated circuit operational amplifier is widely used in data-processing systems, telemetry, and analog instrumentation. Now that's in a low-cost plastic in-line package, it may find wide use in consumer applications—such as in a pre-amplifier where its low-noise characteristics are especially advantageous.

The op amp is entering the consumer market in H. H. Scott's new f-m stereo music system; a dual monolithic IC amp, Motorola's SC2914 (essentially the MC1302), is used as a low-noise phono pre-amplifier with RIAA (Record Industry Association of America) equalization. Price of the system is about \$300.

Lower costs. Scott describes his decision to replace discrete components with an IC as purely one of economics, but says improved per-

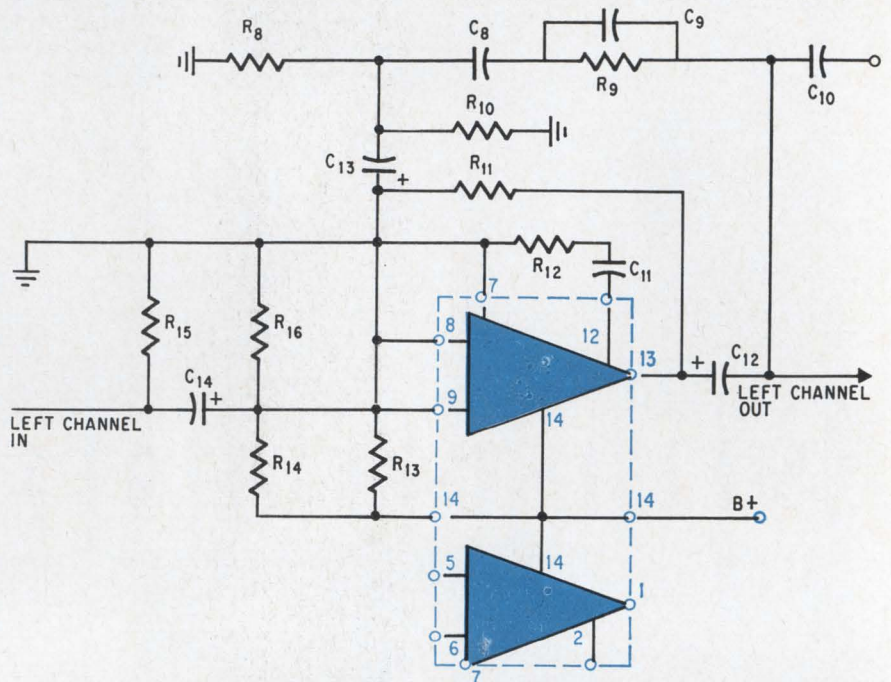

Higher fi. H.H. Scott is introducing an f-m stereo system with a monolithic operational amplifier, boosting performance and cutting costs.

formance and reliability were achieved as byproducts.

The Motorola device is a plastic-packaged version of the more expensive TO-5 packaged MC1535G.

Daniel von Recklinghausen, Scott's engineering director, says, "We can't say exactly what the savings are since production costs are always difficult to determine. But while the costs of discrete resistors and capacitors is on an upward trend, the cost of IC's is going down."

Furthermore, by replacing a large number of discretes with a single device, fewer production operations are required, resulting in reduced labor costs.

Better performance. The integrated-circuit op amp is employed in a closed-loop configuration in the phono preamplifier with external d-c and a-c feedback circuitry.

In the diagram, shown above, only one channel of the dual-channel amplifier is shown for simplicity. RIAA frequency response standards at 500 hertz are provided in the a-c feedback circuit by C₈, C₉, and R₉, while R₁₀ is added to the compensation circuit to achieve the required 75-microsecond rolloff figure.

Feedback for d-c stability and

low-frequency gain is established through R₁₀ and R₁₁. Resistor R₁₃ provides the base current for the input stage and establishes the maximum output limits. Biasing current is established through R₁₄.

Over-all, the amplifier is designed to provide very low noise with improved high-frequency characteristics through the use of tantalum capacitors in frequency-sensitive circuits.

The quiet one

Although the first electronic (transistor-controlled) wristwatch made its debut on the consumer market seven years ago [Electronics, Oct. 28, 1960, p. 35], the watches have generally been high-priced. Bulova's Accutron starts at \$125 and goes up to \$1,000, while Benrus' Technipower is priced from \$120. The Sheffield Watch Co. of New York, however, is introducing a 17-jewel electronic watch — the company's first—that will retail for less than \$50. The Sheffield watch is silent; most other electronic watches hum.

Competing with the Sheffield watch are electric models pro-

150 MHz, 2.4 ns

New performance from probe tip to CRT!

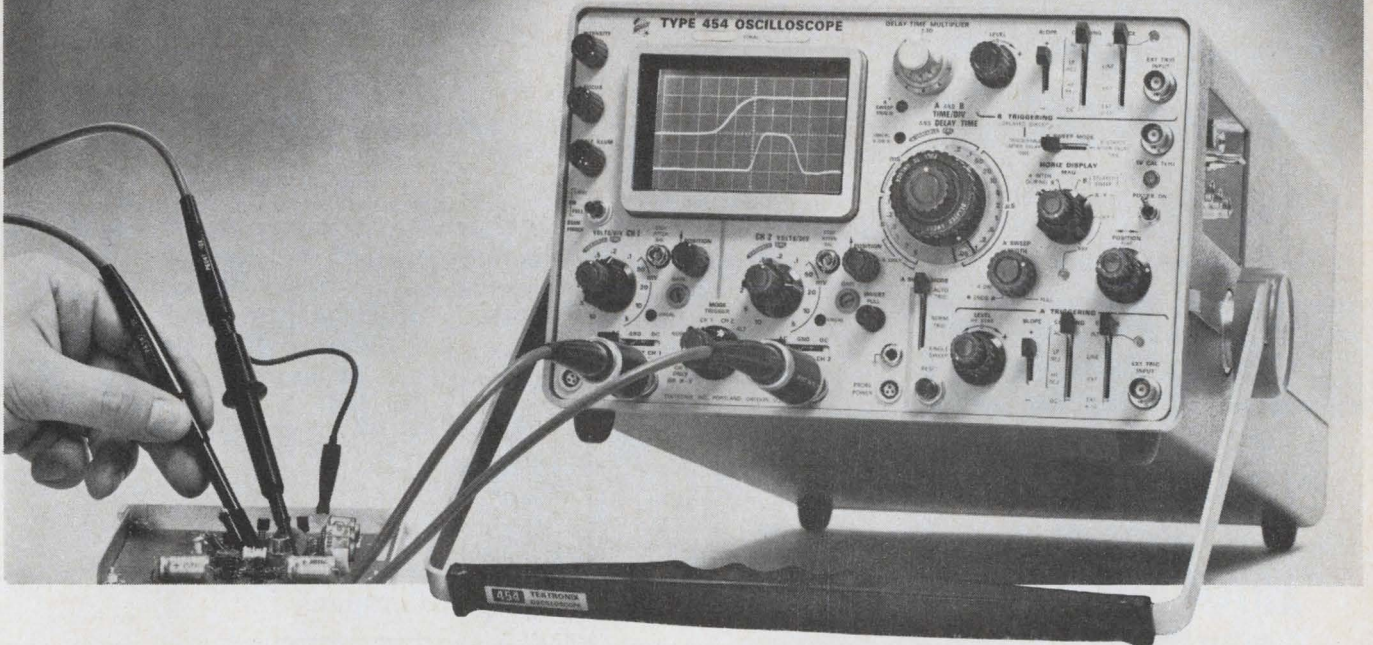

The Tektronix Type 454 is an advanced new portable oscilloscope with DC-to-150 MHz bandwidth and 2.4-ns risetime performance where you use it — at the probe tip. It is designed to solve your measurement needs with a dual-trace vertical, high performance triggering, 5-ns/div delayed sweep and solid state design. You also can make 1 mV/div single-trace measurements and 5 mV/div X-Y measurements.

The vertical system provides the following dual-trace performance, either with or without the new miniature P6047 10X Attenuator Probes:

Deflection Factor*	Risetime	Bandwidth
20 mV/div to 10 V/div	2.4 ns	DC to 150 MHz
10 mV/div	3.5 ns	DC to 100 MHz
5 mV/div	5.9 ns	DC to 60 MHz

*Front panel reading. With P6047 deflection factor is 10X panel reading.

The Type 454 can trigger internally to above 150 MHz. Its calibrated sweep range is from 50 ns/div to 5 s/div, extending to 5 ns/div with the X10 magnifier on both the normal and delayed sweeps. The delayed sweep has a calibrated delay range from 1 μ s to 50 seconds.

For a demonstration, contact your nearby Tektronix field engineer, or write: Tektronix, Inc., P. O. Box 500, Beaverton, Oregon 97005.

Type 454 (complete with 2 P6047 and accessories)	\$2600
Rackmount Type R454 (complete with 2 P6047 and accessories)	\$2685
New Type 200-1 Scope-Mobile® Cart	\$ 75

U. S. Sales Prices FOB Beaverton, Oregon

Pulse fidelity

This double-exposure photograph shows the same 12-ns-wide pulse displayed on the Type 454 (upper display) and on a 7-ns, 50-MHz oscilloscope (lower display). Note the difference in detail of the pulse characteristics displayed on the Type 454 with its 2.4-ns risetime performance.

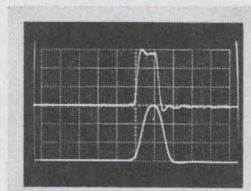

10 ns/div

5 ns/div delayed sweep

The delayed sweep is used to measure individual pulses in digital pulse trains. The Type 454 with its 1 μ s-to-50 s calibrated delay time, 5-ns/div sweep speed and 2.4-ns risetime permits high resolution measurements to be made. Upper trace is 1 μ s/div; lower trace is 5 ns/div.

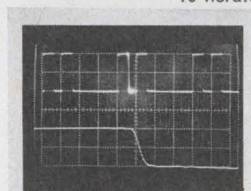

Double Exposure

X-Y

The upper display is a 150-MHz signal that is 50% modulated by a 2 kHz signal. The lower display is an X-Y trapezoidal modulation pattern showing the 150-MHz AM signal vertically (Y) and the 2 kHz modulation signal horizontally (X). Straight vertical line is the unmodulated carrier. Multiple exposure.

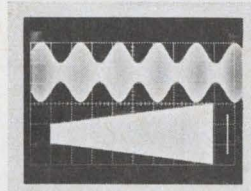

150 MHz AM



Coordinated research,
design and manufacturing



... part of the Tektronix commitment
to progress in the measurement sciences

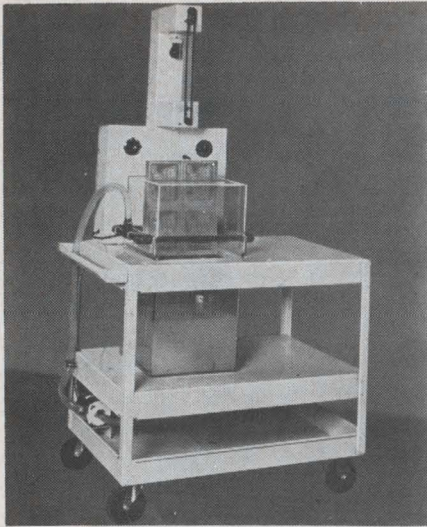

"fine line" etcher

for prototypes—limited runs

Model No. 201 (illus.), etches two 11" x 14" one-sided boards or one 11" x 14" two-sided board: **\$795** Pat. applied for

**ETCH YOUR OWN
P C BOARDS
AUTOMATICALLY**
(in less than 5 minutes)

from this →
to 11" x 14"

Shown Actual Size

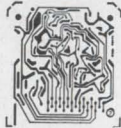

- No cooling or venting required!
- Etches as fine as .001"!
- Cuts costs in half—saves time!
- Complete photo processing instructions!
- Work is illuminated while etching!
- No patterning . . . minimum undercutting!

NOW IN USE BY:

AMP, Inc.
Ampex Corp.
Atomic Energy Com.
Bendix
Charles Brunning
Esso Research
General Dynamics
General Electric
IBM
ITT
Lear Siegler
Magnavox
Micro Switch
Owens-Illinois
Sonotone

Sprague Electric
Union Carbide
U.S. Air Force
Western Electric
Whirlpool
M.I.T.
Oklahoma State U.
Purdue Univ.
Washington Univ.
Univ. of Calif.
Univ. of Chicago
Univ. of Colorado
Univ. of Georgia
Univ. of Hawaii
Univ. of Penn.

CYCLO-TRONICS, INC.

3858 N. CICERO — CHICAGO, ILL. 60641
TELEPHONE: (312)-282-6141

Electronics Review

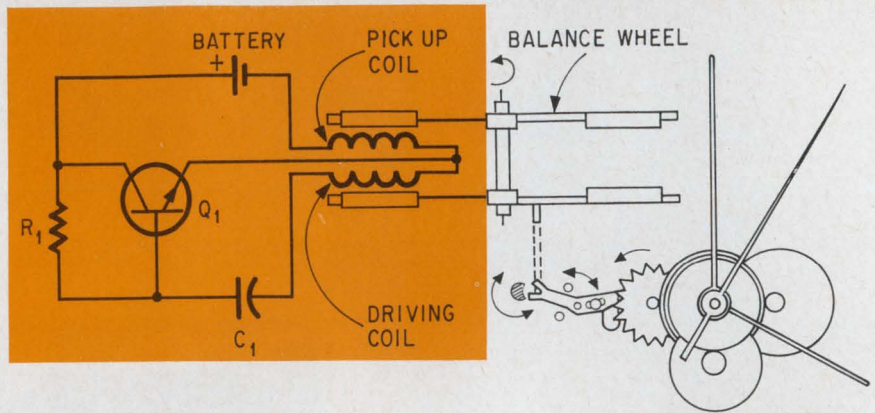

No hum. A transistor oscillator in this electronic watch controls the accuracy of the time piece's pendulum assembly.

duced by Timex, priced as low as \$39.95. These watches, however, are not electronic; a battery powers an electromechanical device, which drives the movement.

The Sheffield watch is guaranteed to be comparable in accuracy to any high-priced electronic watch on the market, according to the company's president, Henry A. Federman.

Fewer parts. The major difference between the Sheffield and others of its type is its simplicity. Unlike the Accutron, which employs an electromagnetic tuning fork in place of the balance wheel and hair-spring used by conventional watches, the Sheffield uses a simple rotor-type balance-wheel pendulum to drive the watch mechanism. This principle, Sheffield feels, is more suitable for mass production. The watch contains only nine moving parts, compared with about 15 for the tuning-fork controlled watches and an average of 24 for spring watches.

Electronic circuit. The Sheffield watch employs a Hartley-type oscillator to accurately maintain a permanent magnet-tipped pendulum assembly balance wheel that drives the watch movement at six swings per second. Initially, as the pendulum swings pass the oscillator coil, sandwiched between the magnet poles, it induces a voltage in the coil, causing capacitor C_1 (see above) to charge through the transistor.

Upon discharge, the capacitor voltage sets up an opposing magnetic field around the coil, which reacts with the magnet on the re-

turn swing of the pendulum to provide the necessary "kick" to sustain the balance wheel at a steady oscillating pace.

The circuit is powered by a 1.35-volt Mallory WH3 mercury cell that lasts 12 to 14 months. Suggested retail price of the cell is \$1.15.

Companies

Hands across the sea

To many small electronic firms the idea of selling in Europe is attractive, but a fear of import-export regulations and of undependable representation often causes marketing managers to shy away. The same is true of many European firms, which would otherwise sell their products in the U.S.

Now a three-year-old test-equipment builder, the Texscan Corp. of Indianapolis, is offering overseas marketing services to U.S. firms and stateside marketing for foreign companies. According to Robert J. Shevlot, general manager of Texscan's technical products division, the service costs nothing, involves no risk, and includes market research, advertising, and service facilities.

Why should an electronics firm wish to become an export-import house? Also, if there's no fee or risk to the client, how does Texscan make its profit?

Different approach. Texscan entered the business because it

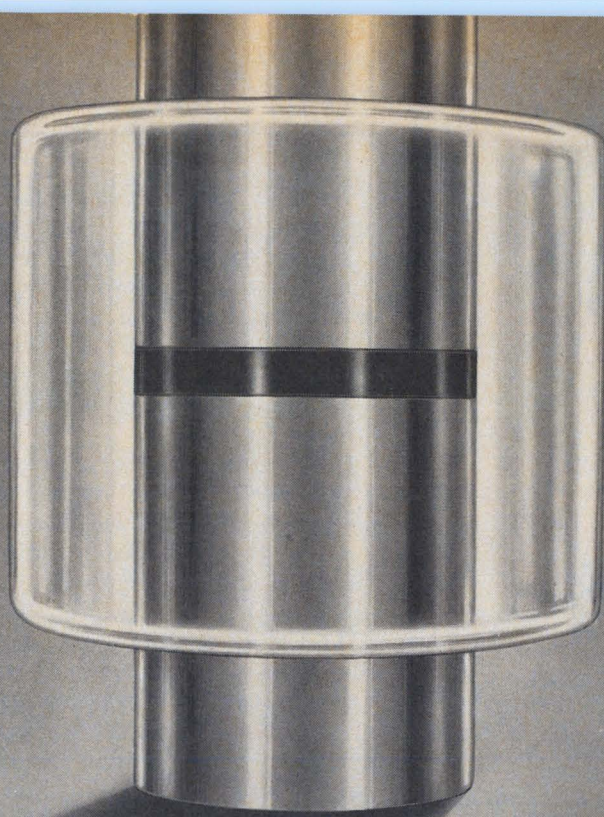

you are looking at the first... and only megawatt PIN microwave switching diode

- low cost . . . ultra-high reliability
- PIV's to 2KV
- Capacitance values suitable for X Band — to 0.5 pf
- Very low forward resistance — to 0.1 ohms
- 300 KW dissipation for 1 μ sec pulse
- 40 watt average dissipation
- Switches megawatts of peak power in duplexer applications
- Typical switching time — 1 μ sec

Two diodes can switch: 9KW average in UHF, 5KW average in S Band, or 2KW average in C Band, all with better than 0.1 db insertion loss, 20 db isolation, and 10% Bandwidth. Two more diodes will add 40 db of isolation. Unitrode. 580 Pleasant St., Watertown, Mass. 02172. Telephone: (617) 926-0404.

UNITRODE®

THE UNIQUE UNITRODE CONSTRUCTION

With the silicon die metallurgically bonded between terminal pins of the same thermal coefficient, the hard glass sleeve is fused to the entire outer silicon surface. Result — a voidless, monolithic structure.

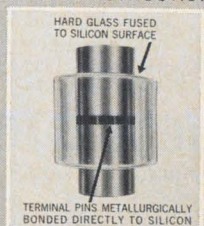

ACTUAL SIZE

Wedge-Action*

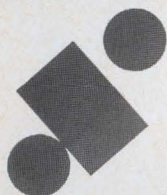

Relays

Hermetically-sealed, electromagnetic relays that provide high performance and reliability under the most difficult operating conditions in dry-circuit to 2 amp applications.

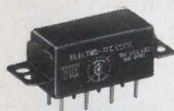

2 PDT
MARK II, SERIES 500
MIL-R-5757/9



2 PDT
MARK II, SERIES 400
(1.35" high)
SERIES 410 (1" high)
MIL-R-5757/8



6 PDT 4 PDT
(1" x 1")
MARK II, SERIES 300
(6 PDT).
SERIES 350 (4 PDT).
MIL-R-5757/1 and
MIL-R-5757/7



6 PDT
MARK II, SERIES 085
(-55°C to +85°C)
SERIES 100
(-65°C to +125°C),
SERIES 200
(-65°C to +200°C).
MIL-R-5757/1.

***Wedge-Action**



The moving contacts are mounted between two stationary contacts. On actuation, they drive into the stationary contacts, creating high pressures and low

contact resistance at all current levels. In addition, wedge-action contact wipe provides self-cleaning of the precious-metal contacts.

*Patent No. 2,866,046 and others pending.

For complete data write Relay Sales and Engineering Office, P. O. Box 667, Ormond Beach, Fla. 32074, Phone 904-677-1771, TWX 810-857-0305.

Electro-Tec Corp.

SLIP RINGS • RELAYS • SWITCHES

wanted to offer a broader line of electronic equipment. The eventual goal is a product line as broad as that of Hewlett-Packard or General Radio. The least costly way of broadening its line was to offer products already developed, with no engineering expense to amortize.

So Texscan now approaches companies here and abroad and offers to act as their export agency—but with the added features of technical knowhow and aggressive salesmanship.

The new venture grew out of Shevlot's own unhappiness with exporters while he was marketing manager for Telonic Industries and U.S. sales manager for England's EMI. "In effect, they take on your line and forget about you," he says.

Thus, when Texscan was formed in 1965, Shevlot decided he'd be his own exporter and went abroad to select his own representatives. He also set up Texscan Ltd. in Hertfordshire, England, to act as a watchdog. "Texscan wanted aggressive representatives and got them—now we look over their shoulders to make sure they stay aggressive."

As for the difficulties of acting as one's own exporter, Shevlot minimizes them: "A few extra forms to fill out, and a few more regulations to consider—not hard at all."

Evaluation, absorption. "Texscan evaluates the market for a client's product and estimates its sales potential," he says. Then it buys the products outright from U.S. or foreign firms and absorbs the costs of marketing, shipping, payments, and any currency devaluation.

In effect, foreign clients have access to a network of 100 stateside sales engineers and a Canadian representative organization—all on Texscan's payroll. U.S. companies penetrate Europe and Japan through Shevlot's hand-picked representatives, and their interests are guarded by Texscan Ltd.

Clients' products often bear Texscan's trademark. Client firms can sell under their own brand names if they wish, but often com-

panies without a name or image in the marketplace elect to have Texscan's label placed on their gear. All of the European clients follow this pattern.

Avionics

Introspective radar

As the electronics aboard airliners multiplies, so does the problem of finding ground maintenance people who can troubleshoot the complex equipment. That's why equipment which performs automatic self-testing and diagnosis is increasingly important to pilots and airlines.

The Radio Corp. of America thinks it has a good idea in its self-testing module that can be retrofitted to its AVQ/10 weather radar. With more than 3,000 of these weather radars in service aboard domestic and foreign airline jets, RCA expects as many as 1,000 to be retrofitted.

The modified AVQ/10 has self-testing features not included in the original design, and bridges the gap between that system and an even more sophisticated unit—the AVQ/30—being built to airline specifications for its use in supersonic airliners.

Finding faults. The older AVQ/10 could only meter crystal and magnetron current, and d-c voltage. The line technician had no way of knowing whether the magnetron was transmitting the power required. With the self-test modifications, he can measure magnetron power, monitor the voltage standing wave ratio of the waveguide antenna, and isolate faults in the unit. And the pilot can check the system's sensitivity time control and contour circuitry before or after takeoff.

Four of the upgraded AVQ/10's have been built for American Airlines and one has been successfully test-flown last month.

Checkout. To run a system diagnosis, the pilot flips a test switch on the radar controls. A 60-mega-

Mounting evidence shows the need for a new plastic power transistor.

Bendix announces the B-5001.

Characteristic	Limits			Test Conditions						
	Min	Max	Unit	V _{CB} V	V _{CE} V	I _C A	I _B mA	T _C °C		
V _{CEO}	35	—	V	14	25	0.2		25		
I _{CEO}	—	10	mA					25		
I _{CBO}	—	1.5	mA					150		
V _{BE}	—	1.2	V					14	0.5	25
h _{FE}	30	250	—					14	0.5	25
h _{FE}	20	—	—					14	1.0	25
V _{CE(s)}	—	1.2	V					1.0	50	25
Power Dissipation: P _T = 14.3 Watts at V _{CE} = 10 Volts, I _C = 1.43 Amps and T _C = 100°C										
Isolated Collector: 500 volts minimum isolation between transistor and mounting platform.										

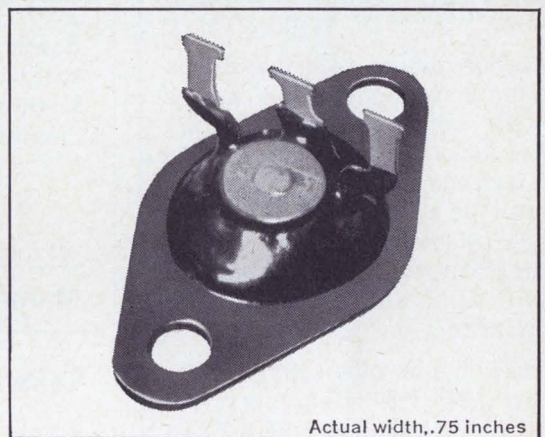

Actual width,.75 inches

A lot of people are using the Bendix® B-5000 plastic silicon power transistor we introduced last year. A lot of people would like to. Now they can. We've put the B-5000 in an easy-to-mount TO-66 configuration, and called it the B-5001. Same great electrical characteristics—with rugged lugs for easy connection.

A few things more. The new Bendix B-5001 silicon power transistor offers you electrical isolation. This means that the B-5001 mounts without insulating washers. Without sockets. Without extra hardware.

Electrical characteristics? 14.3 watts of power dissipation at 100° C. (That's as good as some manufacturers give you in nonisolated units.)

Uses? Audio power amplifiers, power supplies and a wide range of automotive applications. Price? The new B-5001 is the most economical plastic silicon power transistor you can use.

Any more questions about B-5001? Or the B-5000? Just call our nearest sales office. Bendix Semiconductor Division, Holmdel, New Jersey 07733.

Bendix **Electronics**

Chicago—(312) 637-6929; Dallas—(214) 357-1972; Detroit—(313) 548-2120; Greenwich, Conn.—(203) 869-7797; Holmdel, N.J.—(201) 946-9400; Lexington, Mass.—(617) 861-8350; Los Altos, Calif.—W. W. Posey Co., (415) 948-7771; Los Angeles—(213) 776-4100; Minneapolis—(612) 926-4633; Rochester, N.Y.—(716) 266-5550; Runnemede, N.J.—(609) 933-2550; Seattle—Ray Johnston Co., Inc. (206) LA 4-5170; Export—Cable: "Bendixint," 605 Third Avenue, New York, (212) 973-2121; Ottawa, Ont.—Computing Devices of Canada, P.O. Box 508—(613) 829-1800.

VCR FET

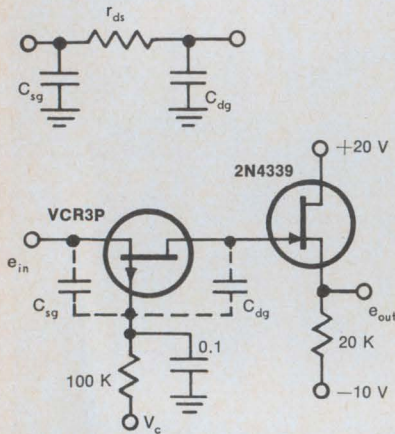

TUNABLE LOW PASS FILTER

SILICONIX ASSUMES NO RESPONSIBILITY FOR THE CIRCUIT SHOWN, OR DO THEY REPRESENT OR WARRANT THAT IT DOES NOT INFRINGE ANY PATENTS.

Corner frequency of this RC pi-filter is voltage tunable over a 100:1 range. A Siliconix VCR* has the equivalent circuit—drain resistance and gate capacitances form the pi. V_c controls the variation by changing r_{ds} . To change the frequency range . . . shunt the gate and source with fixed capacitors.

Build this or other circuits with the VCR FET Designer's Kit "DK6"—includes 6 VCR FETs worth \$30—available from your distributor for \$19.50. Check inquiry card or write . . . we'll be happy to send literature.

* VCRs are voltage controlled resistors—a new family of FET devices—featuring a variable resistance range of typically 10,000 to 1.



Siliconix incorporated

1140 W. Evelyn Avenue,
Sunnyvale, California 94086
Telephone (408) 245-1000
TWX: 910-339-9276

Electronics Review

hertz pulse-modulated test signal is put into the intermediate-frequency strip, transmission automatically shuts off and a test pattern of four three-mile-wide rings appears on the scope. If they are evenly spaced, the pilot knows the system is working properly. He can then adjust the intensity control for proper sweep trace level and the gain control for the proper contour of rings on the test pattern. This can be done before takeoff so the test module can be switched on when airborne without further adjustment. Testing also can be performed during flight.

RCA plans to issue a service bulletin to airlines, outlining advantages of the self-test modification, components required, and how to install and test them. The work can be done by the airlines themselves, although RCA probably will supply a modification kit. Cost of the module has not yet been determined.

Work on the test module for the AVQ/10 was independent of RCA's development of the AVQ/30, which will have even more automatic test features and built-in monitoring of circuitry.

Manufacturing

Take-apart laser

Solid state lasers have come a long way since the first ones were built in 1960, but their reliability still lags behind that of conventional machine tools. Many of the present generation of laser drills, welders, resistor trimmers, and dynamic balancers still suffer from faults that plagued the first laboratory devices—faults that must be corrected before lasers can make a dent in the multimillion-dollar production-equipment market.

The Applied Lasers division of Spacerays Inc. now feels it has an engineering approach that can minimize the laser's downtime, and will put its ideas to work in its forthcoming generation of equipment.

The Burlington, Mass., firm uses extra-rugged flashlamps as well as specially selected laser crystals to give its lasers a reliability cushion. But using such over-specified components where lesser ones would do is only part of the battle—flashlamps will still fail eventually, cavities will still tarnish, and pulse amplitude will still be uncertain.

Spacerays' answers to these problems are a power monitor-feedback circuit and—unique in the industry—a "breakaway" cavity.

Keeping tabs. An optional detector monitors the laser's output at each successive pulse; if the detector's output voltage drops, more power is fed to the flashlamp. The brighter flash compensates for the voltage drop and keeps the laser pulsing at the same amplitude time after time.

The monitor-feedback circuit thus overcomes flashlamp aging and cavity tarnishing—but only up to a certain point. A boost in pump power to compensate for the drop isn't enough at this point, and either the lamp must be replaced or the cavity polished. When this happens a panel lamp lights up, indicating to the operator that it's time to repair the laser.

Bad old days. In the early 1960's, flashlamp replacement was time-consuming. It meant taking apart the cavity, its cooling system, and its electrical connections. But re-assembling the parts in the right optical relationship was an even more difficult task. Engineers often fiddled for days to replace lamp and rod in just the right position to get maximum output.

To both simplify and speed such repairs, Spacerays came up with its breakaway cavity. Both single- and dual-elliptical cavities are machined in two parts, one holding the laser rod and the necessary mirrors and output optics, and the other holding the flashlamp and almost all of the reflective surface. The quick-disconnect coolant and electrical fittings make it possible to remove and replace everything but the laser rod in less than three minutes.

On a production line, spare cavities with prealigned flashlamps would be stored for replacement by the operator; the machining of the

Polaroid Land film makes you wait 10 seconds for an oscilloscope picture. The suspense can be unbearable.

We're sorry we can't do anything about that 10-second wait.

But if you can bear up under the strain, you'll get a sharply detailed, high-contrast, trace record.

You can study it, attach it to a report, send it as a test record along with a product shipment, or file it for future reference.

You also get a choice of four films for oscilloscope recording in pack, roll, and 4 x 5 formats.

The standard film has an ASA equivalent rating of 3000. And if you think that's fast, you haven't heard of our special film called Polaroid PolaScope Land film.

With an ASA equivalent rating of 10,000, it's the fastest thing in films. It can actually record a trace too fleeting for the human eye [for instance, a scintillation pulse with a rise time of less than 3 nanoseconds].

Of course, Polaroid Land films are as quick to point out a mistake as they are to point out a success.

If your trace shows an error, you know it right away. And you never go through the tedium of darkroom procedure only to find out that your blip was a blooper.

To use these films on your scope, you need a camera with a Polaroid Land Camera Back. Most manufacturers have them. Such as: Analab, Beattie-Coleman, BNK Associates, Fairchild, EG&G, General Atronics, Hewlett-Packard, and Tektronix.

You can get complete details by writing to one of these manufacturers or to Polaroid Corporation, Sales Department, Cambridge, Massachusetts 02139.

By the way, if 10 seconds fray your nerves, just imagine what it was like when Polaroid Land film made you wait 60 seconds to see your trace.

"Polaroid" and "PolaScope"®

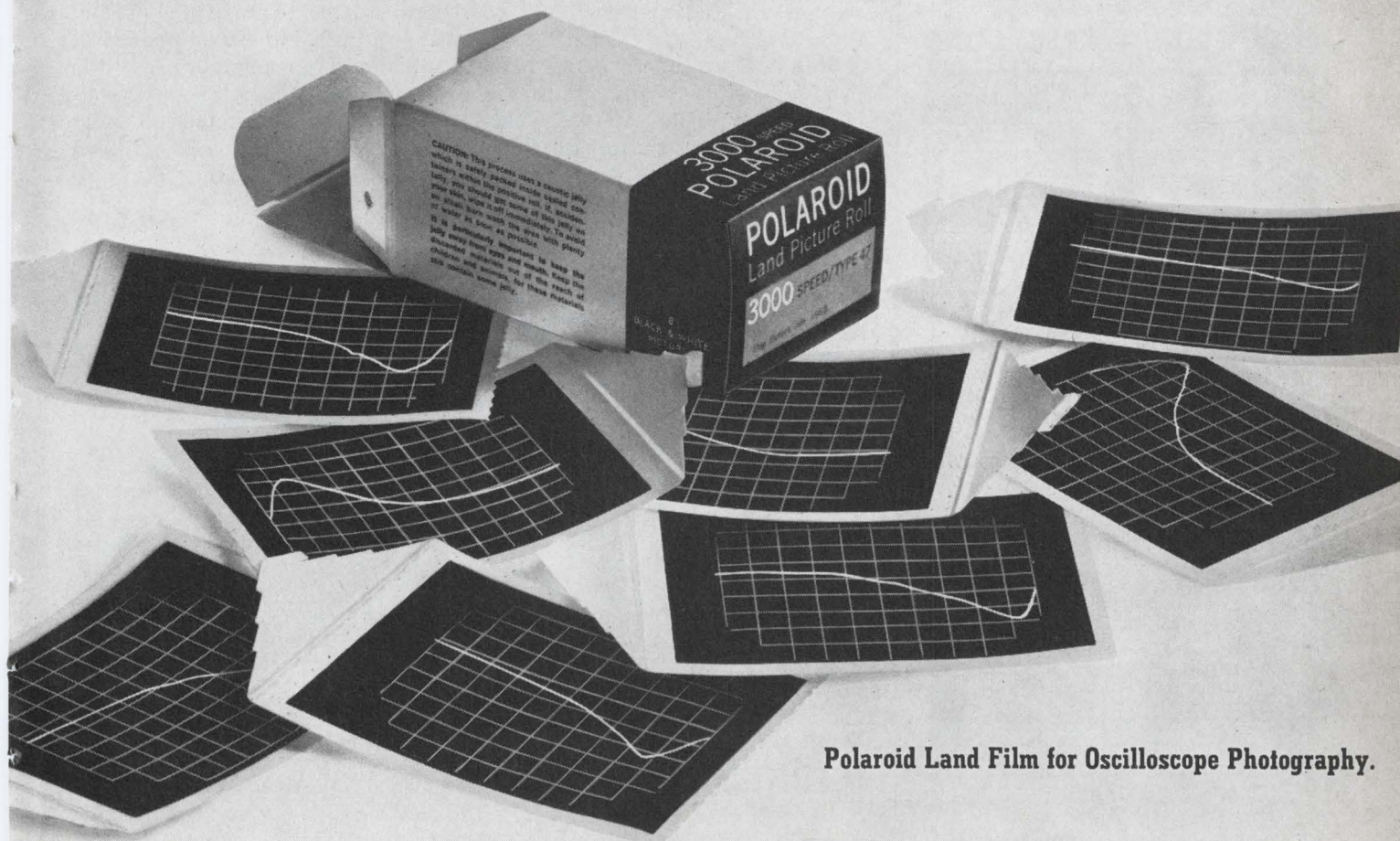

Polaroid Land Film for Oscilloscope Photography.



KEPCO POWER SUPPLIES

Kepeco's original CK design offers true automatic crossover operation with real equality of performance for both voltage regulation and current regulation. VIX® equipped, too. Panel mode lights show at a glance just how the power supply is regulating (with signal provisions for remote alarms, process control, etc.).



REGULATION 0.005% LINE — 0.01% LOAD

MODEL	DC OUTPUT		PRICE
	VOLTS	AMPS	
CK 2-8M	0-2	0-8	\$345.00
CK 8-5M	0-8	0-5	345.00
CK 18-3M	0-18	0-3	305.00
CK 36-1.5M	0-36	0-1.5	305.00
CK 40-0.8M	0-40	0-0.8	267.00
CK 60-0.5M	0-60	0-0.5	305.00

- Two Temperature Compensated Zener References and Two Ten-Turn Wirewound Controls (For both voltage and current modes)
- 16 Access Terminals for Operational Control (May be programmed by voltage, current or resistance commands)



WRITE DEPT. C-14
FOR LATEST CATALOG
CONTAINING COMPLETE
SPECIFICATIONS AND
APPLICATIONS NOTES



131-38 SANFORD AVE. • FLUSHING, N.Y. 11352
(212) 461-7000 • TWX #710-582-2631

cavity makes removal and replacement noncritical. The replacement cavity slips into place only .002 to .003 inch away from the position of the old one. After it's removed, the old cavity can be polished or repaired at leisure without slowing production.

Materials

Reclamation project

Don't write off tantalum scrap as a big loss. Metallurgical International Inc. has developed a process to reclaim the metal that can save money for manufacturers of tantalum capacitors.

Most capacitor makers sell their scrap and rejects for use in alloys and mill products. The going price for tantalum scrap is about \$10 a pound, a far cry from the original cost of the metal, which is about \$35 a pound. Metallurgical International, however, says capacitor-grade powder can be reclaimed for \$15 a pound. This could mean a big savings for the manufacturers of these devices.

Slug it. Once the capacitors have been reduced to tantalum slugs, the company, with its patented Cold-stream process, pulverizes them into a powder. The particles are then recirculated and passed

through a mesh until they are about the same size. A reactant gas then separates all impurities from the powder. Finally, a furnace draws off residual gas, leaving the powder, which, according to Ira L. Friedman, executive vice president of the New Shrewsbury, N.J., firm, "is at least as pure as powder made directly from tantalum ore."

Friedman says the shape of the particles is superior to that produced by conventional methods. Rather than being circular or dendritic, the reclaimed particles are irregularly shaped. Tight packing provides high capacitance and lessens the number of sharp points that invite voltage breakdown in capacitors.

Another spokesman for Metallurgical International says the Cold-stream process can also produce high-grade tantalum powder from virgin ore.

Jury still out. Samples of reclaimed powder are now being evaluated by several tantalum capacitor makers. A spokesman for P.R. Malloy & Co. in Indianapolis says the powder seems to live up to its billing. The Sprague Electric Co. of North Adams, Mass., which usually has from 5,000 to 10,000 pounds of tantalum scrap annually, says the powder seems to be of good quality. However, he is quick to point out that the evaluation hasn't been completed. Other firms are also running studies.

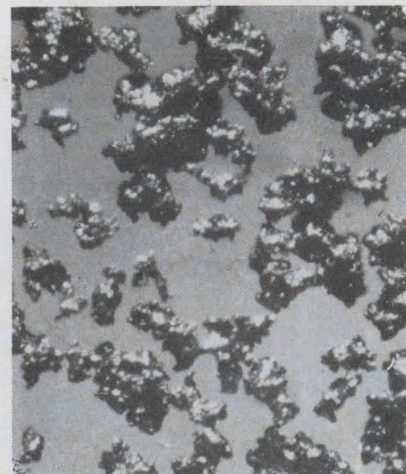
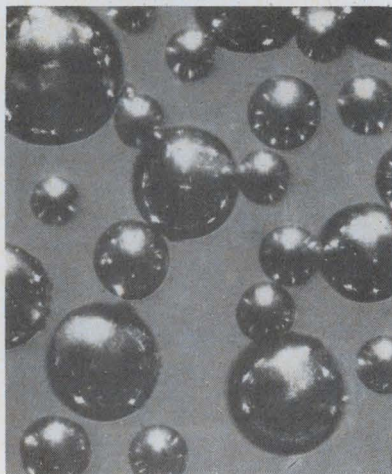

Before and after. Tantalum scrap can now be reclaimed and reused in capacitors. Conventionally produced powder, at left, is spherical, while reclaimed powder is irregularly shaped—resulting in better electrical characteristics.

**"Now we've put
two I/C op amps
on ONE chip
and, in one package!"**

We've put two of our popular MC1709 (μ A709) integrated circuit operational amplifiers in a single 14-pin dual in-line Unibloc* plastic package. We call it the MC1437P.

The result? A staggering 1,600,000,000-voltage gain figure, among other things. Enough gain to permit design of the most stable summing amplifiers, integrators, or other uses where external feedback is used. It is particularly useful for chopper-stabilized applications where extremely high gain is required with excellent stability.

With both MC1709 op amps on the same chip, you get superlative matching and tracking characteristics, too. (The MC1437P offers a low-

temperature drift of only $\pm 3 \mu\text{V}/^\circ\text{C}$, for example.) It also has the ability to swing almost the entire supply voltage — $V_{\text{out}} = \pm 14 \text{ V}$ typical @ 15 V supply. And, output impedance (Z_{out}) is only 30 ohms typical.

While you can't quite get two op amps for the price of one this way, it's pretty close — only \$8.50 (100-up) vs. \$6.00 for comparable single op amps!

For complete details on the MC1437P, or its 36,000,000-gain cousin, the MC1435P, drop us a note at Box 955, Phoenix, Arizona 85001. We'll include a copy of the WESCON paper, "A Dual Monolithic Operational Amplifier."

*Trademark of Motorola Inc.

where the priceless ingredient is care!



MOTOROLA Semiconductors

MOTOROLA SEMICONDUCTOR PRODUCTS INC. / P.O. BOX 955 / PHOENIX, ARIZONA 85001 / (602) 273-6900 / TWX 910-951-1334

New



SHOWN
ACTUAL SIZE

- New in name, packaging concept, reliability.**
- Mature** in engineering input and system usage.
- dataMOD is a "*generic name*" for a class of solid state modules designed to handle data.
- The "**260 Series**" dataMOD in particular could be called a "Differential Amplifier — Phase Sensitive DeModulator" (if you don't mind using an eye-loupe on the nameplate).
- For Use In:** Telemetry — Computation — Automatic Control — Phase Discrimination — Position Monitoring.
- Other Types or "Series":** to be announced subsequently.

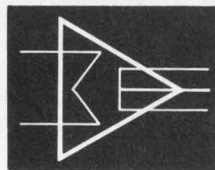

MAYBERRY ELECTRONICS CO.

543 West Manchester Blvd. Inglewood, Calif. 90301
Telephone: (213) 678-4847 TWX 910-328-6188

Electronics Review

For the record

Unexpected bill. Shareholders of Laboratory for Electronics Inc. received a double blow last month. The Internal Revenue Service hit them for \$4,840,000 in back taxes, plus interest. On top of that the Waltham, Mass., firm's second-half financial report showed that its Electronics division had pulled it \$1.4 million into the red for the six months ended Oct. 27. The division's loss must have been much higher, since LFE's other four divisions have been generating some profit.

The tax claim is based on the contention that LFE bought its Tracerlab and Keleket divisions with the aim of applying their losses to its own tax returns. Although LFE did use them as write-offs in 1962, 1963, and 1964, company spokesmen, from company president Henry Harding on down, deny that tax reasons were behind the acquisitions. Some securities analysts side with them, noting that in the early 1960's up to 98% of LFE's income was tied to a single F-105 avionics contract. Tracerlab and Keleket were acquired with the announced intention of broadening LFE's product line to include commercial markets. Its loss is tied to the fact that the Electronics division failed to deliver military avionics gear in time to avoid costly penalties.

Off base. The story describing efforts to develop a "computer on a slice" [Electronics, Nov. 27, p. 50] credited the Air Force's Rome Air Development Center, N.Y., for funding the work under way at Radio Corp. of America, Texas Instruments, and the Philco-Ford Microelectronics division. Wrong. The Wright-Patterson Air Force Base is putting up the money for the competing approaches to a large-scale integrated computer.

Pay plan. Texas Instruments will put all of its 25,000 hourly paid full-time employees on a salary basis starting Jan. 1. At the same time workers who are presently salaried but making less than \$1,100 a month will become eligible for overtime pay.

Your "ELECTRONICS TROUBLESHOOTER"

—help him meet the challenges of today's expensive...

INSTRUMENTATION CONTROLS
NUMERICAL CONTROL SYSTEMS
INDUSTRIAL COMMUNICATIONS SYSTEMS
ELECTRONIC INDUSTRIAL CONTROLS

WHATEVER HIS TITLE in your particular operation, the "Electronics Troubleshooter" is on the payroll to protect you against costly electronic equipment failure. But he can't guard your investment if his skills and know-how aren't every bit as up-to-date as your equipment.

Now there's a practical way you can "train up" your troubleshooters to meet the challenges of today's—and tomorrow's—complex equipment. It's the "Grow Your Own" Program developed by the Cleveland Institute of Electronics.

With this program, training materials and methods are "tailored" to the needs of your operation... and the capabilities of your employees. Training space and time are flexible. And "Grow Your Own" training can save you money and administrative time.

Want complete details? Just send the coupon below. Or, if you prefer, telephone collect—(216) 781-9400 and ask for Kenneth Ede, Vice President, Industrial Programs Division.



CIE Cleveland Institute of Electronics
1776 E. 17th St., Cleveland, Ohio 44114

Attention: Kenneth Ede, Vice President,
Industrial Programs Division

Please send me complete information on CIE's "Grow Your Own" training programs for Electronics Troubleshooters.

Name _____

Title _____

Firm _____

Address _____

City _____

State _____ Zip _____

E-32

NOW... BEAM LEAD DIODES in flip-chips, axial-lead microdiodes and multi-diode modules

You can now select from General Instrument's line of Beam Lead diode products, flip-chips, axial-lead microdiodes, and a complete line of multi-diode modules—all providing the extreme reliability of the Beam Lead structure.

The Beam Lead Technology:

General Instrument's Beam Lead devices consist of gold bonding leads extending beyond the edges of the chip—in cantilever form. Securely bonded to the silicon and its passivating layer, Beam Leads make ohmic contact through a highly stable and low resistance platinum alloy. Beam Leaded devices are prepared on the slice in a batch process, thereby lowering costs and providing the utmost uniformity between Beam Lead interconnected devices. Beam Lead technology creates a total chip/bond system which is unusually rugged and yields extremely reliable package bonds by a variety of techniques.

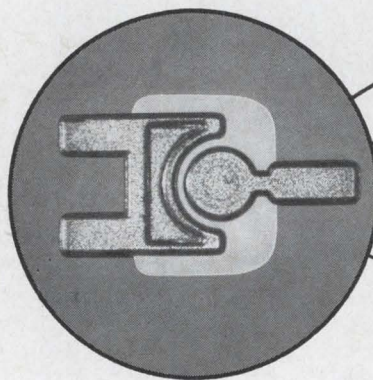

only from General Instrument

For information in Europe, write to: General Instrument Europe, Via Turati 28, Milano, Italy.

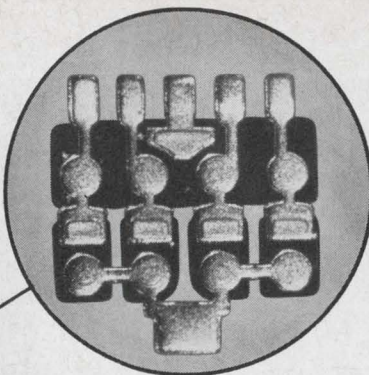

now available in...

Chips and Chip Arrays—for use in flip-chip bonding in a wide range of electrical parameters and circuit configurations. The cantilevered Beam Leads permit economic assembly to substrates without the use of eutectics, aluminum or thermal wire bonding. No bonding energy need be transmitted through the chip itself and, once formed, the bond is visually available for inspection. Discrete diode chips as well as diode arrays containing two to eight air isolated junctions are available.

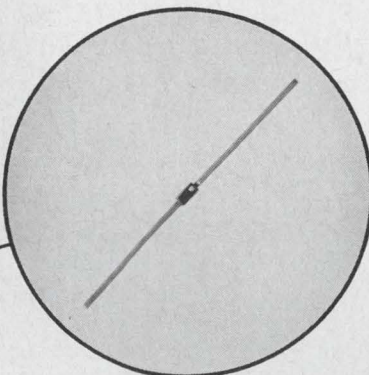

and in...

Beam Lead Microdiodes—in a small plastic axial-lead Microdiode which exceeds MIL moisture specifications. The Microdiode body measures only 40x40x80 mils. It has half inch long gold plated Kovar ribbon leads (5x20 mils). Life tests performed on General Instrument's Microdiode indicate a typical ΔI_r less than $1.5 \times I_r$ (orig.) at PRV and 25°C after 2000 hours at 150°C operating conditions.

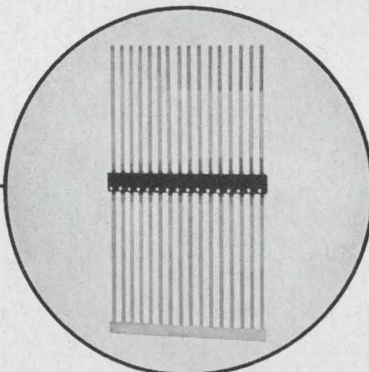

and in...

Beam Lead Microdiode Strips—as modular diode strips on 50 mil centers. The strip may comprise from two to twenty diodes in any combination of common anode, common cathode or discrete interconnections. They can be easily used to form large diode matrices for switching applications.

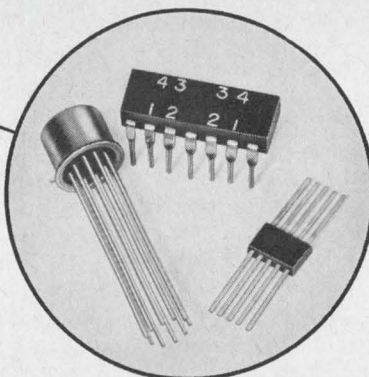

and in...

Beam Lead Diode Modules and Arrays—in any circuit configuration and in plastic or hermetic packages—both flat pack and dual in-line. The extreme stability and long life provided by Beam Lead bonding is assured. The use of Beam Lead isolation between junctions allows the production of switching and core driver modules with faster response times than obtainable by the usual monolithic approaches.

Write for full information.

GENERAL INSTRUMENT CORPORATION • 65 GOUVERNEUR STREET NEWARK, NEW JERSEY



PROBLEM: YOUR CIRCUITS NEED THE LOW COST OF HIGH VOLTAGE.

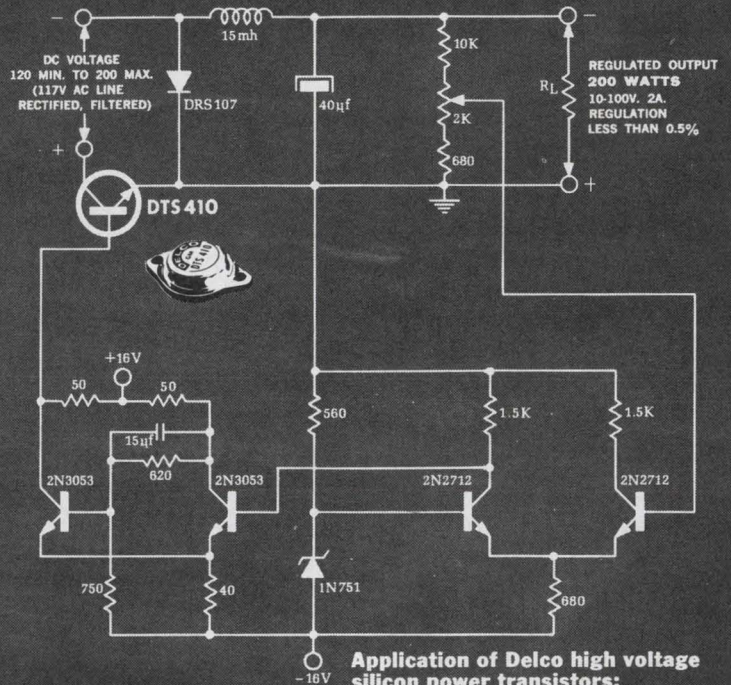

SOLUTION: DELCO SILICON POWER.

Application of Delco high voltage silicon power transistors: the switching regulator.

Delco high voltage silicon power transistors provide high energy capability at the lowest possible cost. Take the applications pictured above: switching regulators, DC to DC convertors and DC voltage regulators. Unit prices? Just \$1.70 for the DTS-410*, \$4.95 for the DTS-423* and \$3.95 for the DTS-413*.

There are other cost cutting advantages to our high voltage silicon power transistors. You can reduce the number and complexity of input-output and filtering components, which means more compact circuitry. Greater reliability. Lower assembly costs.

Other high energy circuits where Delco silicon power transistors have proved capabilities include: ultrasonic power supplies, VLF class C amplifiers, off-line class A audio output, and magnetic CRT deflection (several major TV manufacturers are using them in big screen horizontal and vertical sweep circuits).

They're available in production quantities. For prices, delivery, data, or applications information, just give us a call. Or call your local Delco distributor.

With Delco silicon power transistors, everything's high powered but the price.

*When purchased in quantities of 1,000 and up. Prices subject to change without notice.

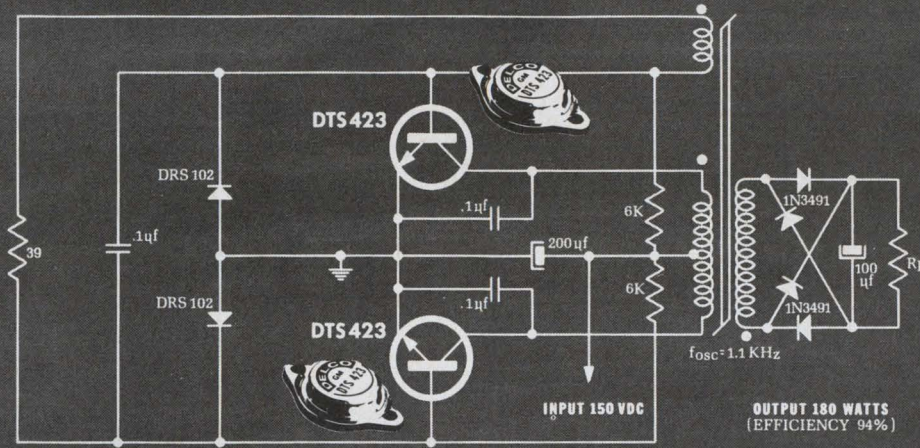

Application of Delco high voltage silicon power transistors: the DC to DC Converter.

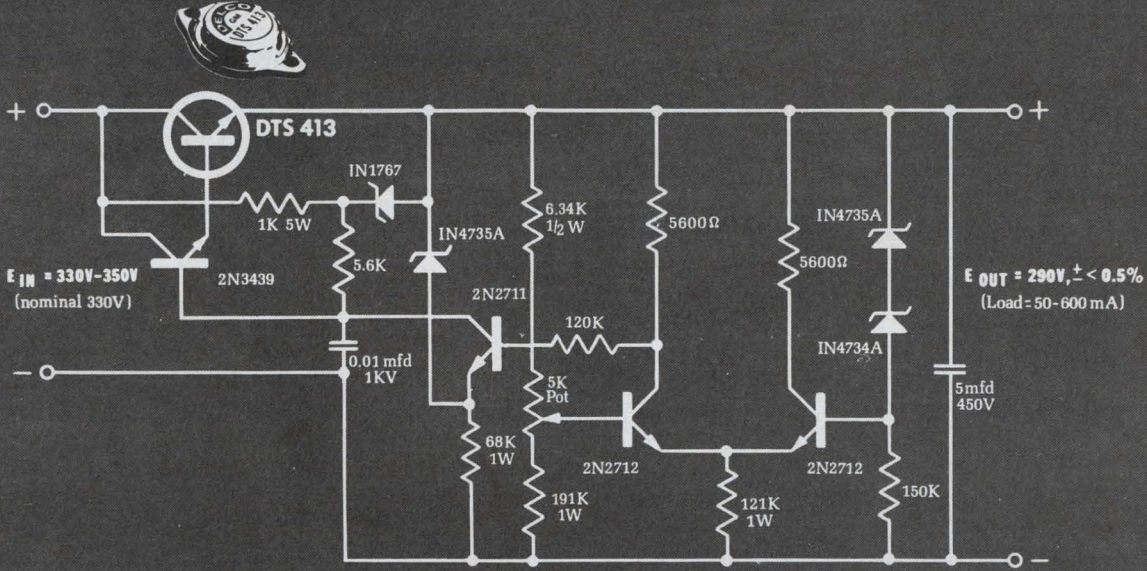

Application of Delco high voltage silicon power transistors: a DC voltage regulator.

TYPE	V _{CEX}	V _{CEO} (sus) min.	I _c max.	h _{FE} min. V _{CE} =5 V @ I _c	P _D max.	PRICE 1000-and-up QUANTITIES
DTS-410	200V	200V	3.5A	10 @ 2.5A	80W	\$1.70
DTS-411	300V	300V	3.5A	10 @ 2.5A	100W	\$2.20
DTS-413	400V	325V	2.0A	15 @ 1.0A	75W	\$3.95
DTS-423	400V	325V	3.5A	10 @ 2.5A	100W	\$4.95
DTS-424	700V	350V	3.5A	10 @ 2.5A	100W	\$7.00
DTS-425	700V	400V	3.5A	10 @ 2.5A	100W	\$10.00
DTS-430	400V	300V	5.0A	10 @ 3.5A	125W	\$12.00
DTS-431	400V	325V	5.0A	10 @ 3.5A	125W	\$18.00

NPN silicon transistors packaged in solid copper TO-3 case.

DELCO RADIO
Division of General Motors, Kokomo, Indiana



Field Sales Offices

Union, New Jersey* 07083
Box 1018 Chestnut Station
(201) 687-3770

Detroit, Michigan 48202
57 Harper Avenue
(313) 873-6560

Santa Monica, Calif.* 90401
726 Santa Monica Blvd.
(213) 870-8807

Syracuse, New York 13203
1054 James Street
(315) 472-2668

Chicago, Illinois* 60656
5151 N. Harlem Avenue
(312) 775-5411

General Sales Office:
700 E. Firmin, Kokomo, Ind. 46901
(317) 459-2175

*Office includes field lab and resident engineer for applications assistance.

Circle 65 on reader service card



**Good old,
reliable,
faithful,
trustworthy,
proven,
tested,
workable,
dependable,
consistent,
versatile,
Signetics
SP-600 series
is now
better than ever**

Guaranteed fan-out has been increased from 4 to 8. And the operating range is now 0°C to +75°C. Signetics SP-600 was the first DTL line in the industry to offer the convenience of the dual in-line silicone package. Find-out for yourself. Send for specs and reliability data based on two years of extensive testing. Write Signetics, 811 E. Arques, Sunnyvale, California 94086. Good old Signetics.



A SUBSIDIARY OF CORNING GLASS WORKS

SIGNETICS SALES OFFICES: Metropolitan New York (201) 992-3980; Upper New York State (315) 469-1072; Southwestern (214) 231-6344; Western Regional (213) 272-9421; Eastern Regional (617) 245-8200; Mid-Atlantic (609) 858-2864; Southeastern (813) 726-3734; Midwestern Regional (312) 259-8300; Northwestern (408) 738-2710.

DISTRIBUTORS: Compare at all locations listed below. Semiconductor Specialists, Inc. (312) 279-1000; Terminal Hudson Electronics (212) 243-5200; Wesco Electronics (213) 684-0880; Wesco Electronics (405) 968-3475; Hammond Electronics (305) 241-6601; Avnet Electronics Corp. of Massachusetts (617) 272-3060; Pioneer Standard Electronics Inc. (301) 427-3300.

DOMESTIC REPRESENTATIVES: Jack Pyle Company (415) 349-1266. Compare Corporation at the following locations: Alabama (205) 539-8476; Arizona (602) 947-4336; California (213) 245-1172; California (415) 697-6244; Colorado (303) 781-0912; Connecticut (203) 288-9276; Florida (305) 855-3964; Illinois (312) 775-5300; Maryland (301) 484-5400; Massachusetts (617) 969-7140; Michigan (313) 476-5758; Minnesota (612) 922-7011; Missouri (314) 428-5313; New Jersey (609) 429-1526; New Mexico (505) 265-1020; New York (518) 436-8536; New York (607) 723-8743; New York (716) 684-5731; New York (201) 471-6090; North Carolina (919) 724-0750; Ohio (216) 333-4120; Ohio (513) 878-2631; Texas (214) EM 3-1526; Texas (713) 649-5756; Washington (206) 725-7800.

INTERNATIONAL SALES: France, Germany, Italy, Belgium, Holland, Luxemburg, Spain—Sovcor Electronique, 11, Chemin de Ronde, Le Vesinet, (S.-&O.) France. United Kingdom, Ireland, Sweden, Denmark, Norway, Switzerland, Austria, Portugal—Electrosil Ltd., Lakeside Estate, Colnbrook-By-Pass Slough, Buckinghamshire, Great Britain. Australia—Corning, 1202 Plaza Building, Australia Square, Sydney, N.S.W. 27-4318. Canada—Corning Glass Works of Canada, Ltd., Leaside Plant, Ontario, Canada (416) 421-150. Israel—Optronix, P.O. Box 195, Ramat-Gan, Israel 724-437. Japan—ASAHI Glass Co., Ltd., Corning Products Sales Dept. No. 2, 3-Chome Marunouchi, Chiyoda-ku, Tokyo, Japan.

Washington Newsletter

December 11, 1967

Ssb gets high marks in satellite tests . . .

There's growing interest in the use of single-sideband modulation in frequency division multiplexing to give ground stations simultaneous, multiple access to communications satellites. Fanning this interest will be a report by NASA's Goddard Space Flight Center that **ssb has come through a year of tests with Applications Technology Satellite 1 with flying colors.**

Goddard researchers will report that the narrow-bandwidth ssb provides more signal energy with less noise than conventional frequency-modulation techniques, and may utilize the frequency spectrum more efficiently. The tests on the ground-to-satellite link utilized 5.6 megahertz base bandwidths to give 600 two-way circuits. Twelve to 24 active circuits were transmitted, plus noise loading to simulate all-channel use, and a signal-to-noise ratio of 40 decibels was measured. A Hughes microwave transponder converted the ssb signals into a phase-modulated single carrier that was retransmitted to all ground stations.

The ATS-1 tests went slowly at first because of problems with ground equipment. Distortion also was a major factor initially, but the ssb equipment is now operating at a distortion level of 1%.

. . . and endorsement in study for Comsat

Also taking a hard look at ssb techniques is the Communications Satellite Corp. Philco-Ford is putting the finishing touches on a \$500,000 study for Comsat of ssb and narrowband f-m techniques. **Its report, which will be delivered later this month, indicates that ssb is feasible for application in commercial satellite programs.** A Comsat official says there is a good chance that ssb equipment may be incorporated in the proposal for an aeronautical services satellite that the company is trying to sell the FAA.

Task force director named

President Johnson's task force on telecommunications finally has an executive director, but it doesn't look as if the group—which insiders say has been spinning its wheels up to now—will be able to meet its August 1968 deadline for a comprehensive study of a new U.S. communications policy.

Apparently because the right man couldn't be found outside the Government, Alan R. Novak, special assistant to Eugene V. Rostow, Undersecretary of State for political affairs, has been named to head the group. He had been running the task force in the absence of a staff director [Electronics, Nov. 27, p. 59]. Aiding Novak, as director of research, is Leland Johnson, formerly with the Rand Corp.

Seismic center gets off the ground

A computer center to provide definitive data on both the location and nature—nuclear or natural—of seismic events is in test operation in Washington. Called Seismic Array Analysis Center, it was built and installed by IBM for the Air Force Systems Command, which is acting as project manager for the Pentagon's Advanced Research Projects Agency. The center will be operational next year.

Data from the Large Aperture Seismic Array (LASA), made up of 525 seismometers installed in Montana in a ring about 125 miles in diameter, will feed into the analysis center to be processed by two IBM

Washington Newsletter

360/40 computers—one to search for a seismic event and the other to analyze it. A third computer—an IBM 360/44—will be used for “special” event analysis and research in seismic-signal processing. Tapes of known events, flown to the center, are being used in current test operations.

Double audit aimed at costs, not profits

Defense contractors, unhappy over the Pentagon’s double-check audits involving sole-source, fixed-price contracts [Electronics, Oct. 30, p. 57], will have at least one consolation: **the scope of the audit has been limited to cost factors.** Contractors feared the audit would be used to evaluate profit-cost relationships.

The Council of Defense and Space Industry Associations had urged deputy defense secretary Paul H. Nitze to rescind the double-audit order or, at the very least, modify it to prevent abuses by overzealous auditors. Nitze agreed to **soften the original order, and the amended version is now part of the armed services procurement regulations.**

EIA tearing down all-electronic wall

A merger of the Electronic Industries Association’s newly formed laser subdivision [Electronics, Nov. 13, p. 61] and the Laser Industry Association may be in the offing. The reason: the EIA is relaxing its “electronics-only” rule, opening the membership door to nonelectronic firms. This rule was one of the major reasons laser-equipment manufacturers—many of them optical firms—organized their own trade group.

Mobile radio group covets tv preserve

The frequency-spectrum battle between television and land mobile radio users is heating up. After three and a half years of studying the problem of crowded frequencies, a committee of land mobile radio users and makers has come up with an 800-plus-page report that concludes: “Genuine relief, which is needed immediately, can only be achieved by the allocation of additional spectrum to these services.” **The FCC-appointed panel didn’t specify the needed spectrum as that now reserved for tv, but that’s what it meant.**

With pressure building on Congress and the FCC to turn over more frequencies to land mobile users, the television industry is expected to demand that every means to improve utilization of existing spectrum by land mobile users be used before any allocation changes are made. Some of the changes under consideration, which the advisory committee says would provide only temporary relief, include reduction of channel spacing in the 450-megahertz band, relaxation of the block allocation system to permit channel sharing on a geographical basis, greater use of low-power channels, and introduction of one-way and nonvoice systems.

Addenda

Look for at least a 12% cutback—around \$1 billion—in the \$8 billion earmarked for Federal nonmilitary research and development in fiscal 1968. Affected will be the Department of Transportation, National Science Foundation, National Institutes of Health, and Atomic Energy Commission . . . The Air Force has delayed the announcement of the winner of a contract, expected to exceed \$100 million, to produce up to 150 computers for housekeeping duties at air bases. The date has slipped from Dec. 5 to Dec. 20. This is the second time around. IBM originally was picked for the job, but Congressional criticism of the award, sparked by competitors’ complaints, forced the Air Force to reopen the bidding.

If Freon* is the "high-priced" cleaning agent ...how is it that Miniature Precision Bearings estimates savings of \$5,400 a year?

Miniature Precision Bearings, of Keene, N. H., greatly reduced cleaning time with a combination of FREON solvents and a new ultrasonic vapor degreaser. The new unit, which utilizes FREON PCA and FREON T-WD 602, replaced an aqueous-based detergent system. The new system can clean up to 38,000 miniature bearing parts each 8-hour shift. Result: 75% reduction in cleaning time and greatly reduced solvent costs.

Encouraged by this performance (and by the performance of a similar system using FREON solvents in their new plant in Medemblik, Holland), Miniature Precision Bearings is considering similar equipment for its Standard Line white room. Methods Engineer James R. Walsh estimates that, because of reuse, solvent savings alone could hit \$4,000 a year. And because FREON solvents need be changed less often, there's an additional \$1,400 annual saving in maintenance costs.

FREON cuts solvent costs because, unlike many other solvents, it needs no inhibitors. Therefore, it's easy to clean and reuse again and again. MPB's new system uses only 50 gallons of FREON a month, with only one 3-hour change during that time. The former system required eight 3-hour changes a month. This reduction provides 21 extra hours of production time and almost eliminates overtime maintenance.

In addition to money savings, FREON does a better cleaning job. Being a dense liquid with low surface tension and high wetting power, FREON gets under dirt and literally forces oil-based contaminants off machined surfaces and from assemblies where tolerances are held to within 20 millionths of an inch.

How much can FREON, the "high-priced" cleaning agent, save you? Find out. Write: Du Pont Co., Room 5618, Wilmington, Del. 19898. (In Europe, write: Du Pont de Nemours International S.A., FREON Products Div., 81, Route de l'Aire, CH 1211 Geneva 24, Switzerland.)

*Reg. U.S. Pat. Off. for Du Pont's fluorocarbon cleaning agent.

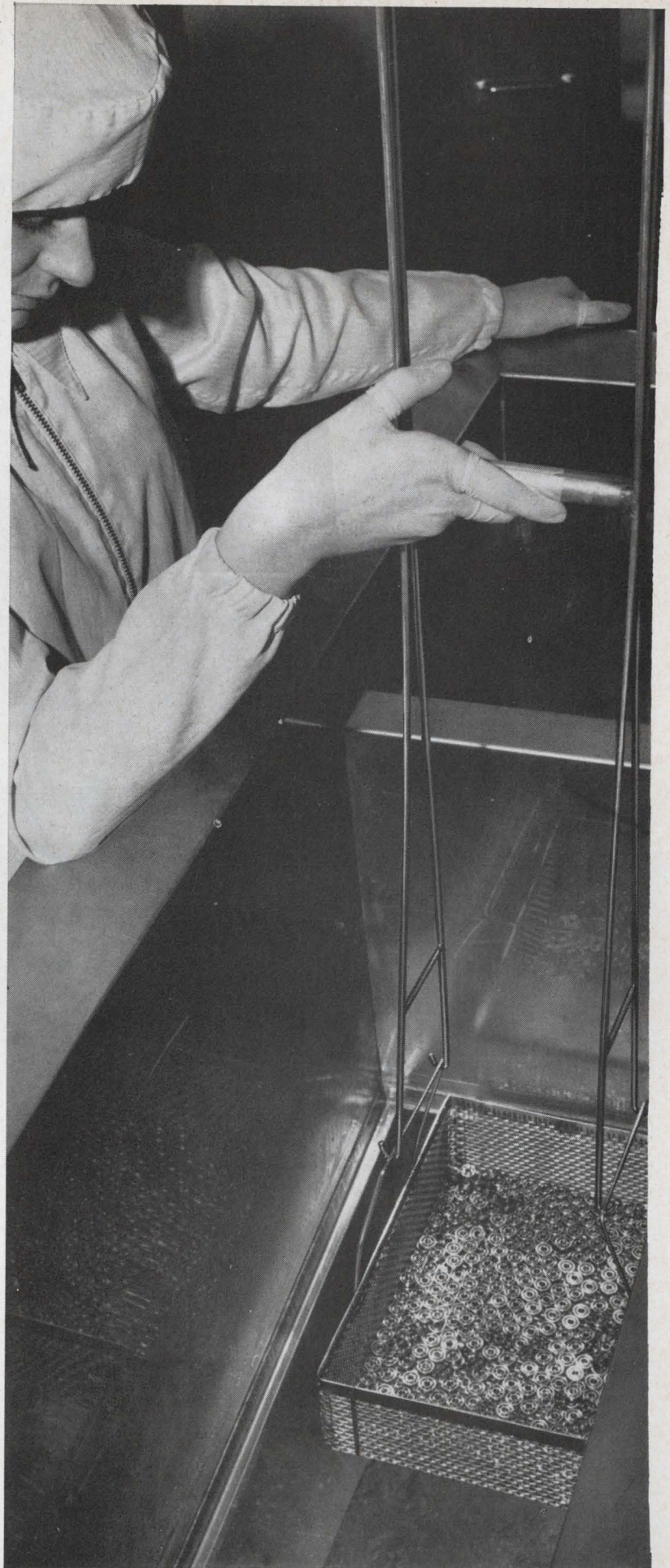

Build with 3 more linear IC innovations from RCA...

New Versatility for Commercial, Industrial, and Military Use

High-frequency wide-band amplifier/phase detector

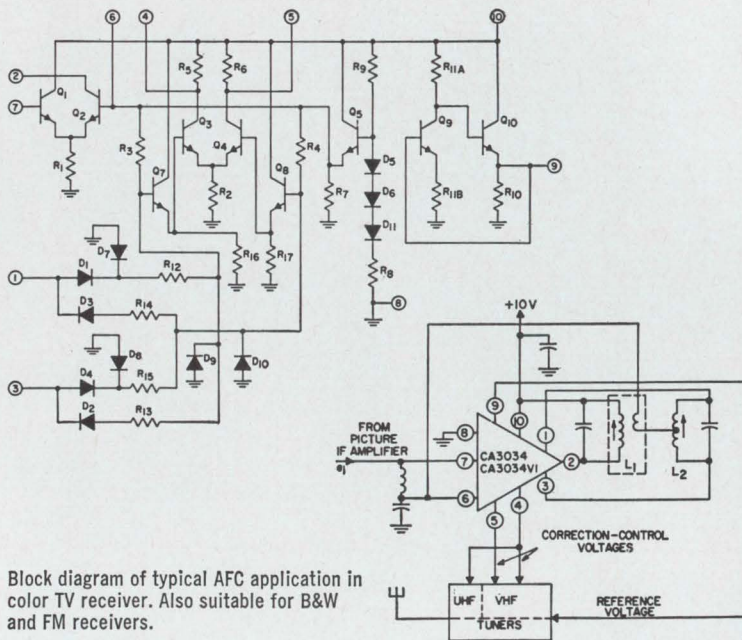

- For Automatic Fine Tuning in VHF and UHF receivers
- Dual phase detector with differential output amplifier
- Compensated reference voltage supply
- Operating temperature range -55°C to $+125^{\circ}\text{C}$
- Total current drain 9 mA (type) @ $V_{CC} = 10\text{V}$
- Output offset voltages between terminals #4 and #5 1.5V max. @ $V_{CC} = 10\text{V}$
- Input impedance 2K Ω typ

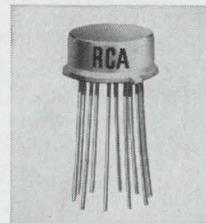

RCA CA3034 in 10-lead TO-5 package. Price \$1.75 (1000+)



RCA CA3034V1 with preformed leads. Price \$1.75 (1000+)

3-in-1 wide-band amplifier array— 132 dB (typ) Gain!

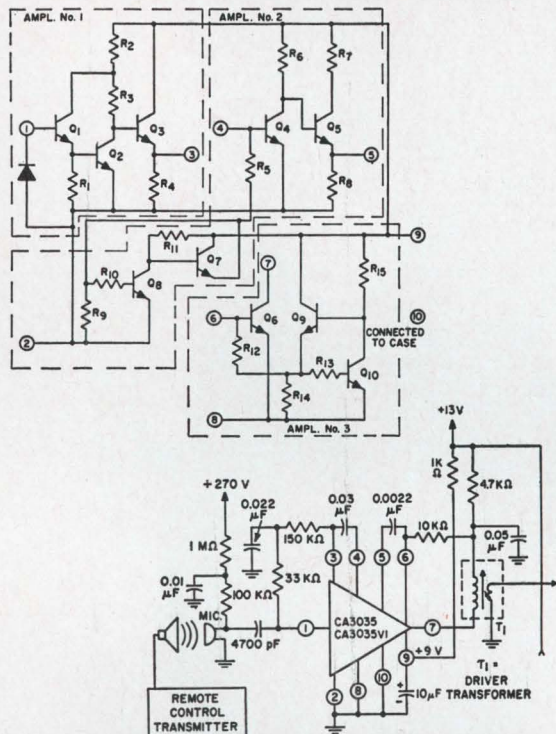

Low noise performance and outstanding wide-band response make this three-in-one unit general purpose amplifier array ideal for TV remote control.

- Three separate amplifiers; gain and bandwidth for each adjustable by external circuitry
- Can operate as individual units—or in cascade for 132 dB gain (typ) @ 40 KHz
- Voltage gain—Ampl. #1 44dB typ
Ampl. #2 46dB typ
Ampl. #3 42dB typ
- Bandwidth @ -3 dB point—Ampl. #1 500 KHz
Ampl. #2 2.5 MHz
Ampl. #3 2.5 MHz
- Operating temperature range -55°C to +125°C
- All three amplifiers single-ended, only one power supply needed
- Typical applications: TV remote control; IF systems; instrumentation amplifiers; chopper amplifiers

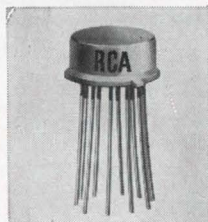

RCA CA3035 wide-band high-gain ampl. in TO-5 package. Price \$1.50 (1,000+)

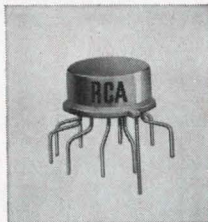

RCA CA3035V1 with preformed leads. Price \$1.50 (1,000+)

Dual Darlington amplifier array

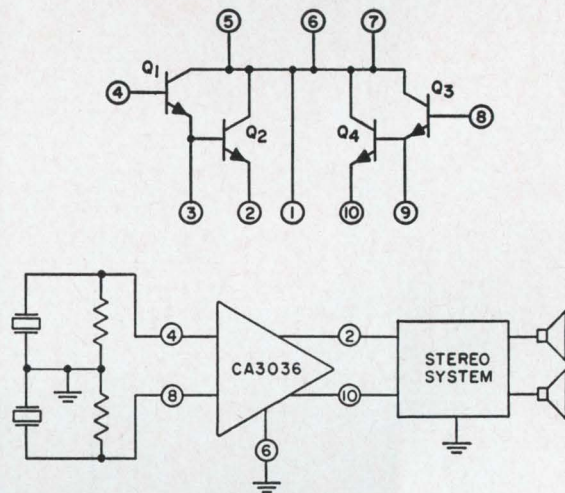

Block diagram of application as stereo phono pre-amp. Cartridges designed around the CA3036 can provide enhanced fidelity, low hum pick-up without shielding. Response flat to 1MHz @ $R_L = 1K\Omega$

- Voltage gain for either pair 26 dB (typ)
- Power gain for either pair 47 dB (typ) @ $f = 1$ KHz
- Gain-bandwidth product for either pair 200 MHz
- h_{FE} for either pair 4540 typ. @ $I_{C1} + I_{C2} = 1$ mA
- Operating temperature range -55°C to +125°C
- $V_{CE0} = 15$ V max.
- $V_{CB0} = 30$ V max.
- $V_{EB0} = 5$ V max.
- I_C (each transistor) = 50 mA max.
- Emitter-follower output
- Typical applications: stereo phono amplifiers; differential amps; op amp driver; mixer

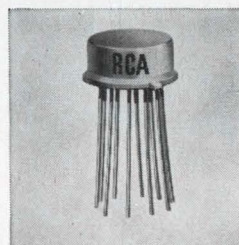

RCA CA3036 Dual Darlington Array in 10-lead TO-5 package. Price 98¢ (1,000+)

Ask your RCA Distributor for his price and delivery. For Technical Data write to RCA Commercial Engineering Section ICN12-2, Harrison, N.J. 07029.

RCA ELECTRONIC COMPONENTS & DEVICES



The Most Trusted Name
in Electronics

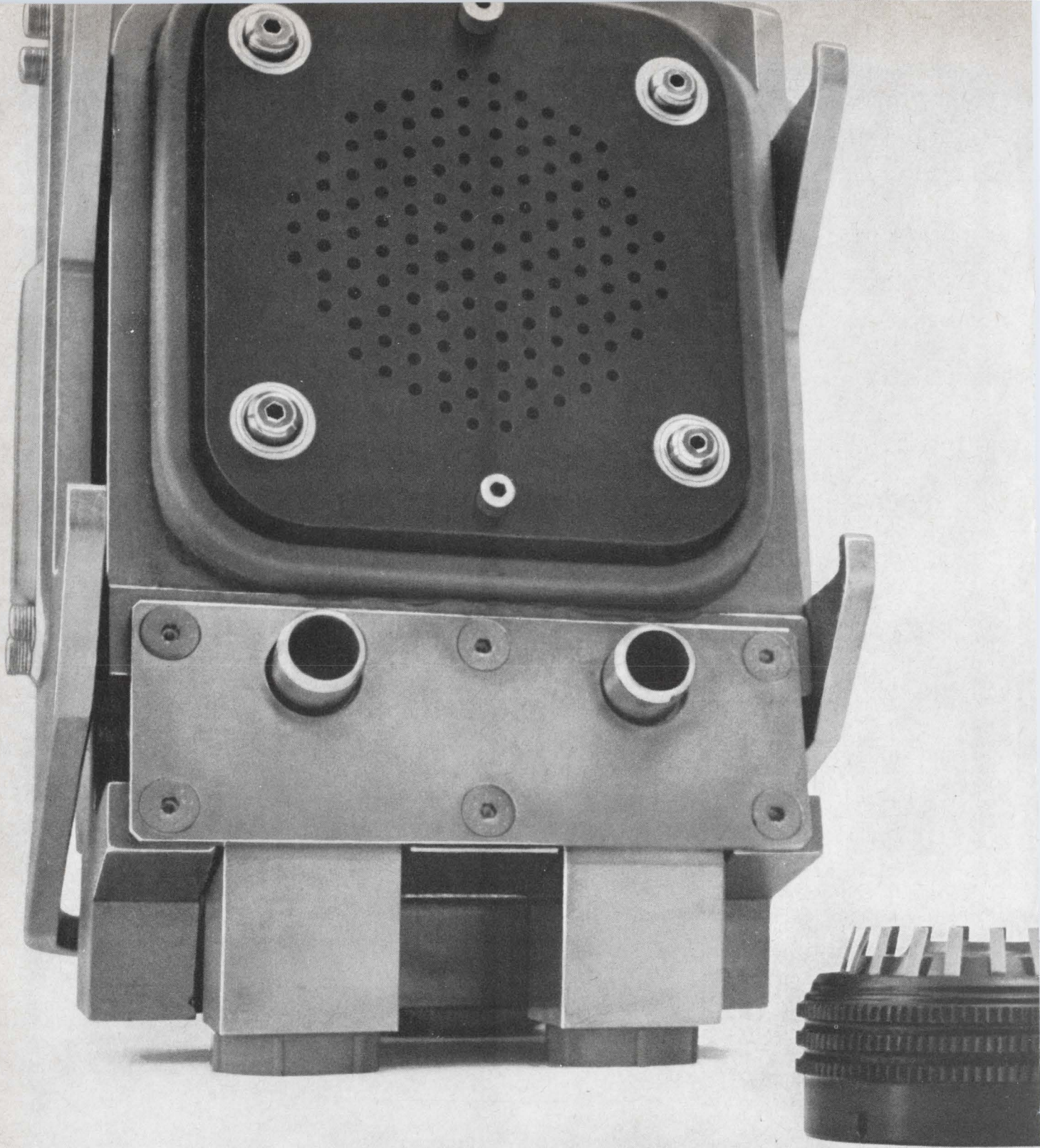

**First-of-a-kind connectors for sale
from Amphenol Space And Missile Systems**

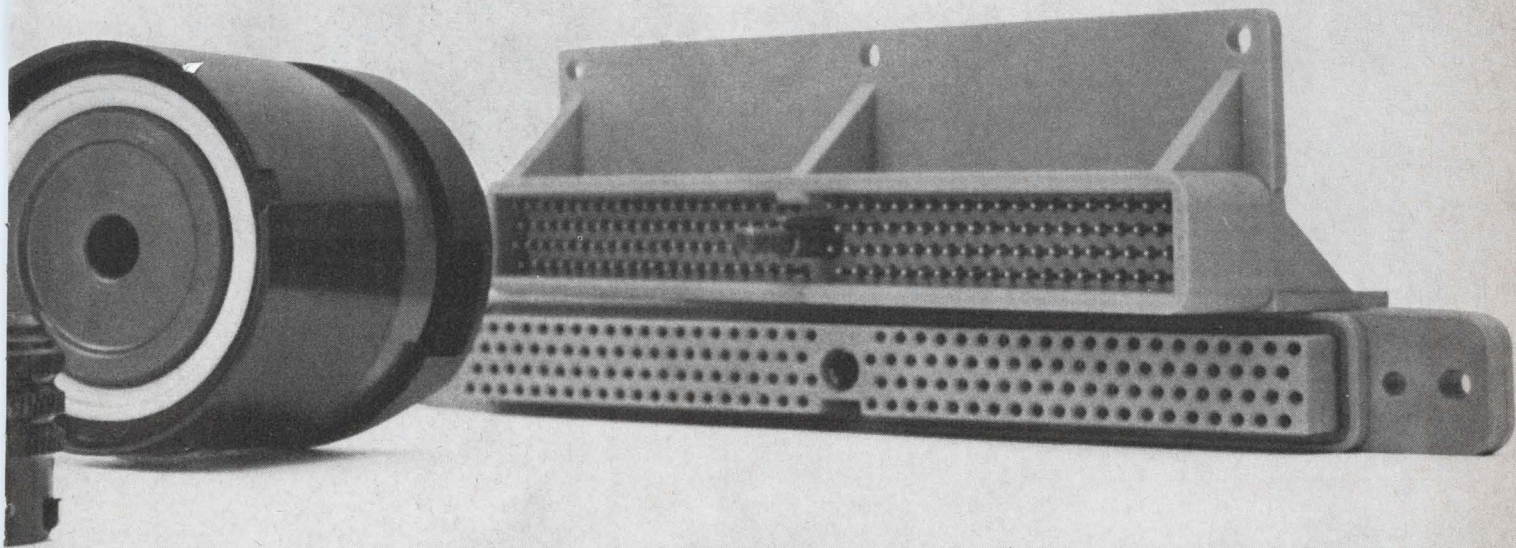

Sometimes the right connector doesn't appear in a catalog. Especially when it's destined for unusual uses.

That's why we developed our S A M S facility—to provide new solutions to interconnection problems.

At Amphenol, we've designed and produced interconnecting systems

for Minuteman, Titan, Agena, SST, and Poseidon—to name a few. Our mission profile includes every type of application from GSE to satellites. Every connector type, too. Some carry several hundred circuits, withstand 1000F, offer "dead-facing" or resist exotic fuel corrosion damage.

Ask us to help you solve your interconnection problems. Write us. **Amphenol Connector Division**, Chatsworth, California 91311.



AMPHENOL

Circle 73 on reader service card

Specify Amphenol . . . the leading name in cable, connectors, assemblies, RF switches, potentiometers, microelectronics.

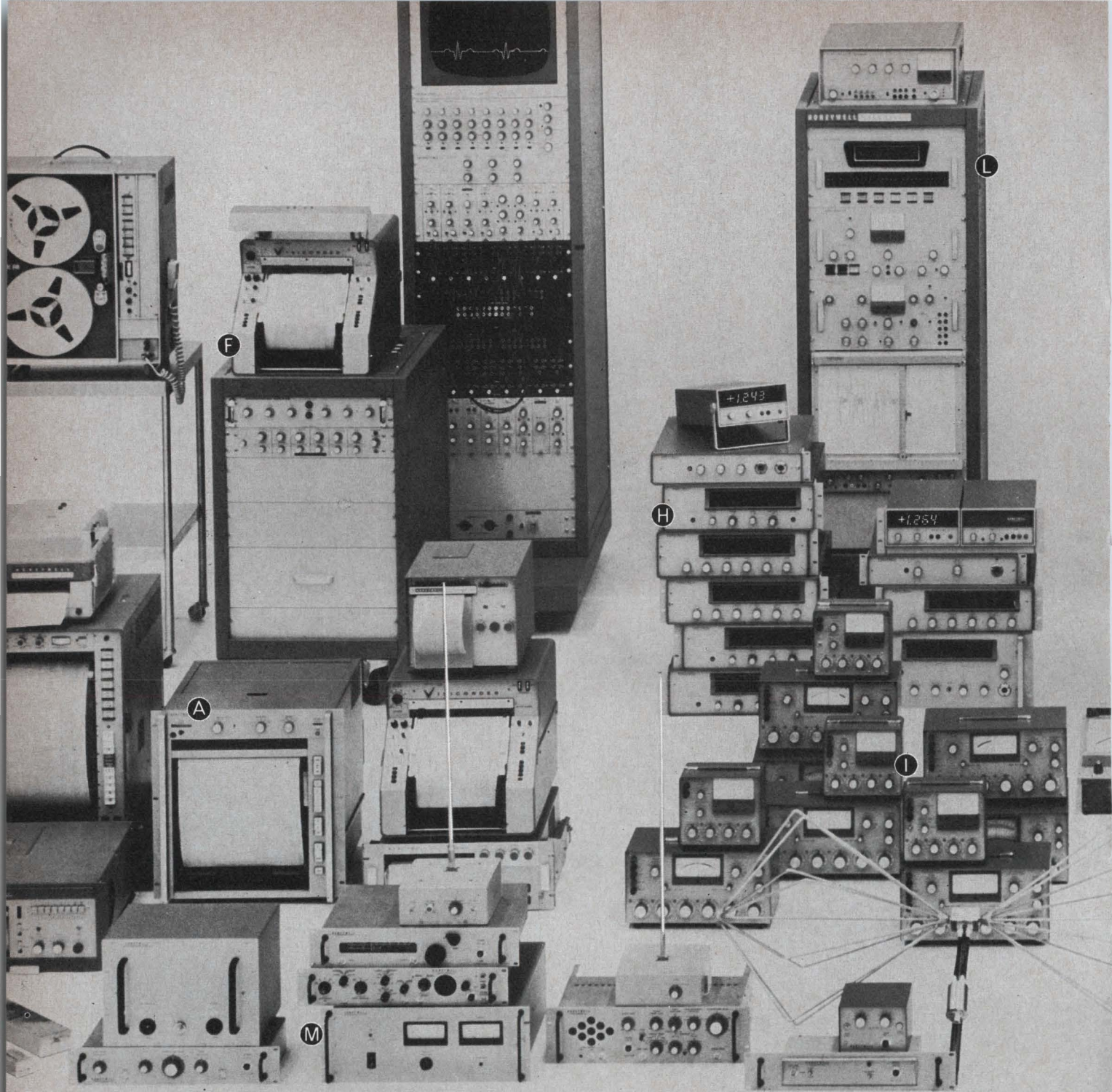

Here's just part of the full Honeywell line, which includes: **A** 117 Visicorder direct-recording oscillographs in 6", 8", and 12" models; **B** 2 Model 1806 fiber-optics CRT Visicorder oscillographs; **C** 26 magnetic tape systems, including the 7600 Series in 10½" and 15" reel versions; **D** 84 amplifiers and other signal-condi-

We build **847**
 instruments to be sure we
 have the exact **1** you need.

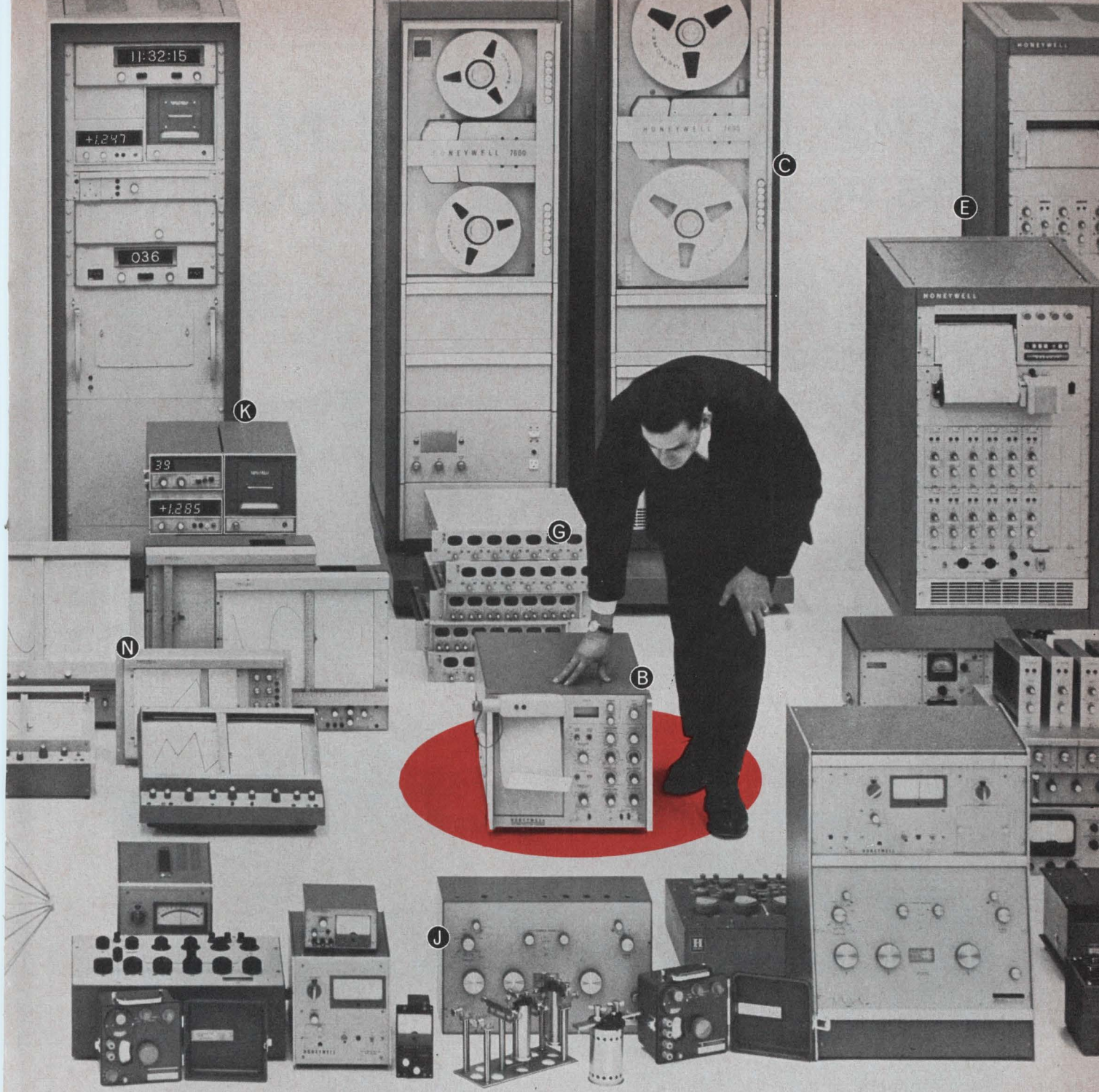

tioning units; **E** 78 analog recording systems; **F** 46 electronic medical systems; **G** 14 oscilloscopes; **H** 37 digital multimeters; **I** 29 differential voltmeters; **J** 179 precision laboratory standards and test instruments; **K** 128 data loggers; **L** 9 analysis systems; **M** 61 EMI products; **N** 37 X-Y graphic recorders.

Your Honeywell sales engineer can zero in on the *precise* solution to your instrumentation problems. Quickly and efficiently. You won't have to settle for "almost" what you need because the Honeywell sales engineer isn't handicapped by a limited line. He can choose from 847 basic instruments whose combinations and permutations approach the infinite.

The solution might be a Visicorder recording oscillograph. Or one of our modular magnetic tape systems. Or an X-Y recorder, a digital multimeter, or a portable potentiometer. But whether it's a single instrument or a complete data system, you can be sure the solution will be the right one, carefully thought out with your future requirements considered as well as your current needs.

Local service and nationwide metrology facilities back up your Honeywell instrument or system. And, we can even provide factory training courses for *your* operating personnel. For the full story on how Honeywell can help you, call your local sales engineer or write: Honeywell, Test Instruments Division, Denver, Colorado 80217.

Honeywell

Honeywell engineers
sell solutions

Circle 75 on reader service card

.050" CONTACT CENTERS 1/16" PC BOARD/BELLOWS CONTACT

NEW MICROMINIATURE PRINTED CIRCUIT CONNECTORS...

your choice of 10, 14, 22, 40, 55 and 64 dual contacts now available with Series 600-6 microminiature printed circuit connectors. Single piece body molding is glass reinforced Diallyl Phthalate Type SDG per MIL-M-14 specifications.

For complete specifications and outline drawings ask for free brochure 6002-667, Advertising Department, Continental Connector Corporation, 34-63 56th Street, Woodside, N.Y. 11377. Or phone (212) 899-4422 for immediate action.

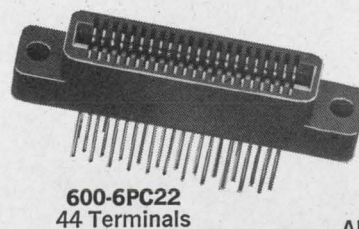
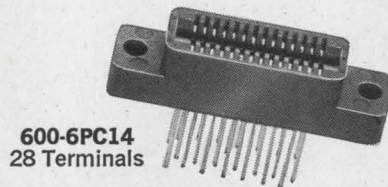

**Series 600-6
Complete Line
Now Available**

ALL CONNECTORS
SHOWN ACTUAL SIZE

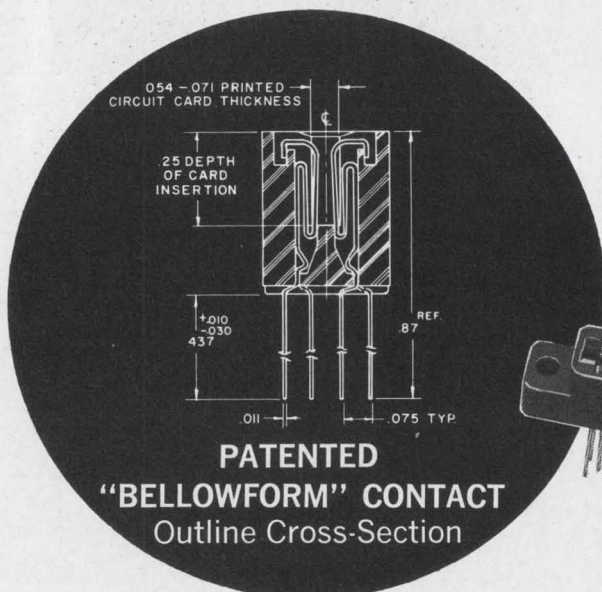
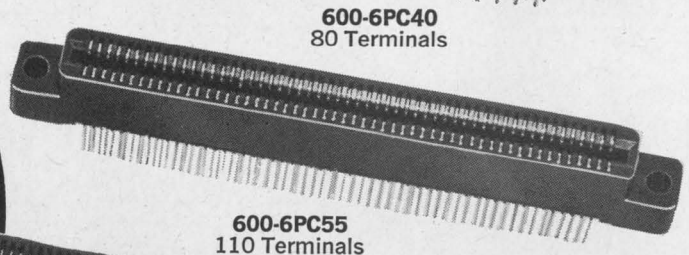
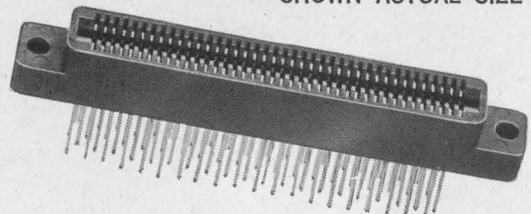

For the Sales Representative Nearest You, See Our Listings in EEM and VSMF Directories.

CONTINENTAL CONNECTORS

CONTINENTAL CONNECTOR CORPORATION ■ WOODSIDE, NEW YORK 11377

**Frenchtown/CFI
can make you
5,000,000 ceramic
transistor bases
a week**

**...or 5,000 ceramic
missile gas generator
igniter insulators
a year**

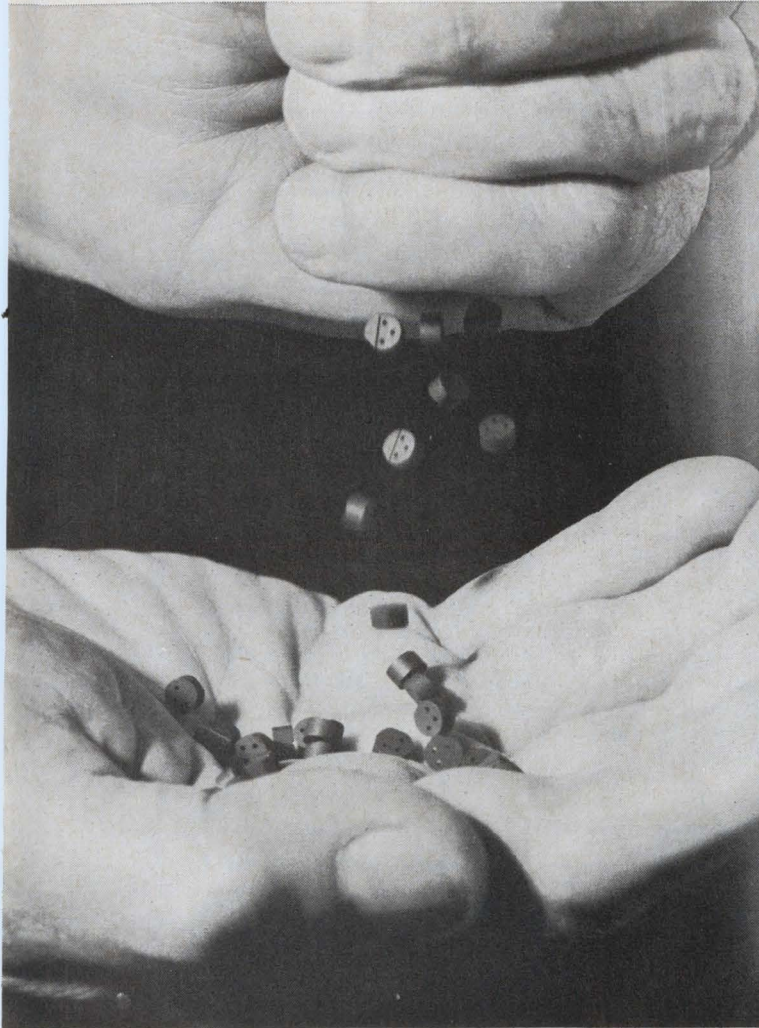

For high volume, custom-made alumina and beryllia ceramic products, astute buyers make sure to contact Frenchtown/CFI, Inc. Shipping rates of more than 5,000,000 pressed parts per week are easily maintained—month after month after month.

For complex parts, too, Frenchtown/CFI is a prime source. You can get them large or small, moly-manganese or gold-platinum metallized. Intricately shaped. Assem-

bled to other ceramics or metal parts. Optically flat. Hermetically sealed.

Whether your application is electronic, electrical, mechanical or chemical, consult Frenchtown/CFI on problems of ceramic production, metallizing and sealing. You can save weeks on your timetable. Describe your need and request a proposal. (We'll send you an informative brochure too.) For fast action call:

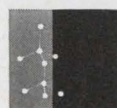

FRENCHTOWN/CFI, INC.

A subsidiary of Alloys Unlimited, Inc.

Eighth Street, Frenchtown, New Jersey 08825
(201) 996-2121

FRENCHTOWN/CFI MEANS CERAMICS FOR INDUSTRY

left photo: 92% alumina—opaque—TO 18 configuration.

right photo: 96% alumina-to-Kovar seal—withstands 8,000 psi.

Circle 77 on reader service card

Don't buy a DVM— buy a measuring system. It's cheaper that way.

Because we designed our new DVM as part of an expandable measuring system, you get a complete digital voltmeter at a price of only \$580. But you also get much more . . .

The only system that will accept two function modules at a time.

The digital display unit is the focus. Plug in one module, and you've got a DVM for measuring DC. Add another, and you can measure AC. Substitute others and you can measure frequency, period, time intervals and other parameters.

Our new Model 6200 DVM doesn't cost much more than a multimeter. But it's 10 to 30 times more

accurate. It's linear over the entire range. You change voltage ranges just by pressing buttons. You read off the voltage value as a number. You don't have to work at interpreting scales.

And the plug-in concept is the topper. Buy a plug-in for whatever function you need at a fraction of the cost of a single-purpose instrument.

For a demonstration, call (201) 229-4400. Or write for a complete technical description.

EAI[®] ELECTRONIC ASSOCIATES, INC.
West Long Branch, New Jersey

MODEL 6200 DISPLAY UNIT with long-life Nixie tube readout accepts two modules simultaneously. Gives you 4-place digital readout and "mix-or-match" of modules for flexibility. Compact: half rack width. Solid-state silicon and I.C. circuitry.

MODEL 6201 DVM MODULE. Measures DC voltages in 5 ranges from 100.0 mv to 1000 volts. Accuracy is $\pm 0.1\% \pm 1$ digit. Features: Push-button ranging. Automatic polarity selection. Integrating function for high accuracy even with a background of hum and noise. 40% overrange on 4 most sensitive ranges.

MODEL 6203 AC CONVERTER MODULE. Measures AC voltages accurately over a wide frequency range. Four pushbutton ranges to 300 volts rms. Frequencies from 20 Hz to 100 KHz. Used in conjunction with DVM Module.

MODEL 6202 COUNTER MODULE. Measures frequencies to 10 MHz with $\pm 0.005\% \pm 1$ count accuracy. Measures period or time intervals from 1 microsecond to 1000 seconds with 1 microsecond ± 1 count resolution.

JUST ADDED: MODEL 6240 RACK MOUNTED DVM. Self-contained DC DVM with optional BCD output and Model 6241 expansion chassis for plug-in modules.

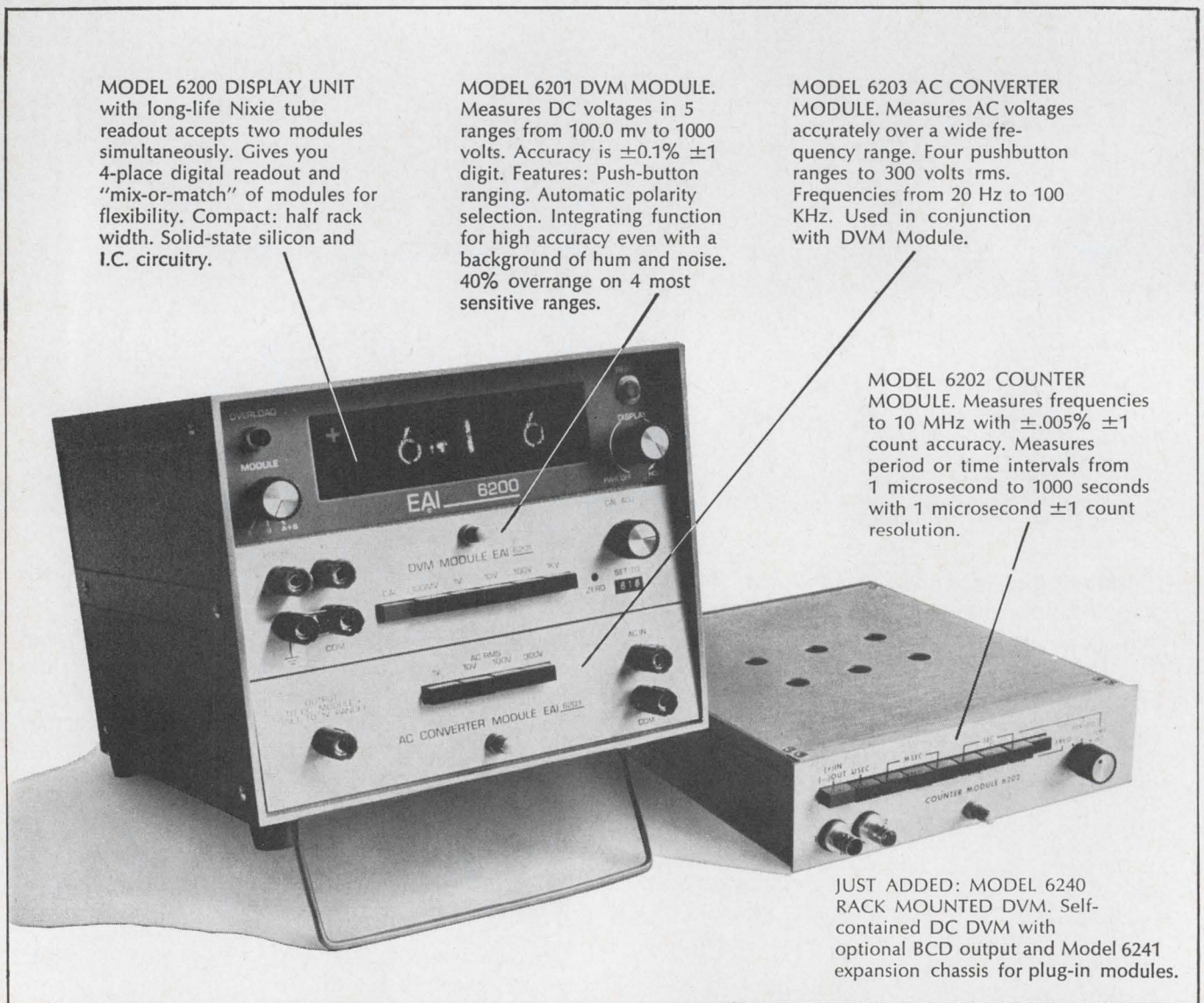

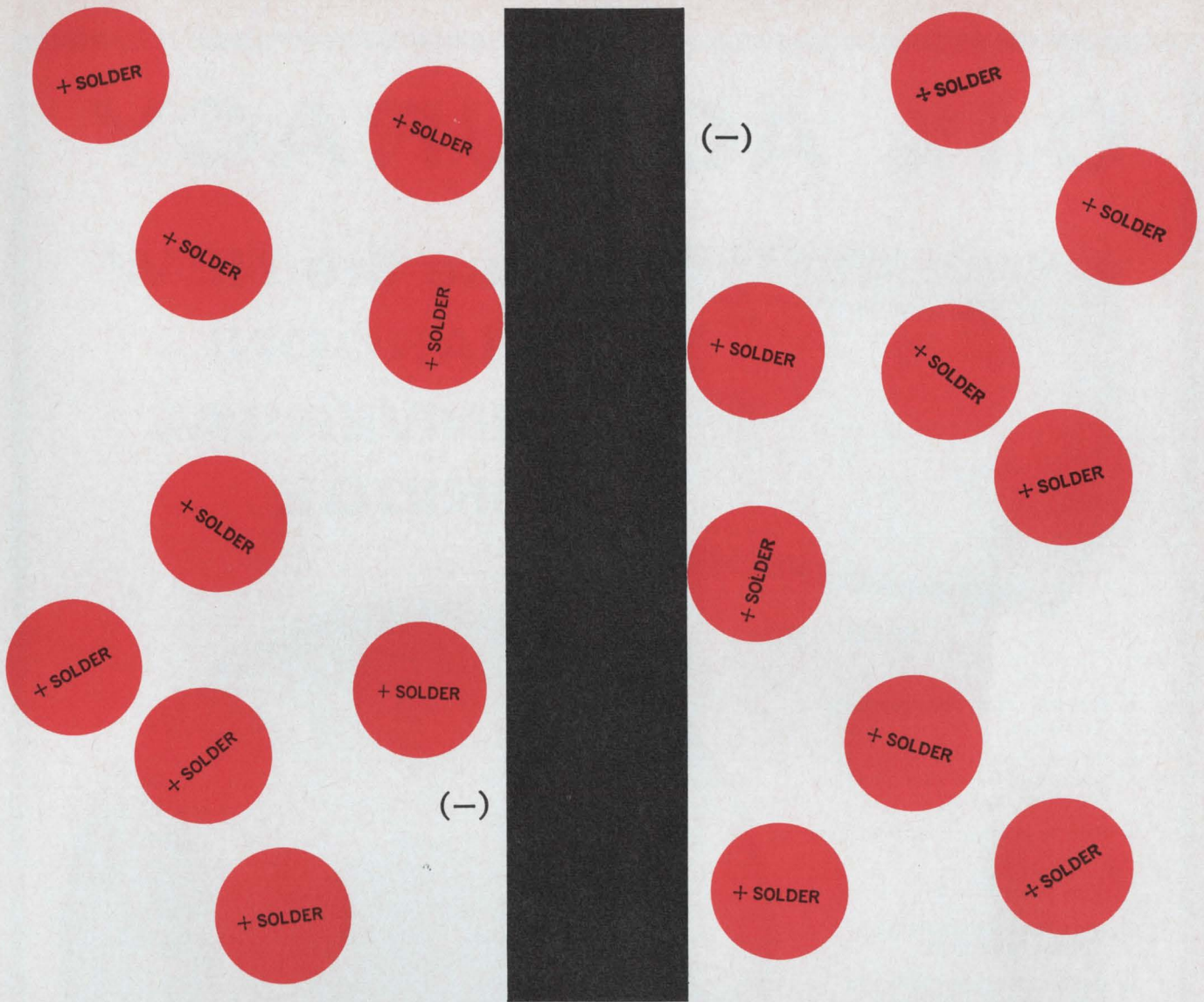

We could solder-plate 100,000,000,000,000 miles of wire
and not vary .0002"

(Hot-dipped wire could never be that precise.)

Up till now all known solder-coated wire was hot-dipped.

That meant lack of uniformity. And plenty of waste. But we've developed a way to solder-plate wire that will hold coating thickness to minimums. We can solder-plate (in a variety of baths) or tin-plate any diameter wire from .010" through .060". We can solder-plate or tin-plate ribbon from .005" x .020" through .050" x .080".

And we can hold a plating thickness range of .0002" on plate thickness up to .0005" minimum (for example: .00025"-.00045" or .0005"-.0007").

There are no more thin areas that become unsolder-

able due to "non-wetting." Coatings on pigtailed wire can now retain their solderability even after extended baking or curing times. And solderability is retained even after an extended "shelf-life" when hot-dipped wire normally goes bad.

What else? Well, we think that many faults you've ever found with hot-dipped wire, our solder-plated wire will correct.

Give us a call, and we'll send you some.

Sylvania Electric Products Inc., Parts Division, Warren, Pennsylvania 16365. Phone 814-723-2000.

SYLVANIA
SUBSIDIARY OF
GENERAL TELEPHONE & ELECTRONICS **GTE**

0.1% ACCURACY

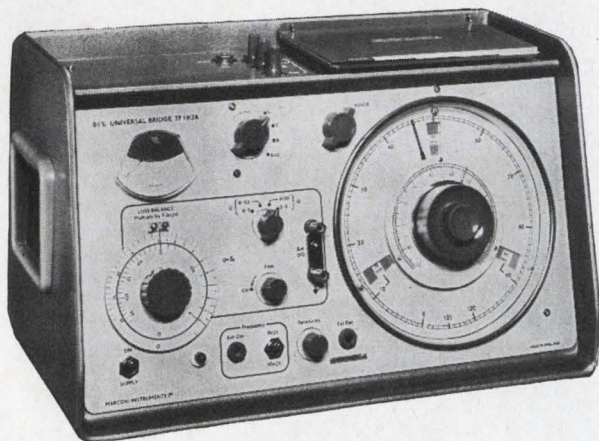

use the **NEW**
MARCONI
UNIVERSAL
BRIDGE

MODEL #1313A

- **Extremely High Accuracy:** 0.1% of Reading
- **No Factors:** Dial callouts automatically change when function and range is selected.
- **High Resolution:** Discrimination 0.01% of full scale; 10,900 division/range (Dial Reads 46.66 mH)
- **Wide Temperature Range Without Corrections**
- **Built-In Oscillator:** 1kHz and 10kHz, 20Hz — 35kHz with external oscillator
- **Capacitor Bias:** Up to 350VDC can be applied to polarize electrolytics

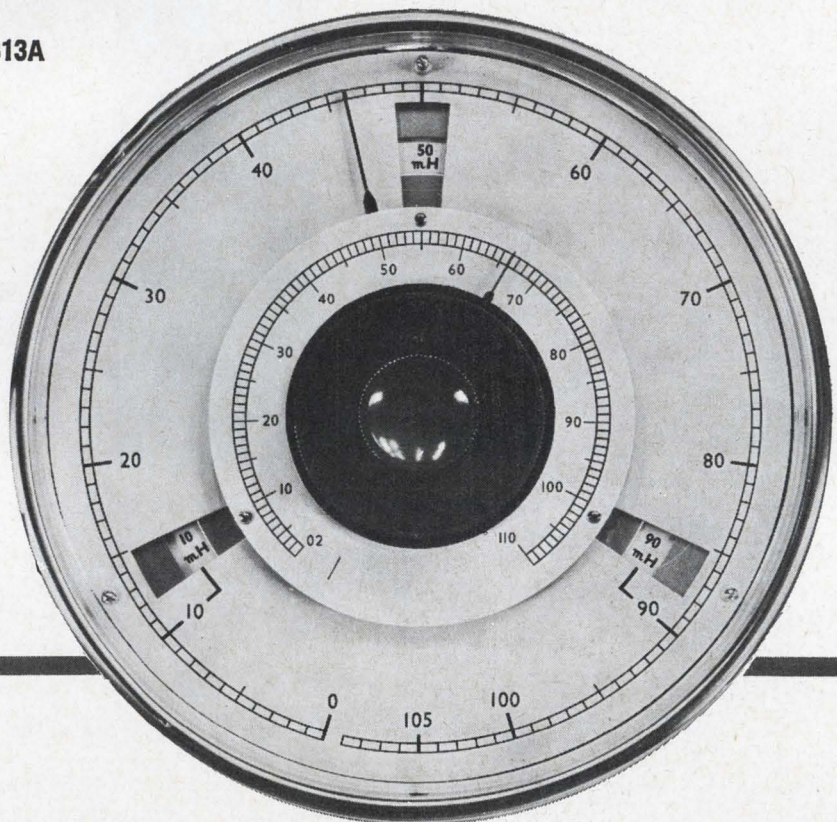

MEASURES

Inductance: ..0.1 μ H to 11H @ 1 and 10kHz
Capacitance: 0.1pF to 110 μ F
Resistance:003 Ω to 110M Ω
Q Range: 0 to 310
D Range:0005 to 30

Accuracy high, interpolation precise, familiarization time minimal . . . the model 1313A, latest in Bridges, is designed for use by engineers and production personnel alike. Ask your Marconi representative to show you.

MARCONI

111 Cedar Lane • Englewood, N. J.

INSTRUMENTS

Telephone: 201-567-0607

Division of English Electric Corporation

Just 40¢ to ship a cubic foot of PELASPAN-PAC® loose-fill packing via 1st class (anywhere within the U.S.). \$3.20 for other kinds of packing materials. Gives you an idea of the savings in truck and rail costs when you use PELASPAN-PAC. A cubic foot of it weighs only 8 oz., 8 times lighter than other packing materials.

PELASPAN-PAC does a better job of cushioning delicate

electronic instruments on trips from here to there. The curled pieces of expanded polystyrene interlock. They actually hold the packed item in suspension. Never wad into a lump or collapse like makeshift packing materials do.

PELASPAN-PAC has other ad-

vantages. It's clean and dust free. So easy to work with, you'll realize major savings in labor time and cost.

Now that you've weighed the facts, isn't PELASPAN-PAC the best?

Your nearby distributor has it. Write us for his name.

The Dow Chemical Company, Plastics Sales, Department 71230, Midland, Michigan 48640.



Packing for shipment? Weigh the cost.

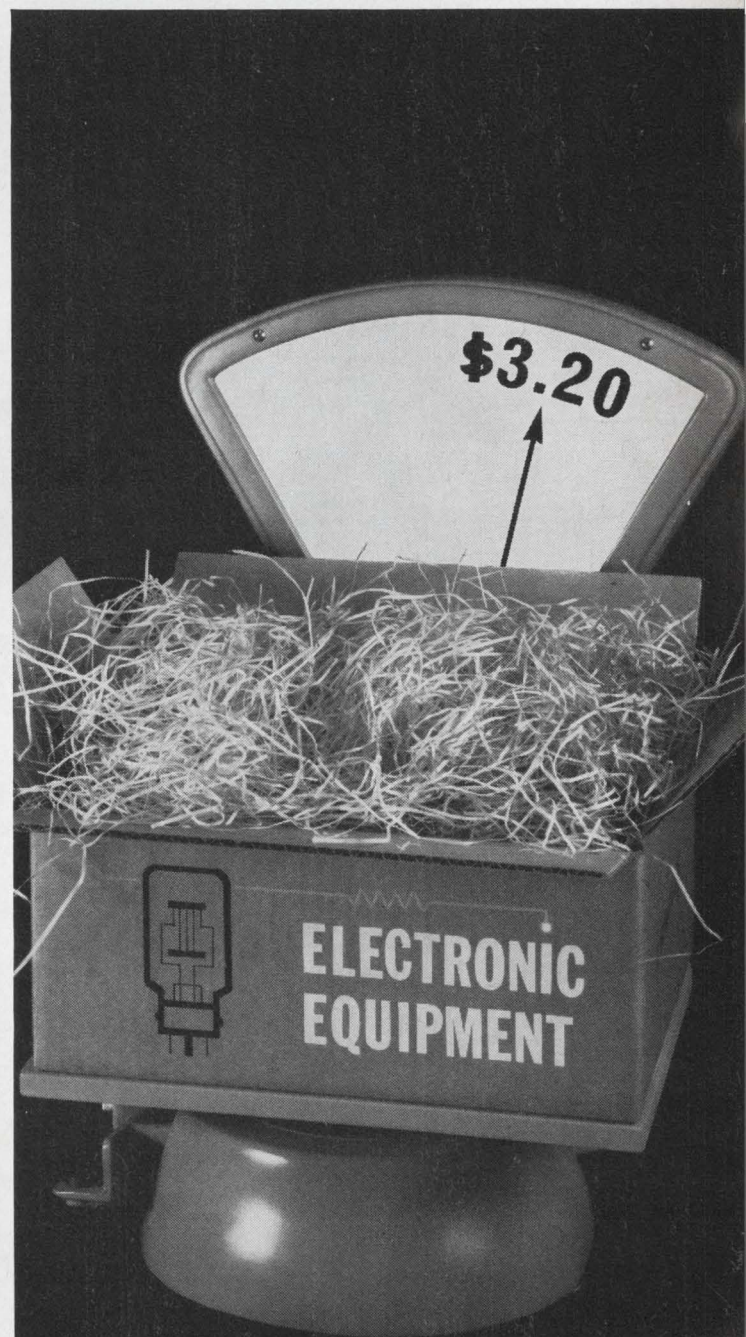
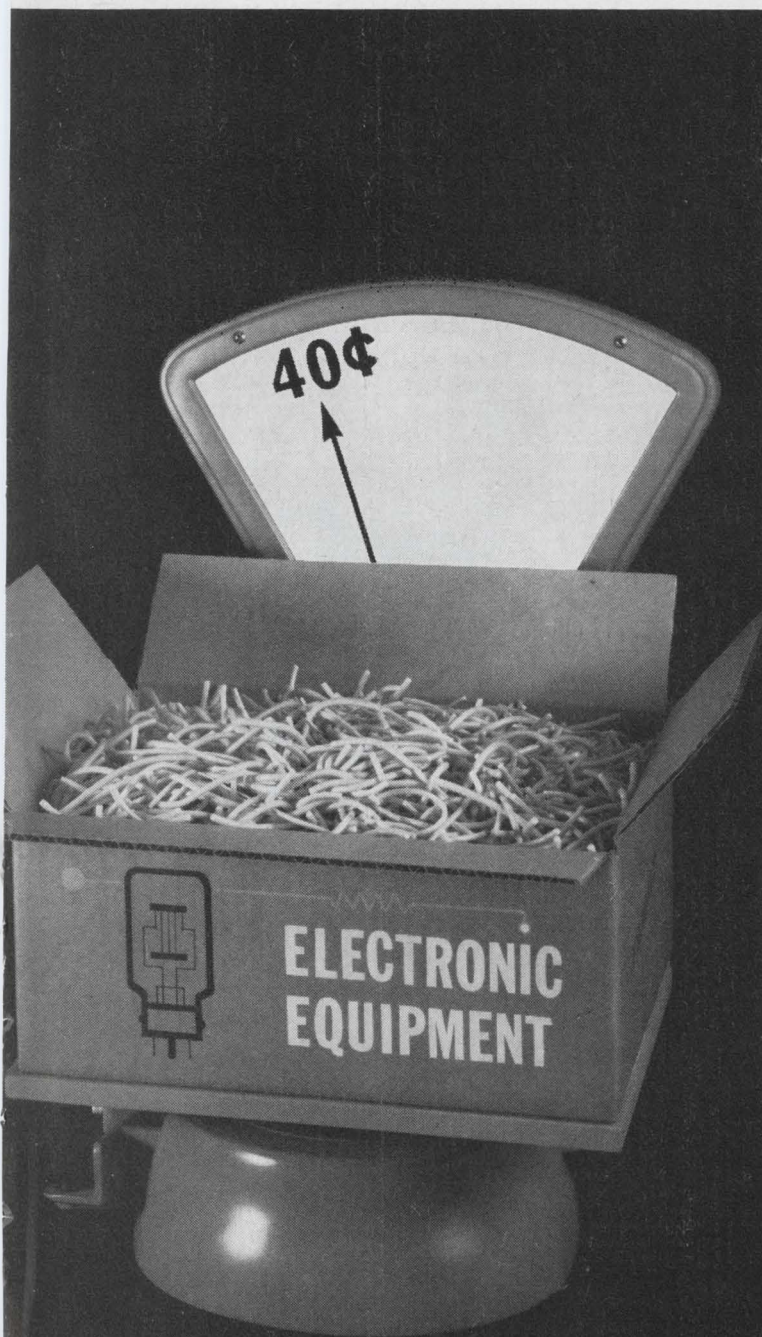

try this for size...

there's no doubt about performance!

Sized right for high density pcb switching—as small as .145 cu. in.—the MicroClareed MR Relay adds a new dimension to Clare Sealed Contact Reed Relay capabilities. Design around 1 to 5 contacts in epoxy sealed and open coil modules—take advantage of all of the inherent reliability and performance achievements of CLAREED Relays in only 1/5th the size.

Super-clean in construction, the 100% operation-tested, glass-encapsulated contacts never need maintenance or adjustment. Fast... with switching speeds in the low millisecond range. On the job, insensitivity to electrical transients... and complete input/output isolation... provide high reliability with maximum circuit simplicity.

For complete design information, circle reader service number—or ask Clare for Data Sheet 961... Write Group 12N9.

C.P. Clare & Co., Chicago, Illinois 60645



a GENERAL INSTRUMENT company



Length: 1¹⁵/₆₄" max.

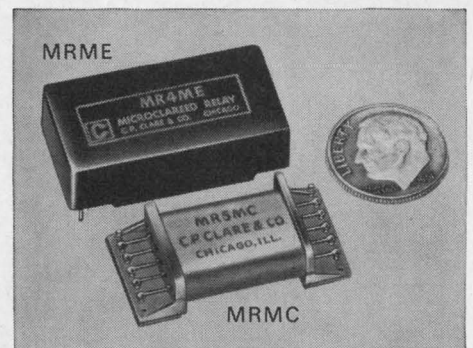

- Inherent reliability with no maintenance (Contacts sealed in glass)
- Switching times 0.5 to 2 ms
- Insensitive to transient electrical/electronic noises
- Contact load versatility—low level to 10 va
- Life:
 - .125 amp., 28 v: 10 x 10⁶ operations
 - low level: 100 x 10⁶ operations
- 1 to 5 contacts per module—open coil or molded epoxy modules

MICROCLAREED SEALED-CONTACT REED RELAYS

for industrial control, data logging and instrumentation,
communication switching, ground control, checkout systems

Now—the broadest line of convection-cooled, all silicon, .015% regulated power supplies

For test equipment and lab use 0-10,-20,-40,-60,-120 VDC, from 0-.5 amp to 0-66 amps

Features and Data

- Rack or bench use
- Full five year guarantee on materials and labor
- Convection Cooled
- Remote Programming
- Regulation—.015% or 1 MV (Line or Load)
- Temp. Coef. .015%/°C
- Completely Protected—Short circuit proof—Continuously adjustable Automatic current limiting
- Remote Sensing
- Constant I./Constant V. by automatic crossover
- Series/Parallel Operation
- No Voltage Spikes or Overshoot on "turn on", "turn off" or power failure
- Ripple—LK models—500 μ V RMS
LH models—250 μ V RMS, 1 MV P-P
- Meet MIL Environment Specs

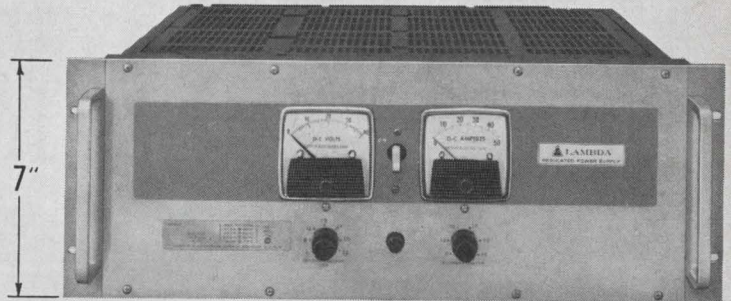

Full Rack 7" LK Series



1/4 Rack LH Series

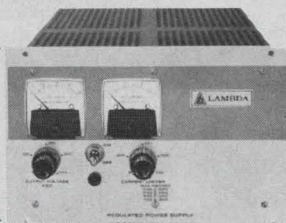

1/2 Rack LK Series-LH Series

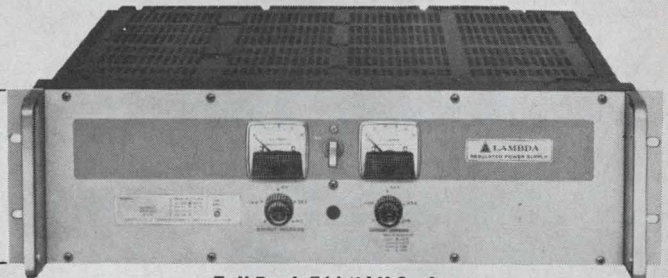

Full Rack 5 1/4" LK Series

3 Full-rack Models — Size 7" x 19" x 18 1/2"

Model ²	Voltage Range	CURRENT RANGE AT AMBIENT OF: ¹				Price ²
		40°C	50°C	60°C	71°C	
LK 360 FM	0-20VDC	0-66A	0-59A	0-50A	0-40A	\$995
LK 361 FM	0-36VDC	0-48A	0-43A	0-36A	0-30A	950
LK 362 FM	0-60VDC	0-25A	0-24A	0-22A	0-19A	995

3 Full-rack Models — Size 5 1/4" x 19" x 16 1/2"

Model ²	Voltage Range	CURRENT RANGE AT AMBIENT OF: ¹				Price ²
		40°C	50°C	60°C	71°C	
LK 350	0-20VDC	0-35A	0-31A	0-26A	0-20A	\$675
LK 351	0-36VDC	0-25A	0-23A	0-20A	0-15A	640
LK 352	0-60VDC	0-15A	0-14A	0-12.5A	0-10A	650

5 Quarter-rack Models — Size 5 3/16" x 4 3/16" x 15 1/2"

Model ²	Voltage Range	CURRENT RANGE AT AMBIENT OF: ¹				Price ²
		30°C	50°C	60°C	71°C	
LH 118	0-10VDC	0-4.0A	0-3.5A	0-2.9A	0-2.3A	\$175
LH 121	0-20VDC	0-2.4A	0-2.2A	0-1.8A	0-1.5A	159
LH 124	0-40VDC	0-1.3A	0-1.1A	0-0.9A	0-0.7A	154
LH 127	0-60VDC	0-0.9A	0-0.7A	0-0.6A	0-0.5A	184
LH 130	0-120VDC	0-0.50A	0-0.40A	0-0.35A	0-0.25A	225

11 Half-rack Models — Size 5 3/16" x 8 3/8" x 15 1/2"

Model ²	Voltage Range	CURRENT RANGE AT AMBIENT OF: ¹				Price ²
		40°C	50°C	60°C	71°C	
LK 340	0-20VDC	0- 8.0A	0- 7.0A	0- 6.1A	0-4.9A	\$330
LK 341	0-20VDC	0-13.5A	0-11.0A	0-10.0A	0-7.7A	385
LK 342	0-36VDC	0- 5.2A	0- 5.0A	0- 4.5A	0-3.7A	335
LK 343	0-36VDC	0- 9.0A	0- 8.5A	0- 7.6A	0-6.1A	395
LK 344	0-60VDC	0- 4.0A	0- 3.5A	0- 3.0A	0-2.5A	340
LK 345	0-60VDC	0- 6.0A	0- 5.2A	0- 4.5A	0-4.0A	395

Model ²	Voltage Range	CURRENT RANGE AT AMBIENT OF: ¹				Price ²
		30°C	50°C	60°C	71°C	
LH 119	0-10VDC	0- 9.0A	0- 8.0A	0- 6.9A	0-5.8A	\$289
LH 122	0-20VDC	0- 5.7A	0- 4.7A	0- 4.0A	0-3.3A	260
LH 125	0-40VDC	0- 3.0A	0- 2.7A	0- 2.3A	0-1.9A	269
LH 128	0-60VDC	0- 2.4A	0- 2.1A	0- 1.8A	0-1.5A	315
LH 131	0-120VDC	0- 1.2A	0- 0.9A	0- 0.8A	0-0.6A	320

¹ Current rating applies over entire voltage range.

² Prices are for non-metered models (except for models LK360FM thru LK362FM which are not available without meters). For metered models, add suffix (FM) and add \$25 to price of LH models; add \$30 to price of LK models.

³ Overvoltage Protection: add suffix (OV) to model number and add \$60 to the price of LH models; add \$70 to price of half-rack LK models; add \$90 to price of 5 1/4" full-rack LK models; add \$120 to price of 7" full-rack LK models.

⁴ Chassis Slides for full rack models: Add suffix (CS) to model number and add \$60 to the price.



LAMBDA ELECTRONICS CORP.

TERMINAL DRIVE • PLAINVIEW, L.I., NEW YORK 11803 • 516-681-8300

A  SUBSIDIARY

LA-182A

Circle 83 on reader service card

This is AE's Class B relay.

Use it where a less expensive relay would cost too much.

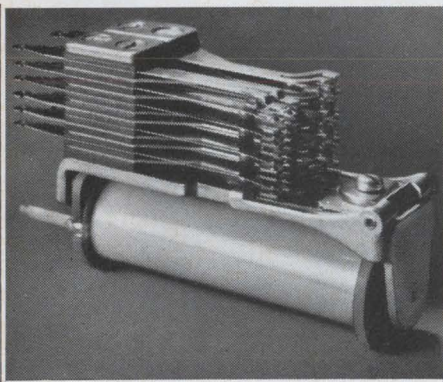

The Class B is a premium-quality telephone-type relay. It can give you at least 400 million operations with unfailing contact reliability. And it seldom needs maintenance.

That's why it's probably the most inexpensive relay you can use—where long-term reliability is a must.

In commercial and industrial control applications, the AE Class B delivers just what you'd expect of a telephone relay. It combines good sensitivity with excellent stability. Withstands extreme temperatures. Provides a wide range of practical operate and release timing...a range much wider than possible with smaller types of relays.

The Class B has two armature ratios (long, for fast acting

or pulsing—short, for slow-release and chatter-free AC operation). It also features twin contacts to insure against contact failure, a permanent wear-free backstop, pin-type armature bearings—plus a sturdy, stable heel-piece.

Newest Class B relay is the Series BRM latching version. When pulsed, remanent magnetism keeps the BRM latched without power consumption until it is restored by a second pulse.

Find out more about the Class B relay—the industry standard for long-term economy. Ask for Circular 1993. Just write to the Director, Relay Control Equipment Sales, Automatic Electric Company, Northlake, Illinois 60164.

AUTOMATIC ELECTRIC

SUBSIDIARY OF
GENERAL TELEPHONE & ELECTRONICS **GTE**

new

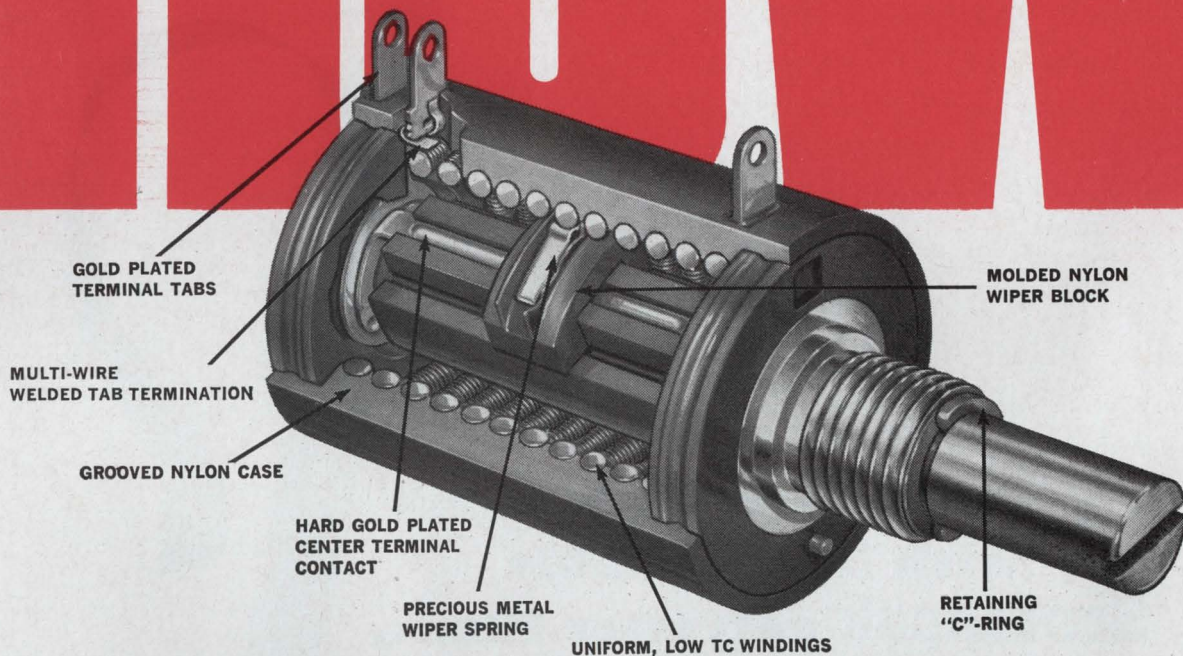

LOW-COST 10-TURN POTENTIOMETER

7/8" diameter, 0.25% linearity, plus long life

Here's a rugged high-performance potentiometer that means space and cost savings for your industrial and commercial applications. With only 1 1/8" projection behind the panel, this 7/8" diameter unit has stability and reliability features normally found only in MIL-type units.

- Rugged nylon housing and end plate—withstands rough handling and mechanical abuse.
- Grooved case—maintains uniformity of wire windings and provides for $\pm 0.25\%$ independent linearity.
- Welded tab termination—means low end resistance and easier external connections.
- Longer winding—20"-long, low TC wire provides better stability and resolution over the entire resistance range.
- Precious metal wiper spring—assures better contact and long rotational life.
- Retaining "C"-ring—prevents possible snap-out of rear plate.

Immediately available, this new IRC precision potentiometer has popular side terminals and a 1/4" diameter shaft that permits knob or screwdriver adjustment. Write for data and prices. IRC, Inc., 401 N. Broad St., Philadelphia, Pa. 19108.

CAPSULE SPECIFICATIONS IRC TYPE 8400

SIZE	7/8" diameter
TURNS	10
POWER	2 watts @ 25° C
INDEPENDENT LINEARITY	$\pm 0.25\%$
TOLERANCE	$\pm 5\%$
RESISTANCE	100 to 100K Ω
END RESISTANCE	0.1% or 2 Ω (whichever is greater)



New lower-cost way to make flat wiring systems

Make them modern
with heat-sealable
Scotchpak[®] polyester film...
BRAND
tough, flat and flexible

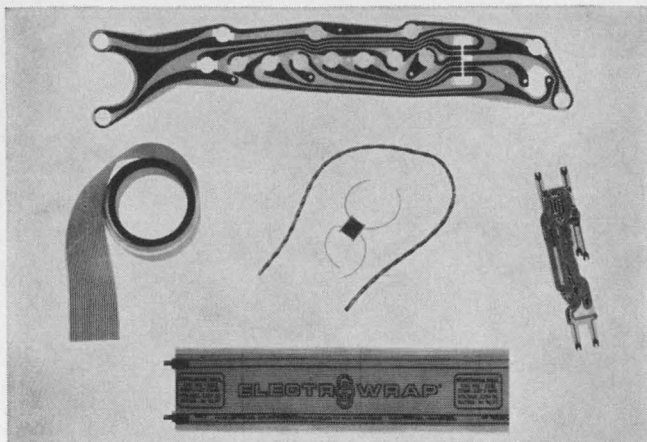
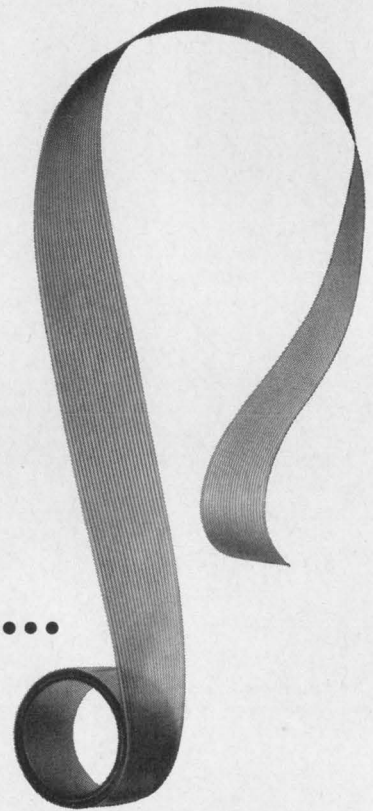

Typical Applications: Pipe and tank-heating cable by Electro-Trace Corp.; printed circuit panels made by firms such as Flexible Circuit Corp.; flat cables by Tape Cable Corp.; and a variety of other uses including coil covers and wire wrap.

"SCOTCHPAK" film laminates easily — like a thermoplastic. And since it is a polyester, it is exceptionally strong... chemically resistant... with high dielectric properties. It's available in various types and thicknesses — probably one just right for your needs. Enables you to make cables that easily follow unusual contours... that lie flat... take up minimum space. Printed circuits that flex... but don't snap. A market potential estimated at over \$100 million by 1970!

Interested? For more information, write: Film & Allied Products Div., 3M Co., 2501 Hudson Rd., St. Paul, Minn. 55119, Dept. ICL-127.

3M
COMPANY

"SCOTCHPAK" IS A REG. T.M. OF 3M CO.



A word to the do-it-yourself module builder:

Don't.

Buy our J Series modules instead.

The J Series is our new family of general purpose, all integrated circuit logic modules. Their performance almost matches that of our famous T Series modules, but they cost about 25% less. They're made to the same dimensions as the T Series, with the same 52 pin connectors, so they're physically interchangeable. We make them for our own seismic recorder systems, so they're rugged and reliable. Now, as of January, you can buy them (com-

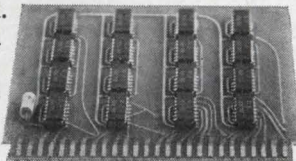

These will cost you less.

plete with mounting hardware, racks and power supplies, if you wish) in any of 25 different functions.

And save yourself the time and cost of making your own: designing, assembling, testing, new procedures, new equipment, new personnel, additional training, to say nothing of the added paper work.

If you're building systems, you must have better things to do than go into the module assembly business. Such as reading our J Series catalog.

It's free.

SDS

Scientific Data Systems,
Santa Monica, California

Circle 265 on reader service card

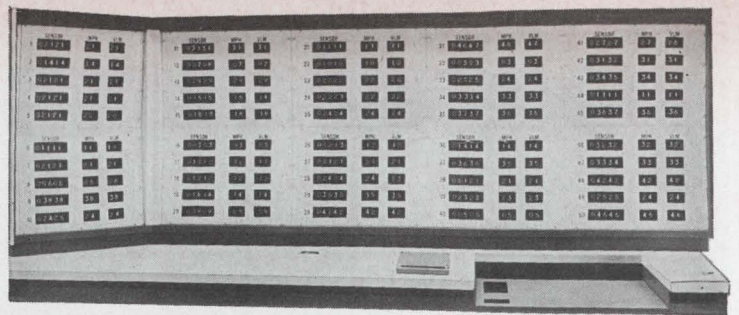

experience counts
... and spells
to produce
information
display
systems

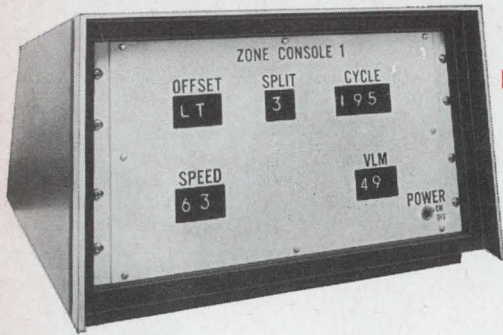

B Burroughs Corporation

Burroughs has produced many complete information display systems for a wide variety of industrial, commercial and military applications.

For application assistance or information write:
Burroughs Corporation, Electronic Components Division
P.O. Box 1226, Department A1
Plainfield, New Jersey 07061
Tel: (201) 757-5000

BURROUGHS CORPORATION
ALPHANUMERIC AND NUMERIC REAL TIME DISPLAY
SYSTEMS FOR COMPUTER READOUT - SCHEDULE BOARDS -
TRAFFIC CONTROL MONITORING - STOCK MARKET
DISPLAY BOARDS - NEWS AND INFORMATION DISPLAYS

Technical Articles

**Programmable logic arrays:
cheaper by the millions**
page 90

So far, all approaches to large scale integration have been based on a fixed metallic interconnection pattern that determines the array's function. But a new scheme is proposed that could add flexibility and cut costs, particularly for situations where only a small number of systems are to be built. With the new method, the function of an array would be determined by signals transmitted to it.

**Transistors share the load
in a kilowatt amplifier**
Page 100

A basic four-transistor module, whose power is combined through broadband transformers, is the heart of an amplifier that delivers peak envelope power outputs of 1,000 watts from 2 to 32 megahertz. Previously, the best high-frequency amplifiers, operating over narrower bands, had outputs of about 200 watts.

**Special report:
Solid state
in Japan**
page 107

Electronics



Over the past few years, production of semiconductors, cornerstone of the Japanese electronics industry, has doubled. Success is based partly on the exploitation of U.S. technology and, more recently, on Japan's accent on home-based research. With the latter, Japanese engineers expect to leapfrog U.S. developments. On the cover, symbolizing Japan's commitment to

semiconductor R&D is Jun-ichi Nishizawa, a leader in Japanese solid state research. Nishizawa is the author of the report on Japan's progress in optoelectronics (p. 117).

**Tailoring the device
to suit the need**
page 110

Japanese designers are concentrating their efforts on devices that are peculiarly suited to meet domestic electronic needs. Advances have been made in r-f transistors, varactors, and thermistors.

**Optoelectronics
goes digital**
page 117

Japan has two specific goals in mind for which it has increased its emphasis on optoelectronics. One is the development of high speed logic using injection lasers; the other is the design of computer input and output equipment using phototransistors and electroluminescent displays.

**Gunn devices are on
target, but short of a
bull's eye**
page 125

The outputs of Gunn-effect oscillators now satisfy just a part of the microwave repeater needs of Japan's communications systems. Yet progress has raised hopes that a practical device may be available in the near future.

**Coming
December 25**

- European electronics market report
- Integrated circuits in a military radar

Programmable logic arrays — cheaper by the millions

Standardized large-scale integrated circuits with fixed interconnections and variable functions can be fabricated in huge quantities at low cost, thus making short production runs of large systems more economical

by Sven E. Wahlstrom

Stanford Research Institute, Menlo Park, Calif.

Flexibility and cost savings would be the payoff if many logic circuits within a single silicon chip could be interconnected in such a way that the function of the array were determined by signals transmitted to it instead of by a fixed, metallic interconnection pattern. After years of studying ways to organize digital integrated circuits in standardized arrays so they can be used as computer building blocks, the Stanford Research Institute has devised such a scheme.

In contrast to conventional arrangements, arrays designed in this way could be reprogrammed to handle several hundred functions. Ideally, the programmable circuits would be identical. With fewer kinds of chips to deal with, development costs are less, and larger quantities of each kind of chip would cost less to produce.

The proposed technique is particularly attractive for situations in which only a small number of systems are to be built. Generally, the programmable logic would require several times the amount of circuitry to perform a given function as does a conventional assembly. And a very large number of custom-designed chips costs less to make than would a functionally equivalent number of pro-

grammable arrays. While programmable arrays would have to be reprogrammed after any power shutdown, program signals could be kept on magnetic or paper tape to ease the process. Or an auxiliary power source could eliminate the problem altogether.

Given the present state of large scale integration, two or three different circuits would likely be required. Several chips would have to be interconnected to provide an array of reasonable size, and, to simplify the programming, more than two terminals would probably be used as entry points.

Programmable arrays represent a step in large-scale integration beyond such concepts as the cellular logic developed extensively at Stanford University and produced in modified form under the labels, Micromatrix and Polycell. In cellular logic, large numbers of arrays are produced exactly alike except for the last step, in which a metal interconnection pattern tailors the cells to a specific function. Only in this final step are the customer's special requirements met.

In conventional logic design, the engineer specifies the wiring between fixed-function modules. With programmable arrays, the engineer sets up the function after the design stage by feeding a sequence of bits into programming buses, from a keyboard or from tape.

Peas in a pod

The programmable array consists of an orderly structure of 64 to 100 cells and fixed wiring that connects neighboring cells and carries data programs over the entire assembly.

In an array, whose lower left-hand corner is shown above, all the cells are identical. Conceptually

The author



Sven E. Wahlstrom is a senior research engineer in the computer techniques laboratory at Stanford Research Institute. He has a master's degree from the Chalmers Institute of Technology in Gothenburg, Sweden, and has worked with Facit Electronics and with the Ampex Corp.

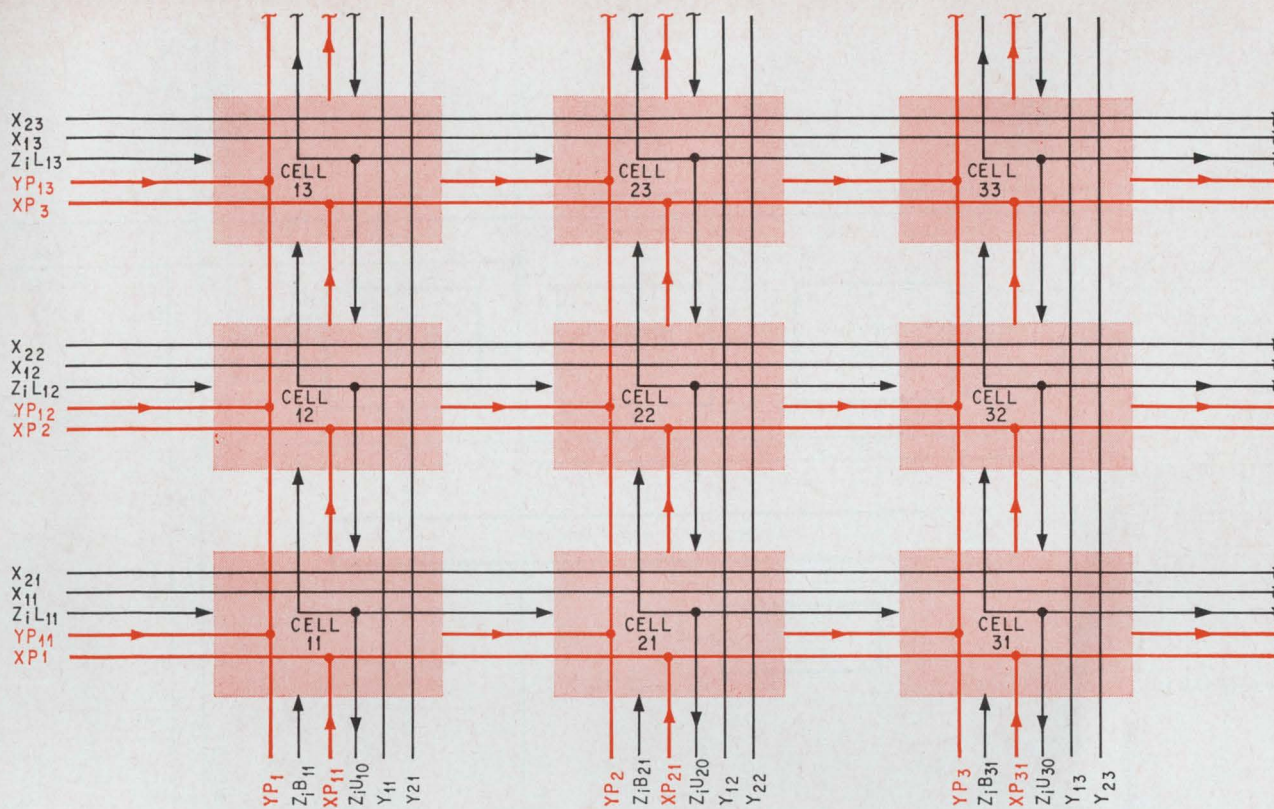

Repeated interconnections. The programmable array contains many identical cells (color blocks) with identical interconnections. Function of each cell is established by pulses sent along the program buses (colored lines). Because each cell is connectable to adjacent program buses as well as adjacent cells, any cell in the array is addressable through cell 11 at the lower left-hand corner.

the pattern stretches indefinitely to the right and up, with a repeating pattern of interconnections. The table below defines the line labels.

Each cell contains four major sections, as shown on page 92. The function control register (FCR) defines the logic function in accordance with the par-

ticular combination of bits in it. A shift register, the FCR loads bits at one end during programing and shifts them along its length until they reach their proper positions. Flip-flops control the cell's basic logic definition and its input and output gates.

Theoretically, an n -bit FCR could define 2^n different functions because it can contain up to 2^n different combinations of bits. Actually, however, many of these combinations are not usable.

Symbols for programmable arrays

Symbol	Interpretation
X_{P1}, X_{P2}, X_{P3}	Horizontal program buses
Y_{P1}, Y_{P2}, Y_{P3}	Vertical program buses
$X_{P11}, X_{P21}, X_{P31}$	Connections to first horizontal program bus from bottom edge of array
$Y_{P11}, Y_{P12}, Y_{P13}$	Connections to first vertical program bus from left edge of array
$Z_1L_{11}, Z_1L_{12}, Z_1L_{13}$	External input connections to cells on left edge of array, as if from cells at their left
$Z_1B_{11}, Z_1B_{21}, Z_1B_{31}$	External input connections to cells on bottom edge of array, as if from cells below them
$Z_1U_{10}, Z_1U_{20}, Z_1U_{30}$	External input connections from cells on bottom edge of array, as if to cells below them
$X_{11}, X_{21}, X_{12}, X_{22}, X_{13}, X_{23}$	Horizontal data buses
$Y_{11}, Y_{21}, Y_{12}, Y_{22}, Y_{13}, Y_{23}$	Vertical data buses

Network programming

One of the simplest ways to program the array would be a technique based on coincidence selection. Pulses on one horizontal and one vertical programing bus, whose trailing edges coincide in time, select the FCR in the cell at the intersection of the two buses, and shift all previously loaded bits one position along the register. Simultaneously they load a new bit into the first position of the FCR. If the leading edge of the pulse on the X bus is ahead of the leading edge of the Y pulse, a 1 bit is loaded; but if the Y pulse rises first, a 0 bit is loaded.

A single pair of wires serves to link the array to the outside world. The output of each cell is connected to the programing buses immediately above it and to its right; the input lines are connected to the lower left chip in the array and drive that chip to route programing signals to the adjacent buses and thence to the adjacent cells.

A route is thus established, one cell at a time,

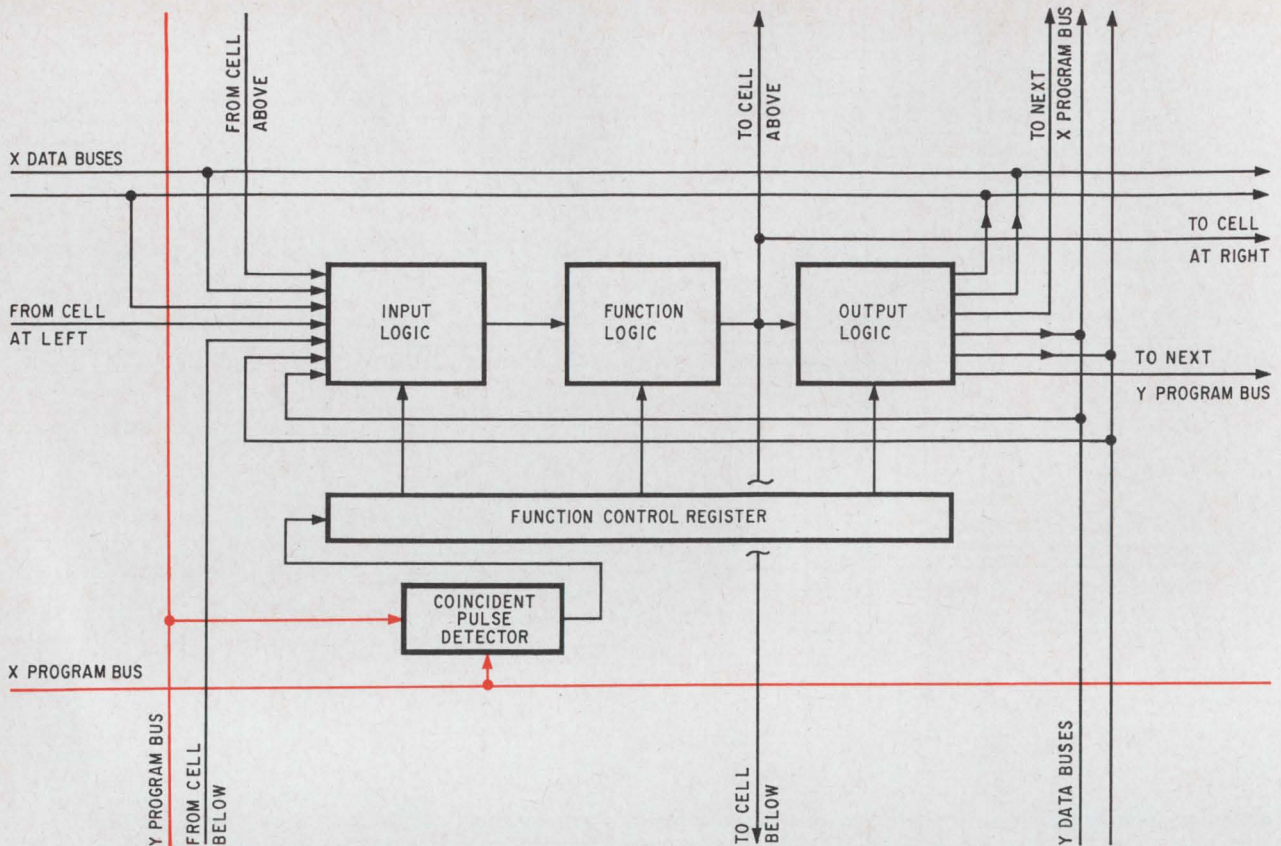

Four major sections. The function control register controls input, output, and function gates to establish the logic function of the cell. The register itself is a shift register loaded by coincident signals on the program buses.

to the farthest cell in the upper right-hand corner. After the program establishes the desired function in that cell, it cranks in the functions of the intervening cells back down the line. Thus the program closes off the route, one cell at a time, as it retreats back to the lower left-hand corner. In large arrays, clear paths can be left for further reprogramming.

Tactical withdrawal

Array programming can be likened to a campaign waged by an army invading a country criss-crossed by rivers and canals. The land areas between rivers correspond to programmable cells.

After establishing a single beachhead, corresponding to the program input terminals, the invaders move materials through it to build a bridge across the first river that they reach. Then, through the beachhead and across that bridge they move material to build a second bridge further on. Thus, assuming no serious resistance, the invaders progress through the country, bridge by bridge, until they reach the far frontier. Now they build an outpost at the far end of the last bridge, bringing in the materials through the original beachhead and across all the bridges. Having established the fort, they retreat, tearing down bridges one by one after they recross them, and using the materials from the bridges to build self-sufficient fortifications on each island. The forts, of course, are analogous to

the logic functions established in the cell.

In this way they withdraw to the original beachhead, where they use the materials of the first bridge to build a final fort. If the country is large and the rivers numerous, the invaders leave a few bridges standing so they can return to the distant frontier to relieve the garrisons left behind.

Swinging gates

Metal-oxide-semiconductor technology could serve to implement a programmable array. For example, 13 MOS NAND gates could be interconnected on a single cell controlled by a 13-position FCR, as at top of page 93. The input logic is formed by seven gates fed by two horizontal data buses, two vertical data buses, and the outputs of the cells immediately above, below, and to the left of them. The seven outputs of these gates are connected to form a seven-way NOR gate; the function can be set up for any number of inputs fewer than seven by adjusting the FCR. In the NOR function, if one or more of the seven inputs carries a binary 1 (a more positive voltage level), the output is a binary 0 (a more negative voltage level); the output can be positive only if all the inputs are negative.

The other six gates form the output logic; they are connected to the same four data buses and to the programming buses immediately above and to the right of them. The NOR function output is also available, ungated, to the cells above, below, and

to the right; it is gated at each destination.

The cell can be set up as a flip-flop if a data bus is connected to both an input and an output gate on the same cell. (The connection is always there, of course, but has no effect unless the corresponding position in the FCR contains a 1). For example, a 1 in position 3, 9 and 13 of the FCR, as shown below, will create a flip-flop on the X_1 data bus. A negative pulse on this bus turns on the flip-flop; a positive pulse on the Y_1 bus turns it off. The logic generating these set and reset pulses must be on adjacent cells.

The diagram shows how the flip-flop is set by a negative pulse on the X_2 data bus that is gated by a negative level on the Z input, both on the cell immediately to the left. Of course, using the data buses in this manner precludes their use elsewhere in the same horizontal row in the array, because they are common to all cells in that row.

In the physical layout of a single cell, shown on page 94, these major functions are available at each of the four edges. On the right edge, the two terminals marked X_1 are electrically common; the corresponding terminals on the left edge aren't connected, but one represents the output of the cell to the X_1 data bus. These two terminals would be connected on the next cell to the left if it was identical; similar interconnections on adjacent cells exist for each of the four data buses. The program buses, passing straight through the cell, are connected to the program logic and to lines from the next cells below and to the left of this one. Corresponding terminals on the top and right edges go to the program buses on those cells.

Bit by bit

After the engineer has completed the logic design and worked out a program to implement it, he simply feeds the program into a standard array a bit at a time; he need not build any new hardware. His problems aren't over, however. Since, in the simplest case, the buses are accessible only at one corner of the array, the programming procedure is rather complicated, as shown on page 95. Cell 11 is

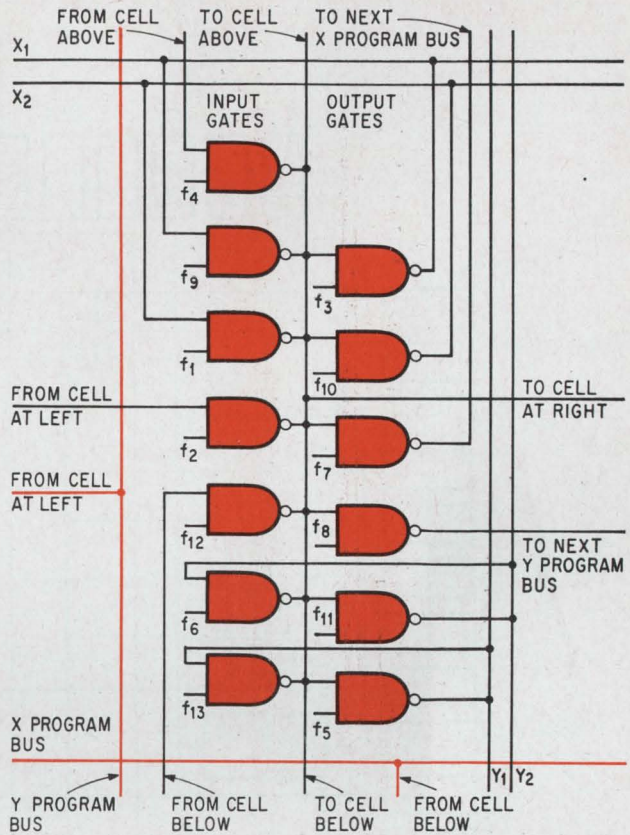

Any function in one cell. The seven input NAND gates with common outputs form a NOR gate with one to seven inputs. This output may be transmitted directly to any one of nine places. Flip-flops and other complex structures can also be programmed.

set up to pass further programming signals to cell 12, which then opens a path to 22. Once the last cell has been programmed, intermediate cells can be reprogrammed to perform functions that drive it.

All of this can be done with the two program inputs, XP_1 and YP_1 , and the single data input, Z_{IB11} . The procedure gets pretty complicated after this, but a few more inputs and wires can expedite programming without adding too much hardware.

Manual programming with a simple keyboard

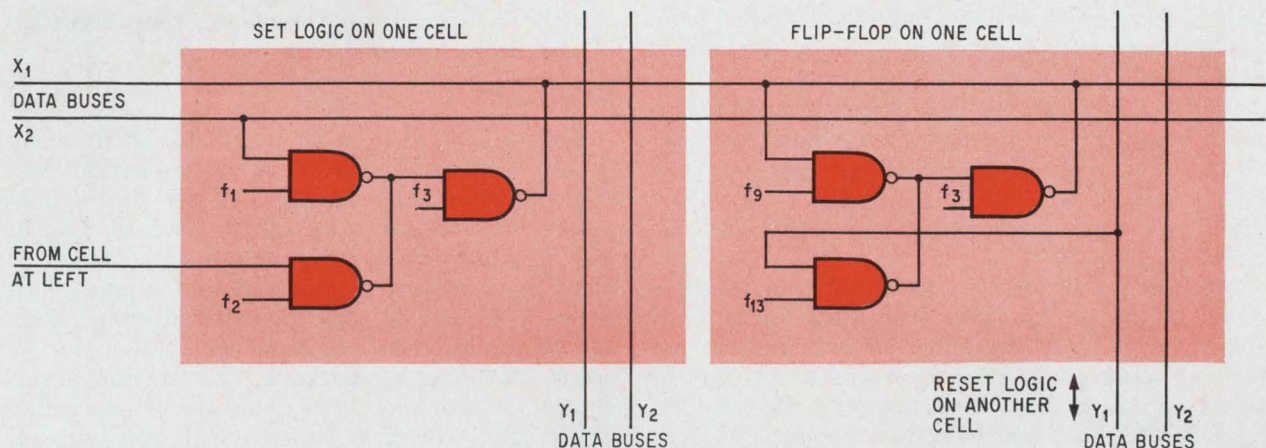

Three-cell flip-flop. The flip-flop proper is on the cell at the right, with its feedback loop on the X_1 data bus. The logic to turn it on is at the left; similar logic for resetting is on a third cell, not shown.

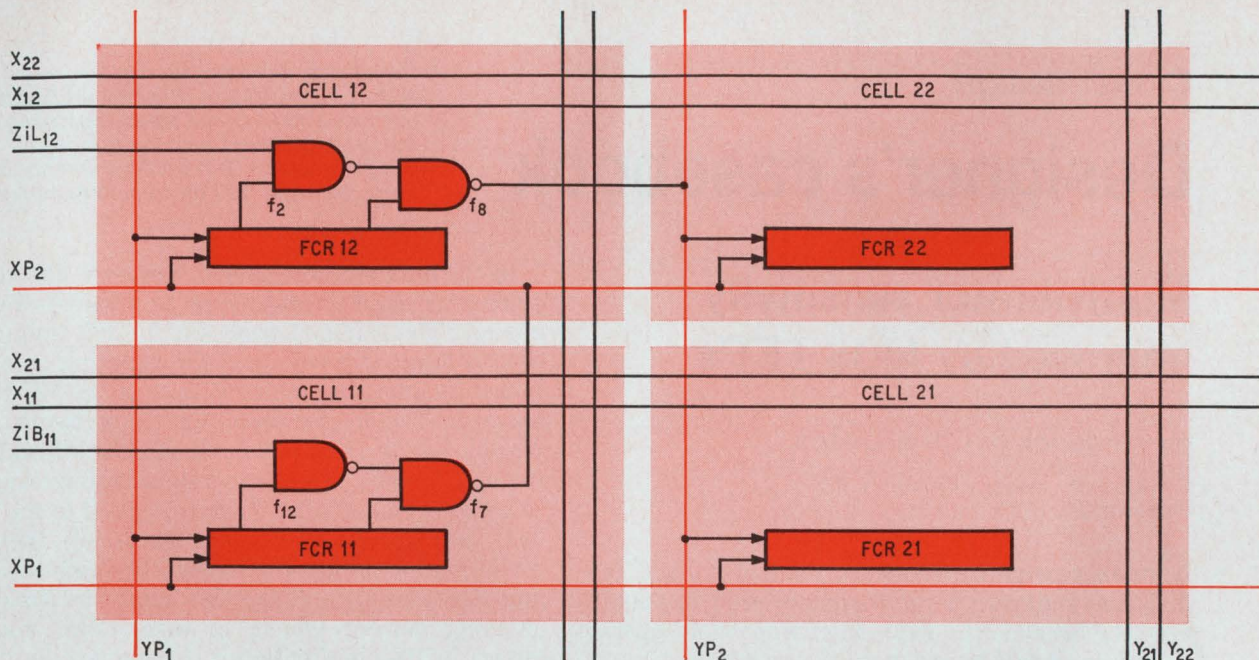

Step by step. Any desired function can be established in cell 22 by first opening a programming path through cells 11 and 12. After cell 22 has been programmed, cell 12 can be reprogrammed with a function to drive cell 22.

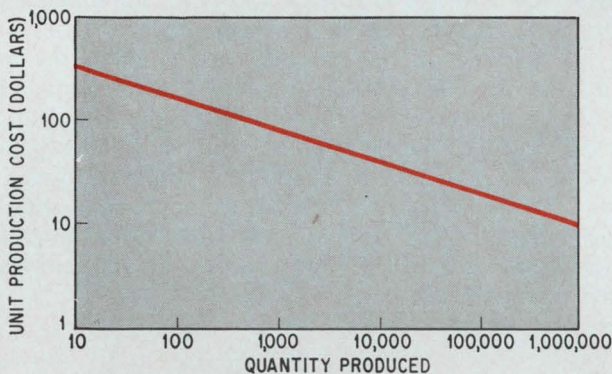

Production cost. Unit cost of producing many thousands of identical IC's is two or three orders of magnitude less than that of producing only a few dozen; herein lies the key to the economics of programmable arrays.

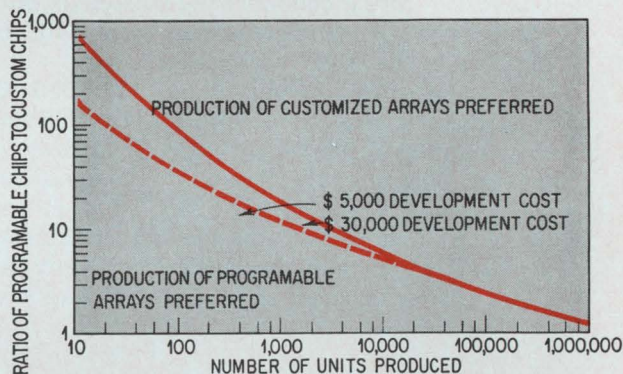

Break-even point. Customized arrays become cheaper than programmable arrays only if the number of units is very large, or if the additional number of programmable arrays required for a given system is very large.

systems built with programmable arrays would require about K times as much hardware, where K is the ratio of programmable chips to the number of customized chips that could perform the same function. At \$7 per chip, the total cost would be $7nK$. The break-even curve, established by the equation

$$nP(n) + 30,000 = 7nK$$

determines the values of n and K below which programmable arrays are more economical than their customized counterparts.

This equation and the production costs in the diagram at left above are the basis for the break-even point graphed at right above. Programmable arrays are most practical where both n and K are small, though they can also pay their way with a small n and large K or large n and small K .

An array of cells built with MOS technology can achieve a K factor of 10 to 25, which in turn leads

to a break-even point between 250 and 1,700 customized circuits. The diagram shows that even if the K value increases to 50 or 100, as it might with stacked arrays, as many as 50 to 150 programmable systems could be built at an economic advantage.

If the other potential benefits of the programmable array are taken into account—spare-part standardization, easy servicing, and system flexibility—the break-even point can well be several thousand.

Bibliography

- Robert C. Minnick, "Cutpoint Cellular Logic," IEEE Transactions on Electronic Computers, Dec. 1964, p. 685.
- Robert C. Minnick, "Survey of Microcellular Research," Scientific Report 1, Air Force Cambridge Research Laboratories, July 1966.
- Cloyd E. Marvin and Robert M. Walker, "Customizing by interconnection" (Micromatrix), Electronics, Feb. 20, 1967, p. 157.
- Lester Hazlett, "Computer accelerates design and production of large arrays" (Polycell), Electronics, Feb. 20, 1967, p. 166.

Designer's casebook

Designer's casebook is a regular feature in Electronics. Readers are invited to submit novel circuit ideas, packaging schemes, or other unusual solutions to design problems. Descriptions should be short. We'll pay \$50 for each item published.

Multivibrator sensitivity improved by MOS FET's

By Frederick G. Christiansen

GPL Division, General Precision, Inc.
Pleasantville, N.Y.

A small change in frequency control voltage produces an extremely large frequency shift in a multivibrator because the field-effect transistors operate as voltage-variable resistors.

The monolithic integrated circuit shown is a single stage of a Darlington differential amplifier wired as a free-running multivibrator. Capacitors C and C' are the commutating capacitors and also serve as the capacitive portion of the RC timing network in the frequency-control circuit.

In many conventional voltage-controlled oscillators, the frequency is determined by charging the commutating capacitors, C and C', to the control voltage through a fixed resistor (the resistive portion of the RC timing network). Thus, in conventional multivibrators, changes in frequency are achieved by varying control-voltage level, which alters current passing through the timing resistor.

In the multivibrator shown, however, the control voltage is applied indirectly to change the frequency. The voltage supply for the RC timing network is fixed at 6 volts and the charging current is varied by adjusting the resistance of the RC timing network. The fixed resistor in the network is replaced by a pair of metal-oxide-semiconductor FET's, Q₁ and Q₂, which function as voltage-variable resistors. The control voltage is applied to the gates of Q₁ and Q₂ (like an ordinary V_{gs} signal). Increases in the control-voltage level lower the drain-to-source impedance of Q₁ and Q₂; this action increases the charging current which, in turn, raises the frequency of the multivibrator. Frequency limits are set by resistors R₁, R₂, R₃ and R₄.

Sensitivity and linearity of the frequency-control circuitry depends on the bias point of the MOS FET's, Q₁ and Q₂. A plot of the FET's impedance versus V_{gs} is quite linear above the knee of the curve. In addition, the slope of the curve above the knee is quite steep, so that extremely large changes in impedance can be made with very small changes in V_{gs}. The circuit's sensitivity is 40 kilohertz per volt—a parameter that is fairly constant over a wide range of temperature due to the thermal stability of the MOS FET's; the MOS FET's have input impedances greater than 10¹⁰ ohms, so they do not load the control voltage.

Multivibrator. The magnitude of the charging current to commutating capacitors C and C' determines the frequency. Two MOS FET's operated as voltage-variable resistors vary the charging current in response to changes in frequency-control voltage.

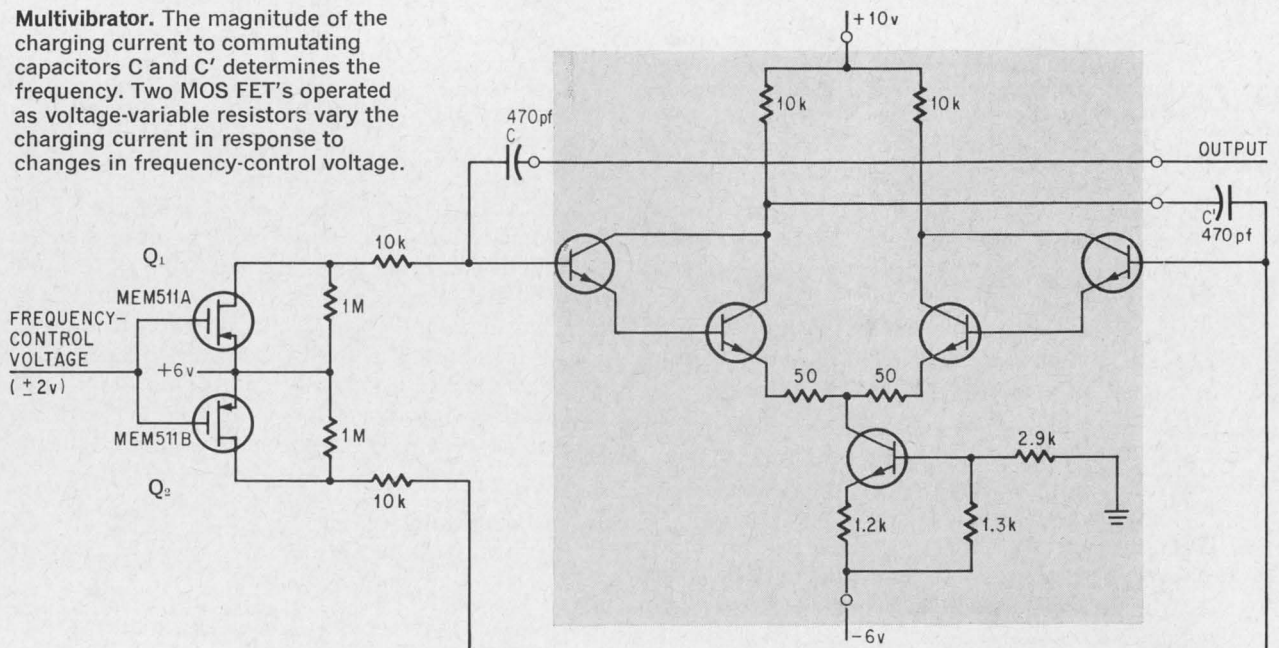

Magnetic resonance limits zener diode current

By Otaker A. Horna

Research Institute for Mathematical Machines
Prague, Czechoslovakia

Zener diodes in a bridge rectifier prevent line voltage variations and load current requirements from affecting the power supply output. The diodes' high current drain during regulation is limited as is any other high current when the secondary saturates the supply transformer.

In saturation, the transformer breaks into magnetic resonance and behaves as an inductance between its primary and secondary. This inductance and a capacitor in the primary constitute a low Q, series-resonant circuit that limits current flow. The current is converted to voltage and stored by the capacitor.

Since the primary capacitor, C_1 , is in a resonant circuit, its d-c voltage rating should be five times higher than the applied voltage V_L . The capacitance value is directly proportional to the stored current and expressed by

$$C_1 = \frac{1.11 I_{max}}{2\pi f \frac{n_1}{n_2} V_L}$$

where I_{max} = short-circuit current or current through zener at high line voltage

f = line frequency

V_L = root mean square of the line voltage

n_1/n_2 = $\frac{\text{number of turns on primary}}{\text{number of turns on secondary}}$

C_1 = primary capacitor

$\pi = 3.14$

Resonance results in a voltage on the secondary of the transformer that is 50% higher than the

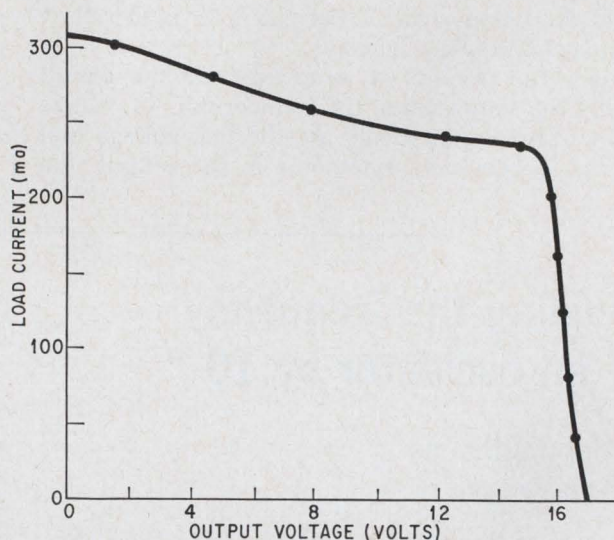

Sharp regulation. During normal operation, current flows through the load until the output voltage reaches 16 volts. Above this, the current is shunted through the zeners.

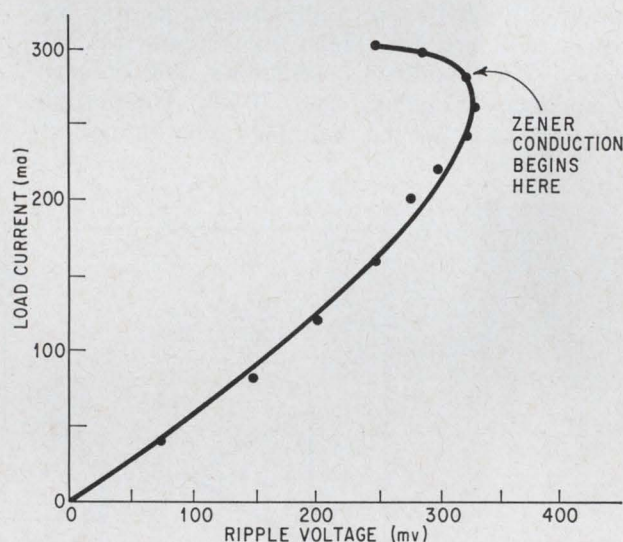

Low ripple. Clipped waveshape that appears at the output of the bridge is a result of zener conduction. Since the clipped voltage is easily filtered a low ripple voltage occurs.

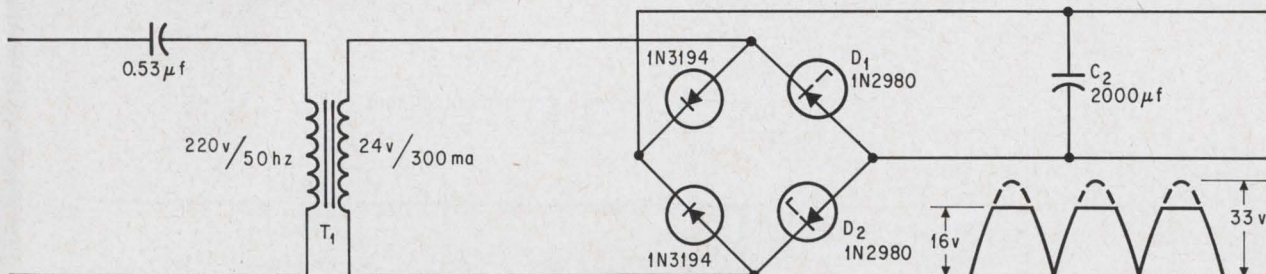

Short-circuit impedance. High line voltages or short circuits cause D_1 and D_2 to draw high currents in the transformer's secondary winding. These currents are limited when transformer T_1 and capacitor C_1 become series resonant and store the current in the magnetic field. Clipping in the output waveform is caused by zener conduction.

Symmetrical gate delivers narrow pulses to fan-out

By Max McGee

Lawrence Radiation Laboratory, Livermore, Calif.

Output pulse width of a symmetrical gate is accurately controlled by the time interval between its two input triggers. The triggers establish the shape of the output pulse and hold the rise and fall times of the output to less than 5 nanoseconds. Two d-c amplifiers in the circuit make it possible to drive loads as large as 30 ohms.

A negative trigger applied to input 1, at time t_0 , drives transistor Q_2 of the Q_1 - Q_2 multivibrator into conduction and simultaneously places Q_1 into cut-off. This causes 6 volts to appear at the collector of

Q_2 , which is transmitted without distortion by the driver stages to the output. Transistor Q_2 remains in conduction as long as it takes for C_1 to discharge through R_1 . A positive trigger is applied to input 2 after the desired time interval, t . Thus, Q_3 begins to conduct, Q_4 is cut off, and -6 volts appear at the collector of Q_3 and is transmitted to the output. The sum of the two-channel outputs at time t_1 is zero and thus the falling edge of the output pulse is sharply formed.

The R_2C_2 time constant is made larger than its R_1C_1 complement. This keeps multivibrator Q_3 - Q_4 in conduction beyond time t_2 and thereby avoids the positive voltage from returning. The negative voltage that appears after Q_1 and Q_2 turns off doesn't affect the fan-out circuit. Interchanging capacitor C_1 with C_2 and switching the two input triggers changes the polarity of the output pulse. This pulse has the same rise and fall times as the positive pulse.

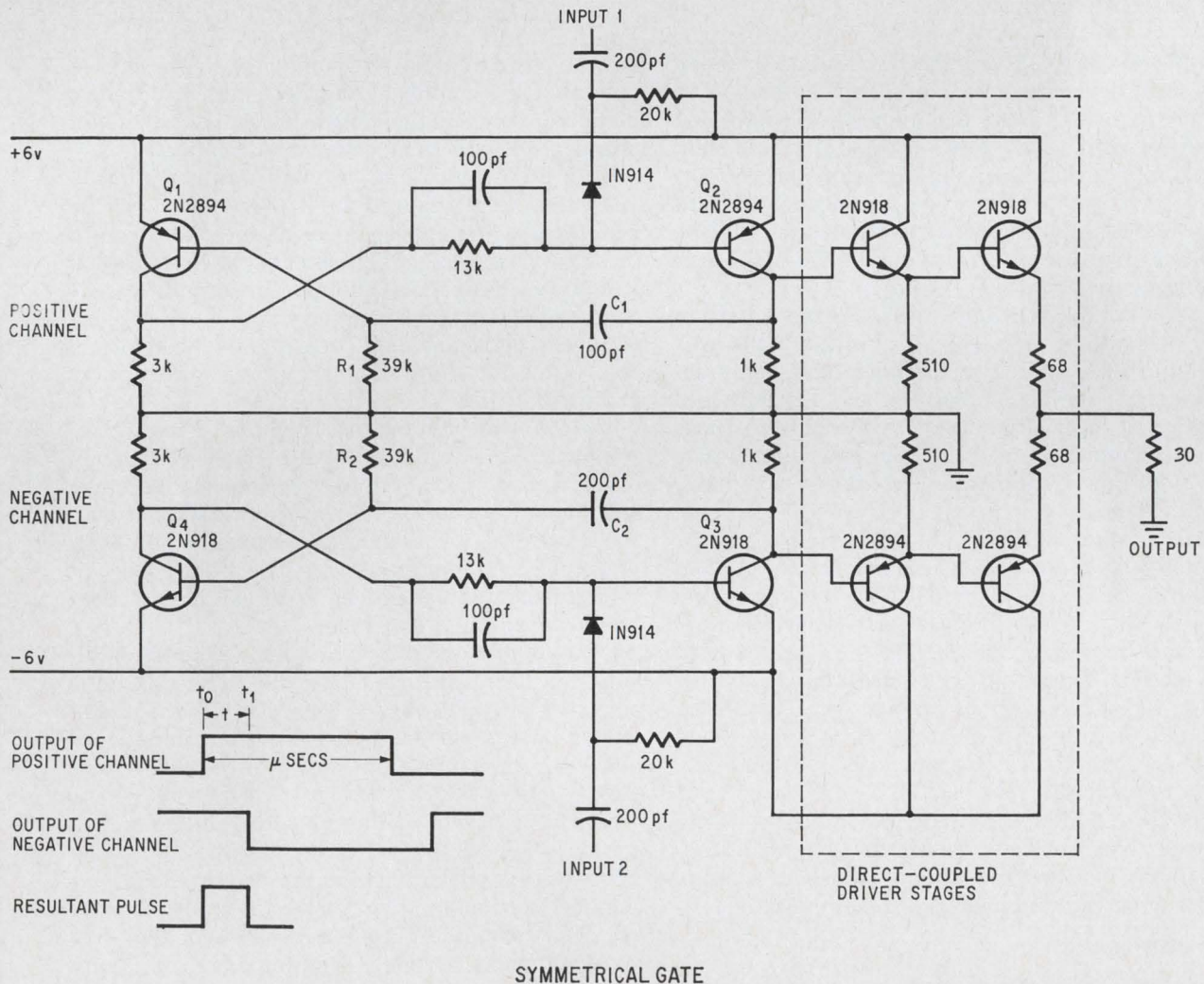

Back-to-back gate. Two-channel gate controls width and sharpens edges of output pulse. Overdriving multivibrator Q_1 - Q_2 produces a rise time of less than 5 nanoseconds in the output pulse. Overdriving multivibrator Q_4 - Q_3 results in a 5-nanosecond fall time.

Transistors share the load in a kilowatt amplifier

Summing the outputs of 15 four-transistor modules in the power section yields the first high-power solid state amplifier at 2 to 32 megahertz

By C.H. Wood Jr., A.W. Morse, and G.R. Brainerd

Westinghouse Electric Corp., Baltimore

High-power gain at very high frequencies using solid state devices—once a designer's dream—has become a reality. New techniques for combining power transistors have been incorporated in a solid state amplifier that has a peak envelope power output of 1,000 watts from 2 to 32 megahertz. Until now, the best high-frequency solid state amplifiers, operating over narrower portions of the band, had PEP outputs of about 200 watts.

Developed by Westinghouse's Surface division under a contract with the Air Force's Rome Air Development Center, the amplifier meets contract requirements for high reliability and linearity and operation at input drive levels as low as 0.25 watts PEP. It is intended for evaluation as a general-purpose, high-power solid state amplifier in communication systems.

Heart of the amplifier is a basic four-transistor module whose power is summed by broadband transformers. Since the transistors are electrically isolated, they can't interact and carry unequal shares of the current. Paralleling the outputs of 15 such modules in the power stages makes possible the unprecedentedly high output. The combining technique and the single-stage circuit developed enable the same type transistor to be used in every part of the amplifier.

There's an added advantage to combining power this way. If a transistor within an electrically-isolated four-transistor group fails, output power drops slightly, but the amplifier continues operating.

Once over lightly

Previous work at Westinghouse in power combining techniques influenced the final decision to use a basic four-transistor module in the amplifier. This decision—along with the results of studies recommending a goal of 40 watts PEP output per transis-

tor—helped determine the number of stages in each portion of the amplifier. And designers also had to produce a very reliable, linear device that would not change under different voltages or temperatures.

With these constraints in mind, engineers specified Class A operation in the first two stages of the preamplifier for highest linearity and Class AB in the next two stages for high linearity with somewhat less power dissipation. The final preamplifier stage consists of four transistors combined in an electrically isolated module. To maintain the required drive level, the third stage requires slight peaking at 22 to 32 Mhz.

The 0.25 watt input signal is amplified in the preamplifier 25 db to about 80 watts. Such a large gain results in large power differences between the lower and higher frequencies. However, a variable attenuator immediately following the fourth stage of the preamplifier compensates for the difference, insuring linear amplification. A tuned circuit then couples power into the driver.

Composed of three four-transistor groups, paralleled in a 12-transistor module, the driver raises the power level to 320 watts, a gain of 6 db. Interstage tuning circuits match the driver output impedance to the very low input impedance of the power amplifier section.

Five 12-transistor modules combine in the output portion of the amplifier, raising the power to the 1,000-watt output level. Like the driver, the power amplifier section operates Class B. Finally, a tuned circuit matches the output impedance of this section to 50 ohms, a widely used impedance in many communication systems.

At the preamplifier input, a limiter protects the amplifier from overdrive, and a drive control makes it possible to adapt the amplifier to different input drive levels.

Single-stage design

Although the amplifier combines 60 transistors in its power section, 12 in the driver, and four in the last preamplifier section, it was still possible to develop one basic circuit for all these transistors. The circuit is designed around an International Telephone & Telegraph transistor, 2N4130, which offered the highest available power gain at 2 to 32 Mhz.

A 50-watt continuous wave output device at 70 Mhz, it consists of two transistors packaged in a single can with an emitter resistor to equalize current gain. The stage operates in the grounded emitter configuration and is biased for Class B operation. Such a circuit offers a combination of high stability and power gain.

As in most Class B power amplifiers, circuit load impedance doesn't match the transistor impedance. Instead the load impedance is determined by $Z_L = (V_{cc} - V_{SAT})^2 / 2P_o$ where Z_L equals load impedance, V_{cc} collector voltage, V_{SAT} saturated voltage, and P_o power output. Load impedance is 10 ohms because 40 watts is the stage output required, 32 volts the collector voltage and three volts the saturated voltage.

The transistor selected has a maximum beta of 35 at 10 amps d-c. Primary advantage of using a low beta device in a high power amplifier is the greater linearity at high currents than with high-beta devices. Since stage gain is proportional to beta at high frequencies and to beta squared at low frequencies, high beta increases nonlinearity. In addition, at low frequencies high betas can cause circuits to oscillate.

Although oscillation is a basic problem in the design of any high power amplifier, it becomes particularly troublesome in broadband circuits. Since each transistor and its accompanying circuit must be able to pass the entire range of frequencies it is potentially less stable than a narrowband tuned

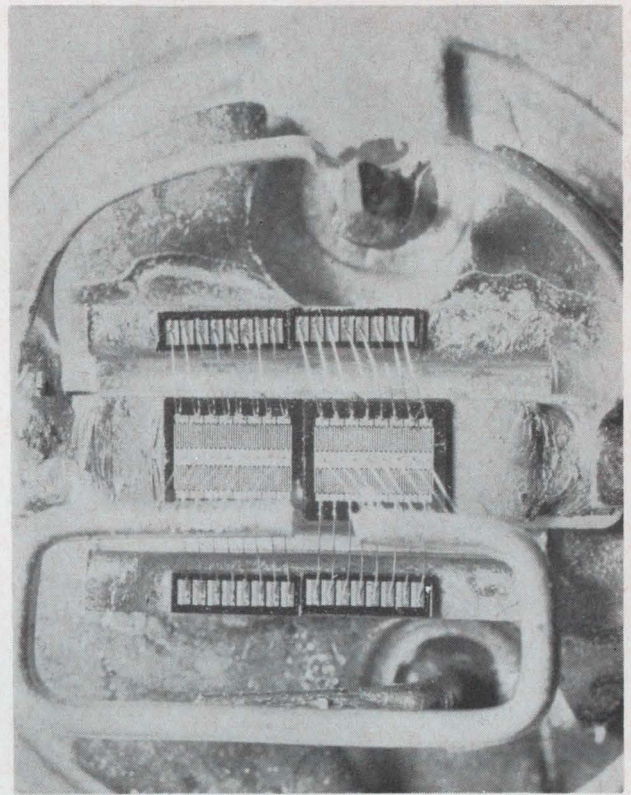

ITT transistor. The 2N4130, a dual-chip device, is used throughout amplifier. Resistors connected to the chips prevent unequal load sharing.

circuit would be.

Then, too, it's impossible to generate useful equivalent circuits for power transistors at high frequencies. Certainly an equivalent circuit can be developed—after careful measurements—for a transistor operating at a single high frequency and temperature, and at a specific voltage. But vary any of the parameters—frequency or voltage, for example—and the equivalent circuit ceases to be valid.

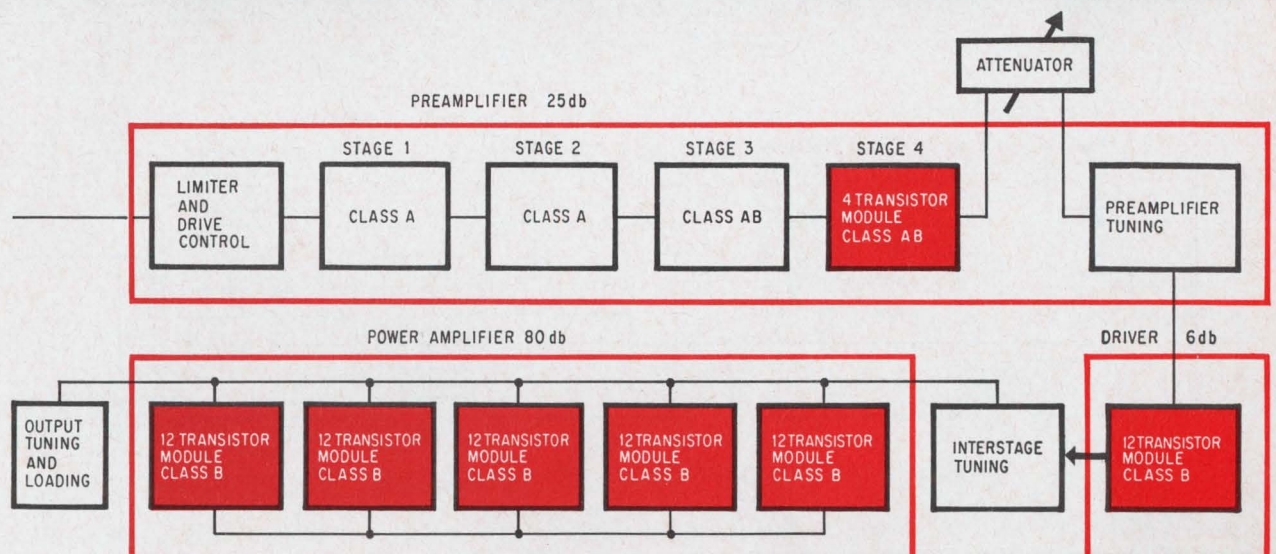

Solid state amplifier. Combining 60 transistors in its power section—which can be tuned as a unit—the 1-kilowatt amplifier operates with input drive levels as low as 0.25 watts.

succeeded in removing the random, low-frequency oscillations due to increasing gain—but not the other type.

One possible explanation for the second type of oscillation is that the circuit acted as a regenerative frequency divider. To eliminate this problem, designers added emitter degeneration. The emitter resistor introduced enough additional negative feedback to reduce the gain of the transistor stage, thus minimizing variations in gain at different frequencies. Another way of looking at this is that emitter degeneration linearized the base-emitter diode, reducing its frequency mixing capabilities. Emitter degeneration required the insertion of electrical insulating washers between the transistor can and the heat sink.

Stage linearity

Though feedback increases linearity, the most important cause of linearity in an amplifier is the basic transistor used. Peripheral circuitry can only take advantage of this linearity and improve it by techniques such as feedback.

The most significant nonlinearity of the transistor in the amplifier arises from a change in impedance occurring around 0.7 volts. But a small amount of forward bias solves this problem. Since transistors are basically current amplifiers, a series base resistor at the input of each transistor in the amplifier makes the r-f input look more like a current and less like a voltage source. Thus, linearity of the collector current depends on the linearity of the r-f source.

Since the envelope of the r-f input signal modulates the bias voltage at the base of the transistor, it was necessary to empirically determine the optimum bias impedance for highest linearity. For best results, the bias network should provide +0.5 v at 40 to 80 watts output and taper down to 0 v at 160 watts at the module output.

Other noteworthy features of the circuit include the use of multiple bypass capacitors, which are connected to the cold side (the point of r-f ground) of the collector circuit. These serve in lieu of a single larger capacitor which would not have a low enough impedance over the wide band of frequencies amplified.

Rather than use high-power wirewound resistors and then have to cope with their inductances, several input base resistors were paralleled. In the same way, paralleling resistors in the emitter circuit minimizes inductances.

A capacitor across the base resistors develops a broad series resonance, in combination with the base circuit inductance, thereby coupling the maximum signal into the transistors at 22 to 32 Mhz where it becomes necessary to use frequency peaking.

Sharing the power

Since no single transistor matches the power of a high-frequency tube, designers of high-power solid state amplifiers have no choice but to combine

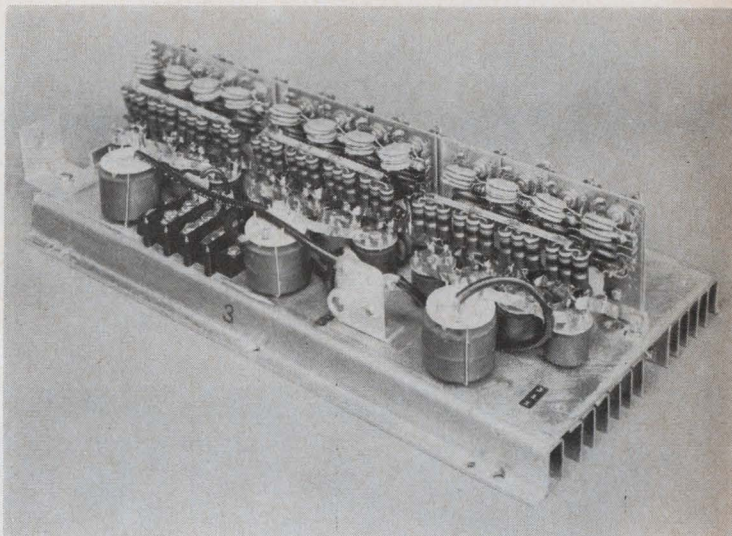

12-transistor module. Used in the driver and power stages, module includes paralleled ferrite transformers which sum the outputs of four electrically isolated transistors.

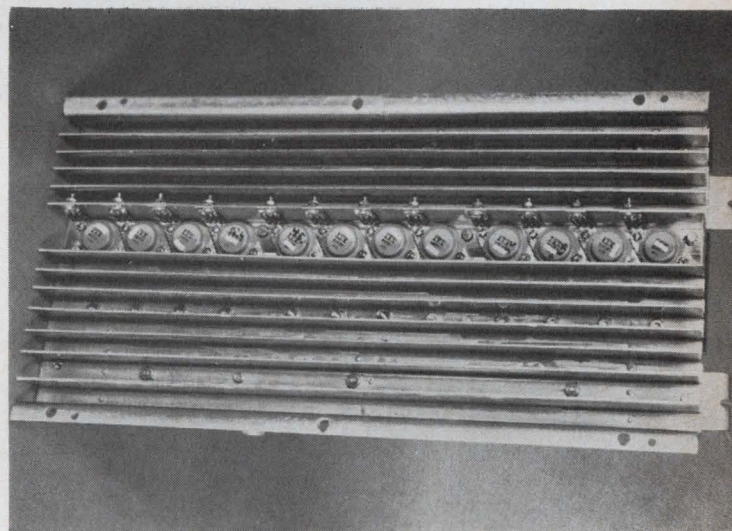

Transistor mounting. On opposite side of module chassis, transistors are mounted between heat-sink fins. Heat-sink material is a 0.13 inch copper sheet.

the outputs of many transistors. They can do so either by paralleling transistors or by electrically isolating them. But it's not so easy to parallel even two transistors because at high frequencies the inevitable slight differences in transistor parameters become exaggerated, causing them to share drive and load unevenly. Also, paralleling transistors lowers their impedance.

Since the desired load impedance for each transistor in the amplifier is about 10 ohms, paralleling the 60 transistors in the power amplifier section would require a 0.16 ohm impedance. Tuning at such a low impedance requires impractically outsize reactive components. Even if such devices were

Two-tone tests on solid state amplifier

At right, both waveshapes result from measurements made at 1,000 watts PEP. Tests simulate single-sideband-type signal.

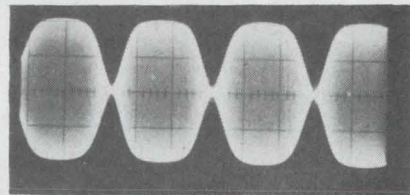
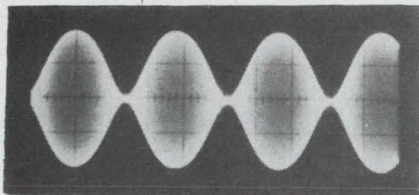
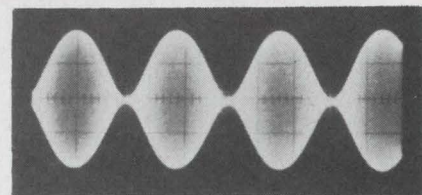
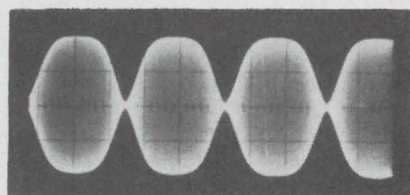
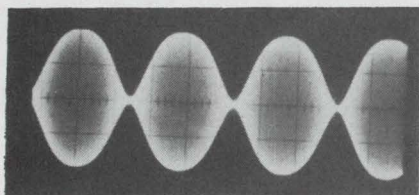
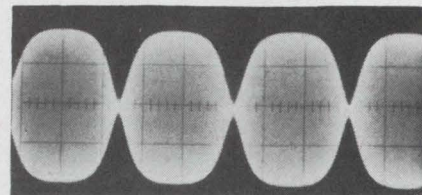
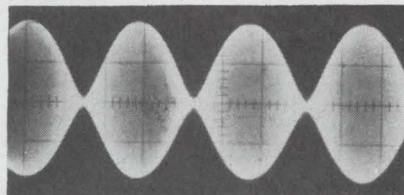

These five waveshapes result from measurements of linear amplifier, all made at 12 Mhz at different power outputs.

built, they'd cause enormous losses in the circuit.

To avoid the problems of paralleling transistors, Westinghouse developed the techniques for combining transistors in electrically isolated groups of four. Within these groups each transistor delivers its power to its transformer—a broadband device developed by Westinghouse. In addition to preventing transistor interaction, the transformers step up the output impedance. A similar transformer sums the output of the four transistor-coupled transformers in the group.

Since the output of the combining transformer has summed the output of the four transistors, there's no problem in paralleling it with other combiners. Four combiners are paralleled and then their output is paralleled in turn with four other 12-transistor modules to form the 60-transistor power section.

Tuning and matching

Since the power-combining transformers pass all frequencies in the 2 to 32 Mhz range, it's not necessary to tune every transistor individually on both base and collector. Instead all transistors in the power section can be tuned in toto. Tuning performs a triple function. It filters out harmonics inherent in any single ended Class B amplifier limits bandwidth for rejection of wideband harmonics, and matches impedance.

The transistor used is virtually broadband over the entire high-frequency range. It's average collector capacitance is about 200 picofarads so that at 32 Mhz—the worst case—shunt reactance is only 25 ohms or 2.5 times greater than the desired resistive load. This simplifies tuning because the transformers need only present a correspondingly low reactive component of the opposite sign.

Nevertheless, the extremely low impedance levels in the amplifier required developing new tuning techniques. For simplicity, compromises had to be made between minimum reactance and maximum transfer of power from stage to stage.

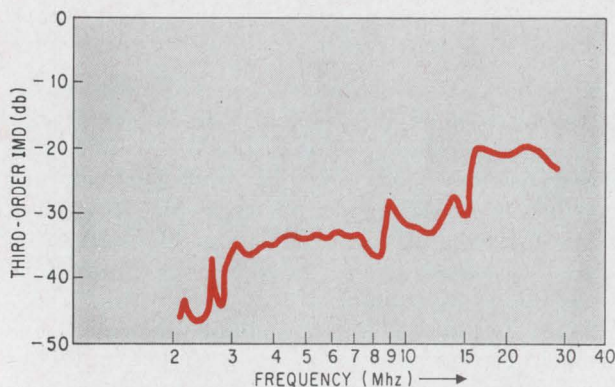

Intermodulation distortion. Measurements at 1,000 watt PEP of amplifier's third-order intermodulation distortion were taken at different frequencies. Plot indicates the high linearity of the amplifier.

How it's done

A series resonant circuit tunes the four transistors in the last stage of the preamplifier. From 2 to 8 Mhz the circuit is at the input of an impedance-matching transformer, from 8 to 15 Mhz and from 15 to 32 Mhz, it's switched to the output of the transformer. A three-position band switch selects the set of frequencies to be tuned. At 15 to 32 Mhz, the switch removes the variable attenuator from the preamplifier circuit.

Most difficult to tune is the driver output, because its impedance must match input impedances as low as 0.05 ohms when r-f currents are as high as 40 amperes. A broadband transformer—actually a composite of five transformers paralleled—is used to accomplish a 25-to-1 impedance match. On the low-impedance side of the tuned circuit, a series resonant circuit compensates for inductance from transistor leads. To keep loaded Q constant, the driver portion is tuned in four separate frequency bands.

The tuning transformers get some help in matching the driver output impedance to the power amplifier input impedance. The inputs to the five power modules are paralleled through two-section coaxial lines whose diameter changes at a certain point. These lines themselves act as impedance transformers and also minimize reactance.

Tuned circuits in the power section use fixed coils with an effective turns ratio of 4 to 1 for an impedance transformation of 16 to 1. These are series-tuned on the low impedance side of the circuit to eliminate lead inductance. This part of the amplifier is tuned in two bands: from 2 to 8 Mhz and from 8 to 32 Mhz. Padding capacitors along with a 100-to-5,000 pf variable capacitor are used in low band tuning. In the high-band circuit the tuning coil consists of six parallel coils and links. This allows tight coupling between coils and lowers inductance.

Housing

The amplifier is in an aluminum cabinet with one removable drawer that contains all low-power circuitry as well as the power amplifier tuning circuitry.

Standing back to back in pairs are the six 12-transistor modules that form the driver and power amplifier sections. Three blowers send forced air in through a finned channel between the modules. Making efficient use of the fins are heat sinks of 0.13-inch copper.

Very large commercial power supplies—rated at 32 volts up to 100 amperes—insure good short time power regulation. Initially, it was found that the high peak current demanded by the amplifier caused excessive d-c drops, which affected linearity and stability.

The specs

Once design was completed, measurements were made of output power, third and fifth order har-

monics, hum and noise products, bandwidth, and voltage standing wave ratios. For example, output power and third and fifth order harmonics were measured at 82 frequencies from 2 to 32 Mhz. These measurements were made at 1,000 watts PEP output.

Below 25 Mhz, amplifier power is nominally 1,000 watts, although more can be obtained at the expense of linearity. Above 25 Mhz, power is limited by distortion of the modulated envelope and by the drive power.

Hum and noise measurements, made at full power output with a spectrum analyzer, showed the 60 hz hum product to be -41 db and the 120 hz product to be -55 db.

The minimum bandwidth of plus or minus 12 khz—specified in the contract requirements—was met at every frequency in the 2 to 32 Mhz band.

Mean time between failure of the amplifier far exceeded the 2,000-hour objective. Calculating from the failure rate of the components used, as listed in the Rome Air Development Center reliability notebook, the MTBF of the amplifier is 8,300 hours. Actually, it should even exceed that because of the redundancy arising from the power combining techniques.

During the design of the amplifier, requirements were established for higher value variable capacitors with high current capacities; low-inductance, low-resistance resistors; low-inductance bypass capacitors, and low-impedance coaxial cables. Had these components been available commercially, amplifier design time would have been reduced considerably.

The authors

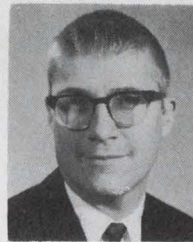

Charles H. Wood, supervisory engineer in the equipment design engineering department at the defense and space center, has worked on solid state digital and analog circuitry. After graduating from Rensselaer Polytechnic Institute in 1956, he started with Westinghouse in its radio-tv division.



Alfred W. Morse, of the radar engineering department, has designed solid state communications amplifiers in the h-f and vhf bands. He graduated from the University of Michigan in 1963 and has done graduate work at Pittsburgh and Maryland.



G. Reed Brainerd started with Westinghouse in 1956 as manager of the solid state technology section, became program manager, solid state radar, and is now an advisory engineer, science and technology, in the company's defense and space center in Baltimore. He received his MSEE from Ohio State University in 1953.

Reader's Choice

IEE bright, legible, wide-angle readouts:

Any characters desired
Any colors or combinations
Any input, BCD or decimal
Any input signal level
Any mounting, vertical or horizontal

Many sizes
Many configurations
Many lamp lives (to 100,000 hours)
Many brightness choices
Many options and accessories

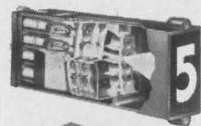

Standard Readouts: Rear projection principle, like all IEE readouts. A lamp in the rear of the unit illuminates one of the 12 film messages, and projects it to the front viewing screen. Unbeatable readability and versatility.

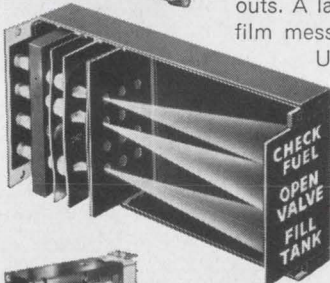

Large Screen Readouts: For reading distances up to 100 feet. Maximum character size $3\frac{3}{8}$ ".

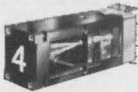

Miniature Readouts: Only 1" wide x 1-5/16" high, yet can be read at 30 feet because of clarity of one-plane projection. Character size: $\frac{5}{8}$ ".



Micro-Miniature Readouts: Only $\frac{1}{2}$ " wide x $\frac{3}{4}$ " high, but 20 foot viewing distance and maximum 175° viewing angle because of front-plane display. Character size: $\frac{3}{8}$ ".



Hi-Brite Readouts: Special lens system increases character brightness 50%. Particularly good when high ambient light conditions exist.

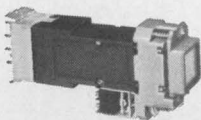

Cue-Switch Readouts: Rear projection readout with push-button viewing screen. Combination switch and display device.



Bina-View Readout: Accepts binary or teletype code, decodes, and displays the proper character.



Status Indicator Readout: Displays up to 12 different messages, individually or in combination. Viewing screen only 3 sq. in.



Indicator Assemblies: Available with up to 11 rear projection readouts, for indicating seconds, minutes, hours, days, etc.



Driver/Decoder Module: Designed to work with IEE Readouts. Accepts a variety of binary codes for decimal conversion.

The new IEE Display Devices catalog gives complete information and specifications on these products, and their accessories. Ask for it.



"I-double-E", the world's largest manufacturer of rear projection readouts.
Industrial Electronic Engineers, Inc. 7720 Lemona Avenue, Van Nuys, California

Japanese technology

Research in solid state pays off for Japan

The accent on home-based research begun by the Japanese more than two years ago [Electronics, Dec. 13, 1965, p. 77] is one of the big reasons for the soaring production of semi-conductors in Japan. The success of such devices, now in high-volume production, yields profits that can be plowed back into further product development. Today's research and development is meticulously calculated to meet the future needs of Japan's thriving electronics industry.

Page 110 Japanese designers of discrete devices call their shots

Page 117 Optoelectronics goes digital

Page 125 Bulk effect devices focus on communications

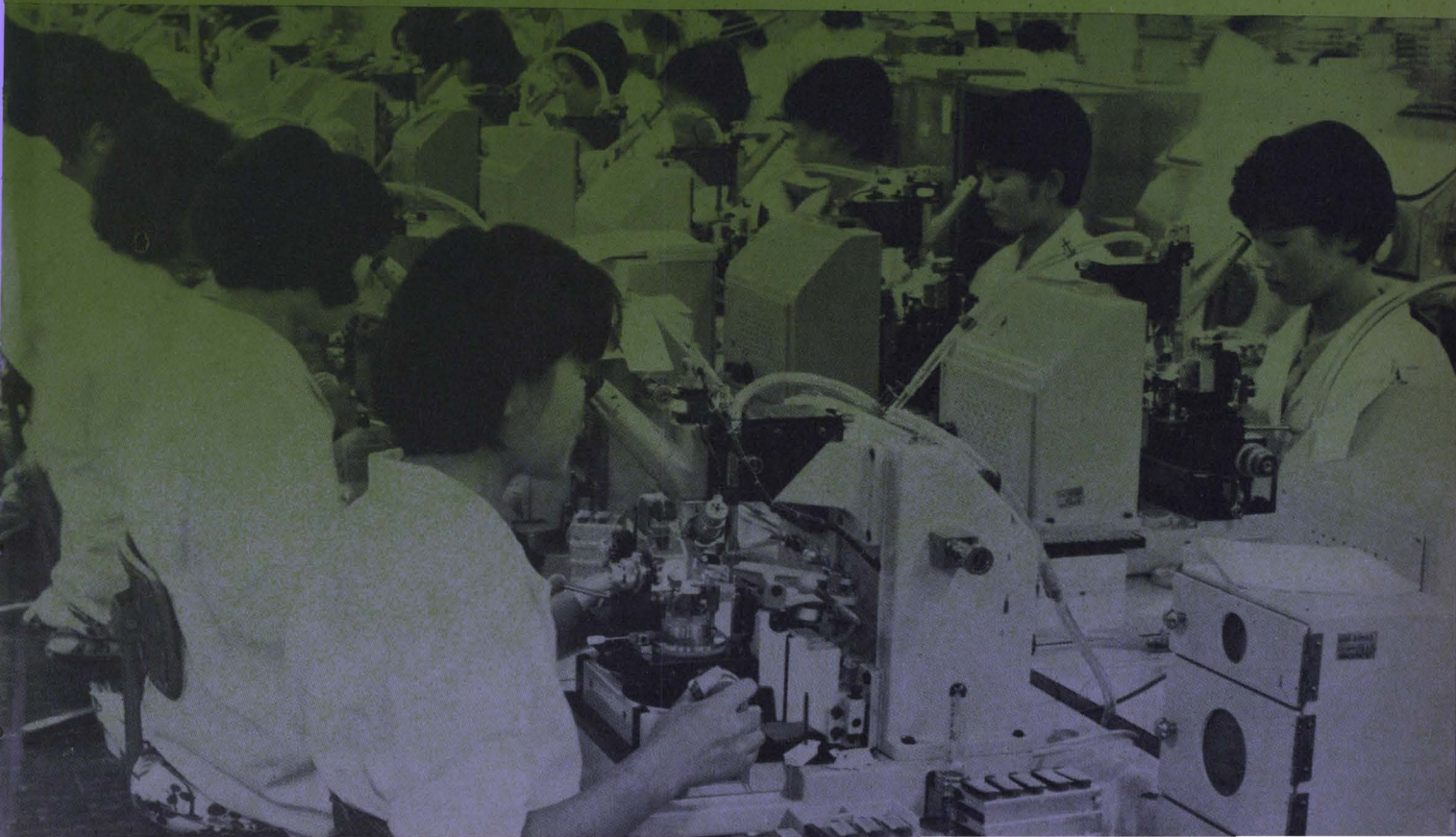



Small loss of 'face' yields big gain in semiconductors

Building on a base largely borrowed from the U. S., Japan is now setting its own course in this field and hopes to leapfrog ahead

Japan's initial efforts in solid state technology seemed aimed at refuting the old aspersion that Japanese technicians can only copy the designs of others. Striking out on its own a few years ago, Japanese industry wound up proving only that such pride goeth before a fall. Production levels and techniques weren't sufficient to keep prices down in the face of rising labor costs, and though a trickle of money was available for R&D, research facilities were inadequate and managers were insisting on overnight results.

But in recent years, Japanese engineers have put aside "face," and have set out to exploit U.S. technological developments and to learn from mistakes made by U.S. firms. When necessary, Japanese companies have signed licensing agreements with foreign concerns. [Fujitsu Ltd. is the only firm that won't enter into such pacts with outside companies.]

Along with this, domestic research and development has begun to pay off. And seeing the results of the modest projects launched a few years ago, managers are becoming conditioned to the necessarily slow pace of R&D.

Even with a partly borrowed base, though, the evolving solid state technology is uniquely Japanese. Most R&D programs today are tailored to the specific needs of the domestic electronics industry; work on bulk-effect devices, for example, is aimed at applications in communications equipment, a Japanese specialty. Japanese engineers hope to leapfrog U. S. developments whenever possible. A strong incentive here is that paying royalties to owners of U.S. patents is both costly and embarrassing.

Growth areas

Japan's stock in trade is consumer electronics. A few years ago, transistors were employed almost exclusively in radios. Today, they're being used in black-and-white television receivers, though not as extensively as Japanese marketers had anticipated. But transistorized sets should soon be directly competitive with tube sets as a result of work on high-

voltage transistors at firms like Toshiba (the Tokyo Shibaura Electric Co.) and the Matsushita Electronics Corp.

The total production of discrete semiconductor devices in Japan has almost doubled in the past two years (from 47.5 million in January 1965 to 88.9 million in January 1967). This year has seen a leveling off in sales, and some inventory building.

Production of germanium transistors is up sharply, but silicon-transistor output has increased even more dramatically. Early in 1965, only one of every 20 transistors was silicon; today the ratio is about one in five. Silicon transistors, used until recently mostly in computers and other nonconsumer equipment, are now being put in inexpensive radios. They are also finding their way into desk calculators, where their stability at high temperatures makes stabilization networks unnecessary and thus saves cabinet space.

Semiconductors for industrial use are attracting research interest, possible because the Japanese feel automation may be the answer to climbing labor costs. In particular, developments of thyristors and rectifier diodes are on the increase. Thyristors rated up to 2,500 volts at 400 amperes are being used in drives for mills, and are also being designed into new control gear for Japan's high-speed trains. Experimental thyristors have been built with ratings of 3,500 volts at 500 amps, and 2,500 volts at 800 amps.

Still larger thyristors are sought for high-voltage d-c transmission systems and for nuclear accelerator pulse modulators, but a spokesman for a research group at the electrotechnical laboratory of the Ministry of International Trade and Industry maintains that development is constrained by present design techniques.

The present rating for rectifier diodes is 5,000 volts at 500 amperes; the goal is 10,000 volts at 1,000 amperes. The rectifiers are used in d-c railway substations and in power supplies at aluminum and chemical plants.

If Japan was to continue to compete successfully

in world markets, a Japanese expert observed in 1965, she would have to become a highly automated producer. The advantages of cheap labor were disappearing; in the early 60's, labor costs rose at a rate of about 10% a year.

Penny-pinching

The advice was taken to heart by Japanese semiconductor manufacturers. Cost reductions and high volume have become bywords with Japanese production experts, who are notably reticent about discussing proprietary manufacturing methods that can shave pennies from the cost of a device.

Like U.S. manufacturers, the Japanese seek the elusive transistor that can be universally applied. The Sony Corp. now has a single basic transistor for most low-power applications from audio amplifiers through i-f stages for f-m equipment. The advantages of broad-use types lie in driving volume up and costs down.

Many Japanese semiconductor makers are banking on plastic or epoxy encapsulation to help reduce transistor costs. Even the Nippon Electric Co.—long a holdout with its low-cost “microdisk” package—has joined this group and is now producing plastic-covered transistors.

Big push

Japanese solid state researchers and device developers are, in the main, concentrating their efforts in the areas of conventional discrete devices, optoelectronics, and bulk effects. A great deal of work is also being done on integrated circuits.

Typical of the fields in which Japanese are trying to jump ahead of American technology is high-frequency power transistors. The Kobe Industries

Corp. has developed the mesh-emitter transmitter, a continuous emitter device that borrows from the overlay technology but which Kobe engineers think will provide twice the power-frequency product. A description of these devices, along with an assessment of new Japanese developments in varactor diodes and thermistors, is given in the article beginning on the next page.

In the optoelectronics field, Japanese researchers have set their sights on two goals—high-speed logic using injection lasers, and computer input and output equipment using phototransistors and electro-luminescent diodes [see the article on page 117].

The Gunn-effect oscillator is being studied for its potential use in the nation's communications system. Power outputs have so far been too low, but the hope is that a commercial device may be just around the corner [see the article on page 125].

Lineup

The major Japanese makers of transistors and diodes for consumer applications are Toshiba, Hitachi Ltd., Matsushita Electronics (a joint venture of the Matsushita Electric Industrial Co. and Philips Gloeilampenfabrieken of the Netherlands), the Tokyo Sanyo Electric Co. (a subsidiary of the Sanyo Electric Co.), Nippon Electric, the Mitsubishi Electric Corp., Sony, and Kobe Industries (a subsidiary of Fujitsu). Other transistor manufacturers include Fujitsu, the Oki Electric Industry Co., the Shindengen Electric Mfg. Co., the Sanken Electric Co., the Shiba Electric Co., and Kyodo Electrics Laboratories Inc. A good deal of Japan's solid-state research is sponsored, coordinated, and conducted by the government's Ministry of International Trade and Industry laboratories.

Semiconductor production in Japan

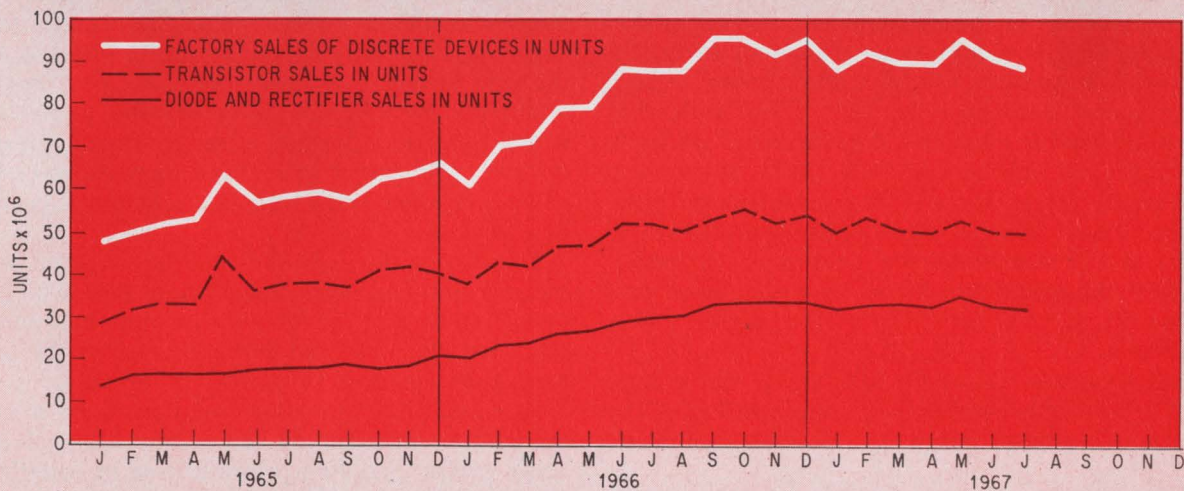

Graphs are based on figures from the Japanese Ministry of International Trade and Industry. The top line represents factory shipments of transistors, diodes, rectifiers, and miscellaneous devices, but does not include integrated circuits. January 1965 shipments accounted for factory sales of \$9.8 million; shipments in July 1967 represented factory sales of \$11.3 million. Production exceeded sales in the first seven months this year, and factory inventories climbed by about 57 million units over that period.



Tailoring the device to suit the need

When it comes to radio-frequency transistors, varactors and thermistors, designers are primarily aiming their devices at the domestic market

By Takuya Kojima

Electrical Communication Laboratory, Nippon Telegraph & Telephone Public Corp., Tokyo

Developments in discrete semiconductors are being tailored for the most part to meet requirements that are peculiarly Japanese. Among the major areas of concentration are radio-frequency power transistors, varactors, and thermistors. In transistors, Japanese engineers have pioneered a continuous emitter structure called the mesh-emitter, a graft-base structure, and devices designed specifically for 13.5-volt mobile communications equipment.

Developments in varactors are prompted by communications applications such as frequency and phase modulation for the nation's microwave telephony systems. And in thermistors, they have come up with their own stable, rugged devices for use in gain-control systems for telephone carrier amplifiers.

Mesh-emitter transistor

Capitalizing on the development of overlay and interdigitated structures—the mainstays in American-made transistors for generating power at high frequencies—engineers at the Kobe Industries Corp. decided to carry it a step further. Turning to a continuous emitter structure, Kobe researchers developed what they call the mesh-emitter transistor. These devices have already produced 10 watts at 400 megahertz, with minimum efficiencies of 50%. American transistors, however, have produced 50 watts at 500 Mhz with a slightly lower efficiency.

At frequencies above 300 Mhz and power greater than 1 watt, the current load concentration at the transistor's emitter periphery becomes a problem.

The author

Takuya Kojima is deputy director of the electronic device development at NTT's Electrical Communication Laboratory in Tokyo. Before turning to semiconductors in 1955, he designed vacuum tubes. Kojima holds a doctorate degree from Osaka University.

Depending on the size of the device, this unequal distribution of the load can lead to the transistor's destruction. To prevent saturation limitations as well as destruction, designers of r-f transistors seek a high ratio of practical emitter periphery length to collector area.

Kobe's approach is to have the device's base contacts consist of islands within the continuous emitter mesh, allowing the emitter to be narrowly shaped along large lengths. Thus, the base and collector areas are correspondingly reduced. Depending on the geometry, the periphery length-to-collector area ratio of a mesh-emitter transistor can be as much as twice that of an overlay device and half again larger than that of an interdigitated structure.

Also critical to high-frequency performance is the device's base resistance: the lower it is, the larger the high-frequency gain. Early mesh transistors had a heavily doped p^+ region diffused into the base structure to lower the resistance. But by improving the resolution, Kobe was able to do away with the diffusion. Instead of the p^+ region, present devices have shorter paths (and thereby lower impedances) between the base contacts and the active base regions.

Eliminating the extra diffusion has brought with it easier and less costly fabrication, narrower patterns because there no longer is an inner base structure, and the outright elimination of slight area irregularities caused by spreading dopants.

Successful in improving resolution, Kobe is now turning its attention to increasing the collector area's current-handling per unit area by lengthening the emitter periphery. Higher current density, the company believes, will lead to a smaller collector area that will lower output capacitance and result in a higher maximum frequency. Kobe is confident this will boost present power-frequency products from the 4,000 watt-megahertz level—10 watts at 400 Mhz—to the 10,000 watt-megahertz range

within a year or so. Even higher products could be attained by joining transistor cells before the chip is diced.

And, by reducing the collector area, even lower fabrication costs are possible because more devices could be put on a given wafer area.

Overlay and interdigitated

Although Kobe is concentrating on mesh-emitter transistors, other companies are pressing on with overlay and interdigitated structures. Unlike their American counterparts, which are fabricating devices for 28-volt operation, these firms are tailoring devices for 13.5-volt operation—primarily for mobile communications equipment in the 300-to-470 Mhz frequency range.

But instead of using the conventionally diffused base, Japanese engineers have turned to the graft-base structure pioneered by the Nippon Electric Co. [Electronics, Dec. 13, 1965, p. 81]. The graft-base configuration, which is essentially a double-diffused structure, is claimed to reduce both contact and bulk resistance in the transistor's base—thus reducing parasitic capacitances and raising frequency capabilities.

Nippon Electric considers the overlay transistor best for large-signal r-f applications—a few watts or more in the very-high-frequency range—and the interdigitated structure best for small-signal applications and for jobs requiring gigahertz frequency operation.

More effort has been spent recently on the interdigitated types. Among the results of this effort is the V415, a transistor with a 3-Ghz cutoff frequency, a 10-decibel power gain at 2 Ghz, and a 6-db noise figure at these frequencies. A successor having a smaller dynamic range is the V417. This device has a 5-db power gain at 4 Ghz, a 1-Ghz bandwidth, and a 5-db noise figure at 2 Ghz. Both types are assembled in ceramic stripline packages to simplify matching with stripline wiring and minimize parasitics.

And, both types have lead inductances of a fraction of a nanohenry and interelectrode capacitances of 0.1 picofarad—about 10% of the parasitics found in TO-18 packages.

Compared with American-made interdigitated devices, the Japanese devices have shallower collector junctions (0.3 micron) and narrower bases (0.1 micron). These result in transistors with an extrinsic base resistance-collector capacitance product, $r_{bb}'C_c$, of only 1.0 picoseconds (typically), which is 33% lower than that of comparable U.S. semiconductors.

Among standard power devices developed for the 13.5-volt operation are predrivers, drivers, and final-output stage transistors. At 500 Mhz, the predrivers develop 1.3 watts output with an input of 0.3 watt; the drivers, 3.2 watts at 1 watt; and final-output transistors, 7.5 watts at 3 watts. Collector efficiencies typically exceed 60% and the devices may be operated with bias supplies rated as low as 10 volts.

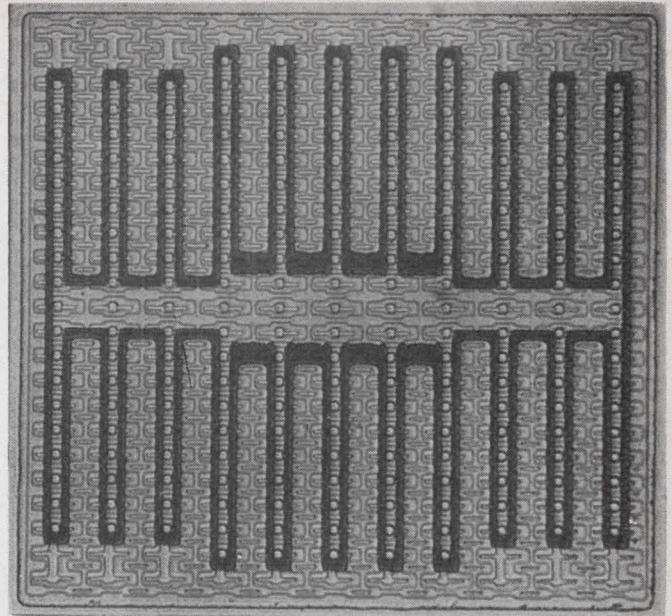

Extra diffusion. Early mesh-emitter transistor required a p+ diffusion (horizontal bars) within the emblem-shaped base region to lower base resistance.

Nippon Electric expects to fabricate an interdigitated structure capable of handling 5 watts at 2 Ghz within the next 18 months. To do this requires a tradeoff—increasing the peripheral length of the emitter stripes at the expense of uniform emitter current distribution. Other improvements will have to be made in stripline packaging and heat-sink materials, but neither these nor the tradeoff appear unrealistic.

Varactors a major front

When it comes to varactor diodes, virtually all Japanese semiconductor firms are either developing or manufacturing these variable capacitance devices. And their efforts embrace several state-of-the-art devices, including hyperabrupt junction diodes, gallium-arsenide varactors, and composite (series-connected) diode multipliers.

The impetus for hyperabrupt junction diode

Characteristics of typical mesh-emitter transistor

Breakdown voltages:	V_{CBO} :	65 v (min.)
	V_{CEO} :	40 v (min.)
	V_{EBO} :	3 v (min.)
Collector current, I_C:		2.5 amps (max.)
Dissipation (at 25°C), P_D:		10 w
Output capacitance, C_{ob}:		5 pf (at $V_{CB} = 30$ v)
Cutoff frequency, f_T:		600 Mhz (at $V_{CB} = 28$ v, $I_C = 200$ mA)
Output power at 400 Mhz, P_o		
(at $V_{CE} = 28$ v, $P_{IN} = 2$ w):		10 w (50% efficiency)
(at $V_{CE} = 28$ v, $P_{IN} = 1$ w):		6.5 w (50% efficiency)
(at $V_{CE} = 13.5$ v, $P_{IN} = 2$ w):		5 w (60% efficiency)
(at $V_{CE} = 13.5$ v, $P_{IN} = 1$ w):		3 w (60% efficiency)
Emitter periphery-to-collector area ratio:		0.15 micron per micron ²

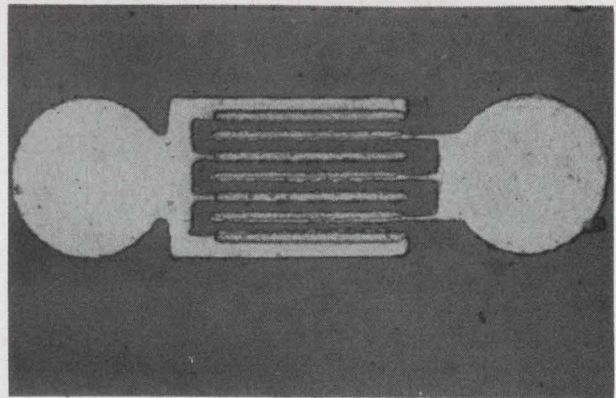
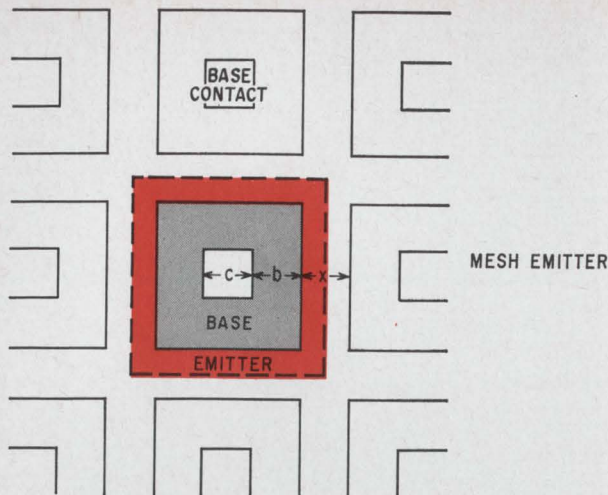

Interdigitated. Nippon Electric Co.'s interdigitated transistor has seven fingers (horizontal bars), four in the base portion, at left, and three in the emitter. Outer stripes have additional, widening elements to lower base resistance.

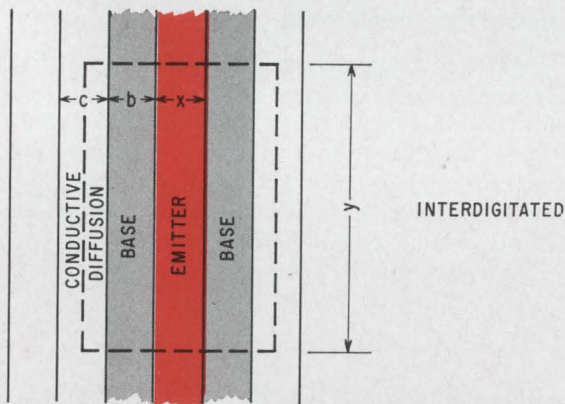
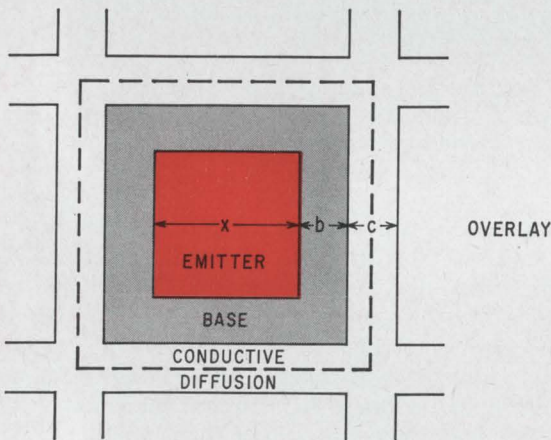

Comparing structures. R-f transistor geometries establish power-frequency capability. In these three devices, k is the smallest achievable unit dimension that can be fabricated, and is smaller than the region-defining dimensions x , b , and c .

development stems largely from communications applications that require devices having a large change in capacitance in response to a small voltage shift. Among these are frequency- and phase-modulators, automatic frequency control circuits, and voltage-tuned networks, and oscillators and modulators for microwave telephony.

New types

Among the varactors recently developed is Nippon Electric's 1N1617-19 series. The voltage-capacitance characteristic of these hyperabrupt junction diodes is determined by an impurity profile. As the depletion layer is approached, the doping level increases. This layer's spreading region has two sections—a high-impurity concentration and a low-doped segment. Nominal capacitance in the high-impurity region is relatively large, while that in the low-doping section is much lower.

Unlike conventional diodes, the doping level in Nippon Electric's diodes decreases on the side of the junction into which the depletion layer extends when reverse voltage is applied. The result: a diode with a narrow depletion layer at zero bias. As the reverse bias increases, the depletion layer slowly extends to the far boundary of the high-impurity concentration. As the bias is further increased—even slightly—the depletion layer moves into the low-doped region and undergoes a large change in width. The net effect is a large change in capacitance for small change in applied voltage.

The company's silicon hyperabrupt varactor series have Q 's of 20 and nominal capacitances of 30 pf, obtained at a frequency of 70 Mhz and with an applied voltage of 4 volts. As the voltage is varied from 0 to 15 volts, the capacitance changes from 70 pf initial value to a final value of less than 2 pf. Some of these diodes have already been designed into the f-m portion of a microwave system, to produce a ± 10 -Mhz swing around a 70-Mhz center frequency.

Similar performance has been obtained by the Mitsubishi Electric Corp. Its hyperabrupt junction diodes, which have also been used to generate

R-f geometries: critical ratios compared

Transistor type	Emitter periphery, P_E	Collector area, A_c	Periphery-area ratio, $F = P_E/A_c$
Mesh emitter	$4(2b+c)$	$(x+2b+c)^2$	$F_{ME} = 0.75/k$
Overlay	$4x$	$(x+2b+c)^2$	$F_O = 0.33/k$
Interdigitated	$2y$	$y(x+2b+c)$	$F_I = 0.5/k$

microwave frequency oscillations, have a p-n⁺-n-n⁺ structure.

Mitsubishi is eyeing hyperabrupt devices for applications at Ku-band frequencies (15.35-17.25 Ghz), and up to 18 Ghz. The company claims the varactor's operating modes are similar to that of the Read diode.

The company has already employed hyperabrupt devices experimentally as microwave oscillators at Ku band, but performance fell short of the Read model. Oscillations as high as 15-18 Ghz and a tuning range of 2 Ghz were recorded, but the output of 62 milliwatts was only 40% of the desired value. A company spokesman blames the depletion layer, which he said was too narrow. The company is now striving for 150-mw outputs at 15 Ghz, using wider layers, and is confident it will achieve this goal in 1968.

GaAs on the rise

Mitsubishi has also developed gallium-arsenide varactor diodes, claiming the high-frequency properties of these devices are superior to that of silicon and germanium units. These epitaxial p⁺-n-n⁺ devices are reported to have very low package capacitance per unit area and small series resistance—0.2 pf and 2.0 ohms, respectively. Junction capacitance is nominally 0.3 pf, and cutoff frequencies reach as high as 700 Ghz.

The company has also used GaAs to make multipliers and Schottky-barrier mixing devices. The frequency-doubling units produced output powers of 300 mw at 24 Ghz, with an efficiency in excess of 40%. The Schottky devices contain gold electrode replacements for the p-material layer. At a bias of -2 volts, these diodes had a noise figure of 6 db at X-band, a cutoff frequency of 370 Ghz and a breakdown voltage of 11 volts.

Using varactors in series isn't new, but composite devices in a single package have been made available only recently in the U.S. When n varactor diode frequency multipliers are connected electrically in series, the over-all power-handling capability becomes n² times that of a single diode. Similarly, connecting n diodes in thermal parallel reduces the net thermal resistance to 1/n² of that of the single varactor.

Fujitsu Ltd.'s FC33B varactor unit contains two diode chips that have been connected in series. The composite has a voltage rating of 250 volts, a thermal resistance of 4°C/watt, and a nominal capacitance of 10 pf. Corresponding figures for U.S. state-of-the-art devices are 150 volts, 12°C/watt, and 5 pf.

When used as a quadrupler, the device produced an 11-watt output at 2 Ghz, with an efficiency of 46%. Since operation was linear, and there was no evidence of saturation, higher outputs are expected.

Taking the heat off

Temperature-sensing resistor elements mark another solid-state area in which Japanese engi-

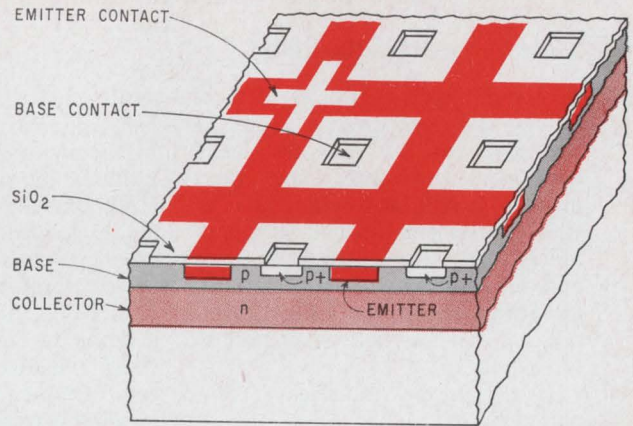

Mesh emitter. Heart of the mesh-emitter transistor is its continuous emitter structure.

neers have departed from American technology. Fujitsu, dissatisfied with the state of the art of these thermistor devices, developed its own germanium thermistors. The company contends that the new devices, negative temperature-coefficient types, are more stable and less fragile than conventional thermistors.

Two types have been built—an indirectly heated bulk-effect unit and a directly heated thin-film unit—both primarily for communications equipment. Aside from use in gain control systems for telephone carrier amplifiers, the thermistors may also find application in power supplies, servos, computers, and for telemetry and thermometry.

Germanium was chosen over the conventional sintered-iron-oxide powders for two reasons:

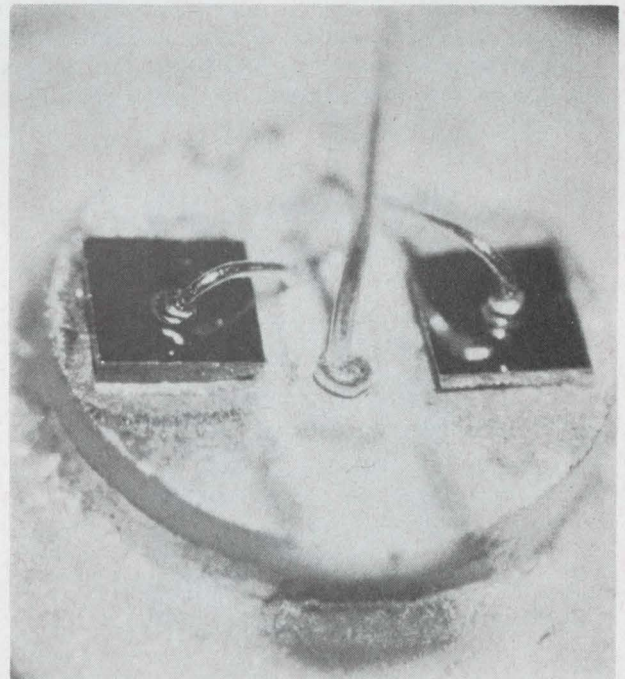

Power boosts. Two varactor diode pellets are bonded to the berylia substrate and placed in a stud casing. Although electrically connected in series, the varactors are thermally connected in parallel. Combination boosts device's power-handling capability.

State of the art in the States

Although Japan's solid state technology has been given a big boost by advances in radio-frequency transistors, varactors, and thermistors, it still lags behind that of the U.S. Recent Japanese developments can help narrow the gap and, in some cases, even close it, but by and large they reflect potential, not off-the-shelf, semiconductor products.

How present American technology fares:

Transistors. Typical characteristics of radio-frequency interdigitated devices include outputs of 50 watts at 500 megahertz and 5 watts at 1 gigahertz, collector currents of 4 amperes, output capacitances of from 10 to 20 picofarads, and efficiencies of 40%. Typical characteristics of overlay devices: 75 watts at 30 Mhz and 1 watt at 3 Chz. Interdigitated small-signal oscillators provide an output of more than 50 milliwatts at 4 Ghz,

and 1-to-4-Ghz amplifiers have noise figures of from 5 to 7 decibels; comparable overlay oscillators produce 250 mw at 3 Ghz.

Varactors. Typical characteristics of hyperabrupt diodes include nominal capacitances of 40-700 pf (at 2-volt bias) and Q's of 200 (at 1 Mhz). Typical parameters of gallium-arsenide varactors include series resistances of about 5 ohms, cutoff frequencies of a few hundred gigahertz, package capacitances of 0.2 pf, internal inductances of 0.4 nanohenry, and Q's in excess of 100. In general, however, U.S. semiconductor firms differ in their definitions of hyperabrupt junction varactors. Motorola Inc.'s Semiconductor Products division calls it a retrograded junction device, and feels that it isn't compatible with standard microwave devices. Texas Instruments Incorporated considers the Schottky-barrier diode a hyperabrupt junction type, and says

it has proven to be suitable for use in hybrid microwave integrated circuits.

Thermistors. A wide variety of these devices are available, enabling users to select temperature-sensing elements with almost any resistance rating and temperature coefficient. Silicon is generally preferred as the thermistor material because of its linear temperature coefficient and stability. Also, with silicon thermistors, the circuit itself—not a separate supply—furnishes the heat. Iron-oxide types, on the other hand, have been found to have less stable characteristics, a hysteresis effect, a higher ohmic value, and a potential for reversing the temperature coefficient's polarity. The state of the art has undergone little change in recent years. The last major innovation was the introduction of a hermetically sealed package—but that dates back a few years.

familiarity with germanium, stemming from transistor manufacture, and the material's intrinsic higher purity that is easily controlled.

In the indirectly heated type, two metal strips, evaporated onto the germanium, serve as the thermistor terminals. A silicon monoxide coating is applied for insulation and passivation; a nichrome element, evaporated onto the SiO layer, functions as the heater. Two metallization strips of a chromium-

gold alloy are formed onto the nichrome for ohmic contacts. A second SiO layer is deposited for additional passivation.

For heater currents between 6 and 28 milliamps the logarithmic plot of resistance change is nearly linear, decreasing from 600 ohms (at 6 ma) down to 7 ohms. Nominal resistance is 250 ohms, and the thermal time constant is 2 seconds—a far cry from the 35 seconds required for conventional thermistors.

For the thin-film thermistor, germanium is evaporated onto a glass substrate. The temperature of the substrate during the evaporation process establishes the temperature coefficient. By merely changing the evaporation temperature, a series of film thermistors—each having specific temperature behavior—can easily be made.

When low-resistivity films were evaporated onto a substrate whose temperature was maintained at 400°C, the germanium showed little resistance variation with thermal change. Thus, germanium is used as both the heating and thermistor element in the composite thin-film device.

In a typical device, a change in heater current from an initial value of 5 ma to a final value of 30 ma produced a corresponding resistance change from 14 kilohms to 150 ohms (in linear fashion on a logarithmic scale).

Fujitsu engineers contend that the thin-film approach is superior to the bulk effect for obtaining large resistance change with temperature, and the bulk method is preferable where greater stability is desired.

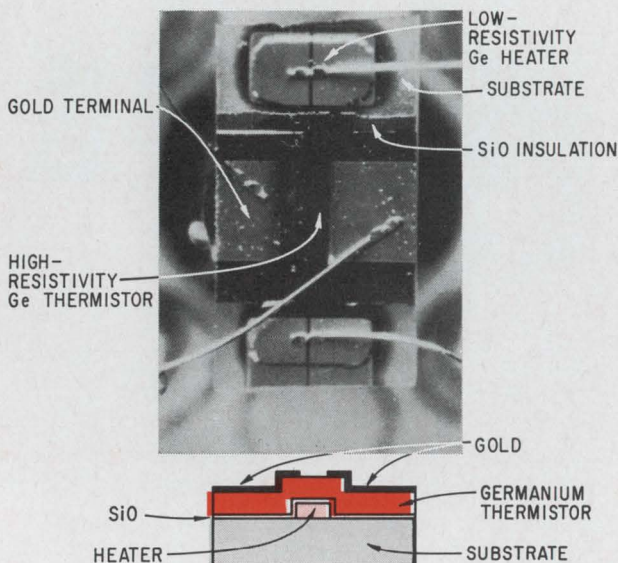

Dual role. Thin-film thermistor structure uses germanium for both heating and temperature-sensing.



The Milgray Air Force

**We use it to rescue embattled
Purchasing Departments.**

Our redoubtable men in blue (and grey, and green, and maroon, etc.) keep the peace. It usually starts with a frantic phone call from the front. Any front. Within 45 minutes the part is on its way to the flight line. The sortie could be to any landing field in the U.S., many overseas and, in a real pinch, a make-do helicopter landing pad. Just as often, we jet crucially needed parts among our branches (New York, Cleveland,

Washington, Philadelphia, Boston) and make the final sprint to your position with mobile ground forces under our command (which includes your local Milgray man's automobile).

So, no matter where in the country you're threatened, Milgray Red Tag service means that within hours we'll deliver virtually any reinforcements you need.

Except coffee, tea or milk.

m
MILGRAY

Milgray/New England 617-272-6800
Milgray/New York 212-YU 9-1600
Milgray/Delaware Valley 215-BA 8-2000
Milgray/Washington 301-864-6330
Milgray/Cleveland 216-881-8800
Milgray/International 212-YU 9-1600

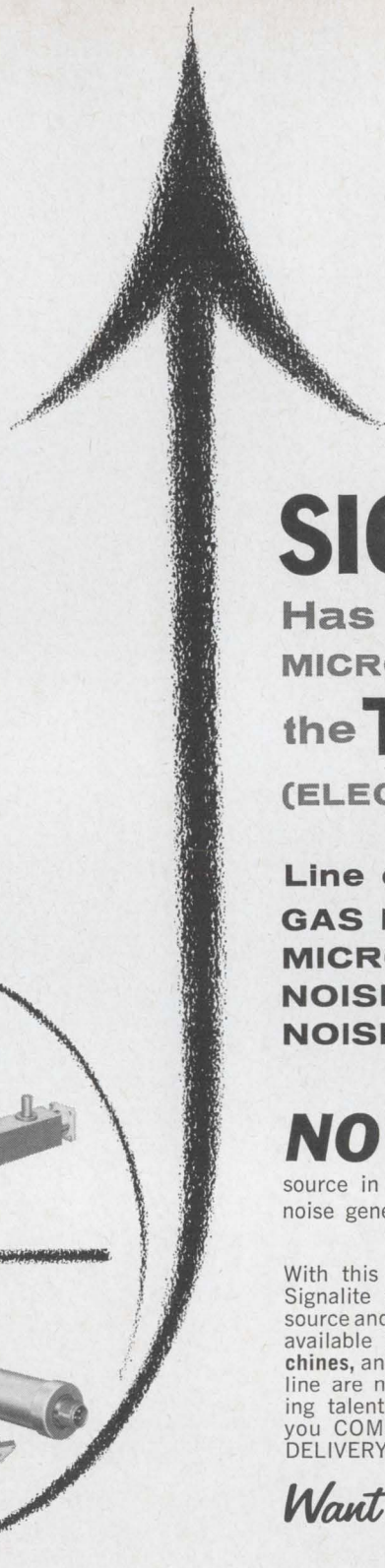

SIGNALITE

Has Acquired From
MICROWAVE ASSOC.

the **TUCOR**

(ELECTRONIC
SPECIALTY CO.)

Line of
**GAS DISCHARGE
MICROWAVE
NOISE SOURCES AND
NOISE GENERATORS**

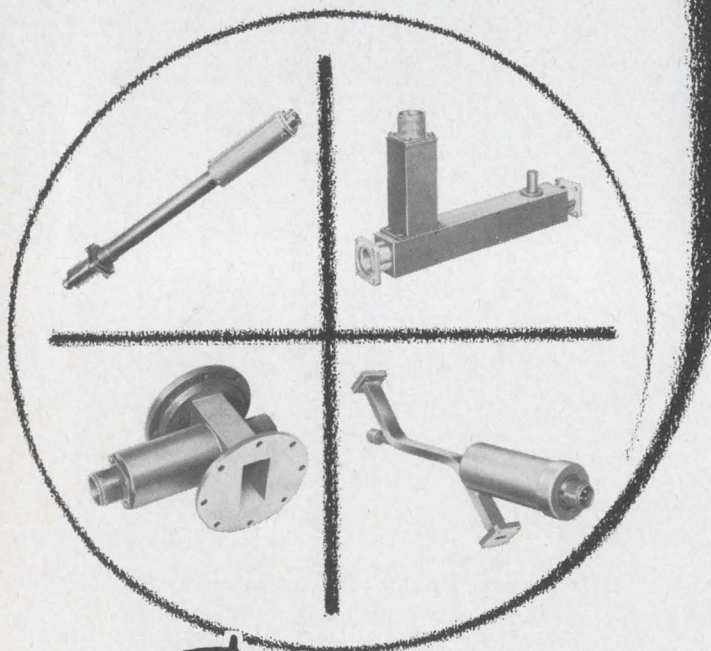

NOW . . . Signalite is the largest source in the world for your noise source and noise generator requirements.

With this addition of the TUCOR (ESCO) line, Signalite now offers the largest range of noise source and noise generators (except for 10° E. plane) available from a single source. The **men, machines, and methods** which developed this quality line are now supported by unexcelled engineering talent and production capabilities assuring you **COMPETITIVE PRICES** and **FAVORABLE DELIVERY**.

Want to know more?

Contact: J. Moor,
Sales Manager,
(201) 775-2490
or

write for...



Signalite's Noise Source Brochure . . . which provides a complete dissertation on microwave noise sources and miniature generators available from S-band to K-band including fundamental noise measurement discussions, typical applications, and detailed characteristics.

Signalite

INCORPORATED



SUBSIDIARY OF
GENERAL INSTRUMENT
CORPORATION

1933 HECK AVENUE, NEPTUNE, NEW JERSEY 07753 • (201) 775-2490



Optoelectronics goes digital

Researchers are arranging injection lasers as high-speed logic gates and trying to build electroluminescent diodes into computer displays

By Jun-ichi Nishizawa

Tohoku University, Sendai, Japan

After a slow start, Japanese researchers are stepping up efforts in digital optoelectronics with an eye to two specific goals:

- High-speed logic via injection lasers
- Computer input and output equipment using electroluminescent diodes and phototransistors.

Farther off in the future, they see the possibility of replacing cathode ray tubes in television sets with computer-type displays, a step toward a completely solid state television system.

The major drive now is to increase the efficiency and reliability of both injection lasers and electroluminescent diodes and to develop more convenient operating parameters. The injection laser is projected as a nearly ideal optical logic element; it has a narrow beam of high-energy density, can be modulated at high frequencies for high-speed logic and has an easily controlled intensity. The electroluminescent diode is compatible with the computer's existing solid state circuitry, and the device's long life and high efficiency could make it an ideal light source for a large array.

Commercial devices are scarce so far, but early results have borne out the opinion that optoelectronics will have a large part to play in electronic systems of the future. The first commercial laser diodes were put on the market in the fall of 1966, and though most electronics companies now produce them in sample quantities, only one—the Mitsubishi Electric Corp.—markets them as a catalog item. Other firms offer electroluminescent diodes, but these are high-priced and still not widely available.

Laser logic

Probably the most dramatic project in this field is the employment of injection lasers as logic gates, with the laser's on-off states corresponding to binary 1 and 0. This work is being carried on at the Nippon Electric Co., the Research Institute of Electric

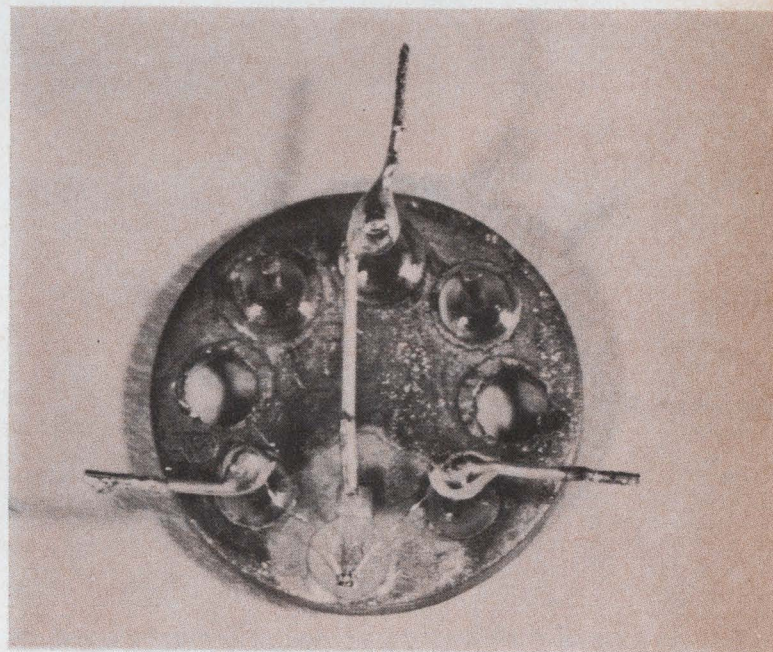

Sum and carry. Injection laser half-adder built by Nippon Electric has an enable input and two data inputs.

cal Communication of Tohoku University, and the Semiconductor Research Institute (sri) in Sendai. Results have been encouraging. Tests have shown that 50-gigahertz rates are possible with the small, high-speed switching elements. All basic logic gates, a half-adder, and a flip-flop have been built and operated experimentally.

With a two-input AND gate, the inputs are applied to two separate junctions located along the lasing direction of a single crystal. Lasing cannot occur if current is applied to only one input because the active diode region is too short compared with total length, and gain is too low. But when current is

Optical logic

By arranging laser junctions in series and in parallel, and by taking advantage of the fact that lasing along one axis can quench lasing along another axis, logic can be performed. Those sides of the devices where lasing is not desired are roughened, while the lasing ends of the crystal are cleaved to produce parallel planes. A detector would be used as an intermediate stage to sense the laser outputs.

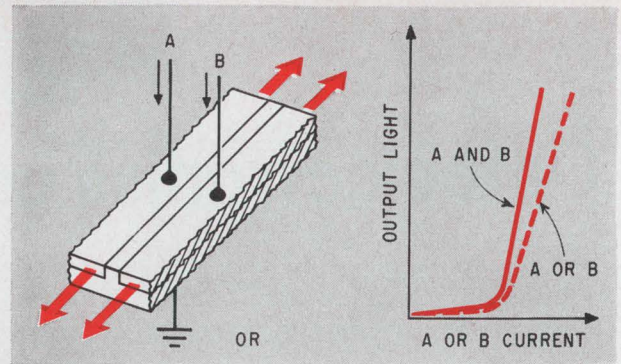

OR gate

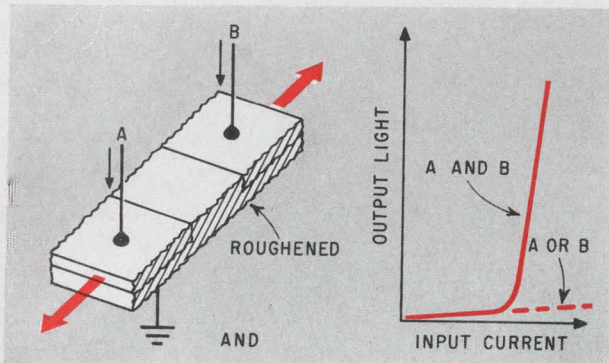

AND gate

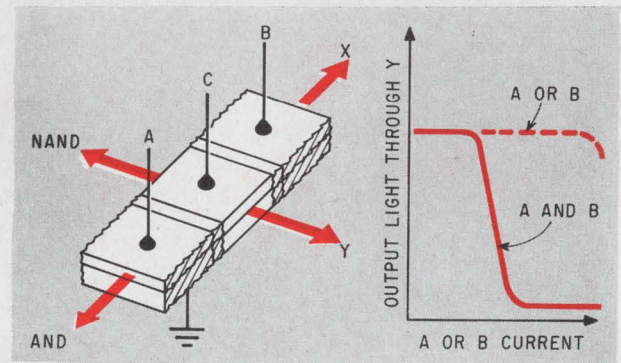

NAND/AND gate

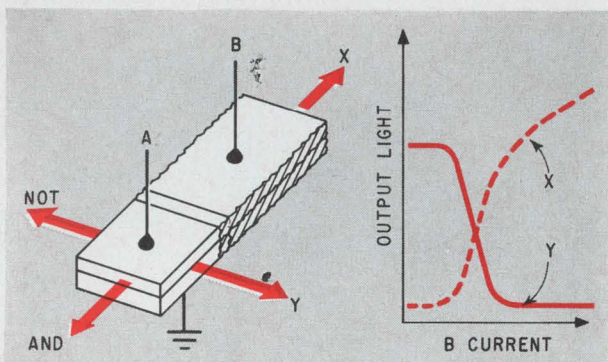

NOT/AND gate

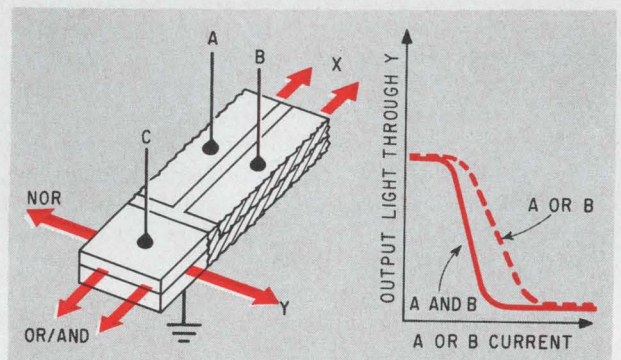

NOR/OR/AND gate

applied to both inputs, the gain increases and the element lases. The sides of the device are roughened to prevent lasing in a path perpendicular to the main direction.

The NOR gate is similar to the AND except that one diode has all edges cleaved to allow it to lase in either the short or long direction of the crystal. Lasing in the short direction occurs if current is applied only to this diode. Current to both diodes causes lasing in the long direction, lasing that takes most of the excited carriers and thus quenches the action of the first diode in the cross direction.

With a constant input current greater than the lasing threshold to the first diode, and with the detector along the short axis, the NOR gate gives a binary output of 1 when there is no input to the second diode, and an output of 0 when the input to the second diode exceeds the lasing threshold by a small amount. With a detector along the long axis, this

gate can be used for the AND function.

The OR gate consists of two diodes in parallel and extending the length of the crystal along the lasing direction. Lasing occurs if current is applied to either diode or to both simultaneously, and the faces perpendicular to the junction are roughened to prevent lasing in the short direction of the crystal.

Three-diode gates

Two diodes in parallel and arranged so they are both in series with a third, single, diode along the long axis of a single crystal form the NOR gate. The single diode can lase in either the long or short direction. If the input to either or both of the other diodes exceeds the lasing threshold in the long direction, lasing will start in the long direction and be quenched in the short. The device performs the NOR function with a detector along the short direction; with a detector along the long axis, it can be

used for the OR function.

The NAND gate is similar to the NOR except that the three diodes are in line along the long axis of the crystal. The center diode can lase in either direction, but usually receives current sufficient to maintain lasing in the short direction. Simultaneous inputs to both diodes are needed to block lasing along the short axis and induce it in the opposite direction. A detector along the short axis yields a NAND function, and along the long axis, the AND function.

The half adder, the most sophisticated of these devices, consists of a NOR gate along the sum axis and an AND gate along the carry axis. Developed by Nippon Electric, it has an enable input and two addition, or data, inputs.

Normally, a current is applied to the enable input to cause lasing in conjunction with one of the other inputs; in operation, the enable pulse is wider than the data input pulses. With a pulse at just one input, lasing occurs along the sum axis ($1+0=1$). If both data inputs are pulsed, lasing in the sum direction is quenched and lasing along the carry axis is initiated ($1+1=0+\text{carry } 1$) because the device is longer along the carry axis and gain is thus higher.

Researchers at Tohoku University and SRI have managed to get flip-flop action with a triode laser. This device has three junctions, one of which is in series with each of the other two and thus is common to two lasing axes. There is no lasing when the common junction area is pulsed, but a pulse to either of the other junctions causes lasing along the axis the pulsed junction shares with the common junction. A pulse applied to the junction along the other (perpendicular) axis quenches the lasing in first direction and starts it in the second.

To estimate the possible operational speed of laser logic, groups at Tohoku and SRI have measured the wavelength shift in light produced by a modulated laser. They amplitude-modulated the laser with a 50-gigahertz signal, and detected the optical sidebands at wavelengths corresponding to frequencies 50 Ghz above and below the laser frequency.

These experiments show the feasibility of modulating a laser diode at millimeter-wave frequencies. They also indicate that the maximum frequency of this modulation is greater than 50 Ghz, and that the operational velocity of laser logic should be faster than 10^{-11} seconds. (Operational logic speed is generally taken to be $1/\pi$ —or about $1/3$ —times the period of the highest frequency obtained from sine-wave frequency response measurements.)

In the computer

Optoelectronic devices have voltages and packages that match those of present computer circuitry. Electroluminescent diodes could be used simply as high-reliability light sources in punched-tape readers, or phototransistors, which have been commercially available in Japan for years, could be used as image sensors to read input data off a printed page. Nippon Electric researchers have produced a linear

array of 40 phototransistors to operate as an image sensor. Since the array is one-dimensional, scanning in a second direction involves moving the paper under the array.

The most pressing need here is development of improved scanning circuitry rather than any breakthrough in optoelectronics. A pulse input to the scanning circuit—essentially a shift register with outputs available at each stage—must propagate through the circuit, with the array tapping off the pulse at intervals. Neuristors—circuits that act like nerve fibers and propagate pulses without attenuation—also can be used for scanning.

Chain reaction

In a neuristor built at Nippon Electric, each stage is composed of a laser, a photodiode, and a photoconductor connected in series, plus a capacitor connected so it charges when the photoconductor turns

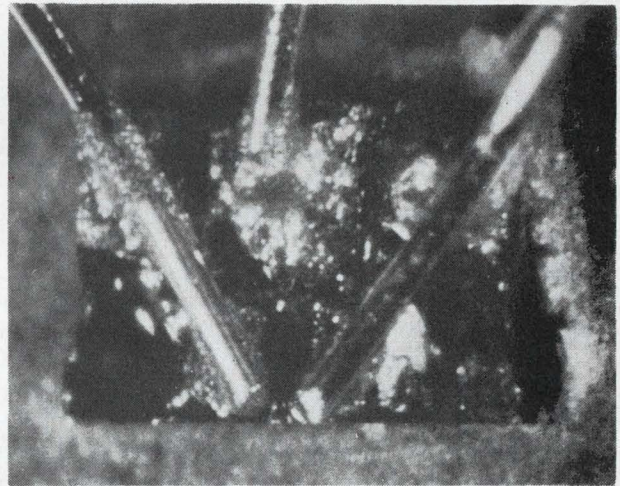

Contact closeup. Three contacts to half-adder, with enable input in the center.

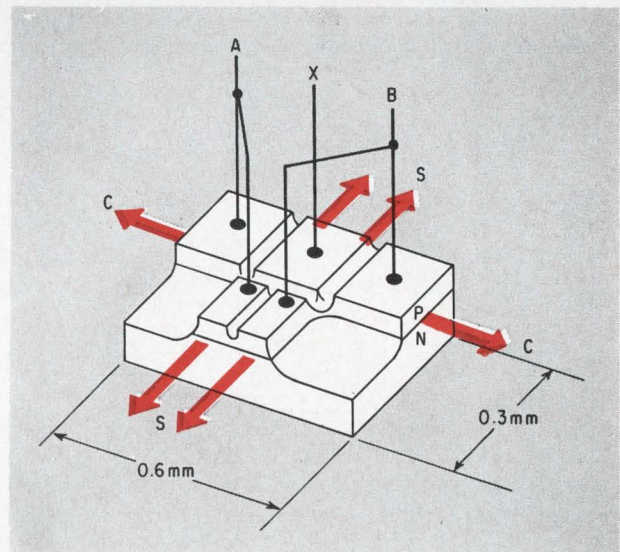

Half-adder. Enable input X is pulsed with a broad pulse, while data inputs A and B take narrow pulses. With only one data input, device lases along the sum (S) axis; two inputs cause lasing along carry (C) axis.

Commercial GaAs light emitters

Manufacturer Model	Peak power	Threshold current (amp)	Maximum peak current (amp)	Maximum pulse width/rep. rate	Operating Temperature (°K)	Package
Laser diodes:						
Mitsubishi	ML-31A	>5 w	0.1-1.0	25	200 nsec/1000 pps	77 TO-18
Electric Corp.	ML-31B	>1 w	5-20	50	200 nsec/1000 pps	300 Pill
	ML-66B	~0.1 w(d-c)	<0.3	1	d-c	77 Pill
Electroluminescent diodes:						
Hayakawa	GLE-702	100 μ w	—	0.1 (d-c)	5 μ sec/100 pps	123-343
Electric Co.	GLE-202	50 mw	—	10 (pulse)		
		8 μ w	—	0.1 (d-c)	5 μ sec/100 pps	123-343
		1.2 mw	—	2 (pulse)		
Mitsubishi	ME-01A	70 μ w	—	0.1 (d-c)	1 μ sec/10 ⁵ pps	253-333 Pill
Electric Corp.		(0.05 amp)	—	1 (pulse)		

on. To propagate a pulse through the circuit, light from one laser illuminates a photoconductor two stages further along in the direction of propagation, charging the photoconductor's capacitor.

Light from the same laser also turns on a photodiode in the intervening stage, transferring energy to the laser of that stage from its capacitor, which has been charged when a previous laser diode activated its photoconductor. Light from this laser diode in turn activates another photoconductor and photodiode, and the impulse is propagated.

A group at Tohoku University has made a neuristor circuit that simulates a traveling-wave tunnel diode as it scans an image converter and image display unit. Discrete tunnel diodes are triggered by transistors in sequence as the pulse moves through the circuit.

The image converter is an 8×8 array of phototransistors. In preliminary experiments, patterns

were formed by masking some of the phototransistors. After the array was scanned to detect the illuminated pattern, the outputs arrived at the display panel in time sequence to drive a similar 8×8 array of gallium arsenide-phosphide electroluminescent diodes. (These diodes, $\text{GaAs}_{0.62}\text{P}_{1.38}$, were used because they emit light in the visible portion of the spectrum, unlike pure GaAs, which emits light in the infrared.)

This unit's resolution is far from meeting the requirements of a television display, but the arrangement does demonstrate the feasibility of the principle. It could be used almost immediately in computers, however.

A light-coupled system using a laser and photodiode is also being investigated at Tohoku. Although power-handling capacity is small, this unit can be useful as a true isolator at microwave frequencies; In the isolator, whose gain-bandwidth product is 6.3 Ghz, a GaAs diode and a p-i-n photodiode are coupled by an optical glass fiber.

Light-beam tv

A research group at Shizuoka University, in experiments aimed at optical transmission of television video signals, has amplitude-modulated the output of a GaAs electroluminescent diode. The purpose was to develop a system for transmitting closed-circuit tv over short distances—for example, between buildings separated by a busy thoroughfare. One problem here was that the signal-to-noise ratio at receiving sites proved sensitive to noise from sunlight and other meteorological conditions, but better results have been achieved using the pulse code modulation of a GaAs laser diode.

The variation of a photodiode's capacitance with illumination has also been exploited at Shizuoka University. Illumination of a gallium-arsenide surface-barrier photodiode produces a voltage that decreases the barrier thickness and thus increases the

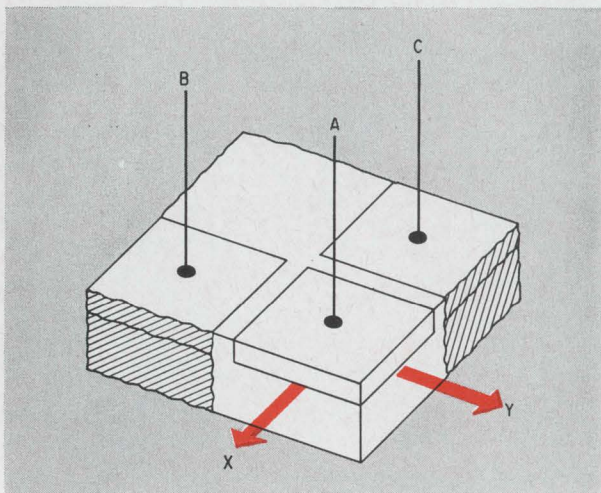

Flip-flop. Laser bistable flip-flop can lase in either direction. An input to A and B causes lasing along the Y axis and an input to A and C causes lasing along X.

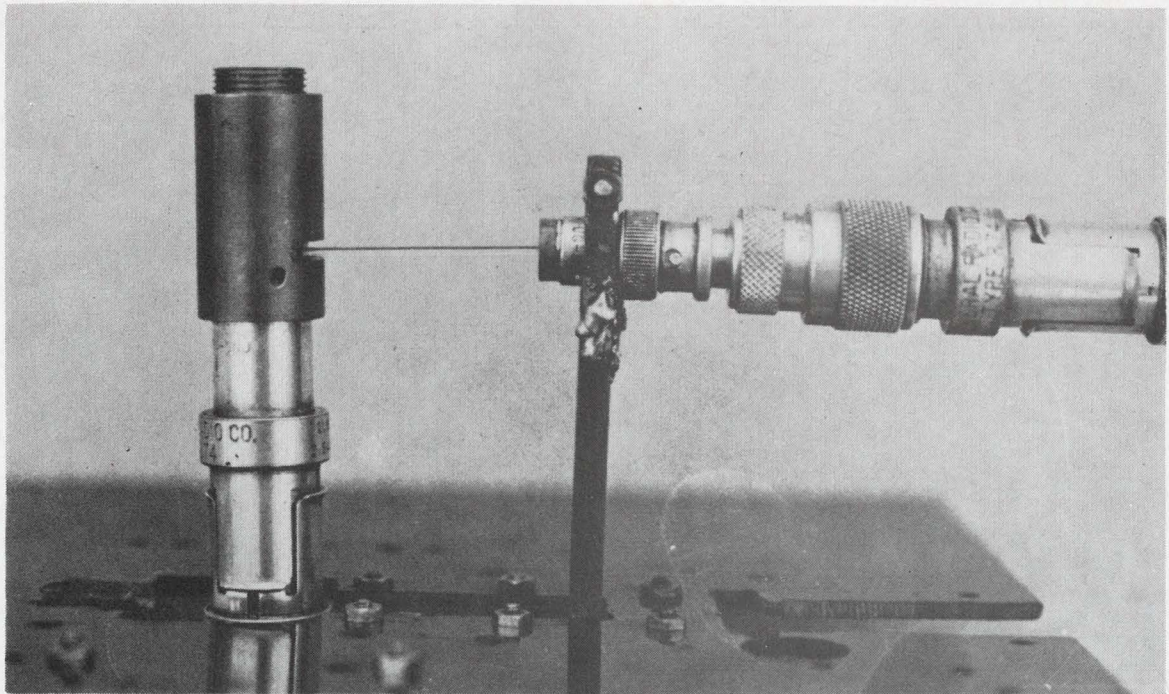

Microwave isolator. A glass fiber couples an electroluminescent diode and p-i-n photodiode. The microwave input signal modulates a light-emitting diode.

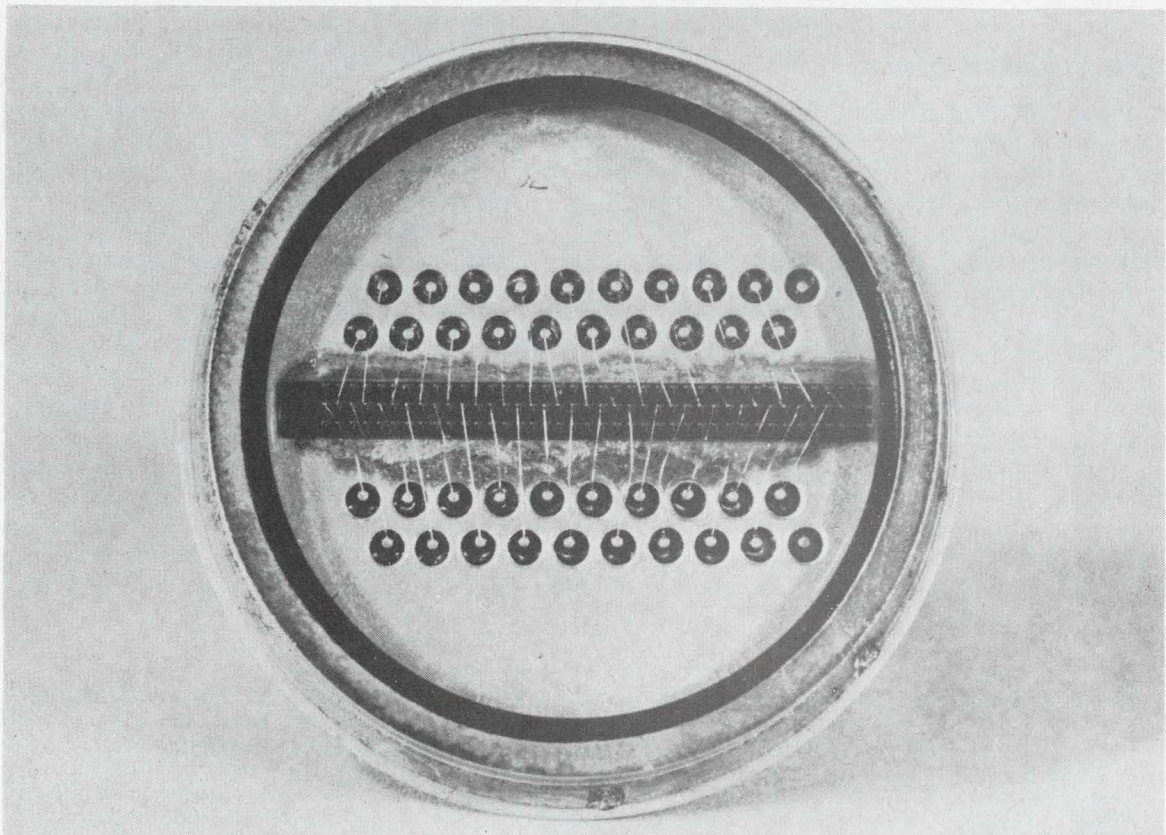

Number pick-up. Linear array of 40 phototransistors acts as a one-dimensional scanner for image sensor. To generate the second dimension, as shown by the number display, image is moved under the scanner.

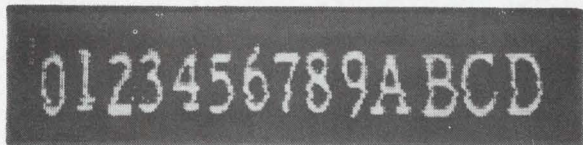

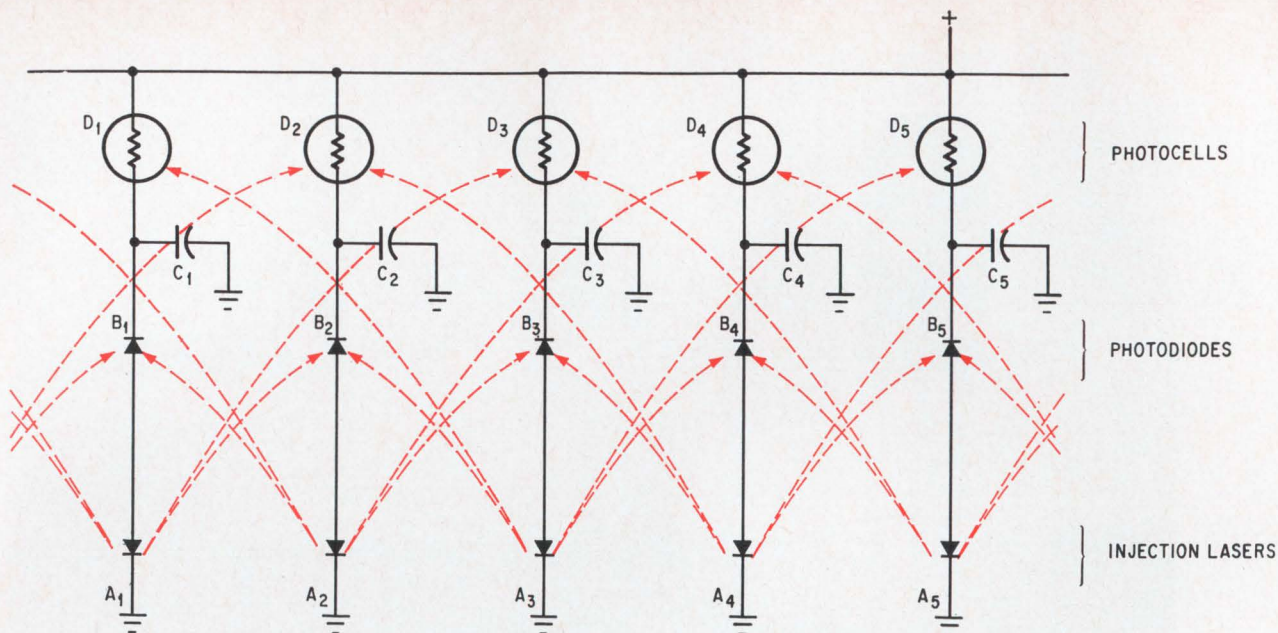

Neuristor. A pulse is propagated as an injection laser charges a capacitor two stages ahead and also turns on a photodiode one stage ahead. The photodiode releases the stored charge on its capacitor to turn on its injection laser.

barrier capacitance of the diode. In one application, the diode was used to frequency-modulate an oscillator tuned to 88 megahertz; capacitance-boosting illumination reduces the frequency of the oscillator.

Looking into the crystal

Studies of light-emitting diodes will help determine the fundamental properties of crystals from which they are made, and may enable Japanese firms to produce their own high-quality crystals; the present supply of good crystals from the U.S. is insufficient for either research or production.

Researchers at the Nippon Light Metal Co. and the Kokusai Electric Co. have succeeded in producing fairly good crystals, and material restrictions should disappear in the near future. Nippon Light Metal is an aluminum refiner that got into the gallium-arsenide business because gallium is one of the byproducts of aluminum production. Kokusai Electric is one of Japan's leading manufacturers of semiconductor production equipment.

Researchers at the Tokyo Institute of Technology have calculated that an injection laser's threshold

current can be cut by increasing the thickness of the active region where carriers are injected perpendicular to the junction surface. They obtained results for directional radiation characteristics, efficiency, and transient characteristics, and concluded that because of the delay in emitting light, maximum conversion efficiency occurs at a frequency corresponding to the reciprocal of lifetime. They now propose a method of determining lifetime by measuring the resonance.

A team at the Mitsubishi Electric Corp. has derived a new design equation showing that threshold current can be determined on the basis of the equilibrium of gain and loss. One of the conclusions of this group is that loss in small lasers is much greater than has been generally thought.

Groups at Tohoku University and SRI are also studying the directional radiation characteristics of the laser. They have analyzed laser operation in a one-dimensional mode, determining directional characteristics by a perturbation method, and these results have enabled them to gather information on directional light intensity as a function of current.

In the vanguard



Jun-ichi Nishizawa, whose photo appears on the cover, is a pioneer in laser technology. In a Japanese patent filed jointly with Yasushi Watanabe in April 1957, he proposed the basic idea for the injection laser. At that time, only microwave masers had been built, though studies had begun on optical masers, or lasers. Nishizawa and Watanabe postulated that the supply of high-energy electrons necessary for maser operation could just as well be provided by injection from outside the system as by boosting the energy levels of the electrons inside.

Nishizawa and his assistants tried to build an injection laser, but gave up after two years. But research work at the General Electric Co., the International Business Machines Corp., and Massachusetts Institute of Technology spurred the Japanese group to return to the project and to succeed. Nishizawa's team has since moved on to laser logic.

Nishizawa, a professor at Tohoku University, has been engaged since 1963 in studies at the solid state electronics division of the university's research institute. He received his doctorate in 1960.

It comes clean out of our test bath

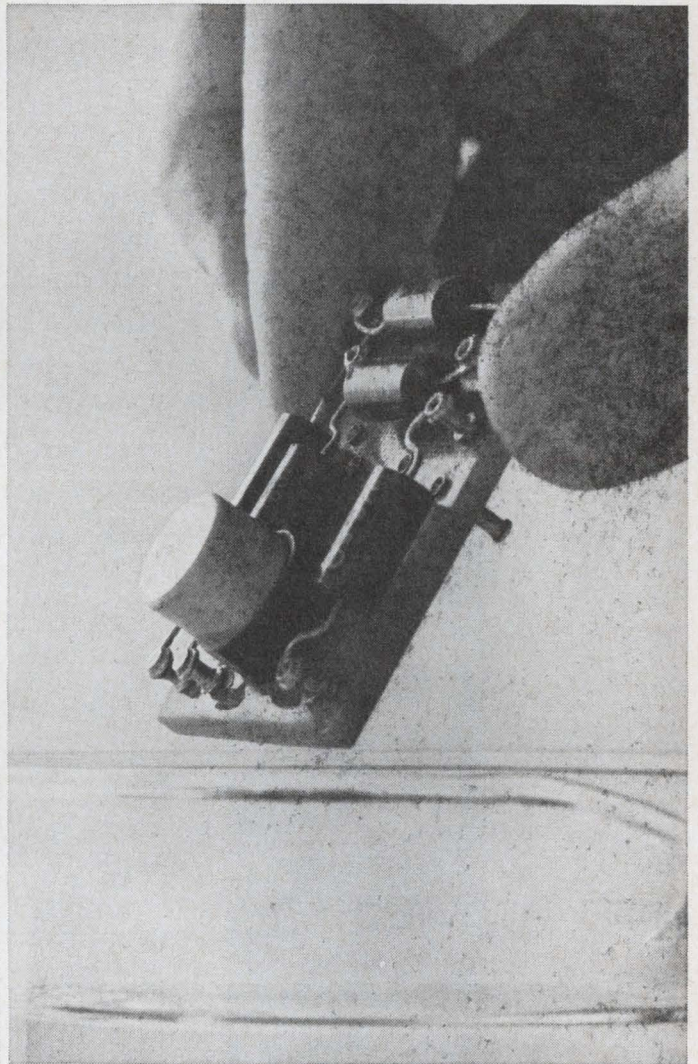
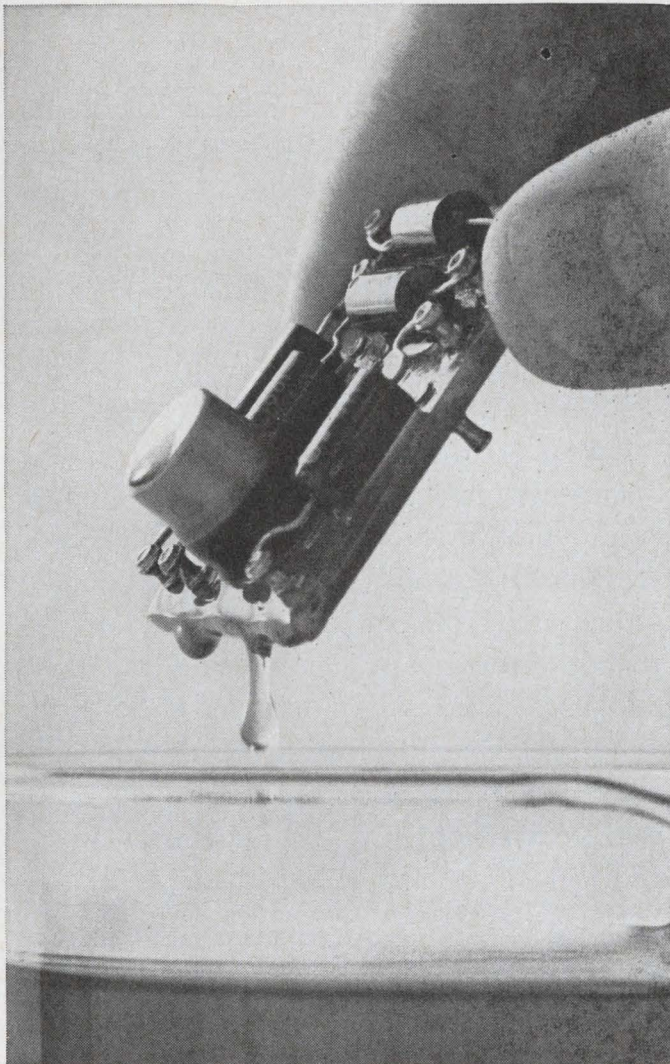

Temperature test your integrated or hybrid circuits in a 3M Brand Inert Fluorochemical Liquid and it'll drain clean, dry immediately and leave no residue.

Unlike conventional test bath fluids, with our Inert Liquids there's no costly cleaning stage to slow down production.

3M Brand Inert Liquids—FC-43, FC-75, FC-77, FC-78—also give you a wide liquid range so you can use them at both high and low temperatures, high dielectric strength for electrical insulation, compatibility to prevent adverse effects on sensitive materials, and non-flammability to make them safe.

With those properties and that kind of reliability—plus efficiency at removing heat—it's no wonder

our Inert Liquids work equally well as coolants. Test them for either application.

3M Chemical Division
Dept. KAX-127, St. Paul, Minn. 55101

Send me all the details about 3M Brand Inert Liquids.

Name _____

Company _____ Title _____

Address _____

City _____ State _____ Zip _____

Chemical Division **3M**
COMPANY

Your gain. One milliwatt to one kilowatt with a single TWT amplifier.

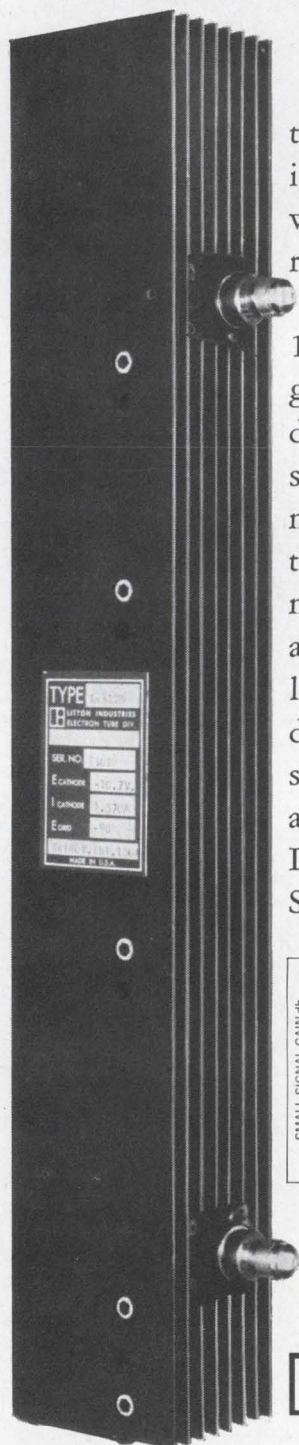

Length 15.69 inches.

Because of its high gain characteristics, Litton's new L-5126 traveling wave tube enables you to eliminate intermediate drivers in certain systems. Your additional gain? The reduction of the size, weight, cost and complexity of your system while improving reliability.

The L-5126 is a broadband traveling wave tube which provides 1.0 kilowatt minimum peak power output with 60 db minimum gain over the frequency range of 7.0 to 11.0 GHz. It may be driven to full power output by a standard signal generator, sweeper, or any conventional signal source. The L-5126 has a metal-ceramic vacuum envelope for reliable performance under the environmental extremes of MIL-E-5400, Class 2 environments, making it ideal for airborne and other similarly demanding applications. It is conduction cooled up to 1% duty and utilizes low cost Alnico periodic permanent magnet focusing. Its unique design and internal construction result in open and short-circuit stability. Tubes with comparable performance are also available at C-band. For additional information on the L-5126 and other Litton TWT's, write Electron Tube Division, 960 Industrial Road, San Carlos, California 94070 or call (415) 591-8411.

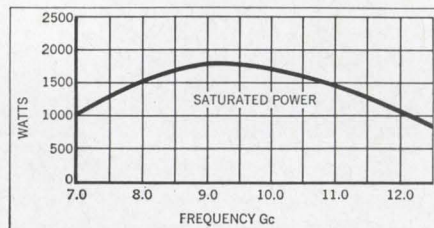
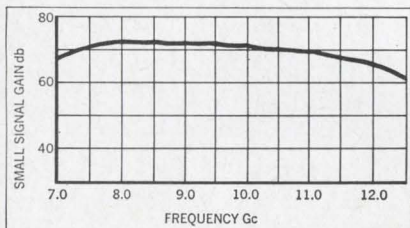

 **LITTON INDUSTRIES**
ELECTRON TUBE DIVISION



Gunn devices are on target —but short of a bull's-eye

Low output power remains the major difficulty in developing continuous-wave, bulk-effect oscillators for communications

By Takanori Okoshi

University of Tokyo

Triggered by the need for solid state communications devices, Japanese development of Gunn-effect oscillators since 1964 has stressed the continuous-wave mode. Progress thus far has given rise to hope that a commercial product may be near. One firm, the Nippon Electric Co., has reported a c-w output high of 340 milliwatts at 7.7 gigahertz.

At this point, however, outputs of Gunn devices satisfy only part of the microwave repeater needs of the government-owned Nippon Telegraph & Telephone Public Corp., which controls most of the nation's communications systems and operates the world's densest microwave network.

The repeaters used by NTT are heterodyne for long-distance main routes and baseband for short-distance links. Gunn oscillators, at best, can only deliver sufficient power to satisfy the transmitter needs of the lower-power baseband system and the local oscillator needs of the heterodyne system. Spectral purity and stability, however, come close to the mark.

Less heat, more power

Because power efficiency for a c-w Gunn oscillator falls between 1% and 8%, below the theoretical 15%, boosting the output necessitates raising the input. But increasing the input requires controlling the temperature rise that accompanies it.

The author



Takanori Okoshi is an associate professor of electronic engineering at the University of Tokyo, where he received his doctorate in 1960. His present research efforts are aimed at developing semiconductor microwave devices and depressed collectors for traveling-wave tubes.

Thus, although solid state devices are small enough to lend themselves to multiple, parallel-connected units in a single package, heat dissipation in the individual devices can be troublesome.

Although a c-w output of 1 watt has yet to be achieved, several watts could be obtained in the 5- to 10-GHz range if adequate heat sinks could be provided around the gallium-arsenide wafer, whether it is boat-grown or epitaxial material. Because of the danger of thermal runaway caused by ionization of deep donors, it has been believed that boat-grown GaAs could only be operated with a 30°C temperature rise. However, Riro Nii of NTT's Electrical Communication Laboratory recently reported that the temperature coefficient of resistivity becomes positive above 100°C. This means stable operation of boat-grown wafers is possible up to nearly 150°C, the maximum usually set for epitaxial gallium-arsenide Gunn devices.

Thus, thermal design of the Gunn package has an important role in obtaining the maximum power from a device. In the package, the Gunn active layer is a pellet sandwiched between two contacts, which also act as thermal contact to the heat sinks, usually copper studs. To calculate the maximum temperature rise, which determines the maximum input, there are three regions that must be considered: the active Gunn area, the heavily doped area on each side of it, and the metal contacts and heat sinks.

When the active region is thin enough, the others are dominant in calculating the thermal resistance of the device. At frequencies above 5 GHz, the active region is less than 20 microns thick. For example, a device with typical dimensions—100 microns radius and 10 microns thick—has a thermal resistance of about 1°C/watt. The total thermal resistance of the other two regions, on the other hand, is closer to 6.25°C/watt. Thus,

Power: the highs are still low

The highest power yet reported for a Gunn oscillator operating in a continuous-wave mode was obtained with epitaxial samples by the Nippon Electric Co.—340 milliwatts at 7.7 gigahertz with 5.5% efficiency. In the millimeter range, the highest power attained is 13.5 mw at 47 GHz with 0.82% efficiency.

Nippon Electric's epitaxial samples have an n^+n-n^{++} structure. The active layer has a carrier mobility of 4,000 to 7,000 $\text{cm}^2/\text{volt-sec}$ and a resistivity of 0.5 to 1.0 ohm-cm. It is epitaxially grown on an n^+ substrate doped with silicon or tellurium at 2×10^{18} carriers/ cm^3 .

The n^{++} layer, with 10^{19} carriers/ cm^3 is formed with the tin-liquid regrowth technique. A copper stud is provided on the n^{++} end of the sample to act as a heat sink. On some samples, heat sinks are also provided on the n^+ side. But since the n^+ layer can be as thick as 35 to 55 microns, the importance of its heat sinks is minimized.

At frequencies below 4 GHz, boat-grown samples predominate. In S band, the highest power obtained thus far is 280 mw at 2.5 GHz, at the Mitsubishi Electric Corp. The material is oxygen-doped, boat-grown gallium arsenide. Purchased in the U.S., it has a room-temperature mobility of 5,800 to 6,100 $\text{cm}^2/\text{volt-sec}$. Ohmic

contacts are provided by alloying tin on both ends of the sample, and a resonant coaxial cavity is used.

In L band, the highest power is 55 mw at 1.6 GHz, obtained by the Tokyo Shibaura Electric Co. (Toshiba) with a high-resistivity (20 to 40 ohm-cm), boat-grown sample having evaporated tin contacts.

The tin regrowth method has

allowed 177 mw c-w output from a boat-grown pellet at 9 GHz and with 8% efficiency, which may be the highest efficiency yet attained for a c-w Gunn oscillator. During operation the highest temperature in the boat grown sample is estimated to exceed 100°C . Operation is stable and the temperature coefficient of resistivity is positive.

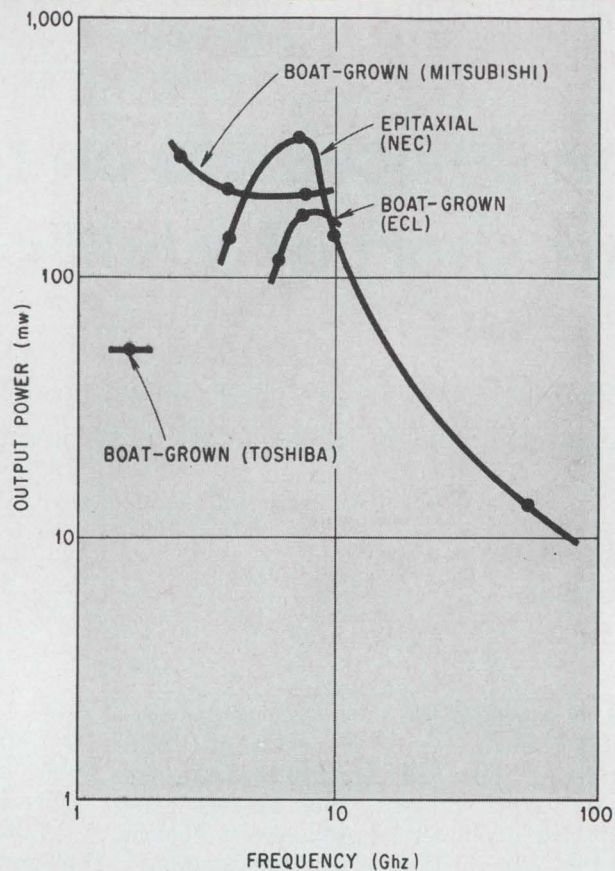

Typical experimental results

Sample no.	Mitsubishi Electric's boat-grown oscillators			Nippon Electric's epitaxial oscillators				
	1	2	3	1	2	3	4	5
Frequency for maximum power (GHz)	2.5	3.7	8.3	3.7	7.7	9.5	34	47
Maximum output power (mw)	280	212	215	160	340	145	28	13.5
D-c input (w)	7.5	6.7	3.8	5.9	6.2	5.8	1.9	1.55
Efficiency (%)	3.6	3.0	5.7	2.7	5.5	2.5	1.47	0.82
Active layer thickness (microns)	42	25	12	30	15	15	3	2
Threshold voltage (v)	10.8	8.1	5.7	7	4	4	2	1.5

the thermal resistance of the contact regions rather than the active region must be reduced.

With a total thermal resistance of $7.25^\circ/\text{watt}$, and with an allowable temperature rise of 150°C , the maximum allowable input power is about 20 watts. Based on an efficiency of 5%, the output power would be 1 watt. (However, even this thermal resistance is difficult to achieve, as evidenced by the 340-mw maximum power figure obtained at Nippon Electric.)

To achieve such thermal resistance, the heavily doped contact regions must be made as thin as possible. Usually, the substrate layer on an epitaxial sample has a thickness of at least 30 microns. Some form of etching is therefore necessary.

One such technique that controls thickness precisely was experimented with at NTR by Nii and others. An extension of the liquid regrowth technique originally developed by Herbert Nelson of RCA Laboratories for forming junctions in laser

diodes, the NTT technique can be used to form a thin GaAs oscillator from a thick boat-grown pellet. Or, it can be used to reduce the thickness of the substrate layer of an epitaxially grown sample. Nii uses tin both as an etchant and as a contact.

When the substrate is brought into contact with the molten tin, the GaAs starts to dissolve and is partially absorbed by the molten solution. When the melt is cooled, a deposit builds up on the resulting thinner substrate. This process is repeated—at increasing temperatures—until the substrate is at the desired thickness and has a heavy tin deposit, which is used as a contact.

Another approach that looks promising is the use of a special diamond type, called II-a, as the heat sink. This method was first used by C.B. Swan of Bell Telephone Laboratories. Compared with copper, this diamond conducts heat five times better at room temperature and 25 times better at liquid air temperature. Thus, with the same 100 microns radius and 10 microns thickness, total thermal resistance could be reduced to about 4°/watt, which means a 37.5-watt allowable input for the 150°C temperature rise.

Apart from thermal resistance, output is limited at higher frequencies by the Gunn diode's active length and the device's resistance. The relationship of the d-c input to the bias electric field, the sample resistance, and active length is expressed by:

$$P_{dc} = E_0^2 l^2 / R_0$$

Since the active region thickness is, in turn, inversely proportional to operating frequency, and E_0 is almost constant with frequency, if a minimum value is set for R_0 , the maximum d-c input is also proportional to f^{-2} , and drops at high frequencies.

Compounding this limitation is the oscillator's output impedance-load impedance mismatches—device d-c impedance is typically about 1-ohm.

Spectral purity

Although boosting output has proved troublesome, improving spectral purity has been relatively easy. Compared with reflex klystrons, frequency spectra measurements made last year indicated Gunn diodes were about 20 decibels poorer. Today, the difference is so slight that the diodes can be considered just about on a par with klystrons.

Spectral purity is characterized by the oscillator's carrier-to-noise ratio for the amplitude- and frequency-modulated noise sidebands, measured with a specific bandwidth (typically 1 hertz) as a function of frequency displacement from the carrier.

For example, in a standard Japanese frequency-division-multiplex (fdm) f-m microwave repeater, the required c/n ratio for the local oscillator is defined for a 1-hz bandwidth, single-sideband, approximately as: at 100 kilohertz away from the carrier, 110 db; at 1 megahertz away, 130 db; and, at 10 Mhz away, 160 db. The ratios already achieved with Gunn oscillators just about meet

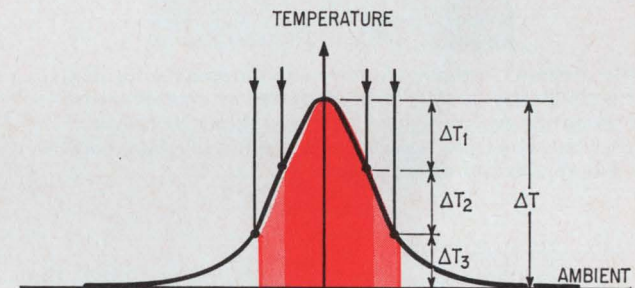
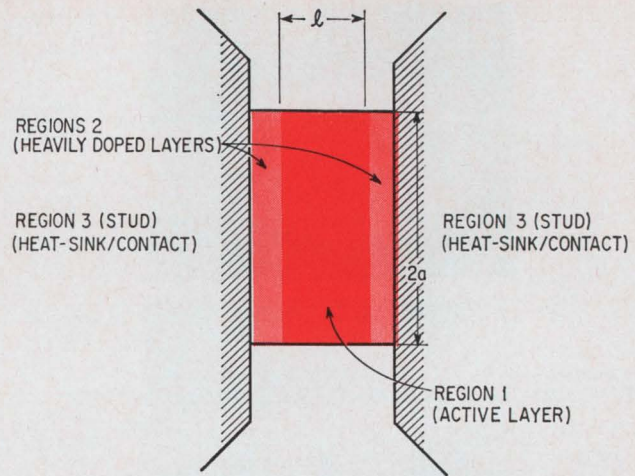

Thermal design. Heat must be dissipated to prevent temperature from reaching about 150°C. Gunn oscillator's active length is l , diameter is $2a$.

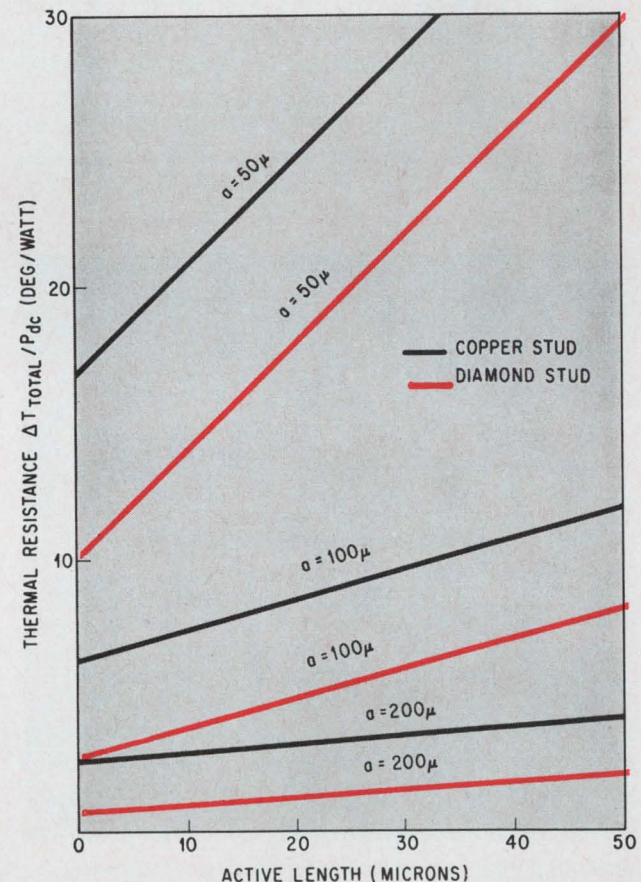

Heat sinks. Use of a diamond as a heat sink can cut thermal resistance by as much as 100%.

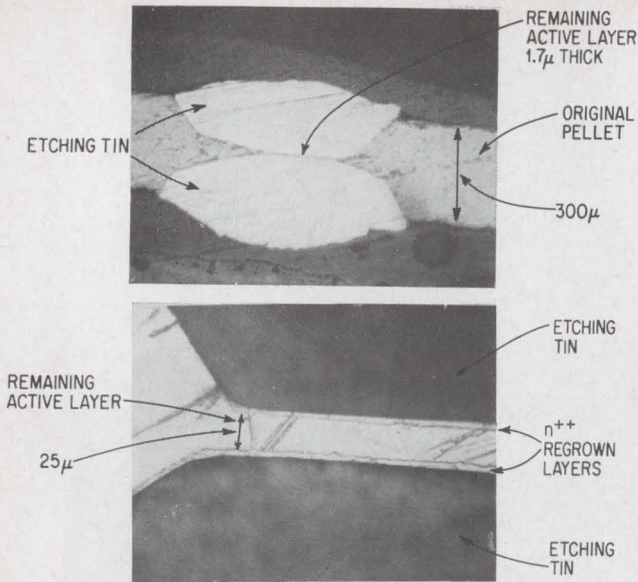

Tin etchant. In the liquid regrowth process for forming tin contacts to wafer, tin is also used as an etchant to reduce the active region thickness. Upper pellet was 300 microns thick. Lower pellet has heavily doped layers on both sides of active region.

these requirements.

Researchers at Nippon Electric have shown that the noise sideband is reduced when the oscillator's external Q is increased. But this means reducing the load, and, in turn, perhaps reducing the output to just a fraction of its potential if mismatching results. For example, consider an oscillator having a carrier frequency centered at 9.6 Ghz. With a 1-hz bandwidth and a Q of 90, the c/n ratio at 100 khz away from the carrier is 104 db. Increasing the Q to 1,100 raises the ratio to 118 db, making the Gunn oscillator comparable with both a reflex

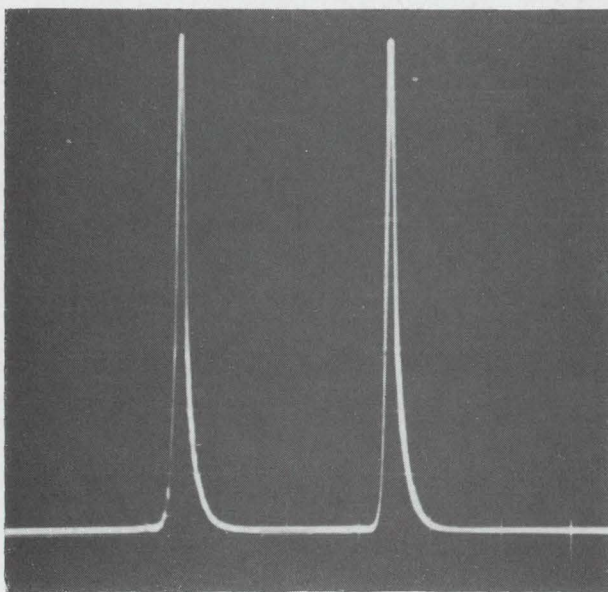

Spectral purity. Almost identical frequency spectra for Gunn oscillator, at left, and reflex klystron indicate that these types of devices are on a par. Center frequency for each device is 1,863.62 megahertz.

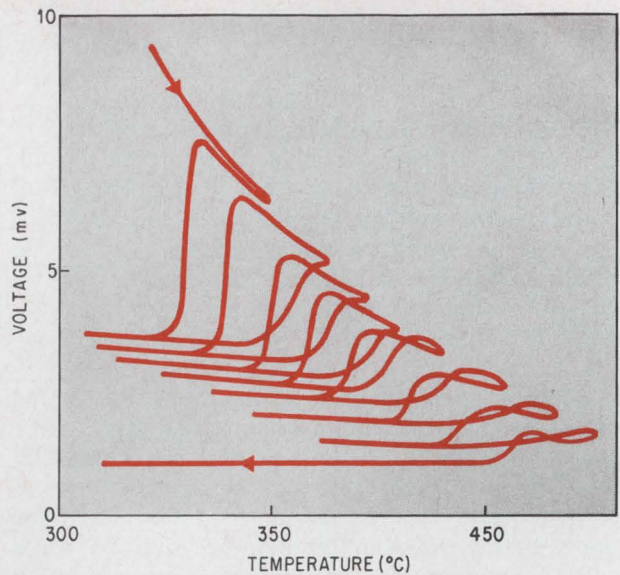

Reducing thickness. Temperature cycling in the liquid regrowth process reduces the active region thickness in steps. Voltage needed to maintain constant current through wafer is used as measure of thickness—decreasing voltage corresponds to decreasing thickness.

klystron and a good varactor chain at this frequency. In general, boosting a Q of 90 to 1,100 yields a 14-db c/n ratio improvement at any frequency.

Based on a simple model of noise generation in a Gunn oscillator, the c/n ratio for the f-m noise side band is theoretically

$$(c/n)_{fm} \propto f^2 Q_L$$

where f is the separation between the carrier and the sideband frequency, and Q_L is the loaded Q of the oscillator. Thus, the c/n ratio increases by about 20 db/decade as f increases. Results of

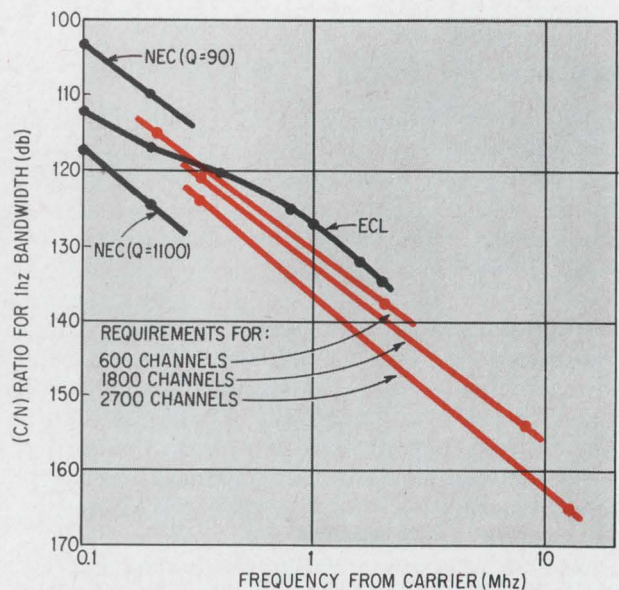

Filling needs. Gunn devices can meet requirements for carrier-to-noise ratios in several systems with different channel capacities. Measurements are by Nippon Electric and NTT's Electrical Communication Laboratory.

experiments for frequency separations greater than about 50 kHz bear out this simplified theory. For lower frequency separations, the noise increases more steeply than expected—about 25 db/decade. This may be due to the inherent noise of the semiconductor itself.

Although the oscillator's Q has the greatest known effect on spectral purity, it isn't the only factor that must be considered. The ratio of the operating frequency to the intrinsic frequency also affects spectral purity. Researchers at NTT have noted that at frequencies $\pm 10\%$ away from the intrinsic frequency, noise is sometimes 10-db greater and at much lower frequencies, it can be as much as 20 db.

However pure the signal is, it must also be stable. In repeater applications, long-term frequency stability is particularly important. Standard Japanese fdm-f-m repeaters require a frequency stability of about 10^{-5} for both the local oscillator and the transmitter. Although much better stability may be obtained with a Gunn oscillator for several minutes, about 10^{-6} , its characteristics are sensitive to temperature and tend to change with time. This problem may be solved with either a locking scheme or automatic frequency control. Experiments on locking a Gunn oscillator have thus far shown promising results.

Despite the stability problem, Hitachi Ltd. has experimented with an epitaxial Gunn device, biased just below the threshold voltage, as the oscillator transmitter in a 12-GHz, pulse-coded, amplitude-modulated system. A signal-channel television signal was converted by a tunnel-diode modulator into a delta-modulated signal that had a pulse-repetition rate of 100 megabits per second. The amplified signal was added to the bias voltage to trigger the oscillations. The results, which Hitachi deemed satisfactory, proved the feasibility of using Gunn oscillators in short-haul communications system.

Computers at work

In addition to practical development of the oscillator, theoretical analyses of the Gunn effect are being conducted at various laboratories. At the Tokyo Shibaura Electric Co. (Toshiba), Yoshihiko Sawayama has performed a dynamic computer analysis of the Gunn diode, including the effects of the external circuit.

At the University of Tokyo, a computer analysis of the steadily traveling dipole domain was performed and a group headed by Hisayoshi Yanai has proposed a simplified model to explain the load characteristics of a Gunn oscillator. Another group, headed by Sogo Okamura, has proposed a simplified large-signal model of harmonic-mode oscillations.

In Sawayama's analysis, the highest efficiency achieved was about 10%, obtained with a light load; the load resistance was about 10 ohms—10 times the low-field sample resistance. In one simulation, the highest efficiency was about 7.5%,

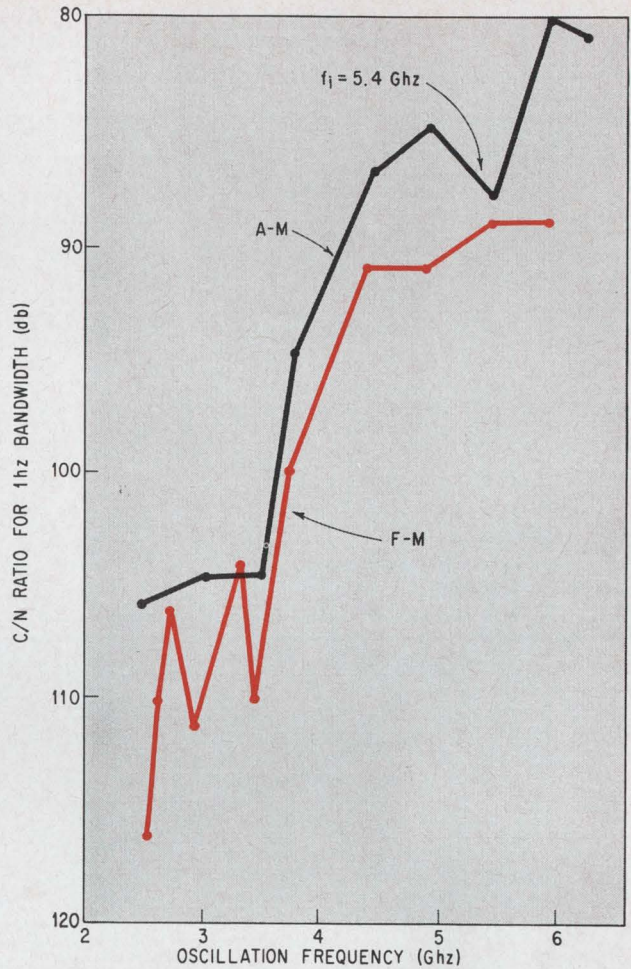

Noise sidebands. At frequencies below the intrinsic frequency, a-m and f-m noise is reduced. This effect has not been fully studied, either theoretically or experimentally.

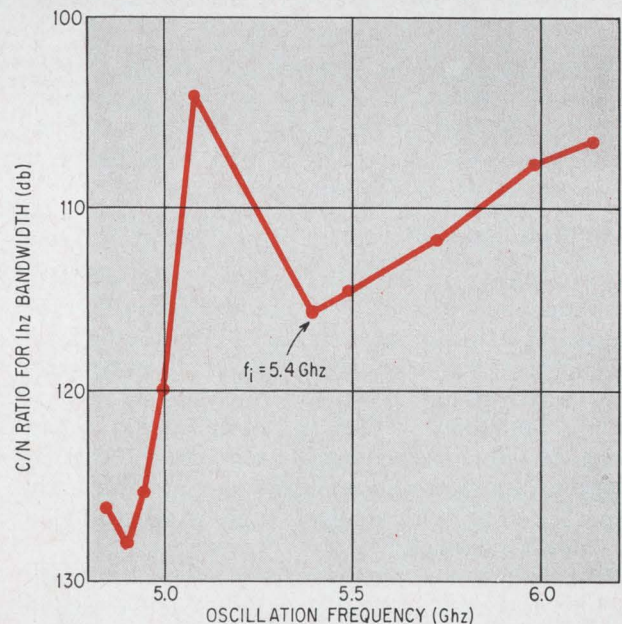

Intrinsic dip. Noise at the device's intrinsic frequency is decreased as much as 10 or 20 decibels, say researchers at NTT's Electrical Communication Laboratory.

Correlation. Theoretical efficiency curve and experimental power curve at right have same general shape.

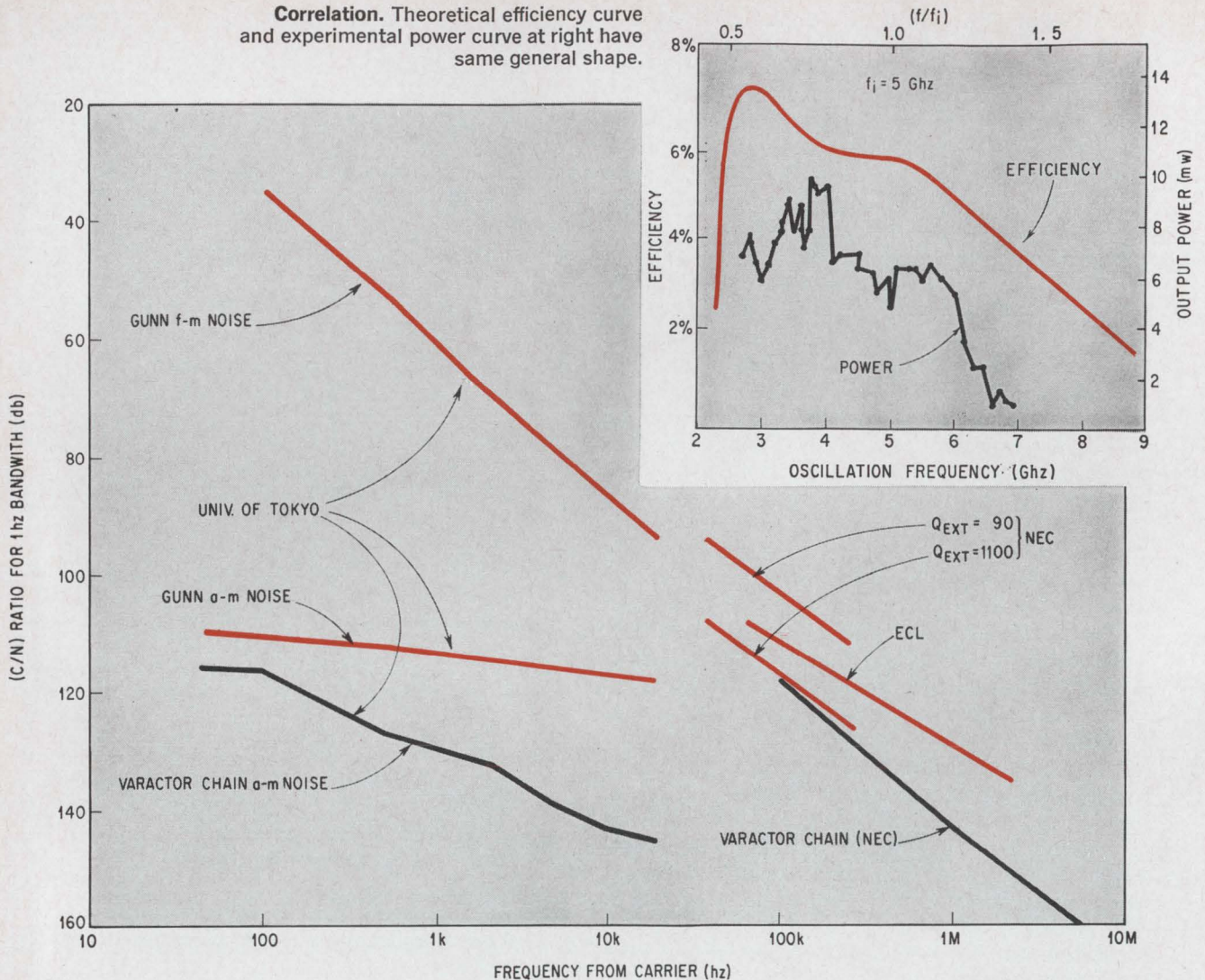

Comparisons. Nippon Electric Co. has shown that by increasing the external Q , spectral purity of Gunn oscillators can be comparable to that of varactor chains. This wasn't done in device measurements at the University of Tokyo and NTT's Electrical Communication Laboratory.

obtained at a frequency lower by a factor of 0.65 than the intrinsic frequency, 5 Ghz. Sawayama also has shown that the cavity resonator can continually change the oscillation frequency between 40% and 200% of the intrinsic frequency.

Amplifiers and logic

In addition to oscillators, bulk semiconductor amplifiers and logic devices are also being investigated. At NTT, Jiro Koyama and Masao Sumi have recently constructed a miniature meander-line-type, slow-wave circuit on the surface of an n-type indium-antimonide pellet, and obtained a coupling between the electromagnetic wave and the carrier. Koyama and Kurasaburo Kawazura are presently experimenting with another type of Gunn-mode unilateral amplifier.

Consisting of a high-resistivity (100 ohm-centimeter), n-type GaAs pellet with an active region length of 600 microns, the device has microstrip input and output leads alloyed onto the ohmic contacts on both ends of the pellet. At the cathode

end, the input triggers the formation of a high-field domain that builds up exponentially as it travels toward the anode. The experiments have been performed in a pulse mode; 5-db maximum gain has been obtained at a center frequency of 1.5 Ghz.

Because the amplifier is highly unilateral, gain is observed only in the direction of carrier flow. At input levels close to saturation, an appreciable portion of the output power is obtained at a frequency one-third the frequency of the input. This is probably due to the preceding high-field domain prohibiting domain formation at the cathode end, effectively limiting strong domain formation to only once every three cycles.

Studies of logic devices using the Gunn effect are still confidential. But most Japanese engineers believe such devices will have a strong impact on future computer technology. The characteristics of Gunn-effect devices having one or two control electrodes are being investigated at the University of Tokyo by a group headed by Hisayoshi Yanai.

**WORLD'S LARGEST SELLING
AND WORLD'S NEWEST**

Hand Size V-O-M's

TRIPLET

MODEL 310-C
World's Newest
Volt-Ohm-Milliammeter

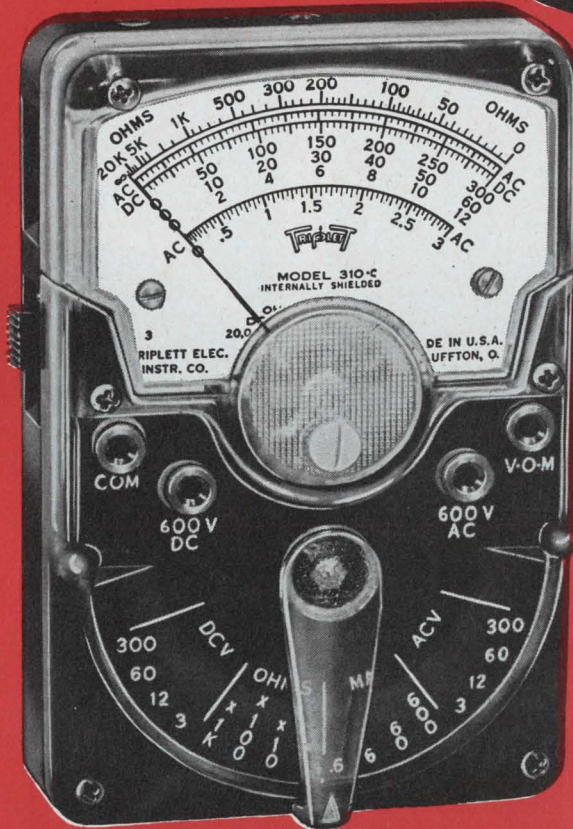
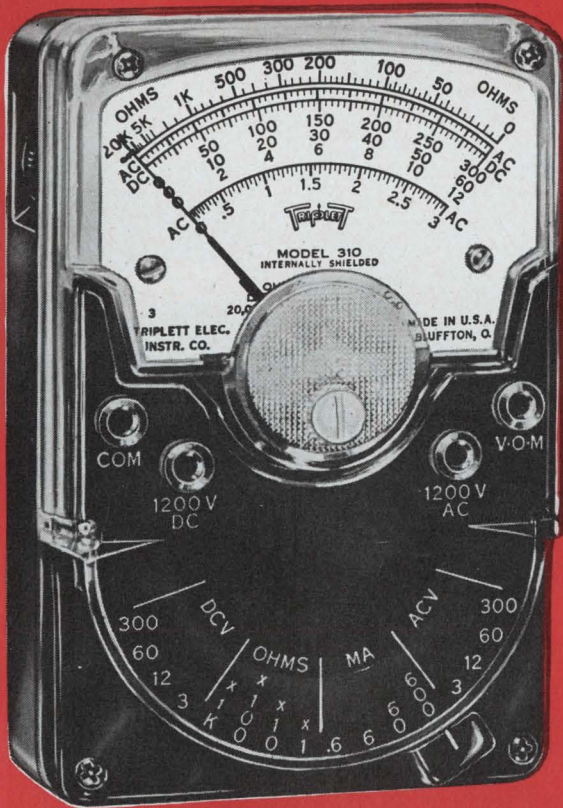

MODEL 310
World's Largest Selling
Volt-Ohm-Milliammeter

**BOTH TESTERS
SHOWN
ACTUAL SIZE**

- 1** HAND SIZE AND LIGHTWEIGHT, but with the features of full-size V-O-M's.
- 2** 20,000 OHMS PER VOLT DC; 5,000 AC (310)—15,000 AC (310-C).
- 3** EXCLUSIVE SINGLE SELECTOR SWITCH speeds circuit and range settings. The first miniature V-O-M's with this exclusive feature for quick, fool-proof selection of all ranges.

SELF-SHIELDED Bar-Ring instrument; permits checking in strong magnetic fields. FITTING INTERCHANGEABLE test prod tip into top of tester makes it the common probe, thereby freeing one hand. UNBREAKABLE plastic meter window. BANANA-TYPE JACKS—positive connection and long life.

Model 310—\$42.00 Model 310-C—\$53.00 Model 369 Leather Case—\$4.00

ALL PRICES ARE SUGGESTED U.S.A. USER NET, SUBJECT TO CHANGE

THE TRIPLET ELECTRICAL INSTRUMENT COMPANY, BLUFFTON, OHIO

310-C PLUS FEATURES

1. Fully enclosed lever range switch
2. 15,000 Ohms per volt AC (20,000 O/V DC same as 310)
3. Reversing switch for DC measurements

MODELS 100 AND 100-C

Comprehensive test sets. Model 100 includes: Model 310 V-O-M, Model 10 Clamp-on Ammeter Adapter; Model 101 Line Separator; Model 379 Leather Case; Model 311 leads. (\$78.00 Value Separate Unit Purchase Price.)

MODEL 100—U.S.A. User Net..\$74.00
MODEL 100 - C—
Same as above, but
with Model 310-C,
Net.....\$84.00



USES UNLIMITED: FIELD ENGINEERS • ELECTRICAL, RADIO, TV, AND APPLIANCE SERVICEMEN • ELECTRICAL CONTRACTORS • FACTORY MAINTENANCE MEN • ELECTRONIC TECHNICIANS • HOME OWNERS, HOBBYISTS
THE WORLD'S MOST COMPLETE LINE OF V-O-M's • AVAILABLE FROM YOUR TRIPLET DISTRIBUTOR'S STOCK

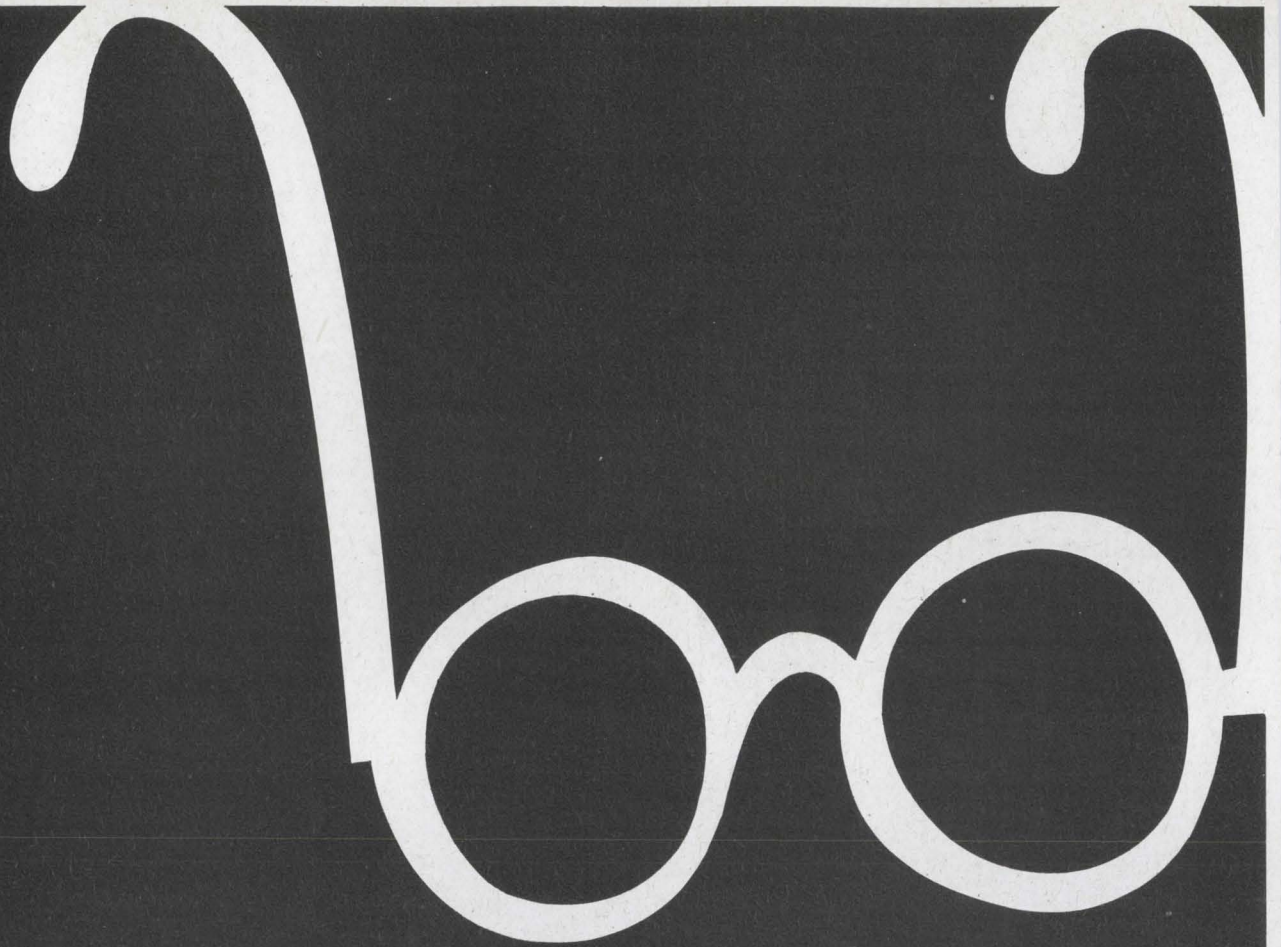

When you need
to see
where the eye
can't be
you need an

MTI Image Orthicon Television Camera.

What can closed circuit television do? It's what it can't do that's in a minority. The applications are endless, particularly for the specialists. Anyone can make a surveillance camera but not everyone can handle film processing, view laser beams, perform in helicopters for night time surveillance, monitor nocturnal animals, etc. because not

everyone makes low light level camera systems like MTI.

And speaking of systems, we design them not only to watch a process but to watch *and control* the process. So whatever your problem; a single camera off-the-shelf or a complete system to control a manufacturing process, call MTI.

mti MARYLAND TELECOMMUNICATIONS, INC.
York & Video Roads, Cockeysville, Maryland 301 - 666-2727
World's largest manufacturer of low light level television cameras.

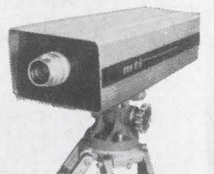



**From Westinghouse...
the only 0.5 mil
resolution CRT in a
“plug-in” package...
no design or
assembly headaches.**

It's simply not economical for you to design and assemble yokes, shields, and CRT's as well as Westinghouse does in its unique "plug-in" packages. For example, the assembly above. It's a fiber-optic CRT package with 0.5 mil resolution that meets mil-specs on shock and vibration. And it's ready to operate. You save many, many hours of engineering and technician time.

This is only one of many Westinghouse CRT packages. For details, write. We have over 400 vacuum electronics engineers who want to help you. Westinghouse Electronic Tube Division, Elmira, New York 14902.

You can be sure if it's Westinghouse





1 OZ.

2 PDT

2 AMPS

TIME DELAY 50ms to 100 sec

Crystal Can Configuration

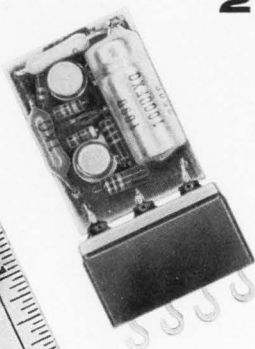

The HI-G Electronics Line Includes:

Fixed and Adjustable Time Delays — Up to 300 seconds delay. Contact ratings up to 10 amps. Special variations available to accomplish delay-on-break and interval timing.

Solid State Timing Modules — Solid state reliability offers flexibility in choice of secondary switching capability.

Voltage Sensors — DC and AC level sensing provides precise switching logic over the temperature range of -65 to 125°C. Interface with transducers to sense heat, light and pressure.

Phase Sequence Relays — To protect phase sensitive loads against phase reversal, open to grounded phase.

The new 2400 series Hi-G Time Delay Relays combines solid state timing circuits with dependable half-size electro-mechanical relays.

Results? Small size (.4" x .8" x 1.5"). Light weight (1 oz. typical). High current carrying capacity and the rugged performance of a Hi-G electro-mechanical relay. Long life and fast response of a hybrid circuit.

The Hi-G 2400 series operates in the range of 18 to 31 volts, needs no regulated input voltages and requires no external resistance or capacitance to obtain the maximum timing limit.

SPECIFICATIONS:

Delay Times: 50 milliseconds to 100 seconds on "make".

Delay Time Tolerance: $\pm 10\%$; (5% on special request).

Contact Rating: 2 amperes standard at 30 volts DC resistive.

Temperature Range: -55°C to +85°C. Specials to 125°C.

Vibration: 20G's, 10 to 2000 Hz.

Shock: 50G's, 11 \pm 1 milliseconds duration.

Call, write, or check the reader service number for more information. Ask for Product Bulletin 167A and a quotation. If you want application engineering assistance, an experienced Hi-G representative awaits your call.

Tel: 203-623-2481.

If you'd like an engineering scale with decimal equivalents, like the one above, just write HI-G. We will send you a handy pocket edition compliments of HI-G.



SPRING STREET & ROUTE 75 / WINDSOR LOCKS, CONNECTICUT 06096

NEW FROM MICRO SWITCH

solid-state-encoded keyboard assemblies

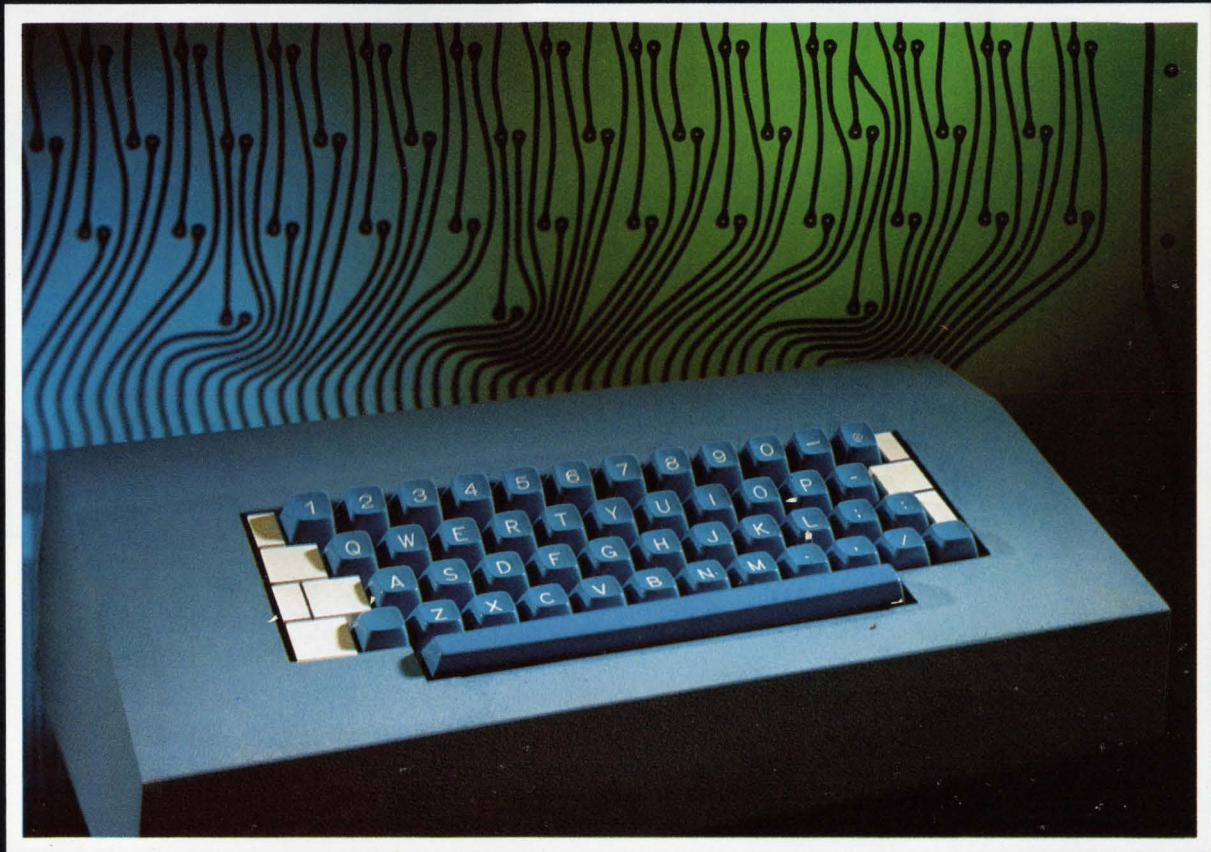

Complete keyboards—assembled, encoded, and ready to interface with your equipment.

These new keyboards feature reliability, flexibility and customized appearance that will give new sales appeal to your equipment. Exclusive new solid-state encoding and dry reed switch input assure your user the maximum in up time, and these features assure you the

minimum in maintenance.

You get a wide choice of custom-design opportunities to reduce your engineering and production costs. A unique new electronic interlock to increase operator speed and efficiency over existing approaches. An electronic strobe to delay the read cycle until the output is stabilized. Input flexibility to match your requirements.

MICRO SWITCH capabilities provide efficient factory assembly techniques to give you a customized keyboard at a price competitive with fixed format keyboards.

When you think of keyboards, think of MICRO SWITCH. Our Field Engineers can be a valuable asset to your design team. Call a Branch Office today. Or write for complete information.

MICRO SWITCH

FREEPORT, ILLINOIS 61032
A DIVISION OF HONEYWELL

Circle 135 on reader service card

Low-cost C106 SCR's?

Tell us how many you want



All voltages are now available in all quantities.



Actual size
GE C106
SCR

C106 RATINGS	
Type	PRV/PFB
C106Q	15 V
C106Y	30 V
C106F	50 V
C106A	100 V
C106B	200 V
C106C	300 V

Choose from any of six 2-amp RMS voltage ratings and many different lead configurations. GE C106's—the industry's first plastic encapsulated SCR's—are priced from 30¢ to 60¢ depending on voltage selection.

Peak current capability is now 25 amps, with 75-amp-capability devices soon to follow.

Sensitive, low-cost C106 SCR's have already brought new economies to a wide variety of applications including small and large appliance controls, gas ignition systems, motor controls, electronic switching, and temperature controls. See your local GE engineer/salesman or authorized semiconductor distributor for complete details. Or write to Section 220-62, General Electric Company, Schenectady, N.Y. In Canada: Canadian General Electric, 189 Dufferin St., Toronto, Ont. Export: Electronic Component Sales, IGE Export Division, 159 Madison Ave., New York, N.Y., U.S.A.

SEMICONDUCTOR PRODUCTS DEPARTMENT

GENERAL  ELECTRIC

Small wonder:



Our new "4th-generation" 12.5 MHz universal counter/timer. Wonderful versatility in a wonderfully small package — at an even more wonderfully small price.

With the new Model 100A you can measure average frequency, frequency ratio, single period or time interval, or count total events. It has a crystal-controlled clock, Monsanto integrated circuit construction, and built-in compatibility with a rapidly growing assemblage of accessory modules.

With its \$575* price tag (accessory modules are pegged at comparably modest rates) you can have big-league counter/timer performance at

costs never before possible. Small wonder we are selling (and delivering) Model 100A's just as fast as we can build them.

Call your local Monsanto field engineering representative for full technical details, or contact us directly at: Monsanto Electronics Technical Ctr., 620 Passaic Avenue, West Caldwell, New Jersey 07006. Phone (201) 228-3800; TWX 710-734-4334.

*U.S. Price, FOB West Caldwell, New Jersey.



ELECTRONICS

Circle 137 on reader service card

envelope delay

ENVELOPE DELAY IN CABLE OR RADIO TRANSMISSION SYSTEMS AND COMPONENTS CAN BE PRECISELY MEASURED WITH WANDEL AND GOLTERMANN INSTRUMENTS; THE WORLD'S MOST COMPLETE LINE OF DELAY AND PHASE DISTORTION MEASURING SYSTEMS.

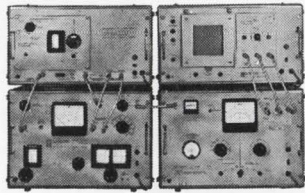

MODEL LD-1

MODEL LD-1 FOR WIDE BAND TRANSMISSION LINES AND TAPE SYSTEMS

The Model LD-1 Group Delay Measuring System measures delay and loss distortion of transmission systems having frequency dependent phase characteristics. Phase reference is automatically transmitted through circuits under test, allowing either loop or straight-away measurements.

Frequency Range	100 kHz to 14 MHz
Split Frequency	20 kHz
Measuring Ranges	
Delay Distortion (full scale)	± 15 ns to ± 15 μ s
Lowest Value Measurable	± 1 ns
Loss Distortion (full scale)	± 0.75 dB to ± 20 dB
Lowest Value Measurable	± 0.05 dB

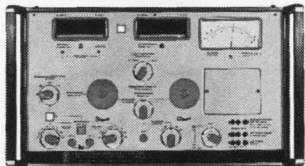

MODEL LD-2

MODEL LD-2 FOR LOW FREQUENCY DATA TRANSMISSION SYSTEMS AND COMPONENTS

Similar to LD-1 except designed to cover lower portion of frequency spectrum (200 Hz to 600 kHz). Particularly useful in fields of Data Transmission over telephone lines where shape of transmitted pulses may be distorted because of frequency response of the group delay. Modulation frequency (40 Hz) allows analysis of very narrow filters and telemetry systems components.

Frequency Range	200 Hz to 600 kHz
Split Frequency	40 Hz
Change Over Frequency	4 Hz
Sweep Frequency Ranges	± 200 Hz to ± 300 kHz
Group Delay Range	± 1 μ s to ± 10 ms + 12.5 ms
Loss Range	± 0.05 dB to ± 50 dB

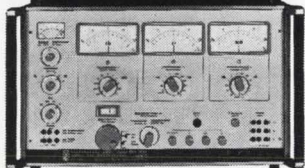

MODEL VZM-83

MODEL VZM-83 DISTORTION METER FOR EQUALIZATION OF RADIO TRANSMISSION SYSTEMS

Designed to measure slope (amplitude) and delay (phase) vs. instantaneous drive of 2 and 4 pole networks, such as radio links, tubes, transistors and wide-band amplifiers. Useful for loop or straight-away measurements and laboratory alignment of FM systems. Selectable test frequencies of 52, 304, 556 kHz. Delay resolution to 0.1 ns; slope distortion to 0.05%.

Test Frequencies-selectable	52, 304, 556 kHz
Sweep Frequency	81.06 Hz
Sweep Frequency voltage-full scale ranges	0.06, 0.2, 0.6, 2V
Delay Measurement-Lowest Change Measurable	0.1 ns
Slope Measurement Lowest Change Measurable	0.05%

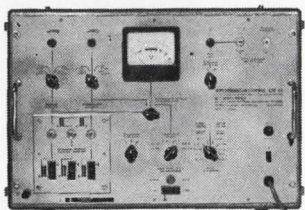

MODEL VZM-2

MODEL VZM-2 DISTORTION METER FOR HIGH CHANNEL DENSITY RADIO LINK SYSTEMS

Similar to VZM-83 except covers much wider range of frequencies. Fully transistorized. Measures phase delay and slope distortion on microwave systems designed to cover up to 2700 voice channels of modulation. Use of higher test frequencies detects faults not observed with lower frequencies, commonly available in other instruments. Selectable test frequencies up to 12MHz available. Useful in both open and closed loop measurements.

Standard Test Frequencies	0.556, 2.4, 3.58, (or 4.429), 5.5 & 8.0 MHz
Selectable (8 max.) (other frequencies available upon request)	
Sweep Frequency (deflection voltage)	sawtooth (1.6 kHz) & triangular (800 Hz)
Deflection Voltage, full scale	0.2, 0.6, 2, 6, 20, 60 volts
Measuring ranges, amplitude (f.s.)	1, 2, 5, 10, 20, 50%
Measuring Ranges, phase (f.s.) (1% = 0.57°)	1, 2, 5, 10, 20, 50%

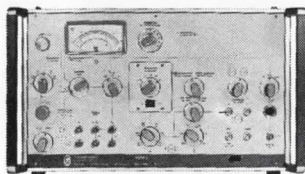

MODEL VZM-1

MODEL VZM-1 DISTORTION METER FOR PHASE AND AMPLITUDE DISTORTION IN COLOR TV TRANSMISSION

Designed to measure amplitude (luminance) dependent gain and phase characteristics of chrominance information in color TV pictures. Test voltage frequency fixed at 3.579545 MHz. Phase resolution 0.1 degree; amplitude resolution 0.5%.

Input voltage required	20-200 mv
Input resistance	75 Ω
Lowest phase change measurable	0.1 degree
Lowest amplitude change measurable	0.5%
Highest amplitude change measurable	50%

A technical paper covering the subject of "Group Delay Measurement" is available by writing to Tel-Com.

Wandel & Goltermann

West Germany

REPRESENTED IN U.S.A. BY

TEL-COM
INSTRUMENTS, INC.

6 Great Meadow Lane, Hanover, New Jersey 07936
Telephone: (201) 887-8700



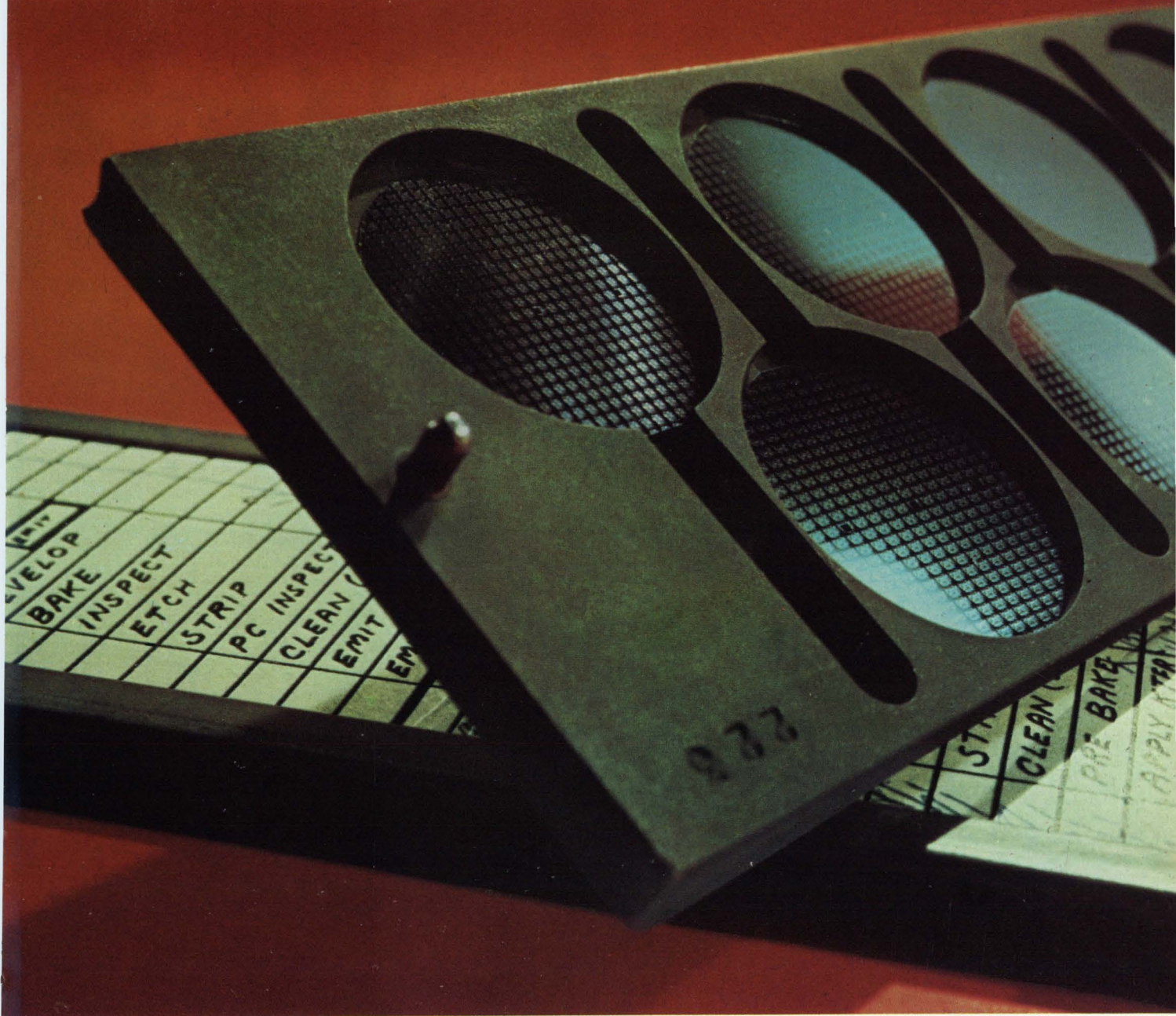

Even the biggest IC order you give us is made in small pedigreed batches.

Mistakes don't get far at Sylvania. By making ICs in small batches and logging their performance on charts that follow them through every step of production, we spot trends and make corrections early. You get reliable ICs, on time.

To assure reliability, vendors' materials must pass stringent tests. Parts made within Sylvania must pass the same tests.

For reliability, processing areas are designed to eliminate contamination. Ceilings, floors and

furnishings are impervious to dirt. Temperature, humidity and air are precisely-controlled.

We've virtually eliminated damage to chip substrates, metallizations and bond wires with mechanized handling equipment. And to make certain we achieve reliability, every IC must survive 100% testing in 12 steps during production. And 100% testing again at the very end.

Sylvania Semiconductor Division, Electronic Components Group, Woburn, Mass. 01801.

SYLVANIA
SUBSIDIARY OF
GENERAL TELEPHONE & ELECTRONICS **GTE**

Circle 139 on reader service card

3.0 watts @ 1 GHz

(35% efficiency, $f_T > 1$ GHz, $\theta < 10^\circ \text{C/watt}$)

How's that for power...

It's the **S 1000**, our newest amplifier transistor for stripline applications.
The following are other devices available from stock:

Application	Device	Frequency (MHz)	Power Out (watts)	Power Gain min. (db)	Efficiency min. (%)	f_T Typ. (MHz)	T _J (centigrade)	V _{cc}	Case
Large Sig Hi Power Oscillator Amplifier	V409	260	40.0	6.0	50	300	200	28	TO-60
Large Sig Med. Power Oscillator Amplifier	2N3866	400	1.0	10.0	45	800	200	28	TO-39
	S704	400	1.0	10.0	45	1,000	200	28	TO-39
VHF/UHF Oscillator Multiplier Amplifier	VX3375	400	4.0	6.0	50	650	200	28	VX*
	2N3375	400	3.0	4.8	40	600	200	28	TO-60
Large Sig Hi Power Oscillator Amplifier	2N3733	400	10.0	4.0	45	400	200	28	TO-60
	2N4440	400	5.0	4.7	45	600	200	28	TO-60
	2N5016	400	20.0	5.0	50	700	200	28	TO-60
	V410	400	25.0	5.5	50	700	200	28	TO-60
Large Sig VHF/UHF Oscillator Amplifier	VX3733	400	10.0	4.0	45	400	200	28	VX*
	VX3866	400	1.0	10.0	45	800	200	28	VX*

*stripline package

These RF power devices, as well as wafers and dice, channel- and lid-mounted units, high-speed NPN switches, small signal/high frequency amplifiers, differential amplifiers, and silicon dioxide capacitors are available from the newly formed Electronic Components division of United Aircraft Corporation. For more information, call (215) 355-5000, TWX 510-667-1717, or write Marketing Manager.

Electronic Components DIVISION OF **United Aircraft**

TREVOSE, PENNSYLVANIA 19047

IBM Systems Development turned to Airco for nitrogen &

...volume. At Essex Junction, Vermont, IBM uses ultra-pure Airco nitrogen for inert atmospheres, gas mixtures & purging in the manufacture of micro-circuitry. Which adds up to a lot of nitrogen. We monitor the liquid gas during production & tag each trailer

with the purity count. & that adds up to total dependability. Industrial gases delivered when, where & in the quantities needed: that's how we serve all our customers, far & wide, large & small. For information, write us at 150 East 42nd St., New York, N. Y. 10017.

AIRCO
Industrial Gases

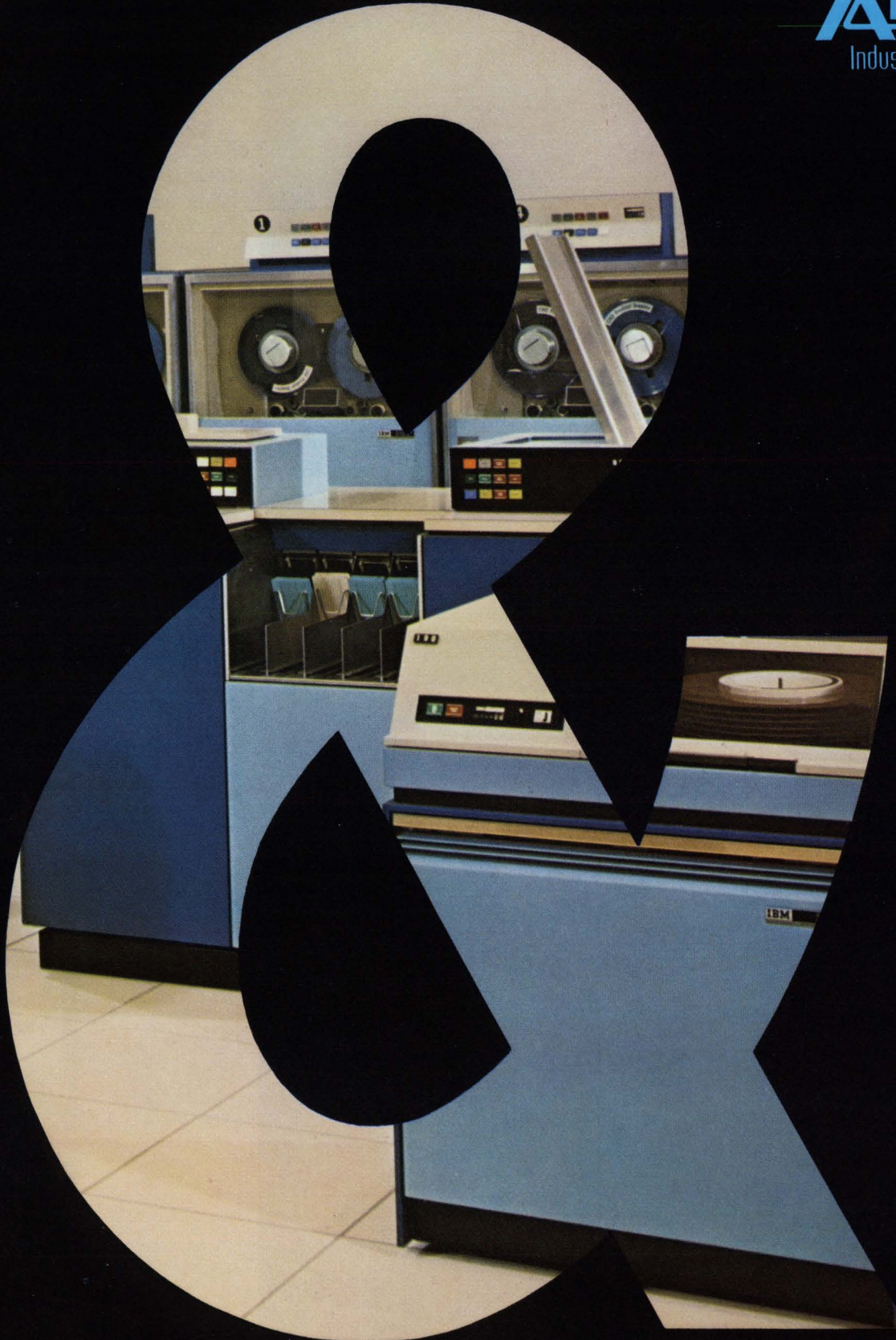

Some of our work is positively brilliant.



In fact, one of our lasers throws a beam 250 billion times brighter than the sun.

It's the brightest laser in the world.

As leaders in lasers, we've made all kinds, up to giants with 1000 megawatts per pulse. And laser welders. And, of course, a full family of laser accessories.

But lasers are only one of the up-front activities that keep Union Carbide on the frontiers of electronics. We are also leaders in the research, development and production of solid state devices, solid tantalum and foil-film capacitors, fuel cells, and single crystals and related products.

They're reasons to keep Union Carbide in mind before your projects reach the breadboard stage.

UNION CARBIDE Corporation, Electronics Division, 270 Park Avenue, New York 10017.

ELECTRONICS

An Equal Opportunity Employer

IF WE KEEP ON INTRODUCING NEW UNIUNCTION TRANSISTORS LIKE THESE, BEFORE YOU KNOW IT

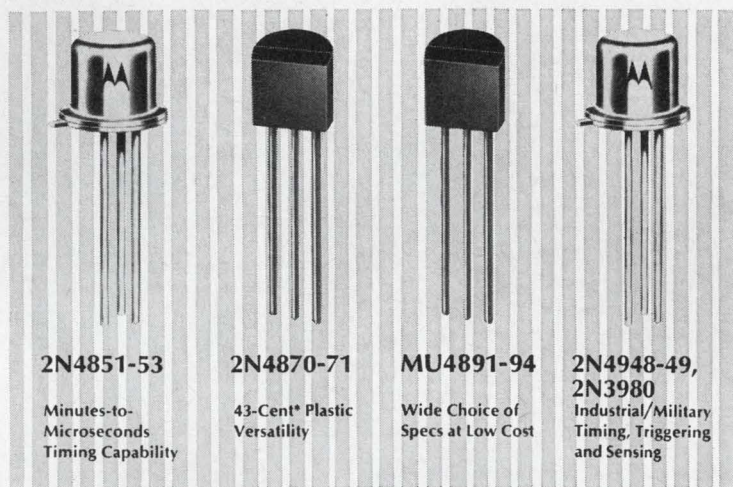

2N4851-53

Minutes-to-Microseconds
Timing Capability

2N4870-71

43-Cent* Plastic
Versatility

MU4891-94

Wide Choice of
Specs at Low Cost

2N4948-49,
2N3980

Industrial/Military
Timing, Triggering
and Sensing

YOU WON'T RECOGNIZE YOUR OLD CIRCUITS

In a little more than a year, Motorola has become the leading source for preferred, state-of-the-art unijunction transistors featuring all the fast response, long-time-delay advantages of Annular[†] technology. But just becoming the UJT price, performance and availability leader isn't our only goal . . . we want to show you how to best use them, too.

And here's how you can: send to Box 955, Phoenix, for our comprehensive, new application notes — "Theory and Characteristics of the UJT," "UJT Timers and Oscillators," and "UJT Triggers for Thyristor Circuits." You'll find many of the answers to questions about today's modern unijunction circuitry in them — we'll include UJT data sheets and a complete Selection Guide to Motorola's extensive Thyristor capability with them. Do it now.

We'll return-mail them before you can say 1-2-3.

[†]Patented Process
*1000-up.

- where the priceless ingredient is care!



MOTOROLA
Semiconductors

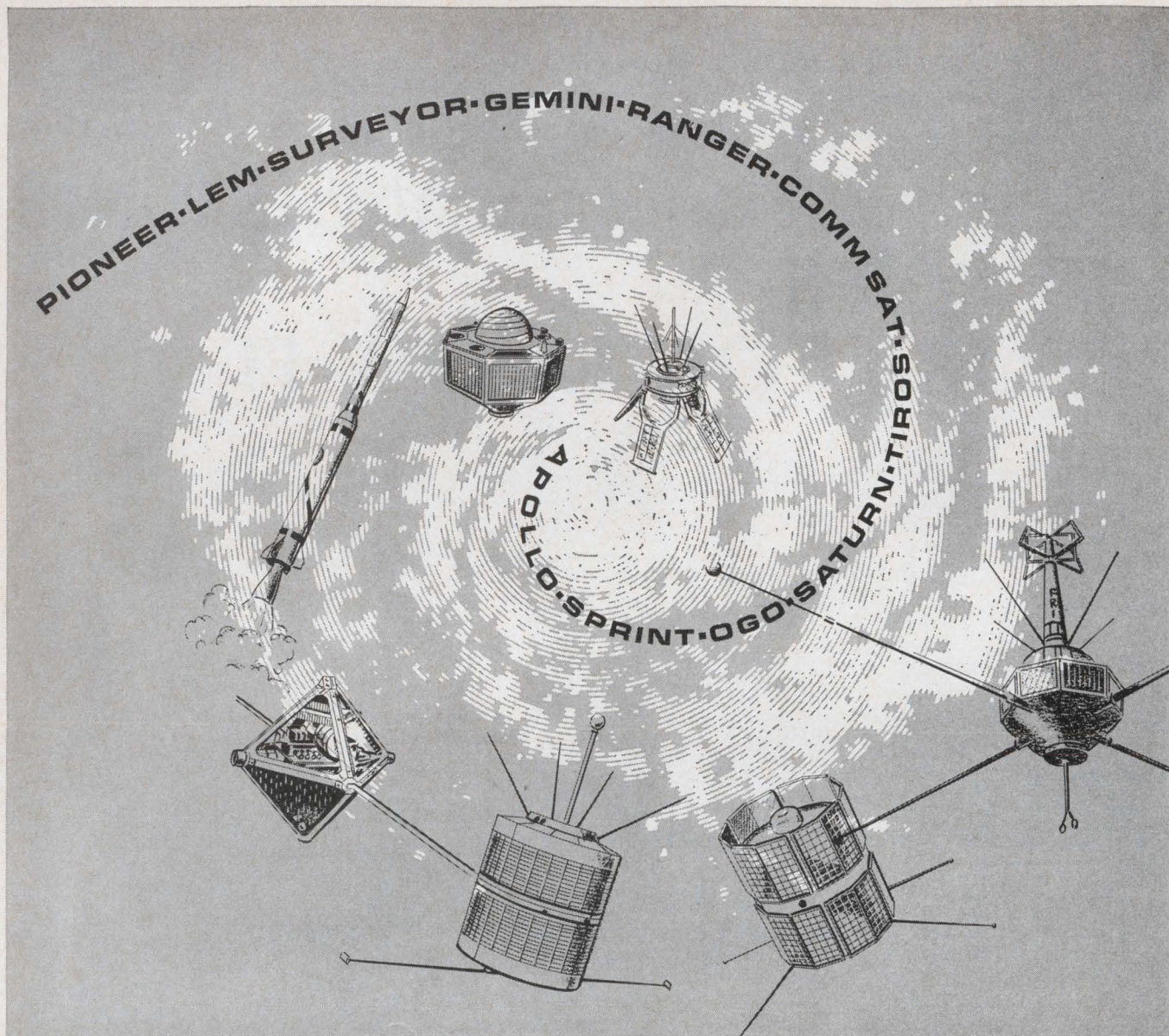

Vital. High Reliability.

In the bone-snapping cold of outer space electronic components are on their own... they *must* perform reliably. Increasingly stringent demands mean pushing technology to its limit.

McCoy has traditionally been a foremost manufacturer and supplier of the highest quality crystals, filters and oscillators for NASA and U.S. military services. To maintain this position has required constant advances in technology.

Our new research and development laboratory (with White Room facilities) is being built now to help McCoy meet the demand for even better products in the future. Coordination of engineering, manufacturing, quality control and management will keep us in the forefront in providing reliable products to meet customer specifications.

When high reliability components are needed, turn to the leader... McCoy. Engineering assistance is available of course. Write now for our new High Reliability literature.



OSCILLATORS

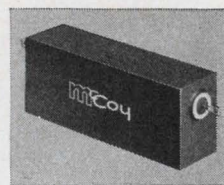

FILTERS



CRYSTALS



MCCOY ELECTRONICS COMPANY

MT. HOLLY SPRINGS, PENNSYLVANIA 17065

Tel. 717-486-3411 TWX: 510-650-3548

a subsidiary of OAK ELECTRO/NETICS **CORP**



The Electronic Countermeasures System, a valuable penetration and survival tool for B-52's, posed a tough isolator problem which was successfully solved by Sperry.

What was so tough about the isolator spec? Among other things were power handling capability (400W CW, 4kW peak); isolation VSWR limited to 1.18:1; insertion loss (only 1 db permitted), and RFI shielding to prevent interference with other aircraft systems. All parameters had to be met at altitudes up to 60,000 feet and over the temperature range of -55°C to $+55^{\circ}\text{C}$ without cooling.

Sperry met the challenge with Model No. D-44S9, a specially engineered isolator that helps assure the reliability of B-52 ECM.

Is there a particularly difficult isolator problem Sperry can solve for you? There's a broad line of standard items, plus plenty of engineering talent if you need it. For full details, contact your Cain & Co. man or write Sperry Microwave Electronics Division, Sperry Rand Corporation, Box 4648, Clearwater, Florida 33518.



SPERRY

MICROWAVE ELECTRONICS DIVISION
CLEARWATER, FLORIDA

When B-52's count on ECM, they count on isolators from Sperry . . . the first name in microwaves.

PRESSURE MEASUREMENT REPORT



REPORT NUMBER 7

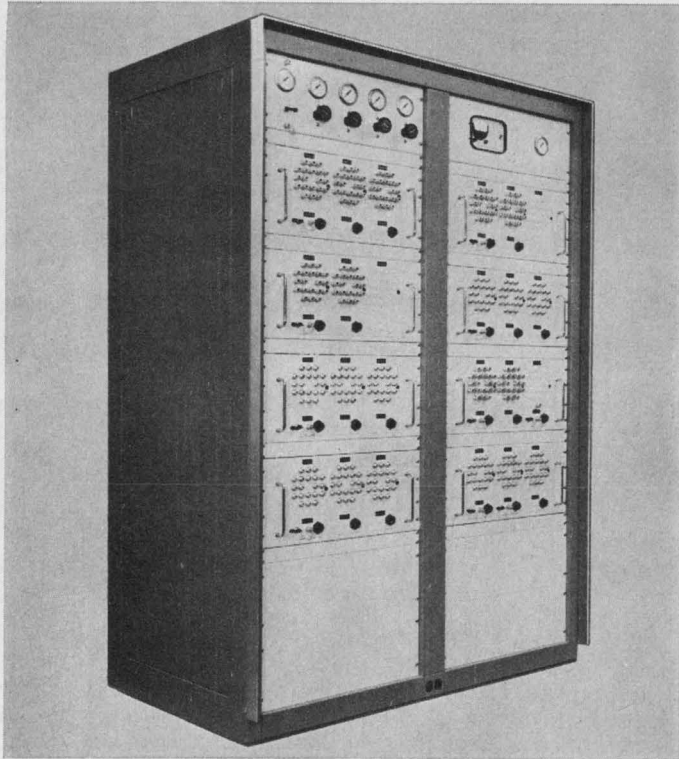

CEC brings
new
advantages
to pressure
measurement
systems

Because of the unique versatility of CEC Electromanometers, pressure measurement systems can be customer designed to offer optimum performance and operating convenience at practical prices.

REASON: These electromanometers (and many other critical system components) are all *standard* CEC products. They've proven themselves in hundreds of applications. They're adaptable—without change or modification—to a wide variety of pressure measurement systems, and they are available in a sufficient number of types to free the system engineer from costly design restrictions. Because they're available, their cost is far less than built-to-order instruments.

Why they are superior:

CEC Electromanometers consist of a transducer and a servo amplifier. Known as the Precision Pressure Balance, the transducer operates on the non-displacement, force-balance principle, affording outstanding accuracy and long-term calibration stability. So precise are these electromanometers, they assure an overall accuracy of 0.05%—often for as long as 30 days without recalibration. Reading errors are eliminated, as is the need for specially-trained



operators. There are no fussy controls to adjust, or scales to interpret.

FOR THE SYSTEMS ENGINEER: there are three distinct types of CEC Electromanometers: *Rack Mounted*, *Miniature*, and *Universal*. They differ principally in package design. Between them, they offer pressure range capability from 1.5 psi to 10,000 psi, differential, gage or absolute. All offer the same accuracy, long-term stability and ease of operation and maintenance.

Accessories are available for each to allow several Precision Pressure Balances to be time-shared by a single servo amplifier. These, and other proven techniques, allow the designer to reduce the per-channel cost of a multi-channel system, often below that of systems using transducers of much less performance capability.

The output of these electromanometers is a high-level analog voltage, linear with pressure. Data-processing is thus simplified, and off-the-shelf components can generally be used to meet system requirements.

TO THE MAN WITH A PRESSURE MEASURING SYSTEM REQUIREMENT: CEC is now prepared to meet your total system needs—with complete custom systems built to your requirements utilizing these electromanometers. We have developed specialized system technology which makes use of the unique and flexible capabilities offered by CEC's Electromanometers. This advance has made possible the prompt fulfillment of any need, from simple calibration systems to computer-compatible, data-logging systems.

For further information or application estimates, call your nearest CEC Field Office. For information on our standard electromanometers, write to Consolidated Electro-dynamics, Pasadena, California 91109. A subsidiary of Bell & Howell. Bulletin Kit #322-X2.

CEC/TRANSDUCER PRODUCTS

 **BELL & HOWELL**

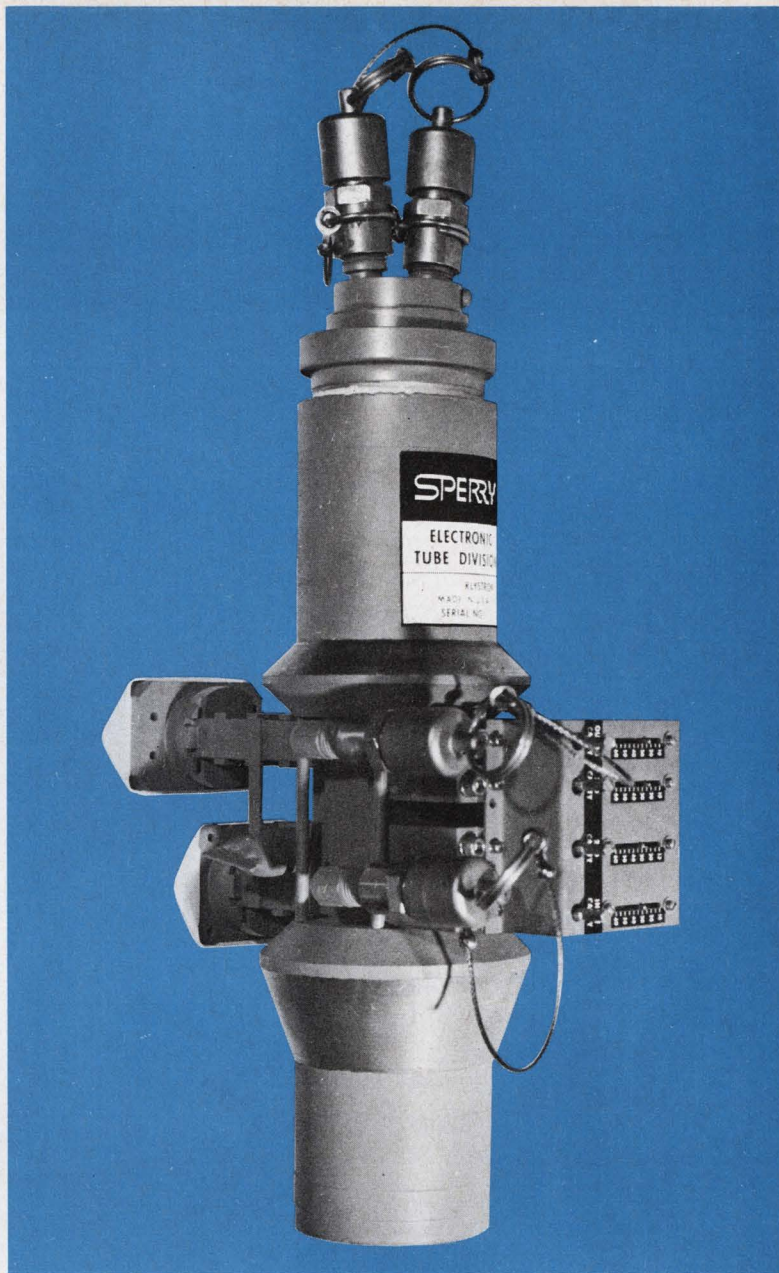

Sperry has recently proved the performance of its X band klystron amplifiers through successful application in a military satellite communication terminal.

The system demanded a tube that is tunable across the entire military frequency allocation; a tube that is easy to install, operate and maintain; a lightweight tube that occupies a minimum of terminal space.

Sperry's answer is the SAX-4705, an 8 kW, 4-cavity klystron amplifier. The tube is tunable from 7.9 to 8.4 GHz. It delivers 48 db gain. It has a 1 db bandwidth of 40 MHz and is 36% efficient. Yet it occupies less than one cubic foot, including magnet, and the entire assembly weighs only 96 pounds. In addition, it has successfully passed testing to the most stringent military environmental specifications.

Other tubes in the SAX-4700 family include a 5-cavity version with 50 MHz, 1 db bandwidth, 53 db gain and 500 MHz mechanical tuning range; a 15 kW tube for operation from 10.0 to 10.5 GHz, and a 20 kW version for the 7.9 to 8.4 GHz band. For more details on any or all of these tubes, contact Cain and Co., or write Sperry Microwave Tube Division, Gainesville, Florida 32601.

SAX-4700 Series Klystron Amplifier

Frequency range	7.9-8.4 GHz
Tuning range	500 MHz
Power output	8.0-20.0 kW, CW
1 db bandwidth	40-70 MHz
Gain	45-54 db
Efficiency	36-40%
Weight	96 lbs

SPERRY
MICROWAVE TUBE DIVISION
GAINESVILLE, FLORIDA

Military communication satellite terminal application proves versatility of Sperry klystron amplifiers.

**The new AO
StereoStar/ZOOM
Microscope
gives you high
resolution,
new convenience,
superior optics
and wide
magnification
range.**

Here are a few of the outstanding advantages that make the new AO[®] StereoStar/ZOOM Microscope the finest instrument of this type available today:

- Widest total magnification range: 3.5–210X
- High resolution to meet the most exacting needs
- The most convenient zoom control available
- Choice of five interchangeable, rotatable zoom power bodies
- Crisp, sharp images at all magnifications
- Extra large field of view and high eyepoint eyepieces
- Wide choice of stands for every purpose
- Long working distance
- Even illumination over the entire field
- Coolest operating illuminator.

See for yourself. Contact your AO Sales Representative for a demonstration, or write for our 24-page, full-color brochure on the newest in stereo microscopes—the AO StereoStar/ZOOM.

*TM Reg., American Optical Co.



**AMERICAN
OPTICAL
COMPANY**

**INSTRUMENT DIVISION
BUFFALO, NEW YORK 14215**

Circle 148 on reader service card

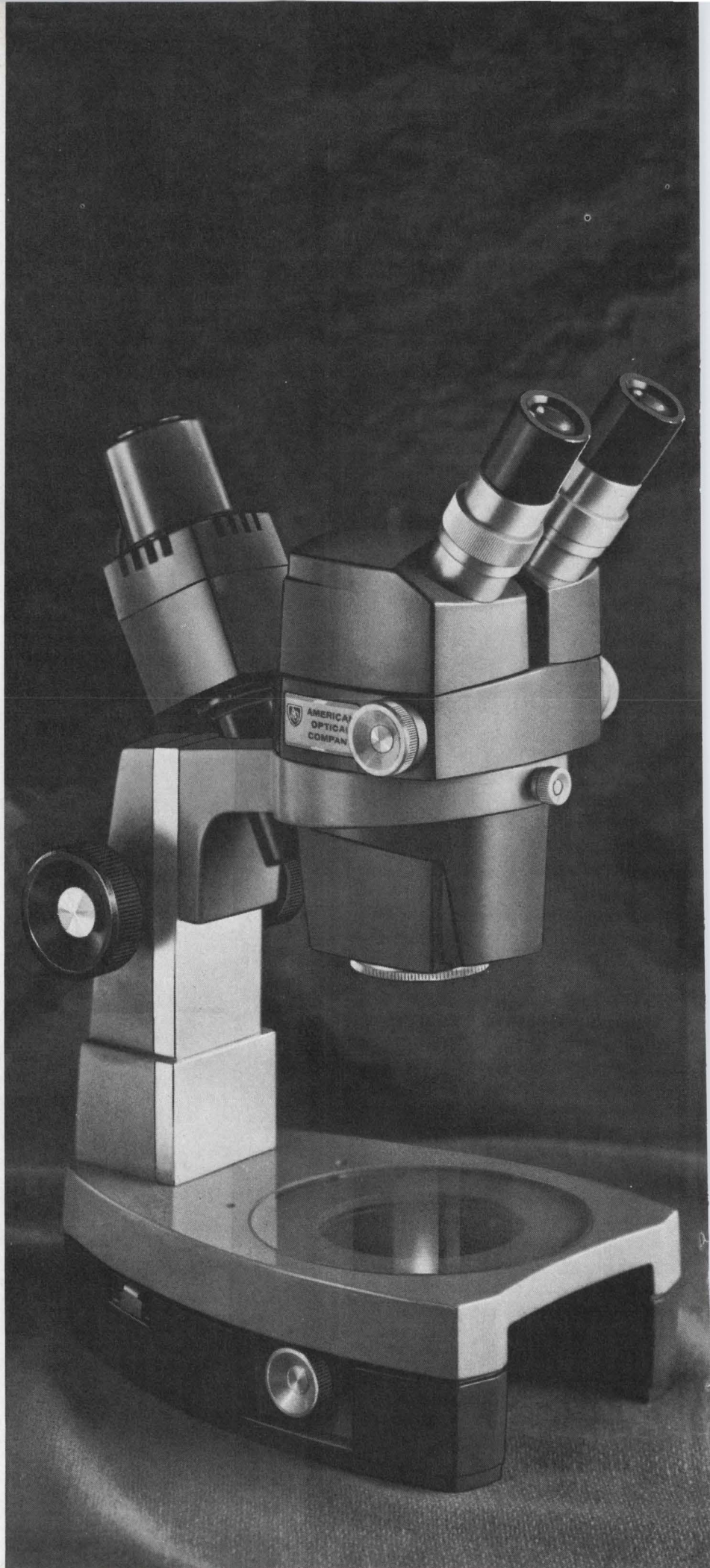

Probing the News

Communications

Crime fighting in real time

FBI's nationwide computerized information network steps up tempo of battle by replying to questions from local authorities within seconds

By Paul A. Dickson

Washington regional editor

Within six months the Federal Bureau of Investigation will have a criminal information network linking state and local law enforcement agencies in all 48 continental United States. They will be tied into the FBI's National Crime Information Center in Washington, which was just an idea as recently as 1965.

Moving with remarkable speed, considering the complexity of the system and the usual official Washington pace, the center now has its computers linked directly to 32 control terminals in 24 states and Canada. Most of the terminals are teleprinters, but FBI officials predict that within five years each state will have at least one computer of its own on line.

I. Forerunner

Obviously the FBI center will provide a market for computers and associated electronics equipment. But of greater significance is its role as the first system linking Federal, state, and local governments in a computerized network, for it may serve as the prototype for other long-sought national networks. For example, the Department of Health, Education, and Welfare has shown interest in a national health information bank; the Justice Department wants a coast-to-coast legal data bank; the Defense Department and the National Aeronautics and Space Administration also are interested in nationwide information storage and retrieval hookups.

The three electronic subsystems

of the crime center are the central computer facility in Washington, a telecommunications system, and terminal equipment—teleprinters and computers at various locations from coast to coast. Communications for the system are now provided by 124 low-speed lines leased from the Western Union Telegraph Co. that handle transmissions of up to 135 words per minute. They link each terminal to the central file, containing more than 330,000 active criminal records. The center, handling some 13,000 transactions a day from the local terminals, serves as an automated file of records of

wanted persons, stolen vehicles, vehicles used in connection with a felony, stolen license plates, guns, and other items that may be identified by serial numbers.

The center answers queries in an average of 10 seconds. Checking is done by one of two International Business Machines Corp. 360/40 computers. A typical query results from a policeman spotting a speeding car or one that is "acting suspiciously." He radios the license number to headquarters where it's fed into the FBI system. Computers in Washington check their files and report back on the status of the ve-



Command center. This is the headquarters of the FBI's National Crime Information Center in the Old Post Office Building in Washington.

Who wants to know?

While the FBI moves full speed ahead with its National Crime Information Center, alarms are being raised over possible abuses of any such system.

A Rand Corp. engineer, leader of a project to provide protection for strategic command and control systems, has called for "additional layers of protection" against invasion of privacy by electronic techniques applied to law enforcement.

Paul Baran, a 40-year-old computer expert, agrees that there are many possible electronic aids to police that do not threaten privacy. In fact, he says, technology for the general welfare has been a poor relative for too long. But he fears abuses. "Information," says Baran, "is dangerous stuff if misused."

Watch it. "Unless those who control the system are honest and safeguards are adequate, we could easily end up with the most effective, oppressive police state ever created," Baran continues. "While research and development in better techniques for law enforcement are desirable, caution is needed lest we create a Frankenstein's monster."

People leave a trail of records from birth to death—schools, job, taxes, licenses, purchases, credit, and maybe court and police records, Baran says. Today, those records are usually hard to track down. With a centralized system, especially with time-sharing—which Baran pinpoints as the gravest potential threat—data about an individual would be just too accessible. This could encourage eavesdropping and tampering. He adds: "While our computer systems may be foolproof, they're not 'smart-proof.' Information in the hands of the wrong person could turn a storage and retrieval network into an automated blackmail machine."

Progress. There's encouraging response, says Baran, from computer engineers, legal authorities, and civil liberties groups that are beginning to explore the dangers involved. "The computer industry itself should take the initiative and responsibility of building in the safeguards," he maintains.

Baran offers this partial list of checks:

- Provide cryptographic protection to discourage eavesdropping.
- Never store file data completely in the clear. Perform some simple but key controllable operation so that simple access will not necessarily mean full access.
- Make random external audits of file-operating programs.
- Detect and report abnormal information requests.
- Verify and record sources of requests.

hicle. Headquarters then radios information to the officer in the car. The man in charge of the crime information center, Inspector J. J. Daunt, sees this as an important function of the system because it serves as a warning to the policeman to be prepared for a dangerous situation if the "suspicious" car turns out to be stolen or if it has been used in a robbery.

Gangbusters' hardware. Besides the two IBM 360's, the center contains peripheral equipment from the IBM stable. There are four 2702 transmission control units to direct and control the flow between the computer and the users and two model 2314 disk pack storage devices, each of which can accommodate nearly 2 million records of 125 characters each. This month, the FBI was to receive a 2703 transmission control unit enabling the system to add 175 leased lines to hook

up new user police agencies.

Terminals now in use are mostly Teletype Corp. 35 or IBM 1050 teleprinters. But a variety of computers have been tied into or are scheduled for interface with the system. Already functioning are:

- A Radio Corp. of America 301 owned by the California Department of Justice;

- Two Sperry Rand Corp. Univac 418's, one owned by the New York State Police, the other by the Louisiana State Police;

- Two IBM 7740's, one owned by the California Highway Patrol, the other by the St. Louis Police Department;

- Two Burroughs Corp. 5500's, one owned by the New York State Identification and Intelligence System, the other by the Michigan State Police.

Within the next year, the Chicago Police Department and the

Ohio State Patrol will acquire IBM computers and the Georgia State Patrol will come in with a Honeywell Inc. model.

Daunt points out that the addition of a single state master computer enables the system to grow rapidly within the state itself. A prime example is California. The Highway Patrol's IBM 7740 was the first computer to be interfaced, and that didn't happen until April. But the Golden State now boasts 270 local terminals tied to the 7740, which in turn is tied into the FBI center.

Subnetworks. Special Agent Donald Roderick, Daunt's assistant, says that's the way the FBI wants things to work—with "every state running its own information network, keeping its own records, and coming up with its own statistics. The statistics will enable each state to make decisions and find answers to local problems." However, Roderick says that 25 or so metropolitan areas could have direct lines to Washington for quick checks of the files.

Daunt says that as larger agencies enter the system the burden of each agency will be to coordinate the efforts of the smaller outfits surrounding them. Several Canadian provinces tried to join the system but the FBI insisted that only one agency represent the country. Another recent addition—the Office of the Provost Marshal of the U.S. Army—is being asked to coordinate the law enforcement needs of all the armed forces.

II. Unified front

When conceived in 1965, the objective of the center was to place in the hands of the law enforcement community a national information network to complement similar local systems. The FBI moved fast. In early 1966, with the International Association of Chiefs of Police and representatives of a number of state and local groups, they held the first meeting. Also early last year, the FBI went to the Commerce Department's Environmental Science Services Administration in Boulder, Colo., to study the concept and provide the crime center's communications design. Late in 1966, at the annual conference of the police chiefs, the delegates adopted a basic set of standard

codes, formats, and procedures to be used by the center and all other law enforcement information systems. With the help of a half-million-dollar grant from the Justice Department and close technical liaison with the Commerce Department, the system was put into operation.

Lesson plan. Says Roderick: "Frankly, it has expanded far more rapidly than we had anticipated." Daunt says that the key to the success of the system thus far has been "the very important business of standards, accuracy, and rigid format." The American Standard Code for Information Exchange is the telecommunications code used by the center and the procedures are those adopted by the police chiefs.

"We could see early in the game," says Daunt, "that we would all have to adopt the some procedures. And it was clear to users that to benefit from the system they have to conform." Standardization, according to Daunt, eliminates interface problems and will help other government officials who have long been discussing information networks but not getting them off the ground.

Whoops. "The biggest payoff of the system so far," says Daunt, "is that we are now getting a new appreciation of the value and accuracy of information. In manual files, errors of omission and commission are made. These errors seldom came to light. Now, with the FBI center to check against local agencies, we are finding these errors." Daunt says that the national file has already been used for a check against state manual files—in one case the state found that it had misfiled records on four wanted persons. Another benefit gained from entering local records in the national bank is that, if the local file is destroyed, replacement could be provided by the national file (which is also being duplicated in case of catastrophe at the national center).

While the center has gotten into operation in short order it was not without problems, though they were of the most mundane variety. Two showstoppers: an improperly set time clock kept shutting the system off last March, and a gummed label, stuck to a drum

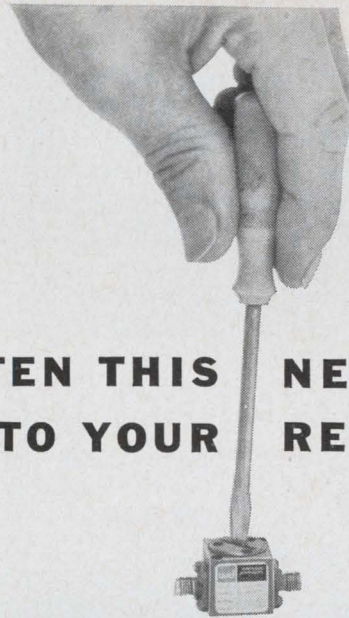

FASTEN THIS NEW YIG FILTER INTO YOUR RECEIVER PLANS

Consider the new WJ-652—the first of a new family of Watkins-Johnson fixed- or mechanically-tuned YIG filters produced in a miniature, lightweight configuration ($\frac{3}{4}$ -inch cubed) to meet rugged environmental conditions. A simple screwdriver adjustment allows for tuning plus/minus 250 MHz at any center frequency between 1–5 GHz.

As shown below, a number of these filters can be stacked to provide multichannel receiver operation—especially where driving power is either minimal or not available or where rapid switching is a requirement. Also, the WJ-652 is **ideal** for use as a frequency selective limiter at some frequencies and as a premature decline limiter at others.

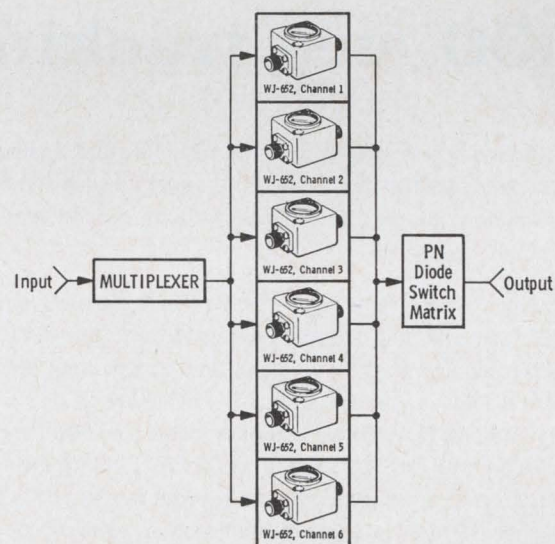

WATKINS □ JOHNSON



3333 HILLVIEW AVENUE
STANFORD INDUSTRIAL PARK
PALO ALTO, CALIFORNIA 94304

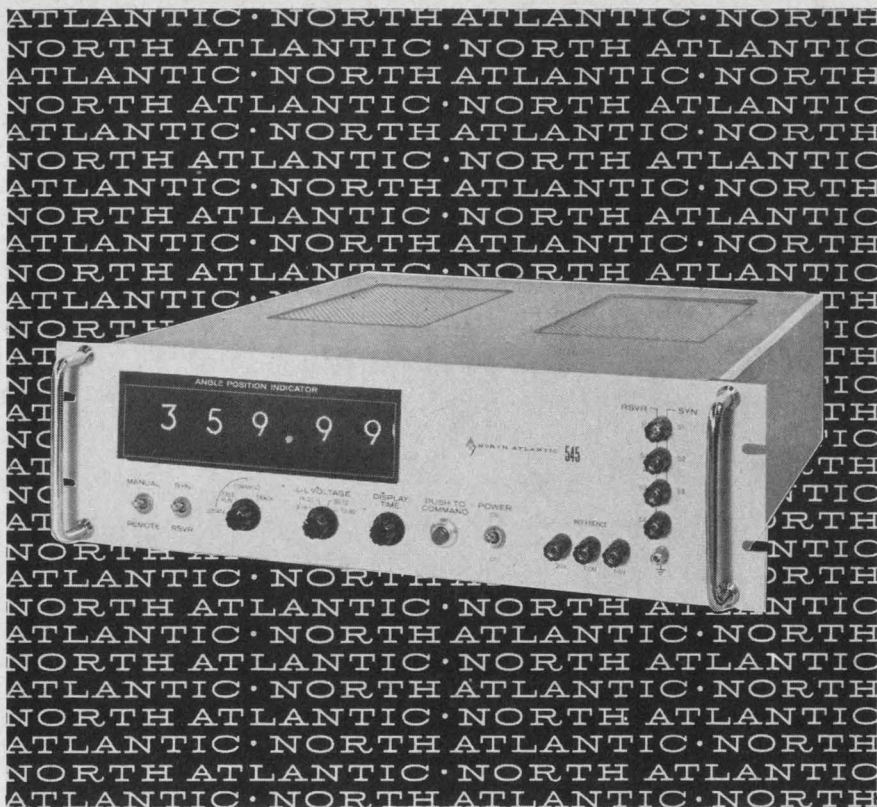

resolver/synchro to digital conversion

... .01° accuracy

...2000°/sec. tracking

North Atlantic now brings you a new generation of solid-state analog-to-digital converters for resolver and synchro data. They offer major advances in high-speed precision tracking as required in modern antenna readout, ground support, simulation, and measurement systems.

For example, the Model 545 provides conversion of both resolver and synchro data at rates to 2000°/second, and accommodates 11.8v to 90v 400Hz line-line signals. For multiplexed applications, acquisition time is less than 50ms. Digital output data is visually displayed and simultaneously available on rear connectors. All modes are programmable as well as manually controlled. Optional features include .001° resolution with 10 arc second accuracy, data frequencies from 60Hz to 4.8KHz, data freeze command for digital readout at a critical instant, and programmed mode where difference angle computation is required.

Your North Atlantic representative (see EEM) has complete specifications and application information. He'll be glad to show you how these converters can answer critical interface problems in your system.



NORTH ATLANTIC industries, inc.
TERMINAL DRIVE, PLAINVIEW, NEW YORK 11803 • 516-681-8600

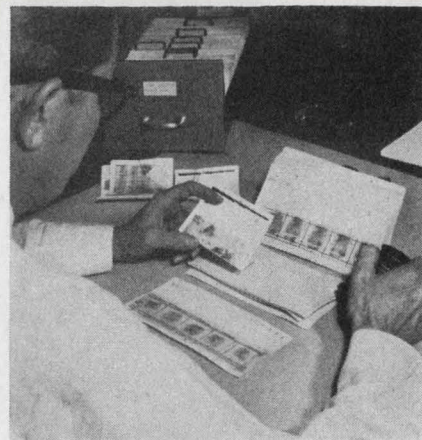

Going out. This method of comparing latent fingerprints manually will be just a memory as the crime center is fully computerized.

memory, kept computer diagnosticians puzzled for a few days.

III. Before 1984

The center is by no means complete and a variety of improvements are under consideration beyond the expansion to state computers. The following are being examined:

- New criminal records. Roderick sees a vast amount of new data that might be filed, including profiles containing the characteristics of known criminals, listing of criminal associates and the modus operandi of felons, and the digital storage of court identification records for hard-core criminals. Also envisioned, as services are expanded, are national crime statistics, storage of ballistic reports, and digital identification numbers representing fingerprints. The FBI is contracting with two electronics firms to produce prototype optical scanners by early next year to read and identify fingerprints [Electronics, July 10, p. 50]. System advisers from the Commerce Department's Colorado facility have urged developers of mobile teleprinters to keep abreast of the center's development so that these printers can be mated to the system.

- International coordination. Law enforcement representatives from about 75 nations have contacted the crime center for advice and information. Daunt reports that Sweden, the United Kingdom, West Germany, and France are moving toward the purchase of hardware for systems similar to that of the U.S. The Canadians will have their

system computerized with all provinces on line in 12 to 18 months, and Mexican officials recently told the FBI that they may be starting a similar system. Daunt hopes that all countries adopt the same procedures and standards used by the U.S., so that some day law enforcement agencies all over the world can be united.

▪ **Broadband data transmission.** Says Daunt, "At the moment, the system does not warrant high speed, but the program has not yet gotten down to the patrolman on the beat. Once this is done, the volume on the system will demand high speed." By the end of the year at least one of the lines from California will be converted from teletype grade (less than 1 kilohertz) to voice grade (4 khz). The next step will be to jump to the 48-khz bandwidth channels. The use of broadband in the future will also allow for "near real time" transmission of graphic data.

▪ **Use and transmission of graphic data.** Mug shots, fingerprints, and criminal court records are now mailed between law enforcement agencies. Daunt points out that at some point this graphic data will be scanned, reduced to a digital code, and stored. He says that state-of-the-art facsimile will probably be added to the center in the near future as an interim measure until either faster facsimile with greater resolution or some new techniques for graphic data transfer emerges.

IV. Getting their man

Effectiveness of the FBI system can be attested to by a number of "hits" made by law enforcement agencies: one of the most dramatic occurred on Oct. 24, the very day the Royal Canadian Police headquarters in Ottawa came on line. An inquiry was sent to Ottawa by a local police agency, asking the Mounties to check the engine serial number of a "suspicious looking" car. Moments later the Canadians got their first dividend from the crime information center—the car had been stolen in the U.S. in January 1967 and its owner had been murdered. The Mounties traced the car through two owners and before long came up with the name of the man who had brought the car across the border.

Award-Winning

LINDBERG HEVI-DUTY DIE BONDERS

use **STEREOZOOM®**

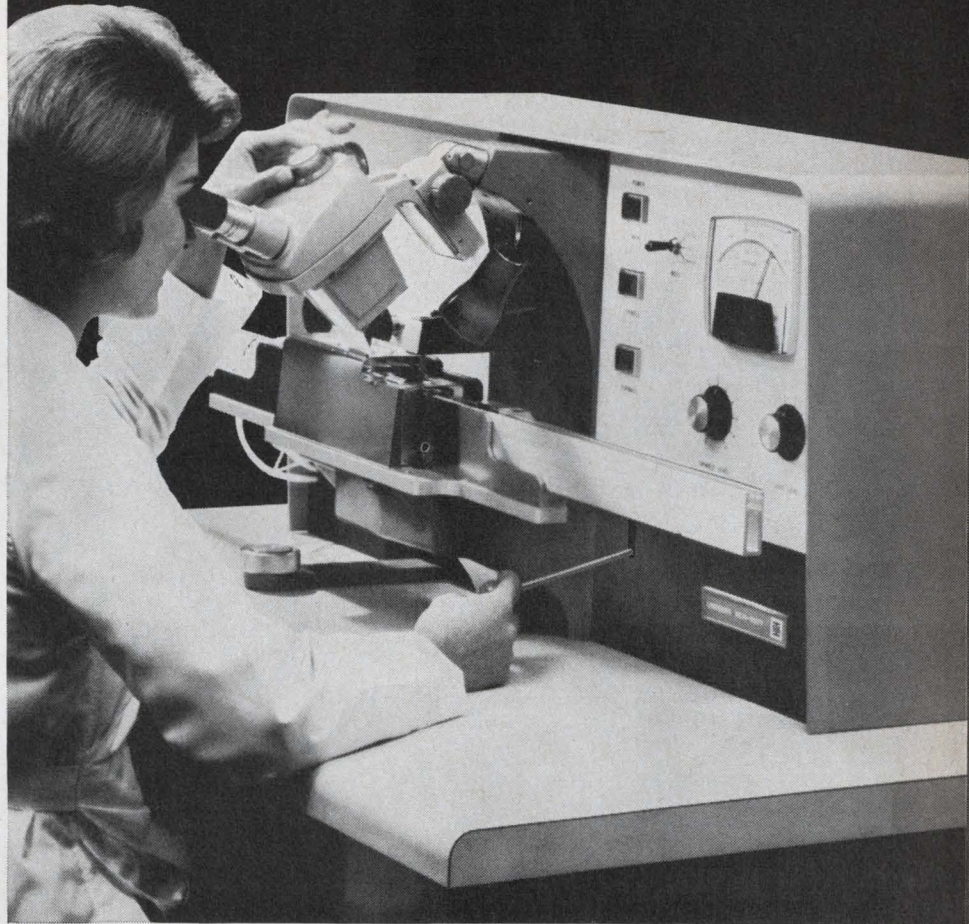

to see and check subminiature operations

you, too, should use a Bausch & Lomb StereoZoom microscope. Lindberg Hevi-Duty, a Division of Sola Basic Industries, does . . . on their automatic die and wire bonders. Designed to meet the most sophisticated demands of the semiconductor industry—for production and reliability, the bonders won a coveted 1966 Master Design Award from "Production Engineering" magazine.

StereoZoom, interlinked with a special mirror system, provides razor-sharp viewing during die pickup, positioning and bonding. StereoZoom gives a big, bright three-dimensional image—with full edge-to-edge, flat-field clarity. Continuously-variable magnification models let operator quickly zoom through a wide range to the precise setting desired. StereoZoom keeps work constantly in view, helps achieve high production rates and minimizes eye strain.



The extensive StereoZoom line lets you pick the right model for the job, or you may select individual components. Get the full story. Call your dealer, or send for Catalog 31-15. Write Bausch & Lomb, 61448 Bausch Street, Rochester, New York 14602.

BAUSCH & LOMB



Circle 153 on reader service card

Communicate clear as a Bell

... by tropo-radio, between points 35 to 150 miles apart — common distances in modern battle areas. AN/TRC-104 is an ultra-reliable, lightweight, troposcatter radio system developed by Bell Aerosystems for the U.S. Air Force. Weighing less than 500 pounds, the complete terminal equipment can be set up anywhere by a small crew in less than an hour. The channels available can handle voice or digital data and simultaneous transmission and reception. The 104 achieved its design goals and in field tests demonstrated its increased reliability, reduced size and weight. This is another example of clear thinking by the scientists and engineers of Bell.

BELL AEROSYSTEMS—A **Textron** COMPANY Buffalo, New York

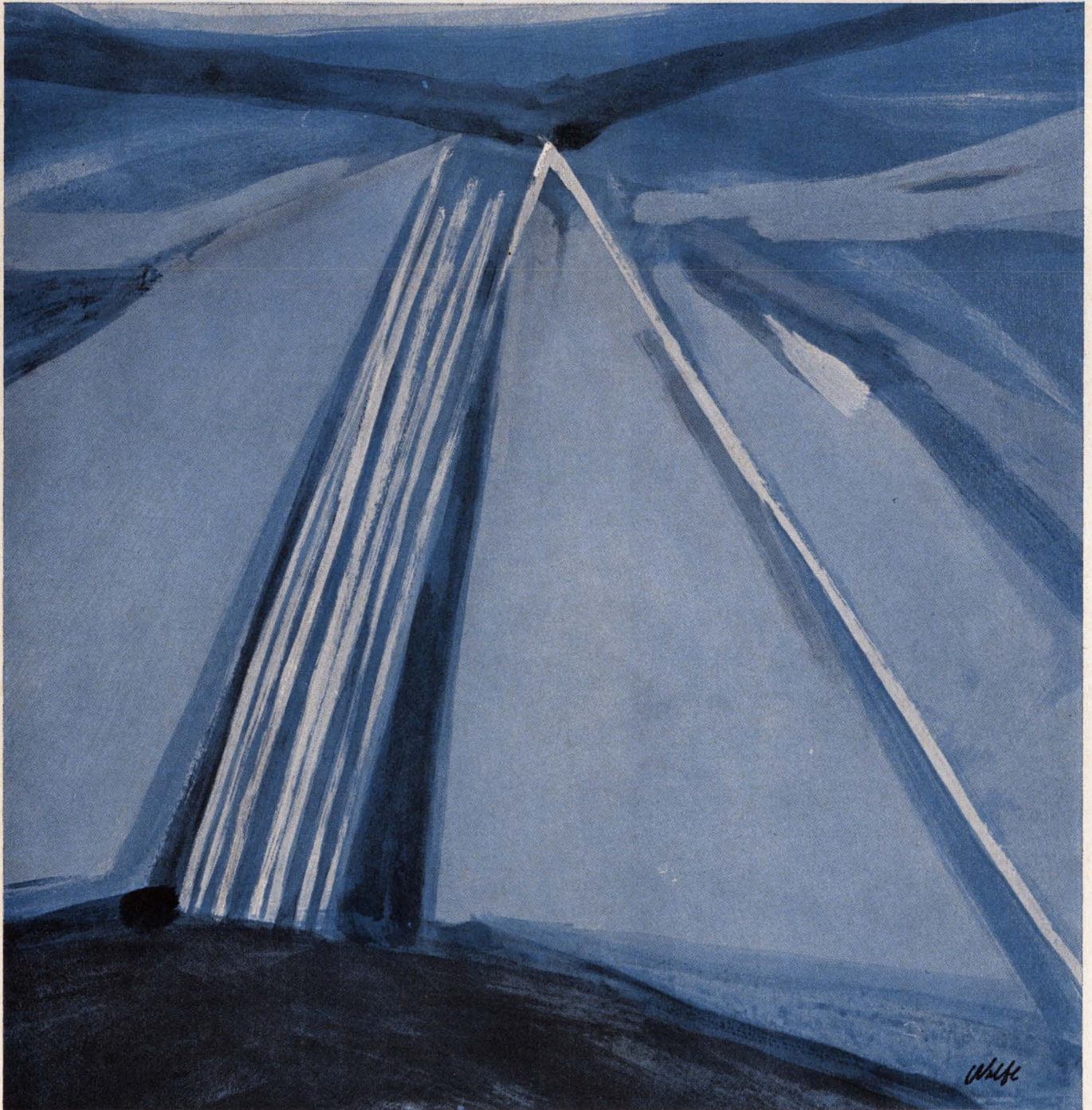
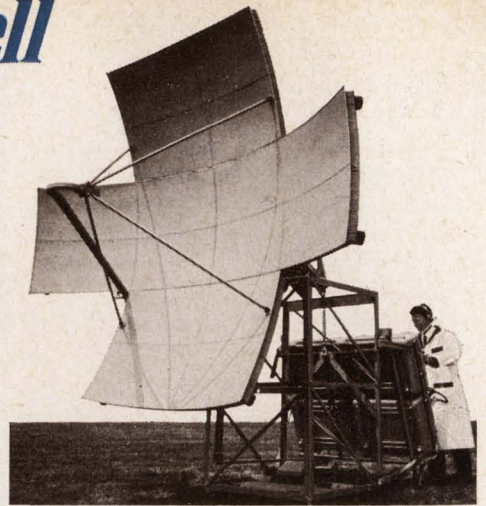

Intelsat 3: coming or going?

Comsat, pushing for FCC approval of Intelsat 4, is getting edgy about the pace of work on its first global communications satellite

Nagging difficulties in the construction of Intelsat 3—the satellites slated for launching beginning next year as the first global communications system—are distracting the Communications Satellite Corp. just as the company is making an all-out effort to win approval for its giant next-generation Intelsat 4.

Just how big these problems are no one will say, but Comsat management is described as having a definite "lack of confidence" in the Intelsat 3 development work. Comsat's president, Joseph V. Charyk, was disturbed enough to make a hurried flight late last month to the TRW Systems Group of TRW Inc., the builder of Intelsat 3, to take a look. His trip with Siegfried H. Reiger, Comsat's technical vice president, added weight to the rumors about Intelsat's problems.

One insider says Comsat blames

the holdup on sloppy management of the program, troubles with foreign subcontractors, and problems in the communications system being built by the International Telephone & Telegraph Corp.'s Defense Communications division. Other reported difficulties include getting channel separation and multiple-beam interference.

Denial. TRW's Intelsat 3 program manager, Morris Feigen, calls those reports of major technical difficulties untrue. He admits there are minor problems, such as bad soldering, but maintains that no redesign has been necessary. "We're having the customary minor difficulties that occur in any spacecraft program," he says, but they're readily solvable." And he insists TRW will come "reasonably close" to a late June delivery date for the first satellite. Insiders say Comsat was told by TRW that it will deliver the sat-

ellite by Aug. 17, five months late.

I. Backstage

All this is unfolding against a background of international machinations concerning the type of satellite that will follow Intelsat 3. While looking nervously over its shoulder at the TRW project, Comsat finds itself engaged in a battle pitting its proposed Intelsat 4 against a beefed-up version of the Intelsat 3—dubbed the 3.5—for the second global system.

Hurdles. Standing in the way of the next-generation craft is:

- The Federal Communications Commission, which still hasn't given its blessing to the program.

- A proposal before the International Telecommunications Satellite Consortium to build the 3.5.

- The plan of an international common-carrier consortium to build the TAT-5, a 720-channel transatlan-

Undersea threat

A bitter feud has developed between backers of cables and satellites over how best to expand transatlantic communications capacity. International carriers, led by American Telephone & Telegraph Co., are pushing to get TAT-5, a \$75 million, 720-channel transistorized cable, installed by 1970 between Rhode Island and Cadiz, Spain. Approval of this scheme would kill any chance the Communications Satellite Corp. has to move ahead with its plan to have the Intelsat 4 satellite on the air by 1970.

The controversy dominated corridor and cocktail-party conversations at the second world planning meeting of the International Telecommunications Union in Mexico City last month. It was clear to all parties that the cable backers don't intend to stop with TAT-5. They are determined that future expansions of international communications will be split 50-50 be-

tween cable and satellite circuits.

Vested interests. Pushing hard for cables are U.S. carriers and European countries that would share in cable ownership. Cables bring their owners far more economic rewards than a satellite network simply because ownership—and profits—are divided among only a half dozen or so interests, compared with 60 or more for a satellite system. Cable owners also control the communications traffic, and in the past they have made sure that the cables are busy before they turned to satellite circuits.

Comsat, Latin American countries, and a sprinkling of other developing nations are dead set against the new cables. They are backed to some extent by the U.S. Government, which wants to promote a global satellite communications system.

Complicating the issue is the fact that the cable backers are also

major shareholders in the 60-nation Intelsat consortium.

Leverage. By early next year, the U.S. Government should present its new position on future cable expansion. U.S. landing rights for cables must be approved by the Government, and this gives Washington a big ace in the hole. The U.S. can't be circumvented because the bulk of international communications sought for cables either originates or terminates in this country. As a result, the foreign concerns need U.S. cooperation for cables as much as the U.S. needs theirs for satellite development.

One proposal to avoid a long, head-on fight: merge all international communications carriers into a new organization that would own both the U.S. satellite and cable interests. This is expected to be considered by the special communications task force created last August by President Johnson.

NEW **KH** ALL-SILICON
DIGITALLY TUNED
VARIABLE FILTER

FEATURES
ULTRA LOW FREQUENCY
96 DB/OCTAVE SLOPE

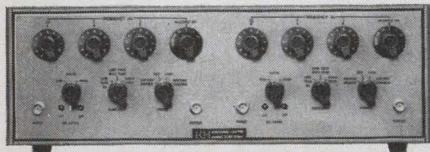

MODEL 3342 DUAL-CHANNEL, MULTI-FUNCTION FILTER provides low-pass and high-pass operation with 96 db attenuation slope or 48 db slopes as band pass or band reject filter. The digital frequency control provides cut-off frequencies from 0.001 Hz to 100 kHz with 2% calibration accuracy and excellent resetability. Size: 5¼" H x 19" W x 16½" D.

The new Krohn-Hite Series 3300 operates on either line or batteries, with 0.1% distortion and provides gain of 20 db.

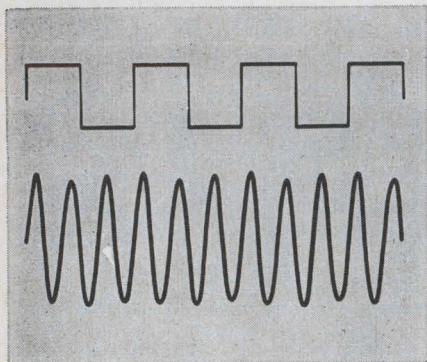

RECORDING ILLUSTRATES gain and selective response of Model 3342, in minimum band-pass operation, to a 0.01 Hz square wave. Output consists primarily of third harmonic component of input.

This kind of low-frequency performance is backed by other important specifications. Examples are:

Filter Characteristics: Either 4 or 8-pole Butterworth (maximally flat) and R-C for transient-free operation.

Digital Tuning: Six bands, 3 digits; rotary switches.

Maximum Attenuation: 80 db.

Dynamic Range: 80 db.

Input Impedance: 10 megohms.

Output Impedance: 50 ohms.

Write for Data

KH KROHN-HITE
CORPORATION
580 Massachusetts Avenue, Cambridge, Mass. 02139
Telephone: 617/491-3211

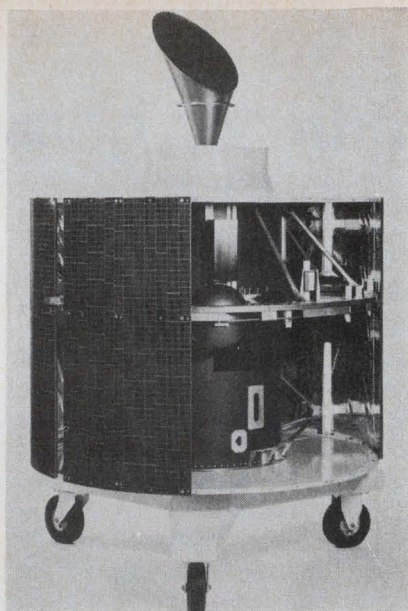

Bird. Model of Intelsat 3, satellite causing anxious moments at Comsat.

tic transistorized cable that would siphon business away from the satellite system.

While there's no guarantee that either the Intelsat 4 or 3.5 will be built, the 18-member Interim Communications Satellite Committee, which handles the day-to-day business for the 60-nation Intelsat consortium, has given Comsat permission to request proposals from industry for both craft. But there's some question about when and if this call will go out. Comsat doesn't want the 3.5 satellite but some of the Europeans show more interest in it than in the Intelsat 4, primarily because the 3.5 would provide more work for them.

The interim committee met late last month to mull the alternatives. Comsat made a vigorous pitch for Intelsat 4, says one source, but "didn't have a prayer of getting it through." A decision can't be made before January at the earliest; that's when the interim committee's technical subcommittee has its next meeting, and, a Comsat official explains, "It would be highly doubtful that the interim group would make a decision without the recommendation of its technical panel."

Complications. The Hughes Aircraft Co., meanwhile, has been making informal approaches to Comsat with the aim of reviving a plan to build an Intelsat 2.5. This craft would have between 800 and 900 channels, gained by "squinting" the antenna beam—focusing it on a

small area on earth rather than an entire hemisphere. Hughes' original Intelsat 2 design employed only 240 channels; Intelsat 3 is to have 1,200; Intelsat 3.5 would have 2,100 with a squinted beam; and Intelsat 4 would have 5,000 channels or, with a squinted beam, 10,000.

Comsat officials concede that a prolonged delay on Intelsat 4 might force them to exercise their option to buy as many as 18 Intelsat 3's in addition to the six already called for. This would make foreign members of the consortium happy because a second Intelsat 3 increment of just six satellites would boost their share of the program's contracts to 70% or 80%.

What it boils down to, says Comsat, is that if no decision is made on Intelsat 4 before the second half of 1968, the company may have to order more Intelsat 3's to provide the channels necessary to accommodate users clamoring to get into the system. If the 3.5 version is approved by the consortium, the Intelsat 3 order could be cut to fewer than the six covered by the contract.

II. Star-crossed

Intelsat 3 was saddled with one problem from the beginning—its antenna. Five months after TRW won the contract in June 1966—Hughes and the Radio Corp. of America were the other bidders—the electronically despun antenna built for the craft by Sylvania Electronic Systems' Central division in Buffalo, N.Y., was discarded [Electronics, July 24, p. 49].

This antenna was replaced by a mechanically despun unit from Sylvania's Eastern division in Waltham, Mass., and it took another two months to confirm that the new antenna would meet specifications. That seven-month delay might have been avoided had Comsat gone along with TRW's suggestion that a mechanically despun antenna be developed concurrently for insurance. As it turned out, the electronic model had the required directivity but experienced losses in the phase shifters of about 1 to 2 decibels more than could be tolerated.

Tug-of-war. Even the first version of the mechanically despun antenna presented a problem. With a parabolic reflector and cornucopia horn, it presented a squint problem:

if the transmit beam pointed at the receiving station, the receive beam was off station, and vice versa. This was solved by using a simple flat plate reflector.

Neville Barter, assistant project manager at TRW, brands as "absolutely untrue" industry reports that the combination of problems in the mechanically despun antenna and the communications transponders would reduce channel capacity from 1,200 to 900. In fact, according to Feigen, the antenna is working out better than specified. He asserts that Sylvania's engineering tests have produced better than the specified 13.2-db gain at the worst point of the beam—the edge.

Furthermore, says Feigen, Sylvania is getting better gain in both transmit and receive modes than specified; he notes that gain plays a big part in channel capacity. If the number of carriers is limited to the 10 that Intelsat 3 was designed for, more than 1,200 channels will be available, he adds.

Switch. Trw's phase-one study of Intelsat 3 projected a medium-altitude (18,000 miles) satellite using gravity-gradient stabilization. Going to a stationary-orbit design presented no problem, says Barter. TRW had already used spin stabilization for the 1958-59 Able series, on Pioneer 5 in 1960, on Explorer 6, and for the Vela program. The solar arrays on Intelsat 3, Barter says, are very similar to those used in the Pioneer program.

TRW has kept foreign subcontractors up to date, says Barter, by inviting those firms' design engineers to reside at the TRW facilities at Redondo Beach, Calif., early in the design and development stages. The subcontractors are following TRW's designs, and TRW is buying all the high-reliability components needed, such as transistors, capacitors, and resistors, and sending them overseas.

The foreign firms perform burn-ins—250 hours for passive components, 1,000 for active—and then build preproduction versions of the hardware, with TRW representatives providing support where needed. Finally, TRW tests the hardware.

III. Blueprint

Barter says there is nothing that can be considered state-of-the-art hardware on Intelsat 3. The two

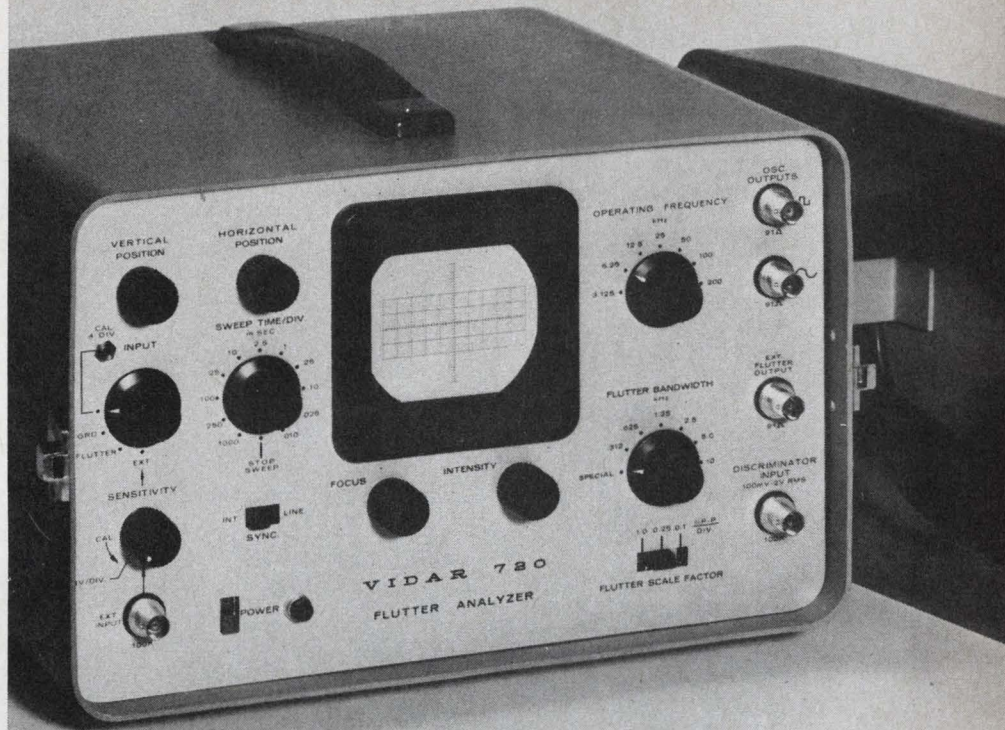

If you use recorders...

shouldn't you check flutter *before* you gather valuable data? VIDAR'S 720 analyzes and measures flutter accurately, quickly, and conveniently in accordance with IRIG 106-66 and recorder manufacturers' recommendations. The oscilloscope display helps you analyze and track down flutter components as low as 0.02% peak-to-peak over flutter bandwidths ranging from 0.2 Hz to 20 KHz. For complete details on this VIDAR laboratory-quality instrument contact Carl Smith, (415) 961-1000, VIDAR Corporation, 77 Ortega Avenue, Mountain View, California 94040.

VIDAR

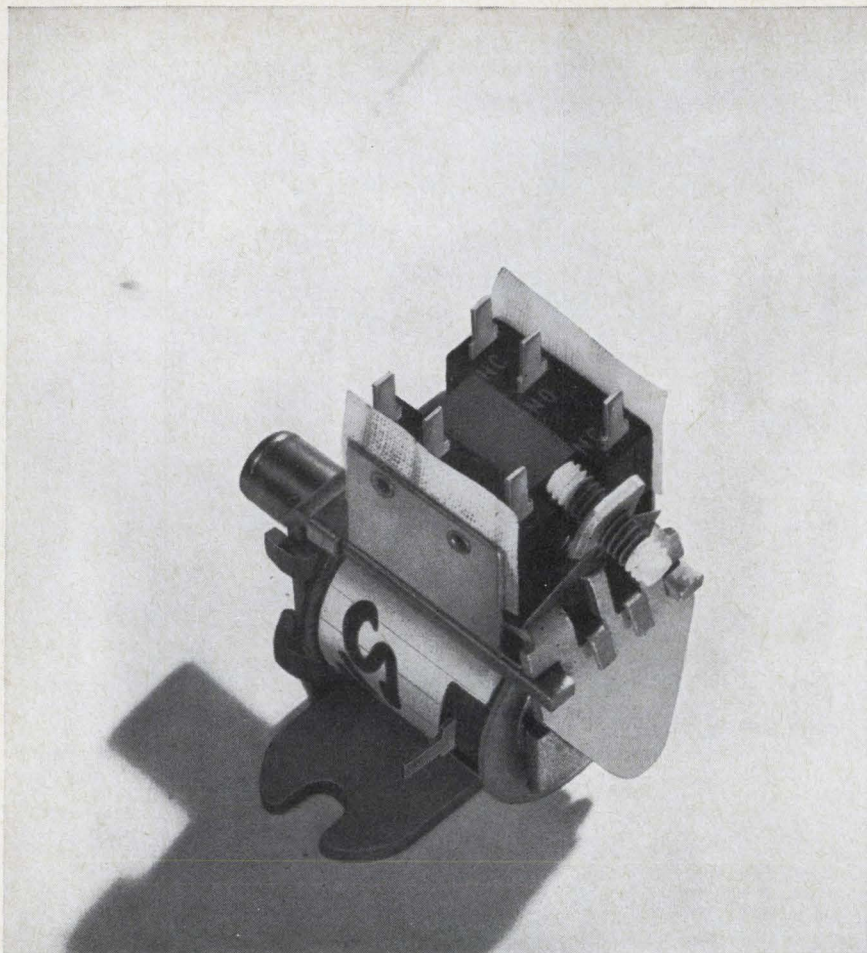

Little Emancipator

You can often do away with a separate slave relay or lock-in circuitry, simply by using a Heinemann Silic-O-Netic® time-delay relay. Its continuous-duty coil can remain energized indefinitely after actuation, and its SPDT or DPDT contacts are rated up to 5 amps (for the Type B shown). Your saving shows up not only in circuit simplicity but in the remarkably low price of the one relay that'll be doing two jobs extremely well.

The five Silic-O-Netic models offer a combination of fast recycling, good repeatability, and low power consumption—virtues inherent in their hydraulic-magnetic actuation. No thermal elements, and therefore no

“heat-loading” on frequent recycling, and only minor effect on delay from ambient-temperature changes.

We offer sixteen standard timings, $\frac{1}{4}$ to 120 seconds, with reset time about 25% of the rated delay; coil ratings (for continuous duty, mind you) up to 250 vac or 120 vdc; plug-in models, hermetic models, open-frame and enclosed-contact models. Bulletin 5006—yours for the asking—will tell you all you want to know about these versatile little t/d relays. Heinemann Electric Company, 2600 Brunswick Pike, Trenton, N. J. 08602.



HEINEMANN

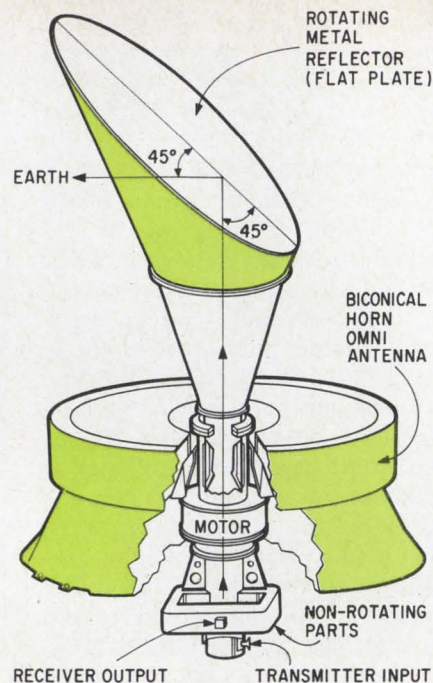

Horn. Mechanically despun antenna uses fiber glass, shown in green.

wide-bandwidth transponders (225 megahertz each) and high-gain antenna are extensions of existing technology. And the official notes that because Intelsat 3 is to be the first satellite with a despun antenna, the transponders' effective radiated power (erp) of 22 db above 1 watt is “significantly more” than that of previous satellites.

Give and take. The antenna subsystem receives communications signals at a frequency of 6 gigahertz and transmits them at 4 Ghz. It transmits telemetry signals and receives command signals at both these frequencies. Transmitted signals are circularly polarized to the right, received signals to the left.

The antenna is stepped in a direction counter to the satellite's spin by a motor that takes its reference from the spacecraft's earth reference pulse. The circuitry here consists of the motor and fault logic, a motor driver, a d-c to d-c converter, and associated filters.

Trw is developing all subsystems except the Sylvania antenna; the communications, telemetry, and command unit, which are being built by ITR; and the apogee thrust motor, being furnished by the Aerojet-General Corp.

Now hear this. The communications, telemetry, and command system is another pacing item in Intelsat 3. A single duplexer in the com-

munications subsystem allows the two amplifier chains to operate simultaneously with or separately from the same antenna, and feeds the two amplifier chains. TRW's Feigen says: "Because we have to diplex into each transponder, one of the very difficult tasks we have is getting linear performance near the band edges of the diplexer. He describes the diplexer TRW is using as "the best that can be built at the moment to meet various constraints, but still a difficult pacing item in the subsystem."

The total erp rating of Intelsat 3 is 25 dbw. Signals received at 6 Ghz are to be amplified without any modulation change and converted to the 4-Ghz frequency for retransmission to earth stations in the 3,700-to-4,200-Mhz common carrier band. Communications signals received in the 5,925-to-6,155-Mhz band are first amplified in a two-stage tunnel-diode amplifier that provides a 35-db gain. The amplifier output is then translated to the 4-Ghz common carrier band by a mixer using a 2,225-Mhz local oscillator. And the translated signal is amplified by an integrated traveling-wave tube made up of a 0.1-watt low-level tube and an 11.7-watt output stage with a total gain of 80 db.

Obey. Feigen explains: "Pointing the antenna must be done either by onboard sensors and logic or by ground signals, and we have to be able to select either method on ground command."

To despin the antenna by onboard means, leading-edge horizon pulses from the earth sensors are applied to the antenna's control electronics. The speed of antenna beam rotation in relation to satellite rotation is then controlled by the frequency of earth pulses. Antenna control from the ground is achieved by commanding the system to function on artificial pulses, and then transmitting these pulses to the satellite at its rotational rate.

Two radial and two axial thrusters triggered by ground commands position and orient the satellite.

The reporting for this article was done by Lawrence Curran in Los Angeles, and Paul Dickson and Seth Payne in Washington. Howard Wolff in New York wrote the story.

Compacts even control tempers

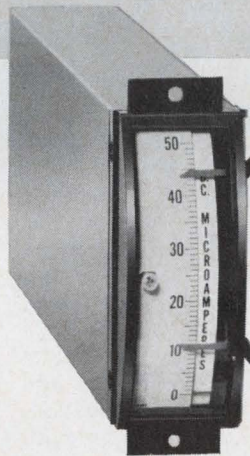
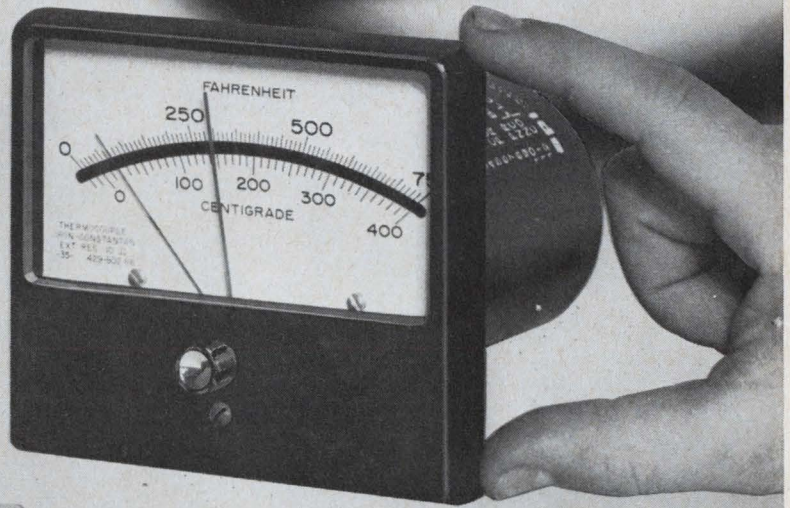

You won't fume or fret over delivery of API's versatile little controllers. Both the upright and edge-reading styles are waiting on the shelf in the most popular current, voltage or temperature ranges.

Compacts contain integral solid-state circuitry behind vibration-resistant taut-band meter movements. Just specify the control action you need for any unamplified signal, DC or AC.

Either single or double set points are adjustable immediately. The existing signal is always displayed.

Compacts not only preserve your good nature—they'll downright spoil you.

Read all about them in Bulletins 48 and 49.

api

INSTRUMENTS CO.

CHESTERLAND, OHIO 44026 • (CLEVELAND-216) 729-1611 • TWX: 810-427-9230
In Canada: Oshawa, Ontario • (416) 576-1541

PUSHBUTTON

designed for computers

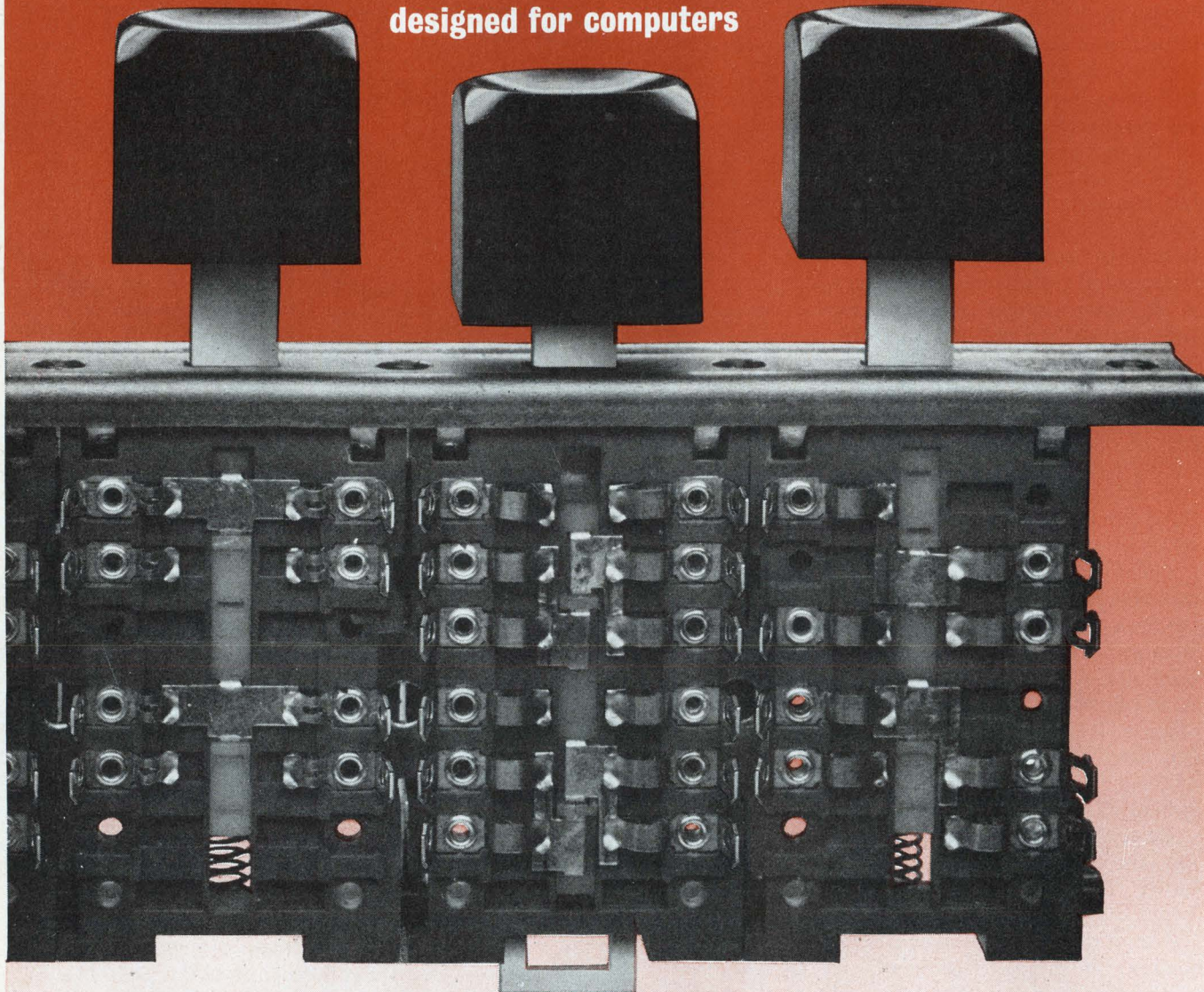

Computer manufacturers no longer have to "make-do" with a pushbutton switch designed for non-computer use. These new Oak switches give you highest reliability—with double-wiping clips locked firmly into recessed barriers for high voltage breakdown characteristics, and a Kel-F slider insulator for smooth action. Response is fast...with stroke as short as $5/32$ "...and operating pressure is light and consistent from button to button. Maximum circuitry available, 4 PDT. Inboard or outboard mounting; molded stator case has interlocking lugs for firmness... almost unlimited stacking. Many options available: Normal interlock, push-to-latch, push-to-release, momentary...or any combination of these. Also multiple latch bar arrangements for any number of buttons up to 12 buttons maximum. (Example: 4 groups of 3 buttons on a 12-button bank.) Pushbuttons are $3/4$ " on center with $2\frac{3}{4}$ " maximum push rod length. Rated 0.5 amp. @ 115 vac or 1 amp @ 28 vdc. For full details, write for Bulletin CD-280.



And, for other computer applications Oak has the 184 Lever Switch... small, molded diallyl phthalate stator, long life, more clips per stator, low electrical leakage, no extra cost. Many options. For full details, write for Bulletin SP 240.

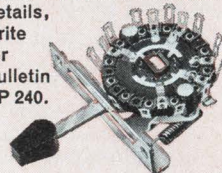

OAK MANUFACTURING CO.

A DIVISION OF OAK ELECTRO/NETICS CORP
CRYSTAL LAKE, ILLINOIS 60014

Phone: 815-459-5000 TWX: 910-634-3353 CABLE: OAKMANCO

Santa's helpers shun electronics

Technological toys will fill few Christmas stockings this year; prices are high and most children prefer conventional playthings

By Peter J. Schuyten

Staff writer

Santa Claus is coming to town again without much in the way of electronic toys. Neither toy makers nor the electronics industry are particularly to blame for the lack of such marvels in Christmas stockings. That tyrant of the marketplace—the American child—is primarily responsible, never having shown any great interest in complex, electronic playthings.

Aside from a minority group of prodigies who assemble miniversions of the latest in scientific gear like computers, telescopes, and atomic energy labs, most kids are content with such perennial best-sellers as Lincoln Logs, burp guns, Erector sets, toy soldiers, and Raggedy Ann dolls.

I. Mournful numbers

“Back in 1960 toy makers began marketing electronic items like robots, radio-controlled cars, and bullhorn devices,” says Pat Tomaro, engineering vice president at Remco Industries Inc., Harrison, N.J. “But they didn’t sell. The bullhorns were unreliable and inefficient; the radio-controlled cars were too expensive; and the robots lacked the user participation factor that is so essential for holding the child’s attention.”

Proving the rule. Every now and then, of course, there comes along a successful electronic toy like Remco’s Tommy the Turtle [Electronics, Sept. 18, p. 47], which in-

corporates a 27-cent silicon controlled rectifier. This device, which responds to audio signals—a whistle or voice command, for example—starts and stops a battery-operated motor that propels the turtle. Tommy’s list price is \$14.95.

Until recently, the DeLuxe Topper Corp. of Elizabeth, N.J., manufactured a doll called Baby Boo that didn’t sell. It cries whenever light hits a photodiode implanted in its stomach. The device draws current to turn on a transistor which pulls in a relay activating a motor that makes the doll squeal. Baby Boo, still in distribution, lists for \$18 and retails for about \$13.

Special situations. Perhaps the largest market for electronic play-

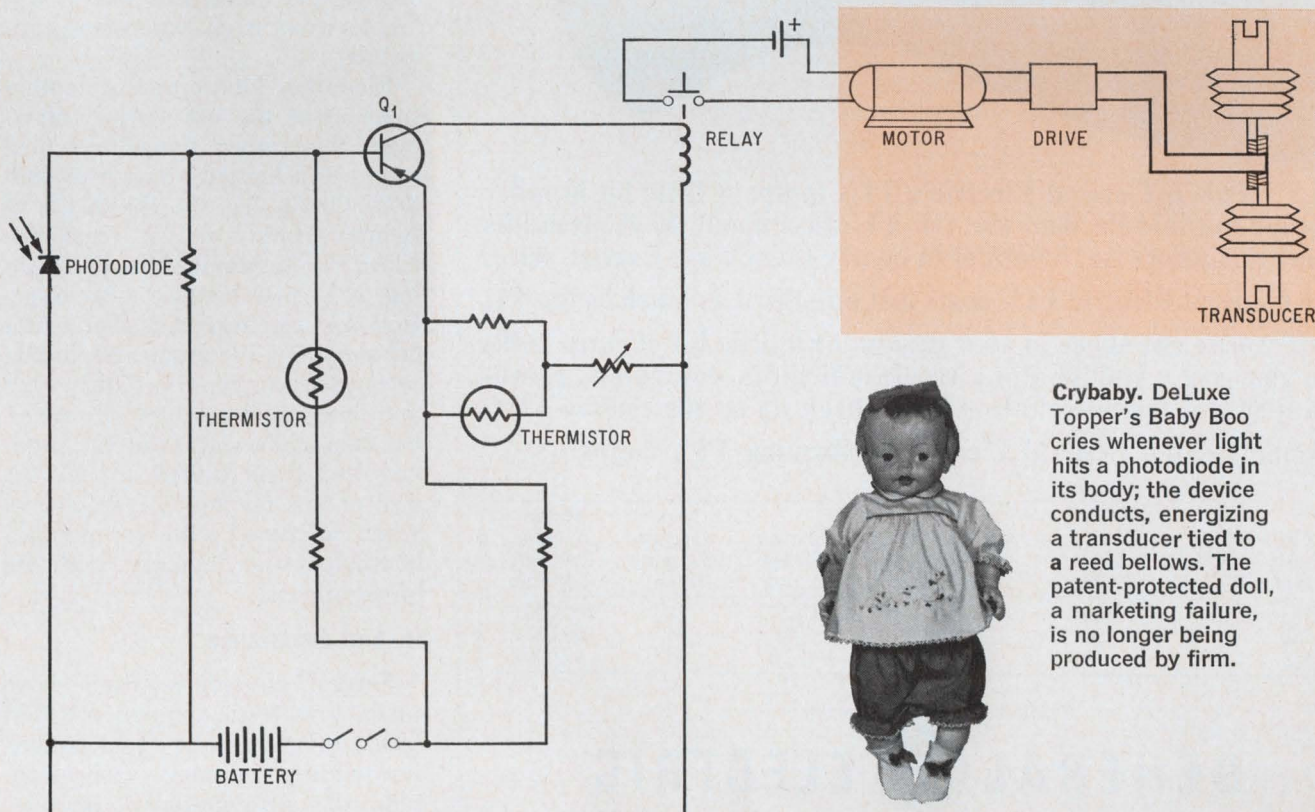

Crybaby. DeLuxe Topper's Baby Boo cries whenever light hits a photodiode in its body; the device conducts, energizing a transducer tied to a reed bellows. The patent-protected doll, a marketing failure, is no longer being produced by firm.

CHUBBY IS CHEAPER!

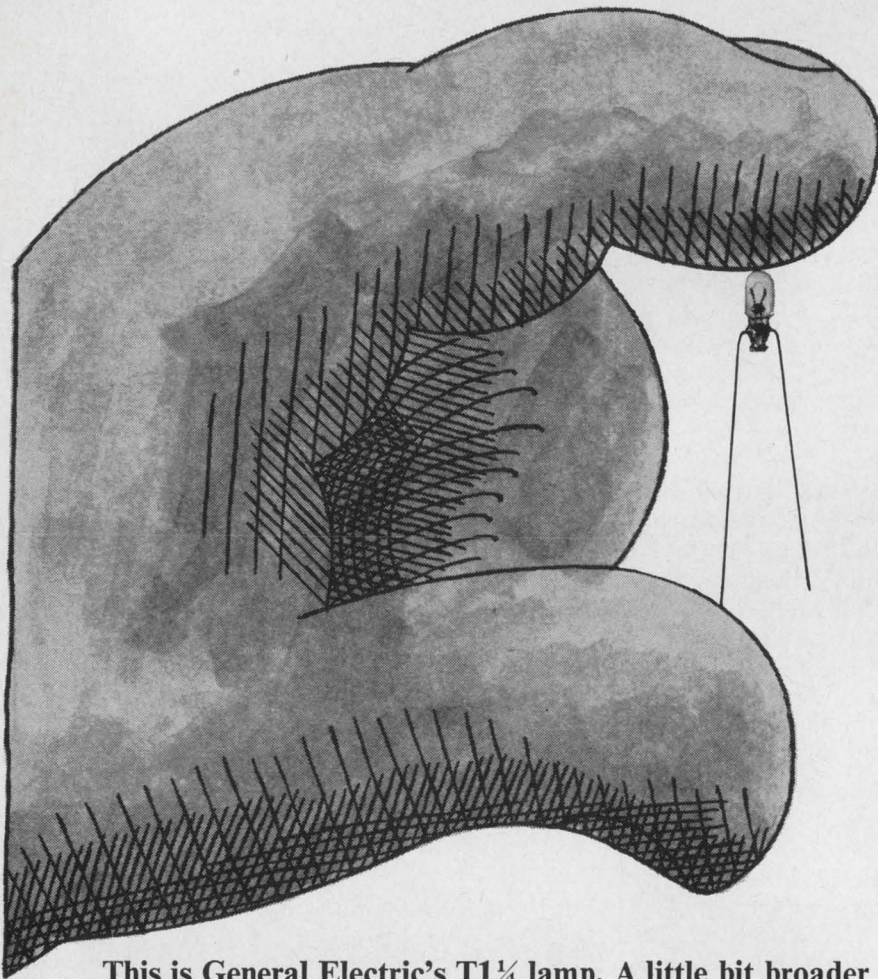

This is General Electric's T1 $\frac{1}{4}$ lamp. A little bit broader around the middle than the GE T1. Just about 40 thousandths broader. Otherwise, identical in nearly every way. Except price. The General Electric T1 $\frac{1}{4}$ costs just one-third as much as the T1! So if you've got space in your design for a little bit of extra bulk, you can save a bundle. For aircraft indicators, computers, photo-chopper and photoexcitation jobs, check up on the chubby T1 $\frac{1}{4}$. Economy-rated General Electric performing T1 $\frac{1}{4}$ lamps:

GE Lamp Number	Design Volts	Design Amps	Approx. Mean Spherical Candlepower	Filament Designation	Max. Overall Length (Inch)	Rated Average Lab. Life (Hours)
583	5	.06	.05±25%	C-2R	$\frac{1}{4}$	100,000+
580	5	.06	.03±25%	C-2R	$\frac{1}{4}$	100,000+
515	5	.115	15±25%	C-2R	$\frac{1}{4}$	40,000+

Miniature Lamp Department

GENERAL  **ELECTRIC**

... many electronic toys
carry high price tags ...

things is in the audio-visual field where so-called educational toys are numerous. For example, the General Electric Co.'s Consumer Electronics division markets a toy called Show 'n Tell, which is essentially a slide projector synchronized with a transistorized phonograph. The toy's appeal, however, is somewhat diminished by its retail price of about \$22—a large outlay for a single item.

General Electric says it is the only consumer electronics company with a separate marketing operation for products aimed at the 3-to-12-year-old age group. But a GE spokesman concedes: "Children's electronics items like Show 'n Tell are nothing more than adaptations of adult products."

Mattel Inc. of Hawthorne, Calif., also has come up with an educational toy based on a transistorized phonograph, but with a new twist—rectangular-shaped records. Called the Talking Learning Machine With Talking Tiles, the toy's tiles—or records—have English, Spanish, and French phrases, along with appropriate sound effects and background music to help the child associate the words with specific objects and situations. But at \$25 this toy, too, is an expensive proposition.

Electronic kits represent another segment of the toy market. However, this rather specialized field caters to a limited number of children. Outfits like the Heath Co. of Benton Harbor, Mich., and the Electronic Instrument Co. of Flushing, N.Y., merchandise a broad selection of electronic kits that center on simplified electronics including integrated circuits, transistors, SCR's and integrated circuits. However, because of the nature of the products and their limited appeal, the size of this market is infinitesimal when compared with the multibillion-dollar toy industry with its broad appeal.

II. Sad experience

Several electronics firms have made toys with components that failed to meet tight specifications for military contracts. For example, the International Rectifier



Setting. Educational audio-visual toys like General Electric's Show 'n Tell machines have only a small niche in the multimillion-dollar industry.

Corp. of El Segundo, Calif., brought out a line of electronic toys only to come a cropper.

Seven years ago International Rectifier started making playthings with an eye to establishing a profitable outlet for photocells which did not meet the standards of defense contracts it was working on. The company offered such items as laboratory sets and racing cars that stopped and started in response to flashlight commands.

Five years later, in 1965, International Rectifier withdrew from the toy market, somewhat sadder and wiser. Glenn Geissinger, the concern's marketing manager, says of the venture: "We made a slight profit, but we also learned that an electronics firm wishing to break into the toy market better come up with a new gimmick, one that hasn't already been beaten to death by the industry. Then they should tie in with a well-known toy company, capitalizing on its name and national distribution channels."

Unique selling proposition. International Rectifier's experience in the toy industry suggests that electronics must make a special contribution to a plaything if it is to capture any significant portion of the toy market. A spokesman for Mattel feels there is a "reasonable prospect" for electronics in toys. But he adds: "The straightforward use of discrete components and associated hardware is rarely the easiest or most reliable way of manufac-

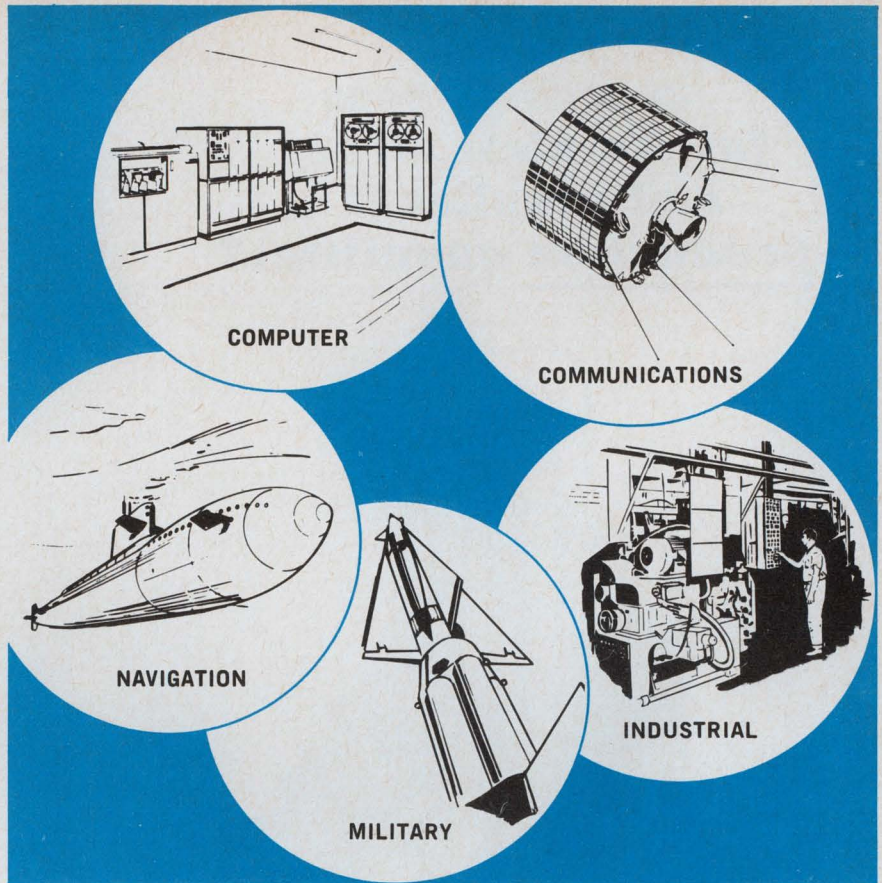

There's a rumor in engineering circles...critical circuits need Nytronics Ceramic Capacitors.

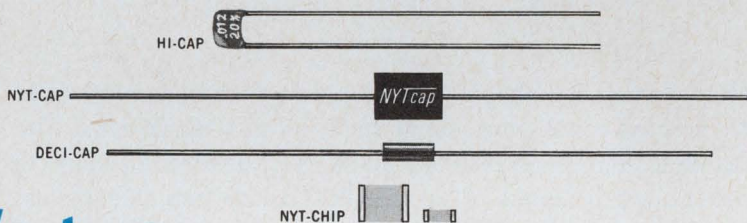

It's true...

because continuous Nytronics research and development, linked with our unique standard line concept, have achieved the highest degree of precision performance together with rapid volume production. Our wide range of miniature capacitors has an exceptionally large capacitance-to-size ratio.

HY-CAP: .01 to 2.5 mfd.; $\pm 20\%$ tolerance; 100 WVDC; no derating to 125°C; and meets MIL-C-11015.

NYT-CAP: Molded epoxy package 0.1" diameter by 0.250" long4.7 to 220 pf; and 0.350" by 0.250" by 0.1"270 to 4700 pf; T/C does not exceed ± 40

ppm/°C (-55°C to $+125^\circ\text{C}$); and 200 WVDC.

DECI-CAP: Epoxy molded envelope 0.100" diameter by 0.250" long4.7 to 27,000 pf; and $\pm 10\%$ tolerance.

NYT-CHIP: 0.170" by 0.065" by 0.070"4.7 to 220 pf; and 0.280" by 0.195" by 0.070"270 to 4700 pf; T/C does not exceed ± 40 ppm/°C (-55°C to $+125^\circ\text{C}$); and 200 WVDC.

In addition to ceramic capacitors and inductors, we maintain inventories of high quality delay lines and resistors. Complete engineering data on all products will be sent on request.



NYTRONICS®

...for Precision Electronic Components

550 Springfield Ave., Berkeley Heights, N.J. 07922 ■ (201) 464-9300 ■ TWX: 710-984-7977

**who meets
exacting specs
for stainless strip
and supplies it in
production quantities?**

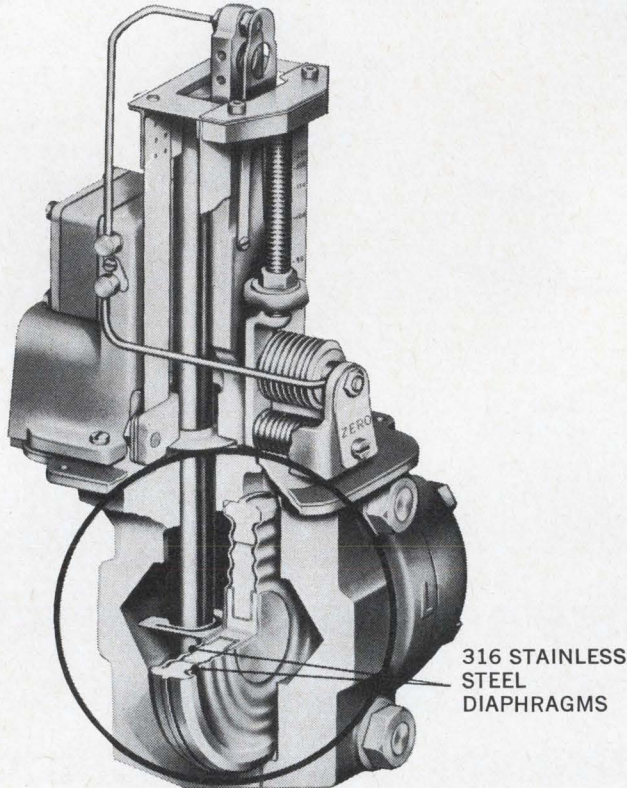

Foxboro differential pressure transmitter

An important component in this force-balance transmitter used for process control is a pair of stainless steel diaphragms. The material from which they are made must be strong enough to resist sudden surges of up to 6,000 psi on one side against no pressure on the other, yet thin enough to measure very slight pressure differences. For uniformity of operation, thinness tolerances must be held to ± 0.0001 ".

Hamilton Precision Metals, with their unmatched capability and productivity, easily met the critical specifications and satisfied the requirements for repetition of those properties from lot to lot.

Hamilton Precision Metals is your prime source for ultra-precision-rolled metals in mass production quantities. 7 proprietary metals, 12 pure metals and 112 commercial alloys are available from Precision Metals. Write today for new 48-page data book.

HAMILTON PRECISION METALS

division of Hamilton Watch Company, Lancaster, Pa. 17604

Market profile

Toys, as industry data attests, are very big business. The Toy Manufacturers Association of America estimates that playthings will ring up \$1.53 billion in sales by year-end 1967. During the Christmas season—November and December—six of 10 adults buy toys. About 53% of the industry's dollar volume accrues in this period.

turing a plaything. Most toys can perform complex functions using electromechanical components." Besides, he says, low-cost components are often just too unreliable, even for toys, and manufacturers who use expensive devices price themselves out of the market.

Poor economy. Jay Cooper, director of product development at the Ideal Toy Corp. of New York City, agrees: "Once you put high-quality capacitors and resistors in a circuit, you've run up quite a bill. The few manufacturers involved with electronic toys use transistors that are below milspecs, which means that they've got to build better-than-military circuits."

Cooper stresses that toy manufacturers usually don't know enough about electronic circuitry, nor do they like the idea of investing in expensive, but necessary, test equipment. "Why go to the trouble? Toys can perform an intricate series of instructions with mechanical components," he says.

III. On the track

One area in which electronics may eventually have a significant impact is the electric train business. A spokesman for the Lionel Corp. which, besides being a major producer of electric trains, has several electronic components operations under its wing, says that while it did not introduce electronics into its offerings this year, there is every reason to believe that it will do so in the future.

Whether Santa's helpers will ever keep pace with the advanced technology revolution is a secret known only to the Remco's, the Ideal's, and the Mattel's. Most are at least studying the possibility. But a spokesman at one firm says: "While cost is a factor, the main question is can electronics do what can't be done another way."

COMING

from **Solitron**

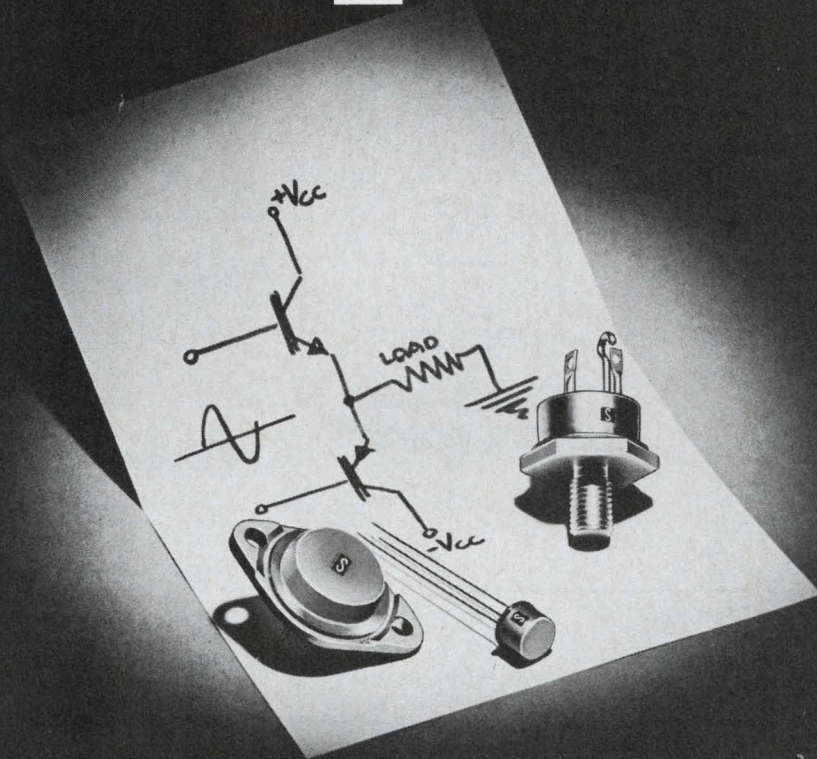

PNP SILICON POWER Transistors with Collector Currents up to 10 AMPS!

DIAL 1-800-327-3243 FOR A "NO CHARGE"
TELEPHONE CALL AND FURTHER INFORMATION

When you think of semiconductors...think Solitron!

Solitron
DEVICES, INC.

1177 BLUE HERON BLVD. / RIVIERA BEACH, FLORIDA / (305) 848-4311 / TWX: (510) 952-6676

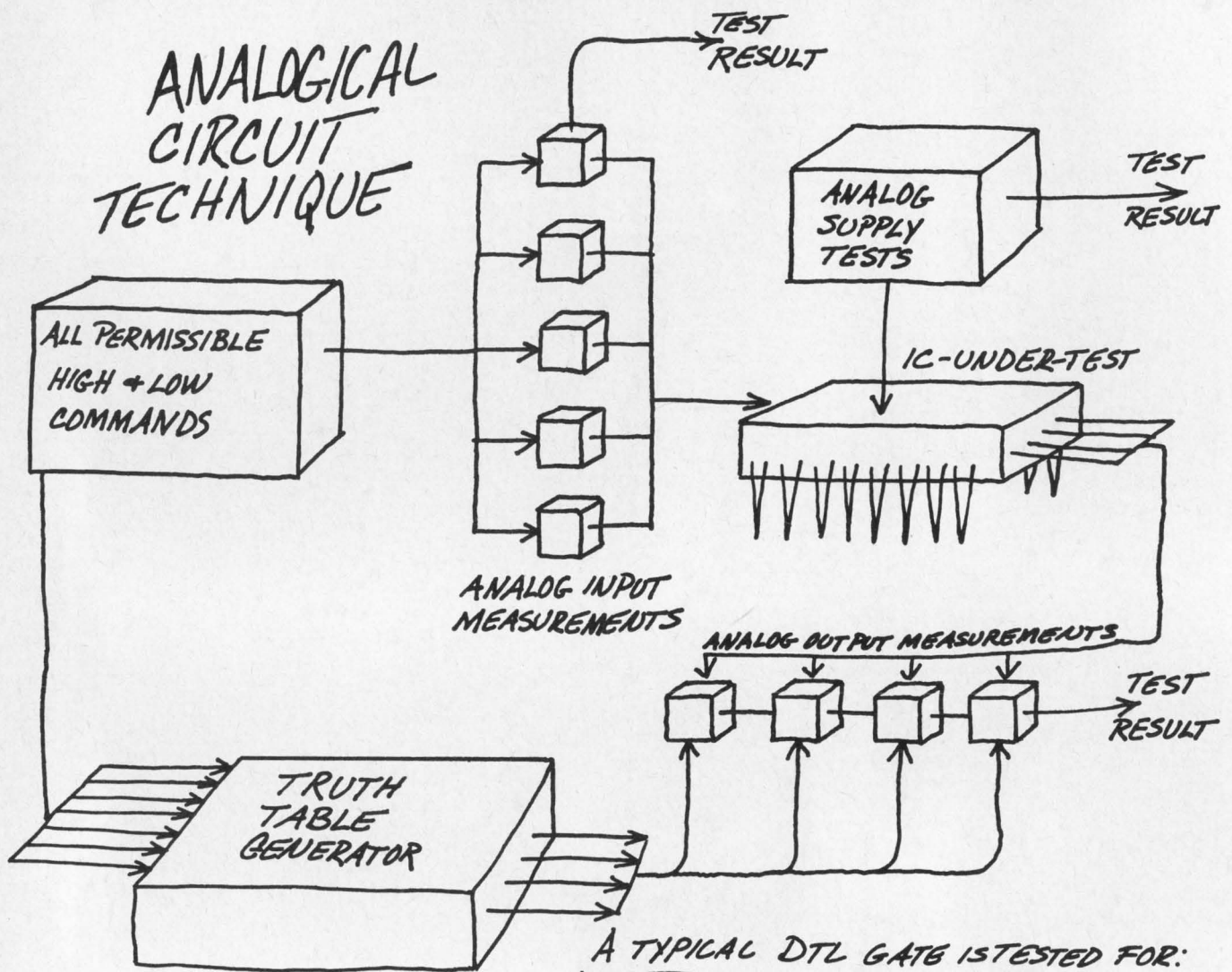

A TYPICAL DTL GATE IS TESTED FOR:

$I_{IN HI}$	5.1 mA MAX @ 4.1 V
$I_{IN LO}$	1.1 mA MAX @ 1.1 V
$V_{OUT HI}$	2.6 V MIN @ 0.12 mA
$V_{OUT LO}$	0.45 V MAX @ 12.0 mA
I_{CC}	16 mA MAX @ 5.0 V

Intriguing, isn't it, this new way of testing digital integrated circuits?

Now you can make sure ALL of your ic's will work — because you can make both parameter and functional tests simultaneously, and for all permissible combinations of inputs. □ It's done by exercising all the LOGICAL inputs on the ic-under-test and selecting the appropriate ANALOG measurements that should be made. 5,000 such measurements are made in 1/100 of a second.



□ Even more exciting, our Analogical Circuit Technique is available on a little machine that weighs only 25 lbs. It's a cinch to program, and costs only about \$5,000. □ We call it ACT 1 (because of the fortunate acronym). □ To learn more about analogical testing, just write: ACT 1, Teradyne, 183 Essex Street, Boston, Massachusetts 02111.



COMPONENT CAPSULES

New low-cost triode
for airborne
oscillators and amplifiers

We designed it specifically for the 1090 megahertz master-oscillator power amplifier function in the AIMS APX-72 tri-service IFF-ATC transponder. But it's also a natural for new tunable DME designs and/or for broadband amplifiers in the 1025-1150 megahertz range. It easily meets all their size, weight, shock and cost requirements. You can depend on Y-1537's to operate at power levels well above the specified minimum of 500 watts. **Circle Number 90.**

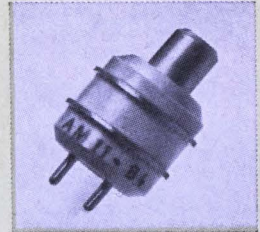

Actual size GE Y-1537
planar ceramic triode

And another
GE transistor line
goes epoxy.
Result: Cost savings
up to 50%



GE D33 transistor—
shown actual size

No loss in performance. No change in electrical characteristics. Latest group to make the switch is our GE line designed for high grade and critical, industrial and military applications. Several series choices, too. Among them: the D33A general purpose amplifier; D33B (2N3973-76, 2N4951-54) medium current, general purpose switch/amplifier/driver; D33D high gain driver; D33E (2N3605-07, 05A, 06A) high speed digital switch; D33G (2N5029, 30) low current, high speed digital switch; D33K high current core driver and medium current, high speed switch; and D33L low voltage, very high speed switch. Seen our latest epoxy transistor reliability story? Order a copy now. **Circle Number 91.**

150-grid relays
now rated 2 amps . . .
now come in 4 forms

That's right. We've doubled our 150-grid relays' current ratings from 1 amp to 2. And now there are four forms to choose from—the 2 Form C, 4 Form C, 4 Form C AND logic, and the 50 mW 1 Form C (or 1A + 1B). All 150-grid relays are just 0.32" high. Take advantage of the space-saving size and get performance as good or better than much larger mil spec relays. **Circle Number 92.**

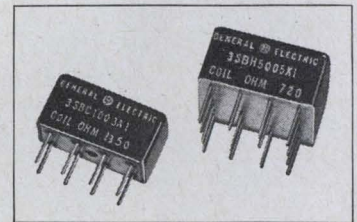

Actual size

Proved:
In-circuit reliability
for military uses

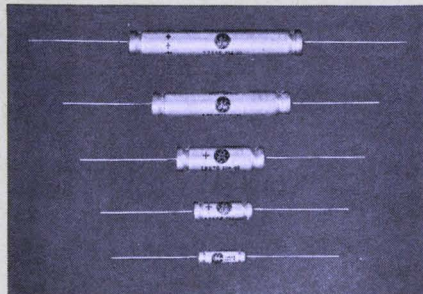

GE tantalum capacitors

More than 20 million GE tantalum foil capacitors have already been applied. They are designed to withstand unsuspected voltage reversals and are self-healing. Low impedance circuits or catastrophic failures are no problem with GE tantalum foils. Ratings are available up to 450VDC, 0.15 to 3500 μ f —55C to 85C, or 125C with voltage derating. For all the facts on these capacitors, **Circle Number 93.**

WE MAY NOT OFFER EVERYTHING YOU WANT FROM ONE COMPONENTS SUPPLIER. BUT WE DO COME A LITTLE CLOSER THAN ANYONE ELSE.

GENERAL  ELECTRIC

*"The secret of success in life...
is for a man to be ready for
his opportunity when it comes."—Disraeli.*

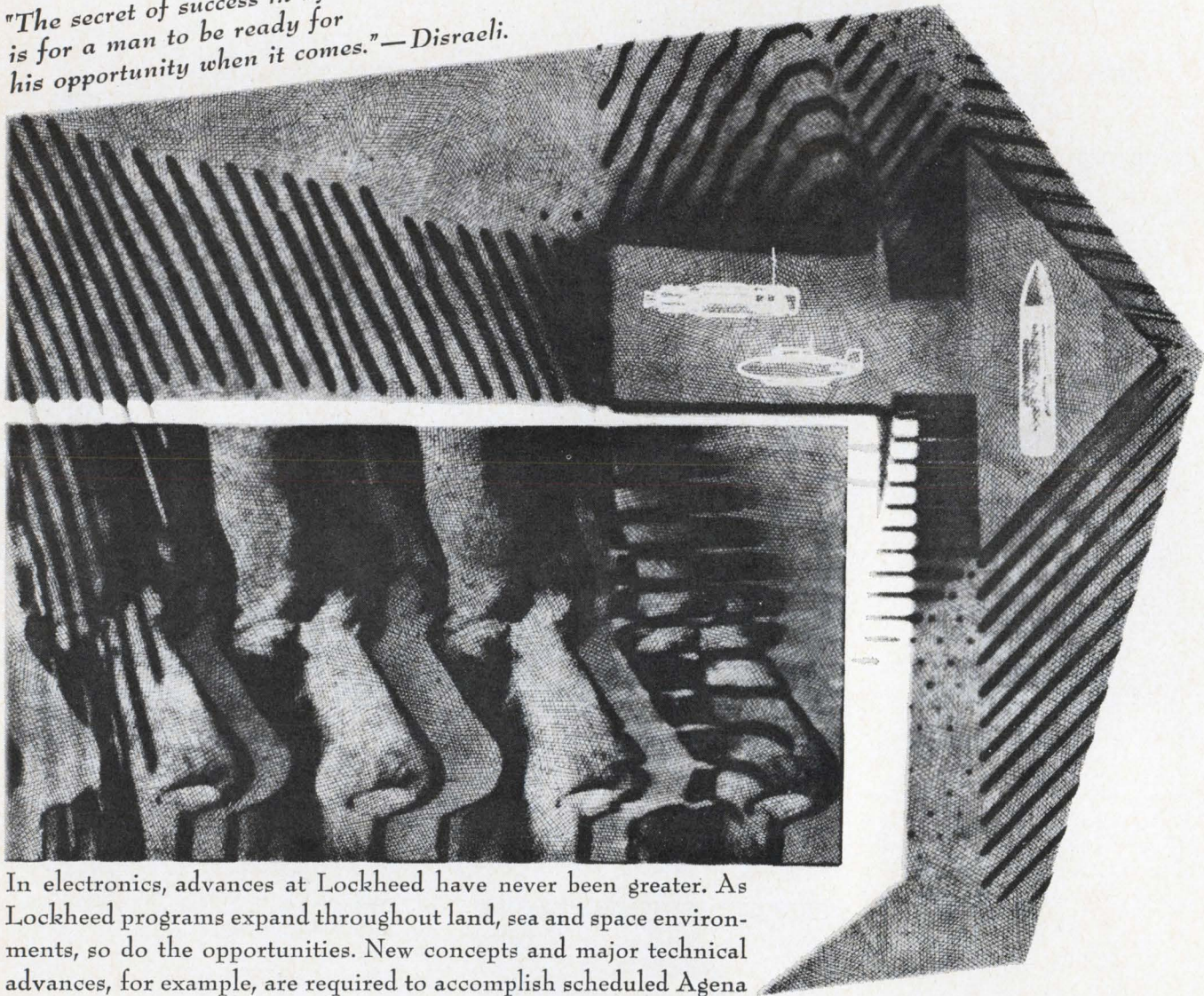

In electronics, advances at Lockheed have never been greater. As Lockheed programs expand throughout land, sea and space environments, so do the opportunities. New concepts and major technical advances, for example, are required to accomplish scheduled Agena flights in years to come—new approaches in digital communication systems for data transmission and command, optical and infrared sensors, solar power panels, power conditioning, digital and analog flight control systems. The number one deterrent force of the future—the Poseidon fleet ballistic missile—requires advances in postulation, establishing requirements, integration, design and use of electronics test and checkout equipment. While on land, advanced vehicle systems and hospital information systems pose unique problems. Undersea, Lockheed offers programs like the Deep Submergence Rescue Vehicle and ocean mining with fresh opportunities in such areas as undersea instrumentation. For more information, write Mr. R. C. Birdsall, P.O. Box 504, Sunnyvale, California 94088. Lockheed is an equal opportunity employer.

LOCKHEED
MISSILES & SPACE COMPANY
A GROUP DIVISION OF LOCKHEED AIRCRAFT CORPORATION

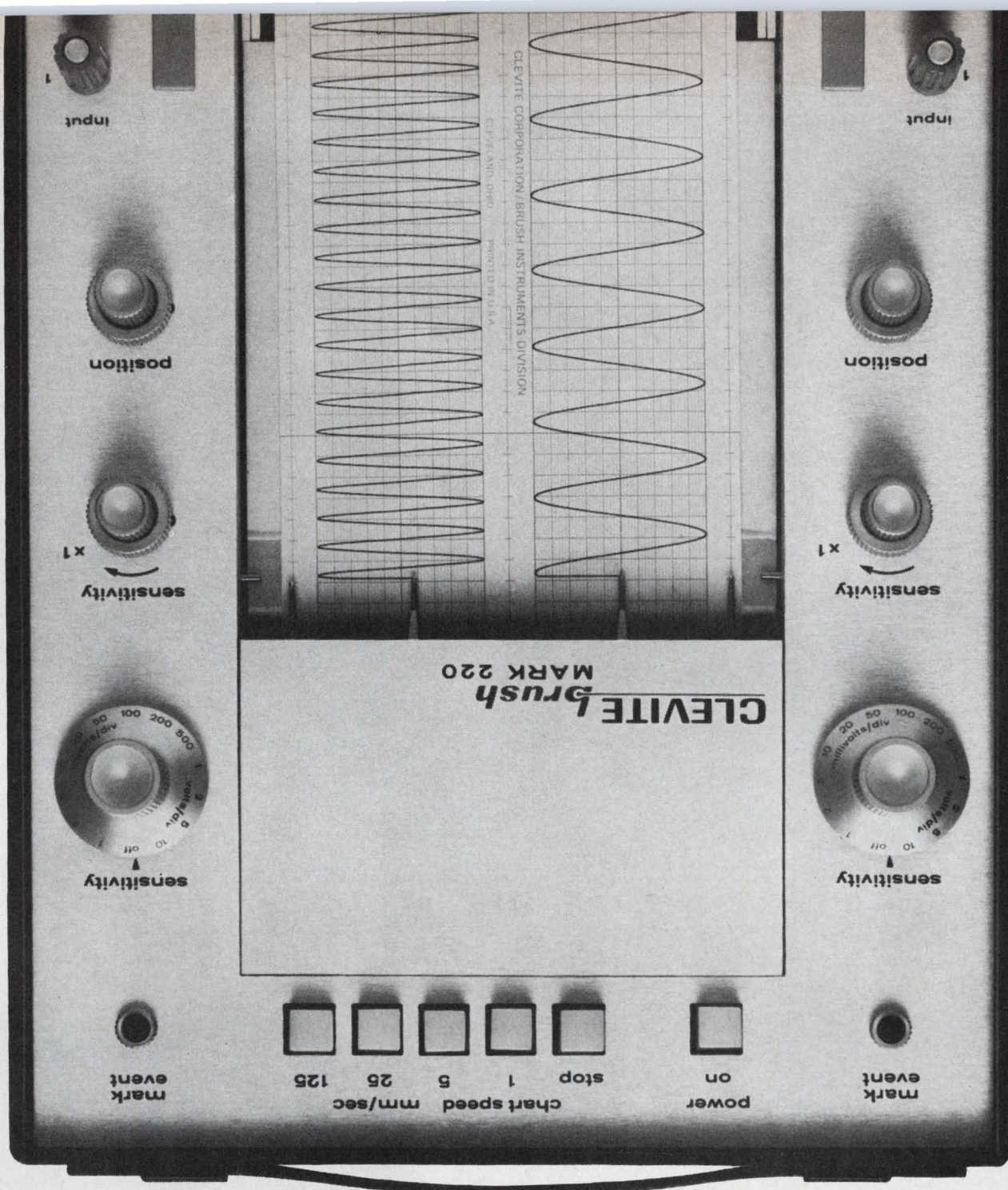

Write-side up?

Why not? New Mark 220 by Brush features pressurized-ink writing. Puts trace into the paper . . . not just on it. And you can see you don't have to pamper it! Now, anyone can take this remarkable new 25 lb. portable *anyplace*, plug it in . . . and put it in writing. And what writing! Fine, sharp traces you can read at a distance—99½% accurate! Rectilinear writing, of course, on two easy-to-read 40mm analog channels plus left and right-hand event markers. And there's enough ink in the throw-

away ink cartridge to last for about a thousand miles. There's more. Rugged, reliable solid state electronics to give you position feedback pen control . . . no springs, no strings. Pushbutton choice of chart speeds. Frequency response that's flat ($\pm 2\%$) from d-c to 40 cps at 50 div, or from d-c to 100 cps at 10 divisions. The price? Less than \$1700. For a portable chart recorder the likes of which you've never seen! Bulletin 942-1 has all the details. Call or write: Clevite Corporation, Brush Instruments Division, 37th & Perkins, Cleveland, Ohio 44114.

brush CLEVITE
INSTRUMENTS DIVISION

Circle 169 on reader service card



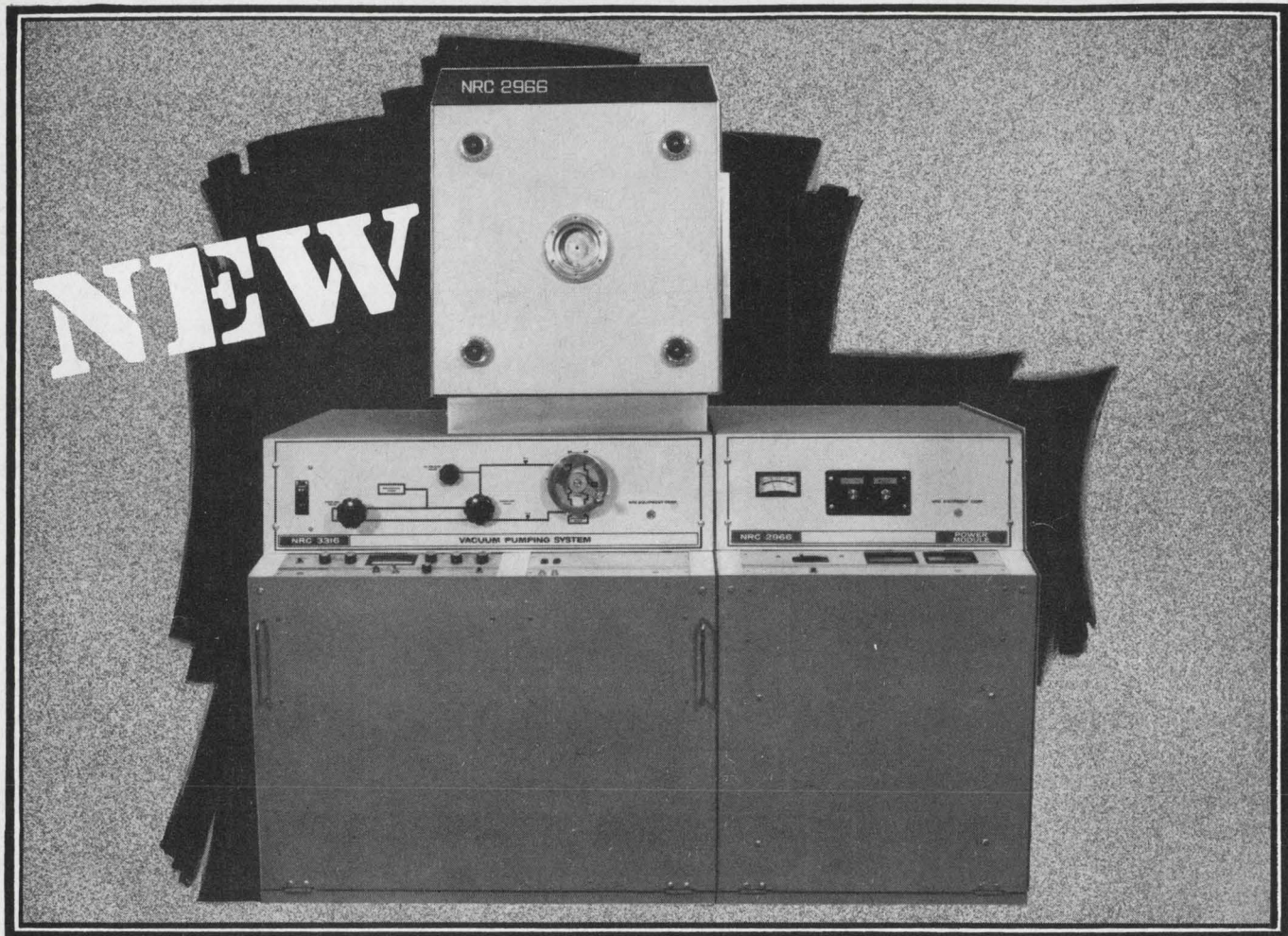

A Furnace for ALL REASONS

FOR: Degassing
 Brazing
 Sintering
 Melting
 Hardening
 Annealing

IN: Vacuum
 Inert Environments
 Reducing

BY: Electronics
 Aerospace
 Nuclear
 Research
 Metallurgical
 Chemical

INDUSTRIES

NOW . . . a multi-capability, high-temperature, vacuum furnace providing tailor-made performance at standard equipment prices. Modular construction enables selection of:

- pumping system
- chamber size
- power supplies
- heater assemblies
- instrumentation

Write today for information on the NEW NRC 2966 vacuum resistance furnace.



EQUIPMENT DIVISION
 NATIONAL RESEARCH CORPORATION
 A SUBSIDIARY OF NORTON COMPANY



160 Charlemont Street, Newton, Massachusetts 02161



We learned it just like this youngster is learning it... only we have a 50-year jump on him.

Take one of our hottest new assignments: Develop and manage the Navy's Integrated Light Attack Avionics System (ILAAS). It's the first integrated system approach to fixed-wing aircraft avionics. Our responsibility: Define system requirements. Develop the technology. Establish specs. Award subcontracts. Integrate and test completed systems. Deliver the prototype this year.

It's taken a lot of innovative systems engineering. And a lot of pioneering work in program management techniques.

The result: Sperry Systems Management Division has the know-how and know-where to develop and deliver systems or sub-systems that can integrate a variety of key electronic functions for tactical, strategic and ASW aircraft or supersonic transports. Functions like weapons delivery, navigation, flight control, displays, communications.

If this is the kind of demonstrated systems management skill your program requires, seek out the group that can deliver reliable, maintainable equipment, on time, within cost and performance specs. Just write: Marketing Manager, Advanced Avionics. Or phone: (516) 574-2216.

SPERRY
SYSTEMS MANAGEMENT DIVISION
GREAT NECK, NEW YORK 11020

**Know how Sperry learned about
advanced avionics systems management?**

From the ground up.

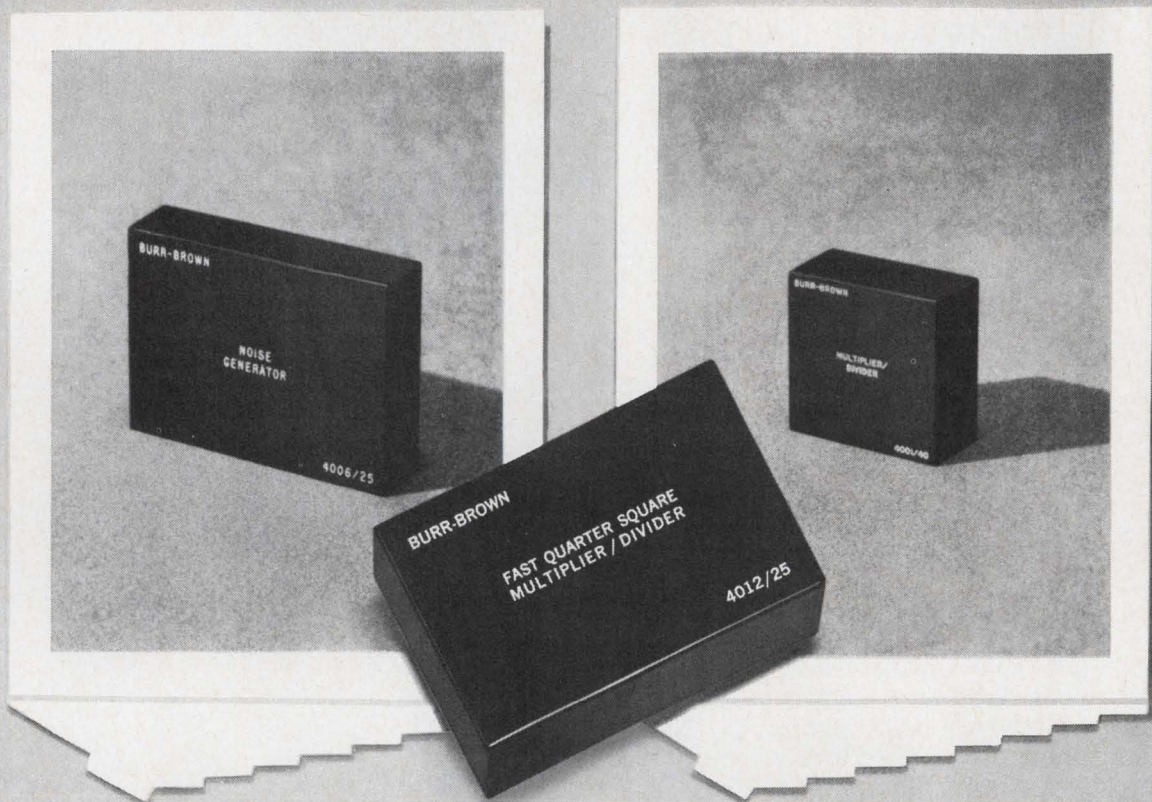

for Instant Analog Systems

Burr-Brown Encapsulated Function Modules

Cut costs, simplify design, and achieve maximum performance from your analog and hybrid circuits by utilizing Burr-Brown encapsulated function modules. These compatible sub-systems are designed to mount and work side by side with operational amplifiers. You save money on component and assembly costs, design time is reduced to an absolute minimum, and you gain the performance advantage of Burr-Brown's specialized experience in analog applications.

Currently, Burr-Brown is supplying fifteen 10V, encapsulated function modules from stock. Each one provides the type of performance you'd expect from the company that "wrote the book" on operational amplifier applications. Available units include: Quarter Square Multiplier — Fast, $E_o = -E_i E_x / 10$. Squaring Modules —

Four separate units are offered. Noise Generator — Random digital output. Logarithmic Amplifiers — Both 40 db and 60 db log units. Adaptive Analog Comparator — Switched hysteresis. Electronic Switches — Including Fast Sample/Hold, Sample/Hold, Integrate/Hold, and Reset/Integrate/Hold units.

Rack Mounting Units — For your rack-mounting applications, Burr-Brown offers fourteen modules. These pre-engineered circuits are ready for you to plug in, wire together, and put to use immediately.

FOR COMPLETE INFORMATION on these maximum value units, contact your nearest Burr-Brown Engineering Representative and ask him for a copy of the new 20-page Burr-Brown catalog. He also has demonstrator units available for your immediate evaluation.

BURR-BROWN

RESEARCH CORPORATION

International Airport Industrial Park • Tucson, Arizona 85706
TELEPHONE: 602-294-1431 • TWX: 910-952-1111 • CABLE: BBRCORP



Operational Amplifiers
Instrumentation Amplifiers
Function Modules
Analog Simulators
Geophysical Instruments

ENGINEERING REPRESENTATIVES: ALABAMA, HUNTSVILLE (205) 534-1648 / ALASKA, ANCHORAGE (907) 272-5231 / ARIZONA, PHOENIX (602) 254-6085 / CALIF., LOS ANGELES (213) 665-5181, SAN FRANCISCO (408) 245-3321 / COLO., DENVER (303) 388-4391 / CONN., ENFIELD (203) 749-7888 / D.C., WASHINGTON (SEE MARYLAND) / FLORIDA, ORLANDO (305) 425-2764 / ILLINOIS, CHICAGO (312) 286-6824 / LA., NEW ORLEANS (504) 888-2266 / MD., SILVER SPRING (301) 588-8134 / MASS., BOSTON (617) 245-4870 / MICH., DETROIT (313) 353-3822 / MINN., MINNEAPOLIS (612) 781-1611 / MO., ST. LOUIS (314) 524-4800 / N.C., GREENSBORO (919) 273-1918 / N.J., CAMDEN (215) 925-8711 / N.M., ALBUQUERQUE (505) 255-1638 / N.Y.,

ALBANY (518) 436-9649, BINGHAMTON (607) 723-9661, MT. VERNON (914) 968-2200, NEW HARTFORD (315) 732-3775, ROCHESTER (716) 473-2115 / OHIO, CINCINNATI (513) 761-5432, CLEVELAND (216) 237-9145, DAYTON (513) 277-8911 / OKLA., TULSA (918) 835-2481 / OREGON, PORTLAND (503) 292-8762 / PENN., PHILADELPHIA (SEE CAMDEN, N.J.), PITTSBURGH (412) 243-6655 / TEXAS, DALLAS (214) 363-1671, HOUSTON (713) 928-5251 / UTAH, SALT LAKE CITY (801) 466-3709 / VIRGINIA, (SEE MARYLAND) / WASH., SEATTLE (206) 767-4260 / CANADA, TORONTO (416) 293-7011, VANCOUVER (604) 736-6377



EE'S

with military communications
equipment experience

call us collect

area code 317/459-2808

Rapid expansion of our ground based and airborne military communications capability has created urgent requirements for electrical engineers (B.S. or M.S.) at Delco Radio.

Opportunities at all levels—beginning, through supervisory, with 2-10 years experience—in the following areas:

Digital communications in the HF, VHF, and UHF bands

Single side band design, HF, and VHF

Frequency synthesizer techniques in all frequency ranges

Wide range electronic tuning

Retransmission techniques

Secure communications techniques

Man-portable and vehicular battle area communications equipment

Acoustic transducers, antennas, and micro-electronics applications.

Call us collect for an interview or more information. Area Code 317/459-2808. Ask for C. D. Longshore. Or send your resume to Mr. Longshore, Supervisor, Salaried Employment, Dept. 204, Delco Radio Division of General Motors, Kokomo, Indiana.

DELCO RADIO

DIVISION OF GENERAL MOTORS • KOKOMO, INDIANA

An equal opportunity employer



Don't fight IC's... join them with thick film interconnections

We don't live in a world of EITHER/OR. To spend our time arguing whether silicon integrated circuits will or will not be low cost is not productive. The answer is already clear—they will be low cost. The questions are how low and how soon.

May we suggest that there are a number of other matters which deserve attention, like—what kind of circuit board—what type passive components—what packaging technique will be needed when IC's are in the economic ball park. If you'll pardon our brashness, we feel you should think of your own system.

Is there a packaging, circuit boarding, interconnecting, or outboard component system which lets you use today's active device configurations, yet is versatile enough to incorporate the next generation of technology too? We think thick film circuit and packaging systems will give you that kind of security.

After all, what other circuit technology allows you to bond active devices by parallel gap welding, thermo-compression bonding, direct and reflow soldering, ultrasonic bonding, precious metal brazing? Allows you to use conventional leads, flip chips, leadless inverted devices, beam leads, or most any other configuration that you can conceive?

If you're thinking about using IC's, think about what else you need. Ask your own experts where your company stands.

**E. I. du Pont de Nemours & Co. (Inc.),
Electronic Products, Electrochemicals Dept.
Wilmington, Delaware 19898**



Better things for better living...through chemistry

you get a choice,

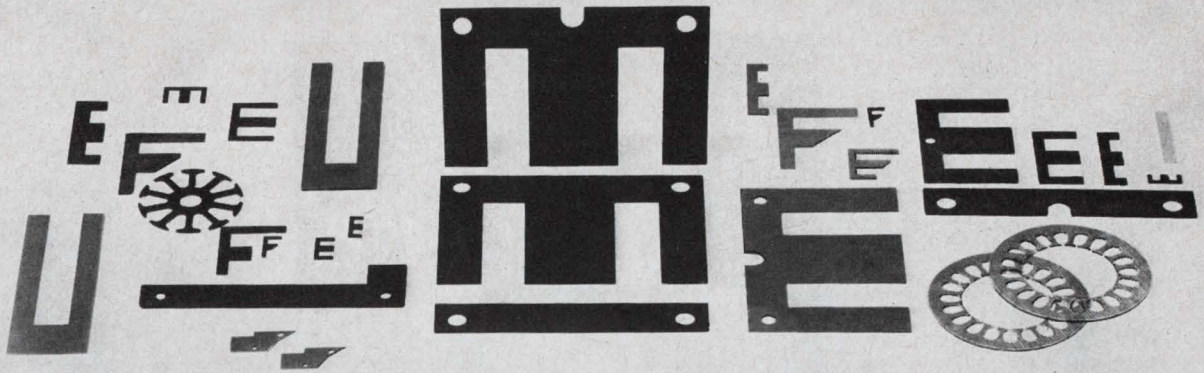

not a challenge

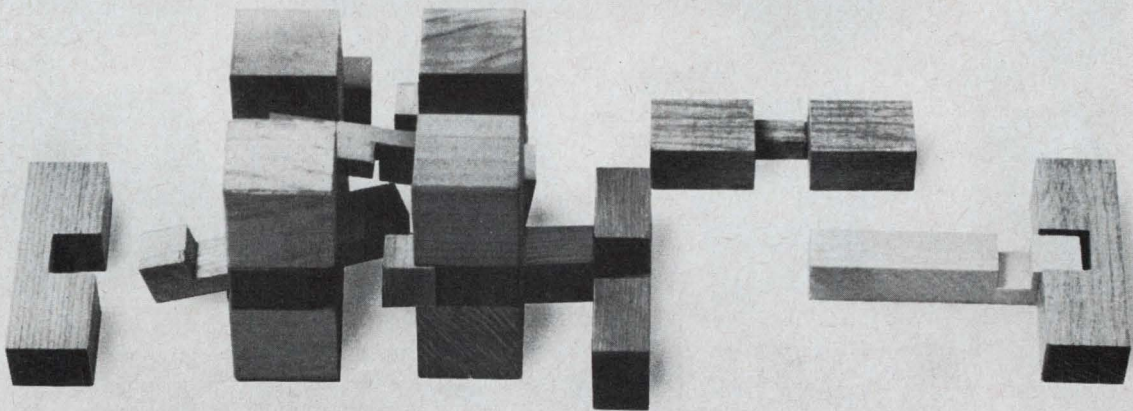

**51 standard shapes of laminations
simplify solid-state circuit design**

Magnetics maximizes your chances of finding laminations that dovetail precisely into your designs for transformers, chokes, reactors and transistor circuits. We offer 51 standard shapes in Permalloy 80, Alloy 48 and Orthonol®. Thicknesses of 0.004", 0.006", and 0.014" are available, with sizes ranging from DU-87 and EI-12 down to the

solid-state circuitry sizes—EI-093, EE-30-31, DU-63 and F-094.

All Magnetics' laminations are hydrogen-annealed and manufactured to guaranteed minimum permeability limits. In addition to the catalog shapes and sizes, we have the capability to make special shapes to fit specific needs, including rotors, stators and recording head laminations. Our photo-etch process is ideal for making

prototype-run laminations and small intricate configurations.

Furnishing a broad spectrum of shapes, sizes and materials is Magnetics' way of saving you valuable design time—we believe in giving our customers a choice, not a challenge. Complete information on Magnetics' laminations can be had by writing today for our Catalog ML-303-R, Magnetics Inc., Butler, Pennsylvania 16001



THESE CIRCUIT PROTECTORS ARE ENTIRELY MAGNETIC TRIP

Hermetically sealed AP Protectors meet or exceed MIL-C-39019. They repeatedly rupture 300A 250V AC, 500A 125V AC, 500A 50V DC, have magnetic time delay, but open a 1000% overload in 4 milliseconds. There is no trip at 100G shock or 20 G vibration, carrying rated current. Available 10 MA to 20A, with a wide variety of circuit combinations, delay curves and auxiliary signal circuits. Ask for bulletin 16E-4.

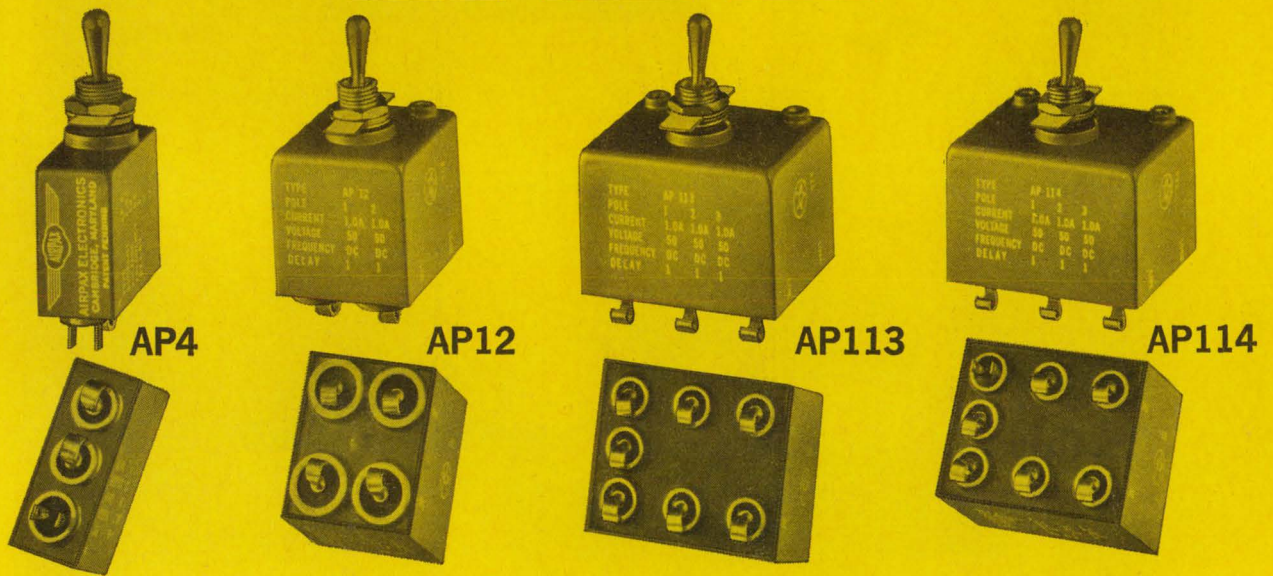
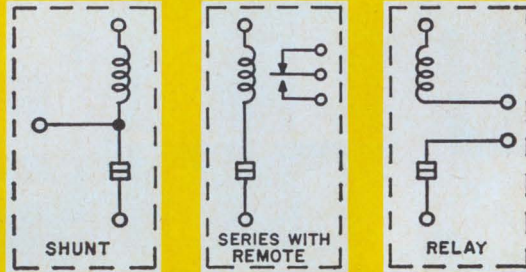

Type UPL1, UPL11, and UPL111 are Underwriters' Laboratory recognized for appliance protection.

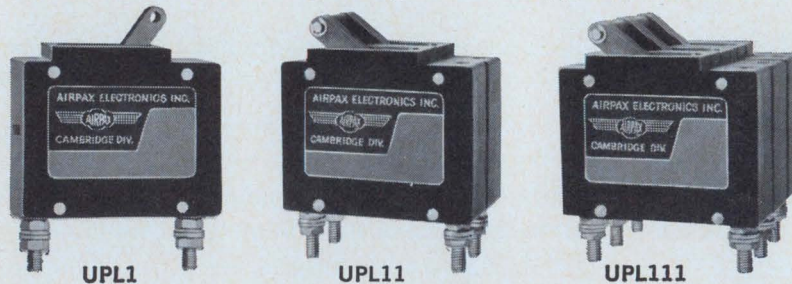

UL RATED at:

.050-50.0 Amps, 50V DC.; .050-50.0 Amps, 120V AC, 60 Hz.; .050-20.0 Amps, 240V AC, 60 Hz.

Series units with enclosed remote switches are available in any combination of delays (Fast — 0.4 to 4.0 sec., Slow — 4.0 to 40 sec., Motor Start — 1.0 sec. at 600%) or UL listed ratings are available in a single pole, two pole or a three pole appliance protector.

AIRPAX ELECTRONICS Cambridge, Maryland 21613 (301) 228-4600

New Products

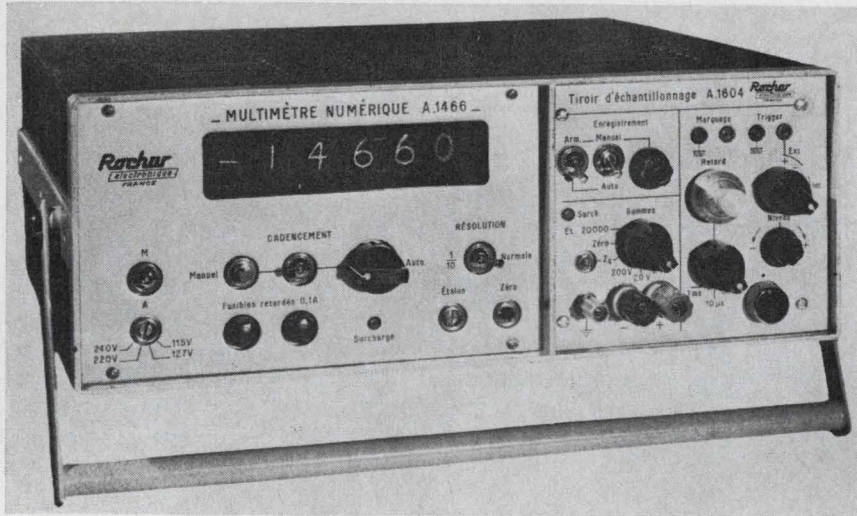

New instruments

Digital voltmeter dissects waveform

Plug-in makes instrument act like sampling oscilloscope but gives peak values; waveforms can be put on recorder

By C. Picot

Rochar Electronique Division, Societe d'Instrumentation Schlumberger, Paris

At what precise input point did the transistor's performance change?

A design engineer can see it on an oscilloscope, but this does not give him the input value quantitatively. To achieve this result, the measuring techniques of sampling and storage—used extensively in scopes—have been incorporated in a plug-in module for digital voltmeters. The resulting instrument provides the absolute measurement, in the form of a digital readout, which is not possible in a scope.

The plug-in enables the digital voltmeter to make quick, accurate measurements of the peak ampli-

tude of any waveform at any point on the waveform.

The instrument was built by Rochar Electronique, a member of the Schlumberger group, for French semiconductor companies, to make precision pulsed-saturation measurements of transistors. However, its application should increase because of two important features: it can be synchronized with the input signal, and the time between synchronization and sampling can be adjusted.

Select sampling. The plug-in, designated model A1604, operates as an oscilloscope does, but instead

of trying to determine the amplitude of a waveform by observing its trace on a cathode-ray tube, it is now possible to vary the plug-in's sampling time and make point-by-point measurements of the waveform with a digital voltmeter. The instrument can also be used to reproduce the measured waveforms on an x-y recorder. Usually, signals above 100 hertz cannot be reproduced this way because mechanical pens can't respond fast enough.

Since the instrument's sampling time is only five microseconds, it can be used to measure the outputs from a multichannel selector or scanner. This is because the short sampling time of the unit enables measurements to be made that are unaffected by such things as contingent switching edges.

I. Synchronized gating

In operation, as a signal is applied to the input, a gate opens for a specified length of time to allow a sample to be taken. The sample signal charges a capacitor to some specific voltage. After sampling, the gate closes and the capacitor voltage is measured by a digital voltmeter. The capacitor is then discharged and the process repeated as needed.

Besides sampling and storage circuits, the unit also includes all circuits necessary for defining the sampling time—the circuits for synchronizing the input signal and a time delay that varies in relation to synchronization—the circuit to control the sampling operation, and circuits to provide outputs for an x-y recorder.

The resistors R_1 , R_2 , and R_3 controlled by switch S_{1a} define the input impedance for the corresponding range. The resistors R_5 and R_6 set the gain of the first amplifier A_1 . Diodes D_1 and D_2 , in parallel with R_5 , limit the output voltage applied to the gate and prevent saturation of the tester. Diodes D_3 and D_4 protect the amplifier against

... field effect transistor presents a practically infinite impedance to capacitor ...

excessive input voltages.

Approaching the infinite. The gate, which uses a field effect transistor, is between the input circuit and a storage capacitor and presents a practically infinite impedance to the capacitor when closed. The amplifier A_2 has a differential input stage consisting of a double FET. Thus the parasitic input current is low and the storage capacitor C discharges negligibly when a measurement is made by the associated digital voltmeter.

Synchronization control can be external or internal and is selected by switch S_2 . When it is internal, the attenuator formed by R_7, R_8, R_9, R_{10} is switched by S_{11} , simultaneously with changes in the mea-

surement range. A third position of S_2 makes recurrent sampling by the internal time-device or the clock of the digital voltmeter.

II. Ramp control

The internal or external synchronization signal drives a trigger. Switch S_3 selects a positive or negative control signal from the ramp generator corresponding to whether synchronization is to take place on the positive or negative edge of the input signal. A normally opened gate is between the trigger and the ramp generator. When triggered, the gate's output voltage varies until it reaches one of the reference voltages, in this case V_1 . At this time the first comparator reverses.

When the ramp generator's output voltage reaches V_2 , the second comparator reverses.

The second comparator drives a monostable multivibrator that inhibits the signal from the trigger by closing the gate. The second multivibrator also controls the return of the ramp and resets both comparators. The reversing time of of this multivibrator is selected so that it protects the ramp generator from being damaged by a control signal when the ramp is being reset.

As the first comparator reverses, it starts the first multivibrator. This defines the sampling time and opens the sampling circuit's gate.

The calibrated time delay is obtained by varying the slope of the ramp initiated from the ramp generator at the time synchronization starts. Since the reference voltage V_1 is fixed, the reversing time of the

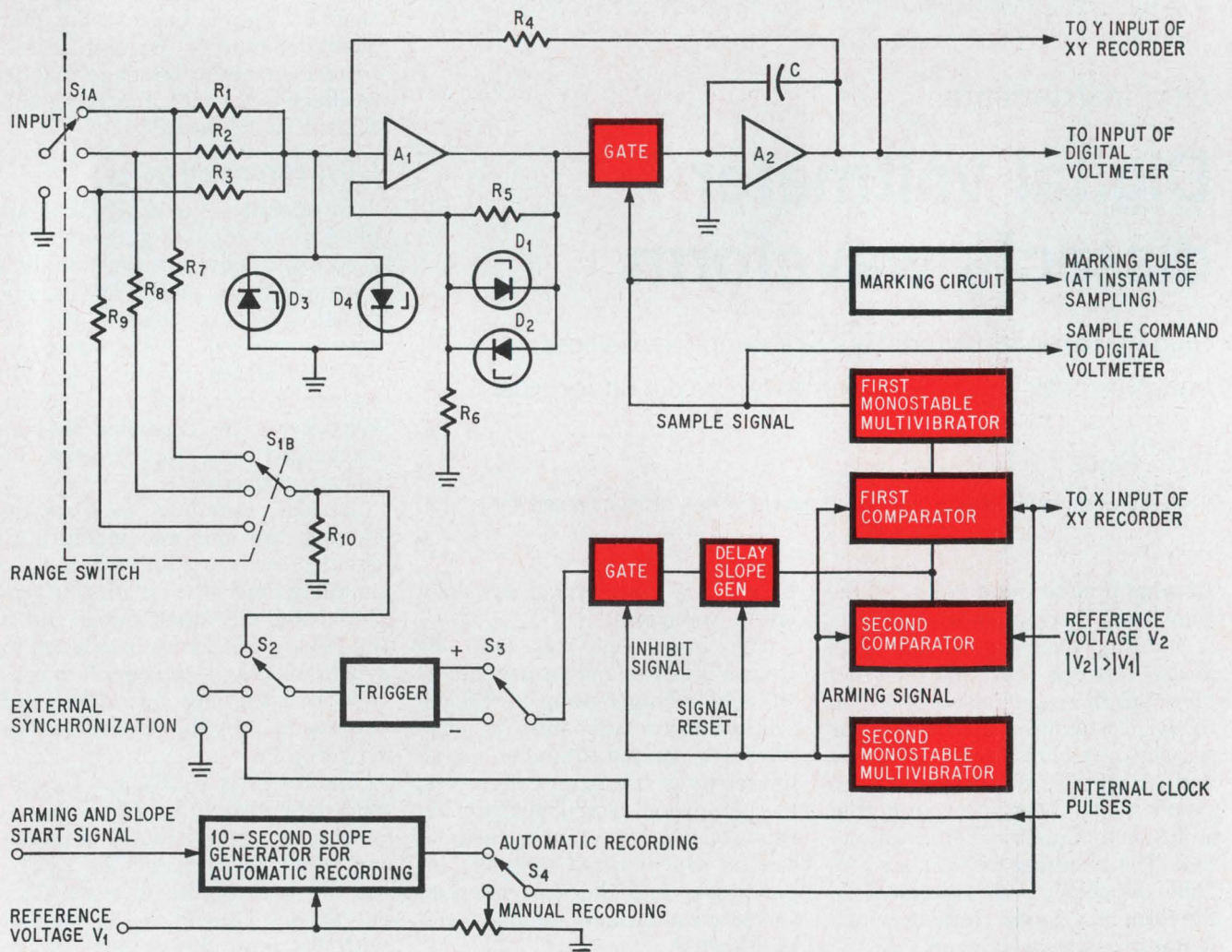

Command measurement. Input signal charges capacitor C when sample gate is opened. When the gate closes, the voltage on the capacitor is read by the digital voltmeter. The sampling command is synchronized to the input signal or an external source. A plot of the measurements can be made by connecting an x-y recorder to dvm. Unit handles up to 200 volts.

In Making Masks for
Electronic Components...
...there's no
Margin for Error!

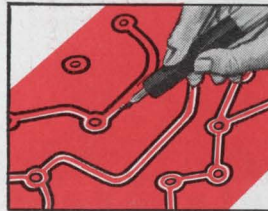

With sharp blade, outline the areas to be masked. Do not cut through the backing sheet. The Ulano Swivel Knife does the job quickly, easily.



Now carefully peel off the film as outlined leaving a completed photo mask, positive or negative, that corresponds exactly to the desired pattern.

**THAT'S WHY EXPERIENCED DESIGNERS
AND ENGINEERS ALWAYS INSIST ON...**

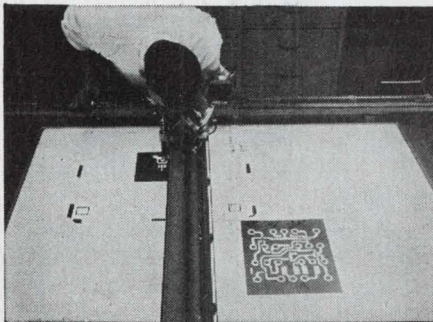

RUBYLITH™

HAND-CUT MASKING FILM FOR THE GRAPHIC ARTS

**THE KNIFE-CUT, LIGHT-SAFE MASKING FILM
LAMINATED TO A STABLE POLYESTER BASE**

The most versatile line of hand-cut masking films, including

**.0075—RUBYLITH 75 DR* .005 RUBYLITH 5 DR
.005 AMBERLITH 5 DA**

These new, thick Ulano films provide the positive answers where exact register assumes a critical importance.

**Available in sheets only, cut to your specifications.*

by

Ulano™

ulano™

610 DEAN STREET, BROOKLYN, N.Y. 11238

NEW YORK • CALIFORNIA • CHICAGO • ZURICH

In Europe: ULANO A. G., Untere Heselbachstrasse 22, Kusnacht 8700, Switzerland

Write on your letterhead for special electronic test kit (no charge) No. 4148

You're a year behind the times if you think our RF1 vacuum relay is just for the communications industry.

Sure our RF1 vacuum relay is ideal for such typical communications uses as antenna switching and band switching. But in the year since it was introduced this remarkable little relay has proven itself in a multitude of markets and in applications where vacuum relays had never been considered.

Ounce for ounce, the RF1 controls more power for more applications than any other relay in the world. It's replacing mercury wetted contacts for switching in capacitor circuits for protection on arc lamps. It's used for circuit control aboard railway locomotives and in automated remote control systems for controlling locomotives. It's also controlling power supplies in laser range finders and making millisecond tuning possible in digitally tuned transmitters, logic circuit all-electronic tuning and

binarily tuned HF radio transceivers.

We could go on and on about the merits of these 3/4-ounce relays with their superclean contacts. They cost no more than other relays of their power level, but look at their performance: 4 kv peak 60 cycle test voltage • 2 kv peak operate voltage at 16 mc • 4 amps rms at 16 mc • Interrupt 1 kw dc power; interrupt inductive loads • .020 ohms maximum contact resistance at 32 mc remains permanently low • 10 g to 2000 cps vibration resistance • Impervious to environmental conditions • Rapid operation (10 ms maximum).

For complete information on the RF1 and a copy of our new vacuum relay catalog, write to ITT Jennings, a division of International Telephone and Telegraph Corporation, 970 McLaughlin Avenue, San Jose, California 95108

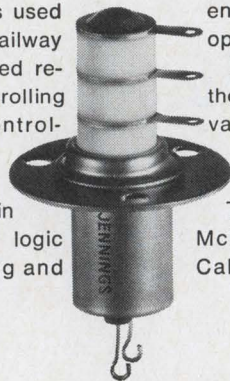

Shown actual size

JENNINGS **ITT**

... first multivibrator initiates measurements ...

first comparator, which controls sampling, is delayed with respect to the time of synchronization.

When the first comparator reverses it also produces a marking pulse to enable observation of the sampling time with reference to the signal. Also, the first multivibrator initiates the measurement by the digital voltmeter of the voltage sampled and stored.

Switch S_4 is used to select the recording mode—manual or automatic. During manual recording, the voltage applied to the first comparator is varied manually from 0 to V_1 by potentiometer R_{11} . This corresponds to a range of calibrated time delays. In automatic recording the voltage applied to the comparator is varied linearly from 0 to V_1 during a long time, say 10 seconds, enabling the recorder to follow easily and with fidelity the shape of the input signal.

In both cases the voltage to be sampled is scanned from the point of synchronization to the point corresponding to the time delay. Therefore, the recording will be in a curve corresponding to the voltage variation between these two points.

A matter of shape. There are certain restrictions on the A1604. While it is not possible to define a general frequency limit, measurement does depend on the shape of the signal. It is necessary that the variations of the voltage measured during the sampling time be lower than the desired accuracy. Also, it is important that the delay between the edge of a rectangular signal and the beginning of sampling be at least 10 microseconds. Therefore, for a square wave, the maximum frequency is 30 kilohertz. For an asymmetrical rectangular signal the frequency can be higher.

If a measurement at one point on a sawtooth signal is desired, it is necessary that the voltage variation during the sampling be lower than 1/1000 of the maximum amplitude of the wave. Therefore the waveform's period must be higher than $1,000 \times 5 \mu s$ —corresponding to a frequency less than 200 hz.

At present the plug-in is designed

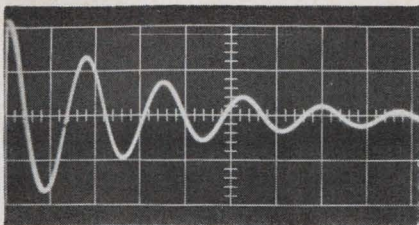

Studying damped sine wave. The maximum and minimum values of a damped sine wave such as that shown can be obtained by manually scanning the waveform. The time axis is calibrated from the delay control of the plug-in unit, enabling such typical characteristics to be calculated from these amplitude measurements as the logarithmic decrement, the decrement, the damping coefficient, the time constant, and pseudo-period.

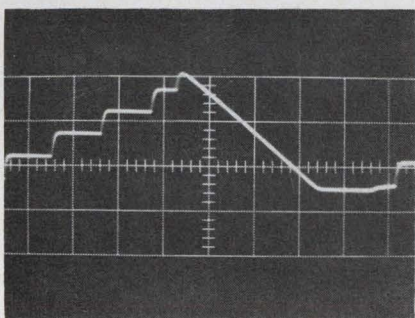

Voltage level tests. Plug-in is useful for checking stepped signals such as shown above, composed of a number of voltage levels that appear apparently flat on an oscilloscope. However, analyzing this signal with the plug-in by setting the sample delay times for the beginning and end of each step permits checking to determine whether the steps are in fact level.

to be used only with a digital voltmeter made by Rochar. However, it is being modified so that it will work with any digital voltmeter on the market now, as well as those that appear in the future.

Specifications

Input voltage	2, 20, 200 with a 5-digit display
Accuracy	$\pm 0.1\%$ of reading, $\pm 0.25\%$ of full scale
Input impedance	10 kilohms in parallel with 50 picofarads for the 2-v range, 100 kilohms in parallel with 20 picofarads for the 20-v range, 1 megohm in parallel with 20 picofarads for the 200-v range
Sampling time	5 μ sec
Time delay between synchronization and sampling	Adjustable continuously from 10 μ sec to 0.1 sec
Price	\$1,100

Rochar Electronique Division, Societe d'Instrumentation Schlumberger, Paris [338]

To turn off rejects of 3rd generation circuits:

Turn on Barnstead's New Micro-Cleaner

There's no better way to make micro-circuits come clean!

Barnstead's new microelectronic cleaning station provides an ultra-pure final rinse — in a totally clean environment — at minimum cost.

Write for Bulletin 211, describing this 3rd generation cleaning station.

Barnstead

Subsidiary of Ritter Pfaudler Corp.
516 Rivermoor Street
Boston, Mass. 02312

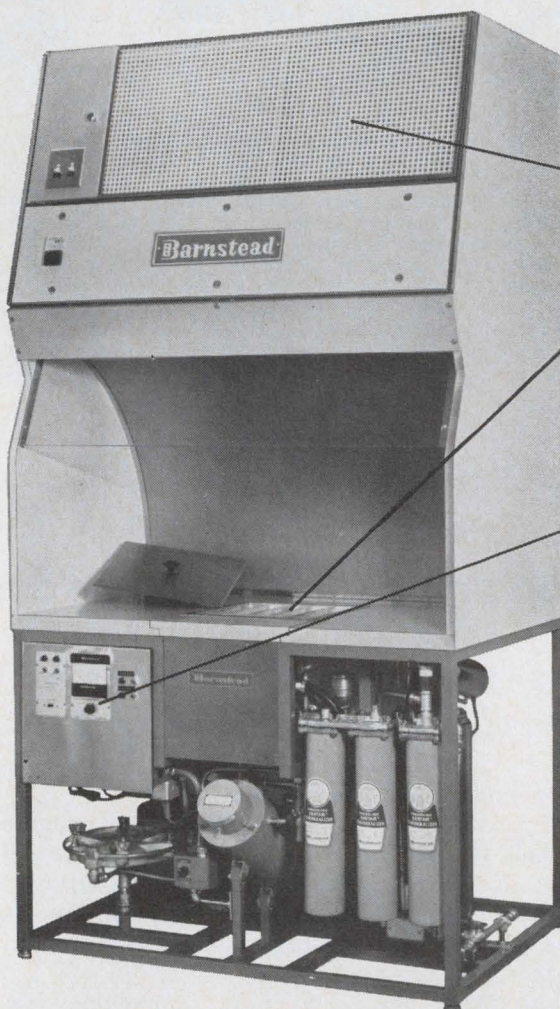

Positive-pressure hood keeps work area free of airborne contaminants, with absolute air filter, quiet, spark-free blower. Meets or exceeds applicable MIL SPECS.

Five hot, cascading pure water rinses in tinlined monel tanks do a thorough cleaning job. Final rinse, measuring 10 megohms/cm @ 25°C and free of organics, gases, biologicals — is much purer than demineralized water.

Purity meter checks quality of rinse water, both "upstream" and "downstream" from final rinse.

To make a few gallons do the work of thousands, water is continuously recirculated, repurified. System includes . . .

Demineralizer. Automatic still. Organic removal bed. 0.1 micron particle filter. Sump, protected by ultraviolet unit, Ventgard® air filter. Regenerative heat exchanger. Cuts electrical load by more than 50%

New Components Review

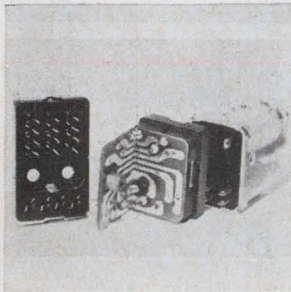

Relay sockets ST140-U1 and ST141-U1 are 2- and 4-pole models. They have a knife-type connector that provides security and eliminates flux contamination of contacts during machine soldering. Sockets are made of fiber-glass-filled polycarbonate with an insulation resistance of 1×10^9 ohms. American Zettler Inc., 697 Randolph Ave., Costa Mesa, Calif. 92626. [341]

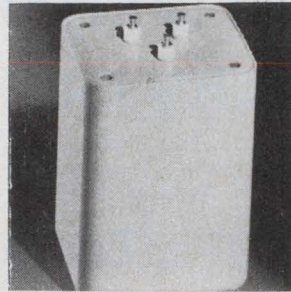

Constant-phase filters, with pass-band phase variation less than $\pm 0.3^\circ$, are for data system uses requiring the extraction of a pure harmonic from a complex wave without loss of phase relationship. Center frequencies of 100 hz to 500 khz are supplied with passbands of $\pm 5\%$ of center frequency. Electro-Mechanical Research Inc., Box 130, Van Nuys, Calif. 91408. [342]

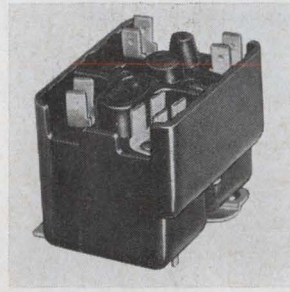

Quick-connect-terminal power relay type 129 is available as single-pole, normally open, and single-pole double-throw. Coils are rated at 6 v, 24 v, 120 v, 208/230 v (50/60 hz). Contacts are rated 18 amps continuous at 250 v inductive and 18 amps continuous resistive at 250 v. Controls Division, Essex Wire Corp., 131 Godfrey St., Logansport, Ind. 46947. [343]

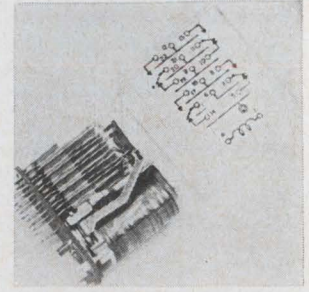

Instrumentation relay model R11 features a guarded construction that keeps the capacitance between contacts to a maximum of 0.150 pf. Relay contacts are rated to 200 ma with a thermal electromotive force of less than 1 μ v. Coil voltages range from 6 to 115 v d-c. Base price is \$9.60. Parelco Inc., 26181 Avenida Aeropuerto, San Juan Capistrano, Calif. 92675. [344]

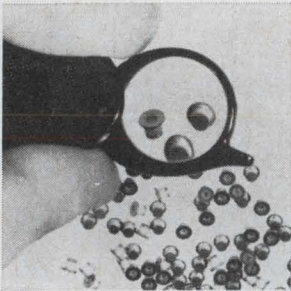

Ceramic-to-metal, pill-type varactor package, called Drawing A-847, has a pedestal available in either copper or Kovar. The ceramic is alumina and is 0.080 in. o-d x 0.050 in. i-d x 0.066 in. long. The flange is copper-clad Kovar, 0.120-in. in diameter. Kovar gives rigidity; copper, low yield point. Ceramics International Corp., 39 Siding Pl., Mahwah, N.J. 07430. [345]

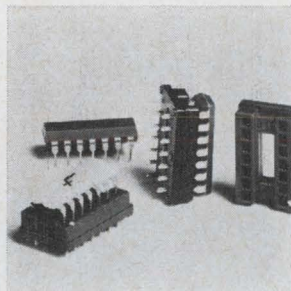

Low profile, dual-in-line sockets are 0.192 in. high. The 14-lead socket requires less than 0.5 x 0.8 in. of p-c board surface. Chamfered entries permit rapid insertion to guide leads into the heat-treated, beryllium-copper-alloy contacts. Contact resistance is less than 8 milliohms over 12,000 insertions. Milton Ross Controls Co., 511 2nd St. Pike, Southampton, Pa. 18966. [346]

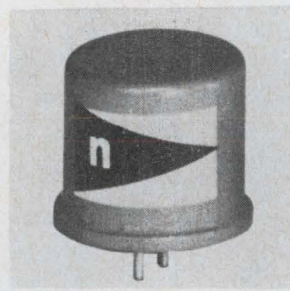

Hermetically sealed, fixed r-f coils in the 1219 series can be used in printed or standard circuitry. They are for applications covering 100 khz to 30 Mhz. With a 1- μ h inductance, Q is 170 at 10 Mhz; with a 1,000- μ h inductance, Q is 170 at 0.5 Mhz. The shield case is $\frac{3}{4}$ in. x $\frac{5}{8}$ in. North Hills Electronics Inc., Glen Cove, N.Y. 11542. [347]

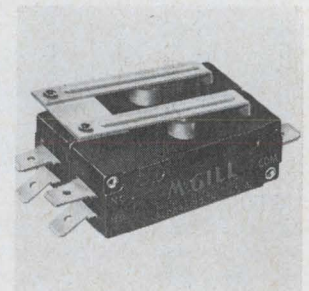

A tandem arrangement of two 2650 series 20-amp, snap-action switches with a common actuator provides a 25-amp, dpdt switch assembly. Utilizing stacked spdt switches, the units are rated at 25 amps, 125-250 v a-c; 1 h-p 125 v a-c and 2 h-p 250 v a-c. They also feature differential travel of less than 0.005 in. McGill Mfg. Co., Valparaiso, Ind. 46383. [348]

New components

Monolithic op amps show it can be done

Bipolar silicon IC's have 10-megohm input impedance, also challenge hybrids and discretes in offset, bias

If a buyer ranked operational amplifiers by type and performance, the line-up might look something like this:

- First, discrete component devices. They offer the highest input impedance, lowest bias and offset currents, but are also bulky and

expensive.

- Second, hybrid integrated circuits. Second best in over-all specifications because component selection can be used, and resistor trimming. But these are still costly devices.

- Third, monolithic integrated

circuits. These are small, widely used and inexpensive, but have generally low input impedance and high offsets. Some characteristics tend to drift with temperature.

The Transitron Electronic Corp. has restacked the deck with its new monolithic TOA7709. The op amp has a typical input impedance as high as 10 megohms—as much as some discrete component devices. Input offset is typically about 2 nanoamperes, input bias current about 10 nanoamperes. Both specifications approach those of hybrid types and even some discrete component op amps.

Meeting or exceeding all 709-

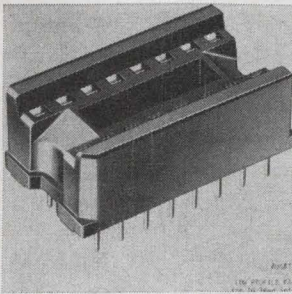

A low-profile socket for 16-lead plug-in IC's permits packaging on 1/2-in. centers. Socket terminals are the same dimension as IC leads for direct interchangeability. Wiping-type beryllium copper contacts permit easy IC insertion. Units are 0.89 x 0.49 x 0.31 in. Price is from 32 to 83 cents each, depending on quantity and type. Augat Inc., 33 Perry Ave., Attleboro, Mass. 02703. [349]

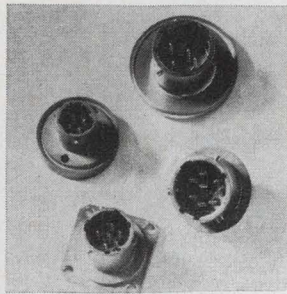

Hermetically sealed connectors withstand pressure up to 40,000 psi. Designed for pneumatic, hydraulic and pyrotechnic applications, they are available in many shell sizes, mounting styles and basic materials. Operating temperature range is -320° to +300°F; vibration, 5 to 2,000 hz at 100 g rms. Gulton Industries Inc., 1644 Whittier Ave., Costa Mesa, Calif. 92627. [350]

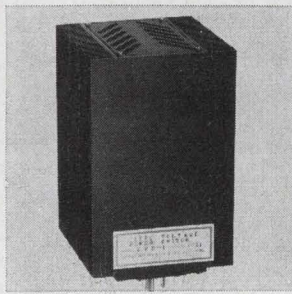

Solid state zero-voltage power switch ZVS-1 handles 20 amps rms per phase in the 3-phase model or up to 32 amps rms for single-phase units. It comes in a 6 x 4 x 3-in. plug-in case. The company says it virtually eliminates conductive and radiated rfi and surge control current problems. Curry, McLaughlin & Len Inc., East Malloy Rd., Syracuse, N.Y. 13211. [351]

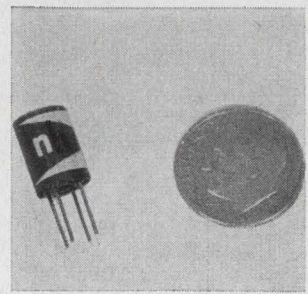

Adjustable coils in the 600 series are shielded and designed for p-c use. They cover from 1 to 1,000 μ h and can be employed over the 100-khz to 30-Mhz range. The coils measure 0.3 x 0.4 in. and plug into a p-c board. Applications include video, r-f and i-f circuitry, both commercial and military. North Hills Electronics Inc., Glen Cove, N.Y. 11542. [352]

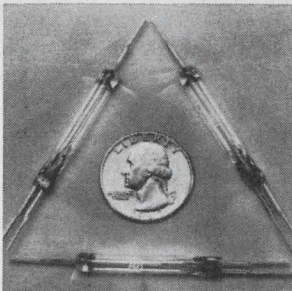

Form C (single-pole, double-throw) reed switch type DR138 is suited for applications involving both resistive and inductive loads. With a contact rating of 5 w (50 v at 100 ma) d-c resistive, it has a life expectancy of 20 million operations. Initial contact resistance limit is 100 milliohms. It has both industrial and military applications. General Electric Co., Louisville, Ky. 40205. [353]

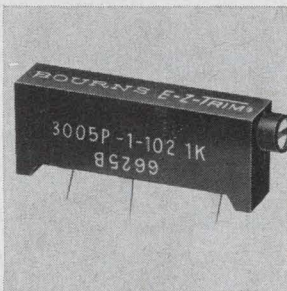

Sealed, commercial wirewound pot model 3005, measuring 3/4 x 5/16 x 11/64 in., has a standard resistance range of 10 to 20,000 ohms, a power rating of 1 w at 40°C, and an operating temperature range of -55° to +125°C. Vibration is 20 g's; shock, 50 g's. Price is \$1.30 each in 1,000-lot quantities. Bourns Inc., 1200 Columbia Ave., Riverside, Calif. 92507. [354]

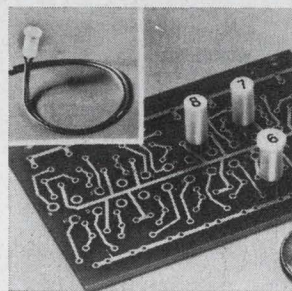

Encapsulated incandescent lamp PC-Lite measures 3/8 x 3/16 in. Mounting pins are spaced 1/8 in. apart. It is designed for printed circuit and instrumentation applications, including panel and sub-panel utilization. Units are available in a power range from 1 1/4 through 28 v and in a variety of colors. Leecraft Manufacturing Co., 21-10 44th Road, L. I. C., N.Y. 11101. [355]



Spst pressure switch 91MG, measuring 0.5 x 0.5 in., operates in the pressure range of 3 to 300 psig. It has a contact rating of 5 amps resistive at 115 v a-c, 60 hz or 28 v d-c. Factory adjusted, the switch point is repeatable to 0.2%. The unit weighs 0.4 oz. Price is approximately \$50. Servonic Instruments Inc., 1644 Whittier Ave., Costa Mesa, Calif. 92627. [356]

type op amp specifications, the new unit is also a direct plug-in replacement for them.

By contrast. The 709's are specified for input impedances of about 400,000 ohms, input bias current of 200 nanoamperes (maximum is 500), and input offset current of 50 nanoamperes (maximum is 200). Thus, Transitron's new op amp offers at least 25 times the 709's input impedance, 5% of the 709's input bias current, and 4% of the 709's input offset current. "... And at a price only 30% higher than for standard 709's," says Stan Harris, Transitron product sales manager for linear IC's and special products.

Comparing prices, Harris says that Transitron's military-quality 709 equivalent, the TOA1709, costs \$9.90 each in lots of 100; the new TOA7709 costs \$12.80. The TOA8709 with less impressive specifications, is Transitron's commercial version and sells for \$8.35, compared with \$6.45 for its 709 equivalent TOA2709.

Firstest-mostest. Transitron has entered the marketplace with the highest-impedance monolithic op amps available, at a competitive price. Motorola and Raytheon are developing op amps which use field-effect transistors to achieve high input impedance. Motorola's

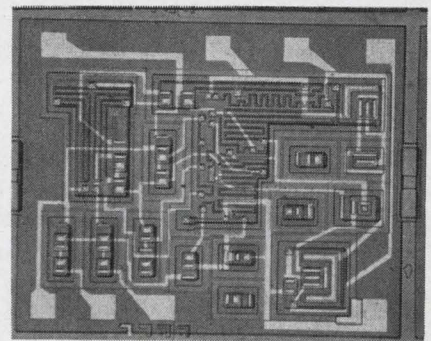

Low draw. High impedance IC has 17 transistors including 4 Darlington pairs and 2 pnp elements.

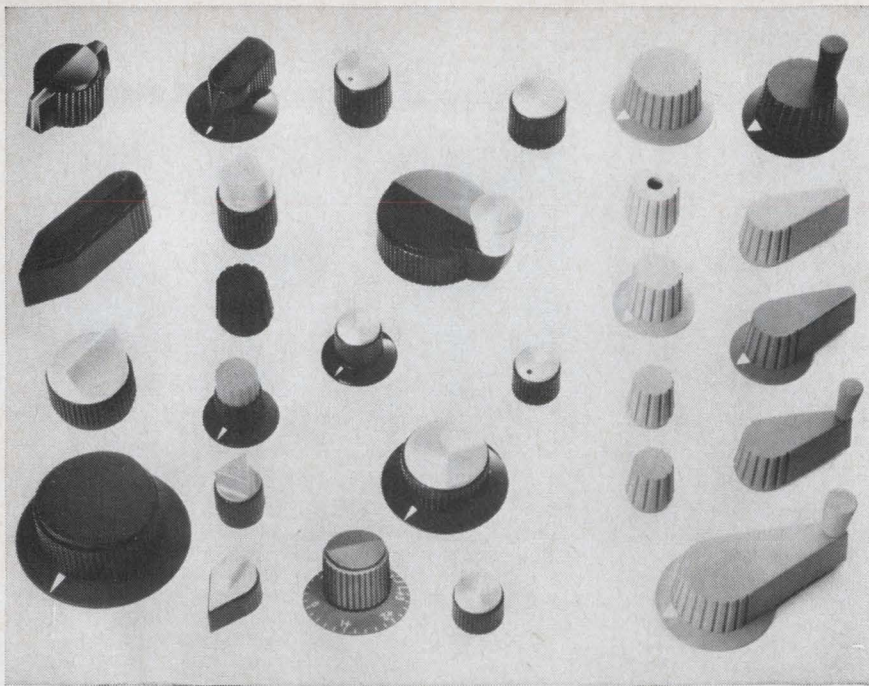

**Standard and custom military knobs,
aluminum cap knobs, color control knobs for
every panel requirement. Send for data kit.**

With Raytheon control knobs, you can meet military specifications—or select styles and colors that harmonize or contrast with any commercial panel decor. And you can get these knobs immediately—through Raytheon distributors from coast to coast.

Meet MS91528C Military Specifications from the more than 300 standard types and the 2,000 “specials” Raytheon has designed. All knobs are functionally designed. All styles have an integrated design to give uniformity to your panel. And all knobs meet specifications for resistance to flame, torque, temperature and humidity extremes, salt spray, and ultraviolet radiation.

Handsome aluminum cap knobs are made of strong plastic with satin finish aluminum caps that are treated with an epoxy coating for corrosion resistance.

Commercial color knobs—available in nine colors and ten styles—harmonize or contrast with commercial equipment design. Raytheon makes these 400 Series knobs of durable, high-impact ABS.

Custom-made control knobs. Raytheon also designs and manufactures control knobs to meet special requirements for color, shape, size, finish. Call your nearest Raytheon regional sales office or write to us. *Raytheon Company, Components Division, Quincy, Mass., 02169.*



**Send for Raytheon
Control Knob Data Kit**

—contains complete specifications on all standard and custom knobs. Just send the reader service card.



**... it started as quest
for higher beta ...**

uses more than one chip and thus can be classed as a hybrid.

Transitron once worked on FET op amps too, and now it wonders why. The firm has done the job on one silicon chip using bipolar transistors and a Darlington input to achieve high input impedance.

The work that led to the new op amps was started in a quest for lower noise and high transistor beta (common emitter current gain) at low collector currents. Noise isn't a guaranteed specification for op amps but users of a variety of 709 types had complained of noise-caused error in their applications, so Transitron embarked on a program to reduce leakage to a minimum and retain beta.

They succeeded through improvements in surface technology, according to Douglas Sullivan, operations manager for linear IC's at Transitron. Very low leakage levels were achieved, and transistors with typical betas of 100 at collector currents as low as 100 nanoamperes could be built; at 20 microamperes and higher, beta was about 200.

Sullivan says that not only was the type of oxide used a factor, but also the method and control of its deposition.

Skeptics. Because of the low leakages attained, and the high betas, Transitron ran a computer analysis of the performance of a Darlington input op amp. The printout looked good but it didn't prepare the engineers for what followed. When they built the first batch they found input impedances of 100 million ohms or more. This was unbelievable, says Sullivan, and the engineers' first reaction was to take the devices from tester to tester, thinking that each had malfunctioned.

The same reaction followed when they tried to measure leakage and offset currents. With standard production gear, these parameters just could not be measured. Only under clean-room conditions with the best laboratory gear Transitron had available, and even then with scale multipliers, could they measure these specifications.

The engineers eventually con-

New Patterns of Performance

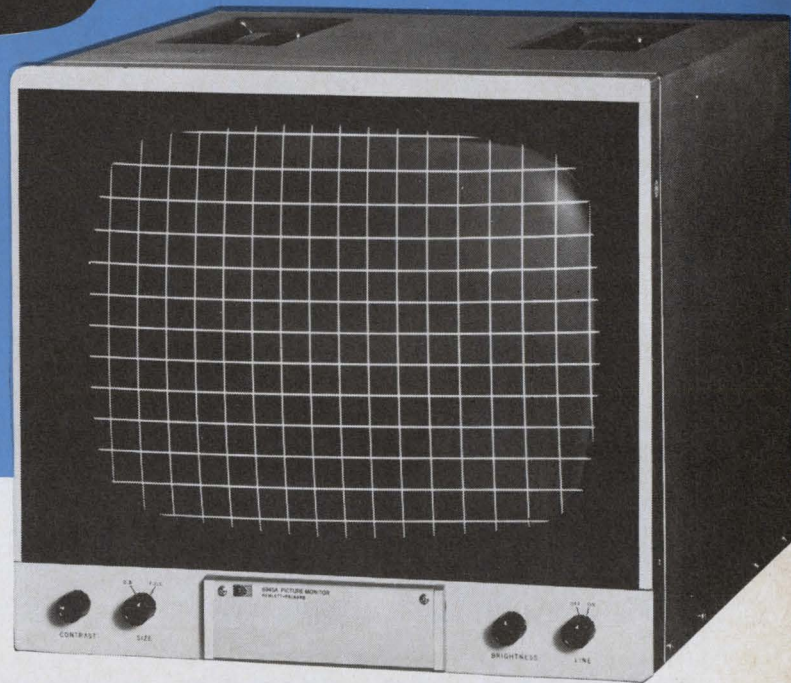
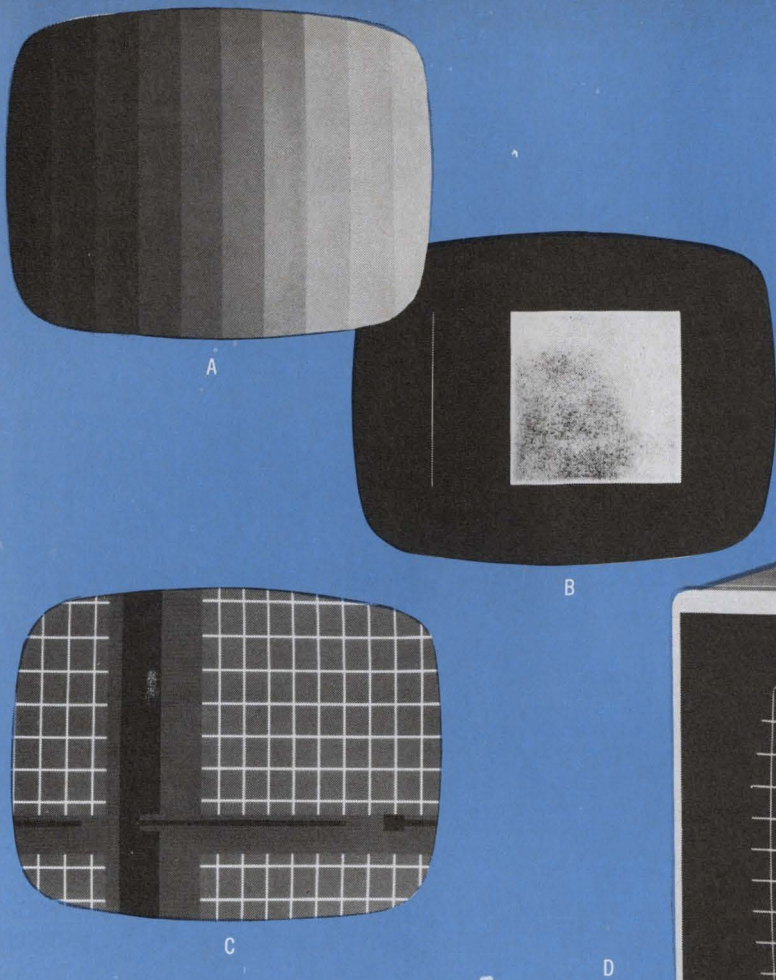

hp 17" Video Monitor Achieves Increased Reliability and Improved Picture Quality through Advanced Circuit Techniques

CONSISTENT IMAGE QUALITY

- A** Keyed back porch clamp assures less than 1% black level shift for 100% video amplitude change.
- B** Displays sine² T/2 pulse without distortion (62.5nsec).
- C** Option 46 pulse cross position.
- D** Less than 1.5% geometric distortion over-all • Feedback insures excellent gain stability over full video bandwidth • Unity interlace results from novel sync circuitry.

MAINTENANCE FREE OPERATION

All Solid State Circuitry • No periodic alignment or adjustment required • Highest quality components and workmanship.

EASE OF OPERATION

Display linearity independent of size adjustment • Unique deflection circuits have feedback active over entire raster • No sync controls — synchronization is automatic on both North American and CCIR Standards.

OTHER IMPORTANT FEATURES

Fully regulated high voltage and low voltage power supplies • Balanced input with loop-through facility • 46 db input common mode rejection • Size: 17⁷/₁₆" W x 15¹/₂" H x 20¹/₈" D. Price: Model 6946A—\$950. Option 46—\$45.

For more information, call your local HP field engineer or write Hewlett-Packard, 100 Locust Ave., Berkeley Heights, New Jersey 07922. Europe: 54 Route des Acacias, Geneva.

HEWLETT  PACKARD

COMMUNICATION INSTRUMENTS

Circle 185 on reader service card

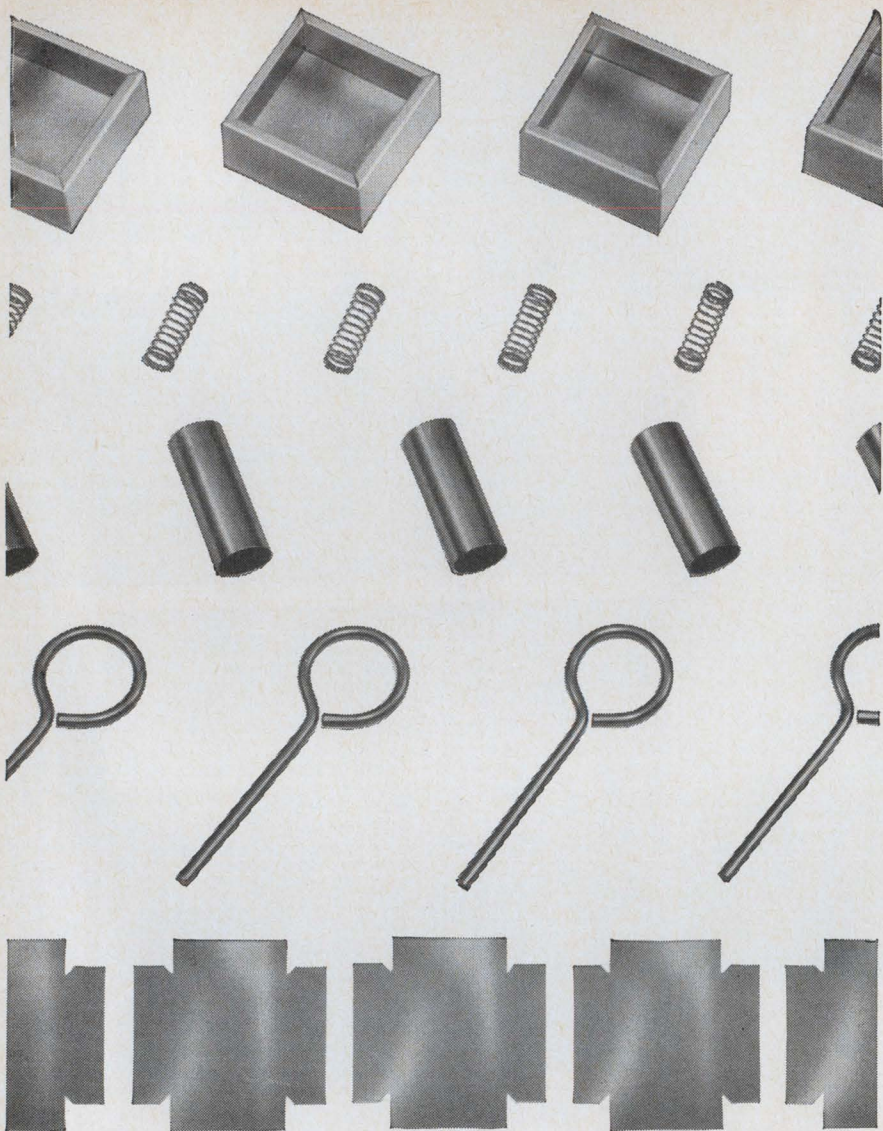

DUPLICATE THESE PARTS AND MORE IN YOUR OWN PLANT WITHOUT DIES!

Here's a way to produce short runs of simple parts quicker than an order can be processed to get them "outside." Versatile Di-Acro "Die-less Duplicating" equipment sets up quickly for cutting stock to size and forming it to die accuracy — without costly dies. Get full information in the new "Die-less Duplicating" catalog. See your distributor or write us.

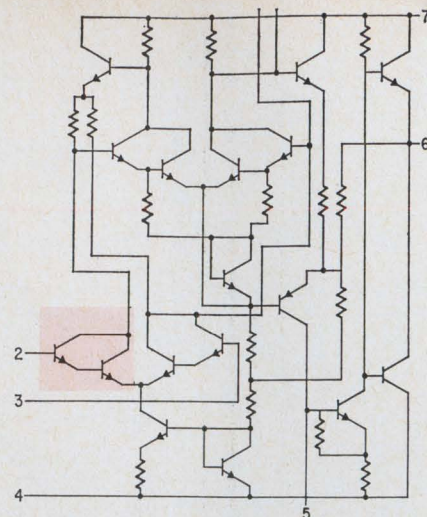
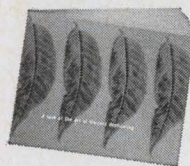

Input pair. High impedance level is due to Darlington input. Transistor element betas exceed 100.

vinced themselves that they had a potentially excellent product, but there was a drawback: gain was only 20,000 to 25,000. For the product to compete with the 709 types, voltage gain had to be at least equivalent—about 45,000. This was achieved by throttling back typical input impedance to 10 million ohms.

There was a side benefit in going to the 10-million-ohm figure. It raised bias and offset currents to the point at which they could be measured on the production line—with some beefing up of the line's test equipment.

According to Harris, Transistron can now take orders in thousand lots and deliver in three weeks. In fact, Sullivan says, without any changes in the production line or shifts in delivery schedules for the other items, Transistron is equipped to produce 5,000 of these IC's a week—and inside of a month could be making 10 times that many.

Specifications

Input impedance	10 megohms typical
Input offset current	2 na typical 10 na max.
Input bias current	10 na typical 30 na max.
Input offset voltage	±1 mv
Input offset voltage drift	±6 mv/°C
Open loop voltage gain	45,000
Common mode rejection ratio	90 db
Packages	dual in-line, flat pack, TO-99
Prices in lots of 100:	
TOA7709 (mil-spec version)	\$12.80 in TO-99
TOA8709 (commercial version)	\$8.35 in TO-99

Transistron Electronic Corp., Wakefield, Mass., 01881 [357]

Move With Advanced Computer Technology At NCR Electronics Division

SYSTEMS FORMULATION

Analysis and development of advanced systems specifications; consultation on systems design, hardware configuration, software trade-offs; analysis of competitive systems. Applicant should have familiarity with very high speed memories, large-scale integration, disc files, drum files, communications and time sharing plus related BS degree and 3 to 5 years' experience in one or more areas mentioned.

SOFTWARE SYSTEMS

Programmers to develop executive and operating systems for third-generation computer systems. Desire experience with medium- and large-scale general-purpose systems employing high speed peripheral units, tapes, random-access files, disc files, drum files, on-line, time sharing and multi-programming. Requires related BS degree and 3 to 5 years' directly related experience. Positions also open for hardware-oriented programmers to do systems diagnostic work.

EDP ANALYST/PROGRAMMERS

Analyst position entails systems analysis in financial and administrative areas. One year of EDP experience required, degree desirable. Programming positions involve accounting and manufacturing systems. Degree and recent experience on medium- to large-scale systems desired.

OPTICAL SYSTEMS

To do computer-aided design of specific elements in complex optical systems, such as field and condenser, as well as image-forming elements.

Activity includes optical-electronic lab work, systems layout and design, technical liaison. Involves geometrical and physical optics. Requires BS in physics or optics plus 2-5 years' directly related experience.

MEMORIES RESEARCH

To design high-speed magnetic memory circuits. Requires knowledge of nanosecond pulse techniques and magnetic memory organization. Familiarity with plated-wire and mass-storage memory concepts desirable. Requires BSEE plus five years' experience.

SYSTEMS ENGINEER

For systems design on advanced computers. Requires extensive knowledge of memory technology, systems logic and large-scale integration as applied to medium- to large-scale general-purpose computing systems. Minimum of BSEE and five years' direct experience required.

LOGIC DESIGN

Several positions available for EE's with 2-5 years' experience in logic design on either special- or general-purpose equipment. Positions require thorough knowledge of logic as related to real-time hardware development or automatic test equipment.

CIRCUIT DESIGN

Positions for both systems- and device-oriented circuits men to work either in developmental projects or standard circuits group. BSEE required plus 3-5 years' design experience and thorough understanding of IC technology. Knowledge of large-scale integration concepts and

ramifications desirable. Projects include thin-film memories, IC utilization and development, project/vendor liaison, systems applications.

FACILITIES/LAYOUT

Work entails projecting needs of expanding division, development of proposals, program implementation. Requires three years of facilities and layout experience, preferably in electronics industry; BSIE or equivalent; ability to deal effectively with all levels of personnel. Knowledge of safety codes desirable.

MACHINE DESIGN

Creative mechanical engineer capable of designing sophisticated manufacturing hardware and of developing machines to do jobs which heretofore have not been encountered. Requires BSME and minimum of two years' experience.

CHEMICAL PROCESSES

Positions in both engineering and manufacturing for man with BSChE and 2-5 years' experience in electroplating and electrodeposition in thin and thick films. Thorough knowledge of related materials, pre-plating surfaces, plating equipment required. Work entails development of advanced processes and techniques for computer development and production.

QUALITY ASSURANCE ENGINEERS

Q.C. assignments include process capability, studies, failure analysis, design reviews, establishment of inspection standards. Position requires 2-3 years' experience with EDP equipment, knowledge of magnetic materials, BSME degree. Reliability positions involve planning, conducting and reporting reliability tests of electronic components, assemblies and units. BSEE required plus experience with reliability mathematics, computer circuitry. Positions also available in systems test.

TO ARRANGE A CONFIDENTIAL INTERVIEW send resume including salary history to: TOM E. LYON

NCR Electronics Division is the largest commercial computer manufacturing facility in Southern California and one of the most advanced in the world. The Los Angeles plant and laboratories have recently been doubled, and an additional manufacturing facility is now under construction in San Diego. At NCR you will enjoy stable, non-defense activity in a

thoroughly professional environment. Your job and your future: the creation of advanced business automation for NCR markets in 121 countries.

Challenge, opportunity and Southern California are waiting for you. Look into these opportunities now.

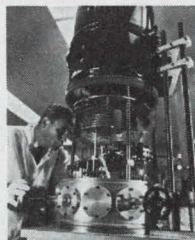
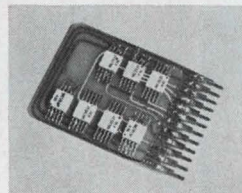
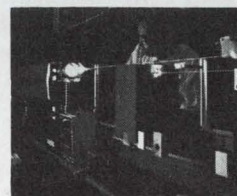

The National Cash Register Company[®]
ELECTRONICS DIVISION
2816 W. El Segundo Blvd., Hawthorne, Calif.
Telephone: (213) 777-7296
An equal-opportunity employer



for maximum **SOLID CARBIDE** drilling precision

SERIES 125 - 1/8" SHANK SOLID CARBIDE CIRCUIT BOARD DRILLS

the rigid stability
of 1/8" shanks
with EVERY size drill

Series 125 Circuit Board Drills are made with Metal Removal Company specifications of point configuration (Four Facet Point), helix angle, very fine flute finish and exacting size tolerances.

The Series 125 Circuit Board Drill is an advancement of drill design to its present optimum. Among many features, it offers:

- Strength and rigidity of the 1/8" shank permits location and hole size tolerance to close limits.
- Drill bushings completely eliminated where used with precision spindles and collets.
- Also available in double end style with 1/8" shanks.
- 1/8" common shank size for all drill diameters eliminates inventory of collets for each size drill.
- Drill point is concentric to drill diameter within .0005"; drill diameter to shank concentricity is within .0003".
- Permits ultra high speed drilling at rates up to 150,000 RPM and 15 feet per minute feed.
- Can be manufactured with geometry variation for clearances required for fast feed, high RPM operation.

For complete information write for Bulletin CB66.

THE METAL REMOVAL COMPANY

1859 West Columbia Avenue
Chicago, Illinois 60626

Plants Located in CHICAGO • LOS ANGELES • SAN JUAN



New components

The jig is up — down if need be

New method of making
relays eliminates
bending of contacts

The manufacture of relays usually includes adjustment of the contacts to assure uniform characteristics. This is accomplished by tweaking—bending the contacts—or by the addition of nonmagnetic material to change operating speed. These techniques, which involve human skill and judgment, are sources of error and also increase the chances of failure stemming from weakened parts.

A new technique, developed by the Hi-Spec Electronics Corp. and applied to microminiature relays, makes unnecessary traditional methods of adjustment. The contacts on the new devices remain fixed.

In the Hi-Spec design, jigs—me-

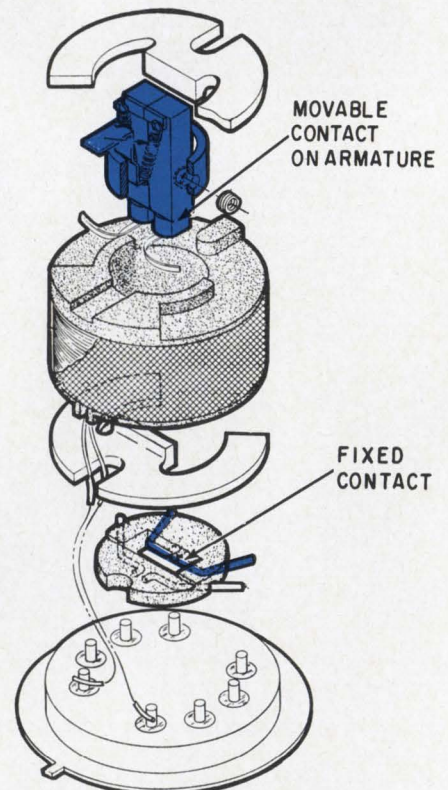

One piece. Movable contact is connected directly to armature.

Will the capacitor you take for granted take out your entire system?

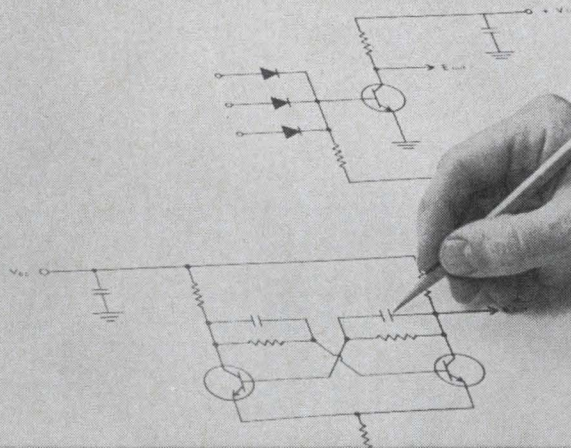

Specify CORNING® Capacitors for confidence.

Considering the finality of capacitor failure, anything less than the reliability of glass is false economy.

Protect all the critical design work you put into your active circuits.

Back them up with the documented reliability of glass dielectric capacitance in the vital roles of coupling, bypass, filtering. Corning offers this confidence in a full range of types, sizes, values and costs.



CORNING® CYFR Capacitors, from .5 to 10,000 pf, substantially exceed the requirements of Mil-C-11272, including environmental performance and Quality/Reliability Assurance, and are backed by a heritage that includes use in Surveyor, Minuteman, Gemini, among others.



CORNING® CYFM Capacitors offer low cost, high reliability, from .5 to 10,000 pf. Give you CYFR-type environment-proof performance at substantial savings.

CGW
TYO7
7511

CORNING® TYO Capacitors from 1 to 2700 pf, radial leads, precision case for snug, upright mounting. Dense circuitry without doubts. Meet or exceed all performance requirements of Mil-C-11272.

CGW
GK
207001

CORNING® Glass-K Capacitors cram from 1000 to 100,000 pf in a quarter-inch case size with a new dielectric material for guaranteed reliability.

In all types, standard items are shipped in two weeks or less. Tell us what you want in capacitance; we'll tell you which CORNING® Capacitor will give you the confidence you need.

For complete specs, write to:
Corning Glass Works,
Electronic Products Division,
3913 Electronics Drive, Raleigh, N.C.

CORNING
ELECTRONICS

The Model 6000 Modular Frequency Meter will measure frequencies 10 KHz to 600 MHz with .000125% accuracy. Special plug-in modules allow the instrument to be used as an audio frequency meter from 500 Hz to 20 KHz full scale and in addition to be used as a dc voltmeter (10,000 ohms/volt).

The wide variety of plug-in oscillator accessories and range modules makes the Model 6000 adaptable to a number of jobs in the field and in the laboratory. Portable, battery operated with rechargeable batteries.

Model 6000 with 601A charger, less plug-in modules.....\$195.00

INTERNATIONAL MODEL 6000 FREQUENCY METER

measures frequencies 10 khz to 600 mhz with accuracy as close as .000125%



Range Modules (Mixers)
\$25.00 to \$45.00 each

Oscillator Modules
(Crystal Controlled For
Frequency Measurement)
\$30.00 to \$90.00 each

Special Modules
Audio Frequency\$45.00
DC Voltmeter..... 25.00

where
accuracy
counts!

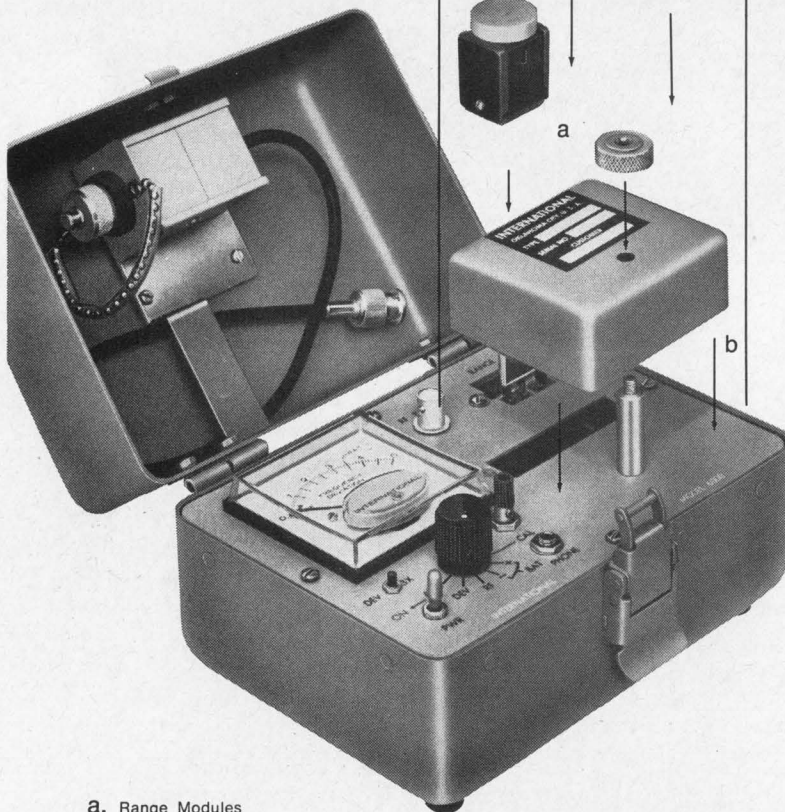

a. Range Modules
b. Oscillator Modules

... For complete information
write International today.



CRYSTAL MFG. CO., INC.
10 NO. LEE • OKLA. CITY, OKLA. 73102

... relay operates with minimum bounce ...

chanical alignment devices—are used to set the contact tolerance. Therefore, each assembled relay must meet its design specifications. If a batch does not meet the specs, the jig is readjusted, not the relays. Jig manufacturing methods were made possible by using only one point to measure set-up dimensions. This one datum point also eliminates tolerance build-up—dimensional errors that are small but increase with the size and complexity of the device.

Solid contact. Because of the construction method, the movable contacts are fixed directly to the armature. No intermediate actuator or movable contact springs are required. As the armature responds to the magnetic force of the energized coil, the contact moves with it. Both the fixed and movable contacts are cylindrical in shape, solid, and made of a gold alloy. This results in the elimination of point wear that is associated with gold plating, and also keeps contact resistance low.

The movable contacts and armature travel only one-third the distance covered in comparable relays, in approximately the same time. The lower average speed means the relay operates with minimum bounce. It also means a lower kinetic energy has to be converted upon mating of contacts. Even though the speed of travel is slower than in some relays, the operate-and-release time combined with the reduced bounce means faster transfer to the steady state condition. The cumulative effect, according to the company, is an increase in operational life.

In most microminiature relays enclosed in TO-5 cans, the leads pass through a glass seal and connect directly to the contacts and coil. If the leads are bent or flexed too much, internal relay parts may be damaged. In the Hi-Spec units, the leads pass through the seal and stop. From this point, inside the header, ribbon leads connect the relay parts to the outside world, eliminating one cause of damage to the device.

Hi-Spec Electronics Corp., Newbury Park, Calif. [358]

At ECI in St. Petersburg, Florida...
Communication Systems Opportunities

For a special breed of engineer

If you're one of that special breed of communication engineers who finds a challenge in projects beginning with applied research and advanced development and continuing through prototype and product design, you may well be the kind of person we're looking for.

Check this partial list of systems engineering activities at ECI. If you'd like to help push the state-of-the-art in any of these or other areas in communications, send us your resume. You'll design systems and equipment for satellite communications, multiplexing, electronic switching, command and control and advanced radio communications for some of the nation's major defense and space programs.

Communication Systems Engineering Activities:

- Propagation Analysis
- Advanced Antennas
- Coding Theory
- Detection Techniques
- Communication System Design
- Communication System Integration
- Reliability Techniques

CHALLENGE, GROWTH . . . and LOCATION TOO!

At ECI your job will be challenging. At ECI you'll find real opportunity for growth instead of just another confining groove — two-thirds of all advanced development is done in regular engineering development areas. And, at ECI you'll like where you're living just as much as you'll like your job. We'll match subtropical, sunny St. Petersburg against any location in the U. S. for stimulating, comfortable living.

SEND YOUR RESUME TODAY — in confidence — to K. E. Nipper, Supervisor of Professional Placement, Electronic Communications, Inc., P. O. Box 12248, St. Petersburg, Florida 33733.
(An equal opportunity employer, M & F.)



ELECTRONIC COMMUNICATIONS, INC.
ST. PETERSBURG DIVISION

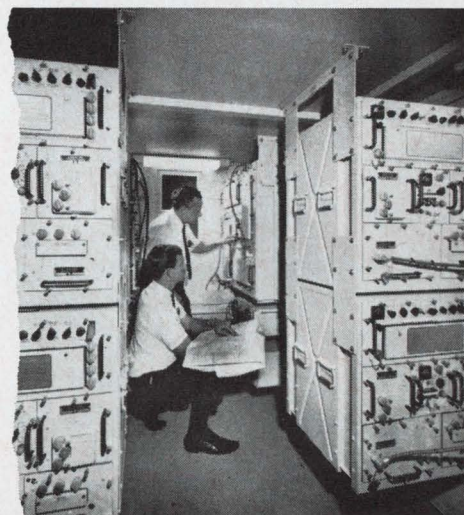

We're number one 2, 3, 4, 5, 6, 7, 8, 9...

No matter how it all adds up, we're the leaders in thumbwheel switches—in sales, in product features and quality...and in service. We like leading, and here's what it means to you:

■ Our switches—Digiswitch® and Miniswitch®—are the simplest, most easily read, easiest to operate, smallest, biggest, and best looking for your panel. And they have both complex and simple electrical output capabilities.

■ Did we get to be number one because we are so smart? We like to think so. But being there first sure helped. We pioneered the thumbwheel switch. And we're the kind of engineers who continually improve our product. [Drives the competition crazy.]

■ But maybe our real advantage is that we like to sell things. This makes us easy to buy from. Send for our catalog. It's as easy as one, two, three.

THE DIGITRAN COMPANY

Subsidiary of Becton, Dickinson and Company **BD**

855 S. Arroyo Pkwy./Pasadena, Calif. 91105

Tel: (213) 449-3110/TWX 910-588-3794

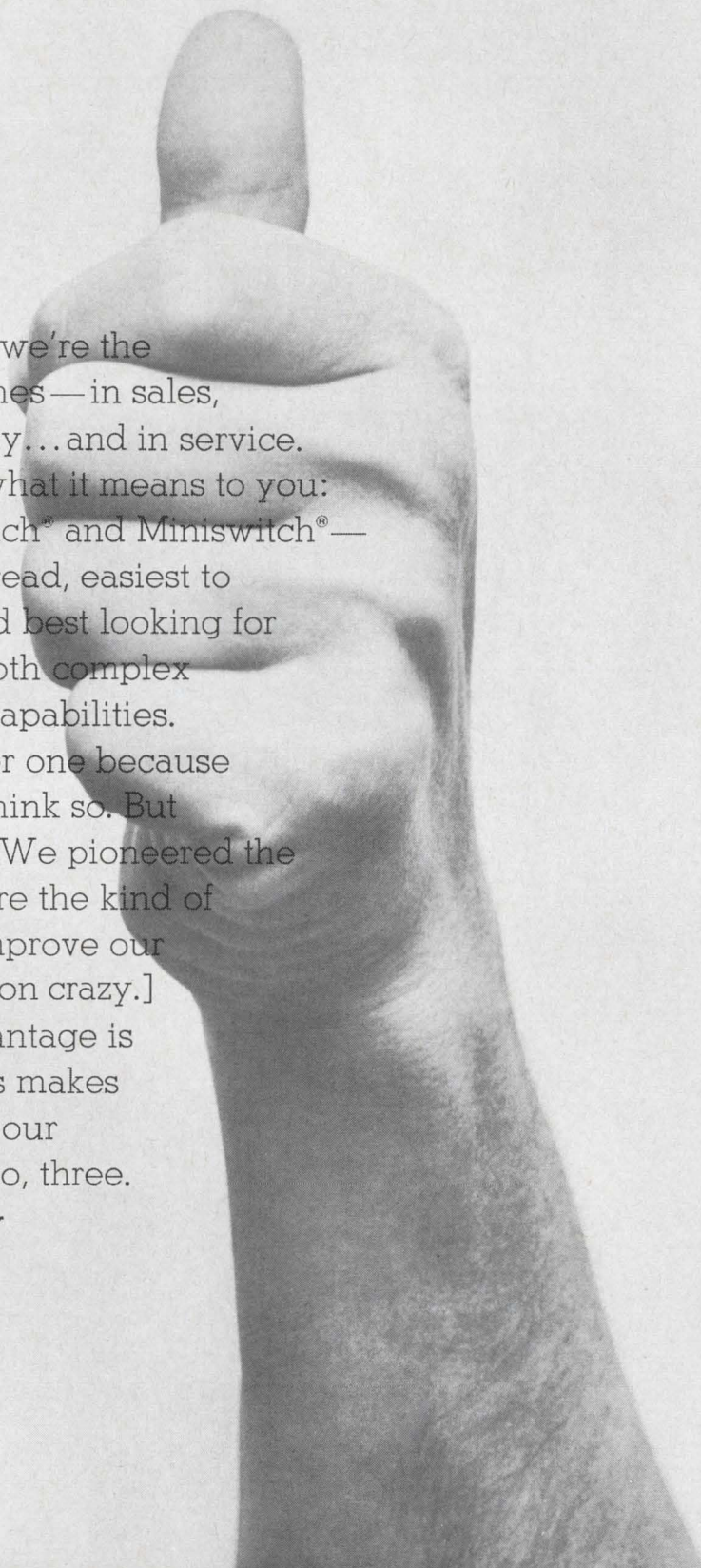

New Semiconductors Review

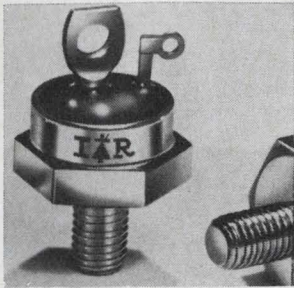

SCR series, types 40RCS5-60, handle 40 amps with ratings from 50 to 600 v. They withstand extreme temperature and humidity per Mil-Std-750. They offer 800-amp-max. peak surge current; 63-amps rms max. on-state current; and 0.5 w max. average gate power. Prices (100-up), \$9.15 to \$19.90 each. International Rectifier, 233 Kansas St., El Segundo, Calif. 90245. [436]

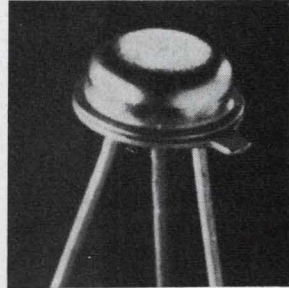

N-channel junction FET CH13N is a high transconductance-to-drain current device for low level amplifier use. Minimum transconductance is 25,000 at 10 ma, ensuring a voltage gain of 25 minimum. As a source follower, the FET has a typical output impedance of 25 ohms. Noise voltage is less than 2 nv at 10 khz. Crystalonics Inc., 147 Sherman St., Cambridge, Mass. 02140. [437]

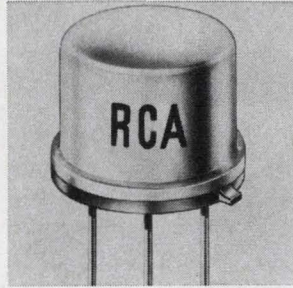

Triple-diffused, silicon planar npn transistors 40581 and 40582 are mounted in TO-39 hermetic-metal packages. They are designed for use in the output stages of 27-Mhz amplifier chain of citizens band radio transmitters. Price in quantities of 1,000 and up is \$2.95 each for the 40581; \$3.25 each for the 40582. RCA Electronic Components and Devices, Harrison, N.J. 07029. [438]

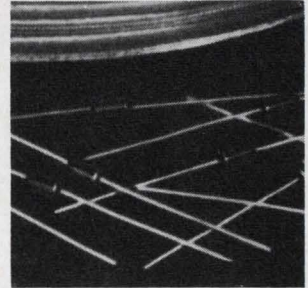

Ratings of 200 and 400 v in the 50- to 1,000-v plastic Surmetic rectifier series are now available to meet Mil-S-19500/228D. The nominally rated 1-amp-at-75°C device is capable of 2.5-amp, 80°C performance, resistive or inductive load. Prices (100-up) are 99 cents and \$1.30 for the 200 and 400 v units, respectively. Motorola Semiconductor Products Inc., Phoenix, Ariz. 85001. [439]

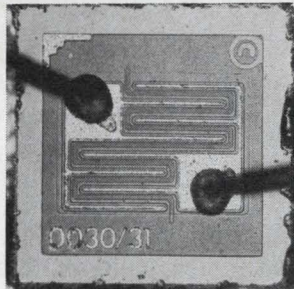

P-channel FET 2N5033 has a pinch-off voltage from 0.3 to 2.5 v when drain-to-source voltage is -10 v and drain current is 1 μ a. Equivalent input noise voltage is 0.1 μ v per the sq rt of frequency at 1 khz, and the frequency noise figure is 2 db max. at 1 megohm. Price is \$1.80 (1-99); 72 cents (10,000-24,999). Fairchild Semiconductor, Mountain View, Calif. 94041. [440]

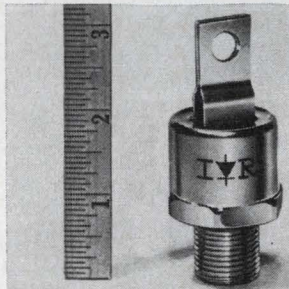

A series of 200-amp silicon rectifiers, 200UB5-50, has a silver-plated flat tab anode terminal that forms a heat sink and allows cable connections directly to the device rather than through terminal posts or blocks. Maximum repetitive prv's range from 50 to 500; prices (1-9), \$6.30 to \$17.80. International Rectifier, 233 Kansas St., El Segundo, Calif. 90245. [441]

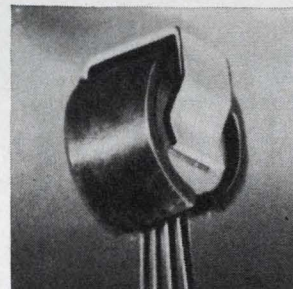

Superconductive selenium rectifiers in the Super-Sel series are typically $\frac{1}{3}$ the size of conventional selenium assemblies. Plate temperatures to 85°C are allowed for 100,000 hours of operation before internal voltage drop doubles. Output currents are from 0.1 to 10,000 amps; voltage, 12.5 to 190 v d-c. Sarkes Tarzian Inc., 415 N. College Ave., Bloomington, Ind. 47401. [442]

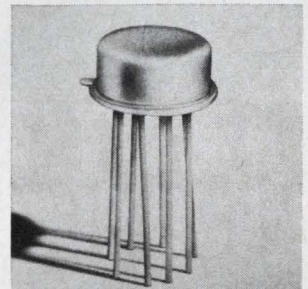

Monolithic differential comparators are for use where fast response times are required over the temperature range -55° to +125°C (type TDC 1710 and 1711) or 0° to +70°C (type TDC 2710 and 2711). Voltage gain for the TDC 1710 is 1700; for the others, 1500. All have 40-nsec response time. Transistron Electronic Corp., 168 Albion St., Wakefield, Mass. 01881. [443]

New semiconductors

UJT offers a choice

By changing two external resistors, a unijunction transistor's characteristics can be suited to a variety of applications

Not too long ago, the Semiconductor division of the General Electric Co. accounted for 90% of the \$5 million-a-year unijunction transistor (UJT) market. It was selling alloy types in commercial, industrial, and military grades, all in metal cans.

Then Texas Instruments Incor-

porated came up with its plastic-packaged planar units, and these cut GE's market share to 60% within a year and a half. Motorola also made headway in this area with sophisticated planar UJT's similar to GE's. For consumer products, especially lamp dimmers and small-

motor controls, customers didn't feel they needed the higher-priced metal can units.

Faced with these challengers, GE started making planar plastic units itself, but ran into problems. About 10% of the new units in each production run didn't meet the specifications for operation at high temperatures. Because the company didn't want to invest the time and money needed to weed out the bad units, the whole project was scrapped and a new one started.

From scratch. GE engineers felt that as long as they were going to develop a new unijunction, they might as well try to eliminate the

Something new under the sun!
Bissett-Berman E-CELL[®] Timers

μWATT 'TIME SINK' CIRCUIT GIVES SUBTOTALS AND TOTALS

Problem: measure the operating time of major components of a system, while also summing the operating time of the system. The old way: use two parallel meters, with their readout gears. The new way: use the Bissett-Berman E-CELL* "time sink" circuit below for a total up to 1000 hours (which can be read out in 30 minutes), in a matchbox-size package that: uses only 1/100 watt-hour; has no moving parts; withstands mil spec shock and vibration; and is directly compatible with solid-state circuitry. Cost? a fraction of just one of the meters. Try it yourself!

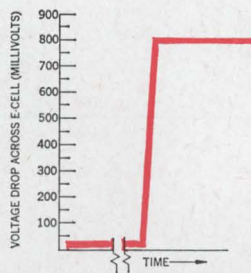
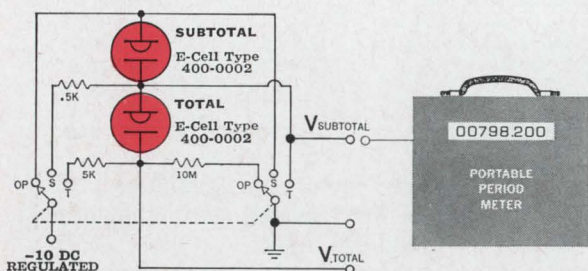

* The Bissett-Berman E-CELL[®] is a unique "liquid state" electrochemical timing and integrating component now being manufactured in high volume on fully automatic production lines. E-CELLS are designed for single use or re-cycling, can be set or re-set in the field, and are furnished in wire-lead or plug-in versions. A multiple-electrode E-CELL enables complex functions such as two-phase timing — or subtotalling and totaling — with



signal outputs at each step. E-CELLS can generate accurate time delays ranging from a fraction of one second to months; can integrate events from one to infinity; and can operate in the **nanowatt** range. Operating/storage temperature is -55°C to 75°C . E-CELLS have been tested and approved by users for severe shock and vibration tolerance in accordance with military specifications. Patents applied for.

For technical information and application notes, contact: Components Division. The Bissett-Berman Corporation, 3860 Centinela Avenue, Los Angeles, California 90066; Telephone: Area Code 213, 390-3585.

**BISSETT
BERMAN**

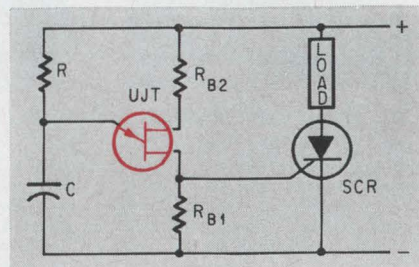
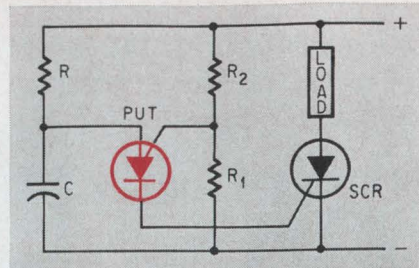

Replaced. In SCR trigger applications, the unijunction and its two base resistors, R_{B1} and R_{B2} , are replaced by a programmable unijunction and its two limiting resistors, R_1 and R_2 .

major drawback of the traditional UJT—fixed valley and peak currents. The result of their effort is a new planar passivated pnpn device called a programmable unijunction transistor (PUT). Unlike the standard UJT with its emitter and two base leads, the PUT has an anode, cathode, and gate—an arrangement similar to that of a silicon controlled rectifier. In some applications, in fact, the PUT functions like an SCR. Operating parameters such as peak current, valley current, interbase resistance, and forward voltage can be selected by choosing appropriate values for resistors R_1 and R_2 , and one PUT can thus be used in a variety of applications.

Turning on. In operation, R_1 and R_2 control the voltage at which the diode (anode to gate) becomes forward biased. After the diode conducts, the regeneration inherent in a pnpn device causes the PUT to switch on, and this generates a negative resistance characteristic from anode to cathode, simulating the modulation of R_1 with a conventional unijunction.

In this case, R_1 and R_2 are equivalent to the interbase resistance of a conventional unijunction. For anode voltages less than the gate potential (established by R_1 and R_2), the PUT is in a nonconducting state. As the anode voltage

VSMF is a product supermarket

John Manning, Missiles Systems Division, Raytheon Company, Bedford, Mass., has installed 4 VSMF Files: Defense Design, Documentation, Mil Specs and Mil Standards.

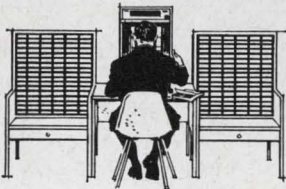

look into it!

Design engineers have been telling us for years that VSMF is much like a product supermarket. That's because Visual Search Microfilm Files contain more than 1,000,000 products from over 15,000 manufacturers—all arranged with design engineers in mind.

Of course, VSMF isn't exactly a supermarket. At Information Handling Services, we've collected 1¼ million pages of product data, indexed them, microfilmed them, put them in compact consoles, and combined them with the most modern microfilm retrieval equipment. VSMF has all the advantages of a product supermarket... complete, easy-to-use and up-to-date.

We know that when you design a product you want to use the best components and materials. And, to do this, you need to compare all that is available. VSMF can help you in this comparison because VSMF supplies the data on *all* products. You supply the judgment.

Manufacturers who place their data in VSMF know this and invite comparison. The constantly changing "state of the art" is reflected in the pages of VSMF.

More than 125,000 engineers in 500 great corporations now shop in the VSMF supermarket. If you have VSMF in your company, look into it. If you don't, you might look into that, too. Write for "Looking into VSMF."



Information

HANDLING SERVICES, INC.

Dept. E-1211

Denver Technological Center
Englewood, Colo. 80110

Circle 195 on reader service card

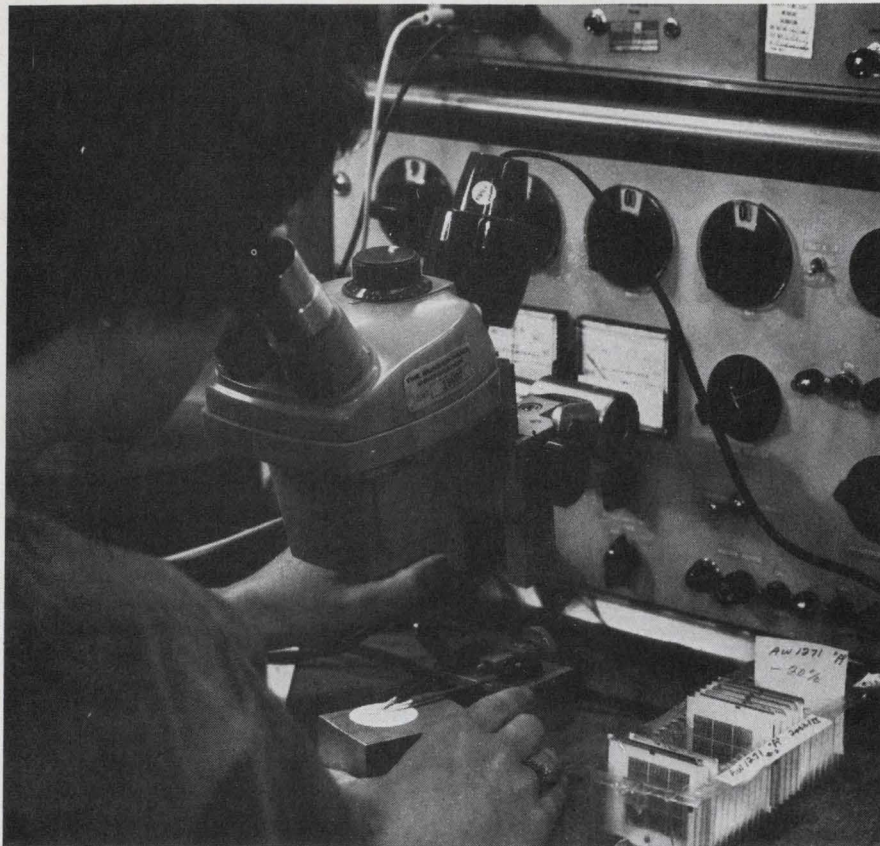

LOW-COST SOLUTION TO RESISTOR ADJUSTMENT

**Bunker-Ramo's Unique Lease Arrangement
Puts Precision Equipment in Your Plant**

Now you can lease Bunker-Ramo's unique precision adjuster at a low monthly rate plus 1 cent per pulse... our substrates are also available, providing a complete microelectronics package with no investment in capital equipment.

Bunker-Ramo's proprietary equipment and processes have been thoroughly tested in daily production of custom microcircuits over a five-year period. We trim thin-film resistors to .01% and match the temperature coefficient of resistance to track to within $\pm 5\text{ppm}/\text{C}^\circ$.

A demonstration will convince you that we have the unique technical know-how that allows you to get exactly the precision you want in the package that meets your needs... and it's available for installation on your premises now!

Contact Joe Crist, Sales Manager, Microelectronics Operation, (213) 346-6000, Extension 546, or write to:



THE BUNKER-RAMO CORPORATION
DEFENSE SYSTEMS DIVISION
8433 FALLBROOK AVENUE • CANOGA PARK, CALIFORNIA 91304

... units available for
triggers and timers ...

is raised above the gate potential, the device turns on, producing a negative resistance region whose characteristic is determined by the parallel combination of R_1 and R_2 . The turn-on point is therefore controlled by the external resistors, not by intrinsic properties as in the conventional UJT.

Resistors R_{B1} and R_{B2} are unnecessary when the PUT replaces a conventional unijunction. Resistor R_{B1} is often used to bypass the interbase current of the unijunction, which would otherwise trigger the connected SCR. Since R_1 —in the case of the PUT—can be returned directly to ground, there is no current to bypass at the SCR gate. Resistor R_{B2} is used to compensate for temperature and to limit the dissipation of the UJT during capacitor discharge. As R_2 isn't modulated, R_{B2} can be absorbed into it.

Two versions of the PUT are being offered. The D13T1 is intended for use in trigger circuits, and in low- and medium-interval timers. It has a pulse-voltage rise time of 80 nanoseconds with a 6-volt input, and a peak point current of 2 microamperes. The D13T2, designed for use in long-interval timers, has a peak point current of $0.15 \mu\text{a}$ and the same pulse-voltage rise time of 80 nsec.

Both units have the same specifications, and, in some applications, both can function as SCR's. However this is true only when they are used to switch currents less than 150 ma at 25°C .

Specifications

Gate-to-cathode forward voltage	+40 v
Gate-to-cathode reverse voltage	-5 v
Gate-to-anode reverse voltage	+40 v
Anode-to-cathode voltage	± 40 v
D-c anode current	150 ma
Capacitive discharge energy	250 μJoules ($E = \frac{1}{2} CV^2$)
Total average power	300 mw
Operating temperature range	-55° to $+100^\circ\text{C}$
Case size	TO-98, epoxy
Anode-to-gate leakage current	10 na
Gate-to-cathode leakage current	100 na
Price (10,000 units)	39 cents each for D13T1 90 cents each for D13T2

General Electric Co., Bldg. 6, Schenectady, N.Y. [444]

any DIP'll do

One DIP Header
for all DIP's.
Mount it on your panel.
Wire posts automatically
—sharp corners bite wire.
One-piece posts
stand true, stand up.
Plug, unplug your
DIP's quickly, easily.
Low cost.

AMP



PUT YOUR IDEAS INTO ACTION WITH THE HELP OF AMP ENGINEERING . . . WORLDWIDE.
Circle 197 on reader service card

AMP INCORPORATED
Harrisburg, Pa. 17105
Show me what AMP's new Dual In-line Header'll do.

NAME _____
COMPANY _____
ADDRESS _____
CITY _____ STATE _____ ZIP _____

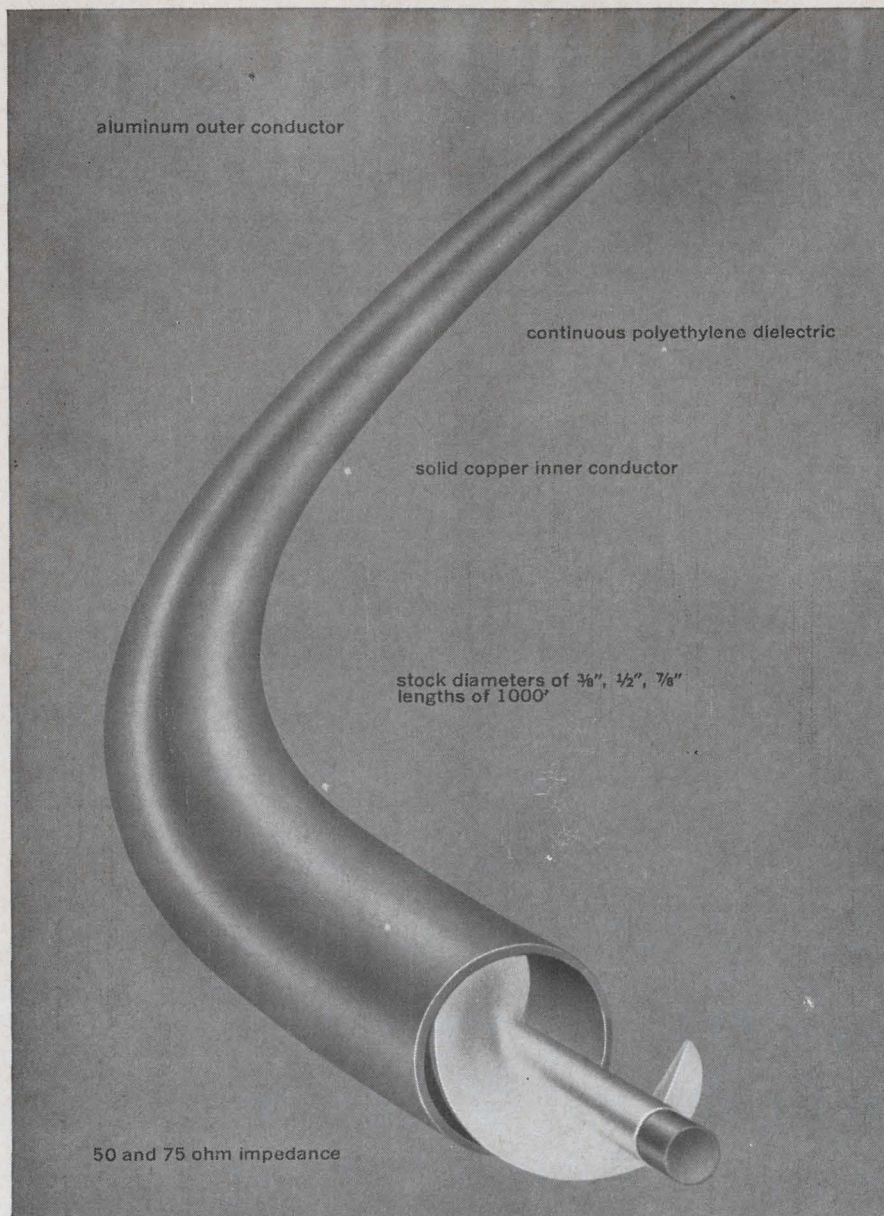

SPIRAFIL® II

Here's the most significant breakthrough in coaxial cable design since we introduced Foamflex in 1959. Spirafil® II is ideal for high frequency communications and UHF air-to-ground communications.

What makes Spirafil® II so radically different is a solid polyethylene helix which completely covers the solid copper center conductor without interruption. Among other things, this means great

mechanical stability with an absolutely non-collapsible helix and higher voltage breakdown. Add to this the advantage of unusually attractive electrical characteristics: low attenuation, extremely high velocity of propagation and excellent dielectric constant.

Price, believe it or not, is competitive with conventional foam cables.

Can we tell you more? Write for your copy of Bulletin SL Issue 1.

PHELPS DODGE ELECTRONIC PRODUCTS
NORTH HAVEN, CONNECTICUT



New semiconductors

Matched FET's —a winning hand

Paired by a computer,
junction units have
better balance than IC's

One way to hold off the encroachment of linear integrated circuits on discrete semiconductors—or at least reduce it—is to come up with transistors matched close enough to produce tracking, drift, and other electrical characteristics to rival those of the IC's.

Generally, the device balance of monolithic circuits is 10 times better than that of discrete circuits. Balance in an IC reflects how alike the transistors are, and how alike they remain through environmental changes. This matching in linear IC's is usually an order of magnitude closer than the best match possible with discrete components.

The balance of an IC is enhanced by the arrangement of the output; each half-circuit response can be summed at the output in such a way that unwanted changes (such as increased leakage) offset one another, and desirable changes (higher gain with rising temperatures, for instance) complement each other.

Thus, the integrated circuit usually provides excellent electrical tracking, maintaining balance in the face of changes in signal levels and temperature. It also provides uniform linearity in the reproduction of input signals, and can compensate for such changes as temperature variations and power supply shifts. But this has changed with the development of a new technique for producing matched, dual field effect transistors.

Siliconix Inc., a manufacturer of field-effect devices, digital IC's, and semiconductor test equipment, is now using a computer-aided matching process for its new dual FET's.

The new FET's are n-channel units whose balance surpasses that of linear IC's. They are designed to be used in high-input-impedance

differential amplifiers.

The company guarantees a 0.97 matching (transconductance ratio) for the 2N5196, the first in the series, making it comparable to Union Carbide's 2N3954 dual, n-channel FET. But the tracking specification of the Siliconix unit—less than 5-microvolt drift per °C tracking—is twice as good as that of Union Carbide's, 10 μV per °C. And the new FET has a maximum offset of 5 millivolts.

Computer's aid. Although selecting adjacent dice on the silicon wafer is effective in matching bipolar transistors, this method isn't reliable for FET's. The actual dice must be accurately measured before packaging. Siliconix uses a computer to keep track of dice in a given batch, then pairs dice having very close characteristics. The yields are very good, says the company.

Siliconix' process isn't a radical technological change. Says one engineer: "It's not a matter of getting the match once and announcing it for every device and then guaranteeing it for everyone. Instead, it's like a car maker guaranteeing his cars for 180 miles per hour. To do this, he must build them for 200 mph."

The other devices in the series include the 2N5197, with a transconductance ratio of 0.97 and a tracking specification of 10 μV ; the 2N5198, 0.95 and 20 μV ; and the 2N5199, 0.95 and 40 μV . Because the tracking specifications are derived from maximum and minimum input measurements, the company says they are really a slope and not point-by-point measurements.

All of the units have low-leakage input-gate current of less than 15 picoamps at 25°C and equivalent input noise voltages of 0.020 μV per

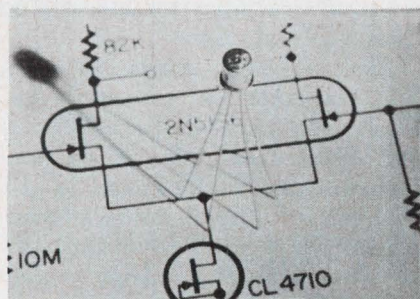

Matched. Dual field effect transistors have matched characteristics that rival those of integrated circuits.

It all began here!

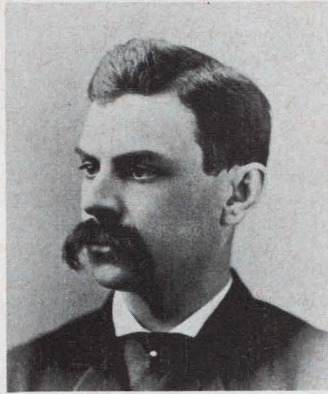

Edwin H. Hall

(Fogg Art Museum, Harvard University)

THE HALL EFFECT

"....In short, the phenomena observed were just such as we should expect to see if the electric current were pressed, but not moved, toward one side of the conductor."*

When Edwin H. Hall wrote these words in 1880, he was not thinking about semiconductors or the effect that now bears his name. In fact, he was a 25-year old graduate student at Johns Hopkins who was looking for a way to prove or disprove a statement made by Maxwell.

In his text "Electricity and Magnetism" Maxwell had said that "a magnetic field acts not upon the current in a conductor, but upon the conductor itself. The conductor will move in obedience to this force."

Hall reasoned that if the current itself is attracted by the magnet, the current should be drawn to one side of the wire and its resistance path should be increased.

To test this theory he used "a magnet that was worked by a battery of twenty Bunsen's cells joined four in a series and five abreast. The strength of the magnetic field . . . was probably fifteen or twenty times H , the horizontal intensity of the earth's magnetism."

A strip of gold leaf mounted on a glass plate was placed between the poles of the electromagnet, with the plate cutting across the lines of force. "The two poles of a sensitive galvanometer were then placed in connexion with different parts of the disk, through which an electric current was passing, until nearly equipotential points were found. The magnet-current was then turned on and the galvanometer was observed in order to detect any indication of a change in the relative potential of the two points.

"I succeeded on the 28th of October in obtaining, as the effect of the magnet's action, a decided deflection of the galvanometer-needle."

*("On the New Action of the Magnet on Electric Currents," *The London, Edinburgh and Dublin Philosophical Magazine and Journal of Science*, Vol. 9.1880)

Fw
"BELL PRODUCTS for PLANNED PROGRESS"

and **NOW** from

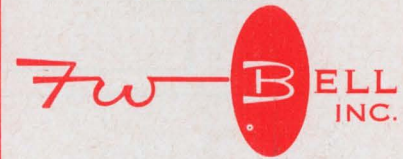

**New Hall effect
GAUSSMETERS
with performance
and versatility
unmatched anywhere**



Model 620 Precalibrated Gaussmeter

A medium priced, precision instrument designed to take full advantage of recently developed high-linearity Hall elements and solid-state circuitry. Unit features precalibrated probes that may be interchanged without recalibration. With built-in calibration accuracy of 0.3%, instrument accuracy is $\pm 1.0\%$ to 30 kG (3 tesla) and $\pm 0.5\%$ to 10 kG (1 tesla) when used with high-linearity probes. Direct ac and dc field readout. One volt FS calibrated output. Temperature compensated probes allow high-stability operation in laboratory or production.



Model 640 Precalibrated Gaussmeter

High performance instrument designed to fulfill all the requirements of the Model 620 plus many more never before offered. The Model 640 offers 1000X scale expansion with automatic and true zero center meter readout. Permits direct measurement of small incremental variations in both a positive and negative direction. Controlled feedback permits incremental operation up to 30 kG. Absolute field measurement accuracy is $\pm 1.0\%$ to 30 kG and $\pm 0.5\%$ to 10 kG using high-linearity probes. Five volt dc auxiliary output. Field measurements can be extended to 100 kG with high field probes.



1356 Norton Avenue
Columbus, Ohio 43212
Phone: 614/294-4906
TWX: 810/482-1716

T-FORMATION

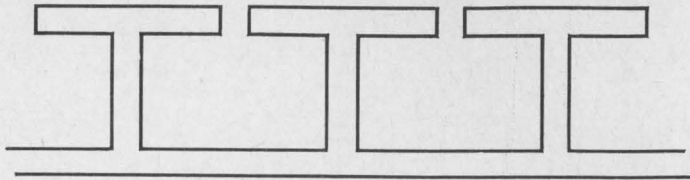

A winning combination for any heat dissipation problem, Astrodyne's patented "T" fin provides 20% or greater cooling surface area than straight fin designs. Available only on Astrodyne heat sinks, the T-fin shortens the thermal path from heat source to fin tip, reduces the space needed for proper heat sinking, and, with proper fin spacing, gives better chimney effect in natural convection cooling.

When the heat's on, don't punt. Try Astrodyne's T-formation.

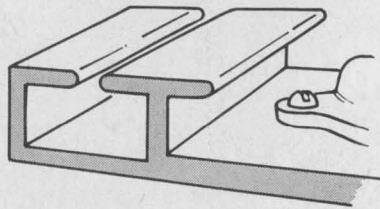

(Free Short Form Catalog of Standard stock heat sinks and list of Distributors in principal cities.)



astrodyne, inc.

SUBSIDIARY OF ROANWELL CORPORATION
207 CAMBRIDGE STREET / BURLINGTON, MASSACHUSETTS 01803
(617) 272-3850

Circle 268 on reader service card

Put VARISTORS in your circuit

They will protect your components, limit noises, and do all others to assure your circuit works all right.

Select right one from varieties of **SanKen** Silicon and SiC Varistors.

Silicon varistors
11 types

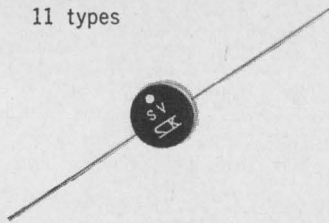

SiC varistors
27 types

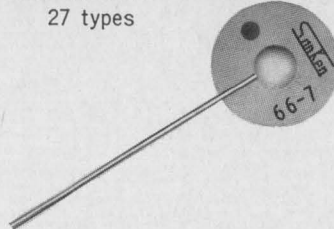

Other Products: Silicon Diodes, Silicon Power Transistors, Selenium Rectifiers, CdS Photo Cells.

SanKen®

SANKEN ELECTRIC CO., LTD.

1-22-8 NISHI-IKEBUKURO, TOSHIMA-KU, TOKYO
PHONE: 986-6151 CABLE: SANKELE TOKYO

... chips can be bought
for hybrid IC's ...

square root of the frequency. Other tightly matched parameters tested at 25°C are differential-gate-source voltages running from 5 to 15 mv, common-source forward transconductance from 1,000 to 4,000 micro-mhos, and a maximum common-source output conductance of 50 μmhos.

Stability up front. While such tightly matched parameters may be more than most designers need, Siliconix is aiming the FET's at users seeking extremely stable devices at the front end of their equipment. Most likely application is in military gear. The 2N5196 is designed for primary standards-type equipment, such as clocks, d-c amplifiers, and the front ends of ic amplifiers. Customers wouldn't buy the 2N5196—priced at \$29.20 each in lots of 100—for \$250 analog computers, but the government might for a satellite.

Siliconix thinks that the others in the series—the 2N5197, priced at \$18.60, the 2N5198 at \$9.30, and the 2N5199 at \$7.75—will find wide-spread use because of their stability across wide temperatures and extreme accuracy, particularly for preamplifier stages.

The company believes that for the present, dual FET's are preferred for preamplifier stages. Its reason: ic's still can't match dual FET's specifications. The FET input current is 15 picoamps for a dual FET, compared with 200 nanoamps for a typical linear ic. However, Siliconix, which second-sources some digital ic's, is experimenting with linear ic's, but has none ready for market. The company also sells chips to hybrid-circuit makers and to users who have facilities for assembling their own hybrids.

To make FET pair selection easy, Siliconix offers a designer's kit, DK7, containing the four differential-amplifier pairs plus two current-limiter diodes, CL4710 and CL6810. The current limiters are two-terminal FET's that provide current loads of 470 and 680 microamps respectively. The kits are sold through Siliconix' distributors for \$84.50.

Siliconix Inc., Sunnyvale, Calif. [445]

Don't sit there
wishing your
 support people
 knew more
 electronics...

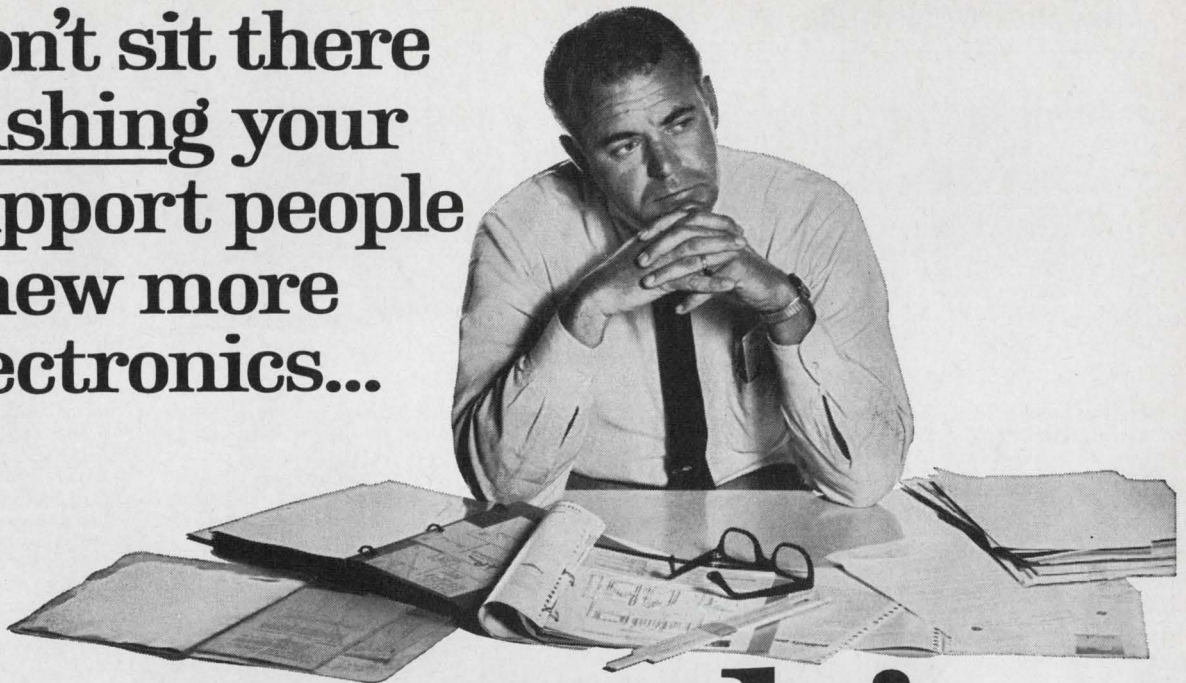

do something

Look over your men. Pick out a few who are intelligent enough to profit from more education in electronics, ambitious enough to work hard to get it. Send us their names and addresses. We'll send them complete information about CREI Home Study Programs in Electronics, tell them how these programs have helped thousands of young men increase their value to their employers. We'll explain how they can study at home, at their own pace, on their own schedule

without traveling to classes. We'll give them the names of the more than 80 leading scientists and engineers who help us develop and update programs related directly to the needs of industry.

Yes, we'll do all that. If you're lucky some of your men may enroll. Why not give it a try? Fill out the coupon and get it in the mail today.



CREI Programs cover these specialized areas of advanced electronics:

- Communications Engineering •
- Aeronautical and Navigational Engineering •
- Television Engineering •
- Computers • Nuclear Instrumentation and Control •
- Automatic Control Engineering •
- Missile and Spacecraft Guidance •
- Radar and Sonar Engineering •
- Nuclear Engineering Technology •
- Industrial Electronics for Automation •
- Computer Systems Technology.

CREI
THE CAPITOL RADIO ENGINEERING INSTITUTE

A Division of McGraw-Hill, Inc.
 Dept. 1850-E, 3224 Sixteenth Street, N.W.
 Washington, D.C. 20010

Gentlemen: The men listed at right are high school graduates working in some phase of electronics. Please send them your FREE book, "How to Prepare Today for Tomorrow's Jobs" and complete information about CREI Home Study Programs.

And please send me the free brochure which tells how we can use CREI Home Study Programs to supplement our educational program for electronics personnel.

Name _____
 Title _____
 Company _____
 Address _____
 City _____ State _____ Zip Code _____

Name _____
 Address _____
 City _____ State _____ Zip Code _____

Name _____
 Address _____
 City _____ State _____ Zip Code _____

Name _____
 Address _____
 City _____ State _____ Zip Code _____

Name _____
 Address _____
 City _____ State _____ Zip Code _____

Name _____
 Address _____
 City _____ State _____ Zip Code _____

(Not enough room? Attach sheet of paper with additional names and addresses)

New Instruments Review

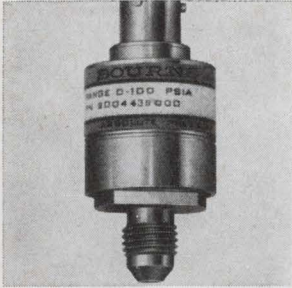

Pressure transducer model 443 has a range of 0-15 to 0-500 psia, an independent static error band of $\pm 1.5\%$, temperature error band of $\pm 2.5\%$, and an operating temperature range of -65° to $+200^\circ\text{F}$. It measures 1 in. in diameter and weighs 2.5 oz. It is rated at 20 g's vibration, 35 g's shock. Bourns Inc., 6135 Magnolia Ave., Riverside, Calif. 92506. [361]

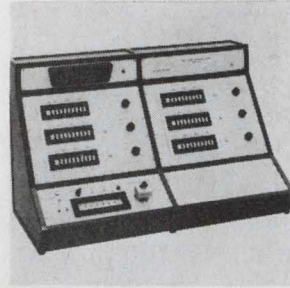

Field-effect transistor tester model 57 is capable of testing 10 parameters at an average speed of 60 msec per test. It is usable in incoming inspection and engineering evaluation labs. Standard options include go/no-go limits and device classifying. Unit is programmed by a variety of mediums. Test Equipment Corp., 2925 Merrell Rd., Dallas 75220. [362]



Digital optical tachometer 505460 is for lab use in measuring the speed of rotating objects. It offers direct digital readout from 100 to 99,000 rpm. Measurement is made by pointing the photo-reflective probe at the rotating object marked to provide fluctuation in reflected light. Clary Corp., Military Products Div., 320 W. Clarey Ave., San Gabriel, Calif. 91776. [363]

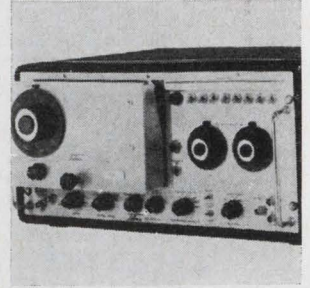

Sweep oscillator 3003 covers 5 to 500 Mhz and can sweep a region as narrow as 200 khz. It is suited for testing f-m broadcast equipment and vhf tv systems. Output voltage is 0.5 v rms; linearity, 1.5:1; flatness, ± 0.75 db at max. sweep; stability, less than 200 Khz drift over a 1 minute span. Telonic Instruments, 60 N. First Ave., Beech Grove, Ind. 46107. [364]

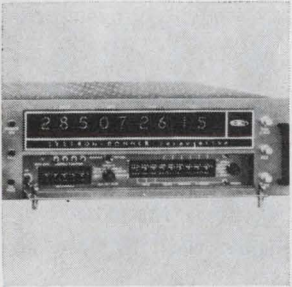

Time code generator HI-160 offers IC design, flexible choice of different time code combinations, and controls that permit quick, precise synchronization commands. The in-line time display reads directly in days, hours, minutes, and seconds. Useful in aerospace applications. Price is from \$3,775. Systron-Donner Corp., 888 Galindo St., Concord, Calif. 94520. [365]

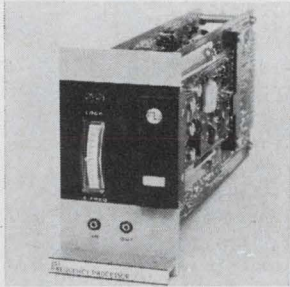

Frequency processor 251 picks out a signal that is buried in noise, tracks it over a wide variation in frequency, processes it through a phase lock filter, and presents it as a clean, high-level square wave. Input range is 1 to 240 khz in 6 plug-in steps; bandwidth, 10 hz to 5% of operating frequency. Interstate Electronics Corp., Box 3117, Anaheim, Calif. 92803. [366]

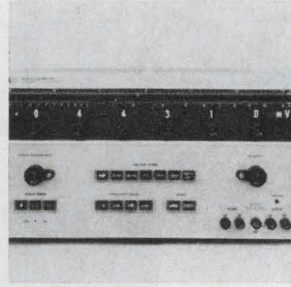

A-c calibrator 745A has an output frequency continuously adjustable from 10 hz to 110 khz in 4 overlapping bands. Output voltage is known with an absolute accuracy of $\pm 0.02\%$ from 50 hz to 20 khz for a period of 30 days following calibration. Maximum output current is 50 ma. Hewlett-Packard Co., 1501 Page Mill Rd., Palo Alto, Calif. 94304. [367]

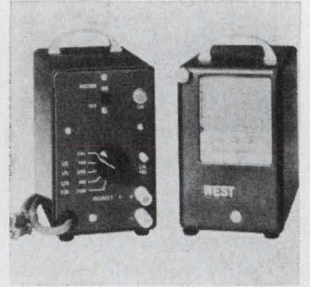

Strip-chart recorder F4 has ranges of 0-400°F and 0-1,200°F with iron-constantan thermocouple and 0-800°F and 0-2,400°F chromel-alumel thermocouple. It features pushbutton calibration for external resistance (23 ohms max.). It is accurate to $\pm 2\%$ of span. Unit measures $5\frac{3}{8} \times 3\frac{3}{8} \times 5\frac{7}{8}$ in. West Instrument Corp., 3860 N. River Rd., Schiller Park, Ill. 60176. [368]

New instruments

Heat can't hide from this thermocouple

Measurements in hottest, most abrasive environments made with transducer developed for missile work

From the throats of rocket engines to the piston rings of automobiles—that's the story of a new line of surface - temperature - measuring thermocouples.

"We're measuring temperature transients above 5,000° F in spots where it's never been possible to

measure before and with response time of less than 10 microseconds," says Jack Nanigian, president of the Nanmac Corp.

Nanmac developed the transducers for operation in gun barrels and the throats of rocket engines under a contract from the Naval

Weapons Station, Dalghren, Va.

Commercial applications include:

- Temperature measurements in almost all parts of internal combustion engines — from exhaust pipes to piston rings.

- Temperature measurement of extrusions, both plastic and metal, while the material is still within the die.

- Brakeshoe, disk, and drum temperature studies as part of automobile safety research.

What's old. Nanmac's thermocouples differ from usual designs which use two wires welded together at their tips to form a bead.

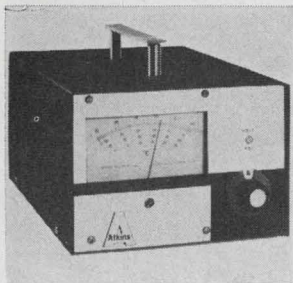

Thermistor thermometers are offered for research, testing, and quality control. Temperatures from -100° to $+300^{\circ}\text{C}$ are covered by a choice of ranges on 4-in. taut-band meter scales. There is 10% overlap between ranges and choice of 0.1° , 0.25° , 0.5° , 1° , and 2° scale division markings. Accuracy is to 1% of span. Atkins Technical Inc., Gainesville, Fla. 32603. [369]

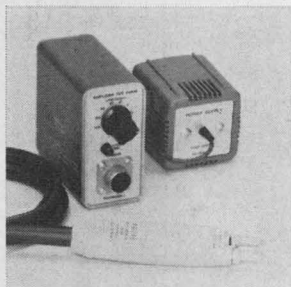

Probe and amplifier P6046, for use with the company's oscilloscopes, have these differential rejection capabilities at the probe tip: 10,000 to 1 at d-c; 1,000 to 1 at 50 Mhz; and 100 to 1 at 100 Mhz. Bandwidth and rise time (3.5 nsec) are constant over deflection factor range from 1 mv/div. to 200 mv/div. Tektronix Inc., Box 500, Beaverton, Ore. 97005. [370]

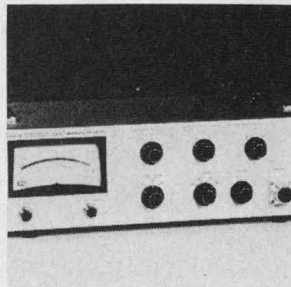

D-c amplifier model 140 provides 10-nv resolution, 0.01% accuracy, and 20-msec rise time for small signal changes. It offers gain ranges of 100 to 100,000, a 50-megohm input impedance, and up to 5 decades dynamic range. Common mode rejection is greater than 140 db. Price is \$1,795. Keithley Instruments Inc., 28775 Aurora Rd., Cleveland, Ohio 44139. [371]

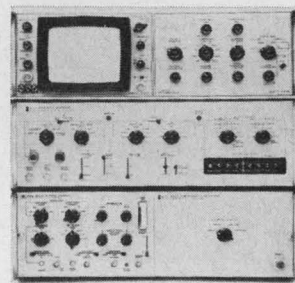

Multichannel analyzer model 5400A, a 1024-channel unit for nuclear measurements, has a 100-Mhz a-d converter. It can process a pulse within 13 μsec . The analyzer also functions as a multiscaler. Pulse pair resolution in this mode is 100 nsec. Memory cycle time is 2.2 μsec . Price is \$9,500. Hewlett-Packard Co., 1501 Page Mill Rd., Palo Alto, Calif. 94304. [372]

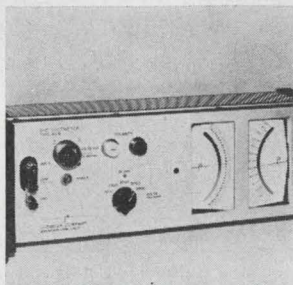

Voltmeter type 415A blends digital and analog circuitry. It measures d-c voltages from the low mv region to 10 kv. Readings provide 4 digits of information with resolution of tenths of a millivolt in the lowest range. About 90% of an input value is presented in digital form; the remainder as analog vernier. J-Omega Co., 2271 Mora Dr., Mtn. View, Calif. 94041. [373]

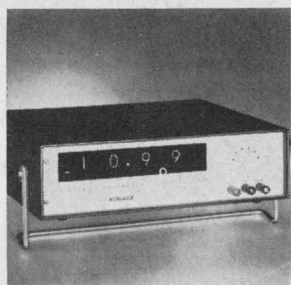

Model 304 dvm features 100- μv sensitivity on the 100-mv range. Nonsegmented, in-line, high-intensity 3-digit readout is provided in 5 ranges: ± 100 mv, 1 v, 10 v, 100 v and 1,000 v. In addition, a fourth digit provides over-range readout at full rated accuracy to 120% of full scale for all ranges. Roback Corp., 602 Buck Rd., Huntingdon Valley, Pa. 19006. [374]



Resistance temperature coefficient plotter TR204A can be set to record deviations of $\pm 0.5\%$ to $\pm 50\%$ full scale over a resistance range of 1 ohm to 100 megohms and a temperature range of -55° to $+165^{\circ}\text{C}$. Variable slope controls provide heating and cooling rates of 5° to 16°C per minute. Trott Electronics Inc., 30 Ridgeland Road, Rochester, N.Y. 14623. [375]

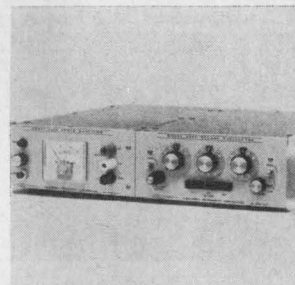

A-c power amplifier model 2200 furnishes 200 v-a of a-c power over a frequency range of 10 to 10,000 hz. Output is 0 to 130 v; total harmonic distortion, 0.25%; line regulation, 0.02%/v; load regulation is adjustable to zero. The unit measures $3\frac{1}{2}$ in. high by 8 in. wide. Price is \$595. California Instruments Corp., 3511 Midway Dr., San Diego, Calif. 92110. [376]

As temperature changes, the voltage across the thermocouple also changes, and this change can be converted into a temperature reading. But standard devices do not have the response time of the Nanmac units—as low as 2-3 microseconds in some applications. Nor will they withstand the punishment of operation in shock tubes or rocket engines where pressures often exceed 50,000 pounds per square inch. The new unit can tell the temperature of grindstone even as it cuts away the device's sensing tip.

What's new. Rather than welded wires, Nanmac's sensing tip is

made of 0.001-inch thick metal alloy strips insulated from each other by mica strips about 0.0002-inches thick. This sandwich is pressed into a tapered well in its mount under 50,000 pounds of pressure to form a gas-tight seal. The mount itself can be any material—plastic, ceramic, or the hardest metal alloys.

The thermal junction that replaces the bead used in common thermocouples is formed by grinding and polishing the sensing tip. Since the junction is formed abrasively, wear in the cylinders of an engine or on a missile nose cone continually forms new junctions in

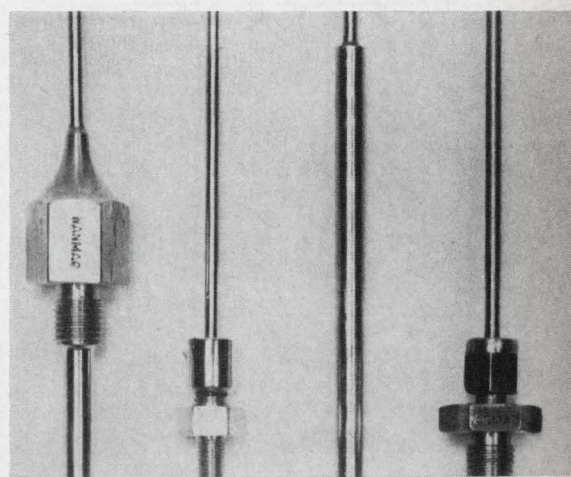

Heat seekers. Units can be used in surface, in-wall or immersion jobs.

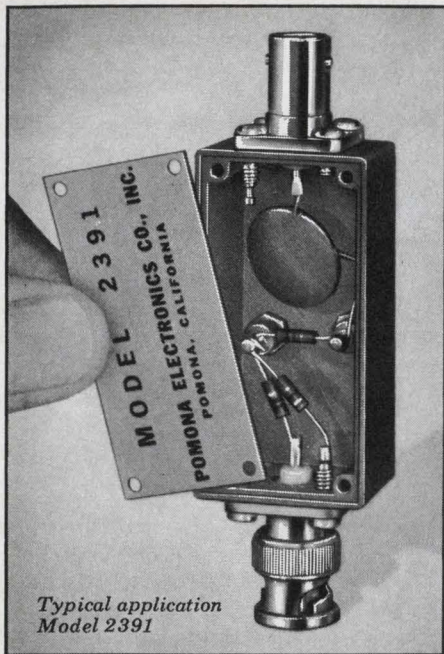

Typical application
Model 2391

SHIELDED BLACK BOXES

To package,
protect and
SHIELD

custom test circuits

(voltage dividers, attenuators, isolation and impedance, networks, etc.). Rugged die-cast aluminum box with aluminum cover, available in 16 different connector combinations. Write for free catalog.

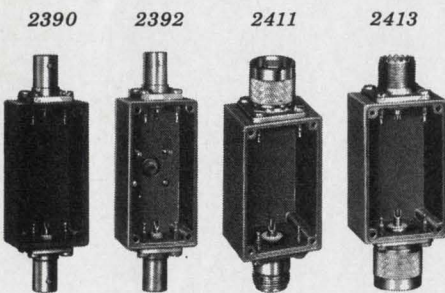

POMONA
ELECTRONICS CO., INC.
1500 E. Ninth Street, Pomona, Calif. 91766

... keeps on measuring
as tip wears away ...

the form of hundreds of tiny welds between the two metal strips. The thermocouples can be worn down $\frac{3}{8}$ of an inch before they fail. Even then it is the pressure seal, not the thermal junction, that gives way to the abrasive force.

Nanmac has sold large numbers of the devices to the Air Force, for studies of airframe heating or ablation. Ohio State University and Republic Aircraft have used the thermocouples in ablation studies and for the first time have been able to gauge the exact temperature of ablative material as it heats and peels away. The thermocouple tip erodes too, but the device goes right on measuring.

Formerly, standard thermocouples were buried in the ablative and, since they were below the surface, the temperature "on top" had to be extrapolated. Sometimes the estimates were as much as 1,000 degrees off, says Nanigian, adding that his devices are accurate to $\pm 1^\circ\text{F}$ and that the university got readings in 2 microseconds.

Early risers. While other thermocouples do not seem to be as rugged as Nanmac's, laboratory types using thin film sensors on ceramic substrates can equal their rise-time. But Nanigian says that these aren't as accurate, since they measure the temperature of the substrate rather than that of the material being studied.

The new thermocouples can do other things besides measuring temperatures. With a fine enough finish on the sensing surface, the electrodes become electrically separate. General Electric Co. has used such finely polished devices to measure ion densities in plasma. The ions bridge the gap between the electrodes; thus the higher the ion density, the greater the flow of electricity through the device.

It can also act as a laser power measuring device. Heat generated by the beam changes the thermocouple's output voltage. Users could also build the thermocouple into the cutting tool of a lathe to gauge the temperature of the material being turned—and thus regulate the rate of cut to keep delicate

YOUR NO.1 SOURCE FOR ALL MAGNETIC MATERIALS

PERMAG

Complete magnetic material inventory ... permanent magnets, high permeability, shielding and core materials and ferrites. Full fabrication facilities. Skilled engineering staff. 24-hour delivery.

PERMAG PACIFIC CORP.
5441 WEST 104th ST., LOS ANGELES, CALIFORNIA 90045
Telephone Area Code (213) 776-5656 TWX [910] 328-6547

PERMAG CENTRAL CORP.
5301-D OTTO AVE., ROSEMONT, ILL. 60018
Telephone Area Code (312) 678-1120

PERMAG MAGNETICS CORP.
formerly EMPIRE MAGNETICS
3130 SOUTH AVENUE, TOLEDO, OHIO 43609
Telephone Area Code (419) 385-4621

PERMAG NORTHEAST CORP.
50 THAYER ROAD, WALTHAM, MASSACHUSETTS 02154
Telephone Area Code (617) 484-0550

PERMAG CORP.
88-06 VAN WYCK EXPRESSWAY, JAMAICA, N.Y. 11418
Telephone Area Code (212) 657-1818 TWX [710] 582-2952

Circle 270 on reader service card

NORTON Magnetic Tape Heads

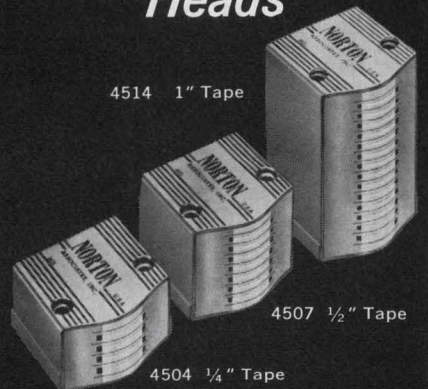

SERIES 4500

Crosstalk—50 DB
+75°C Temperature Operation

Send now for complete technical literature.

NORTON
ASSOCIATES, INC.

10 Di Tomas Court, Copiague, N.Y. 11726
Phone: 516 598-1600

ELECTRO-OPTICAL ENGINEERS AND SCIENTISTS:

Can you contribute to the development of products like these?

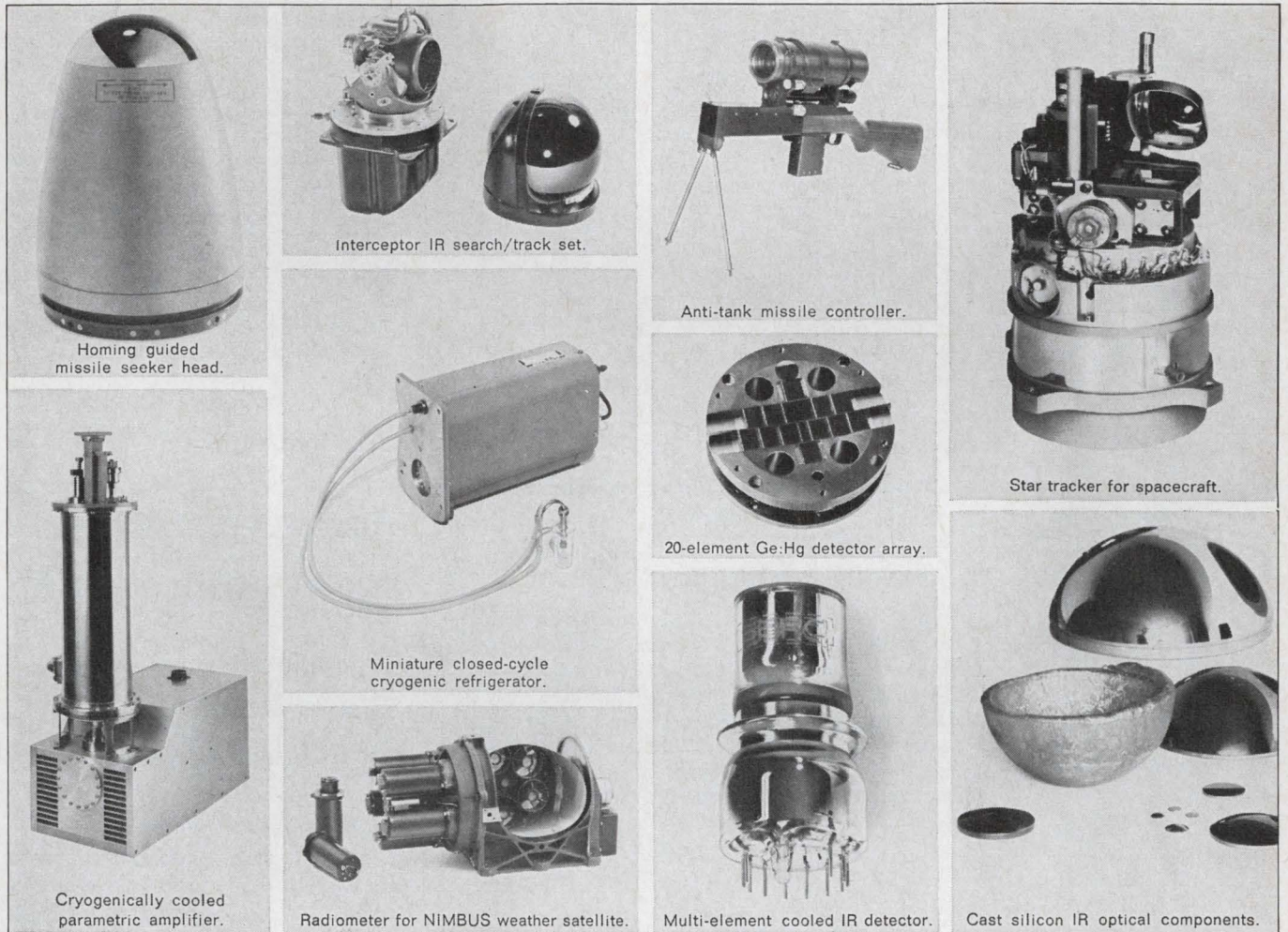

Rapid growth of Hughes electro-optical activities in the Aerospace Divisions and the Santa Barbara Research Center has created many responsible positions for qualified engineers and scientists in all phases of systems development from conception through production engineering.

Immediately available assignments include openings in such diverse technologies as optical design, semiconductor physics, cryogenics, mechanical engi-

neering, precision electro-mechanisms, electronic circuit design, servo systems . . . and many other areas.

Current Hughes contracts include advanced systems for: space exploration, weather satellites, anti-ballistic missile defense, night reconnaissance, aircraft and space vehicle defense, and tactical weapon guidance and fire control.

Professional experience, an accredited degree and U.S. citizenship required.

For immediate consideration, please air-mail your resume to:

Mr. Robert A. Martin
Head of Employment
Dept. 36
Hughes Aerospace Divisions
11940 W. Jefferson Blvd.
Culver City, California 90230



HUGHES AIRCRAFT COMPANY
 AEROSPACE DIVISIONS

An equal opportunity employer

Another Advance in MICRO Miniaturization!

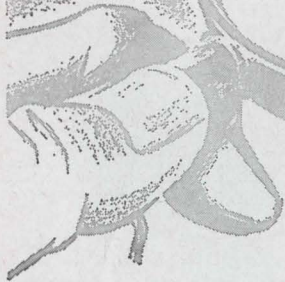

ACTUAL
SIZE



G/M Magnetic Analog Voltage

Four Quadrant Multi-
plication or Squaring
Monolithic Micro Circuit
Block for Analog
Voltage Multiplying of
DC x AC Voltages

Addition, Subtraction,
Multiplication, Division
and Extracting a
Root of Many Voltage
Variables may be
Handled by one G/M
Magnetic Microblock

Product Accuracy of
up to 0.5% of Full
Scale, with very slight
Derating over a Wide
Temperature Range

Multiplying Modulators

Monolithic Analog Computing Modules

Featuring

**THE WORLD'S SMALLEST AND MOST
RELIABLE MAGNETIC MICROBLOCK**

Available as small as 0.1 cubic inch and weighing as little as 0.1 ounce, G/M Micro Magnetic Multipliers feature extreme stability with negligible change of product over wide temperature range, and are high shock and vibration proof. Bandwidth may be extended into the kilocycle range. Utilizing low milliwatt power consumption, they are rugged and may be mounted directly on printed circuit cards.

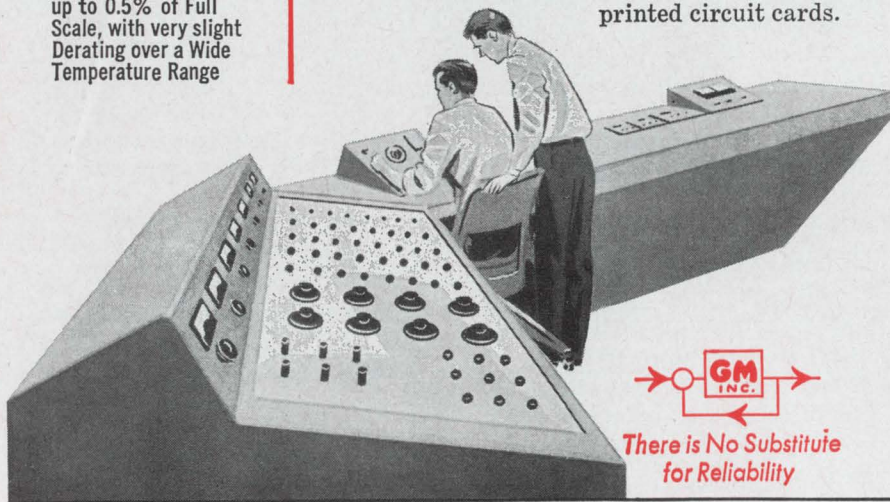

There is No Substitute
for Reliability

Write for Illustrated Bulletin MM 109

General Magnetics • Inc

135 Bloomfield Ave., Bloomfield, N.J. 07003

... device can measure
low temperatures too ...

materials cool while they are machined.

Besides measuring high temperatures, the thermocouple will operate at temperatures as low as -320°F and could thus be used to study the moving parts of cryogenic refrigerators and other low-temperature equipment.

Specifications

Rise time	10 μsecs max 2 - 3 μsecs reported
Temperature range	-320°F to $2,000^{\circ}\text{F}$ continuous
Accuracy	$\pm 1^{\circ}\text{F}$
Maximum pressure	more than 20,000 psi
Tip erosion before failure	3/8 in.
Temperature measurement during erosion	continuous
Maximum velocity of medium being gauged	6,000 fps
Output voltage	20 to 50 mv
Price	\$75 to \$125
Delivery	3 to 6 weeks

The Nanmac Corp., Needham Heights, Mass. 02194 [377]

New instruments

Testing plated wire for memories' sake

Rig generates own noise,
simulates computer
environment to probe film

Plated-wire memories are so new that companies making them have had to jury-rig their own test systems to make sure that the magnetic properties of the iron-nickel film are what they are supposed to be.

E-H Laboratories Inc. is marketing what it calls the first commercially available system for testing plated wires.

The Model 8305 operates with a test rig much like the plated wire's environment in a computer memory, with "word strap" normal to the wire.

But in order to test the properties of the film alone, the test rig has a dummy wire, unplated, in parallel with the plated wire. Pulses produced by a transformer across the two wires are attributable

solely to the plating.

The tester uses three word straps—one to test a bit position on the wire and one on each side to determine the effect of nearby pulses in a real memory.

Noisemaker. To approximate more closely actual memory conditions, the system generates its own noise. Although a plated wire is a nondestructive readout memory element, explains Robert Broughton, applications engineer, its memory content will be degraded somewhat by many "reads." After 100,000 readings, the bit pulse may have lost as much as a fifth of its strength, but it should remain fairly constant after that. Many of the outputs of the word generator, consequently, provide only "disturbs" on the wire. A special strobing voltmeter is pulsed four times during any one cycle, to determine undisturbed voltage for a 0, disturbed voltage for a 0, undisturbed voltage for a 1, and disturbed voltage for a 1.

The total test pattern, with some bits repeated, takes 40 microseconds. During this time the wire moves 5 to 10 millionths of an inch.

"The manufacturer is actually testing his process," says E-H Product Manager Doug Curé. "He provides a stimulus and measures its effect." But Curé says that the E-H system provides resolution 10 times as great as equipment that does not include the special voltmeter. This instrument, which stretches and amplifies pulses, can pick off pulses that change at the rate of one or two microseconds per millivolt (risetime for both word and bit currents is 25 nsec.).

Normally, Broughton says, bit currents will be supplied and picked off with mercury cups through which the wires can run. The sense output can be fed to a logic unit which controls a wire chopper, so that bad chunks of wire can be discarded automatically.

The Model 8305 system is supplied in a two-bay cabinet with the word generator, two six-channel pulse drivers, four six-channel timing units, the strobing voltmeter, a four-channel analog comparator, and a five-inch x-y oscilloscope display unit.

E-H Research Laboratories Inc., Oakland, Calif. 94607 [378]

reliable switches

FOR THE BOEING 727

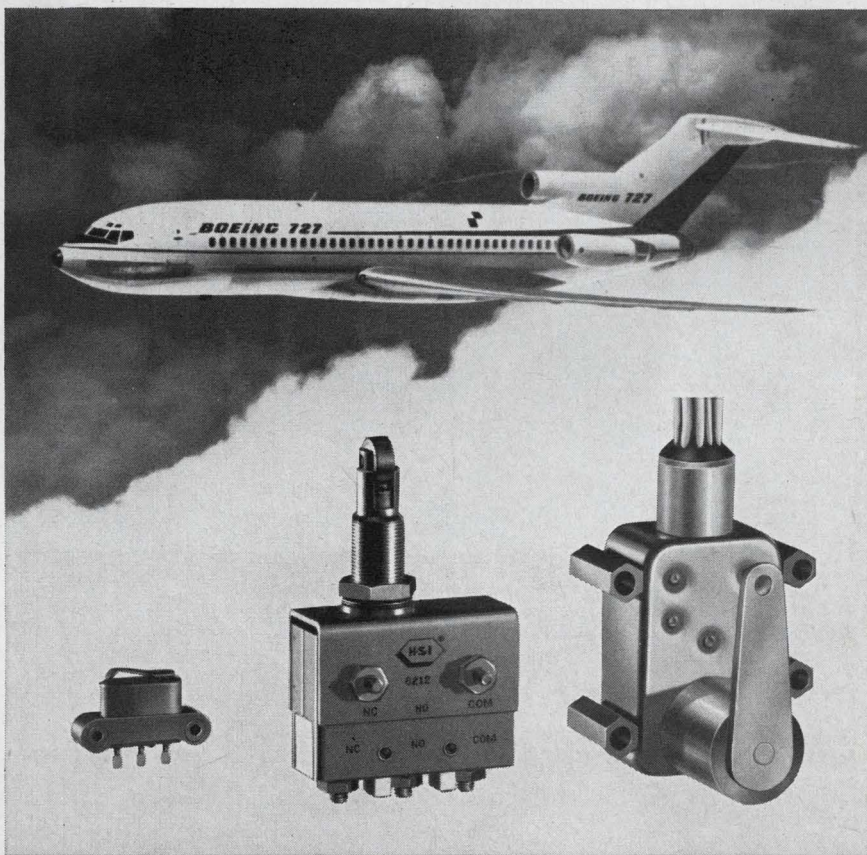

HSI sealed switches have successfully performed critical tasks on the Boeing 727 since the start of the program. That means faithful performance during thousands of flight hours.

The HSI Flap, Leading Edge Slat, and Landing Gear Switches have patented elastomer-bonded rotary seals and heliarc welded stainless steel enclosure. These features provide positive protection against severe environmental conditions of humidity, altitude and temperature.

The HSI hermetically sealed Engine Thrust Reverser Lockout Switches operate in ambient temperatures of -65° to $+660^{\circ}$ F. This capability comes from years of experience with high temperature applications.

Furthermore, the one-piece blade design of these switches provides unusually high contact pressures making the switches insensitive to severe vibration conditions. Call HSI for answers to special switching problems. Send for data sheets.



HAYDON SWITCH & INSTRUMENT, INC.

Where Optimum Performance is Standard

1500 Meriden Road, Waterbury, Conn. 06720/Area Code (203) 756-7441

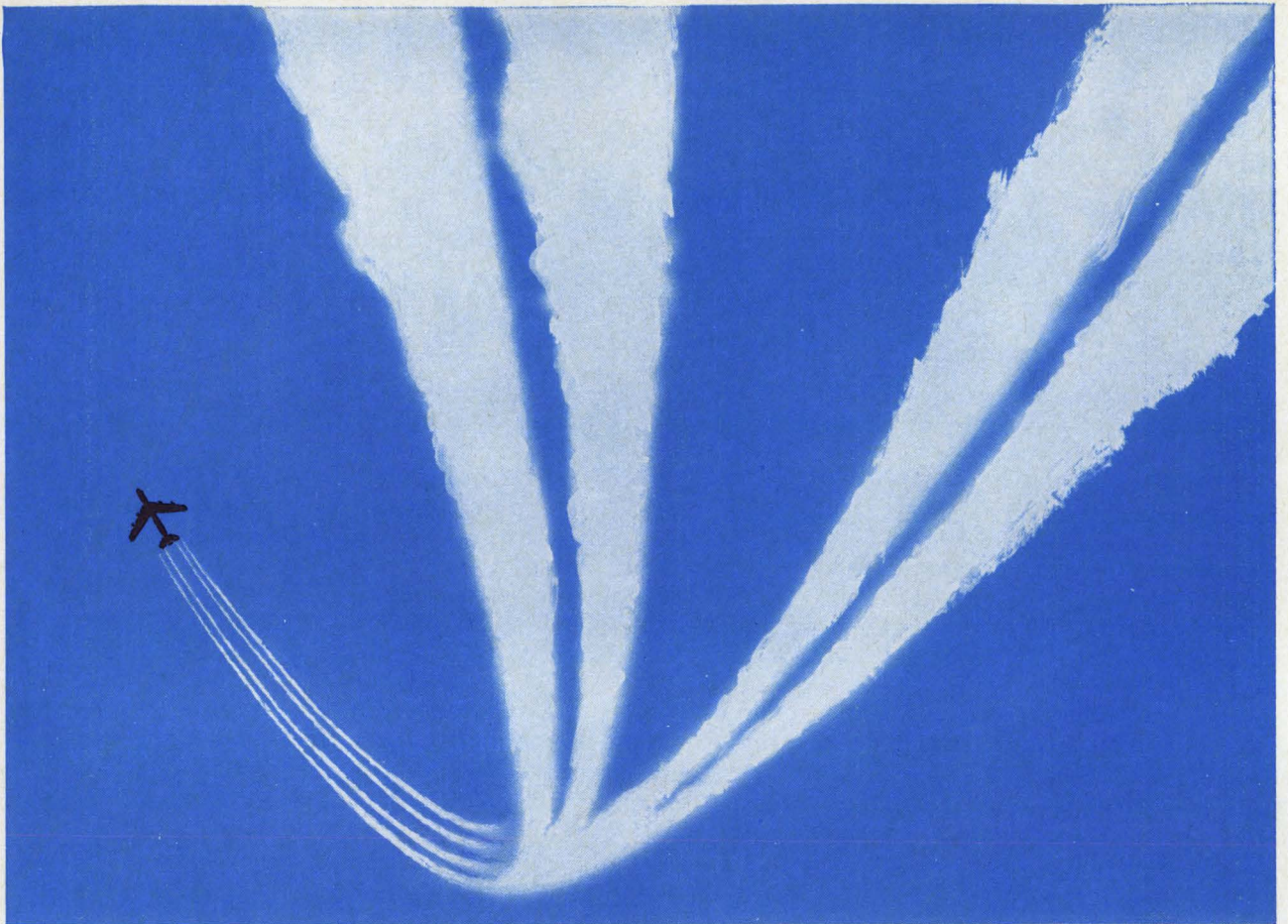

Our abrasion-resistant TFE wire keeps on flying after others call it quits.

Keeps flying up to 12 times longer, as proved in use on six leading types of commercial and military jets. Reason? It's 100% more abrasion resistant than other airframe wires. Because it has a tough insulation core of mineral-reinforced TFE bonded between pure TFE layers.

Our wire also averages 50% smaller in diameter and 60% lighter in weight than comparably rated wires. It can operate continuously at 500°F and remain tough at -450°F. It's nonflammable, nonhygroscopic, highly resistant to chemicals, has optimum dielectric properties and good flexibility.

Right now, it's reducing wire replacements in aviation, mining, refining, ground transportation and railroad equipment manufacturing. It can do the same for your application. For a free test sample and further data, write: ITT Wire and Cable Division, International Telephone and Telegraph Corporation, Clinton, Mass. 01510.

WIRE AND CABLE **ITT**

New Subassemblies Review

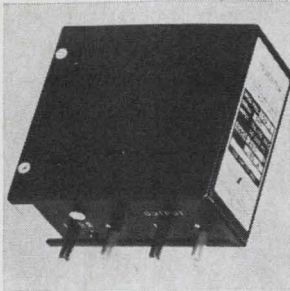

Solid state Thinverter power supply module PHU-L has voltage output regulation within 0.2% for load changes up to 20 w. It is rated at 40 w. Outputs range from 2 v to 5 kv d-c. Inputs range from 115 v rms, 50 to 500 hz or 28 v d-c. The unit is 1½ in. thick and weighs 27 oz. Prices begin at \$160. Arnold Magnetics Corp., 6050 W. Jefferson Blvd., Los Angeles, 90016 [381]

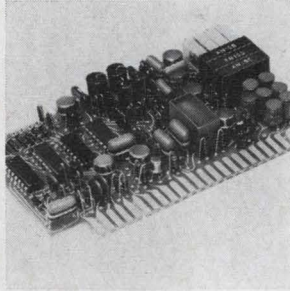

Medium-speed a-d converter model AN2317 uses integrating techniques to perform a 4-digit (plus sign) conversion in 150 msec max., and is self-contained on a 2½ x 4½ in. card. Only power and an output register of either binary or BCD format is required to provide 0.01% accuracy over 0° to 70°C. Analogic Co., 296 Newton St., Waltham, Mass. 02154. [382]



Resonator-controlled oscillator model 211 performs under 10 g's vibration at operating frequency, 50 g's shock, and temperature from -65° to +125°C. Frequency accuracy to 0.01% is a function of temperature, with 0.025% from -40° to +80°C typical. Operating frequency is from 400 to 2,500 hz. Armec Corp., 195 West Hills Rd., Huntington Sta., N.Y. 11746. [383]

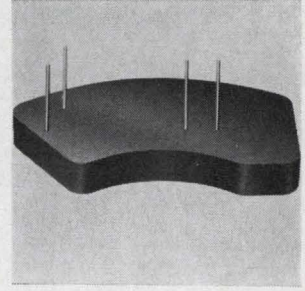

Miniature delay lines, with a delay time range from 1 nsec to 1,000 μsec, have a frequency response greater than 1,000 khz and impedances from 50 to 2,000 ohms. Relay tolerances are ±2% or better, with a temperature range from -55° to +125°C. Output pulse distortion of ±10% max. is maintained. RCL Electronics Inc., 700 S. 21st St., Irvington, N.J. 07111. [384]

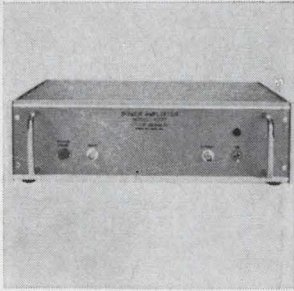

Distributed amplifier model 4007 produces low-pass response to 225 Mhz. Low frequency cutoff is 100 khz, with an output of 20 v p-p to 50 Mhz, 15 v p-p to 100 Mhz, and 10 v p-p to 200 Mhz, into a 75-ohm load with 1-db compression. Typical gain is 20 db. Price is \$800; delivery, 30 days. C-Cor Electronics Inc., 60 Decibel Road, State College, Pa. 16801. [385]

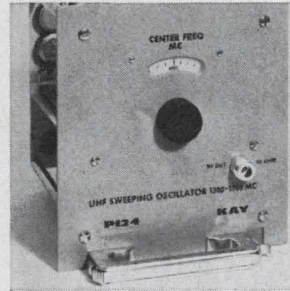

Solid state plug-in P124A extends the range of the model 121C wide-sweep marker generator to 1.7 Ghz. The unit covers its range of 1.3 to 1.7 Ghz in a 400-Mhz wide sweep. The fundamental frequency (0.5 v rms output) is held constant by fast-acting agc circuits. Sweep width is 500 khz to 400 Mhz. Flatness is ±0.5 db. Kay Electric Co., Pine Brook, N.J. 07058. [386]

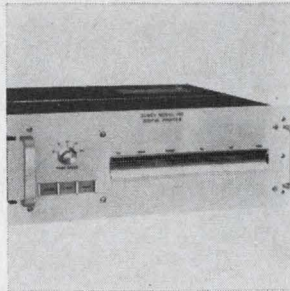

Digital printer 152 is used in data systems where a permanent record and visual readout are required. It has a 30-column capacity. Printing speed is variable up to 240 lines per minute. Data input can be either serial or parallel entry with storage input speed for serial entry in excess of 1 million bits/sec. Sonex Inc., 20 E. Herman St., Philadelphia, Pa. 19144. [387]

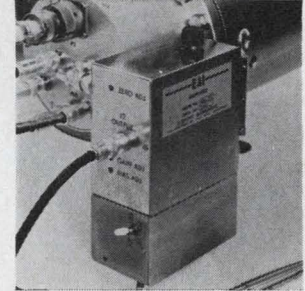

D-c amplifier ESA-75 accepts positive or negative input current in any of 4 fixed gains from 10⁻⁴ to 10⁻¹⁰ amps for full-scale output (10 v) plus 8-decade logarithmic range 10⁻⁴ amps for full output. D-c linearity is within 0.1% of full scale up to ±10 v output. Price is \$595, availability from stock. EAI Scientific Instruments, 4151 Middlefield Rd., Palo Alto, Calif. 94303. [388]

New subassemblies

Putting the squeeze on recorded data

Accessory for data-processing equipment uses coding method to increase information content of magnetic tapes or disks

An old technique—but with a difference—makes it possible to further increase the information content of a wide variety of data storage units which use magnetic recording.

Many tape units, disk-pack drives and similar devices now available

use phase encoding in which every bit, whether a 1 or 0, is represented by a reversal of magnetic flux. It permits about twice the information density possible with the older method, non-return-to-zero (NRZ), in which only 1's were stored as flux reversals.

Potter Instrument Co. is marketing an accessory called Adlogic which can increase by 50% to 70% the density of data in any equipment using phase encoding. The method involves a timing bit inserted after every pair of data bits and a modified encoding scheme.

More and faster. The increased density means that more data can be stored on a length of tape, a section of a disk or other magnetic material, and that it can be transmitted to or from a computer at greater speed.

Adlogic is a collection of integrated circuits on printed-circuit boards. It can be wired to the con-

Who's foolhardy enough to pay people to try to put his business out of business?

Some company called Poly-Scientific.

For years we've been in the slip-ring business. We make them in every size and shape. And to any parameter. So we like to think we're experts in the field. But we've often thought "Maybe something else would work better."

Recently, we decided to explore the idea.

With the help of our next-door neighbor, Virginia Tech, we set up a Scientific Advisory Board. Its mission: To think new processes, new materials, new products.

Four regular members— Ph.D.'s and professors who periodically meet with our own top people—make up the SAB. Each represents a separate scientific discipline. Often a visiting VIP sits in on the brainstorming sessions.

Naturally, some of their ideas get pretty far out—but we've already seen some practical benefits. Our new Captach Switch described on the opposite page is an example.

It's just one of the many useful ideas resulting from our Scientific Advisory Board. You'll be hearing about more in the future. If anybody puts us out of business—we're going to make sure it's us.

Care to have a foolhardy company like this working for you?

POLY-SCIENTIFIC 
A DIVISION OF LITTON INDUSTRIES

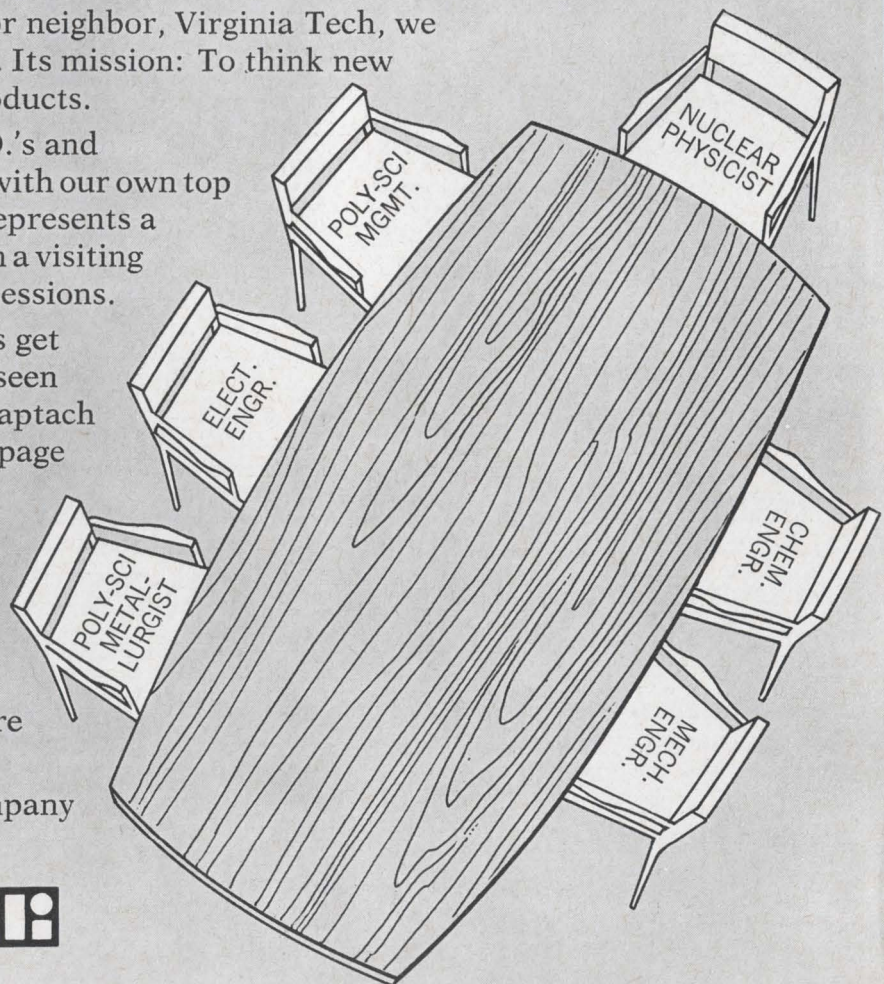

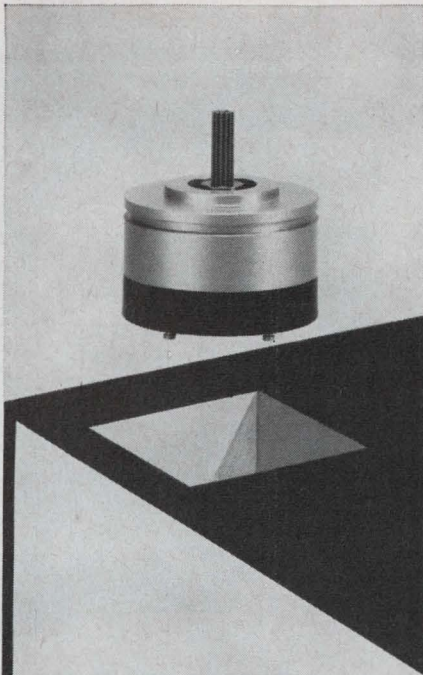

"BLACK BOX" components like our new mechanically driven, 24-contact Captach Switch exemplify our ability to meet complex rotary-switch requirements for shaft integrator systems of airborne computers.

The tiny unit (0.8" x 1.062" OD) features a 13-tooth pinion drive shaft (diametral pitch .120") extending 0.47" outside the housing. Other specs for this 0.9-oz. device include:

- Breakaway torque: 0.015 to 0.05 oz.-in.
- Continuous rotational speed: 0 to 3600 rpm
- Life: 10 million revolutions (min.)
- Shaft runout: 0.001 TIR
- Shaft end play: 0.0015 TIR
- Shaft radial play: 0.0008 TIR

Specify your design problem to Poly-Sci. We'll specify your solution. Mail coupon or call Robert Gardner at 703/552-3011. Or TWX 710-875-3692. On the West Coast, call Jim Swallow, at 213/887-3361.

Poly-Scientific Division ★ ★
Litton Industries
1111 N. Main St., Blacksburg, Va.
Tell me how Poly-Sci is qualified to solve my design problem.

Name _____

Title _____

Company _____

Address _____

City _____ State _____ Zip _____

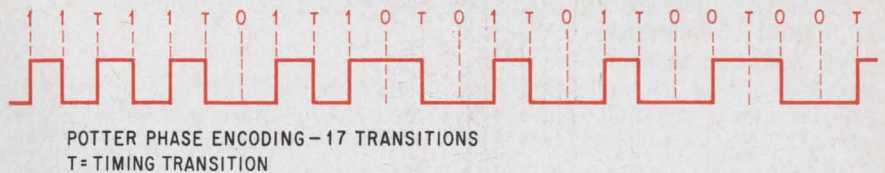
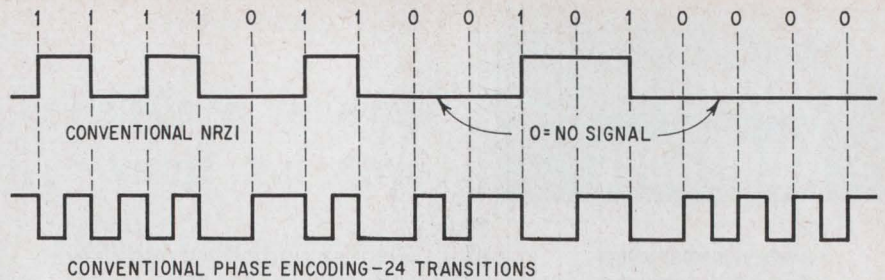

Fewer transitions, more data. The Potter technique squeezes more data onto a recording by putting two bits between timing pulses.

control unit of a high-density tape handler, disk pack, random access memory or other device using phase encoding.

"It intercepts data transmitted from the control unit, converts it into a self-clocked signal at a higher effective data rate, and forwards it to the device," says Henry P. Kilroy, vice president of engineering at Potter. "It also picks up data, when reading, converts it the other way, and returns it to the control unit."

Self-timing. In conventional phase encoding, as shown above, the transition frequency and the output pulse frequency for a string of successive 1's or successive 0's is twice that for a string of alternating 1's and 0's. Thus a strip containing 1,000 transitions at maximum density can contain no more than 500 bits.

Potter's improved version of phase encoding incorporates additional flux reversals specifically for timing, and represents 0's by the absence of reversals. It permits two bits to be recorded between timing transitions, so that a strip of 1,000 transitions at maximum density contains 667 bits—a 33% increase over the conventional method. The increase is achieved without increasing the actual density of signals on the tape, and without changing the frequency response of the reading head or the electronic circuitry.

There's a catch. With 0's recorded as the absence of transitions, two 0's in a row create a rel-

atively wide space between two timing transitions, and this can affect the timing drastically because of a phenomenon called pulse crowding.

To correct this tendency, the Potter equipment records data on the magnetic medium in two modes. Mode 1 is used for every pair of bits that includes at least one 1 bit. When two consecutive 0's show up, the unit switches to mode 2, in which it records the 00 and the two following bits in such a way that at least two transitions are guaranteed for the four bits. The extra logic to do this switching is the price paid, instead of higher recording density or higher frequency response.

The principal advantage of phase encoding is its self-clocking capability, requiring no separate timing track or electronic synchronized timing device. The advantage of Potter's technique is its increased density for a given frequency response. Both techniques are highly reliable, because a loss of signal caused by a defect on the recording surface is easily distinguished from a string of 0's.

In conventional non-return-to-zero recording, the industry standard before phase encoding and still an important technique, artifices such as interspersed synchronizing bits or parity checking bits are necessary to distinguish a string of 0's from a dropout—signal loss due to a defect.

Potter Instrument Co., Plainview, N.Y.
[389]

USE THESE...

Logarithmic Amplifiers

for

- Wide dynamic range
- Exceptional accuracy

LEL log amplifiers are sequential detection type units. Most solid state models offer logging accuracy of ± 1 dB. Log accuracy of models ITL-2-160, ITA-5 and IML-1 is ± 2 dB. Input impedances are 50 ohms. Outputs are video.

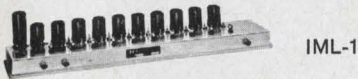

IML-1

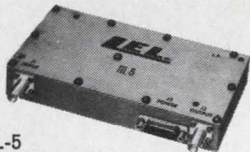

ITL-5

standard models

Model No.	Center Freq. MHz	Bandwidth @ 3 dB MHz	Input dynamic range dB	Sensitivity mV/dB
solid state				
ITL-1-30-04-50	30	4	60	50
ITL-1-30-08-50	30	8	60	50
ITL-1-60-04-50	60	4	60	50
ITL-1-60-08-50	60	8	60	50
ITL-2-30-10-50	30	10	80	20
ITL-2-30-18-50	30	18	80	20
ITL-2-60-10-50	60	10	80	20
ITL-2-60-20-50	60	20	80	20
ITL-2-70-10-50	70	10	80	20
ITL-2-70-30-50	70	30	80	20
ITL-2-160-10-50	160	10	80	20
ITL-2-160-30-50	160	30	80	20
ITL-3-30-03-50	30	3	50	50
ITL-4-30-10-50	30	10	80	20
ITL-4-60-10-50	60	10	80	20
ITL-4-70-10-50	70	10	80	20
ITL-5-30-08-50	30	8	70	40
ITL-5-60-08-50	60	8	70	40
miniature tube				
IML-1-30-04-50	30	4	80	25
IML-1-30-08-50	30	8	80	25
IML-1-60-04-50	60	4	80	25
IML-1-60-08-50	60	8	80	25



LEL DIVISION
VARIAN associates

AKRON ST., COPIAGUE, L. I., NEW YORK 11726
(516) AMityville 4-2200/(516) PYramid 9-8200
TWX Code 516-691-5085

New subassemblies

Making a splash with ink spray

Printer uses charged drops of ink to form characters quickly and noiselessly

Computer speeds have increased a thousandfold from the earliest models to the latest third-generation equipment. Meanwhile, peripheral equipment—card readers, punches, printers—has lagged badly because it is mainly electromechanical.

An electronic approach is taken in a new Teletype Corp. printer. Called Inktronic, the printer sprays drops of electrically charged ink through nozzles. Deflection plates, similar to those in a cathode-ray tube, cause the stream of dots to trace a character on the paper.

Unlike the conventional, clattering teleprinter, which prints 150 words a minute at the most, the new unit operates at up to 120 characters a second—corresponding to 1,200 words a minute. It includes a transformer core memory system that stores character data, a character generator, and two digital-to-analog converters that provide the analog signals to drive the deflection amplifiers.

Quiet enough. Because it has few

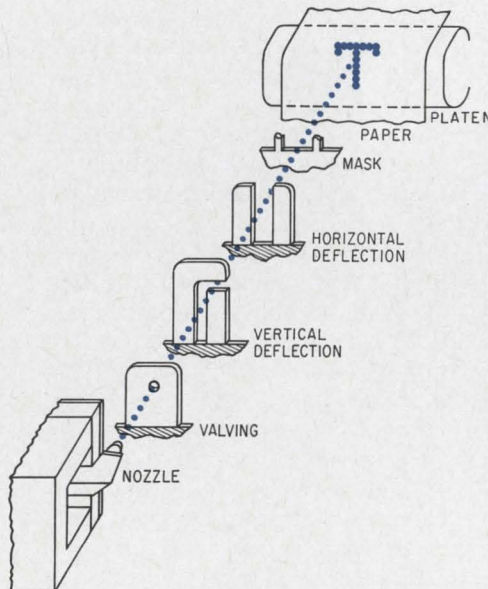

Jetprint. Characters are shaped by spraying ink droplets from nozzles.



\$1485*
is the price of it!

CURTIS ELAPSED TIME METER designed to meet MIL-I-81219

- 50 MW POWER
- 2 GRAMS WEIGHT
- 1000 HOUR SCALE
- $\pm 3\%$ ACCURACY
- DIRECT READING
- AC AND DC MODELS

Write for complete details on the entire Curtis line of elapsed time meters and ampere hour meters . . . they're yours for the asking.

* Curtis standard Model 620-N elapsed time meter is priced at \$14.85 when purchased in lots of 1,000.

Curtis Instruments, Inc.

351 Lexington Ave., Mount Kisco, N.Y. 10549
Tel: 914-666-2971 TWX: 710-571-2163

MATSUO

Highly Reliable Capacitors

POLYESTER FILM CAPACITORS.

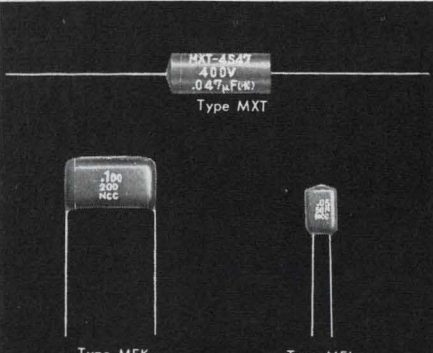

Type MXT In plastic tube.
Capacitance Range: .001 MFD to .22 MFD.
Voltages: 100v, 200v, 400v, 600v DC.

Type MFK Dipped flat shape, non-inductive construction.
Capacitance Range: .01 MFD to .47 MFD.
Voltages: 100v, 200v, 400v, 600v DC.

Type MFL Dipped flat shape.
Capacitance Range: .001 MFD to .22 MFD.
Voltages: 50v, 100v, 200v DC.

METALLIZED POLYESTER FILM CAPACITORS.



Type FNX-H Mylar wrapped semi oval with epoxy end seal.
Capacitance Range: 1 MFD to 10 MFD
Voltages: 100v, 200v, 400v, 600v DC.

SOLID TANTALUM CAPACITORS.

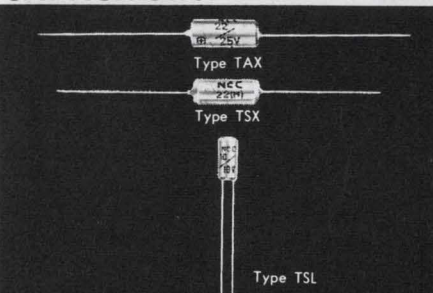

Type TAX MIL-C-26655A hermetically sealed.

Type TSX · TSL Sealed with epoxy resin.
Capacitance Range: .22 MFD to 330 MFD.
Voltages: 3v, 5v, 10v, 15v, 20v, 25v, 35v, 50v DC.

for full details, contact :

MATSUO ELECTRIC CO., LTD.

3-chome, Sennari-cho, Toyonaka-shi, Osaka, Japan
Cable Address "NCC MATSUO" OSAKA

moving parts, the printer is virtually silent—except for the flapping of the paper. There are no keys and the carriage doesn't move from side to side. Characters are formed by spraying small drops of ink sequentially through 40 nozzles—each capable of printing two characters. The drops are drawn out of the nozzles when a voltage is applied to a valve at each nozzle. Electrodes then deflect the drops vertically and horizontally to form the characters. Up to 80 characters per line can be printed on conventional teletypewriter paper.

A one-nozzle printer was introduced last spring by Recognition Equipment Inc., but it prints only coded marks on moving paper as part of a sorting process.

Inktronic accepts data in ASCII (American Standard Code for Information Interchange), but the company plans to have it accept five-level Baudot code as well.

Stream of characters. Like conventional teletypewriters, the machine prints one character at a time. As every other character is received, one ink nozzle is energized by a reed relay, then the others are activated in sequence.

Each character is decoded to select one of 64 subroutines in a read-only memory, and each subroutine contains 32 words of seven bits each—four of which set up a vertical deflection to 1 of 10 possible positions while the remainder set up a horizontal deflection to one of eight positions. The 32 words in the subroutine deflect 32 droplets to different positions so they trace out a character on the paper.

The digital-to-analog converters (one for vertical and the other for horizontal) convert the digital signals to 5- to 10-volt analog outputs, which are used by three sets of two operational amplifiers to direct the ink jets. The d-c amplifiers operate at 800 to 2,800 volts, depending on the amount of deflection needed to shape the characters. Gain is 300 for the horizontal and 200 for the vertical amplifiers.

Major applications, the company feels, are computer printout, input or interrogation when the machine is furnished with a keyboard; monitor for high-speed tape-to-tape systems; and communication terminals for voice-grade channels.

Teletype Corp., Skokie, Ill. [390]

ECCO REFLECTOR® RADAR TARGET

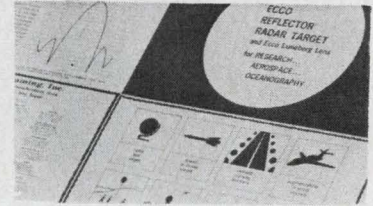

NEW FOLDER

Based on the Luneberg Lens, the Ecco Reflector is a wide-angle, constant cross section radar reflective device. Four-page folder in color describes monostatic, bistatic, omnizimuthal and omni-directional types.

Circle 503 on reader service card

ECCOSORB® ANECHOIC CHAMBERS NEW DESIGNS 7

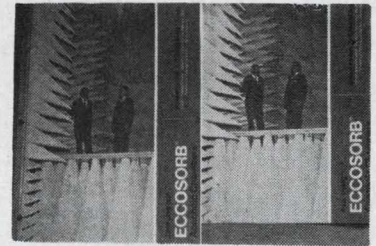

Illustrated folder gives details on anechoic and shielding performance of several new chambers used for antenna pattern, radar cross section, VSWR and RF compatibility measurements.

Circle 504 on reader service card

STYCAST® HiK High Dielectric Constant Plastics

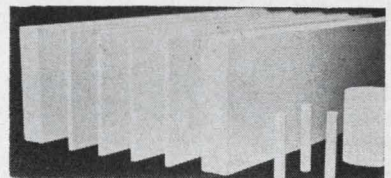

Machineable rod and sheet with K' ranging from 1.8 to 25. Dissipation factor is below 0.002—for waveguide, coax, antennas. Stable in severe environments. Proven in hundreds of applications.

Circle 505 on reader service card

Emerson & Cuming, Inc.



CANTON, MASS.
GARDENA, CALIF.
NORTHBROOK, ILL.
Sales Offices
in Principal Cities

EMERSON & CUMING EUROPE N.V., Oevel, Belgium



**They
all
look
alike...**

...INSIDE!

Sure, the outside configurations vary. But inside, all Microlab/FXR Dummy Loads are basically the same. Which means you benefit in terms of low cost and prompt delivery, even on so-called "specials."

All Microlab/FXR Dummy Loads draw on pre-designed and qualified interchangeable parts and subassemblies. This includes flanges, fins and lossy materials, of course. Even in the case of housings, where there are several different types, there is a great degree of interchangeability within each type. And perhaps most important, all Microlab/FXR Dummy Loads are based on over 20 years of Bogart experience in the design and manufacture of the finest loads in the business.

All of this has combined to produce what we call our "standard designs." But we receive special requests every day: Special heat transfer problems, unusual peak and average power handling needs, particular environmental requirements—these assignments are also taken in stride, thanks to our depth of experience in this field. Water loads—air or liquid cooled loads—from L Band through U—the same Microlab parts, coupled with Bogart-developed skills in design, engineering, and manufacturing serve to solve every problem.

For more information about the complete line of Microlab/FXR Dummy Loads, and a copy of our newest Catalog, write us at Dept. E-62.



MICROLAB/FXR

Livingston, New Jersey 07039 Phones: (201) 992-7700; (212) 721-9000

New Microwave Review

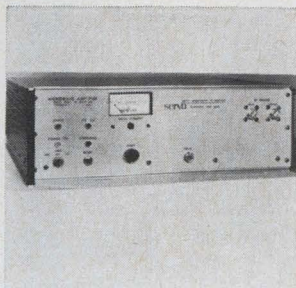

Solid state traveling-wave-tube amplifier series 2000 is a 20-w unit. It is available in the frequency ranges of 1 to 18 Ghz, covered in 5 bands. Noise figure is 35 db maximum, and cold insertion loss of 80 db is specified. Dimensions are 5.25 x 16 x 16 in.; weight, 48 lbs. Delivery takes 30 to 60 days. Servo Corp. of America, 111 New South Road, Hicksville, N.Y. 11802. [401]

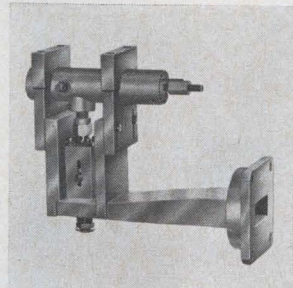

Oscillator/multiplier 2969-9900 is for use as an X-band local oscillator or a noise-modulated source to drive a twt amplifier. It has a mechanical tuning range of 10.15 to 10.55 Ghz. Output power is 4 mw minimum; input power, 150 v at 30 ma max., 6.3 v at 275 ma nominal; temperature range, -54° to $+95^{\circ}$ C. Trak Microwave Corp., Tampa, Fla. 33614. [402]

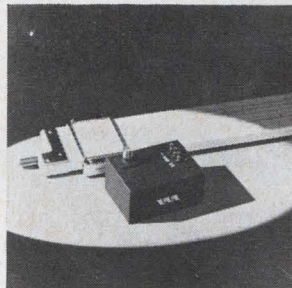

Broadband voltage-tuned oscillators cover a frequency range of 140 Mhz to 9.5 Ghz, with output power ranging from 7 mw to 200 mw. Tuning voltage is 0 to 60 v. Input power is -28 v d-c at 125 ma max. Operating temperature is -40° to $+70^{\circ}$ C. Size ranges from 2 to 3 x $1\frac{1}{2}$ x 1 in. Western Microwave Laboratories Inc., 1045 DiGiulio Ave., Santa Clara, Calif. 95050. [403]

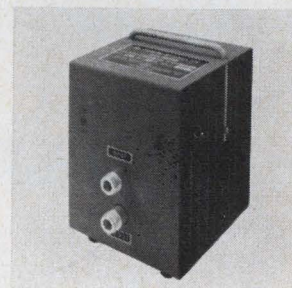

Attenuator series AX features a maximum vswr of 1.1 up to 1 Ghz, with attenuation accuracy of 5%. Standard values are 3, 6, 10, 20, and 30 db; other values by special order. L-pad configuration is standard, T-pad optional. Typical price for a 10-db, 100-w L pad attenuator is \$175. Electro Impulse Laboratory, 116 Chestnut St., Red Bank, N.J. 07701. [404]

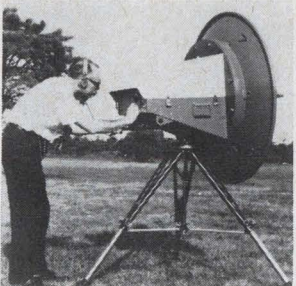

Portable f-m/tv relay links in the MRS series features output powers to 2 w. They are available from 1.7 to 7.725 Ghz. Receivers and transmitters are each complete with tripod, pan-head and antenna. The receiver or transmitter is integrally mounted to the antenna structure and is rfi protected. RHG Electronics Laboratory Inc., 94 Milbar Blvd., Farmingdale, N.Y. 11735. [405]

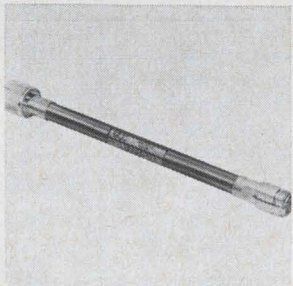

Low-pass filter TLT cuts off at any frequency from 2 to 10 Ghz. It is a tubular type available with 2 to 12 sections depending on the filtering characteristics desired. Impedance is 50 ohms; max. pass band vswr 1.5:1; insertion loss, 0.23 db to 1.13 db depending on number of sections. Telonic Engineering Co., P.O. Box 277, Laguna Beach, Calif. 92652. [406]

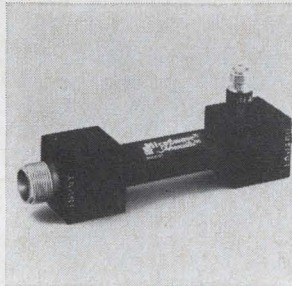

Solid state, uhf-band receiver protector switch MA-8307-1L3S is capable of high isolation in a radar receiver during transmitter pulse interval with low loss during the interpulse period. It operates in the 400- to 1,100-Mhz range with max. insertion loss of 0.5 db, vswr of 1.4 max., and isolation of 80 db minimum. Microwave Associates Inc., Burlington, Mass. 01803. [407]

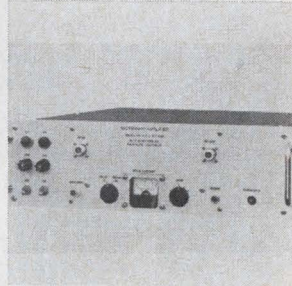

A series of 13 microwave amplifiers span power levels from 0.5 to 2 w and frequencies from 250 Mhz to 18 Ghz in octave band coverage. Small signal gain ranges from 30 to 37 db and noise figure ranges from 20 to 40 db depending upon instrument. Prices vary from \$3,308 to \$6,475. Alto Scientific Co., 4083 Transport St., Palo Alto, Calif. 94303. [408]

New microwave

A strong case for low loss

Switch design puts characteristics of package to work for device, not against it

Microwave switches keep getting smaller, but not the problem of parasitics, those unwanted and energy-wasting signal currents. At high frequencies, the capacitance of the package itself couples it to the circuit and results in high insertion loss and high voltage-stand-

ing-wave ratio. Isolation between switch and case must be provided, and this increases cost.

Instead of trying to eliminate the package parasitics, one company is using them as part of the device. As a result, its switch will sell for half the price of competing

units, says Société Européenne des Semiconducteurs (sesco), the component subsidiary of Compagnie Francaise Thomson Houston-Hotchkiss Brandt.

According to sesco design engineer Robert Ponnet, the nearest competing device is Hewlett-Packard's 3604, which sells for about \$175 in small quantities. Ponnet says the sesco modules will cost half that.

"We use a standard package that adapts easily to mass production," Ponnet says, "while American competitors are using specially designed packages. The device is almost as easy to assemble on the

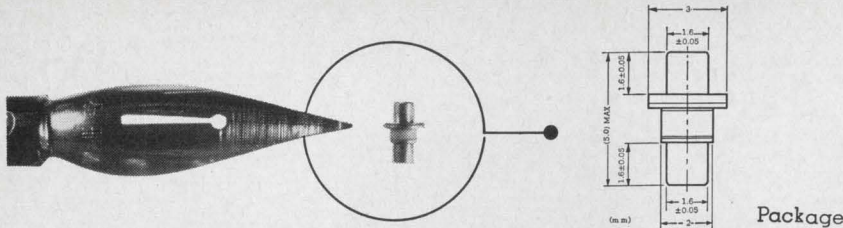

TRIPLE GUARANTEE!

Highest quality
Absolute reliability
Immediate delivery

Mitsubishi Microwave Gallium Arsenide Diffused Epitaxial Varactor Diodes

MV8000V Series (parametric amplifier applications)—This series of $p^+ nn^+$ diffused epitaxial high-cutoff-frequency varactor diodes are designed for use in low-noise parametric amplifiers. They come in a metal-ceramic-metal microwave pill package and feature hermetic-welded seal construction. Specially designed units can be used at liquid helium temperatures.

ELECTRICAL CHARACTERISTICS

TYPE	BV(V) min.	f_{co} (-6V) (GHz) min.	C_{jo} (pF)	
			min.	max.
MV8152A	6	150	0.2	0.7
MV8203A	6	200	0.3	0.7
MV8253A	6	250	0.3	0.7
MV8303A	6	300	0.3	0.7

MV8000B, C, D Series (frequency multiplier applications)—This series of $p^+ nn^+$ diffused epitaxial high-breakdown, high-cutoff-frequency varactor diodes are designed for use in frequency multipliers over x-band. They are capable of multiplication to millimeter frequencies. They come in a metal-ceramic-metal microwave low-loss pill package and feature hermetic-welded seal construction.

ELECTRICAL CHARACTERISTICS

BV (V)	(min.)	6		18		30
		C_{jo} (min.)		C_{jo} (min.)		C_{jo} (min.)
f_{co} (-6V)	150	MV8153B	MV8157B	MV8153C	MV8157C	MV8153D
GH _z	200	MV8203B	MV8207B	MV8203C	MV8207C	MV8203D
(min.)	250	MV8253B		MV8253C		MV8253D
	300	MV8303B		MV8303C		MV8303D

Write for full technical data and application information.
Chicago Representative: 119 East Lake Street Prudential Plaza,
Chicago, Ill. 60601 Phone: (312) 222-6079

 **MITSUBISHI ELECTRIC CORPORATION**
Head Office: Mitsubishi Denki Bldg., Marunouchi, Tokyo. Cable Address: MELCO TOKYO
Circle 216 on reader service card

Fight them all

Heart Attack
Stroke
High Blood Pressure
Rheumatic Fever

Give Heart Fund

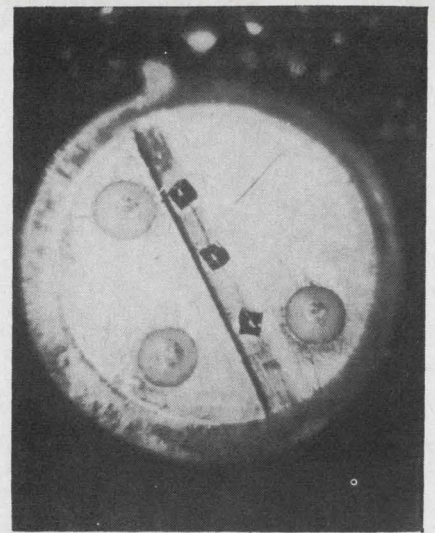
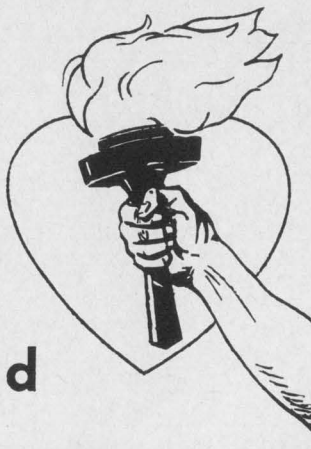

Headway. Microwave switch consists of three chips mounted to header.

production line as our silicon transistors." The SESCO switches are mounted in TO-3 or TO-5 cans, depending on the specifications.

SESCO found it could use standard packages, says Ponnet, "by incorporating the package's parasitic elements in the definition of a wideband filter in which switching diodes also intervene." Thus the characteristics of the case are made to work for the device instead of against it.

SESCO's first units are a low-power, high-speed switch in a TO-3 can and a high-power, slow-speed switch in a TO-5 can. The faster module operates at power levels up to 2 watts and switching speeds up to 2 nanoseconds. The slower device is rated at 5 kw and 1 microsecond. Insertion loss for both is equal to or less than 1.5 decibels, with an isolation of 70 decibels. In the operating range of 500 megahertz to 7 GHz, the switches have a vswr of 1.5.

The company doesn't expect to sell more than 1,000 units in the U.S. and Europe during the next year. If the demand increases, SESCO says, higher production will permit further price cuts. The first applications for the device will be in replacing transmit-receive tubes in low-power radar, and for switching in backup microwave systems. The low-power power switch also has applications in testing equipment such as frequency synthesizers and pulse shapers.

Societe Europeenne des Semiconducteurs, Paris [409]

MAGNETIC TAPE RECORDERS?

ask Hewlett-Packard

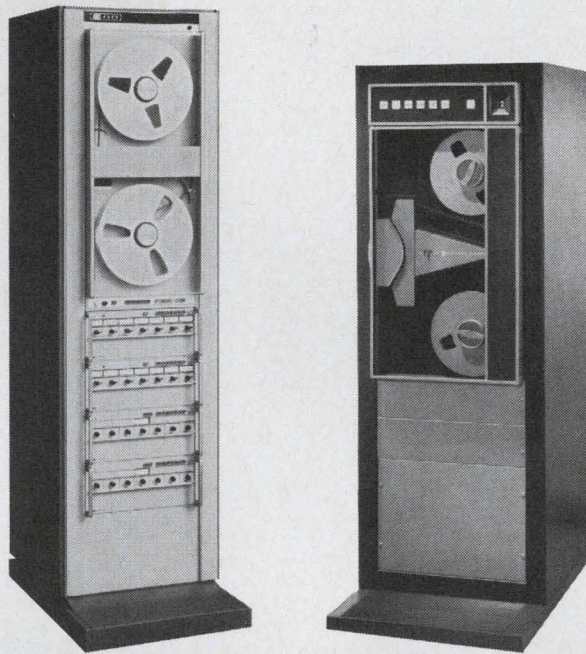

ANALOG or DIGITAL...

Reliability, ease of use, flexibility...these are the built-in extras you get with Hewlett-Packard magnetic tape recorders: today's most dependable tape transport; sturdy mechanical construction permitting long-term performance that can't be matched by more expensive recorders; electronics that are easy to adapt to your specific application; minimum maintenance. And, Hewlett-Packard service is only a phone call away. All this makes the low HP prices even more attractive.

For complete information on analog or digital magnetic tape recorders, call your local HP field engineer or write Hewlett-Packard, 690 Middlefield Road, Mountain View, California 94040; Europe: 54 Route des Acacias, Geneva.

ANALOG RECORDERS

IRIG compatible
7 or 14 tracks
½" or 1" tape
Direct and FM recording
Bandwidths to 1.5 MHz
Price: \$10,000 to \$20,000

**CIRCLE 206 ON READER SERVICE
CARD**

DIGITAL RECORDERS

IBM compatible
7 or 9 tracks
3 standard densities
½" tape
Choice of tape speed
to 75 ips
Read and write
Price: \$5000 to \$15,000

**CIRCLE 207 ON READER SERVICE
CARD**

HEWLETT  PACKARD

MAGNETIC RECORDERS

FLUX'EM, SOAK'EM, CLEAN'EM



BOURNS 3 NEW COMMERCIAL MODELS TAKE IT!

... that's right because the new E-Z-TRIM® potentiometers have been designed and built to meet today's production requirements. Sealed to prevent damage from fluxing, soldering and cleaning, the new Models 3005, 3065 and 3066 are available in two sizes ... with wirewound or non-wirewound elements ... yet the unit price is less than competitive models with lower specs.

Don't live with unnecessary production problems ... when your design and production needs call for sealed, low-cost potentiometers, specify these E-Z-TRIM units ... they're big in everything but size and price!

Write today for complete data or contact your nearest Bourns office or representative.

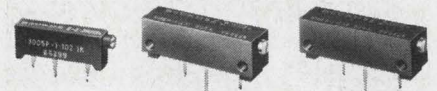

	Model 3005 Wirewound Element	Model 3065 Wirewound Element	Model 3066 Carbon Element
Size (L, W, H)	.75 x .14 x .31	1 x .29 x .36	1 x .29 x .36
Standard Resistance Range	10Ω to 25K	50Ω to 20K	20K to 1 Meg
Resistance Tolerance (Standard)	±10%	±10%	±20%
Resolution	0.2 to 1.6%	0.32 to 1.39%	Infinite
Power Rating	1 watt	0.5 watt	0.2 watt
Temperature Range	-65°C to +125°C	-55°C to +85°C	-55°C to +85°C
Seal	Immersion Proof	Immersion Proof	Immersion Proof
Price (500 piece)	\$1.45	\$1.44	\$1.44



BOURNS, INC., TRIMPOT DIVISION • 1200 COLUMBIA AVE., RIVERSIDE, CALIF.
TELEPHONE (714) 684-1700 • TWX: 910 332-1252 • CABLE: BOURNSINC.

New Production Equipment Review

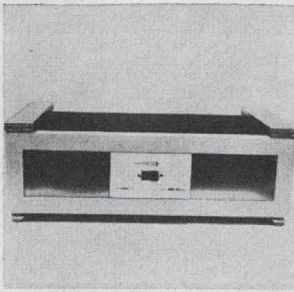

Jar-rolling machine Slo-Rol 202 slowly and continuously rolls jars of inks or resistor compositions for printed and fired circuits to maintain an even distribution of the metallic particles suspended in the vehicle, thus eliminating nonuniform circuit elements. Its gear motor has a fixed speed of 1 rpm. Precision Systems Co., Box 148, Somerville, N.J. 08876. [421]



Flatpack sealer FP-VP-1 is a bench-type, single-head unit. It will seal glass, Kovar and ceramic packages and will handle, with proper tooling, packages ranging in size from $\frac{1}{4} \times \frac{1}{8}$ in. through $1\frac{3}{4} \times 1\frac{3}{4}$ in. Its versatility and size suit it for use in laboratories and pilot line operations. Dix Engineering Div., GTI Corp., 1399 Logan Ave., Costa Mesa, Calif. 92626. [422]

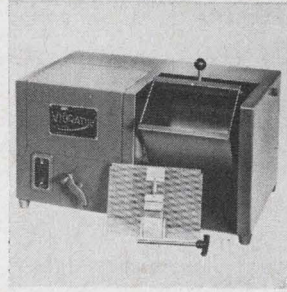

Bench-top vibratory deburring and finishing machine, called Vibratub 33, eliminates costly manual finishing of exposed and internal surfaces of small electronic stampings and precision parts. It has a working capacity of $\frac{1}{3}$ cu.ft. or $2\frac{1}{2}$ gallons. No water or drain connections are required. Price is from \$415. Vibraslide Inc., 95 Prospect Ave., Binghamton, N.Y. 13902. [423]

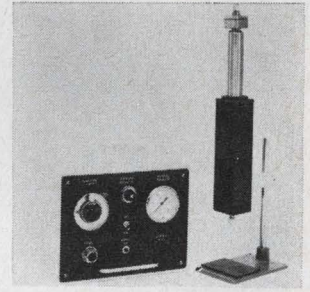

Solder cream dispenser RS2 Mini-Stroke, for automatic production systems, dispenses predetermined quantities of solder and flux mixture to a repeatable accuracy of $\pm 3\%$. It uses compressed air to force the cream from cartridge to work area. Dispenser costs \$385.80; control console, \$371.70. S.A.C. Consultants Ltd., 36-38 Baldwin St., Bristol, England. [424]

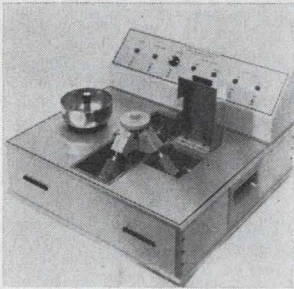

Ramsey core laundry CL-500 increases core-handler efficiency by cleaning and deburring cores before handling. It uses a polishing station consisting of a vibrating bowl partially filled with abrasive powder. After deburring, cores are sieved to remove abrasive, washed in an organic solvent, and dried by moving air stream. Computer Test Corp., Cherry Hill, N.J. 08034. [425]

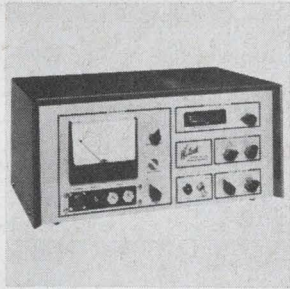

Welding power supply AC-12 features pulse shaping and resistance feedback control. Maximum output is 1 kva. The unit is suited for low- to medium-range insulated wire welding, butt welding, and regular resistance welding where resistance between electrodes varies from one weld to another. Wells Electronics Inc., 1701 S. Main St., South Bend, Ind. 46623. [426]

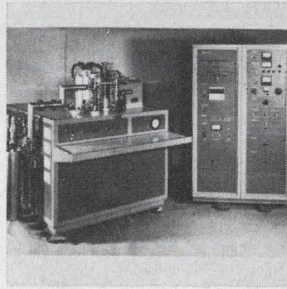

An automatic vacuum encapsulation system is capable of hermetically sealing as many as 1,000 crystals or other components every 7 hours. It employs a cold-weld technique that is effected by fusion of clean metals through pressure alone; no heat or solder flux is involved. Vacuum pressure is 2×10^{-7} torr. Varian Associates, 611 Hansen Way, Palo Alto, Calif. 94303. [427]

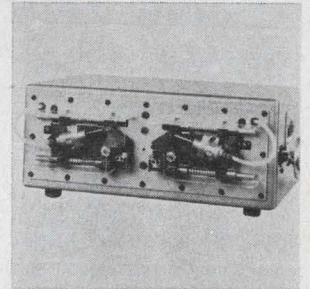

Automatic lead straightener designated Leadomat can handle a wide range of component sizes, wire-lead lengths and diameters. Its smooth motion prevents deformation of wires. Both manual and automatically-fed models are available. The automatic unit handles about 2,500 components per hour. Advanced Technology and Systems Corp., Riverside, Conn. 06878. [428]

New production equipment

Side-by-side crimping

Precision machine cold-welds terminals to solid or stranded wire, decreasing contact resistance

Terminals fed end to end into a crimping machine can be cut off at the wrong spot, causing an improper crimp. With the small-diameter wire used in solid state equipment, the misalignment can damage the wire and cause a connector to break off.

To get around this problem, a new system developed by the Cinch Manufacturing Co. attaches the terminals to a carrier strip and moves them along side by side.

Pilot holes punched in the carrier strip help align the terminals to within 0.0003-inch.

Exact placement of the terminals in the crimping head and precise operation of the Cinch machine make for a cold weld between terminal and wire. The wire is completely encircled and a nearly homogeneous crimp connection results—even fine 26 AWG wire will not be cut by the action of the automatic machine.

Corseted. The crimping head is designed so that the sides of the barrel cannot expand sideways when the crimper comes down and engages the sides to close them over the top of the wire.

The same crimp height—that is, the height of the finished crimp—



**Last
Tuesday
morning
a lot of people
on Pleasant
Avenue were
glum.**

But not "Smiling" Sam Price. He's one of the Twelve Cranks on Pleasant Avenue. And last Tuesday he found a lousy connection in a Trygon Liberator Power Supply that was coming off the line! It made his day!

The point is, of course, that loused-up Liberators never leave Trygon. Not with Sam Price and his un-merry men around. Their job is finding problems for us; so you don't get any problems from us.

Sam's pet, the Liberator, gives you the ultimate in IC and transistor system power in minimum size at lowest possible cost. Wide slot adjustment ranges with voltages up to 160v. Output current levels up to 40 Amp (3½") and 70 Amp (5¼"). .005% regulation/.5 mv ripple/3mv P-P noise/.01% stability/extremely low output impedance/MIL Spec. performance / integral slide mounting/automatic load share paralleling/overvoltage protection.

And you can be sure of this. Every Trygon Liberator Power Supply comes off the line under Sam's baleful eye. Order one and see.



Trygon Power Supplies
111 Pleasant Avenue, Roosevelt, L.I., N.Y. 11575
Trygon GmbH 8 Munchen 60, Haidelweg 20, Germany

**... wire is not elongated
or necked-down ...**

is nominally achieved for all wires in a range. This height can be adjusted with a positive micrometer adjustment independent of crimp head positioning. Once crimp height is set for a wire range, it need not be adjusted again for that range.

An important detail in the terminal design is the grooved wire-lock on the interior of the wire barrel into which the wire, deformed by the pressure of the crimper, is forced.

Calculated squeeze. Since crimp terminals are used in almost all electronic equipment from aerospace components to pinball machines, connections must not only meet the stringent electrical requirements of these circuits, but must also have the mechanical strength to provide reliability. The wire-lock in the Cinch terminals—a series of tiny "C's" embossed into the side of the wire barrel—is designed so a predetermined amount of wire will be squeezed into these areas. The wire is not elongated or necked-down even though the crimper exerts about three tons of pressure. The wire-lock is further designed so the resulting tensile strength of the connection is 70% to 75% that of the wire.

The tin-plated brass terminals, with maximum surface contacting

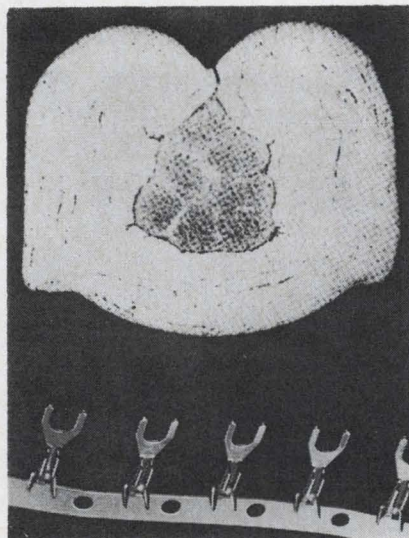

Tight grip. Top shows cross section of terminal crimped to stranded wire. Bottom is a section from a reel with terminals attached to feeder strip.

NEW!
**High RF
Voltage**



**Quartz
Trimmer
Capacitor**

The new Johanson GQ 11115 quartz trimmer capacitor permits a working voltage of 2500 VDC and 2500v peak RF at 30 mc with a dielectric strength of 7000 VDC. It bridges the application gap between the low power handling capabilities of conventional piston trimmer capacitors and the extremely high power handling capabilities of vacuum capacitors.

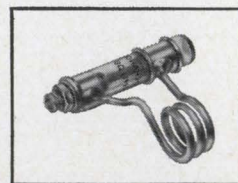

**Tubular
Electrodes**

- Low losses and low inductance at microwave frequencies.
- Components can be attached to the capacitors utilizing shorter leads.
- Higher voltages (RF) and higher Q are a result of the "gripping" action of bands on glass.

Call or write for complete information.

Johanson

**MANUFACTURING
CORPORATION**

400 Rockaway Valley Road
Boonton, N.J. 07005 • (201) 334-2676
Electronic Accuracy Through Mechanical Precision

4 lives
3 forms
2 uses
1 crystal
0 voids

The **TOTALLY TOKIN TOTAL:**

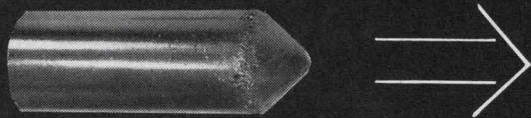

1. '64 Olympics: Japan Broadcasting Corporation developed unique slow-speed video tape recorders to catch the winning moments beyond doubt. To get long life and super-sensitivity for their VTR recording heads, they chose **TOKIN** to make the tips. Just last year **TOKIN** began to produce them internationally.
2. **TOKIN** heads the heads with Ferrite Single Crystals. These **TOKIN** single crystals quadruple recording head life, vastly improve electrical characteristics because voidless ceramic materials with high electrical resistivity are used.
3. **TOKIN** single crystals can be produced along customer-specifications in (1) round ingot form, in (2) blocks and in (3) chips—and even cores. These extraordinary crystals head the heads in (1) VTR's and audio recorders, and work as well in (2) computers and data processing equipment.
4. **TOKIN** was the first to do it, stays in first place internationally: **TOKIN** manufactures nearly 100% of ferrite single crystals in Japan, stands almost alone among world-makers. (**TOKIN** also manufactures a complete line of head-materials including Sendust alloys.) And like everything else **TOKIN** takes up, **TOKIN** single crystals are, start-to-finish, totally **TOKIN**.
5. Write:

Tohoku Metal Industries, Ltd.

4, 7-chome, Ginza-Higashi, Chuo-ku, Tokyo, Japan Telephone: Tokyo 542-6171

Cable Address: TOHOKUMETAL TOKYO



Isn't
 this
 the
 darndest
 cable
 you
 ever
 saw?

It just goes to show you that Markel can make just about any cable you can dream up! We make not only a wide variety of standard constructions, including all standard RG/U coaxial cables, but also a tremendous number of special constructions to customers' specifications. These may provide single, twisted pair or multiple conductors—bare copper or with tin, silver or nickel coatings; may combine insulations of Teflon*, silicone rubber, fiberglass and nylon; braided metal shields; fillers, liners and jackets of various materials. Just give us your specs . . . we'll make your cable. For free samples, write:



L. FRANK MARKEL & SONS
 Norristown Pa.19404 • 215-272-8960
INSULATING TUBINGS AND SLEEVINGS
HIGH TEMPERATURE WIRE AND CABLE

*TM of DuPont

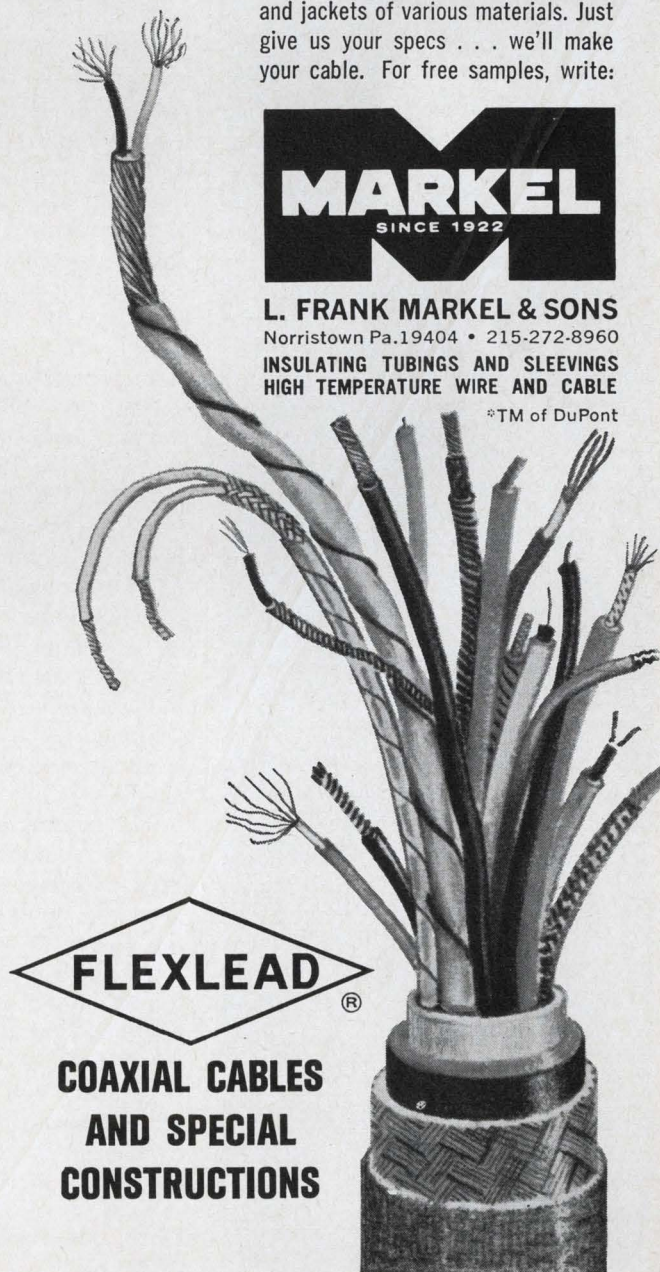

FLEXLEAD®

**COAXIAL CABLES
 AND SPECIAL
 CONSTRUCTIONS**

computer
data

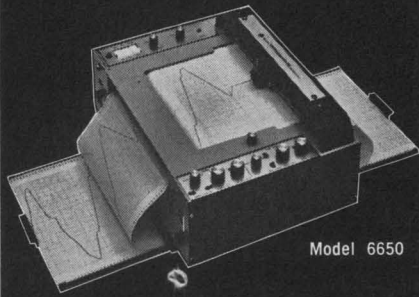

Model 6650

records
incrementally

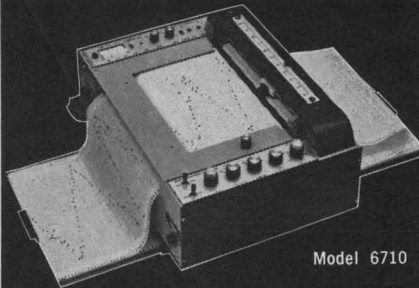

Model 6710

or
digitally

Recording inputs from digital computers, incremental encoders, pulsers, pulse generators, BCD digital data or parallel binary data?

Try Model 6650 Omnigraphic[™] Recorder with features such as: Z-fold paper (tears out to std. 8½" x 11"); 18,000 Increments/min. Speed; 0.01 Resolution; for a cost of only \$2850; Infinite Scale Expansion optional. Or Model 6710: 40 inches/sec. Slewing Speed; both Digital, and Discrete Analog operations; 1½ sec. Access—Single Point Memory for a cost of only \$3725.

Or, ask about the new Omnigraphic[™] style X-Y recorders.

**houston
instrument**

DIVISION OF BAUSCH & LOMB

4950 TERMINAL AVENUE, BELLAIRE, TEXAS 77401
(713) 667-7400 CABLE HOINCO

... uses ring-and-tongue,
spade-type terminals ...

the conductor, provide high conductivity with minimum voltage drop in low-voltage circuitry—less than 10 millivolts with 24 AWG wire. Also, the terminals don't become brittle when heated by current.

Another aspect of the Cinch design is the grip—suited to a variety of wire diameters—that holds the wire over the insulation to a measured tensile value; the conventional insulation support only protects the wire at the point it enters the wire barrel. Overlapping sliding fingers can be crimped around and into any of the common insulating materials to provide a true grip.

With the Cinch system, production efficiency is increased because regardless of the terminal configuration, only two sets of machine tools are needed. This depends on the wire size range—18 to 22 AWG or 22 to 26 AWG wire. In addition, a change of crimper and anvil in the machine takes only 20 minutes, and a change of terminals within the same wire range requires only a change of terminal reels.

Reel or bulk. Both ring-and-tongue and spade-type terminals are available for crimping to AWG sizes 18 to 26, and any of three material thicknesses may be chosen—0.016, 0.020, and 0.025 inch. Terminals are available either on 5,000-piece reels in a side-by-side design on a carrier strip for automatic crimping, or in bulk for use with manual tools. Cinch terminals are designed to fit any barrier block in common use, stud sizes 4 through 12.

The automatic crimping machine has a synthetic, molydisulphide grease lubricating system, and operates on 110-120 volt/60-hertz a-c power. Current requirement is approximately 7 amperes.

For manual crimping, a ratched cycle tool for repetitive production work ensures complete crimping before the tool opens to insert another terminal. This tool produces an exact crimp height every time, regardless of the skill of the user.

Cinch Manufacturing Co., Chicago
[429]



FREE SELECTOR CHART FOR REFRACTORIES

This Free New Selector Chart / Brochure describes a line of crystalline oxide refractory and insulating ware for use by industry and laboratories. These new products are designed for high resistance to heat, low reaction with metals and chemicals, low porosity and high thermal conductivity. The Selector Chart provides instant technical, mechanical and application data for apparatus made of Aluminous Porcelain, Recrystallized Alumina, Thoria, Zirconia and Magnesia. Write for your copy today.

57



**THERMAL AMERICAN
FUSED QUARTZ CO.**

RT. 202 & CHANGE BRIDGE RD.
MONTVILLE, NEW JERSEY
ZIP CODE 07045



*for
maximal
performance
in critical
applications...*

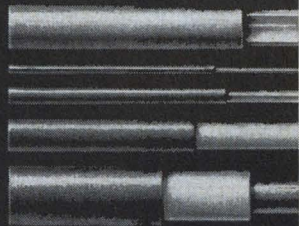

**COAXITUBE
PRE-FAB PARTS
& ASSEMBLIES**

Orders of Coaxitube can be furnished cut to size, stripped, preformed to shape or assembled with connectors to meet your exact specifications. Semirigid construction assures the retention of shape and closely held tolerances. We'll gladly send data or quote your needs . . . no obligation.

New production equipment

**Printed circuits
without etching**

Engraving technique used
to produce prototype
from pencil layout

From a research or development engineer's standpoint, making prototype printed-circuit boards can be a troublesome proposition. If the work is sent out to a photoengraving house, the cost can run as high as \$100 for two boards. If the boards are handmade, in house, reproducibility is sacrificed. This is especially crucial if the boards



Dry copy. The finished p-c board requires no rinsing or cleaning.

are to be used for high-frequency circuits, because placement of the parts is critical. And if the boards are handmade, the chances of their being alike are slim.

Applying their experience in electronic engraving machines to the problem of p-c boards, Graphic Electronics Inc. developed the Directron. It produces printed-circuit boards by cutting the pattern into a copper-clad epoxy or fiber glass sheet.

A hand-drawn pen or pencil layout of the desired circuit is placed on a drum. The copper-clad material is placed on a second drum. As the drums rotate, the machine optically scans the drawing and produces a signal representative of the desired pattern. This signal is



**PRECISION
Semi-rigid
COAXITUBE**

These high performance solid-jacketed cables offer broad frequency response, low attenuation, zero radiation and lowest possible VSWR. The splined, air-articulated types provide minimum attenuation and highest cutoff frequencies, eliminate periodicity phenomena, and insure phase stability in the order of 20 PPM/°C from 10°C to 40°C, and 35 PPM/°C from -40°C to +125°C. They also provide excellent external RF shielding. For critical applications in severe environments, your best decision is Precision.



PRECISION TUBE COMPANY, INC.
SPECIAL PRODUCTS DIVISION
North Wales, Pennsylvania 19454
Phone 215-699-4806 TWX 510-661-8427

NEW Concept in Digital-Analog Converters

The use of Model DIC 2760 Digital-to-Current Converter with any operational amplifier provides the designer with a variety of high performance digital-to-analog converters with premium specifications.



3/4" x 3/4" x 1 1/2"

MODEL DIC 2760 converts TTL logic levels to weighted currents in less than 50 nanoseconds. This module contains reference supply, resistor network, and up to 12 high-speed precision switches.

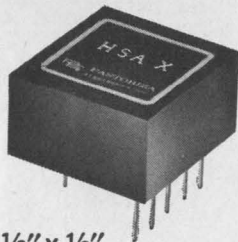

1 1/8" x 1 1/8" x 1/2"

MODEL HSA X Digital Operational Amplifier with FET input provides current-to-voltage conversion for voltage outputs of up to ± 10 volts at ± 10 mas.

The combination of HSA X and DIC 2760 results in a very high performance digital-to-analog converter with:

- Input levels of up to 12 bits resolution at TTL logic levels.
- Total conversions in 1 microsec.
- Complete DAC, in two modules, requiring less than 2 sq. in. of P.C. card.

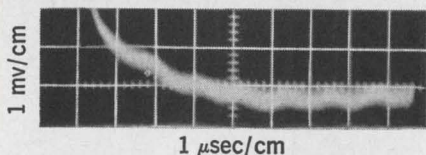

Response of D/A converter output to a full-scale change of 10 volts.

Write for detailed specifications and application data.

PASTORIZA
ELECTRONICS, INC.

385 Elliot St., Newton Upper Falls, Mass. 02164
(617) 332-2131

... boards as large as
12 by 18 in. can be made ...

fed to a lathe-type cutter mounted on the second drum. As the signal dictates, the pattern is cut into the copper-clad board.

The Directron can handle a board as large as 12 by 18 inches, but it takes about three hours to reproduce it. This makes large boards a problem, but the machine can be used to make the same type, or different boards, of smaller size at the same time. Thus the first board might be finished in only 30 minutes, and by the time it is wired up, the second board will be ready, and so on until all the boards are produced. The only other restriction on the machine is that the maximum board thickness that can be handled is $\frac{3}{32}$ of an inch.

The machine weighs 750 pounds and is priced at \$3,750. Delivery takes 10 days.

Graphic Electronics Inc., La Salle, Ill. [430]

New production equipment

Low-melting solder puts call through

Alloy joins core wires
for telephone switching
without cracking, burning

The problem was how to solder lead wires to ferrite memory cores without heat-cracking the cores. Conventional tin-lead solders required too much heat.

The customer was Western Electric Co., a part of the Bell System and manufacturer of core memories for telephone switching networks.

The solution, by Cerro Corporation, was an alloy of indium and tin which softens at 240°F and is liquid above 260°F, compared to 400 to 600°F for other solders.

Use of the low-melting-temperature indium alloy, which is called Cerroseal 35, for soldering the two lead wires was begun after Western Electric's repeated experience with destruction of the core material from overheating. The Cerro

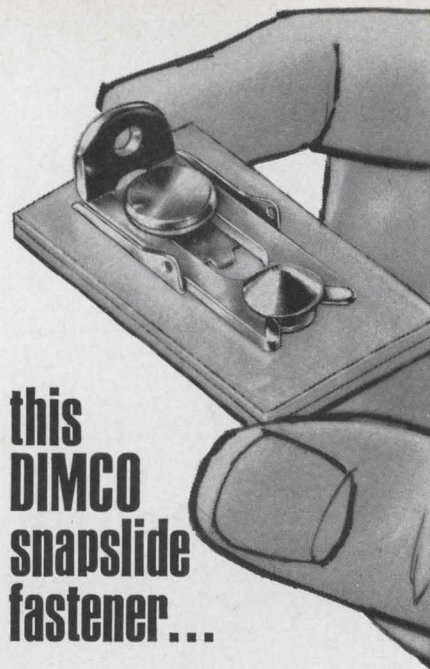

this
DIMCO
snapslide
fastener...

holds assemblies
securely...

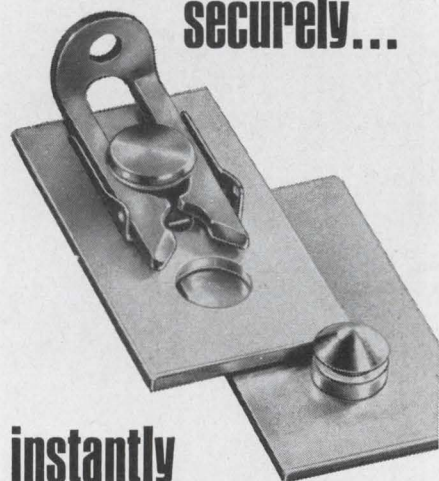

instantly
engages/releases...

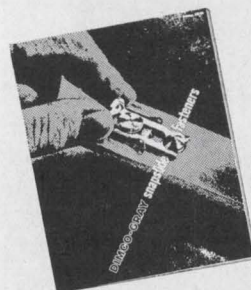

write for
new
handbook

Dimco-Gray Snapslide Fasteners hold assemblies firmly despite shock or vibration... never need adjustment, even with repeated use. Instant snap action engages or releases fastener... no tools required. Approved under Military Standards. Handbook illustrates typical applications, stimulates design ideas, describes attachment methods. Write for free copy today.

DIMCO-GRAY CO., 204 E. SIXTH ST., DAYTON, OHIO 45402

free! new

1968 NEWARK

INDUSTRIAL ELECTRONICS CATALOG

- Industry's Most Complete Buying Guide
- Over 70,000 items—500 Standard Brand lines
- 700 Pages
- Over \$7,000,000 Industrial Electronics Inventory— your assurance that NEWARK has it now.

LISTING

3909 STOCK TYPES

OF *Electra*

PRECISION, SEMI-PRECISION AND SUBMINIATURE RESISTORS

Electra metal film resistors equal or surpass precision wire wound resistors in accuracy, reliability and stability. They meet all applicable MIL specifications and are priced to compete with composition resistors.

Resistances from 1/20 to 1/2 watt are stocked in quantity.

Immediate delivery from stock—factory OEM prices
—fast efficient service from 10 Newark warehouses.



New Main Office & Warehouse

NEWARK 500 North Pulaski
Chicago, Illinois 60624

ELECTRONICS CORPORATION

WAREHOUSES IN

- * Chicago, Illinois (312) 638-4411
- * Cincinnati, Ohio (513) 421-5282
- * Denver, Colorado (303) 757-3351
- * Detroit, Michigan (313) 548-0250
- * New York City (212) 255-4600
- * Los Angeles Area (213) OR 8-0441
- * Grand Rapids, Michigan (616) 452-1411
- * New Orleans, Louisiana (504) 834-9470
- * Dallas, Texas (214) BR 2-3571
- * Houston, Texas Opening Soon



Cool. Low-temperature solder is used to wire ferrite memories.

alloy is supplied as 1/16-inch wire which is sliced into 1/32-inch buttons. According to Cerro Corp., no problems with wafer material or leads, which withstand a 200-gram pull test, have been reported since switching to the low-melting-point alloy.

The telephone company's 1-inch-square core is produced by high-pressure compacting of a ferrite powder. Copper is evaporated and plated on the wafer to provide a conductive track. When a telephone in the switching system is dialed, dialing signals are stored in this magnetized wafer. A central processor scans the memory and uses the stored information to set up the switching circuits to establish a communication path. Two hundred and fifty-six bits of information can be stored in the square to provide an erasable memory for a switching system.

According to Dick Becker, manager of Cerro's alloys department, "the extremely low vapor pressure of the indium-tin alloy also permits it to be used in high-vacuum apparatus requiring a seal between glass and glass or glass and metal." Besides adhering to glass, the alloy will also adhere to mica, quartz, thermosetting plastics and some glazed ceramics. Being rich in tin, it will bond to any metal which can be tinned with lead-tin solder, providing tinning is done at the same temperature required for ordinary solders with flux.

Cerro Corp., 300 Park Avenue, New York, N.Y. 10022 [431]

IT'S TAKEN 150 YEARS

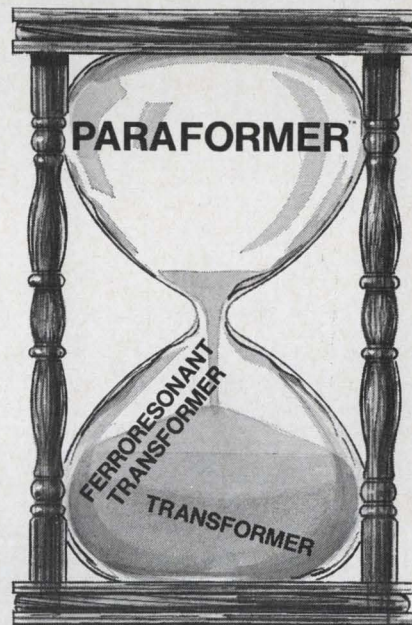

But Now There's A New Way To Convert Energy

PARAMETRIC POWER

The New Discovery by WANLASS

See What It Means!

	Trans- former	Ferro- resonant Trans- former	Para- former™
Electrical Isolation	excellent	excellent	excellent
Voltage Transformation	excellent	excellent	excellent
Voltage Regulation	none	good	excellent
Noise Rejection	none	poor	excellent
Bilateral Operation	yes	no	yes

For information: write, wire or call today.

WANLASS ELECTRIC CO.

A subsidiary of American Bosch Arma Corporation
2175 South Grand Avenue, Santa Ana, California
Phone: (714) 546-8990



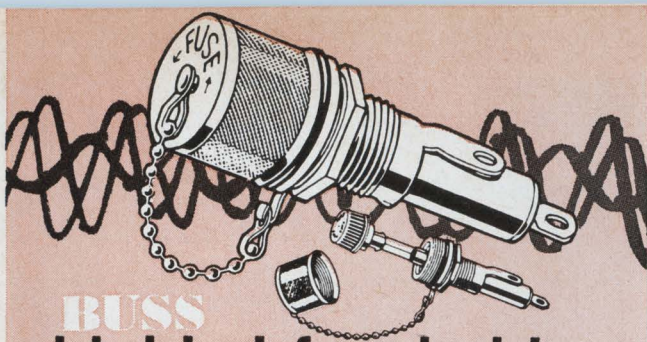

BUSS shielded fuseholders

PREVENT RADIO
FREQUENCY INTERFERENCE

For use where fuse and fuseholder could pick up radio frequency radiation which interferes with circuit containing fuseholder — or other nearby circuits.

Fuseholder accomplishes both shielding and grounding.

Available to take two sizes of fuses — ¼ x 1¼" and ¼ x 1" fuses.

Meets performance specifications of both MIL-I-6181D and MIL-F-19207B.

INSIST ON
BUSS QUALITY

BUSSMANN MFG. DIVISION, McGraw-Edison Co., ST. LOUIS, MO. 63107

Circle 226 on reader service card

FUSETRON

dual-element FUSES

Slow Blowing

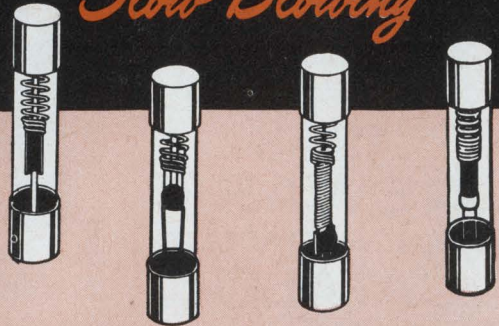

"Slow blowing" fuses prevent needless outages by not opening on harmless overloads—yet provide safe, protection against short-circuits or dangerous overloads.

Write for BUSS Bulletin SFB

INSIST ON
BUSS QUALITY

BUSSMANN MFG. DIVISION, McGraw Edison Co., St. Louis, Mo. 63107

Circle 226 on reader service card

BUSS: The Complete Line of Fuses and . . .

yes,

CCTV Cameras work best



with **COSMICAR**® LENSES

Superior cameras deserve superior lenses. COSMICAR's proven precision performance is the combined result of advanced optical engineering and exquisite workmanship.

Now widely used, COSMICAR LENSES come in 23 models for focal lengths ranging from 12.5 mm to 500 mm, and in 3 zoom models including a remote control zoom.

Your CCTV camera and COSMICAR LENSES will make an unbeatable team. For technical data and other particulars, please write.

Effective September 1, 1967, ICHIZUKA OPTICAL CO., LTD. changed its name to

COSMICAR OPTICAL CO., LTD.

568, Shimoochiai, 2-chome, Shinjuku-ku, Tkoyo
CABLE ADDRESS: "MOVIEKINO TOKYO"

New Books

Out of Line

Transistors for Audio Frequency
Guy Fontaine
Hayden Book Co.
384 pp., \$7.95

Audio frequency applications continue to engage the attention of electronics engineers. Despite a plethora of published works on the subject, more information is needed constantly, largely because of the dynamism of solid state. Here we have a book intended to fill the information gap, but it fails.

Fontaine's opus lacks organization; it rambles, sometimes leaving the reader bewildered. It has loopholes, particularly in the sections devoted to applications and those apparently aimed at revealing the "whys" of audio frequency design, so that the entire discussion is fragmented and sketchy. But the greatest sins are those of omission. Fontaine has virtually ignored silicon

devices (which have replaced the germanium units he is discussing), and has failed to provide enough data to enable an engineer to select the best device for a given job.

Other shortcomings: characteristic curves accompanied by too-brief descriptive material in the text; not enough definitions of terms; too strong an emphasis on the tutorial.

One of the few saving graces is the use of color in the diagrams to highlight those portions of a schematic or curve that are paramount. Fontaine's effort has little value for working engineers, technicians, teachers or students of electronics

Who'll save the robot?

The Search for the Robots
Alfred J. Cote, Jr.
Basic Books, Inc.
242 pp., \$5.95

Mr. Unimate, a die-casting operator at Stewart-Warner's Chicago

plant, works a 20-hour day, saves the company \$15,000 a year, doesn't eat, sleep, or complain, and is one of the few blue-collar workers in the Chicago area who doesn't belong to a labor union.

Unimate is a robot doing work that normally requires four men on two, 10-hour shifts. Despite this blessing, neither Unimate nor others of his kind are being sought primarily as part of management's desire to automate production.

Instead, robots, or "intelligence machines" (as their creators prefer to call them) are desired for other, less sensitive purposes. Among these are jobs in environments too dangerous for man; for performing boring manual tasks, and for quantitative work characterized by streams of numbers, facts, and other data. But the robot state-of-art is still fairly primitive, largely because the electronics know-how needed to advance it hasn't been channeled in that direction.

For example, microelectronics techniques are only now being ap-

Fuseholders of Unquestioned High Quality

BUSS

SPACE SAVER

Panel Mounted Fuseholders

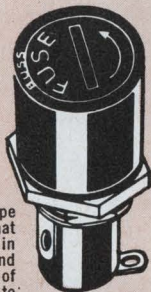

Screw type slotted knob that is recessed in holder body and requires use of screwdriver to remove or insert it.



Screw type knob designed for easy gripping, even with gloves. Has a "break-away" test prod hole in knob.

Fuseholder only 1 5/8 inches long, extends just 2 9/16 inch behind front of panel. Takes 1/4 x 1 1/4 inch fuses. Holder rated at 15 ampere for any voltage up to 250.

Write for BUSS Bulletin SFH-10

INSIST ON

BUSS QUALITY

BUSSMANN MFG. DIVISION, McGraw-Edison Co., ST. LOUIS, MO. 63107

TRON SUB-MINIATURE

PIGTAIL FUSES

BODY SIZE ONLY .145 x .300 INCHES

For use on miniaturized devices, or on gigantic space tight multi-circuit electronic devices.

Glass tube construction permits visual inspection of element.

Smallest fuses available with wide ampere range. Twenty-three ampere sizes from 1/100 thru 15 amps.

Hermetically sealed for potting without danger of sealing material affecting operation. Extremely high resistance to shock or vibration. Operate without exterior venting.

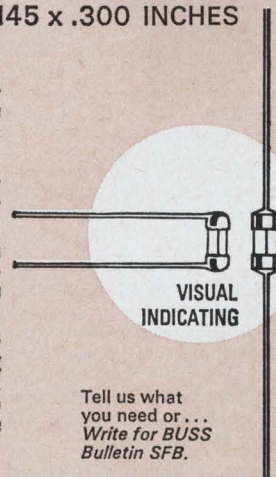

VISUAL INDICATING

Tell us what you need or... Write for BUSS Bulletin SFB.

INSIST ON

BUSS QUALITY

BUSSMANN MFG. DIVISION, McGraw Edison Co., St. Louis, Mo. 63107

New Diagnostic Technique

TAKE YOUR OWN X-RAYS

at your workbench with office-machine simplicity



SEND FOR FREE APPLICATION KIT

X-ray machines are usually thought of as bulky, complex pieces of equipment operated in a lead-lined room by specialists.

The FAXITRON 804 now provides an invaluable new tool—a compact, self-contained X-ray unit for workbench, lab, production area which can be operated as easily as an office copying machine. Just place the object in the exposure chamber, select the voltage and exposure time, press a button. The image is recorded on film which processes on-the-spot in 10 seconds without a darkroom. Take them yourself—when and where you want them!

Built-in shielding allows the instrument to be operated safely in populated areas without an X-ray room. (Qualifies as an "exempt" installation per NBS Handbook 93). High resolution is provided by a small X-ray source (0.5 mm). Good contrast for a useful range of specimen thickness and densities is provided by a wide voltage range (10 to 110 kVp).

See for yourself how a "quick look inside" can help locate and define hidden problems, speed development of your project with X-rays you can take yourself.

Send for Free "Do-it-yourself" Application Kit—technical information on typical exposures and use of materials for on-the-spot X-rays of potted electronic components, multi-layer PC boards, integrated circuits, die cast parts, plastics, biological specimens—other research, design, production and quality assurance applications. Ask for a free radiographic sample of a product or object of your choosing.

FAXITRON 804, \$1970. f.o.b. McMinnville



Field Emission Corporation

McMinnville, Oregon 97128/A C 503, 472-5101

New Books

plied to robot circuitry. Systems designers, needed to configure sound working approaches to robot design, haven't been lured away from their mainstream efforts in the aerospace, computer or communications fields. Finally, most of those with expertise in electronics know comparatively little about bionics, anatomy, mechanics—the other sciences crucial to robotology.

In a lucid, informative, and interesting manner Cote examines the A-Z of robots, from the viewpoint of the modern electronics engineer. He covers the why and how of the machines, nature's electronics (the bat's radar, the homing instinct of birds, the moth's counter-measures); explores the electronics of man (in nerve cells or equivalent "brain" circuits); visual and speech recognition, learning machines, the computer technology, and the robot state-of-art—and goes on to define those areas awaiting electronic solution.

Cote offers little in the way of detailed solutions, but does a beautiful job in defining the problems and constructing a framework (much like the familiar block diagram approach) on which to build future efforts.

Inadvertently perhaps, the reader is left with the definite impression that robots will never replace their human progenitors, a la Mary Shelley's Frankenstein. In fact, the robot comes across as a kind of big, oafish doll—a neglected, retarded orphan who may be elevated by electronics to a status similar to that of the domesticated dog, ox, camel, and other friends of man.

Refreshing

Introduction to Network Analysis
Ben Zeines
Prentice-Hall Inc., 306 pp., \$10.95

In a field where introductory texts are usually either too advanced for understanding or too fundamental for practical use, this text is refreshing. Though it may be somewhat elementary in its early sections for the practicing engineer, its later chapters, on attenuators and equalizers, filter network synthesis, and

NOW! WORLD'S FIRST 10.7MC CERAMIC FILTERS FOR FM RADIOS.

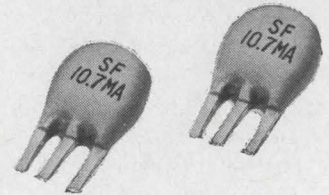

Murata's remarkable new ceramic filter Model SF-10.7MA gives you more selectivity for their size than any conventional I-F filter. These filters are fixed tuned and need no alignment—are non-magnetic and non-microphonic. They are entirely electrical, with no mechanical coupling.

By appling of the trapped energy theory about vibration mode to piezoelectric ceramics, Murata has succeeded in making this new high frequency ceramic filter, for the first time in the world. Improve your next FM radio design with the new ceramic filter Model SF-10.7MA.

Request today the latest technical bulletin #765-E for complete specifications and selectivity curve.

muRata

MURATA

MANUFACTURING CO., LTD.

Nagaoka, Kyoto, Japan

Phone: 075-92-1121

Cable Address: MURATAKYOTO

Telex: 5422-317KYO

IN THE UNITED STATES

MURATA CORP. OF AMERICA

160 Broadway, New York, N.Y. 10038

Phone: (212) 686-2510

Telex: MURATA421690

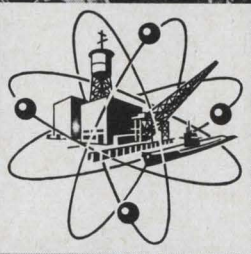

HAWAII CALLS ENGINEERS

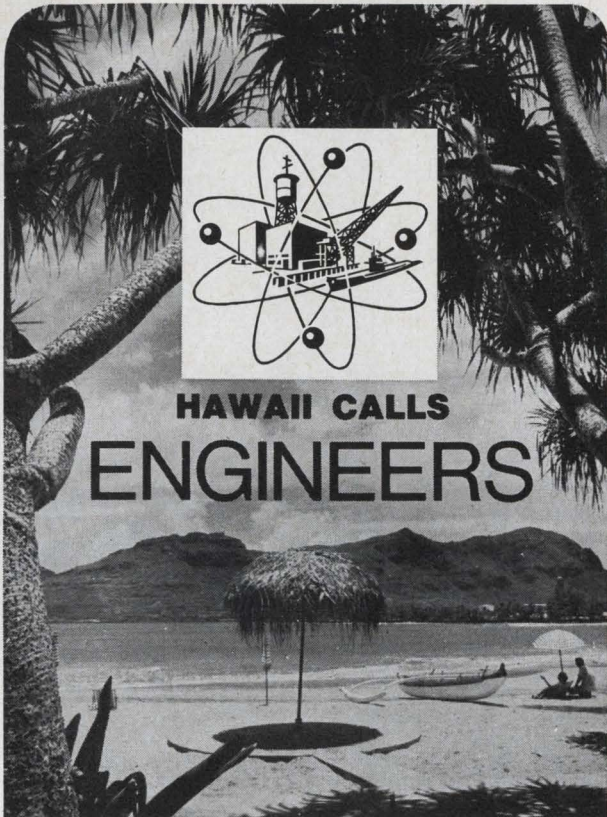

PEARL HARBOR NAVAL SHIPYARD

needs

**Electronic, Electrical, Marine,
Mechanical, General, Nuclear Power
Engineers and Naval Architects**

STARTING SALARIES: \$7,345 to \$13,001
depending on experience

Salaries include 15% cost-of-living allowance,
which is subject to change.

- Opportunities for professional growth, advancement.
- Pleasant living for you and your family.
- Pearl Harbor Naval Shipyard, the largest industrial organization in the Pacific, plays a vital role in today's nuclear Navy. The activities of the Yard create a broad range of assignments for engineers and naval architects.

Transportation to Hawaii and back provided for employees and their dependents. Household effects will be shipped at government expense. Transportation for home leave provided if employment agreement is renewed after three years.

These are career Civil Service positions with regular salary increases, generous benefits, liberal retirement plan, and will be filled on an Equal Opportunity basis. Send resume of professional experience or Standard Form 57 to:

PEARL HARBOR NAVAL SHIPYARD

(CODE 170)

BOX 400, PFO SAN FRANCISCO 96610

THE MOST ACCURATE and SIMPLEST WAY:

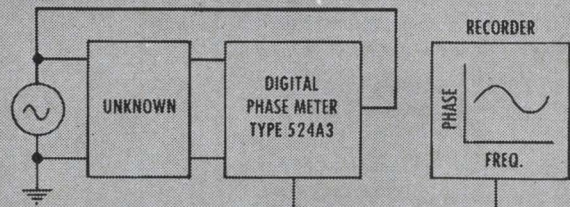

Read phase angle in 4-digits and automatically plot phase curve vs. frequency from 10 Hz to 500 KHz.

DIGITAL PHASE METER Type 524A3

Phase angle in degrees directly represented in four digits. No amplitude adjustment. No frequency adjustment. Analog output available for external recorder or programmable systems. Accuracy $\pm 0.03^\circ$. Phase response from 5 Hz to 500 KHz.

Write for
free technical
bulletin—
"DIGITAL PHASE
MEASUREMENT".

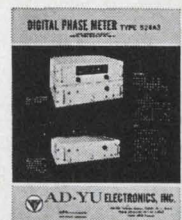

WORLD FAMOUS IN PHASE-TIME MEASUREMENT

ADYU **ELECTRONICS, INC.**
249 TERHUNE AVE., PASSAIC, N. J.
PHONE: (201) 472-5622
CABLE: ADYU PASSAIC

Catch 1 μ s
voltage peaks.

Why?

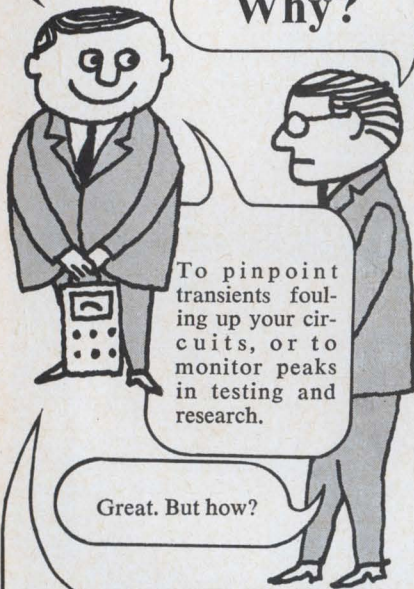

To pinpoint transients fouling up your circuits, or to monitor peaks in testing and research.

Great. But how?

With PEAK LOK. It measures positive, negative or bipolar peaks with 1% full scale accuracy, holds its reading in an analog state until it's reset. Use it to measure physical parameters in environmental tests, record surges in power lines and supplies, detect overload transients in electronic and electrical systems . . . everywhere precise determination of voltage peaks can help solve a problem. It has an output for data logging, can be remotely reset, has nine ranges from 0.1 to 1000v full scale, and can go up to 30 kv with a high voltage probe. When you're not catching transients, use PEAK LOK as a sensitive DC voltmeter, to measure that hard to get to voltage with a quick touch of the probe.



For complete specifications

write to PEAK LOK Sales, Dept. 228, Analog-Digital Systems Division, Control Data Corporation, 4455 Eastgate Mall, La Jolla, California 92037. Or phone 714/453-2500.

CONTROL DATA

CORPORATION

4455 Eastgate Mall, La Jolla, Calif.

New Books

tuned voltage amplifiers, could be of great help to many engineers who are occasionally called upon to design such circuits.

The author's strong suit is his ability to demonstrate theoretical concepts with concrete, practical problems. Thus, the early chapters, which deal with such topics as network theorems, Laplace transforms, and pole-zero techniques for analysis of resonant and coupled circuits, are definitely worth reading for many engineers. Though they would find no additions to the basic body of knowledge they studied as undergraduates, they should gain in understanding more clearly concepts which may have become blurred through lack of use.

Attenuators and equalizer design are covered in detail with a set of tables summarizing the network types and their respective design equations.

There is a good description of filter network synthesis, particularly Chebyshev filter design, which is much clearer than explanations found in many other books which presume to instruct on such subjects.

The final chapter, on tuned voltage amplifiers, also includes examples of transistor circuits, transformer coupling, and stagger-tuned circuits on a highly practical level, seldom found in such texts.

Dishing it out

Microwave Communications
Diogenes J. Angelakos and
Thomas E. Everhart
McGraw-Hill Series in Electrical
and Electronic Engineering
McGraw-Hill Publishing Co., Inc.
248 pp., \$11.50

Here at last is a book that truly communicates microwave technology. It is one of the few works that presents an interrelated, systematic view of the subject.

Many previous texts suffered from two major faults: the numerous elements of microwave systems were treated as isolated topics, leaving it to the reader to pull the pieces together; the physics of microwave theory were cluttered with lengthy derivations and complex equations not reduced to forms



Actual Size

Meet
the Marcon
MC PACK
(Thick-Film IC)

An Audio Amplifier Circuit, the Marcon Model D-2009 is a thick-film integrated circuit incorporating silicon planar transistors. To obtain the gain and frequency characteristics you desire, just place a suitable external network between output and NFB terminals. Solid, flat and packed, this circuit exhibits excellent performance and durability.

Ideal for digital and analog circuits. Offers greater applicability because it can be hybridized with semi-conductor IC's.

The Marcon MC PACK standard products include :

- Audio amplifier D-2009 (9V to 12V)
- Tone control amplifier D-2011 (12V to 18V)
- Flip-Flop circuit D-3044 (12V and 4.3V 10Mc)
- Flip-Flop circuit D-3046 (12V and -6V, 100Kc)
- Schmitt trigger circuit D-3060 (12V, 500Kc)
- Flip-Flop circuit D-3100 (12V, 1Mc)
- Flip-Flop circuit D-3101 (6V, 1Mc)

Tokyo Denki will MC-PACK other digital and analog circuits to meet your special requirements. For detailed information, write today.



TOKYO DENKI CO., LTD.

3-13, 5-chome, Minamishinagawa,
Shinagawa-ku, Tokyo, Japan
Cable Address : ELECTROMARCON TOKYO



NEW from Cramer



ADJUST-A-LOK STOOLS

Adjust to every worker like fine tools!

Cramer Adjust-A-Lok is immediately adjustable to any workers height. Just release the safety stop, and lift or lower. It can be done just that quick. Since fatigue is a critical factor in efficiency of seated workers, it's just good economics to provide tools that minimize fatigue. With Adjust-A-Lok every worker can find his own most comfortable and efficient level. 6 seat styles and 5 base types provide 30 available models. For more information: write V. P. Sales, Cramer Industries, Inc., 625 Adams, Kansas City, Kansas 66105.

Industrial supplier
inquiries invited



Cramer—The leader in style and quality.
Circle 286 on reader service card

NEW MINIATURE



NYLON CONNECTORS

Up to 15 circuit capacity with these low-cost, miniature nylon connectors! Contacts automatically crimped to leads, then securely snap-lock into the housings. Positive polarity prevents misconnections and integral mounting ears provide easy panel installation.

Write for complete specifications and samples on any of these connectors.

MOLEX® PRODUCTS COMPANY
5241 Katrine Avenue
Downers Grove, Illinois 60515
(312) 969-4550 TWX 910-695-3533



Circle 287 on reader service card

MORE POWER

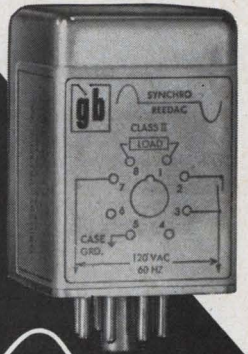

TO YOU!



SYNCHRO-REEDAC* from GRIGSBY-BARTON

**The First Fully Solid State
Power Relay To Offer The Benefits
of Synchronous Switching.**

Incorporating virtually infinite life and the environmental characteristics of the famous Grigsby-Barton REEDAC, the Class II SYNCHRO REEDAC* now opens new horizons. The Class II SYNCHRO REEDAC* is a second generation, fully solid state, heavy-duty power relay engineered for switch-on at 4 volts or less... and switch-off at current zero. The result: No strain... no R.F.I. problems... no "dirty switching"... no complex filtering necessary for switching up to 15 amp loads at 115 or 240 Volts AC. Compact size... available in standard solder type case or octal plug in can.

DESIGNERS AND PRODUCERS OF:
REED RELAYS • LOGIC CARDS • SWITCHING SYSTEMS
*Patent Pending

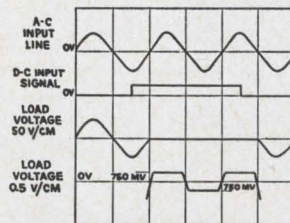

MAXIMUM RATINGS
Applied Voltage—400 volts, peak. Load current—up to 15 AMPS, RMS. Operating Temperature—0 to 70°C. Storage Temperature—40°C to +100°C.



GRIGSBY-BARTON, INC.
107 NORTH HICKORY STREET
ARLINGTON HEIGHTS, ILL. 60006
PHONE AREA 312 / 392-5900

Circle 231 on reader service card

231

Compact electronics package?

COOL IT...

...with a small size, long life, high output AiResearch fan.

Garrett-AiResearch special purpose fans are individually designed and custom built to deliver more flow and greater pressure rise with a minimum envelope size.

Take a typical AiResearch small size fan: computer-optimized for required performance under all operating environments; our own motor, engineered and manufactured for a perfect match to its fan; and up to 40 percent more airflow than any other ventilating fan of similar input, size, and weight.

Next time you need a ventilating fan for a very special airborne or ground electronics enclosure specify AiResearch. Available for high temperature and cryogenic applications, with flow rates and power requirements as specified. AiResearch Manufacturing Division, Torrance Facility, 2525 190th Street, Torrance, California 90509.

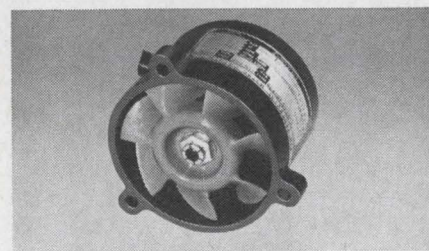
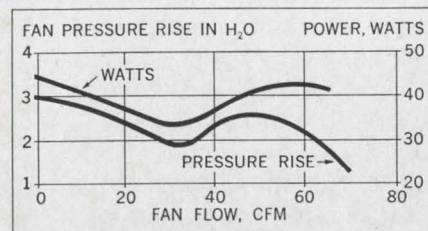

AIRESEARCH SPECIAL PURPOSE FANS



New Books

easily understood.

The authors have provided ample detail for an in-depth understanding of both the salient features and the nuances of the microwave art. This information is presented from the viewpoint of the systems engineer and buttressed by approximate solutions to difficult practical problems.

Emphasis is on electromagnetic field theory, power flow, amplifiers and oscillators, solid-state microwave devices, and specific, existing microwave and communications systems. Other topics covered in depth are antennas, radio-wave propagation, and noise.

The artwork illustrates the concepts well and the exercises following each chapter are helpful. There are enough equations to facilitate understanding but not a superfluity of them.

All in all, the reader will come away with a better grasp of microwave systems, and should find it easier to design and evaluate them as well.

Although Angelakos and Everhart have aimed at senior-level undergraduates, their book will also have value for the working engineer. The only deficiency is the absence of the microelectronic technology that is reshaping microwave systems. However, microwave IC's are so recent that the subject probably could not have been covered adequately at this time.

Recently published

Thermal Insulation Systems: A Survey, Arthur D. Little Inc. Staff, National Aeronautics and Space Administration, 148 pp., 60 cents.

A summary of data on the performance of thermal insulations and systems combining such insulations, with emphasis on cryogenic applications, intended to help industry benefit from aerospace R&D.

Physical Electronics, Curtis L. Hemenway, Richard W. Henry, Martin Caulton, John Wiley & Sons, Inc., 449 pp., \$11.50 (2nd Edition)

Basic theory of quantum physics, statistical mechanics, solid state physics and electron ballistics on a graduate level with emphasis on semiconductor devices including p-n junctions, bipolars, FET's, and SCR's.

Characteristics and Operation of MOS Field effect Devices, Paul Richman, McGraw-Hill Book Co., 146 pp., \$10

The book covers the electrical characteristics of MOS transistors, MOS technology, fabrication techniques, and linear and digital MOS circuit applications. Included are recent developments in the fabrication of low power MOS complementary integrated circuits.



Eight fact-packed pages tell how we've combined up-to-the-minute production facilities with the kind of meticulous New England craftsmanship you probably didn't realize still existed. Read how the combination benefits you, whenever you need quality.

PRINTED CIRCUITS ASSEMBLIES PROTOTYPES



ELECTRO-SONICS, INC.
210 Main St., Spofford, N. H. 03462
Tel. 603/363-4701

Circle 289 on reader service card

High Reliability Instruments

meguro

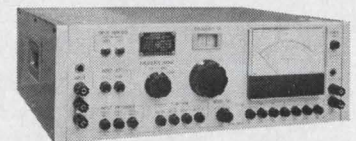

MAK-659

Dist. meter

— for AUDIO LABS and PRODUCTION —

MEASUREMENT RANGES

■ Distortion

Range: 0.1 to 30%, 5 steps; frequency: 20Hz-200kHz; input impedance: 600, 10k, 20k ohms; automatic control range: 40dBm or 100X in voltage; fundamental suppression: over 60dB.

■ Level

Range: -70 to +40dBm, 600 ohms, and -70 to +20dB (0.3mV-10V), 10k and 20k ohms; frequency: 20Hz to 600kHz.

■ S/N (signal/noise)

Range	Input
0 to 70dB	-22 to 0dBm
0 to 90dB	0 to +38dBm

frequency: 20Hz to 60kHz.

● Catalog sheet on request



MEGURO DENPA SOKKI K.K.

(Meguro Electronic Instrument Co., Ltd.)
No. 5, 1-2-chome, Chuo-cho, Meguro-ku, Tokyo, Japan
TEL: 711-7191-7 Cables: MEGURODENPA TOKYO

These new heat-shrinkables devour vinyl spec by spec.

Yet cost no more. That's because new Insultite® CP-150 and Insultite SRT are polyolefins. Heat-shrinkable, irradiated polyolefins that provide protection at a polyvinyl price. New CP-150 insulates and encapsulates any subject. And is particularly ideal for commercial, automotive, appliance, and computer applications. From 3/64" to 2" I.D. In black. As for new SRT? This clear, tough, thin-wall polyolefin is perfect for components subject to shock and strain and where visual identification is important. From 3/16" to 2" I.D. Write for free samples today. (Specify diameters, please.)



ELECTRONIZED CHEMICALS CORPORATION

A subsidiary of High Voltage Engineering Corporation
Burlington, Mass. 01803, Area Code 617-272-2850

E.C.C. heat shrinkables are recognized under UL component file E39100.

Circle 290 on reader service card

8 of a series

TRANSICOIL SOLVES SERVO PROBLEMS

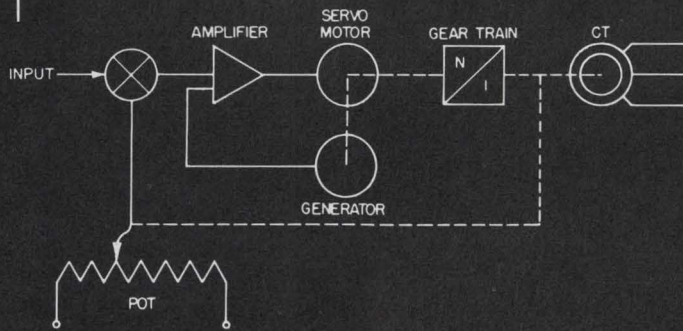

shown
without
cover



New Transicoil position servo assembly

Weston-Transicoil built this position servo assembly for an Increased Maneuverability Kit used on the BMQ-34A Firebee target drone. Designed with provision for hermetic sealing, it provides accurate and constant error voltages per degree of bank angle, guaranteeing precision control of the Firebee during high *g* maneuvers. Synchro output closely follows analog voltage input with the 10-turn potentiometer connected by precision gearing to a size 10 motor generator driven by a standard size 11 amplifier. Typical of Transicoil engineered servo packages, all components in the position servo are supplied by Weston and the entire assembly is designed for plug-in installation.

PERFORMANCE: Feedback Potentiometer: 1K 10-turn size 5 • Output: Size 8 control transformer • Slew Speed: 1 Rad/sec • Accuracy: 1° (over range of -90° to +90° at synchro) • Power Required: 26V, 400 CPS; 28V DC • Size: 2 1/2" dia. x 3 1/4" length.

Weston Instruments, Inc., Weston-Transicoil Division, Worcester, Pa. 19490, a Schlumberger company

WESTON® prime source for precision... since 1888

Technical Abstracts

Skin deep

Full-color and three-dimensional radiograph displays
Wilfred Roth
Dept. of Electrical Engineering and
Dept. of Radiology
University of Vermont, Burlington

An X-ray photograph (radiograph) contains a wealth of permanently stored information, probably more than can be interpreted even by the skilled observer. Two new types of electronic displays can enhance subtleties that would normally go undetected. Both relate to the radiographic gray scale, a measure of the depth below the skin's surface or the thickness of an object.

The first display converts to full color the radiographic gray scale; the second display converts the gray scale to the third dimension in an isometric view, which appears almost three-dimensional rather than planar.

Both displays are generated from a television camera focused on a conventional radiograph. In the color conversion system, electronic circuits sort the information in the video signals into three channels corresponding to the density of the respective elements of the radiograph. High-density elements are assigned to a blue channel, medium-density elements to a red channel, and low-density elements to a green channel. The outputs of the three channels control the blue, red, and green electron guns of a conventional tv color picture tube. The final display is a full-color conversion of the original black-and-white radiograph in which density is converted to hue.

For the isometric display, the output of the tv camera vertically deflects an electron beam producing an x-y scanning raster on a monochrome cathode-ray tube in synchronism with the scanning

beam of the tv camera. The horizontal scan lines of the raster are deflected vertically by an amount depending on the density of the radiograph at each scanned position, since height in the isometric view corresponds to depth.

Both systems have the advantage that an electronic light measurement can be performed on an absolute basis, whereas the human eye is sensitive primarily to relative light levels, not to a gradual change in light levels. If the radiographic density varies slowly across an area, the eye will detect it only if the gradient exceeds a certain threshold, depending upon the particular observer and the absolute light level. An electronic detector can judge the density of a particular picture element without being influenced by adjacent elements.

The techniques are equally applicable to the presentation of data from fluoroscope screens, radioisotope scans, electron micrographs, and similar sources of stored information. The technique

PROBLEM / Formica know- SOLVED

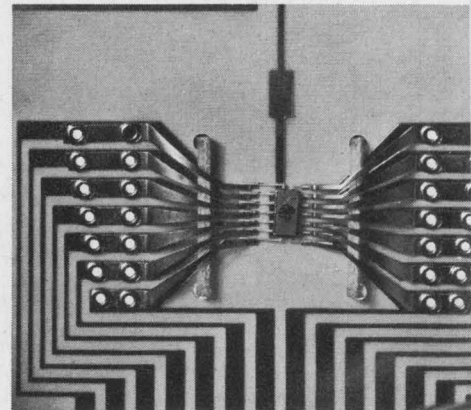

Case #1695-Problem: 4 different copper clad grades were purchased and inventoried, creating multiple paperwork, record-keeping. Idea activated: One FORMICA® FR-45 laminate, created to meet NEMA G-10, G-11, FR-4, FR-5.

Case #6520-A-Problem: Pad slippage causing poor registration in production of multi-layer circuitry boards. Idea activated: FORMICA® laminate MLC system created a sandwich with better copper bond strength and registration control at elevated temperatures.

is thus useful in industrial non-destructive testing.

Presented at the 20th Annual Conference on Engineering in Medicine and Biology, Boston, Nov. 13-16.

Outside help

Practical design of an implantable passive receiver of radio-frequency energy

G.R. Abell, Avco Everett Research Laboratory
Everett, Mass.

The power for pacemakers or bio-telemetry devices implanted in the body can be supplied from an external source through radio-frequency induction. R-f energy is delivered to a tuned coil inductively coupled to an implanted tuned coil.

Although this powering technique is inherently inefficient, efficiency is improved with tighter coupling between the coils. An implantable magnetic structure (patents pending) improves coupling with a low-loss ferrite ring of about the same size as the receiving coil. The ring is butted against the coil

on the side away from the skin and thus provides a better path for the flux through the coil. In addition, the free space within the coil and ring can be used for other components of the receiver system.

For a given coil size, power output rises with frequency. But the upper frequency limit depends on the frequency limits of such components as transistors in the transmitter and upon the approximate 0.3 megahertz tissue-loss "corner frequency." Therefore, typical systems operate best between 0.1 and 1.0 Mhz. At these frequencies, litz-wire coils are often preferable because insulation losses are low.

A small system to provide electrical stimulation of a paralyzed bladder was designed, using this type of receiver coil. A hand-held transmitter produced 0.1 Mhz r-f pulses which, coupled to the receiver, provided 4-millisecond pulses at a repetition rate of 20 pulses per second. Power is up to 2 watts into a 100 to 200-ohm tissue load connected to the receiver leads.

More than a dozen of these devices, implanted in patients, have performed well for periods up to several years. As far as materials are concerned, it is necessary to provide biological acceptability and impervious sealing against body fluids.

Presented at the 20th Annual Conference on Engineering in Medicine and Biology, Boston, Nov. 13-16.

Watching waves

Conversion of millimeter wave images into visible displays

Harold Jacobs, Ronald C. Hofer, George Morris and Edward Horn
U.S. Army Electronics Command
Fort Monmouth, N.J.

Millimeter waves bounced off a solid object can be converted into visible images by focusing them onto a semiconductor panel flooded with bright light. The light makes the panel conducting and thus an opaque shield to the waves. To form the image, a flying dark spot scanner is focused on the panel. It blocks the bright light and allows the waves to pass through the panel

how activates ideas!

If your problem is printed circuit boards, call us. Continuing innovations at Formica Corporation have created a wide variety of copper clads. One of these could help you!

Small problems in copper clad circuit boards can become big problems in product dependability. Turn those problems into profit and reliability. Call Formica. No one offers as much experience in laminates . . . backed by the research resources of Cyanamid. We make a variety of copper clad grades to solve a variety of problems. Ideas solve problems. Formica know-how activates ideas.

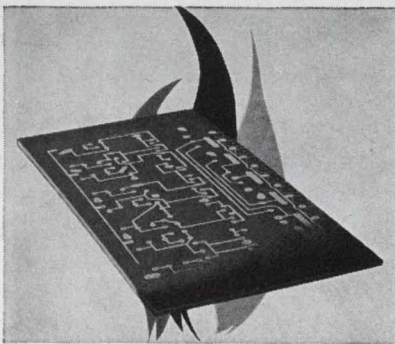

Case #5266-Problem: Flame retardant version of XXXPN-36 required, at no premium price. Idea activated: Flame retardant FORMICA® laminate FR-200 engineered to meet MIL specs, offers high flexural strength, excellent electrical properties.

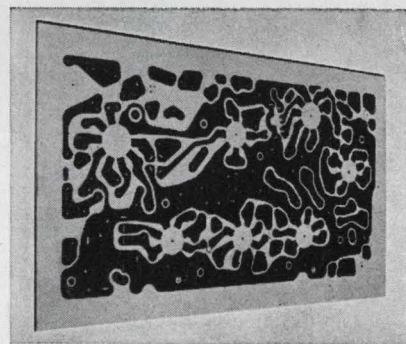

Case #J-9291-Problem: Utility-priced copper clad with quick local delivery required, due to limited inventory space. Idea activated: FORMICA® laminate FF-91 (meets G-10 specs) produced, maintained in Formica regional warehouses for phone-call delivery.

There are other brands of industrial plastics but only one



FORMICA CORPORATION • Cincinnati, Ohio 45232,
Dept. EL 12-7 subsidiary of

\$1,000,000 INVENTORY OF ELECTRONIC TEST EQUIPMENT

FOR RENT

Name brand test equipment fully calibrated with certificate of traceability if desired. Maintenance provided and all equipment is insured against fire, theft and damage in shipment. □ Short term rentals our specialty but yearly rental available. Fast delivery. Wide variety and depth. □ If you need equipment **NOW**, call Jim Powers or Frank Cassidy at (301) 424-2333. If you want a copy of our rental list or more information write:

RENTAL ELECTRONICS, INC.

16203 FREDERICK ROAD
ROCKVILLE, MARYLAND 20850

Technical Abstracts

whenever they occur at the same place as the dark spot.

If the flying spot is synchronized with the trace on a cathode ray tube, the position of the electron beam in the tube corresponds to the dark spot position on the panel. The beam intensity, in turn, is controlled by the wave signal transmitted by the panel. The visible display on the CRT then represents the radiation pattern produced by the waves on the semiconductor panel.

In an experimental 70-gigahertz system, the panel consisted of germanium of 40-ohm-centimeter resistivity, cut, polished and etched to a square 1.5 centimeters on a side and 3.21 millimeters thick. Overall, the panel was 9 cm square.

A lucite sheet was used to support the germanium blocks. Behind the sheet was a large horn antenna to pick up the transmitted millimeter waves, applying them to a detector diode. The output of the diode, which corresponds to the image, controlled the intensity of the CRT beam.

A conventional slide projector off to one side flooded the panel with light. A rotating lucite wheel, containing opaque metal spots in a helical pattern, was put in front of the projector. This device causes the dark spots to scan across the light-sensitive germanium panel.

Presented at Nerem, Boston, Nov. 1-3.

Biological design

A structural preconscious Piaget: heed without habit
Avery R. Johnson
Massachusetts Institute of Technology,
Cambridge

To provide the best data for a subsequent manned mission, the sensing and control systems of an unmanned vehicle landing on another planet should emulate biological sensing and control systems. If this could be done perfectly, the men on the first manned mission would have nearly as much useful data to draw on as those on the second manned mission. [The Piaget of the title is J. Piaget, French psychologist famed for his studies of learning and behavior in children.]

Most sensing and control sys-



FASTENERS FROM

DIE CAST ZINC ALLOY

-  Wing Nuts
-  Cap Nuts
-  Thumb Nuts
-  Thumb & Wing Screws

MOLDED NYLON & DELRIN

-  Screws
-  Hex Nuts
-  Washers
-  Screw Insulators

Big help for your tiny assemblies!

MINIATURE molded NYLON SCREWS

Now as small as #00



GRC Small & miniature screws simplify designs—at lower cost.

- Sizes #00, #0, #1, #2, #3 and #4.
- Many head types, lengths. Set screws, too.
- Flash-free, precise and uniform.
- Corrosion-resistant, vibration-proof, electrical insulating with high strength to weight.

Ask for sample kit prices . . . data about other GRC Plastic Fasteners—screws, nuts, washers, etc.



GRIES REPRODUCER CO.

Division of Coats & Clark Inc.
151 Beechwood Ave, New Rochelle,
N.Y. 10802 (914) 633-8600

World's Foremost
Producers of Small
Die Castings and
Plastic Moldings

Circle 291 on reader service card

DIFFERENTIAL TRANSFORMERS

For measurement and remote control use

Capable of obtaining output voltages exactly proportional to any kind of mechanical variation.

Measuring value: 1/100,000~100mm
More than 500 types are available.

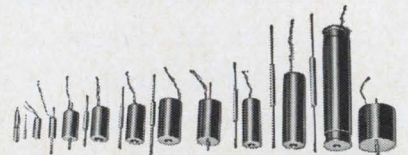

Features:

- *Outstanding interchangeability
- *Quite free from outer magnetic field
- *Insensitive to ordinary shock, water and heat

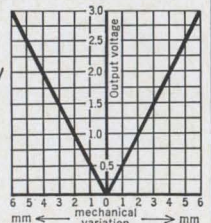

Manufacturers of Differential Transformers

NIPPON COIL CO., LTD.

Amakawa Bldg. 1, 1-chome, Hommachi, Higashi-ku, Osaka, Japan.

Circle 292 on reader service card

Measure impedances directly in polar form

From pure resistance, capacitance or inductance, to complex impedances . . .

Acton's 310-B Z-Angle Meter measures any RLC combination, with only one balancing step.

Impedance range from 0.5 to 100,000 ohms
frequency range from 30 cps to 40 kc
with magnitude accuracy of $\pm 1\%$
and $\pm 2^\circ$ for angle at 20 kc
The 310-B is both compact and portable



ACTON

LABORATORIES · INC.
Subsidiary of Bowmar Instrument Corporation
531 Main Street, Acton, Mass. 01720
Tel: (617) 263-7756 (Boston) 542-0284

Circle 293 on reader service card

who has the head start in stepping motors?

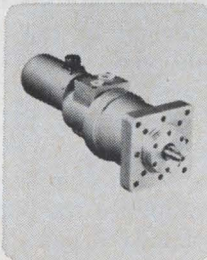

ELECTROHYDRAULIC PULSE MOTORS

Speed: To 8,000 steps/sec
Power: To 6 HP
Resolution: 200 or 240 steps/rev.

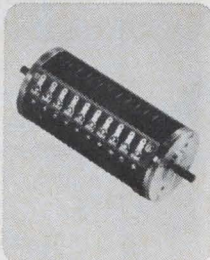

ELECTRIC PULSE MOTORS

Speed: To 10,000 steps/sec
Power: To 1 HP
Resolution: 160 or 240 steps/rev.

icon!

Icon is the leader in stepping motors. Can offer you the highest performance motors available. Can help you apply them practically, economically and simply to automate your plant or products. Call Icon now.

icon
CORPORATION

LEADERS IN DIGITAL MOTION
156 Sixth St., Cambridge, Mass. 02142
617/868-5400

Orcon® Lighted Pushbutton Switches

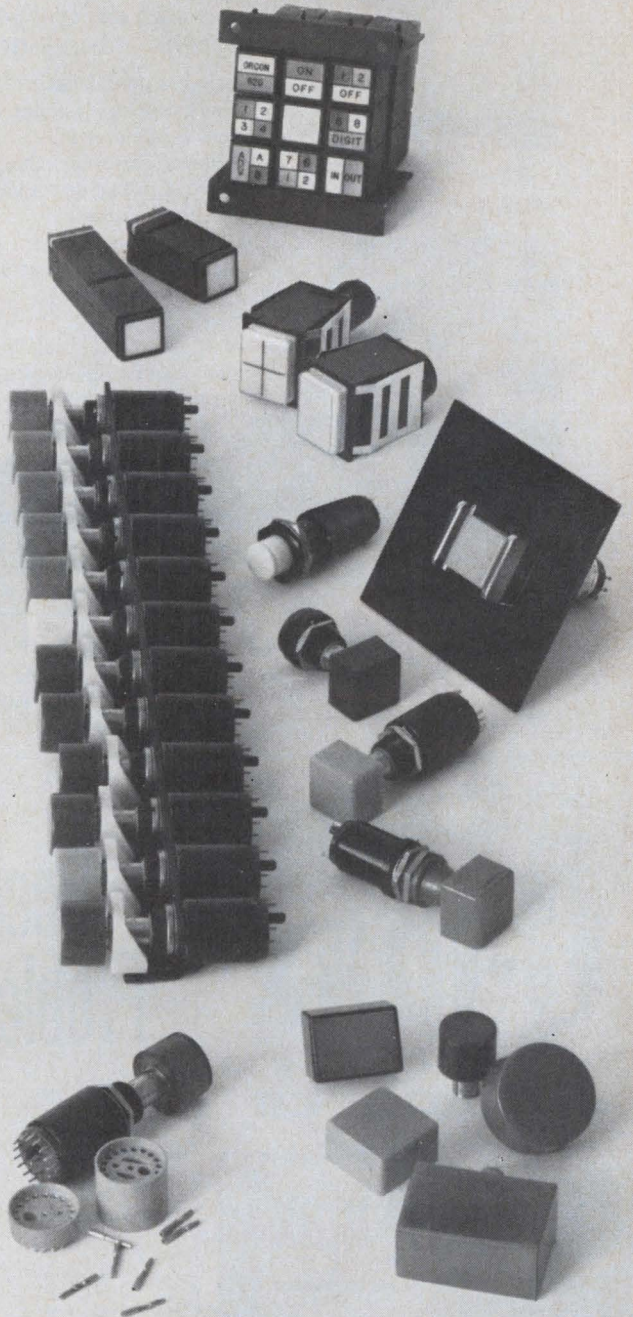

ORCON switches combine exclusive multicircuit capacity, isolated contacts, sliding-wiping action, independent light circuit and connector convenience in $\frac{3}{4}$ " and $1\frac{1}{16}$ " diameter sizes. Standard, solenoid hold-in, square multilight, electroluminescent, crimp contact connector and custom switches available. Plus indicator lights, ganged assemblies, adapters and accessories. For new brochure, contact USECO, 13536 Saticoy Street, Van Nuys, California 91409. (213) 873-3520.

USECO

Division of Litton Industries



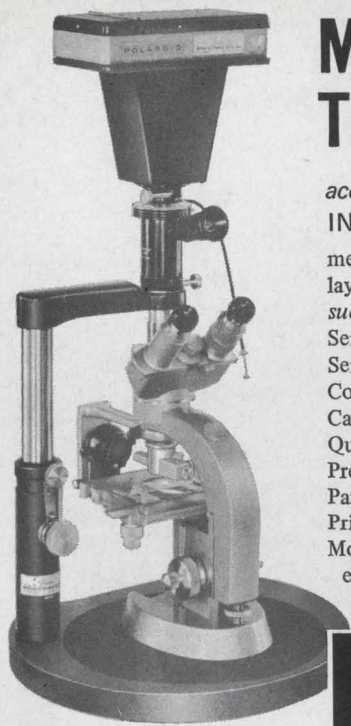

Measure Film Thickness . . .

accurately and conveniently...
INTERFERENCE MICROSCOPE

measures the thickness of thin film layers, coatings, platings, etc.
successfully used in..
Semi-conductor metallurgy
Semi-conductor device engineering
Computer research
Capacitor manufacture
Quartz Crystal manufacture
Precision engineering
Paint laboratories
Printing, ceramics, canning industry, etc.
More effective, convenient and economical than much more expensive systems.



WILLIAM J. HACKER & CO., INC.
box 646, W. Caldwell, N. J. 07006 phone (201) 226-8450
Circle 295 on reader service card

Specifically Engineered for
RF COMPONENTS

Q-max

A-27 Superfine
EXTREMELY LOW-LOSS
RF LACQUER



Q-MAX impregnating and coating composition penetrates deeply, seals out moisture, provides a surface finish. Q-MAX imparts rigidity and promotes stability of the electrical constants of high frequency circuits. Effect on the "Q" of RF windings is negligible.

Write for catalog today.

Q-max Corporation
MARLBORO, NEW JERSEY
Telephone: 462-3636 (Area Code 201)

Reed Relay Problems?

A special AND logic relay in the new "UF" configuration.

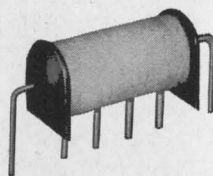

Can We Solve Your Problem?

Operating Inputs: low as 1mA. and 15mW.
Standard Coil Voltages: 6, 12, 24, 32, 48V in stock for immediate delivery.
Special Voltage or Resistance, multiple windings for flip flop, memory and crosspoint selection applications — to customer specifications.
Relay Contacts in Form A, B, C and latching. Also high vacuum type 5000V Form A.

Write for catalog and prices of our standard line of magnetic reed relays. For special requirements, give complete details for quotation.

Coto-Coil COMPANY INC.
61 Pavilion Ave.
Providence, R. I. 02905
Phone: (401) 941-3355

Technical Abstracts

tems designed up to now have failed to exploit man's knowledge of biological systems. In today's operating system, the sensor is a pattern-recognition device that identifies objects placed in front of it. The control portion of the system reacts to the output of the pattern recognizer. Steps are sequential whereas in biological systems they are simultaneous and inseparable. The controller output, in general, modulates the input to the pattern recognizer to increase the system's knowledge of its surroundings; the pattern-recognizer-controller system therefore is closed-loop, each part affecting the operation of the other.

A rudimentary visual system can be built that can recognize certain simple patterns and simultaneously react to them, altering them if necessary to improve its own rate of success. The system would consist of two arrays of photodetectors, two lenses, two mirrors, and electronic circuits that would react to the photodetector outputs, adjust the focusing with the lenses and mirrors, and drive motors and other mechanical devices to respond to what it sees.

The photodetector arrays would be more densely concentrated at their center than around the edges, to permit the system to "look" straight at anything interesting.

Measurement of the array outputs would be through a bridge circuit that gives an output only when unequal amounts of light fall on corresponding cells in the two arrays. The controller would react so as to minimize the difference in outputs of all the pairs of cells in the arrays, to maximize the differences between two such pairs, and to minimize the rate of change of cell pair outputs. These reactions would respectively insure that the images on both arrays were as nearly alike as possible; that the system's attention was concentrated on high-contrast boundaries, permitting it to "find" an object, and that, in the presence of an object of interest, the system did not continue to scan randomly as long as that object was present.

Presented at the National Electronics Conference, Chicago, Oct. 23-25.



amerline corporation BOBBINS

SEND FOR OUR
NEW CATALOG
TODAY!

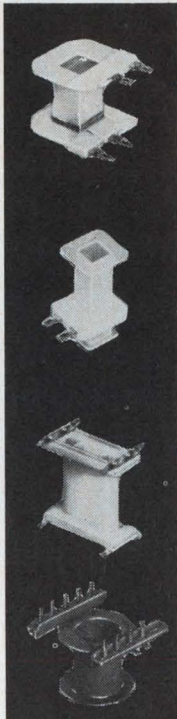
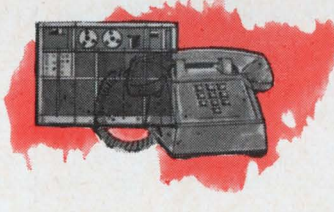
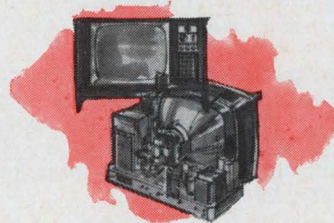
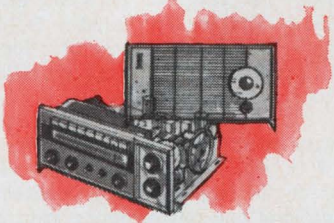

RADIO —

Moldcrafters of transformer bobbins oscillator I.F. and R.F. coil forms and stereo tape cartridges.

TELEVISION —

Producers of color yoke insulators, terminal boards, housing and convergence coil bobbins.

COMPUTER AND TELEPHONE —

Wide selection magnetic tape reels and containers, cartridges, disc packs, reed relay bobbins for computers, audio reels for tape recorders and players, bobbins for switching circuits and reed relays for telephone.

Complete line of patented Lead Slot bobbins.



AMERLINE CORPORATION
1800 FULLERTON AVENUE
CHICAGO, ILLINOIS 60614
(312) 348-4300 - TWX: 312-222-9410

Circle 297 on reader service card

your POSTMASTER suggests
SHOP and MAIL EARLY



"MAIL PARCELS"
▶ FOR OUT OF TOWN DELIVERY
NO LATER THAN DECEMBER 5th
▶ FOR LOCAL DELIVERY
NO LATER THAN DECEMBER 14th

"GREETING CARDS"
▶ FOR OUT OF TOWN DELIVERY
BY DECEMBER 10th
▶ FOR LOCAL DELIVERY
BY DECEMBER 15th

USE
WRAP PACKAGES
SECURELY

ZIP CODE NUMBERS
IN ALL ADDRESSES

POSTMASTER

Saving a few pennies in the initial cost of a capacitor is a fine idea. But, suppose the tolerance specifications are so rigid that you may have to buy ten for every one you can actually use. Not very economical! This is where WESCO fills the need for top quality capacitors that can be ordered in any quantity with close tolerances to $\pm 0.1\%$. They may cost a few pennies more, but think of the dollars saved by eliminating bulging inventories.

Call or write for complete pricing information.



WESCO
WESCO ELECTRICAL COMPANY, Inc.
27 OLIVE STREET / GREENFIELD, MASSACHUSETTS 01301

New Literature

Timers and counters. Eagle Signal Division, E.W. Bliss Co., 736 Federal St., Davenport, Iowa 52808. Sixteen-page catalog No. 15 covers a variety of industrial and commercial timers and counters.

Circle 446 on reader service card.

Beacon magnetron. Microwave Associates Inc., Burlington, Mass. 01803, offers technical bulletin 1523 describing the compact model MA-250, a 4-kw, X-band beacon magnetron. [447]

Interconnection products. AMP Inc., Harrisburg, Pa. 17105. A 10-page catalog describes an expanded line of Ampmodu modular interconnection products for printed circuitry. [448]

Digital measuring system. Electronic Associates Inc., West Long Branch, N.J. 07764. Bulletin 67251 on the series 6200 digital measuring system, a modular system, featuring plug-in versatility, is now available. [449]

High-fidelity relays. General Electric Co., Schenectady, N.Y. 12305. Bulletin GEA-7382C provides engineering data, ordering information, and outline drawings for the CR120 type K, a high fidelity, 300-v relay. [450]

Photoresist products. Shipley Co., 2300 Washington St., Newton, Mass. 02162. Data sheet S-111/9 describes two adaptable photoresists (AZ-111 and AZ-119) for low-cost processing of printed circuits. [451]

Microwave materials. Harshaw Chemical Co., 1945 E. 97th St., Cleveland, Ohio 44106, offers data sheets featuring magnetic saturation versus temperature curves for single crystals and polycrystalline microwave materials. [452]

Materials for semiconductors. Transene Co., Route One, Rowley, Mass. 01969. A 20-page catalog describes chemical products and materials used in processing solid state devices. [453]

Attenuation calibrator. PRD Electronics Inc., 1200 Prospect Ave., Westbury, N.Y. 11590, has issued a data sheet on the type 915-B microwave attenuation calibrator. [454]

Edge-lit indicators. Inter-Market Inc., 312 Waukegan Rd., Glenview, Ill. 60025. Engineering catalog 67-100 describes the KGM line of edge-lit indicators, giving details on 26 models. [455]

Plug-in relay. Deltrol Controls Corp., 2745 S. 19th St., Milwaukee, Wis. 53215. Bulletin 1095 provides complete technical information on the series 105 general purpose plug-in relay. [456]

Vibration-control mountings. Lord Manufacturing Co., 1635 W. 12th St., Erie, Pa. 16512, has issued bulletin D-944 covering bonded-rubber-metal Flex-Bolt mountings for low-cost vibration and shock control. [457]

Microwave components. Sperry Rand Corp., P.O. Box 4648, Clearwater, Fla. 33518. A 14-page catalog contains specifications and performance data on a line of microwave components including production-ready isolators, circulators and phase shifters. [458]

Monitor/controller. Airborne Accessories Corp., 1414 Chestnut Ave., Hillside, N.J. 07205. Capabilities, specifications and applications of a solid state monitor/controller are described in bulletin PS-18. [459]

Drafting aids. Bishop Industries Corp., 11728 Vose St., N. Hollywood, Calif. 91605. A 28-page catalog lists thousands of standard and special electrical and electronic engineering and drafting aids. [460]

Optical scanning system. Digital Scanning Corp., Route 332 East, Newtown,

SOLVE NOISE AND FILTERING PROBLEMS WITH CERAMAG® FERRITE BEADS



- Ceramag® ferrite beads are low cost, easy to install, and save space.
- Effective r.f. decoupling, shielding and parasitic suppression without sacrificing low-frequency power or signal level.
- Installed by simply sliding one or several over conductor leads.
- Beads can, but need not, be grounded.
- Sizes from .040" ID — .100" OD — 100" L.
- Sample quantities available.



STACKPOLE
CARBON COMPANY
Electronic Components Division
St. Marys, Pa. 15857

NEW SPECIAL PURPOSE RESISTOR PROTECTION

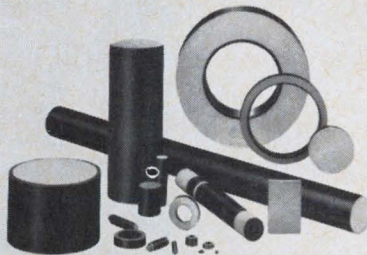

- Currently in use on lightning arrestors, circuit breakers, spark plugs.
- Available in rods, sleeves, rings, special shapes, up to 15" in length and 5" in diameter.
- Ceramic composition favors high voltage applications with high surges.
- Organic Special Purpose Resistors are inexpensive solution where heat dissipation is necessary.
- Both ceramic and organic available in wide range of resistivity values.
- Write for technical assistance.



STACKPOLE
CARBON COMPANY
Electronic Components Division
St. Marys, Pa. 15857

ENVIRONMENT PROOF ROTARY SWITCHES

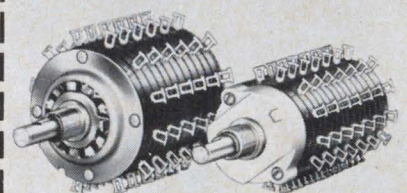

Series 600 1 1/2" Dia. — Series 100 1 1/8" Dia.

- Both index mechanism and electrical sections are completely enclosed.
- Corrosive atmospheres, dust, dirt and moisture are permanently sealed out, lubricants sealed in.
- Solder or quick-connect terminals molded permanently into position minimize production damage.
- Standard index angles include 15°, 30°, 36°, 60° and 90°, special angles available on request.
- Write for engineering bulletin.



STACKPOLE
COMPONENTS COMPANY
P. O. Box 14466
Raleigh, N. C. 27610

Pa. 18940. A 12-page brochure for users of data processing describes the Digitek 70 optical scanning system. [461]

Laser interferometer. Heidenhain Corp., 7952 N. Waukegan Rd., Niles, Ill. 60648, offers a four-page brochure describing a laser interferometer for measurement of displacements. [462]

Digital translator-display. Sigma Instruments Inc., 170 Pearl St., Braintree, Mass. 02185. Optoelectronic digital translator-display type 321 is illustrated and described in bulletin 1173 [463]

Digital timing control. Artisan Electronics Corp., 5 Eastmans Rd., Parsippany, N.J. 07054. Operational details, features and specifications for the model 490 electronic digital timing control are contained in bulletin 605. [464]

Operational amplifiers. Fairchild Instrumentation, 475 Ellis St., Mountain View, Calif. 94040. A six-page brochure includes specifications of FET, hybrid, chopper-stabilized, and general purpose operational amplifiers. [465]

Ultrasonic thickness testers. Branson Instruments Inc., Progress Drive, Stamford, Conn. 06904. The Vidigage ultrasonic, nondestructive thickness testers are described in a 12-page brochure. [466]

F-m vhf transmitter. Sonex Inc., 20 E. Herman St., Philadelphia, Pa. 19144, has issued a four-page bulletin on a 2-w true f-m vhf transmitter for airborne telemetry applications. [467]

Vswr measurement. Telonic Engineering Co., Box 277, Laguna Beach, Calif. 92652. An eight-page booklet presents a detailed report on error analysis of several types of voltage standing-wave ratio measurement systems. [468]

Continuous wideband recorders. Radio Corp. of America, Defense Electronic Products Div., Camden, N.J. 08102. Catalog B-155 describes the TR70-CVR series of video and r-f recorders. [469]

Printed circuits. Scientific Data Systems, 1649 17th St., Santa Monica, Calif. 90404, has available a 12-page brochure describing its capabilities in manufacturing custom-designed p-c boards for industrial and military applications. [470]

Molded memory plane. Indiana General Corp., Keasbey, N.J. 08832. Engineering data bulletin MP-80 illustrates and describes the Cor-Gard molded memory plane with 20- and 30-mil ferramic cores. [471]

Ultraviolet analyzer. Technical Measurement Corp., 441 Washington Ave., North Haven, Conn. 06473. Product

bulletin No. 55 discusses the model 1056B ultraviolet analyzer for continuous column monitoring. [472]

Mass spectrometer. Bendix Corp., 3625 Hauck Rd., Cincinnati, Ohio 45241, offers a brochure on the model MA-1 time-of-flight mass spectrometer. [473]

DTL integrated circuits. Raytheon Co., Lexington, Mass. 02173. A 28-page catalog on the 930 series DTL IC's describes flip-flops, gate expanders, multiple gates, dual buffers, a-c binary circuits, and monostable multivibrators. [474]

Microwave equipment. Electronics Division, LFE Inc., 1075 Commonwealth Ave., Boston, Mass. 02215, has published a six-page brochure on microwave oscillators, synchronizers, and stability testers. [475]

Small motors. IMC Magnetics Corp., 570 Main St., Westbury, N.Y. 11591, has published an eight-page catalog on 16- and 22-frame torque and synchronous motors. [476]

Digital and linear IC's. Westinghouse Molecular Electronics Division, Box 7377, Elkridge, Md. 21227. An eight-page quick reference guide presents schematic diagrams, design features, and model designations of more than 50 digital and linear IC's. [477]

UNEXCELLED QUALITY FOR LESS THAN 4¢

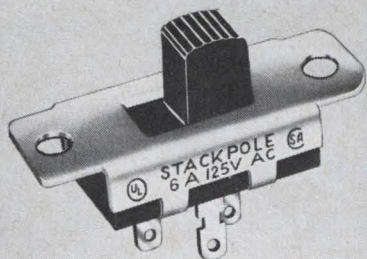

- Rated from 1 to 10 amps with full UL AND CSA approval.
- 7960 slide switch combinations — 23 basic types.
- New rugged solder lug terminal, designed for use with quick connectors.
- Uniform quality assured by automated assembly.
- Electro-silver plated terminals and contacts—shorting and non-shorting.
- Phenolic or nylon triggers in a variety of colors.
- Write for engineering bulletin.



STACKPOLE
COMPONENTS COMPANY
P. O. Box 14466
Raleigh, N. C. 27610

UNIQUE DESIGN ADDS VALUE AND APPEAL

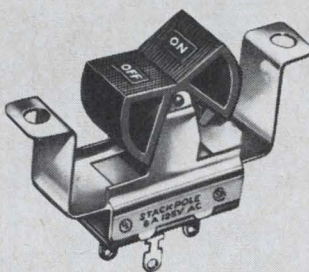

- 23 rocker switch configurations, including 2-3 positions, spring return and center-off.
- Variety of rocker designs available in a spectrum of colors and hot-stamped lettering.
- 1 to 10 amp UL AND CSA ratings at 125V and 250V.
- Solder lug, space saver, quick-connect or printed circuit terminals.
- Field-proven quality same as famous Stackpole slide switches.
- Prices start at less than 15¢.
- Write for engineering literature.



STACKPOLE
COMPONENTS COMPANY
P. O. Box 14466
Raleigh, N. C. 27610

CERAMAG® FERRITE MATERIALS CONSISTENT IN PERFORMANCE, QUALITY

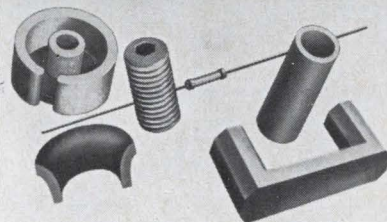

- Select from over 30 grades.
- Available in toroids; cup, insert and thread cores; bobbins; sleeves; transformer cores; deflection yokes; and rectangular solids.
- A wide range of sizes held to exact tolerances.
- Maximum permeability and high Q.
- Tooling available for hundreds of parts.
- Offers the advantage of complete moldability.
- Write for bulletin.



STACKPOLE
CARBON COMPANY
Electronic Components Division
St. Marys, Pa. 15857

Sample and hold. Sample and hold. Do dah. Do dah.

The closed-loop performance of Redcor/Modules' new Sample-and-Hold will put a smile on your face and a spring in your step. The 770-715 has an accuracy of 0.01%. If that don't get you, try a settling time of 5 microseconds for 20V step input. Or how about an input impedance of 10 megohms at 1 kc? Maybe a frequency response of DC to over 50 kHz? This performance, friends, is yours for a mere \$250 in quantities of 50. Redcor makes equally appealing comparators,

dynamic bridge and buffer amplifiers, 8-channel multiplexers, plus 0.1% Sample-and-Holds. They all have a great new pin layout that for the first time lets you easily interconnect modules with dual in-lines. So quit clapping your hands long enough to request complete data.

REDCOR 7800 DEERING AVENUE
CANOGA PARK,
CALIFORNIA 91304
(213) 348-5892 • TWX 910-494-1228

Circle 298 on reader service card

Ultra-miniature Neon or Incandescent

DATA LITES[®]

Meet most space-saving, multiple readout requirements

Datalites offer a system of indication for computer, data processing and other readout applications.

Datalites are ultra-miniature in size... can be mounted in 3/8" clearance hole. Lampholders can be spaced in any center-to-center measuring from 1/2" up.

Flexibility is provided by a choice of Neon or Incandescent light sources... with a wide range of lens colors and/or legend presentations available.

Typical Datalites are shown. For the many possibilities open to you and your application—ask for our latest 12 page Datalite catalog.

Why not do it today!

SAMPLES ON REQUEST—AT ONCE—NO CHARGE

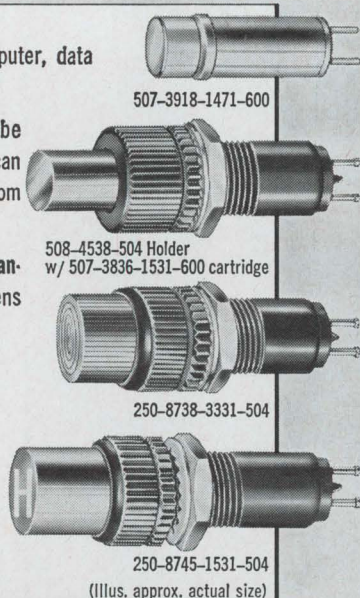

(Illus. approx. actual size)

DIALCO[®]

Foremost Manufacturer of Indicator Lights

DIALIGHT CORPORATION

60 STEWART AVE., BROOKLYN, N.Y. 11237

AREA CODE 212 497-7600

New Literature

Switchboard instruments. Voltron Products Inc., 1020 S. Arroyo Parkway, Pasadena, Calif. 91105. Short-form catalog SB67A describes a line of 4 1/2-in. switchboard instruments. [478]

Magnetic shielding material. Magnetic Metals Co., 2110 Hayes Ave., Camden, N.J. 08101, offers a bulletin giving technical data on Shieldmu 30CU magnetic shielding material for full-spectrum shielding from 1 hz to 10 Ghz. [479]

Digital data collection. Technical Measurement Corp., 441 Washington Ave., North Haven, Conn. 06473. A modular solution to problems in scientific data collection is discussed in product bulletin 51. [480]

Electrolytic capacitors. Cornell-Dubilier Electronics, 50 Paris St., Newark, N.J. 07101, offers a four-page Color-Lytic listing that categorizes electrolytic capacitors by capacitance instead of voltage. [481]

Heat sinks and coolers. Technical Accessories Co., Rt. 1 at Raymond Rd., Princeton, N.J. 08540. A four-page folder lists more than 100 types of semiconductor heat sinks and coolers with dimensions and application data. [482]

High-vacuum equipment. CHA Industries, 1215 Chrysler Drive, Menlo Park, Calif. 94025, has published two eight-page booklets, one dealing with high-vacuum modules and pumping stations, the other with deposition systems. [483]

Counters. N. Zivy & Cie., S.A., Oberwil, Basel, Switzerland. A 48-page catalog illustrates and describes a wide line of counters. [484]

Temperature control. Blue M Electric Co., 138th & Chatham St., Blue Island, Ill. 60406. Bulletin 6710 describes the Power-O-Matic 70, a solid state proportioning control system. [485]

Instruments and systems. Winslow Tele-Tronics Inc., 1005 First Ave., Asbury Park, N.J. 07712, offers an eight-page catalog entitled "Electronic Instruments and Systems for Education, Research, Development, Production, and Field Support". [486]

Phase shifters. DeMornay-Bonardi, Division of Datapulse Inc., 1313 N. Lincoln Ave., Pasadena, Calif. 91103, has issued a bulletin on the DB-X-198 direct-reading phase shifters for 7.05 to 90 Ghz. [487]

Power supply. Power/Mate Corp., 163 Clay St., Hackensack, N.J. 07601, has released brochure 125 describing the Uni 76 module power supply. [488]

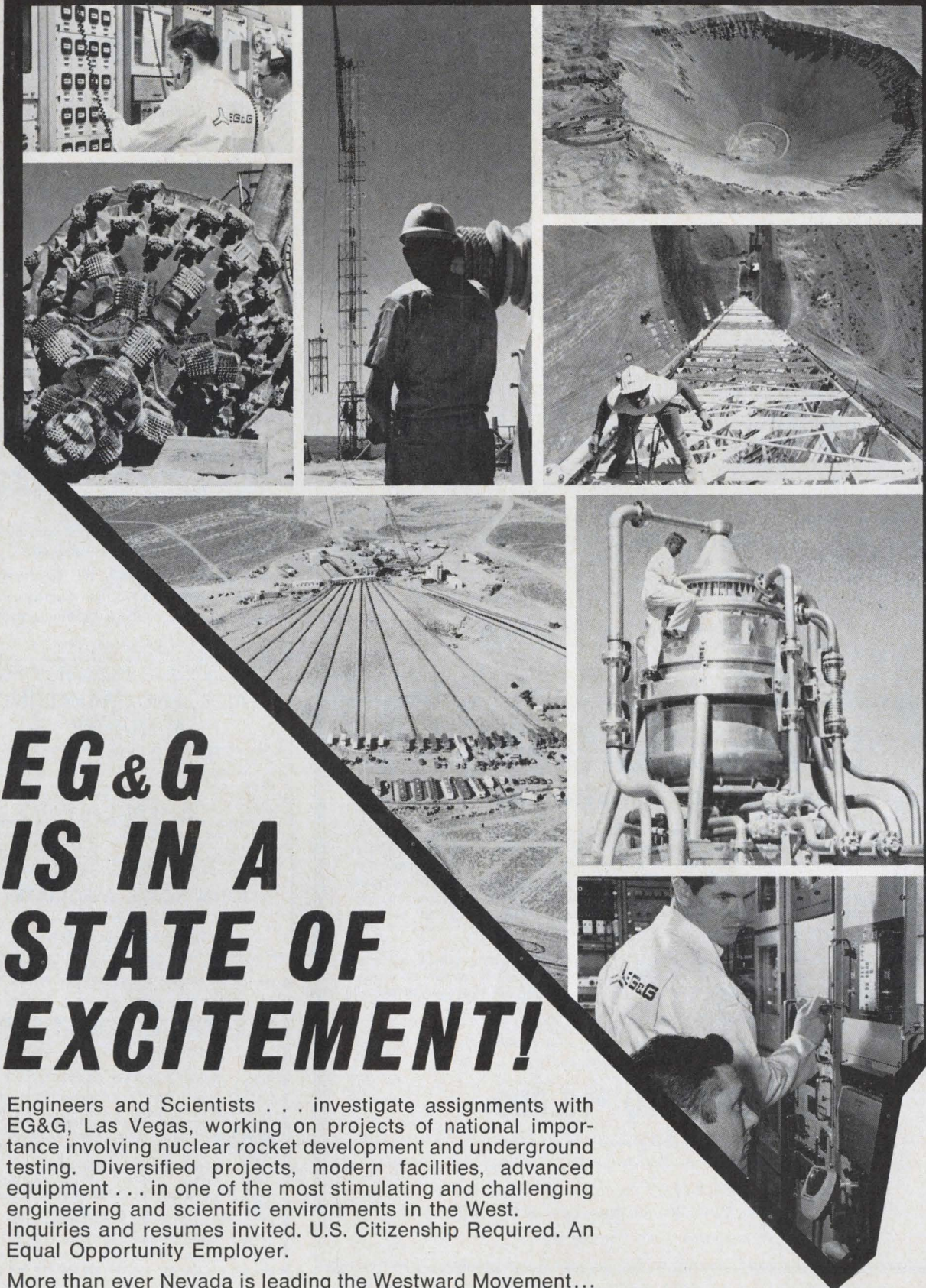

EG&G IS IN A STATE OF EXCITEMENT!

Engineers and Scientists . . . investigate assignments with EG&G, Las Vegas, working on projects of national importance involving nuclear rocket development and underground testing. Diversified projects, modern facilities, advanced equipment . . . in one of the most stimulating and challenging engineering and scientific environments in the West. Inquiries and resumes invited. U.S. Citizenship Required. An Equal Opportunity Employer.

More than ever Nevada is leading the Westward Movement... because Nevada offers more. More growth! More excitement! More personal and professional benefits! Dynamic Nevada . . . outstanding schools, facilities, services, entertainment and climate. Write EG&G, Personnel, 680 E. Sunset Road, Las Vegas, Nevada 89101.



engineers, your ship just came in!

Another nuclear aircraft carrier, boosting our contract backlog to \$500 million, creates added engineering career openings in all these disciplines:

Mechanical Engineers
Electrical Engineers
Marine Engineers
Industrial Engineers
Naval Architects
Nuclear Engineers

Civil Engineers
Metallurgical Engineers
Data Programmers
Systems Analysts
Chemists
Laboratory Analysts

If your training and experience are in or close to these fields, get details on immediate opportunities and long-range career security with the world's largest, most advanced shipbuilding company. Write our employment manager, John J. Gaughan. You'll get fast action.



Newport News
SHIPBUILDING AND DRY DOCK COMPANY, NEWPORT NEWS, VIRGINIA
An Equal Opportunity Employer

CIRCLE 951 ON READER SERVICE CARD

Electronics Field Engineers

This Is a Discriminatory Ad!

Major N. Y. metropolitan area aerospace manufacturer is seeking the services of top-flight electronics field engineers to work on and master extremely complex airborne electronic equipment. The men accepted for these positions must have exceptional competence, be of a high order of intelligence, with a mental attitude of not being fazed by the unexpected. Possessed of good health and drive, these men will have the attributes of a "team captain." Indeed, many will be just that . . . able to get the most out of electronics equipment and the men who keep it working.

Applicants must be experienced in one or more of the following areas: search and track radars, digital computers, inertial guidance systems, transistorized equipment. BS degree in Electronics or Physics, is desirable, but candidates demonstrating the equivalency will be considered. In-plant training will be given to the applicants chosen.

*These are unique career opportunities for qualified
Weapons or ECM Systems Engineers.*

SALARIES TO \$18,000

commensurate with background and experience

Arrange interview by sending comprehensive resume in strictest confidence to:

Box P-4277, Electronics

Class. Adv. Div., P. O. Box 12, New York, N. Y. 10036

An Equal Opportunity Employer (M/F)

EMPLOYMENT OPPORTUNITIES

The advertisements in this section include all employment opportunities — executive, management, technical, selling, office, skilled, manual, etc.

Send new advertisements to:

Electronics
Class Adv. Div., P. O. Box 12, N. Y., N. Y. 10036

Antenna Specialist

Starting Salary \$11,306 to \$14,717

To be responsible for developing new or revised radar specifications and procedures, both electrical and mechanical, to increase radar antenna reliability.

Will hold conferences with operating and maintenance personnel to determine maintenance and operating procedures used during actual operations and the sequence of events noted at the time of unsatisfactory performance. Will conduct a variety of experiments and tests to determine cause of equipment deterioration, failure or change in operational characteristics.

Requires B.S. degree plus 3 years of professional experience, one year of which must be specialized experience in electronic engineering leading to a thorough knowledge of electronics relating to radar antennas.

Career Civil Service position with liberal benefits. U. S. Citizenship required.

Send resume or SF-57 to: Employment Division (Code 174-5D), San Francisco Bay Naval Shipyard, Vallejo, California 94592.

An Equal Opportunity Employer

CIRCLE 952 ON READER SERVICE CARD

SALES AND MARKETING MANAGER

We are seeking a National Sales and Marketing Manager who has the desire and drive to get into a very high income bracket by way of his own effort and ability. Qualifications required: engineering degree in electronics, experience in selling electronic capital goods equipment, good knowledge of computers and allied equipment, plus some familiarity with programming, numerical control and software. If you have these qualifications and are looking for THE opportunity, send resume and starting salary requirements to

JOHN ROTTE ASSOCIATES

6100 Belleair Place,
Cincinnati, Ohio 45224.

CIRCLE 953 ON READER SERVICE CARD

We have been placing B.S., M.S., & Ph.D.

ELECTRONIC ENGINEERS

in FEE PAID positions throughout the U.S. since 1959 through our PERSONALIZED SERVICE.



Over 1000 client companies rely on us to provide carefully screened, technical referrals. We are staffed by experienced graduate engineers **WORKING FULL TIME FOR YOU!**

SEND RESUME TODAY

If none, send this ad with your name and address for confidential application.

ATOMIC PERSONNEL, INC.

Suite L, 1518 Walnut St., Phila., Pa. 19102

AN EMPLOYMENT AGENCY FOR ALL TECHNICAL FIELDS

CIRCLE 954 ON READER SERVICE CARD

SALES ENGINEER

Real opportunity for young, energetic engineer who knows electronics, computers, and is familiar with programming, numerical control and software to move into high income bracket selling electronic capital goods equipment. Should have Bachelors Degree in engineering-electronics. Outline your qualifications in resume to John Rotte Assoc., 6100 Belleaire Pl., Cincinnati, Ohio 45224.

CIRCLE 955 ON READER SERVICE CARD

Electronics | December 11, 1967

In electronics it's Electronics magazine to sell used equipment!

Your advertisement will produce Results in Electronics. Engineers turn to Electronics magazine for the latest technical developments — and for the latest buying information. You can reach them inexpensively in Electronics Searchlight Section.

For information:
Searchlight Section
Classified Advertising Division
Post Office Box 12
New York 10036

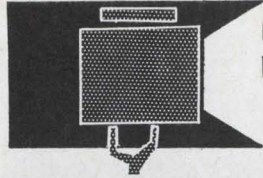

SEARCHLIGHT SECTION

• CLASSIFIED ADVERTISING • BUSINESS OPPORTUNITIES
• USED OR SURPLUS EQUIPMENT

AUTOTRACK ANTENNA MOUNT

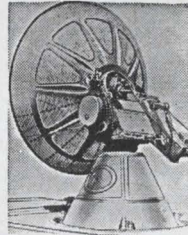

360 degree azimuth, 210 degree elevation sweep with better than 1 mil. accuracy. Missile velocity acceleration and slewing rates. Amplidyne and servo control. Will handle up to 20 ft. dish. Supplied complete with control chassis. In stock—immediate delivery. Used world over by NASA. USAF, MP-61-B. Type SCR-584. Nike Ajax mounts also in stock.

PULSE MODULATORS

MIT MODEL 9 PULSER 1 MW—HARD TUBE
Output 25kv 40 amp. Duty cycle .002, pulse lengths .25 to 2 microsec. Also .5 to 5 microsec. and 1 to .5 microsec. Uses 6C21. Input 115v 60 cycle AC. Mfg. GE. Complete with driver and high voltage power supply. Ref: MIT Rad. Lab. Series, Vol. 5, p. 152.

2 MEGAWATT PULSER
Output 30 kv at 70 amp. Duty cycle .001. Rep rates. 1 microsec 600 pps. 1 or 2 msec 300 pps. Uses 5948 hydrogen thyratron. Input 120/208 VAC 60 cycle. Mfr. GE. Complete with high voltage power supply.

250 KW HARD TUBE PULSER
Output 16 kv 18 amp. Duty cycle .002. Pulses can be coded. Uses 5D21, 715C or 4PR60A. Input 115 v 60 cy. AC \$1200 ea.

18 MEGAWATT PULSER
Output 150KV at 120 amps. Rep rate: 50-500 PPS. Pulse length: 5 msec. 15KV 120 amp. into pulse transformer. Rise time 1.5 msec. Filament supply 5V 80 amp. incl. 17.5KV 1.5 amp DC power supply. Input: 220V 60 cy AC.

VARIAN KLYSTRONS
V-45: .15W output CW 9 to 10 KMC
VA-800: 10 KW output CW 1.7 to 2.4 KMC
VA-806H: 1KW output CW 7.5 to 8.5 KMC

IBM 704 IBM 650

These computers in stock for immediate delivery

SCR 584 AUTOTRACK RADARS
Our 584s in like new condition, ready to go, and in stock for immediate delivery. Ideal for telemetry research and development, missile tracking, satellite tracking Fully Desc. MIT Rad. Lab. Series, Vol. 1, pps. 207-210, 228, 284-286. Comp. Inst. Bk available \$25.00 each.

MICROWAVE SYSTEMS

L BAND RF PKG.

20 KW peak 990 to 1040 MC. Pulse width .7 to 1.2 micro sec. Rep. rate 180 to 420 pps. Input 115 vac incl. Receiver \$1200

200-225 mc RADAR SYSTEM

1 Megawatt output. 200 nautical mile range for long range detection of medium and high altitude jet aircraft as well as general search. AN/TPS-28.

10 KW CW S-BAND

Complete 1700-2400 MCS RF system using VA-800 klystron. New.

SURVEILLANCE DRONE RADAR SYSTEM

X-Band tracking system with plotting boards. Type AN/MPQ-29. Drone also in stock.

5 MEGAWATT C-BAND

Klystron RF package delivering nominal 5 megawatt pulse RF. Complete with pulser and power supply.

500 KW L BAND RADAR

500 kw 1220-1359 msc. 160 nautical mile search range P.P.I. and A scopes. MTI. thyratron mod 5J26 magnetron. Complete system.

100 KW X BAND RADAR

Complete 100 kw output airborne system with AMTI. 5C22 thyr. mod. 4J52 magnetron. PPI. 360 deg as sweep, 60 deg. elev. sweep, gyro stabilizer, hi-gain revr. Complete with all plugs and cables.

AN/GPG-1 SKY-SWEEP TRACKER

AN/GPG-1 SKY-SWEEP TRACKER

AN/GPG-1 SKY-SWEEP TRACKER

AN/GPG-1 SKY-SWEEP TRACKER

AN/GPG-1 SKY-SWEEP TRACKER

AN/GPG-1 SKY-SWEEP TRACKER

AN/GPG-1 SKY-SWEEP TRACKER

AN/GPG-1 SKY-SWEEP TRACKER

AN/GPG-1 SKY-SWEEP TRACKER

AN/GPG-1 SKY-SWEEP TRACKER

AN/GPG-1 SKY-SWEEP TRACKER

AN/GPG-1 SKY-SWEEP TRACKER

AN/GPG-1 SKY-SWEEP TRACKER

AN/GPG-1 SKY-SWEEP TRACKER

AN/GPG-1 SKY-SWEEP TRACKER

AN/GPG-1 SKY-SWEEP TRACKER

AN/GPG-1 SKY-SWEEP TRACKER

AN/GPG-1 SKY-SWEEP TRACKER

AN/GPG-1 SKY-SWEEP TRACKER

AN/GPG-1 SKY-SWEEP TRACKER

AN/GPG-1 SKY-SWEEP TRACKER

AN/GPG-1 SKY-SWEEP TRACKER

AN/GPG-1 SKY-SWEEP TRACKER

AN/GPG-1 SKY-SWEEP TRACKER

AN/GPG-1 SKY-SWEEP TRACKER

AN/GPG-1 SKY-SWEEP TRACKER

AN/GPG-1 SKY-SWEEP TRACKER

AN/GPG-1 SKY-SWEEP TRACKER

AN/GPG-1 SKY-SWEEP TRACKER

AN/GPG-1 SKY-SWEEP TRACKER

AN/GPG-1 SKY-SWEEP TRACKER

AN/GPG-1 SKY-SWEEP TRACKER

AN/GPG-1 SKY-SWEEP TRACKER

AN/GPG-1 SKY-SWEEP TRACKER

AN/GPG-1 SKY-SWEEP TRACKER

AN/GPG-1 SKY-SWEEP TRACKER

AN/GPG-1 SKY-SWEEP TRACKER

AN/GPG-1 SKY-SWEEP TRACKER

AN/GPG-1 SKY-SWEEP TRACKER

AN/GPG-1 SKY-SWEEP TRACKER

AN/GPG-1 SKY-SWEEP TRACKER

AN/GPG-1 SKY-SWEEP TRACKER

AN/GPG-1 SKY-SWEEP TRACKER

AN/GPG-1 SKY-SWEEP TRACKER

AN/GPG-1 SKY-SWEEP TRACKER

AN/GPG-1 SKY-SWEEP TRACKER

AN/GPG-1 SKY-SWEEP TRACKER

AN/GPG-1 SKY-SWEEP TRACKER

AN/GPG-1 SKY-SWEEP TRACKER

AN/GPG-1 SKY-SWEEP TRACKER

AN/GPG-1 SKY-SWEEP TRACKER

AN/GPG-1 SKY-SWEEP TRACKER

AN/GPG-1 SKY-SWEEP TRACKER

AN/GPG-1 SKY-SWEEP TRACKER

AN/GPG-1 SKY-SWEEP TRACKER

AN/GPG-1 SKY-SWEEP TRACKER

AN/GPG-1 SKY-SWEEP TRACKER

AN/GPG-1 SKY-SWEEP TRACKER

AN/GPG-1 SKY-SWEEP TRACKER

AN/GPG-1 SKY-SWEEP TRACKER

AN/GPG-1 SKY-SWEEP TRACKER

AN/GPG-1 SKY-SWEEP TRACKER

AN/GPG-1 SKY-SWEEP TRACKER

AN/GPG-1 SKY-SWEEP TRACKER

AN/GPG-1 SKY-SWEEP TRACKER

AN/GPG-1 SKY-SWEEP TRACKER

AN/GPG-1 SKY-SWEEP TRACKER

AN/GPG-1 SKY-SWEEP TRACKER

PROFESSIONAL SERVICES

Donald C. Harder, Inc.

Magnetic Component Engineers

Reactors—Transformers—Filters
Serving the Research Laboratory

2580 K Street, San Diego, Calif. 92102
Phone (714) 239-8021

EMPLOYMENT SERVICES

Career Advancement—Electronic and electrical engineers, mathematicians, physicists. Challenging R&D, product development, QC systems manufacturing and sales positions. Fee paid. National exposure. Confidential. Send resume. Multiple Career Listings, Inc., 322 W. Jefferson Blvd., Dallas.

POSITION WANTED

Vice President/Gen'l. Mgr. Proven engineering graduate seeks broader position where he can materially contribute to growth and profits. Outstanding record includes full P&L responsibility, 10 yrs. mgmt., business dev. & admin. in aerospace, industrial mach'y & aircraft eqpt. Top nationwide mgmt. contacts, 9 years responsible technical positions in stress analysis, struc. design & machine design. PW-4390, Electronics.

RADAR SYSTEMS GROUND AND AIRBORNE. AUTOMATIC TRACKING ANTENNA SYSTEMS. NIKE AJAX. NIKE HERCULES. M-33. MSQ-1A. MPS-19. MPS-9. SCR 584. TPS-1D. TPS-28. FAA-ASR-2. AIRBORNE SYSTEMS. APN-84. APN-102. APS-20. APS-27. APS-45. DPN-19. DIGITAL COMPUTERS. IBM 650. IBM 704.

LARGEST INVENTORY OF RADAR AND MICROWAVE EQUIPMENT IN THE WORLD.
RADIO RESEARCH INSTRUMENT CO.
45 WEST 45TH ST. N. Y. 10036 212-JU 6-4691

CIRCLE 960 ON READER SERVICE CARD

ELECTRON TUBES

KLYSTRONS • ATR & TR • MAGNETRONS
SUBMINIATURES • C.R.T. • T.W.T. • 5000-6000 SERIES

• SEND FOR NEW CATALOG A2 •

A & A ELECTRONICS CORP.

1063 PERRY ANNEX

WHITTIER, CALIF.

696-7544

CIRCLE 961 ON READER SERVICE CARD

SPOT WELDING TWEEZERS



TW1 - 36" Lead \$11.65

AC and Stored Energy Power Supplies and Welding Heads

EWALD INSTRUMENTS CORP.

KENT, CONN. 06757

CIRCLE 962 ON READER SERVICE CARD

NEW VACUUM PENCIL



PHILIP FISHMAN COMPANY
7 CAMERON ST., WELLESLEY, MASSACHUSETTS

CIRCLE 963 ON READER SERVICE CARD

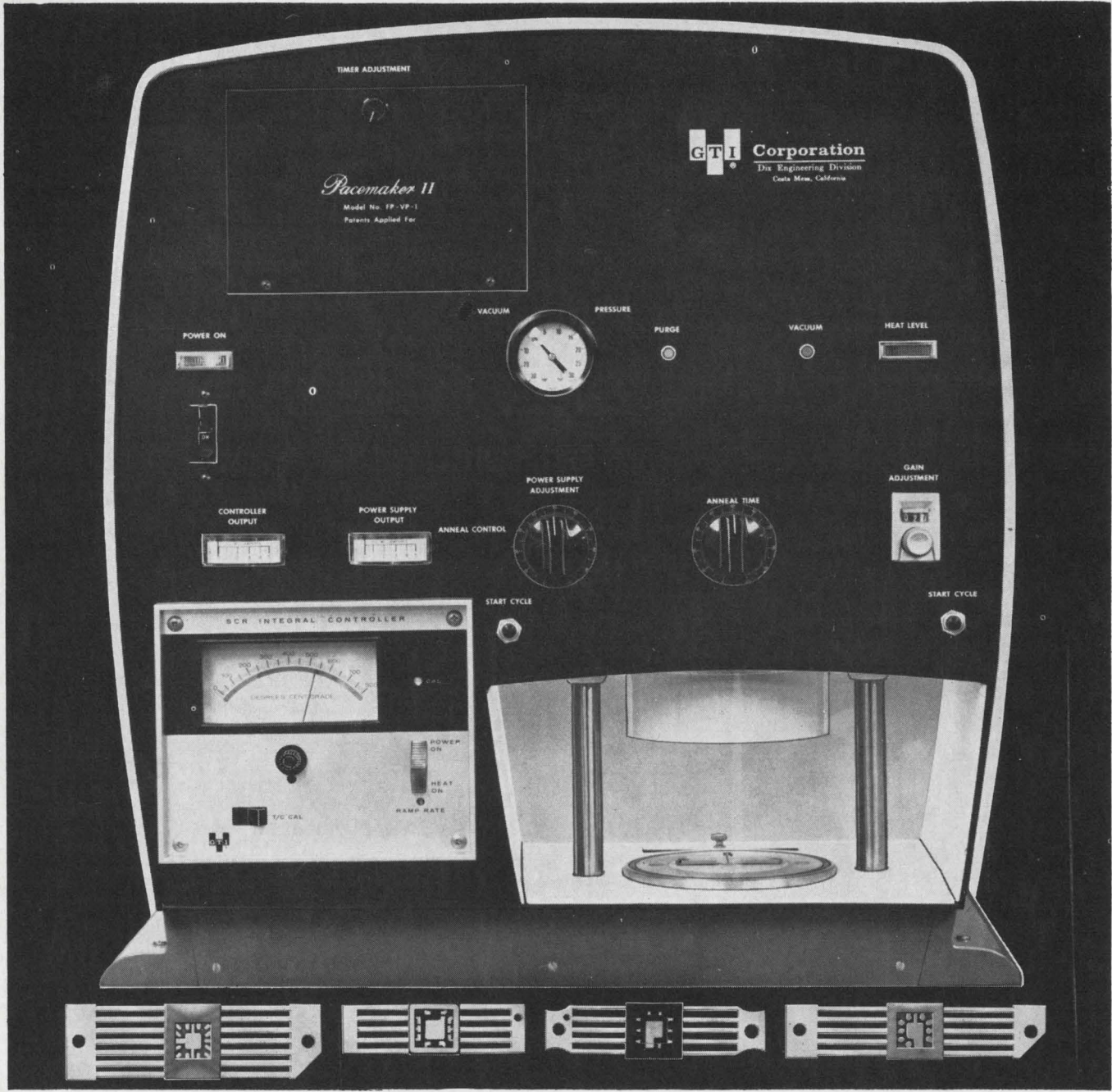

Total control for integrated circuit packaging...with GTI Providence Flat Packs plus the NEW GTI Dix Sealer

GTI FLAT PACKS

GTI offers a complete line of all-glass and glass-composition Flat Packs from 10-lead $\frac{1}{4}'' \times \frac{1}{4}''$ to 14-lead $\frac{1}{4}'' \times \frac{3}{4}''$. Using Corning's 7052 hard glass, nickel iron cobalt, and alumina glass compositions, GTI Flat Packs insure ruggedness, economy and reliability so necessary in today's microelectronic industry.



Send for **FREE Literature Now!**

Write to GTI Corporation, 310 Chestnut Street, Meadville, Pa. 16335 for Providence Division Integrated Circuit Flat Pack Data Sheet and Dix Engineering Division Flat Pack Sealer Data Sheet.

GTI FLAT PACK SEALER

The GTI Bench-Type, Single Head, Flat Pack Sealer incorporates the most advanced features for the controlled sealing of integrated circuits and film packages. Perimeter-type sealer seals glass, kovar, and ceramic packages in sizes from $\frac{1}{4}'' \times \frac{1}{8}''$ through $1\frac{3}{4}'' \times 1\frac{3}{4}''$. Sealer's versatility and size make it ideal for laboratory and pilot line use. Sealing atmosphere, location of heat, and time at temperature are strictly controlled, assuring high yields in final-sealing.

Flat Packs of all types can be sealed under vacuum or positive pressure. Heat is concentrated at the Flat Pack perimeter, thus keeping the device temperature at a safe level during the sealing cycle.



Newsletter from Abroad

December 11, 1967

Computer merger near in Britain

Britain's International Computers & Tabulators Ltd. and the English Electric Co. are expected to announce a merger, or at least a close alliance, of their computer activities early in the new year. **Such a link would have government support and might even be blessed by a government loan, as in the case of English Electric's tieup with Elliott-Automation Ltd.**

Talks between ICT and English Electric already have resulted in agreement to use certain common peripherals. Terms of the final deal will probably take this form: **neither company would abandon its major computer line—ICT's 1900 series and English Electric's System 4.** A single unified computer design would most likely have to wait until a new generation of equipment was due. However, marketing, research and development, purchasing, administration, and perhaps some other activities would be amalgamated progressively so that **the next-generation joint computer would be launched by a single consolidated organization.**

ICT's revenues, including rentals, come to about \$150 million a year. English Electric's income from its commercial computer operation, hurt this year by System 4 production troubles, is likely to be running at an annual rate of \$30 million by next spring.

Nippon Electric to make Ise's Digitron tubes

Nippon Electric Co. will produce Ise Electronics Corp.'s Digitron, a cold-cathode readout tube, for use in its line of calculators. **The deal calls for Nippon Electric to make an initial cash payment and then pay royalties, and Ise to provide technical assistance.**

Unlike conventional readout tubes that have the cathode at the rear, Digitron's cathode is up front [Electronics, May 29, p. 212]. One reason Nippon Electric turned to Digitron is that the tube doesn't require special processing to make the fluorescent material on numeral segments glow at low voltages. **And, according to informed sources, Ise was willing to make the deal because it had more business than it could handle.**

Meanwhile, Nippon Electric has launched an all-out campaign to prevent the Japanese government from granting a patent to Burroughs Corp. for its Nixie tube [Electronics, June 26, p. 203].

Elliott to start beam lead process

Elliott-Automation Microelectronics Ltd. of England will be in pilot production in about six months with semiconductor components using integral beam leads electrodeposited in gold. The method isn't new; scientists at Bell Telephone Laboratories reported on it almost two years ago. **But Elliott believes it's the first European company to reach production with beam leads.**

Elliott developed its own production procedures and will not pay license fees to Bell specifically for this technique. However, the firm does pay fees to cover use of some basic electronic techniques.

Like Bell's, Elliott's technique uses platinum silicide for ohmic contact with the silicon through the contact holes in the silicon dioxide layer. The oxide layer and the platinum silicide are then covered with titanium, which acts primarily as an adhesive between the oxide and platinum silicide, and a layer of pure platinum. The gold beam is electroformed atop the platinum [Electronics, March 20, p. 91]. Beam lead has two advan-

Newsletter from Abroad

tages. First, it's cheaper because beam formation is part of the automatic production process; second, reliability is increased.

Danish devaluation perils F-5 sale

Denmark's devaluation of the kroner and budget tightening have created shock waves that are being felt in the Pentagon. **The reason: concern that the Danes will put off buying about \$100 million worth of U.S. jet aircraft or turn to Sweden with the 50-plane order.**

Denmark has been weighing the Northrop F-5 against the more versatile Saab Traken, the Mach 2-plus mainstay of the Swedish Air Force that's designed for both fighter-bomber and interceptor use.

If Saab makes the sale, it would be Sweden's first fighter plane deal with a NATO nation, and it could open the door to further sales, particularly in Scandinavia. One move making Northrop take notice is the appointment, effective Jan. 1, of one of Sweden's top export salesmen, Kurt Mileikosky, as managing director of Saab.

Bull-GE and Czechs in computer deal . . .

Bull-GE, the French computer affiliate of the General Electric Co., is expected to reach an accord with the Czechoslovakian electronics industry combine, Tesla, for the production by Tesla of one of Bull-GE's medium-range computers. **Although French and Czech governmental red tape has delayed the signing of the licensing agreement, informed sources say that all details have now been worked out and that the pact will soon be signed.**

. . . and Prague may buy tv plants

Czechoslovakia is expected to buy a television-receiver factory and possibly a tube plant from France. In his visit to Prague to arrange the computer licensing agreement between Bull-GE and Tesla, French science minister Maurice Schumann also discussed color television with the Czechs, who like most Eastern bloc countries, will adopt the French Secam system.

Poland to make Grundig recorders

Grundig Werke GmbH, giant West German consumer electronics firm, has licensed Poland's state-owned foreign trade association, Universal, to make tape recorders. **This is the latest in a series of efforts to import Western electronics knowhow through licensing deals.** A Warsaw-based firm, Kasprzak, will start producing four tape-recorder models next year.

The units, conventional 3.75-inches-per-second types, will be marketed in Communist-bloc countries only.

East Germany importing workers

East Germany's high-riding electronics industry, the second largest in Eastern Europe, is increasingly turning to foreign workers to help ease its chronic labor shortage. Under an agreement made this year between East Berlin and Budapest, a contingent of Hungarian workers has arrived in Dresden and Karl-Marx-Stadt, primarily to work in the electronics industry. It's estimated that eventually 100,000 Hungarians may be employed.

East German officials figure that the country is lacking some 250,000 technicians, a shortage they attribute to large-scale defections to the West and a low postwar birth rate. **In the past, workers have been brought in from such Communist countries as North Vietnam and Poland.**

SPEER COMPONENT COMMENTS

All about a new economical method for selecting the right precision industrial resistors...

It's called "looking for the particular precision resistors that deliver the exact functional characteristics you need at the lowest possible price."

Perhaps this highly sensible method isn't new to you. But it will be to a lot of people. We've been amazed to discover just how many design engineers specify their industrial precision resistors on the basis of arbitrary (and non-functional) labels—such as the fact that the resistors meet certain MIL specs or feature "wire-wound" construction.

Don't get us wrong. MIL-spec resistors are fine—for military applications. But is it really logical to pay a premium for a wider range of environmental adaptability—and more documentation—than your industrial application actually involves?

Wire-wound resistors are fine, too. Even when they're evaluated on a functional basis, they may prove to be better than metal film resistors for certain industrial applications. But if you still assume that wire-wounds are better for every application, you simply haven't been paying sufficient attention to what's been happening in precision resistor technology in recent years.

Thanks in part to important advances by the Speer research and development people, our JXP resistors now are competitive with wire-wounds as far as resistance-temperature stability is concerned. And their statistical reliability is greater. Ditto their power density, when performance is equivalent. And their prices are not only competitive but are in many cases even lower than wire-wounds.

Our JXP metal film resistors, because of our exclusive manufacturing process, can be produced to tighter tolerances than wire-wounds at sig-

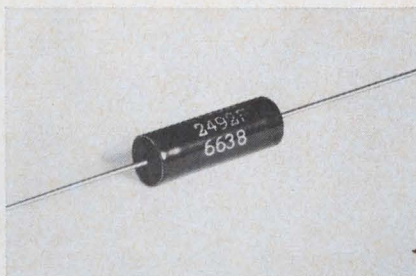

nificantly less cost for most resistance ranges. Furthermore, they automatically incorporate faster response and settling times at no additional cost.

You can get JXP's with tolerances and TCs as low as $\pm 0.02\%$ and ± 2 PPM/ $^{\circ}$ C, respectively, upon request. These "white room" metal film resistors have other startling functional characteristics that you should also be aware of. Use the coupon, and we'll send you the full details.

...and the right industrial precision resistor networks

As we've just demonstrated, evaluating industrial precision resistors on the basis of functional characteristics rather than arbitrary labels may change your buying habits.

Well, the same goes for resistor networks.

Our JXP precision resistors are available in all kinds of packaged networks and assemblies, needless to say. In addition, we can furnish you

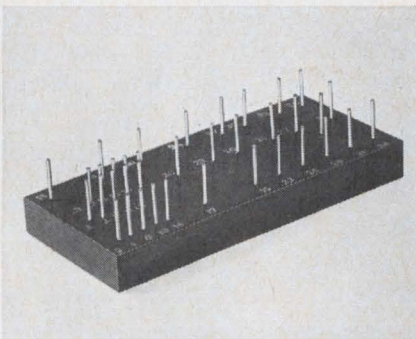

with any network engineering assistance you might need—from prototype preparation to testing and certification. For complete information, mail us the coupon.

How's your frequency on Typical Error #4 in inductor testing?

Continuing our review of the errors often made when measuring inductance and Q (see MIL-C-15305), error #4 is letting your test frequency become inaccurate.

Needless to say, preventing this particular lapse is easy. Just check it at regular intervals using accepted instruments of at least 0.1% accuracy.

For additional errors—and how to adjust for them—check with us.

AIRCO Speer Electronic Components

St. Marys, Pa. 15857

Rush details on just how functional your JXP precision resistors really are.

Ditto on your JXP precision resistor networks.

Name _____

Title _____

Company _____

Street _____

City _____ State _____ Zip _____

NEW

KEMET D's

The "DIET
CAPACITORS."

They take off inches.

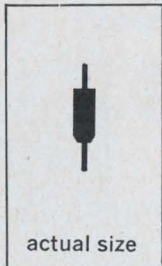
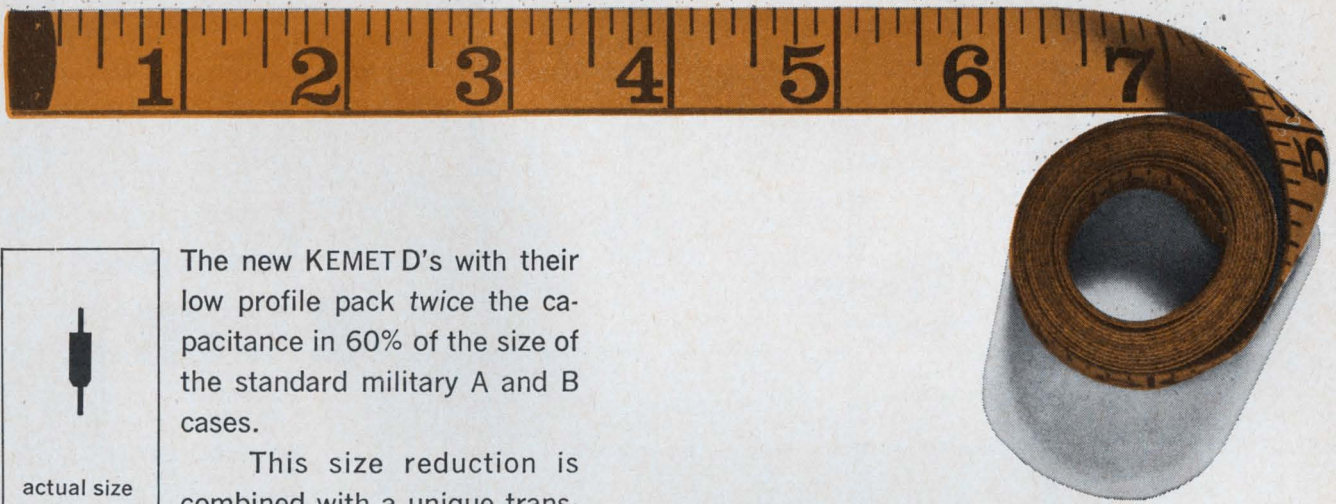

The new KEMET D's with their low profile pack twice the capacitance in 60% of the size of the standard military A and B cases.

This size reduction is combined with a unique transfer molding technique to produce a 3 case line (A², A¹ and B¹) especially suited for high speed automatic insertion equipment. These new KEMET D's can be punched readily, along with resistors and diodes, onto computer cards and printed circuit boards.

Typical applications of the new KEMET D's are commercial computers and peripheral equipment, communications systems and many other areas of electronics requiring high density packaging.

With an impedance rating of less than 1 ohm at 10 MHz for 12 μ F, the new KEMET D's are just great for computer applications with high clock rates that require low impedance at high frequencies.

Other important performance characteristics of the new KEMET D's are as follows:

Capacitance Range . . . from .0047 μ F to 68 μ F.

Voltage Range from 6V to 35V.

Temperature Range . . . from -55° C to $+85^{\circ}$ C.

D.C. Leakage Current . . . less than 1μ a at 25° C.

Temperature Cycling . . . exceeds MIL-STD-202.

There's a new products catalog that explains the new KEMET D's in great detail. To get your copy simply contact your local Union Carbide Representative or write us direct.

The new KEMET D's, the diet capacitors, from Union Carbide, The Discovery Company.



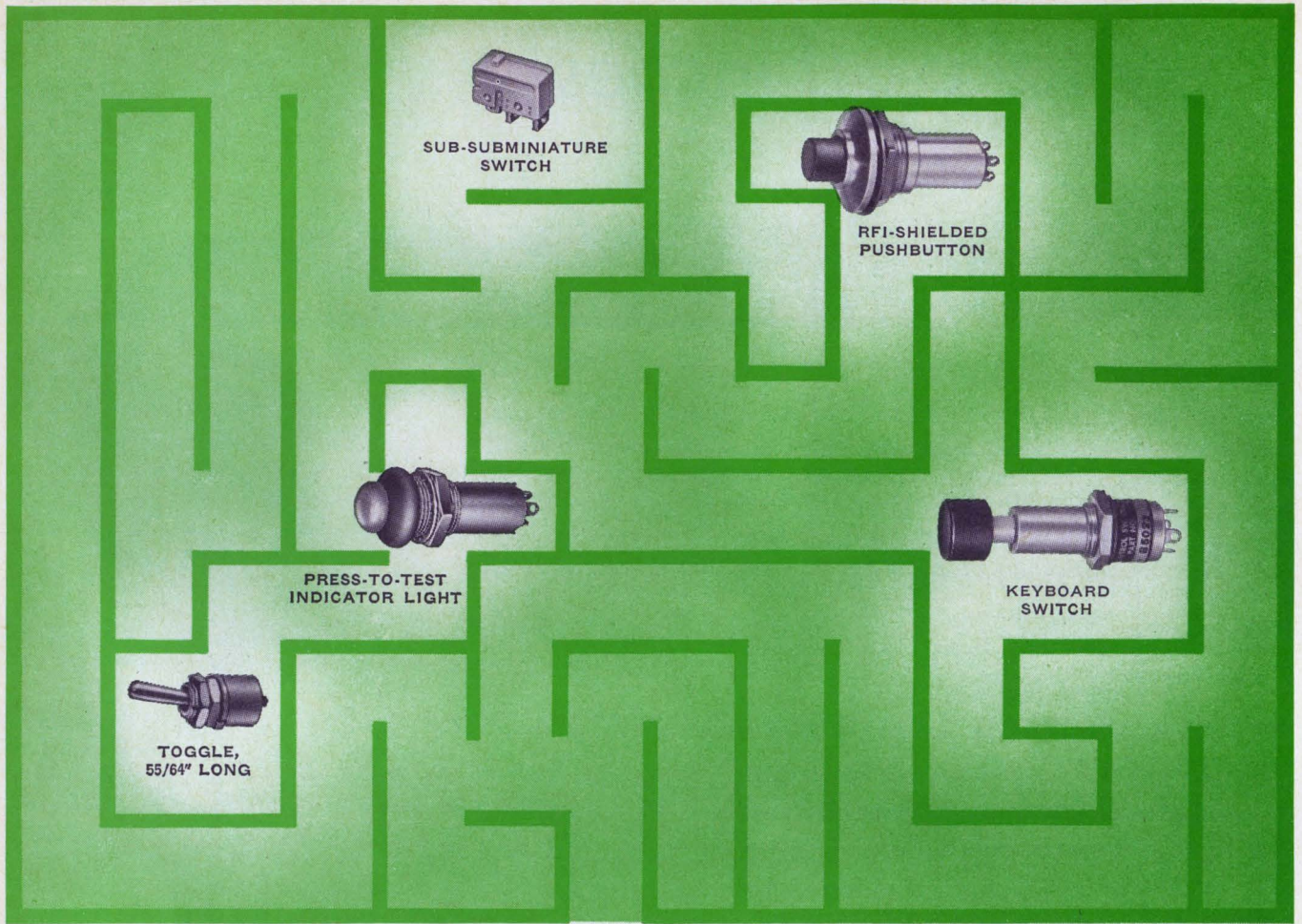

Why get lost looking for a switch?

Head straight for these Control Switch references!

Send for all the Control Switch catalogs and bulletins listed below . . . now! Keep them handy. When you need a different switch or indicator light, check Control Switch data first.

Odds are you'll find exactly what you want in ten minutes. For Control Switch makes more switches and indicator lights for the fields we serve than any other manufacturer.

What's more, they are high reliability components for applications where you cannot afford a failure. Sensitive control systems, for example. And missiles, computers, industrial equipment.

Control Switch advances include RFI-shielded switches and indicator lights, sub-subminiature switches, ultra compact pushbuttons. And indicator lights of only .200" diameter.

Order through us or your Control Switch distributor. He specializes in selected lines of electro-mechanical and electronic components. He knows your needs and has the Control Switch inventory to get your order out pronto!

SEND FOR THESE TODAY

Check numbers on the Reader Service Card corresponding to those at left below for any or all of these Control Switch references. While you're at it, get 'em all!

- # 511 Condensed Switch Catalog 100
- # 512 Basic Snap-Action Switch Catalog 110
- # 513 Toggle Catalog 180
- # 514 Indicator Light Catalog 120
- # 515 Hermetic Switch Catalog 130
- # 516 Switchlite Catalog 220
- # 517 Pushbutton Catalog 190
- # 518 RFI-Shielded Component Bulletin 62A

**C CONTROLS
C COMPANY
OF AMERICA**
CONTROL SWITCH DIVISION
1420 Delmar Drive, Folcroft, Pennsylvania 19032
A Subsidiary of
 General Precision Equipment Corp.

France

A gauntlet thrown

U.S. electronics companies in Europe generally take pains not to flaunt their strength. But all the same they've found themselves front-page news in recent weeks. In a spectacular best seller, French journalist Jean-Jacques Servan-Schreiber has singled out the U.S. electronics industry as a leader in the challenge that threatens to turn Europe into an underdeveloped area.

Servan-Schreiber's book, "Le Défi Américain" (The American Challenge) mounts a scathing attack against the centuries-old structure of Europe—political, social, educational, and, above all, corporate. The \$10 billion that American industry has invested in Europe since 1958, he insists, is only the effect of Europe's inability to cope. Servan-Schreiber, in fact, all but defies the American way of management, of education, of innovation.

Tocsin. Servan-Schreiber calls his work a "book of action," intended to galvanize Europe to face the challenge. And it has provoked much the same reaction as Ralph Nader's "Unsafe at Any Speed" or Rachel Carson's "The Silent Spring" did in the U.S.

In this year's National Assembly budget debates, "Le Défi" was cited to back up the arguments of both Gaullists and their leftist opposition. The book has sparked debate on television, in the press, and in countless cafes. Even President de Gaulle has read it. Since its publication in October, the book has sold nearly 200,000 copies, making it a smashing best seller.

Crucial. Servan-Schreiber worries most about the industries of the future. The most critical of these, he says, is electronics. At present, he writes, American firms control 15% of consumer electron-

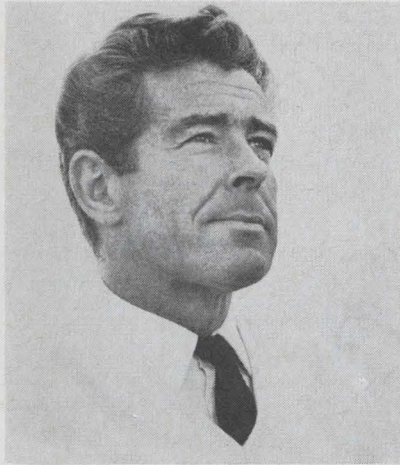

Gadfly. Jean-Jacques Servan-Schreiber wants Europe to stand up to the challenge of U.S. industry.

ics production in Europe, 50% of semiconductor production, 80% of computer production and 95% of the integrated-circuit production.

"Electronics," he adds, "is not just any industrial sector." He calls it the harbinger of the second industrial revolution during which computers will take over human mental tasks just as machines took over human physical tasks in the 18th century.

Huge supranational European enterprises are the only means of taking on the Americans effectively, he says. Nationalization of U.S. firms in Europe would be the worst solution: "What counts for a company today is not its walls or its machines, but immaterial elements that can't be nationalized." He says, for example, that nationalization of IBM-France would be intellectual, scientific, and industrial suicide. U.S.-trained managers would emigrate. The company would collapse after losing its link with its parent, the center of decision that fuels the subsidiary.

Federate. Restricting investment in Europe is no better, Servan-Schreiber adds. It would only increase the necessity to import products made in America. France, he points out, once tried to keep Amer-

ican firms from setting up shop in the country. But the de Gaulle government soon found that U.S. firms could thwart the ban simply by locating their new plants in other Common Market countries.

"Europe's tool," he says, "should be the Common Market—including Great Britain, the best possible ally of France in the Market." He urges elevation of the Market to federal stature, with its own budget and freedom of decision, a far cry from the present confederal structure that de Gaulle has succeeded in preserving.

For the moment the Common Market is only a tariff union for everyone but one big nonmember, the U.S. "While French, German or Italian companies are still groping in the vast space opened to them by the Treaty of Rome," he says, "the heavy units of American industry, after learning the peculiarities of the terrain, maneuver now from Naples to Amsterdam with the ease and rapidity of Israeli tanks in the Sinai."

Defense. Unchallenged, Servan-Schreiber says, American industry in Europe will become the world's third greatest power, after the United States and the Soviet Union. In his view, Europe's salvation lies in big companies. But bigness isn't all. "La force moderne," says Servan-Schreiber, "is the capacity to invent—that is, research—and the capacity to put inventions into products—that is, technology."

Ahead in infrared

Although the Société Anonyme de Télécommunications largely does what its name says it does, the company nonetheless has just about cornered the French market for infrared devices.

All the guided missiles the de Gaulle government has in mind for its nuclear striking force, for example, will carry SAT infrared de-

tection systems. And, SAT supplies the infrared hardware already in French reconnaissance planes.

The bulk of the infrared business comes from military and space customers, but SAT sees other promising markets ahead. Jean Turck, head of the company's missiles and space division, says he expects to find new outlets in clear-air-turbulence detection equipment and in laser communications.

Playing it cool. For both, SAT is developing hardware based on its latest infrared detector, the sensing element of which is a single crystal of mercury telluride-cadmium telluride with a spectral range from 8 to 14 microns. The crystal's time constant is less than 10 nanoseconds and its composition can be varied to suit peak response to various applications. SAT packages the detector in a dewar flask filled with liquid nitrogen to hold the temperature at 77°K.

The new device will be the kingpin component in a 45-pound clear-air-turbulence detector SAT will introduce late next year or early in 1969. The detector will have a horizontal field of 37°, a vertical field of 5°, and a range of 30 miles. Turck says the 30-mile range will give the pilot of a supersonic transport enough time to skirt a dangerous air pocket. The aircraft SAT sees as the most likely prospect is, of course, the Franco-British Concorde.

Linear link. The helium-cooled infrared detector also turns up in a long-range laser communications system SAT expects to start testing late next year or early in 1969.

The forerunner of the system is already being tried out at one of SAT's plants. Range of the system, which has a 3-watt output, is about two miles. But Turck sees a chance of stepping up laser power so that the laser link can span the same distances as microwave relays, which can be spaced up to 50 miles apart. The laser links, though, would need waveguide-like tubes to prevent attenuation by rain.

Like the laser radar being developed in the U.S. by the Autonetics division of the North American Rockwell Corp. [Electronics, Nov. 27, p. 48], SAT's system uses a pair

of carbon-dioxide lasers. One of them, which operates at 10 microns and 100 milliwatts, serves as a pilot oscillator. Its output passes through a gallium-arsenide modulator and then pumps the second, more powerful laser. The two-step technique, with the modulation initially applied at low power levels, makes it much easier to work up to higher powers than does straight modulation.

Bandwidth for the system is 100 megahertz, about the limit for a 10-micron laser. But this isn't a serious drawback; 100 Mhz of bandwidth is enough for six television and 400 telephone channels.

Japan

Around the bend

A race to get onto the market with a book-size television set seems to be shaping up in Japan. The contenders so far: The Hayakawa Electric Co. and the Tokyo Shibaura Electric Co. (Toshiba).

Last summer, Hayakawa demonstrated a development version of the flat cathode-ray tube for the set it has in mind [Electronics, June 12, p. 246]. Now, Toshiba has readied a prototype of its flat crt.

Both tubes have front-to-back dimensions of 2 inches, but with that the resemblance ends. The bulb in Hayakawa's 8-inch tube is roughly the shape of a book with a funnel tacked onto the bottom for the electron gun. Toshiba's 6-inch tube is wedge-shaped, with the electron-gun funnel projecting from the side. What's more, the Toshiba tube has a noticeably curved face-

plate, crucial to its low-power horizontal-deflection scheme.

Linear. In the Toshiba tube, vertical deflection is across a 90° angle, much the same as in conventional small crt's. The horizontal-deflection angle, however, is only 22°—about one-fifth the usual angle. Because of the small angle, the power needed to drive the horizontal-deflection coil is something like a tenth of that needed for a conventional tube. Since horizontal-deflection power commonly runs about three times vertical-deflection power, the over-all deflection-power requirement is cut by two-thirds—a big advantage in small, transistorized tv sets.

The faceplate actually is a section of cylinder. The center point of the horizontal deflection lies at a point that would be on the cylinder were it projected into the neck of the tube. Because of the center point's location, a sweep with linear angular velocity moves the electron beam at a linear velocity along the faceplate. Thus conventional saw-tooth deflection circuitry—but with lower power—can be used.

The horizontal-deflection geometry also means the beam-spot size on the faceplate can be held constant by dynamic focusing. Even without focusing, changes in spot size aren't a problem because modern electron guns have a large depth of focus.

Collimated. Vertical deflection is essentially conventional. But a correction is needed to prevent key-stone distortion. This is done by a collimator made up of permanent magnets spotted around the tube where the funnel joins it.

Although Toshiba says it could go into production soon, there is no definite plan for doing so. The

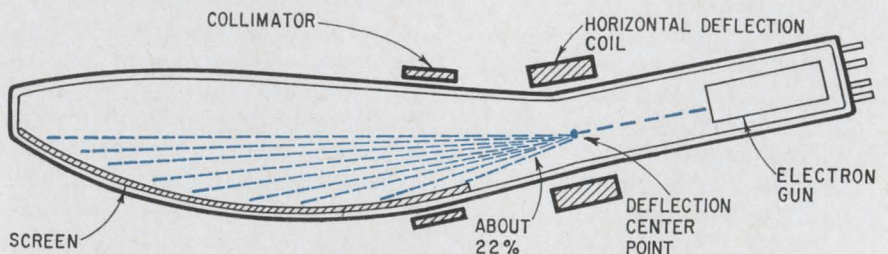

In good shape. Top view of Toshiba flat crt shows how curved faceplate and deflection center point's location keep horizontal deflection angle at a low 22°.



Svelte. Toshiba now has a prototype flat cathode-ray tube and may be first on the market with a book-size television set.

big problem is the bulb, made up of three major pieces—none of them simple shapes. The production tube, too, will need a shorter overall length than the prototype's 10.5 inches. To do this, Toshiba will bend the neck slightly and use a shorter electron gun.

High-octane GaAs

Every day and every way—almost—gallium arsenide looks better and better.

The GaAs story started a decade ago when the semiconductor material scored its first practical success in varactors for low-noise parametric amplifiers. Since then GaAs has been put to work in lasers, light-emitting diodes, microwave diodes, and microwave bulk-power sources.

Still another chapter was written last month when two researchers at the Japanese government's Electrotechnical Laboratories reported they've developed a new kind of GaAs oscillator.

The two, Hiroshi Tateno and Shoei Kataoka, still haven't pinned down exactly what makes their oscillator oscillate. They do know, though, that it's neither the Gunn-effect nor the limited space-charge

accumulation mode; both of these have been exploited in the U.S. to build oscillators with frequencies in the tens of gigahertz. And they know that the new oscillator can operate from several tens on up to several hundred gigahertz. What's more, it can be tuned across its range by an external circuit. It's this circuit, not the size of the device, that sets the frequency.

Notched. Starting material for the oscillator is a slab of GaAs 3 millimeters long, 1 mm wide, and 0.5 mm thick. The material has a carrier concentration of 1.2×10^{16} electrons/cm³. A notch cut near the center of the bar makes the cross section there 1 by 0.15 mm. An ohmic contact is formed at each end with a layer of tin. Around the notch, there's a control electrode insulated from the bulk GaAs by a layer of barium titanate. Two other insulated contacts, one near each end, serve as output electrodes.

The control electrode is connected to one of the ohmic contacts. When 60-nanosecond pulses of 800 to 1,000 volts are applied to the contacts, the slab oscillates. The frequency depends on the length of the shorted coaxial cable connected to the output electrodes. Thus far, Tateno and Kataoka have pushed the device to 380 Ghz.

Accent the negative. The Japanese researchers believe a suppressed space-charge layer causes the oscillation. As the voltage pulse is applied, the layer starts to form and move. But the high field applied by the control electrode works against it. The net result: a negative resistance between the two ohmic contacts.

Whatever the mechanism, it points to a device having great promise. As their next step, Tateno and Kataoka will try for continuous-wave operation. [For more on Japanese developments in GaAs Gunn-effect devices, see p. 125]. Since there appears to be little limitation on size, it should be fairly easy to boost the power output. Finally, the device could be a sleeper as a logic element. After the driving pulse decays, the device continues to oscillate for some time.

The Netherlands

A better weigh

In the everyday art of weighing things, innovations are rare. For some 7,000 years after the ancient Egyptians invented the balance, all the world's scales were essentially balances. It wasn't until the 18th century that scales based on pendulums and springs—the kinds that still prevail in small shops—came into use.

But with electronics, there's always something new. Researchers at Maatschappij Van Berkels' Patent NV have designed a scale that works with vibrating strings and digital integrated circuits. H.H. Thooft, business manager of the Berkel subsidiary in West Germany where the scale will be manufactured, claims it's going to revolutionize the business.

On the counter. Berkel expects to have the scale in production early

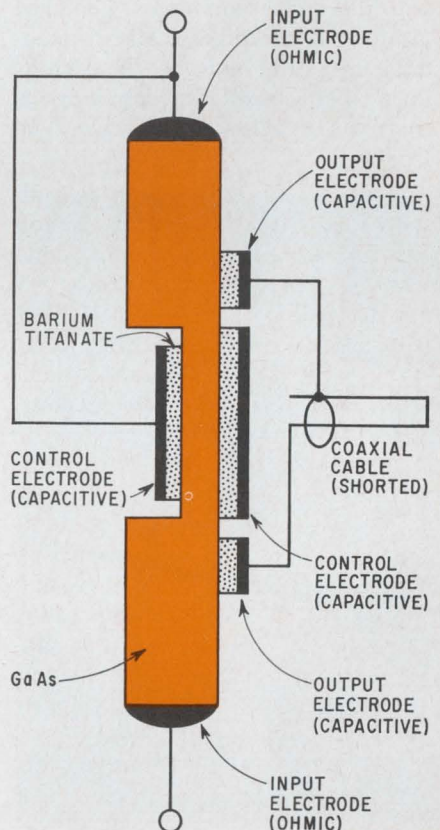

Call the tune. Length of coaxial cable connected to output contacts determines operating frequency of new Japanese GaAs oscillator.

in 1968 and will start selling it—mainly to grocery stores and butcher shops—during the second half of the year. The firm says the scale can handle up to 2,500 grams (5.5 pounds) and is accurate to within 1 gram.

Since the weight is calculated digitally, Berkel has quite logically added an IC computing network. With this, the scale can calculate the price of what's weighed if a price per pound is fed in through a keyboard in the display unit. Berkel won't say what the scale will cost, but Thooft maintains that owners of small stores will be able to afford it.

Pulling strings. The scale has two parts, a load cell box and the calculator unit with its display and price-per-pound keyboard. The two are interconnected by a cable and the whole affair is line-powered.

The actual measuring elements in the load cell are two vibrating strings. When the scale is loaded and a rod and two other strings change their tension, they vibrate at different frequencies centered around 17 kilohertz. Electromagnets on either side of the strings keep them oscillating as long as there's a weight on the scale. The

strings are made of beryllium-brass but have a low voltage applied across them to produce an interaction with the electromagnets.

In the calculator unit, the difference between the two frequencies is determined by zero-crossing detection and is then sent on to the IC logic circuits. The output of the calculating network is a series of current pulses that drive counters showing the weight, unit price, and the price of the item on the load cell.

Great Britain

Place in the sun

About every 11 years the sun gets rambunctious, much to the delight of sun-spot watchers around the world. A period of peak solar activity is on the calendar for next year and Decca Radar Ltd. is ready for it. Decca is marketing a solar radiometer priced at \$12,000 to \$17,000, depending on the sophistication a customer wants.

The company expects to sell the instruments mainly to observatories. But there should be some customers among communications-satellite operators who want to check the effects of solar activity at possible ground station sites. And there may be a few meteorologists who'll buy the gear, Decca figures.

The Greek way. Decca decided to take a fling at solar radiometers after Michael Anastassiadis of the Greek National Observatory pointed out the potential market. For starters, Anastassiadis ordered one himself and it will soon be on its way to Athens. Decca, which developed the instrument with the aid of the British government's Radio and Space Research Station at Slough, has a second radiometer under construction.

Solar radiation can be checked at frequencies from 5 megahertz and up; the higher the frequency, the deeper the penetration into the sun and the more informative the reading. However, at millimeter wavelengths atmospheric absorption makes for difficulty in the measure-

ment; so Anastassiadis and Decca opted for a 35-gigahertz frequency, where there's a "window" in the absorption spectrum.

On and off. Decca packaged the radiometer in two sections. The first consists of an antenna and a millimetric receiver up through the first intermediate-frequency stage. The second part, off the antenna stand, includes the remaining amplifier stages and the radiometer itself.

The radiometer uses a system devised years ago by R.H. Dicke of Princeton University to measure variations in the intensity of solar radiation. In Dicke's method, the signal picked up by the antenna and a reference signal at the same frequency are switched alternately onto the receiver so that two different noise-temperature levels pass through it one after the other. In Decca's gear, the switching rate is 50 hertz.

By comparing the two levels in a phase-sensitive detector, an output proportional to their difference is obtained. Since the reference is held constant within very close limits, changes in the detector output are a measure of changes in solar activity.

The antenna has a 24-inch dish and a swan-neck feed. Beamwidth is about 1° and the gain 45 decibels. Both the antenna and the radio-frequency head integral with it ride on an equatorial mount that tracks the sun automatically.

West Germany

Hazy market

It's mostly smog that comes in on little cat feet in West Germany these days. Along with smarting eyes and hacking coughs, the noxious haze has touched off another fast-growing market for electronics equipment.

In its fight against dirty air, the Ministry of Health this year spent some \$5 million to develop pollution-monitoring equipment and expects to up the ante next year.

West German electronics com-

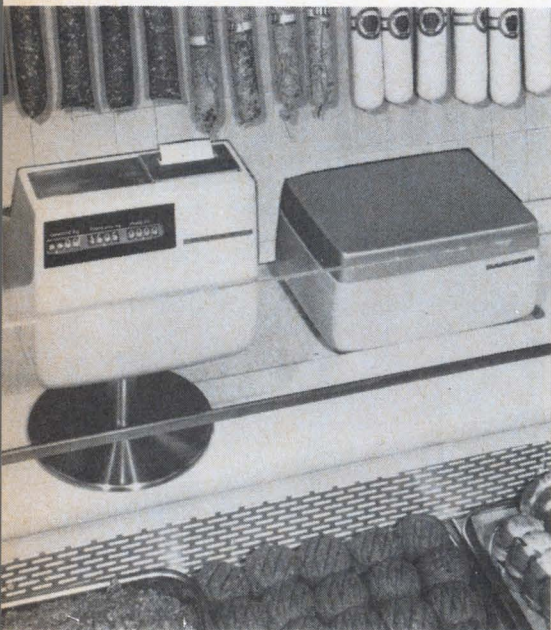

Thumbs off. Integrated circuits in Dutch electronic scale for butcher shops and grocery stores computes price of goods at same time they're weighed.



solved with
integrated
driver
and FET
switches

analog switching puzzle?

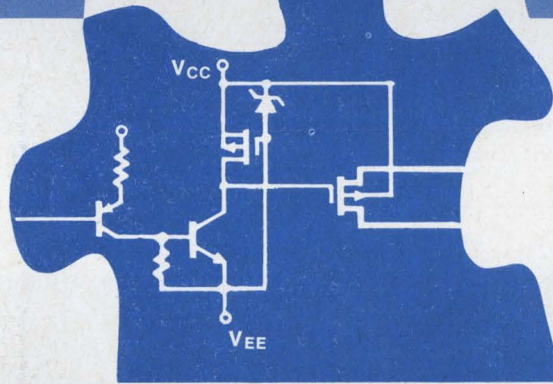

Analog switching got you puzzled? Here's the answer — an integrated circuit with drivers and FET switches all in one package. Drive the input with almost any integrated logic — only 0.8 volt swing is required. The output FET with ON resistance as low as 80 ohms and leakage less than 1 nA can switch plus or minus 20 volt signals.

Pick the driver-switch combination for your application: 2 to 5 channels; inverting drivers or not; MOS or junction FETs — see table. These products add to the wide variety of Siliconix drivers and FET switches that are now available from your distributor. Write or check inquiry card for data.

SILICONIX DRIVER-FET SWITCHES

Type	No. of Channels	Logic Input for ON Switch	Type FET Switch
DG102F	2	0	Jct
DG103F	2	1	Jct
DG104F	2	0	Jct
DG110F	2	1	MOS
DG111F	2	0	MOS
DG112F	2	1	MOS
DG126F	2*	1	Jct
DG116F	4	1	MOS
DG118F	4	0	MOS
DG123F	5	1	MOS
DG125F	5	0	MOS
DG122F	2*	1	MOS
DG132F	2*	1	MOS
DG120F	3*	1	MOS
DG121F	3*	0	MOS

* Differential — two common gate switches with common output.

NEW LOW COST FET TESTER

The SI200 Semiconductor Tester features plug-ins for expandable test capability, simplicity of operation, and low cost.

Price: SI200 Tester — \$960.

Price: SI201 (DC & g_{fs})

Plug-in Module — \$1335.

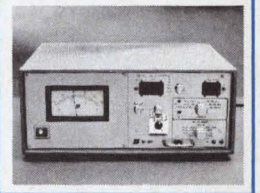

Franchised Distributors

ALABAMA Cramer Electronics, Inc.
Huntsville (205) 536-4493

ARIZONA Kierulff Electronics, Inc.
Phoenix (602) 273-7331

CALIF. Hollywood Radio & Elec.
Hollywood (213) 466-3181
Menlo Park (415) 322-3431
Kierulff Electronics
Los Angeles (213) 685-5511
San Diego (714) 278-2112
Elmar Electronics, Inc.
Mountain View (415) 961-3611
Oakland (415) 834-3311
Electronic Supply, Inc.
Riverside (714) 683-8110

COLORADO Kierulff Elec., Inc.
Denver (303) 825-7033

CONNECTICUT Cramer Elec., Inc.
Hamden (203) 288-7771

FLORIDA Perrott Associates, Inc.
Clearwater (813) 446-2535
Orlando (305) 275-1132
West Palm Beach (305) 585-7761

ILLINOIS Semiconductor Spec.
Chicago (312) 279-1000

MARYLAND Milgray Elec., Inc.
Hyattsville (202) 864-6330

MASS. Cramer Electronics, Inc.
Newton (617) 969-7700

MICH. Semiconductor Spec., Inc.
Detroit (313) 255-0300

MINN. Semiconductor Spec., Inc.
Minneapolis (612) 866-3434

MISSOURI Semiconductor Spec.
St. Louis (314) 521-8866

NEW JERSEY Tech. Elec. Dist.
Bergenfield (201) 384-3643

NEW MEXICO Kierulff Elec., Inc.
Albuquerque (505) 268-3901

NEW YORK Summit Dist., Inc.
Buffalo (716) 884-3450
Milgray Electronics, Inc.
New York City (212) 989-1600
East. Semiconductor Sales, Inc.
Syracuse (315) 455-6641

NORTH CAROLINA Kirkman Elec.
Winston-Salem (919) 724-0541

OHIO Alpine Industries, Inc.
Dayton (513) 278-5861

OKLA. Oil Capitol Elec. Corp.
Tulsa (918) 836-2541

PENNSYLVANIA Milgray Elec., Inc.
Philadelphia (215) 228-2000

TEXAS Sterling Electronics, Inc.
Austin (512) 452-0271
Dallas (214) 357-9131
Houston (713) 666-4061
Lenert Company
Houston (713) 225-1465

WASHINGTON Washington Elec.
Seattle (206) 682-8981



Siliconix incorporated

1140 W. Evelyn Avenue, Sunnyvale, California 94086
Telephone (408) 245-1000 TWX: 910-339-9216

Service...Engineering...Experience

MAKE THE **BIG** DIFFERENCE
BETWEEN A YOKE SPECIALIST
AND A YOKE SUPPLIER

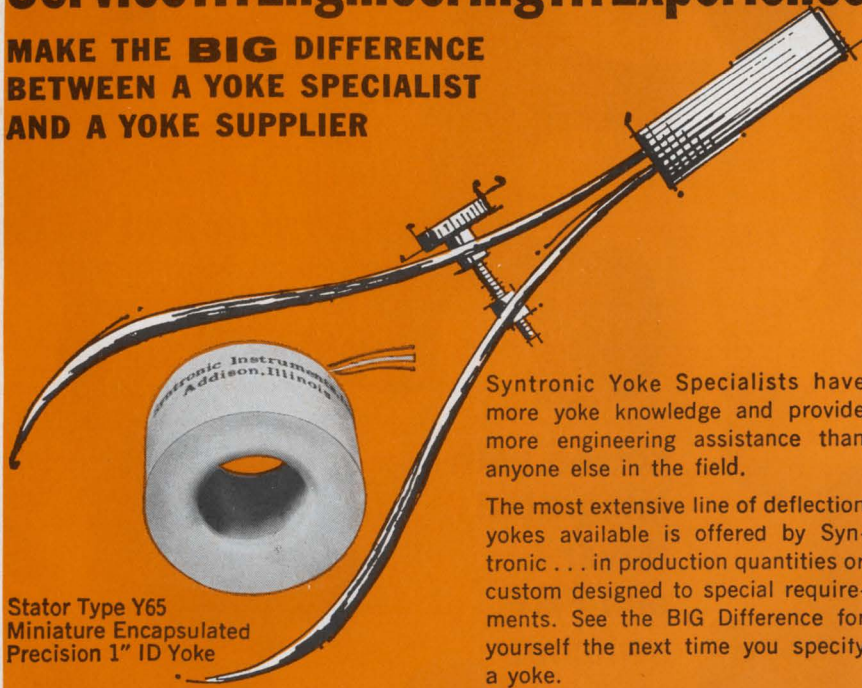

Stator Type Y65
Miniature Encapsulated
Precision 1" ID Yoke

Syntronic Yoke Specialists have more yoke knowledge and provide more engineering assistance than anyone else in the field.

The most extensive line of deflection yokes available is offered by Syntronic... in production quantities or custom designed to special requirements. See the BIG Difference for yourself the next time you specify a yoke.

syntronic INSTRUMENTS, INC.
100 Industrial Road, Addison, Illinois Phone 312, 543-6444

Circle 299 on reader service card

New high efficiency, high frequency Photochopper Modules

- High stability from -25 to $+75^{\circ}\text{C}$, efficiency varies less than 5% over temperature range
- 50% efficiency at 1000 Hz
- Internal electrostatic shielding
- CdS cells for fast warm up

Write for new Bulletin 201/ITD3-67



1239 BROADWAY, NEW YORK, N.Y. 10001

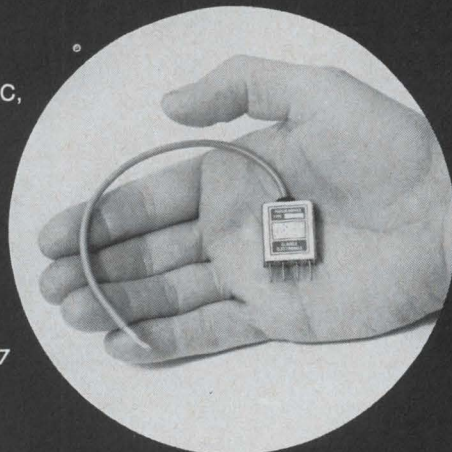

Electronics Abroad

panies, too, have been doing much research on their own hook, readying for what seems a lusty market. It's estimated that some \$500 million has been spent on air pollution monitoring and control equipment, much of it electronic, during the past five years.

And the outlay apparently is headed up. Next year, Germany will become the first West European country to set limits on the pollutants in automobile exhaust. Within the next 10 years, one components manufacturer estimates, some \$50 million annually in electronic components will be going into automakers' pollution-control devices. Volkswagenwerk AG, the country's largest auto producer, already has adopted an electronic fuel injection unit so that the VW 1600's it sells in the U.S. will meet antipollution regulations [Electronics, Oct. 2, p. 235].

Towering job. Cities around the country also are turning attention to the air pollution problem. Munich, for instance, plans to spend \$40,000 for monitoring gear. It will be spotted at seven points on the city's 950-foot-high television tower.

Data on sulfur dioxide levels and air temperatures picked up by the instruments on the tower will be fed over telephone lines to a central station at the city hall. The data, along with that from existing checkpoints around the city, will be analyzed by computer. Eventually, the system will be able to sound an alarm when a dangerous situation is imminent. A similar monitoring and alarm system is in the works at Frankfurt.

Well stacked. Another burgeoning market for air-pollution electronics turns up at industrial plants. Under German regulations, any power plant rated at 3.2 million BTU's per hour or more must have monitoring equipment in its stack.

The latest stack equipment—for continuously checking the density of smoke and dust—is that of AEG-Telefunken. It has a single lamp and a single photocell but operates nonetheless on a twin-beam system. In such systems, a light beam that passes through the smoke and across the stack is checked against

CONSIDER COLORADO / INDUSTRIAL COLORADO

a reference beam.

In the measuring head, a semi-reflecting mirror splits the light from the lamp into the two beams. The measuring beam is bounced off a reflector on the opposite side of the stack; the reference beam passes out through the head optics, but is bounced back without crossing the stack.

Both beams go through a chopper before they hit the photocell. The cell's output pulses are amplified and then demodulated in phase to sort out the reference and measurement signals. Comparing the two beams provides a measurement of the dust and smoke particles. And because of the comparison, there's inherent compensation for soiling of the head's windows, aging of the lamp, amplifier drift, and like factors that otherwise would introduce error in the measurement.

Sweden

Care-full computer

Sweden, long a leader in biomedical engineering, is planning another first—a medical profile data bank covering the citizenry of Stockholm.

The data will be stored at a main information center, the new Huddinge hospital, which will be linked with other hospitals via closed-circuit television. By dialing a patient's registration number, a doctor will be able to obtain the complete medical history of that patient. Everyone in the country is covered by a unified medical-care plan.

The system will also keep track of the availability of hospital beds and doctors, as well as stocks of blood, plasma, medicines, and hospital supplies.

A \$500,000 Univac computer has been ordered for a smaller hospital in the Stockholm area as the first step toward implementing the plan. The main system is scheduled to go into operation by 1972, by which time Stockholm's population will have reached 2 million.

... where research and education set an accelerated pace ... Innovating for industry. Providing information and qualified personnel. Through government, university and private sources.

Consider basic and applied research being conducted in Colorado by over 100 organizations. More than 3,500 graduate scientists directing the activities of thousands of specialized personnel to gather, correlate and apply data about everything from marketing to missiles, from the arctic to aerospace.

Consider Colorado's scientific and academic community. Fifth ranking state for percentage of scientists in its population. 10.7% of the population in the 25 and older age group with 4 years of college, the highest percentage in the nation. A professional atmosphere and a pleasant and varied "living" environment that attracts and holds scientists, engineers and technical administrators. A recent survey of graduating college students points up the desirability of locating in Colorado by ranking Denver among the top 3 major U. S. cities preferred for living.

Consider the excellence of Colorado's education system. 16 colleges and universities. 6 junior colleges. Per capita spending for institutions of higher learning ranks the State fourth in the nation. 23% of the State's annual budget earmarked for education.

If a burgeoning scientific and academic community would be an asset to your business, consider Industrial Colorado for your expansion or relocation.

DIPLOMA IS A
RECOMMENDATION
ON THE 7TH DAY
OF THE YEAR OF THE

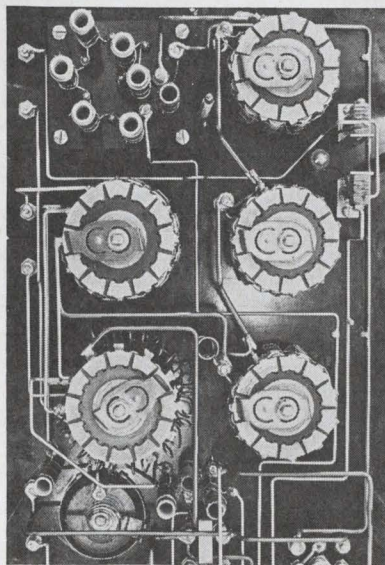
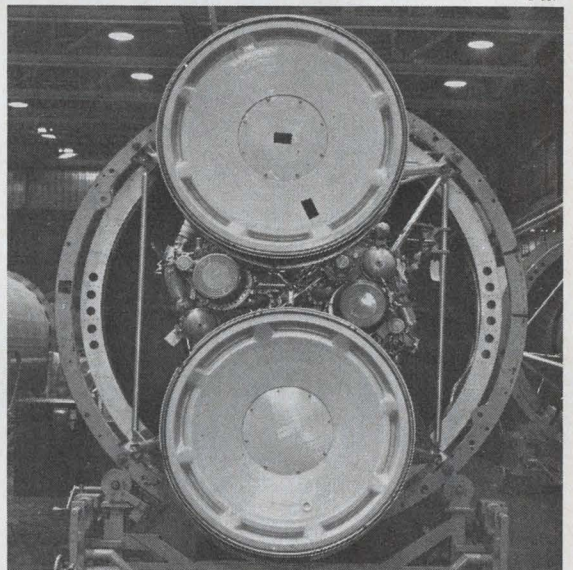

A well-educated population, numerous centers of basic and applied research, and a desire to find practical applications for new discoveries characterize Colorado. Write for a complimentary copy of Industrial Colorado, a revised-to-the-minute, factual, spiral-bound portfolio. It covers important considerations pertinent to plant expansion or relocation in any part of the State. Address inquiries to Ronald D. Lemon, Director, Industrial Research & Development, Division of Commerce and Development, 56 State Services Building, Denver, Colorado 80203.

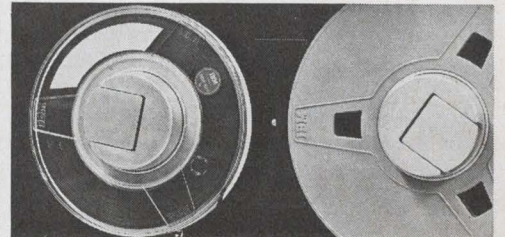



Paul R. Trautmann, President, Spectrol Electronics Corporation

Welcome to your new trimmer and potentiometer facility!

For years, we have been doing our best to provide you with the industry's finest precision potentiometers and trimmers. But we've been doing something else, too. We've been listening when you had something to say. So to continue to give you what you want in product and service, we've developed the industry's most complete capability.

We built a new main plant in the fast-growing industrial suburb of Los Angeles, the City of Industry. This new Spectrol building is thought by many to be the best in the industry. It was planned, built, and equipped exclusively for the design, development, and volume production of high quality, competitively priced, electromechanical components.

But the whole story cannot be told by machines, bricks and mortar. Outstanding people and procedural know-how

Circle 260 on reader service card

are also necessary to turn a *facility* into a *capability*.

That's why we expanded our research and engineering staff and further streamlined our organization and procedures to reflect the most modern and up-to-date administrative and production techniques.

Our regular customers have already felt the impact of the new Spectrol capability. If you aren't a regular customer yet, why don't you find out more about us? Be our guest at *the facility we built for you*. We're confident that you'll like what you see. You'll like our products, too. Let us send you our Short-Form Catalog.

Spectrol Electronics Corporation
17070 East Gale Avenue
City of Industry, California 91745
Better Components for Better Systems



■ Acton Laboratories, Inc. Impact Advertising, Inc.	237	■ Dale Electronics, Inc., Sub. of Lionel Corp.	3rd Cover	HI-G, Inc.	134
Ad-Yu Electronics, Inc. P & G Advertising Agency	229	Swanson, Sinkey, Ellis, Inc.		Marketing Assistance, Inc.	
Aircro Speer Electronic Components Hazard Adv. Co., Inc.	249	Damon Engineering, Inc. L. K. Frank Co., Inc.	16	■ Honeywell, Micro Switch Div.	135
Airpax Electronics, Inc. Welch, Mirabile & Co., Inc.	176	Delco Radio Div., General Motors Corp. Macbill/Ross, Inc.	173	■ Honeywell, Test Instruments Div.	74, 75
Air Reduction Co., Inc. Aircro Industrial Gases Div. Fuller & Smith & Ross, Inc.	141	Delco Radio Div. of General Motors Corp. Campbell-Ewald Co.	64, 65	Houston Instrument, Div. of Bausch & Lomb	222
Allen-Bradley Co. Fensholt Advertising Agency	37, 39	Di-Acro Corporation, Div. of Houdaille Industries, Inc. Charles E. Brown Adv. Agcy.	186	Ray Cooley & Associates, Inc.	
■ Amelco Semiconductor, Div. of Teledyne, Inc.	34, 35	Dialight Corp. H. J. Gold Co.	242	Hughes Aircraft Co.	205
American Optical Co., Instrument Div. Fuller & Smith & Ross, Inc.	148	Digitran Co., The Smith-Klitten, Inc.	192		
Amerline Corp. Carlson Advertising Co.	239	■ Dimco Gray Co. Weber, Geiger & Kalat, Inc.	224	Icon Corp.	237
■ AMP, Inc. Garceau, Hallahan & McCullough, Inc.	197	Dow Chemical Co., The MacManus, John & Adams, Inc.	81	■ Indiana General Corp., Magnet Div.	24
■ Amphelol Corp., Connector Div. Marsteller, Inc.	72, 73	■ DuPont de Nemours & Co., E.I., Electrochemicals Div. Rumrill-Hoyt, Inc.	174	Industrial Electronic Engineers Gumpertz, Bentley & Dolan, Inc.	106
■ A.P.I. Instruments George Z. Griswold Advertising	159	■ DuPont de Nemours & Co., Freon Div. Batten, Barton, Durstine & Osborn, Inc.	69	Information Handling Services Martz & Associates	195
■ Astrodyne, Inc. Tech/Reps, Inc.	200			International Crystal Mfg. Co. Robert V. Freeland & Associates	190
Automatic Electric Co., Sub. of General Telephone & Electronics Corp. Marsteller, Inc.	84			I R C, Inc. Gray & Rogers, Inc.	85
				■ ITT Jennings Mfg. Co. West, Weir & Bartel, Inc.	180
				ITT Wire & Cable West, Weir & Bartel, Inc.	208
■ Barnstead, Sub. of Ritter Pfaudler Corp. Creamer, Trowbridge, Case & Basford	181	Elco Corp. Fien and Schwerin, Inc.	38		
■ Bausch & Lomb, Inc. Wolff Associates, Inc.	153, 263	Electro Scientific Industries Nadler & Larimer, Inc.	7	■ Johanson Mfg. Co. Josephson, Cuffari & Co.	220
■ Beckman Instruments, Inc., Helipot Div. Hixson & Jorgensen, Inc.	22	Electro-Sonics, Inc. Mead-Ross Associates	232		
■ Bell Aerosystems Co. Comstock Advertising, Inc.	154	■ Electro Tec Corp. Wilson, Haight & Welch, Inc.	54	■ Kepco, Inc. Weiss Advertising	58
■ Bell, Inc., F. W. Wheeler, Kight & Gayney, Inc.	199	Electronic Associates, Inc. Gaynor & Ducas, Inc.	78	Keystone Carbon Co. Downing Industrial Adv., Inc.	264
■ Bendix Corp., Semiconductor Products Div. MacManus, John & Adams, Inc.	55	Electronic Communications, Inc. Neals & Hickok, Inc.	191	■ Krohn-Hite Corp. L.K. Frank Co., Inc.	156
■ Bissett-Berman Corp. S. F. Associates	194	Electronized Chemicals Corp. Kenyon & Eckhardt, Inc.	233		
■ Bourns, Inc., Trimpot Div. Lester Co., The	218	Emerson & Cuming, Inc. Edwin F. Hall	213	■ Lambda Electronics Corp. Michel Cather, Inc.	83
■ Brush Instruments, Div. of Clevite Corp. Carr Liggett Adv., Inc.	169	■ Erie Technological Products Co., Inc. Altman-Hall Associates	33	■ L E L Div. of Varian Associates Snow & Depew Adv., Inc.	212
■ Bunker-Ramo Co.	196			Litton Industries, Inc., Electron Tube Div. West, Weir & Bartel, Inc.	124
■ Burr-Brown Research Corp. N. A. Winter Adv. Agcy.	172	■ Field Emission Corp. Ken Webber Advertising	228	Litton Industries, Inc., Poly-Scientific Div. West, Weir & Bartel, Inc.	210, 211
■ Burroughs Corp., Electronic Components Div. Conti Adv. Agcy., Inc.	88	■ Formica Corp., Div. American Cyanamid Co. Clinton E. Frank, Inc.	234, 235	Litton Industries, USECO Div. West, Weir & Bartel, Inc.	237
■ Bussmann Mfg. Div. of McGraw Edison Co. Henderson Adv. Co.	226, 227	Frenchtown/CFI, Inc. Mort Barish Associates, Inc.	77	Lockheed Missiles & Space Co. McCann Erickson, Inc.	168
Capitol Radio Engineering Institute Henry J. Kaufman & Associates	201	■ Garrett Corp., Airesearch Mfg. Div. J. Walter Thompson Co.	232		
Cimron, Div. of Lear Siegler, Inc. Phillips-Ramsey, Inc.	40	■ General Electric Co., Electronic Components Sales Operation Robert S. Cragin, Inc.	167	McCoy Electronics Co., Div. of Oak Electro/Netics Corp. Buchen Adv., Inc.	144
■ Clairex Corp. Michel-Cather, Inc.	258	■ General Electric Co., Miniature Lamp Div. Batten, Barton, Durstine & Osborn, Inc.	162	■ Machlett Laboratories, Div. of Raytheon Co. Fuller & Smith & Ross Inc.	11
■ Clare & Company, C.P. Reincke, Meyer & Finn Adv., Inc.	82	■ General Electric Co., Semiconductor Products Div. Robert S. Cragin, Inc.	136	■ Magnetics, Inc. Lando Adv. Agcy., Inc.	175
■ Cleveland Institute of Electronics Foote, Cone & Belding, Rapp & Collins Div.	61	■ General Instrument Corp., Semiconductor Products Div. Norman Allen Associates	62, 63	■ Mallory & Co., P.R., Mfg. Div. Aitkin-Kynett Co.	8
■ Colorado, State of, Industrial Development Div. Buchen Adv., Inc.	259	General Magnetics, Inc. George Homer Martin Assoc.	206	■ Marconi Instruments McCarthy, Scelba & DiBiasi Adv. Agcy., Inc.	80
■ Consolidated Electrodynamics Corp., Sub. of Bell & Howell Hixson & Jorgensen, Inc.	146	General Radio Co. Horton, Church & Goff, Inc.	17	■ Markel & Sons, L. Frank George Moll Adv., Inc.	221
■ Continental Connector Corp. Dunwoodie Associates	76	Gries Reproducer Co. Harold Marshall Advertising	236	■ Maryland Telecommunications, Inc. Raymond E. Finn Advertising	132
■ Control Data Corp., Analog-Digital Systems Div. Barnes-Champ Advertising	230	Grigsby Barton, Inc. Sprinkle and Green, Inc.	231	■ Matsuo Electric Co., Ltd. Daiyusha, Inc.	213
■ Control Switch, Div. of Control Co. of America Harry P. Bridge Co.	252	G.T.I. Corp. Meek and Thomas, Inc.	246	■ Mayberry Electronics Kinney Advertising, Inc.	60
■ Cook Electric Co., Automatic Controls Div. Grant/Jacoby, Inc.	36			■ Meguro Electronic Instrument General Adv. Agcy., Inc.	232
■ Corning Glass Works, Electronic Products Div. Rumrill Hoyt Co., Inc.	189	■ Hacker & Co., Inc., Wm. J. Raymond-Nicholas Advertising	238	■ Metal Removal Co., The Advertising Producers Associates	188
■ Cosmicar Optical Co., Ltd. Matsushita, Inc.	226	Hamilton Watch Co. Beaumont, Heller & Sperling, Inc.	164	Microdot, Inc. Gumpertz, Bentley & Dolan Advertising	15
■ Coto Coil Co., Inc. Williams Co., The Cramer Industries, Inc.	238	■ Haydon Switch & Instruments, Inc. Reynolds & Foster, Inc.	207	Microlab/FXR Frank Best & Co., Inc.	214
■ Curtis Instruments, Inc. Lescarbours Adv., Inc.	212	Heinemann Electric Co. Thomas R. Sundheim, Inc.	158	■ Milgray Electronics Bliss/Gruenwald, Inc.	115
■ Cyclo-Tronics, Inc. Bernard J. Hahn & Assoc.	52	■ Hewlett Packard, Harrison Div. Healy Adv. Agcy.	185	■ Minnesota Mining & Manufacturing Co., Chemical Div. Young & Rubicam, Inc.	123
		■ Hewlett Packard, Loveland Div. Tallant/Yates Adv., Inc.	1	■ Minnesota Mining & Manufacturing Co., Scotchpar Div. Klau-Van Pietersom-Dunlap, Inc.	86
		■ Hewlett Packard, F.L. Moseley Co. Div. Lennen & Newell, Inc.	9	■ Mitsubishi Electric Corp. Hakuhodo, Inc.	216
		■ Hewlett Packard, Mt. View Div. Lennen & Newell, Inc.	217		
		■ Hewlett Packard, Rockaway Div. Culver Adv., Inc.	2		

Advertising sales staff

Frank E. LeBeau [212] 971-6464
Advertising sales manager

Wallis Clark [212] 971-2127
Assistant to sales manager

Donald J. Austermann [212] 971-3139
Promotion Manager

Atlanta, Ga. 30309: Michael H. Miller, 1375 Peachtree St., N.E.
[404] 892-2868

Boston, Mass. 02116: William S. Hodgkinson
McGraw-Hill Building, Copley Square
[617] CO 2-1160

Chicago, Ill. 60611: Robert M. Denmead,
J. Bradley MacKimm, Ralph Hanning,
645 North Michigan Avenue,
[312] MO 4-5800

Cleveland, Ohio 44113: William J. Boyle, 55 Public Square, [216] SU 1-7000

Dallas, Texas 75201: Richard P. Poole, 1800 Republic National Bank Tower,
[214] RI 7-9721

Denver, Colo. 80202: Joseph C. Page, David M. Watson, Tower Bldg., 1700 Broadway,
[303] 255-5484

Detroit, Michigan 48226: Ralph Hanning
856 Penobscot Building
[313] 962-1793

Houston, Texas 77002: Kenneth George,
2270 Humble Bldg., [713] CA 4-8381

Los Angeles, Calif. 90017: Ian C. Hill,
John G. Zisch, 1125 W. 6th St.,
[213] HU 2-5450

Minneapolis, Minn. 55402: J. Bradley MacKimm, 1104 Northstar Center
[612] 332-7425

New York, N.Y. 10036
500 Fifth Avenue

Donald R. Furth [212] 971-3615
James R. Pierce [212] 971-3616
Jeffrey M. Preston [212] 971-3617

Philadelphia, Pa. 19103:

Warren H. Gardner,
6 Penn Center Plaza,
[215] LO 8-6161

Pittsburgh, Pa. 15222: Warren H. Gardner,
4 Gateway Center, [412] 391-1314

Portland, Ore. 97204: James T. Hauptli,
218 Mohawk Building, 222 S.W. Morrison
Street, Phone [503] 223-5118

Rochester, N.Y. 14534: William J. Boyle,
9 Greylock Ridge, Pittsford, N.Y.
[716] 586-5040

St. Louis, Mo. 63105: Robert M. Denmead
The Clayton Tower, 7751 Carondelet Ave.
[314] PA 5-7285

San Francisco, Calif. 94111:
James T. Hauptli, 255 California Street,
[415] DO 2-4600

London W1: Edwin S. Murphy Jr.,
34 Dover Street, Hyde Park 1451

Paris: Pierre Braude, European Director
Iena Commercial Bldg., 33 rue Galilee
Phone: 553-47-79

Milan: Robert Saidel
1 via Baracchini Phone: 86-90-656

Frankfurt/Main: Hans Haller
Elsa-Brandstroem Str. 2
Phone: 72 01 81

Geneva: Mike Zeynel
1, rue du Temple Phone: 31 95 60

Tokyo: Nobuyuki Sato, 1, Kotohiracho
Shiba, Minato-Ku [502] 0656

Osaka: Ryoji Kobayashi 163, Umegae-cho
Kita-ku [362] 8771

Business Department

Wallace C. Carmichael, Manager
[212] 971-3191

Stephen R. Weiss, Production Manager
[212] 971-2044

Thomas M. Egan,
Assistant Production Manager [212] 971-3140

Dorothy Carmesin, Contracts and Billings
[212] 971-2908

Frances Vallone, Reader Service Manager
[212] 971-2865

Circulation and Research

Milton Drake, Manager [212] 971-3485
Isaaca Siegel, Assistant Circulation Manager
[212] 971-6057

David Strassler, Assistant Research Manager
[212] 971-6058

Chloe D. Glover, Research Associate
[212] 971-6057

Electronics Buyers' Guide

George F. Werner, General Manager
[212] 971-2310

Ray Smyth, Eastern Regional Manager
[212] 971-6538

Regina Hera, Directory Manager
[212] 971-2544

Thomas M. Egan, Production Manager
[212] 971-3140

Dust Detective

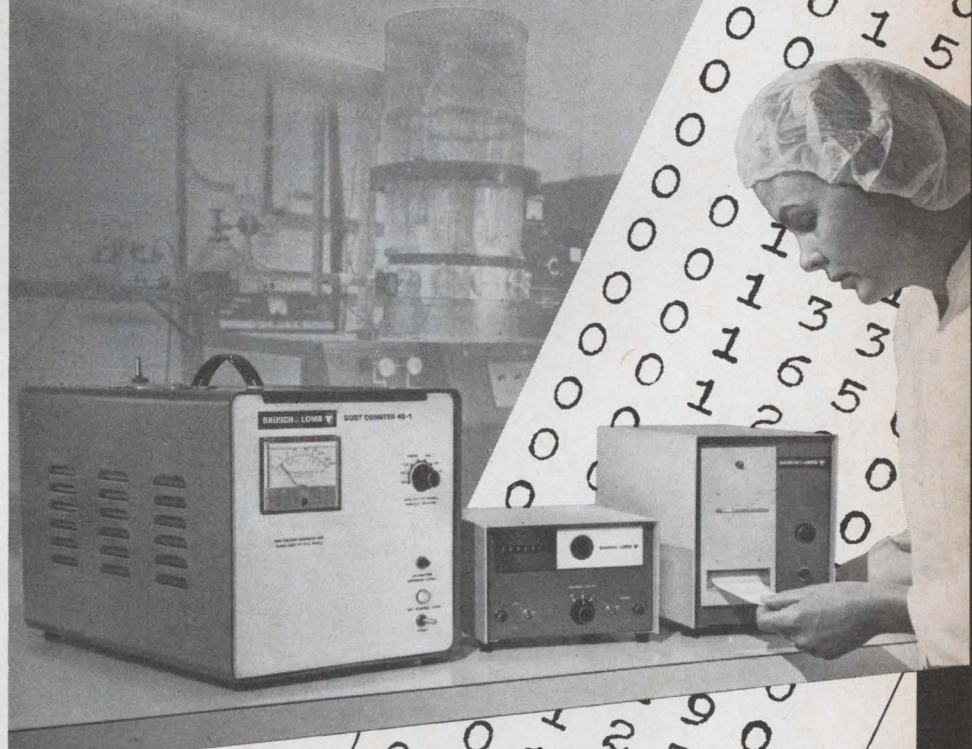

The new Bausch & Lomb Aerosol Dust Counting System keeps a watch on dust in your clean room. Airborne contamination is detected, counted and recorded . . . automatically, accurately, dependably. Particles of different refractive indexes are correctly sized the only accurate way . . . using near-forward light scattering. The efficient concentric optical system can classify particles of any shape and orientation by equivalent diameter. Any particle concentration—up to one million per cubic foot—is read and printed directly. Response is instantaneous. Counts all particles greater than the preset size. Seven presettable sizes can be selected—0.3, 0.5, 1.0, 2.0, 3.0, 5.0 and 10 microns. And, surprisingly, this superior system is priced far below any other commercial unit. Ask for our new Catalog 38-2190 . . . it has the full story. Write Bausch & Lomb, 99748 Bausch Street, Rochester, N. Y. 14602.

BAUSCH & LOMB

In Canada, Bausch & Lomb Optical Co., Ltd., 16 Grosvenor St., Toronto, Ontario.

Circle 263 on reader service card

Guard water purity...
 Produce chemicals...
 Run steam power plants...

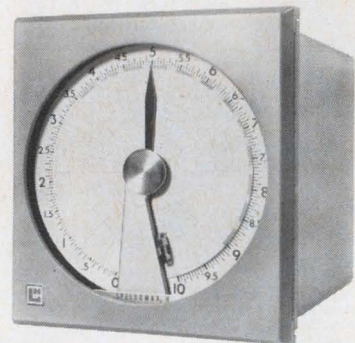
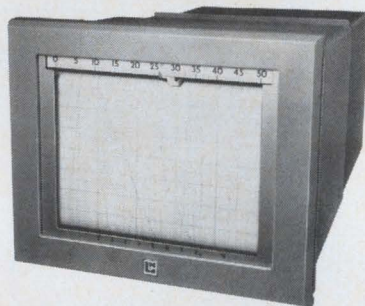
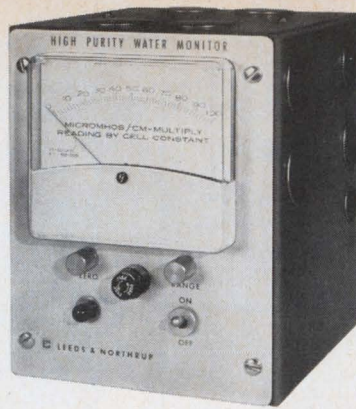

with help from
LEEDS & NORTHRUP

and Keystone
 Thermistors

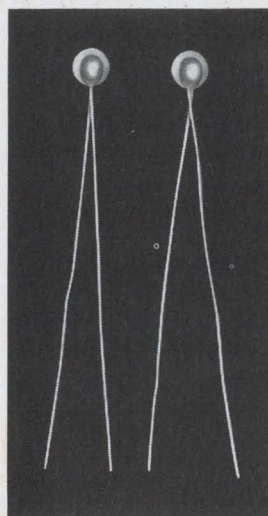

These tiny Keystone Thermistors are components of temperature compensators in a number of Leeds & Northrup Company electrolytic conductivity instruments—serving such applications as water purification, chemicals production, steam power generation and many other processes involving operation throughout a wide range of ambient temperatures. Let us consult with you on your thermistor requirements. KEYSTONE CARBON COMPANY, St. Marys, Pa. 15857

Keystone
 leads

in creative thermistor technology