

■ Performance Management, Part 1: System Monitoring

■ Real-Time UNIX™ Strives For Optimum Response

■ System Security, Part 2: VAX/VMS™ Internal Security

CONNECTIVITY

RSM

NOVEMBER ■ 1988

DEC

\$4.00 ■ VOL. 7, NO. 11

# Professional

*An Independent Magazine from Professional Press*

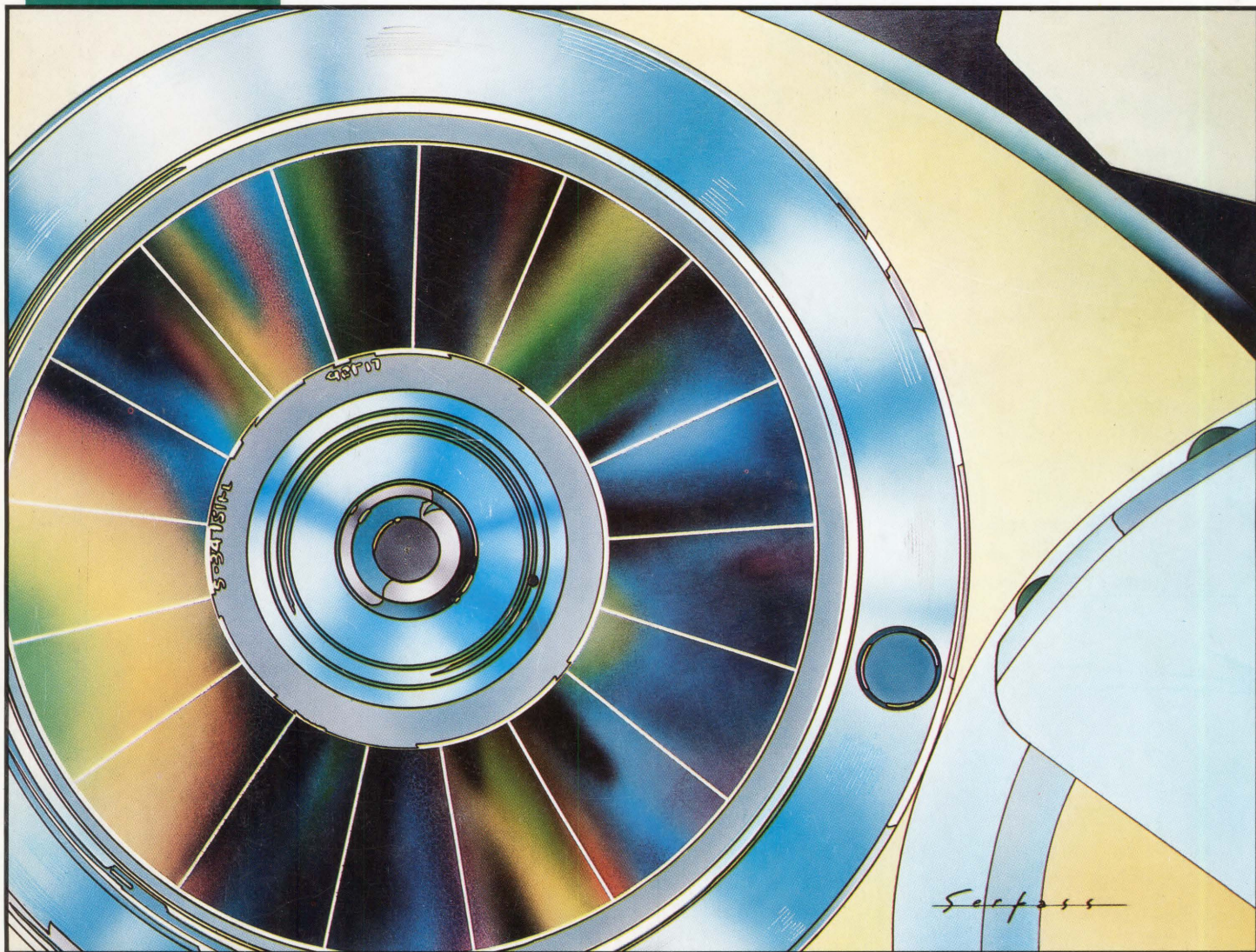

## Mass Storage



# End-Users Make SMARTSTAR A Hot Property At Cain & Scott.

Cain & Scott, a Seattle-based commercial real estate firm, is a true end-user environment. "We have no programmers on board and I'm not a software person," says Research Director Patty Dupre. "But SMARTSTAR® documentation is so easy and your service hotline people so helpful, I was able to create an excellent forms-based application. It gives each of our brokers and consultants instant access to the near-3000 apartment buildings in our database. Productivity for reporting and querying our database is at least 10 times higher with this software. Everyone is on-line and they

have no problems; they love using SMARTSTAR!"

*SMARTSTAR is today's leading SQL-based 4GL application development software designed exclusively for VAX/VMS. It is an ideal interface to Rdb and RMS, and it implements the Digital Standard Relational Interface. Features include functional menus, scrolling regions and windows.*

*The newest feature is SMARTDECISION™, a Lotus-compliant spreadsheet/graphics option. . . the decision-support component for a total application development environment.*

Other Signal Technology

products include PACS PLUS® resource accounting and chargeback software, which is installed at more VAX sites than all similar products combined, and ILS® signal processing software, with more than 2,000 installations in 40 countries. And no software developer is more committed to customer support and satisfaction than STI.

For details, a demonstration, or for information on any STI product, please call this toll-free number: 800-235-5787.



**Signal Technology Inc**

5951 Encina Road, Goleta, CA 93117  
(805) 683-3771 (800) 235-5787

FAX (805) 967-0871 TWX/Telex 910-334-3471

**digital**™ Cooperative  
Marketing  
Program

DPR 11/88

VAX, VMS, Rdb and RMS are trademarks of Digital Equipment Corporation.

Atlanta Boston Chicago Dallas Dayton Los Angeles New Jersey New York Philadelphia San Francisco Washington, D.C.

CIRCLE 275 ON READER CARD

# PowerHouse.



PowerHouse® is widely accepted as a powerful, fully-evolved 4GL that supports Digital's RMS® and Rdb/VMS® for greatly increased application development productivity.

## Introducing a More Powerful House.

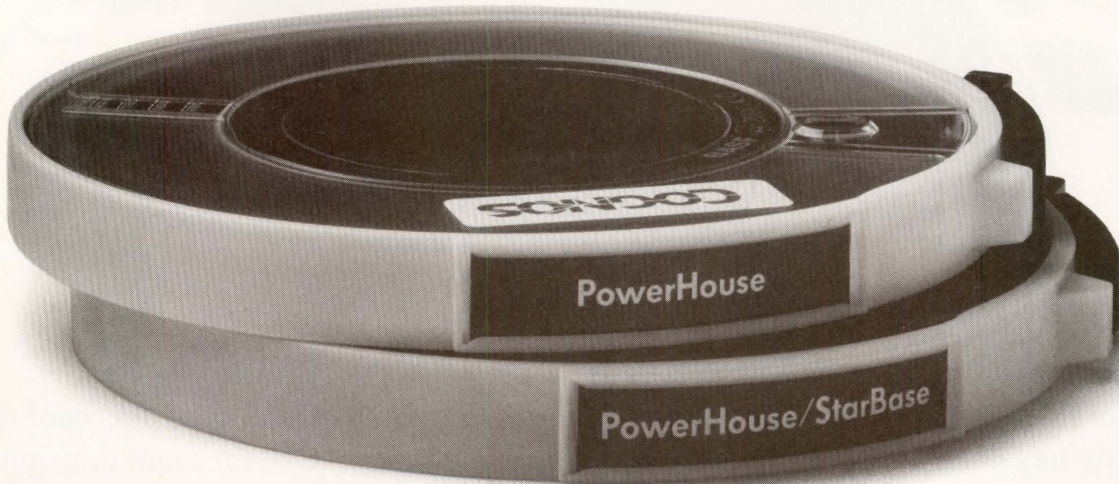

The PowerHouse family of software now offers a powerful new option. PowerHouse StarBase™ is a 2nd Generation relational database—a superior data management system complete with distributed processing, on-line transaction processing and hardware vendor integration. So you can access the data you need wherever it is.

To find out more about the new PowerHouse StarBase RDBMS\* and the integrated PowerHouse solution, return the coupon or call 1-800-426-4667. In Canada, call 1-800-267-2777; in Europe, +44-344-486668.

\*First release on Digital VAX® computers.

**CIRCLE 108 ON READER CARD**

**COGNOS**

*Ours Is The Language Of Integration.*

I believe integration is fundamental to increasing our productivity. Tell me more about the total PowerHouse solution.

- |  |   |
|--|---|
| <input type="checkbox"/> Send me the PowerHouse Solutions Brochure.                    | <input type="checkbox"/> Have a sales representative contact me.              |
| <input type="checkbox"/> Send me information on PowerHouse StarBase, the Cognos RDBMS. | <input type="checkbox"/> Send me information on the PowerHouse Discovery Kit. |

NAME \_\_\_\_\_ CITY \_\_\_\_\_  
 TITLE \_\_\_\_\_ STATE/PROV. \_\_\_\_\_  
 COMPANY \_\_\_\_\_ ZIP/POSTAL CODE \_\_\_\_\_  
 ADDRESS \_\_\_\_\_ TELEPHONE \_\_\_\_\_

HARDWARE ENVIRONMENT \_\_\_\_\_  
 FILE SYSTEM(S) \_\_\_\_\_  
 DATABASE SYSTEM(S) \_\_\_\_\_  
 DEVELOPMENT LANGUAGE(S) \_\_\_\_\_

Send to:

Cognos Corporation, 2 Corporate Place, I-95, Peabody, MA 01960.  
 In Canada; Cognos Incorporated, 3755 Riverside Drive, P.O. Box 9707,  
 Ottawa, Ont. Canada, K1G 3Z4.  
 In Europe; Cognos Limited, Westerly Point, Market Street, Bracknell,  
 Berkshire, RG12-1QB, U.K.

Cognos and PowerHouse are registered trademarks of Cognos Incorporated. VAX, RMS and Rdb/VMS are registered trademarks of Digital Equipment Corporation. PowerHouse StarBase is a trademark of Cognos Incorporated.

# Conquer the Connectivity Challenge



## The Challenge

If you're of the opinion that networking lots of PCs, printers, modems and host computers together has to be complicated and expensive, we'd like to change that opinion.

## Presenting SwitchLAN

SwitchLAN is a simple low-cost network. It provides "hot-key" File Transfer, Terminal Emulation and Printer Sharing at a cost of about \$150 per PC.

## Easy Does It

Installing SwitchLAN is a snap. It uses telephone type twisted-pair wiring and the serial COM port already in your PCs. You don't need to buy expensive network servers, install network boards in every PC, or struggle with coax cable.

Using SwitchLAN is as easy as installing it. Extensive help and pull-down menus are provided so people don't have to be network gurus to use it.

## Challenge Us

Don't take our word for it. Call for more information or a free demo disk. With SwitchLAN you can turn a Connectivity Challenge into Child's Play.

**Call 1-800-328-2729**

In Florida: 305-255-3500

Equinox Systems Inc.

14260 S.W. 119 Avenue

Miami, FL. 33186

# EQUINOX

## Simply Better Networks

CIRCLE 122 ON READER CARD

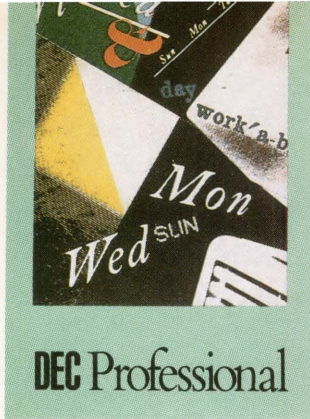

# C CONTENTS

NOVEMBER 1988

VOL. 7, NO. 11

---

## MASS STORAGE

---

**38 TRENDS IN DISK STORAGE**  
*by David W. Bynon and Philip A. Naecker*

Analyzing the upheaval in the disk storage market.

**48 OPTICAL STORAGE COMES OF AGE**  
*by Ron Levine*

Making strides in storage technology.

---

## ARTICLES

---

**62 SYSTEM MANAGEMENT: PERFORMANCE MANAGEMENT**  
*by Terry C. Shannon*

Part 1: Tips on monitoring system performance.

**72 UNIX: REAL-TIME UNIX**  
*by Evan Birkhead*

Striving for optimum response time.

**82 SECURITY: SYSTEM SECURITY, PART 2**  
*by David W. Bynon*

When the system's locked up, it's out of enemy hands.

**90 CONNECTIVITY: ONE DOING THE WORK OF MANY**  
*by Philip A. Naecker*

Remote System Manager provides a mechanism to perform management duties on distributed VAX systems.

### ON THE COVER:

This month's cover illustration is the work of Pennsylvania-based airbrush artist Jim Serfass.

This magazine is not sponsored or approved by Digital Equipment Corporation.

"DEC" and "VAX" are trademarks of Digital Equipment Corporation. Digital Equipment Corporation is the owner of the trademark "DEC" and is the source of all "DEC" products. For other Digital trademarks, see page 6.

*Continued on page 4.*

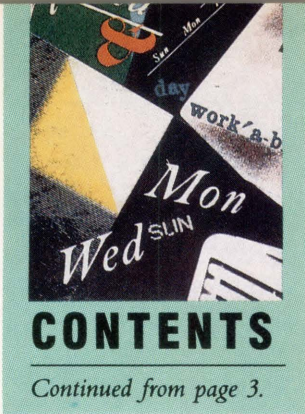

## DEPARTMENTS & COLUMNS

### Publisher

by Carl B. Marbach  
 Curiouser And Curiouser .....10

### Editorial

by Dave Mallery  
 From Bad Code To Birthdays.....14

### DECWORLD Report

by Evan Birkhead  
 Networking The Enterprise.....16

### Field Service

by Ron Levine  
 The Mysterious Problems  
 Of Line Power .....112

### Let's C Now

by Rex Jaeschke  
 Reading And Writing  
 Declarations, Part 2.....116

### DCL Dialogue

by Kevin G. Barkes  
 Code That Goes Bump In The Night.....122

### From The Lab

Cluster Chronicles: DECNET™  
 by Dave Mallery.....125  
 Emulex Performance 4000  
 by David W. Bynon.....128

### From The Lab (continued)

Microsystems Engineering's MASS-11  
 by David B. Miller.....130  
 Esprit Systems' Opus 3n1  
 by David B. Miller.....140  
 Software Techniques' ARCHIVE 2000  
 by David B. Miller.....146  
 Innovative Computer Systems' FCX  
 by David B. Miller.....154

### The Mac Connection

by James K. Anders  
 Remote AppleTalk Communications.....158

### Back End

by John C. Dvorak  
 The Electronic Rat Race: Circa 1973.....192

**ARISTALK**.....18

**Product Watch**.....22

**Products**.....166

**Product Showcase**.....186

**Used Equipment**.....187

**Classified**.....188

**Advertisers Index**.....190

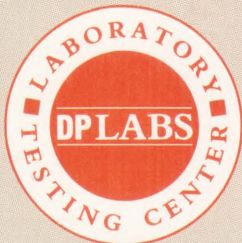

The lab seal indicates that the product reviewed has been tested by one of our experts in our Laboratory and Testing Center.



The ARIS symbol on an article indicates that the program segments are available electronically on our Automated Reader Information Service. Dial (215) 542-9458.

We will consider for publication all submitted manuscripts and photographs, and welcome your articles, photographs and suggestions. We cannot be responsible for loss or damage. All materials presented are believed accurate, but we cannot assume responsibility for their accuracy or application. DEC PROFESSIONAL Magazine ISSN 0744-9216 is published monthly by Professional Press, Inc., 921 Bethlehem Pike, Spring House, PA 19477. Printing and binding by R. R. Donnelley & Sons Company. Subscriptions are complimentary for qualified U.S. and Canadian sites. Single copy price, including postage, \$4. One year subscription rate \$30 in the U.S. and Canada; and \$60 foreign. All orders must be prepaid. Second Class postage paid at North Wales, PA, and additional mailing offices. POSTMASTER: Send all correspondence and address changes to: DEC PROFESSIONAL, P.O. Box 503, Spring House, PA 19477-0503. COPYRIGHT © 1988 by Professional Press, Inc. All rights reserved. No part of this publication may be reproduced in any form without written permission from the publisher.





# Emulate The Best With The Brightest.

There's no denying the availability of some outstanding dedicated terminals to access Digital®, Hewlett-Packard, and Data General® host systems. Which makes the task of precisely emulating the performance of those dedicated terminals on an IBM® PC or compatible a rather significant challenge.

Based on the feedback we've received from SmarTerm® users, our family of terminal emulation software has met the challenge, passed every test, and surpassed, in the opinion of a host of enthusiastic users, the performance of the host system terminals being emulated.

The reasons why we shine are fundamental.

Every SmarTerm emulation is precise. So precise, in fact, that a dedicated terminal's SmarTerm counterpart fully emulates not only advanced performance features but also unique terminal quirks and bugs.

Every SmarTerm emulation is easy to use. It's one thing to make software do what hardware does. It's another challenge to minimize software's human wear. The people designing our products understand the nature of the people using them.

Every SmarTerm emulation is easy to learn. These days, training costs are a hot topic. Software intended to boost overall system efficiency must recognize the value of learning speed. We have.

It's also easy to learn more about how SmarTerm emulations can help you shine. Your software dealer can supply all the details. Or you can contact us at (608) 273-6000 to request complete specifications and a demonstration disk of the SmarTerm emulation that precisely matches your requirements.

**persoft®**

CIRCLE 175 ON READER CARD

Tech-Tips No.

5

# DECconnect Solutions

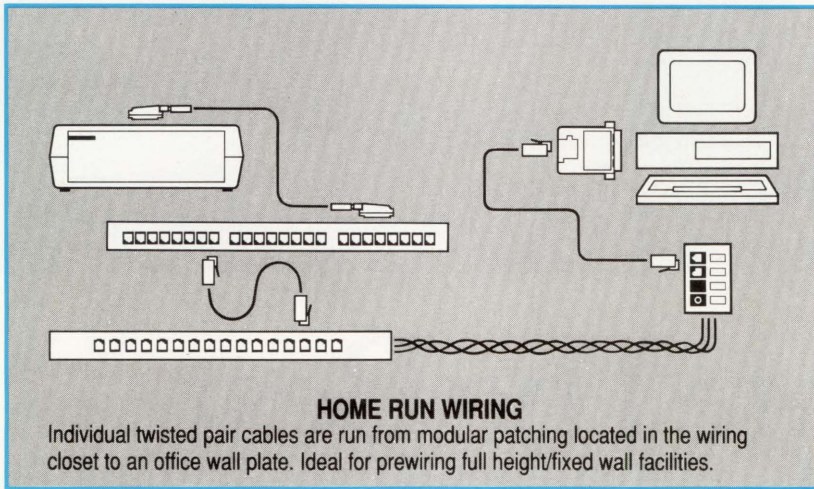

MMJ is the DEC standard for data polarization. The unique off-set style prevents users from plugging data equipment into a voice outlet. All MOD-TAP's products are available with the MMJ polarization.

MOD-TAP offers innovative solutions for all your communications wiring needs.

Call today for your free DECconnect Solutions Application Note and our latest Applications Catalog.

The MOD-TAP Communications Wiring System is a modular solution for voice and data building wiring. MOD-TAP System is not biased towards any particular manufacturer's equipment or Local Area Networking design.

## MOD-TAP System

285 Ayer Road  
P.O. Box 706  
Harvard, MA 01451-0706

**(508) 772-5630**

MOD-TAP System UK Ltd.  
City Commerce Centre  
Marsh Lane  
Southampton Hants, S01 1EX  
England 44 703 212120

Trademarks are the property of their respective owners.

CIRCLE 185 ON READER CARD

# DEC Professional

Publisher: Carl B. Marbach  
Editorial Director: R. D. Mallery

### Editorial

**MANAGING EDITOR** Lou Pilla  
**ASSISTANT EDITORS** Karen Detwiler, Pamela F. Fullerton  
**SENIOR TECHNICAL EDITOR** Al Cini  
**EAST COAST EDITOR** Evan Birkhead  
**WEST COAST EDITOR** Philip A. Naecker  
**TECHNICAL EDITOR** David B. Miller  
**FIELD SERVICE EDITOR** Ron Levine  
**BACK END EDITOR** John C. Dvorak  
**C EDITOR** Rex Jaeschke  
**DCL EDITOR** Kevin G. Barks  
**MICROVAX EDITOR** David W. Bynon  
**NETWORKING EDITOR** Bill Hancock  
**UNIX EDITOR** Lori A. Snyder  
**COPY EDITOR** Eric Schoeniger  
**EDITORIAL ASSISTANT** Anne Schrauger  
**CONTRIBUTORS** James K. Anders, Terry C. Shannon

### Design & Production

**DESIGN/PRODUCTION MANAGER** Ruth Ann Leiby  
**DESIGN/PRODUCTION ASST.** Pat Messina  
**ADVERTISING BOOKING COORD.** Lori Goodson  
**ADVERTISING PROD. COORD.** Suzanne Garr  
**PROMOTIONS MANAGER** Timothy M. Kraft  
**GRAPHIC DESIGNERS** Richard Kortz, Sue Ann Rainey  
**PRODUCTION ARTIST** Patricia P. Kraekel  
**TYPESETTING** MaryEllen Coccimiglio

### Circulation

**CIRCULATION MANAGER** Betsy Ellis  
**FULFILLMENT MANAGER** Margie F. Pitrone  
**CIRCULATION DBA** Rebecca Schaeffer

### PROFESSIONAL PRESS, INC.

**PRESIDENT** Carl B. Marbach  
**VICE PRESIDENT** R. D. Mallery  
**VICE PRESIDENT** Peg Leiby  
**EXECUTIVE EDITOR** Linda DiBiasio  
**EXECUTIVE DESIGN DIRECTOR** Leslie A. Caruso  
**DIRECTOR OF MARKETING** Mary Wardlaw  
**CONTROLLER** Andrea Beneke  
**MIS MANAGER** John F. McGlinchey  
**ASSISTANT TO THE PRESIDENT** Jan Krusen

For information on how to contact your sales representative, see page 190. Editorial, Advertising Sales, and Executive Offices at 921 Bethlehem Pike, Spring House, PA 19477. (215) 542-7008. TWX 910 333 9522. FAX (215) 628-2845. Easylink 62805174. ARIS (Automated Reader Information Service) (215) 542-9458. Additional Editorial Offices: East Coast Office at 238 Bedford St., Suite 3, Lexington, MA 02173. (617) 861-1994. West Coast Office at 1010 E. Union St., Suite 101, Pasadena, CA 91106. (818) 577-5970. Northern California and Northwest Office at 903 Sneath Lane, Suite 220, San Bruno, CA 94066. (415) 873-3368. Southern Texas Office at 11782 Jollyville Rd., Suite 203, Austin, TX 78759. (512) 258-4800.

The following are trademarks of Digital Equipment Corporation:

A-to-Z  
ALL-IN-1  
CDD  
DATATRIEVE  
DCCMP  
DEC  
DECcalc  
DECconnect  
DECgraph  
DECmail  
DECmate

DECnet  
DECsystem-10  
DECSYSTEM-20  
DECtest  
DECUS  
DELNI  
DIBOL  
DNA  
Eve  
FMS  
GIGI

IAS  
IVIS  
LAN Bridge  
LA50  
LA100  
LQP02  
LSI-11  
MASSBUS  
MicroPDP-11  
MicroPower/Pascal  
MicroVAX

PDP  
PDT  
P/OS  
Q-bus  
Rainbow  
RALLY  
Rdb/VMS  
RSTS/E  
RSX  
RF-11  
TEAMDATA  
TOPS  
ULTRIX  
UNIBUS

VAX  
VAXBI  
VAXcluster  
VAX DIBOL  
VAXELN  
VAXFMS  
VAXIab  
VAX LISP  
VAX SCAN  
VAXstation  
VMS  
VT  
Work Processor  
WPS

UNIX is a trademark of Bell Laboratories.  
MS-DOS is a trademark of Microsoft.  
CP/M is a trademark of Digital Research, Inc.  
Macintosh is a trademark of Apple Computer, Inc.  
X Window System is a trademark of MIT.



# CLEARPOINT

The Leader in DEC-Compatible Memory—  
Delivering High Performance for the Complete MicroVAX Line



## The DCME-M30 Meets the Challenge – Highest Density Memory, First to Market

Take your MicroVAX 3000 to the max! Clearpoint packs a full 32 megabytes of memory onto the DCME-M30 boards using state-of-the-art one megabit DRAMs. Also available in 16 or 8 MB densities, Clearpoint offers the best pricing for the best package.

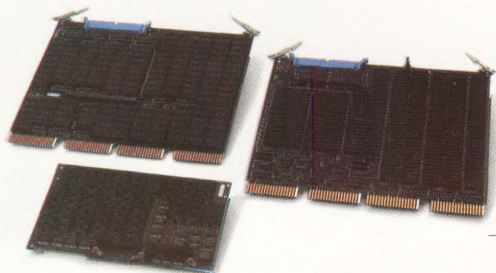

## The DCME-M20 Releases the Full Power of Your MicroVAX 2000

Order your DCME-M20 today and get the equivalent of MicroVAX II performance at half the cost. The DCME-M20 is available in 8 and 16 MB boards to upgrade the MicroVAX 2000 to either 10 MB—or to the full 16 MB maximum of the MicroVAX microprocessor.



CIRCLE 105 ON READER CARD

**Clearpoint Research Corporation**  
99 South Street, Hopkinton, MA 01748  
1-800-CLEARPT (253-2778)  
(508) 435-2000

## The DCME-M2 Offers the Full System Capacity of the MicroVAX II on One Board

The 16 MB DCME-M2 is designed to run cooler and draw less power for maximum board life and reliability. Also available in 8 and 4 MB boards.

Call or write for specific product info, the '88-'89 Catalog and our Memory Pointers newsletter



Clearpoint is a registered trademark of Clearpoint Research Corporation. DEC, MicroVAX 3000, MicroVAX 2000, MicroVAX II are trademarks of Digital Equipment Corporation.

# LOOK INTO THE FUTURE



VISTA TCP/IP NETWORK INTERFACE CARD

VISTA X.25

VISTA 32 PORT RS423

VISTA 32 PORT RS423

VISTA 2400 BAUD MODEMS

VISTA 8 PORT RS232

VISTA LAT COMPATIBLE NETWORK INTERFACE CARD

# ...DISCOVER VISTA.™



## THE NEW LAT COMPATIBLE TERMINAL SERVER THAT DEFINES COMMUNICATIONS INTO THE 21<sup>ST</sup> CENTURY

Dramatic change is the only standard in the computer industry. New strategies and techniques are constantly reshaping the marketplace. And those companies that keep pace with change gain the competitive edge. Introducing the VISTA Series—a new fully LAT compatible terminal server with superior capabilities for today and remarkable options for tomorrow.

### UNMATCHED EXPANSION CAPABILITY

VISTA is a revolutionary communications server with unparalleled connectivity options. Imagine a 100% LAT compatible terminal server, capable of supporting up to 128 users in the space of a single

DECSERVER-200. It would take sixteen DECSERVER-200s to do the job of one VISTA Server. And VISTA offers a variety of connectivity interfaces: RS232, RS423, On-Board Modems, X.25 and more.

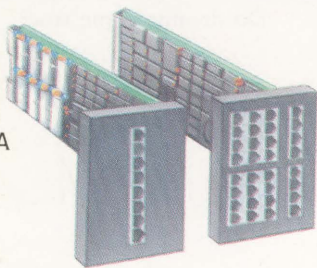

Finally a platform that brings together all your communications needs.

### NETWORKING FOR TODAY AND TOMORROW

What makes the VISTA Server so unique is that it is completely network independent. Begin now by using VISTA's fully LAT compatible Network Interface Card (NIC), cable ready for standard Ethernet, thin-wire Ethernet and Synoptics unshielded twisted pair connections. And when it comes time to change strategies, upgrade the NIC card and implement an entirely new hardware or software approach, such as TCP/IP or the emerging OSI terminal service protocol.



### A SINGLE PLATFORM WITH MANY OPTIONS

VISTA allows you to configure your own custom tailored communications platform. Choose the NIC card you need today, together with up to four expansion cards. Imagine configuring a LAT compatible terminal server with 64 ports, 8 2400 Baud dial in/out modems and full X.25 support.

With VISTA, your options are endless.

### THE BEST FOR LESS

The VISTA Communications platform represents so much more than a terminal server. But at the same time, VISTA's per port costs are among the lowest in the industry. Whether its power, performance or price, current needs or future plans, there's simply no strategy available that competes with VISTA.

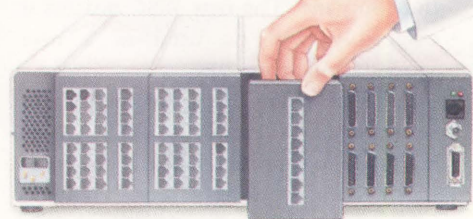

### IT'S TIME TO ACT!

For more information, simply call our toll free number 1-800-342-5377. We'll send further details that highlight the capabilities of this remarkable product.

VISTA. It's the communications server for the 21st century.



From **DATABILITY**™ The Leader in LAT compatibility.

**1-800-DIAL-DSS**

(in NY: 212-807-7800)

Datability Systems, 322 Eighth Ave. New York, NY 10001

All product names are registered trademarks of their respective manufacturers.

CIRCLE 216 ON READER CARD

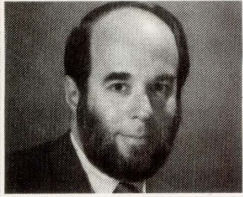

## PUBLISHER

**Carl B. Marbach**

# Curiouser And Curiouser

VAX/VMS partnership in trouble?

DEC recently announced that William J. Heffner, vice president, Systems Software, who led Digital's VAX/VMS effort, now will be responsible for the development of Open Software Foundation (OSF)/ULTRIX systems. Word from the Maynard Giant is that spending on ULTRIX is outpacing VMS. And DEC's support for OSF, which is sponsoring a new, independent UNIX-like operating system, shows a commitment to UNIX/ULTRIX.

Alone, these three major happenings might not mean much. But DEC has embraced both the Mac and the PC as integral parts of its network. NFS, a UNIX-standard networking scheme, is being incorporated into the DEC networking suite. DECWINDOWS will conform to standards, allowing new levels of interoperability among processors.

Finally, DEC has purchased RISC technology from Mips Inc. of Sunnyvale, California, and bought a piece of the company. The new RISC processor ostensibly will be used in a new workstation from DEC.

These things have happened for several reasons. First, the VAXSTATION has failed to capture the hearts and souls of the workstation market. That has been done by Sun, Apollo, Apple, Hewlett-Packard and others who offer better performance and a lot of software.

We've said before that the best thing about the VAXSTATION is that it's a VAX, and the worst thing about the VAXSTATION is that it's a VAX. Having one gives you a VMS engine at a great price, but there isn't the kind of work-

station software to make it productive. Even if there were, the one-to-three-mips VAXSTATION pales compared with the competition, which offers up to 25 times more power. A one-to-three-mips workstation isn't going anywhere. VMS doesn't look like it's going to be very good for workstations, the rest of which run UNIX.

The DEC strategy, long espoused by the "Digital has it now" banner, makes me wonder if it should be changed to, "Digital used to have it now, but now we'll have it later." The strategy is changing. No longer is there going to be a network of VAX-only processors. The network now will include VAX and UNIX machines, as well as Macs, PCs and the new RISC processor from Mips.

DECWINDOWS will tie these together with a windowing and graphics strategy, allowing a single-client windows terminal to be served by multiple processors. The big VAX/little VAX network isn't enough, and if DEC includes UNIX, RISC machines and others in its strategy, what makes DEC different from anyone else? Does everybody have it now?

Our eight-VAX cluster is so hard to tune and understand that it requires a full-time expert. When we add other processors, the complexity of DECWINDOWS and interoperability, it rapidly will get out of control. Remember when we simultaneously had RSTS, RSX and RT-11 in the PDP-11 world? Wasn't VMS supposed to solve the problem of multiple operating systems?

DEC had an elegant, simple solution to networked computing: large computers, small computers and workstation computers, all networked and running the same operating system. Adding RISC, ULTRIX, UNIX and other processors to this networked solution

removes its elegance and simplicity. DEC has been forced down this path by the market and its inability, again, to produce a competitive desktop product. Because of lack of power and software, the VAX workstation simply can't compete.

Given the proper VAX workstation, with 20 to 40 mips and a lot of software, DEC never would embrace the things it's endorsing now. Instead of leading, DEC is following the pack. DEC has been at its best when it has innovated and led, as it did with minicomputers and networking. DEC has been at its worst when it has followed the market, as with the Rainbow, VAXMATE and now the VAXSTATION.

Maybe the new RISC technology from Mips will allow DEC to build an integral part of a VAXCLUSTER without muddying the waters. I dream of a RISC VAX that runs VMS and fits into my network as easily as other VAXs do. This new RISC VAX runs workstation software at super speeds, costs very little and is an innovative product doing things only DEC could have thought of. It's a power and a leader in the workstation market, yet it fits with its bigger and smaller brothers and sisters. In this dream, the ads still say, "Digital has it now."

Do dreams come true?



## The Fastest, Most Reliable Alternative to the TA79

Why settle for less? Now there's a HSC compatible tape subsystem that runs rings around the DEC TA79—day after day after day. It's the new MA-200 start/stop tape subsystem from Micro Technology.

When it comes to backing up high-capacity disk storage in a VAXcluster, the MA-200 can't be beat. In fact, the MA-200 is 38% faster than the DEC TA79. The MA-200 packs in 6250 bits per inch and records 200 inches per second. When all is said and done, you end up with a data transfer rate of 1.25 MB/sec. And that's a real improvement.

But perhaps the biggest improvement the MA-200 has to offer is its uncompromising performance. Its reliability. After all, what good is speed without reliability? And that's exactly the point.

CIRCLE 302 ON READER CARD

So check the MTBF rates and see for yourself where the latest improvements have been. Then treat your VAXcluster to the MA-200. The only start/stop tape subsystem that knows how to store your data, quickly, carefully and reliably.

For more information on the fastest, most reliable alternative to the TA79 tape subsystem, call Micro Technology, 800-999-9MTI.

Micro Technology, Inc. designs, manufactures, sells, and supports enhancement products for the VAX end user.



### Micro Technology

1620 Miraloma Avenue • Placentia, CA 92670

800-999-9MTI

# Cut Through Applications Backlog Fast With INGRES Relational Database.



© 1988 Relational Technology Inc. Printed in U.S.A.



To design, build, and maintain effective business applications, you need the right tools and development options. INGRES combines Tools, Power, and Access to help you cut through development backlogs. In addition, hundreds of ready-to-use INGRES-based business solutions are available.

**Tools** INGRES offers an unmatched integrated application development environment providing CASE, 4GL, SQL and visual programming methods. These facilitate complex applications prototyping, deployment, and provides independent end-user query and reporting capabilities. Applications are instantly portable across multiple hardware platforms.

**Power** INGRES high performance SQL database engine provides OLTP power to support production applications in single or multi-CPU and distributed environments. A unique AI-based query optimizer maximizes processing efficiency.

**Access** INGRES integrates existing data into your applications through flexible access tools. Gateway access to existing data. Network access to tie your systems together. The most advanced distributed technology to integrate islands of information. Access to your data wherever it resides.

Find out how 12,000 installations have cut through their applications backlog fast with INGRES Development Tools. Attend a free INGRES seminar.

**Call 1-800-4-INGRES**

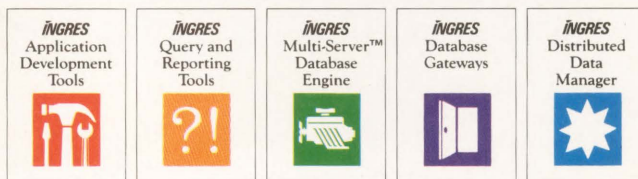

**INGRES**  
RELATIONAL TECHNOLOGY

Corporate Headquarters: 1080 Marina Village Parkway,  
Alameda, CA 94501, (415) 769-1400  
International Headquarters: Anchor House, 15-19 Britten Street,  
London SW3 3TY, UK, +44 1 351 7722

CIRCLE 155 ON READER CARD

DP

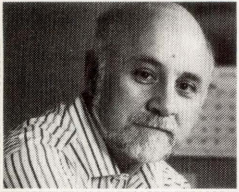

## EDITORIAL

Dave Mallery

# From Bad Code To Birthdays

---

My blood boils when I think of the nut who uploaded the Trojan horse procedure to Kevin G. Barkes' PC-based BBS (see DCL Dialogue, page 122). That Trojan Horse was meant for the Professional Press computer.

My first reaction was that we'd have to stop all ARIS downloads and stop publishing any code. The liability generated by propagating killer code could ruin us.

But reason prevailed. After all, we can identify the source of all code we publish. We only provide code we buy for upload, and we never accept code for upload from any other source. We never accept executables, only source.

Therefore, be warned: Never execute anything you find in any area of ARIS other than the download. We can't remove all the code that appears in the various SIGs, as much of it is very useful and offers editorial suggestions. Treat it with extreme care. Sad but true, the nuts are out there, and they're after you. We're publishing this because it's our duty to inform you of a real danger.

## DEQNA?

Word has it that DEQNA owners will have to pay about \$2,500 for a DELQA or the like after VMS version 5.1 becomes available. This is because there's a major and unfixable throughput problem with DEQNA after it gets involved with a significant number of nodes. I've never heard of support being withdrawn for a product so early in its life.

## Anniversary

This issue marks our ninth anniversary in publishing. In 1979, we distributed the first edition of *RSTS PROFESSIONAL* at DECUS in San Diego, much to the chagrin of several notables. We operated on the premise that if you supply something that everyone wants and needs, they'll buy it.

Buy it you did. Today, we have 110 employees in offices all over the U.S. producing four publications that cover the midrange computing spectrum. *HP PROFESSIONAL* now is established firmly in its turf, and our newest publication, *MIDRANGE Systems*, is a biweekly tabloid for the IBM S/3x and AS/400 market.

It's been a blast! On to 10 years!



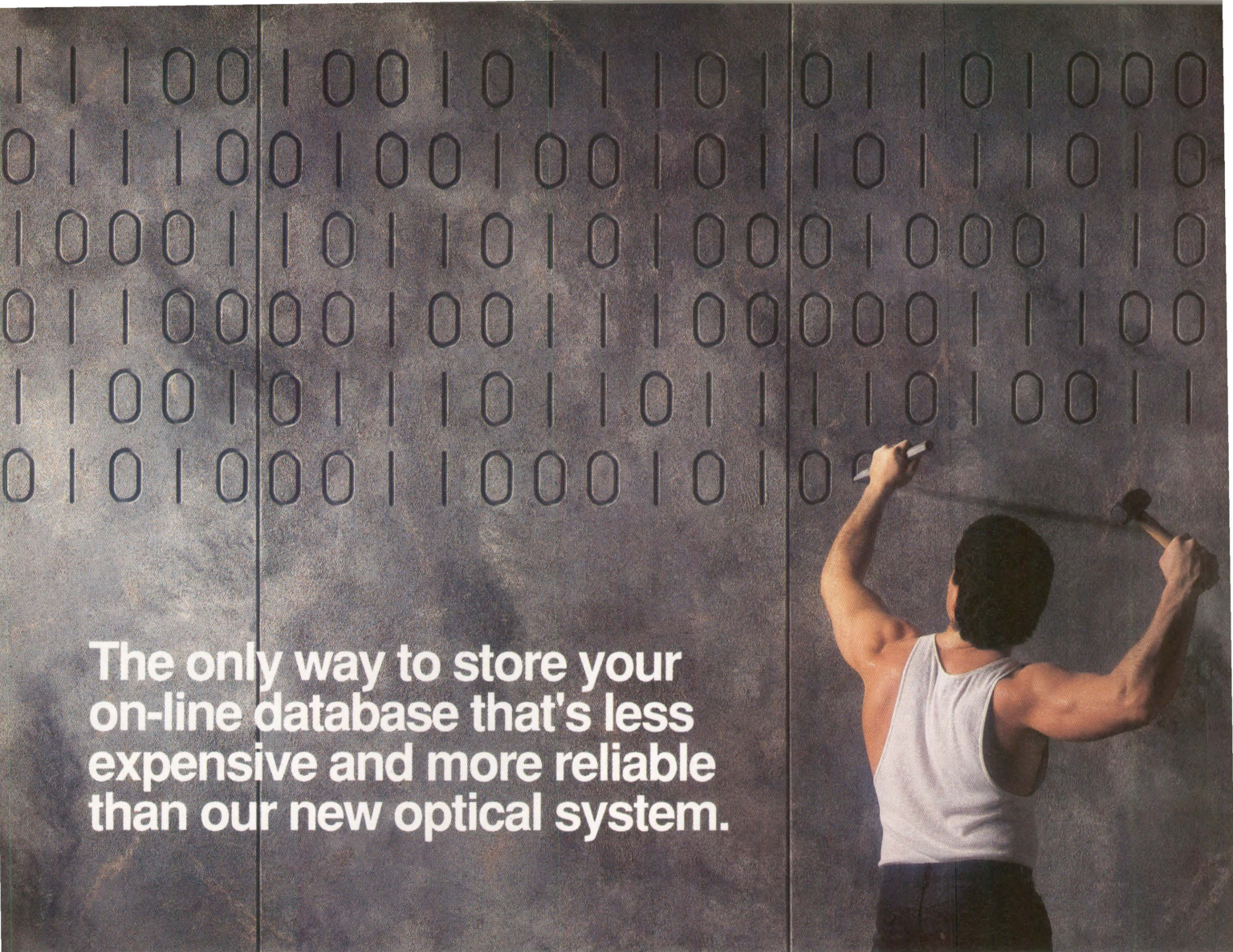

**The only way to store your on-line database that's less expensive and more reliable than our new optical system.**



If you've been banging your head against the wall trying to find a low-cost, reliable way to store your large on-line database, EMC has the solution.

Because now, there's Archeion Database System. A rock-solid alternative to expensive magnetic disk storage.

This system, the newest addition to EMC's Archeion family of optical storage products, gives you the benefits of optical technology with the flexibility of a magnetic disk.

Benefits like unlimited user accessibility. Direct access capabilities. Unmatched durability, performance, and capacity.

Archeion Database System is ideal for both your relational database and archiving applications. It works in conjunction with any DBMS package you're currently using, so when you choose Archeion, you're not caught between a rock and a hard place when it comes to software compatibility.

Archeion will support up to 56 optical drives. Each drive provides one gigabyte on-line storage. What's more, Archeion has removable media. One drive can service many gigabytes of data.

Because it utilizes WORM technology, Archeion's media has a useful life of 30 years or more. And it's virtually indestructible. Data is actually burned into the disk so it's as safe as if carved in stone. This means data integrity like you've never known.

All this, for a fraction of the cost of magnetic disk storage.

The end result is simple: if you want a low-cost, reliable way to store your valuable on-line database, buy EMC's Archeion Database System.

Or get your chisel ready.

For more information on EMC's Archeion family of optical subsystems, call

**1-800-222-EMC2**

(in Massachusetts, 617-435-1000).

**EMC<sup>2</sup>**

The System Enhancement Company.  
EMC Corporation, 171 South Street,  
Hopkinton, MA 01748-9103

VAX is registered trademark of Digital Equipment Corporation. Archeion is a registered trademark of EMC Corporation.

CIRCLE 121 ON READER CARD

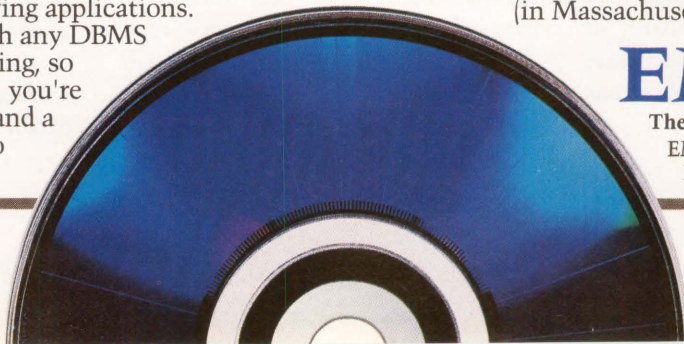

## DECWORLD REPORT

Evan Birkhead

# Networking The Enterprise

Digital announced few new products at DECWORLD

'88 in Cannes, France. It did, however, spell out its strategic direction for the 1990s. Not surprisingly, the direction emphasizes DEC's strength in networking solutions and reflects its desire to be perceived as a major systems integrator.

Two corporate programs debuted under the heading "Solutions For The Enterprise." These are the Enterprise Planning and Design Services, which formalizes DEC's entry into the support systems business, and the Network Enterprise Management Program, which focuses on managing the network architecture.

By addressing problems of the corporate enterprise, rather than the computer department alone, DEC is trying to change its image to that of an all-purpose technology consultant.

DEC often has played the role of *Fortune* 500 consultant, gaining expertise in corporate strategy and planning. With these two new programs, DEC ties the loose ends of various consulting abilities and accumulated relationships into a neat marketing package.

The Enterprise Services includes the following four elements:

1. Enterprise Planning and Design Services, in which DEC works in partnership with its clients to map corporate strategies and apply technical plans to these strategies.
2. Integrated Support Services, in which DEC becomes a single point of contact for all problems on a network, including multivendor problems.
3. Digital Program Management, in which DEC gets involved in corporate strategy and subsequent applications development.



*More than 18,000 attendees gathered at the Palais des Congrès in Cannes, France, September 12-23, for DECWORLD '88. The focus was "Integrating The Enterprise," but the real news came when DEC President Kenneth H. Olsen announced DEC's commitment to the development of a RISC-based machine. This is a notable departure for DEC, and the company plans to develop a robust system for UNIX that includes some VMS features. As part of this commitment, DEC purchased five percent of UNIX-based processor and workstation vendor Mips Computer Systems Inc.*

4. Services Alliances, in which DEC works in coordination with vendors and systems integrators in an extension of its cooperative marketing program.

The Network Enterprise Management Program features an expanded definition of network management to address the entire enterprise. This will involve publishing network specifications based on the OSI standard and the development of a more flexible network architecture that easily integrates third-party packages.

The integration will be an interface to software at the two lower layers of the OSI model: the physical link and the data link. DEC categorizes software as three types of modules: presentation or user-interface modules, modules that access or are accessed from other net-

works, and functional or software applications modules.

The OSI network will be an evolution of DECNET, but ideally it won't be restricted by operating systems, says Tony Viola, DEC's product marketing manager for networks and communications.

This concept of an Expanded Management Architecture will be DEC's answer to IBM's SNA/Netview and AT&T's Universal Network Management Architecture (UNMA).

DEC already has signed seven third-party cooperative development relationships with companies that provide access modules: management systems for data networks, voice and video networks, and distributed systems and databases. ■

“Our 1400 DEC terminals now offer full MS-DOS emulation, thanks to Logcraft.”

Thomas M. Costello, Ph.D.  
Vice President  
University of Lowell

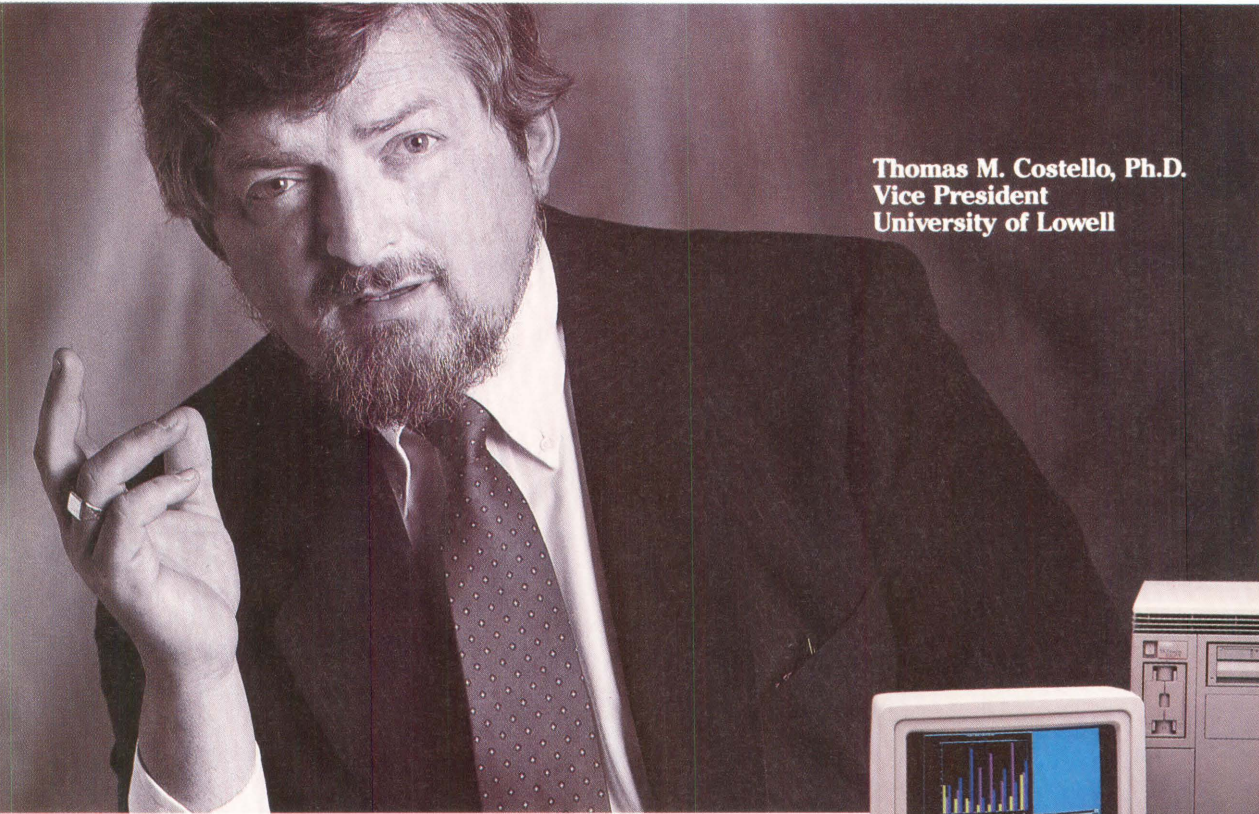

Hundreds of the world's largest banks, universities and businesses rely on Logcraft instead of PCs. With 386Ware from Logcraft, VT terminals and VAXstations can run MS-DOS software at high speed, at a fraction of the cost of buying individual PCs.



386Ware allows files to be shared back and forth, and gives PC applications full access to your existing VAX peripherals and printers.

386Ware from Logcraft. It not only saves you money. It makes your networks a lot more manageable.

**LOGICRAFT®**

22 Cotton Road  
Nashua, NH 03063  
(603) 880-0300  
FAX: (603) 880-7229

DEC, VAX, VAXstation and VT are trademarks of Digital Equipment Corporation. MS-DOS is a registered trademark of Microsoft Corporation. Logcraft is a registered trademark of Logcraft, Inc.

**CIRCLE 134 ON READER CARD**

## 750 PERFORMANCE

### QUERY:

**Bill Slayton** (SIG 13/MESS 151): We have three DMF32s and one DHU11 (giving us a total of 40 ports), one RA81 (which holds all system and user files and has 181,000 free blocks), one RA60 (used mainly for weekly and daily backups) and one TU80, all connected to a VAX/VMS 11/750 that contains 8 MB.

On average, we have 23 processes on the system at one time. Presently, we have 45 users on the 750 and 25 VT220 terminals to accommodate them. We also have seven spooled, queued printers, which, on average, print 10 50-block jobs per day.

Our main applications are word processing and spreadsheets. However, we also run accounts payable, fixed assets and prepaid accounts, which consume a great deal of CPU. But only the A/P program is run every day.

We do list processing for our marketing department, and two programmers compile COBOL programs all day. During a COBOL compile, the rest of the users are down. Otherwise, our throughput is OK until we get about 10 users logged in.

How can we increase throughput and response time? How do we know how much life is left in the 750? What are some rules of thumb concerning system tuning and monitoring? Is the 3500/3600 a viable migration destination? What about more memory or another disk drive? Any help would be appreciated.

### REPLIES:

**Eric S. Dungan** (SIG 13/MESS 152): Create a low-priority batch queue and force the COBOL compiles to use the batch queue. If your on-line users run at priority 6, set the batch queue up to execute at priority 2. Your on-line users will get the CPU they need, and the COBOL



## How To Use ARIS

If you're a subscriber to *DEC PROFESSIONAL*, you can call up our VAX and log into ARIS, our Automated Reader Information Service. In ARIS, you can download programs from this publication, communicate with our editors, request a change of address, find additional information about advertisers, order books and back issues, check the guidelines for submitting articles, take a peek at our editorial calendar for the year and communicate with other VAX users.

To log in, you'll need your subscription number from your mailing label. Set your terminal to seven data bits, one stop bit and space parity, or eight data bits, one stop bit and no parity, and dial (215) 542-9458. Baud rates: 300, 1200 or 2400.

### Recent Changes

As a *DEC PROFESSIONAL* subscriber, you can download any of the programs marked with an ARIS symbol in *DEC PROFESSIONAL*. *VAX PROFESSIONAL* programs are available only to subscribers of *VAX PROFESSIONAL*. For subscription information, contact Karol Hughes at (215) 542-7008.

California Alert: The ARIS lines in Southern California are up. The phone number is (818) 577-9100.

*XMODEM is available.*

*KERMIT is available.*

## SIG Identification

The SIG categories referenced in this month's *ARISTALK* are:

13 .....System Performance  
42 .....Communications/File Transfer  
101 .....Miscellaneous

compiles will be using whatever CPU your on-line people don't use.

**Bob Zisek** (SIG 13/MESS 153): Use Monitor Cluster to determine how much of the CPU and memory are be-

ing used on a daily basis. Record your Monitor output to file for about a week.

Be careful, because setting your monitor intervals to one second creates huge output files that quickly will devour your disk. I set the interval recording to five minutes, depending on how long I'm going to monitor.

We upgraded to a VAX 8250 and are pleased with the outcome. You might want to consider a low-end VAX 8000 series system instead of a MICROVAX 3500.

**Robert Hostetler** (SIG 13/MESS 154): Along with the COBOL batch queue, add at least 4 or 8 MB of memory and another RA81 disk drive. Much of what you're running is memory- and I/O-intensive.

If you add another disk and split user files from the system disk, you'll have less than half the I/O pending on either disk. I/O kills throughput on a UNIBUS system.

If the budget is small, take the disk over the memory. If the budget is non-existent, force memory paging over swapping by reducing working sets.

The COBOL programmers should be first in line. Paging will increase disk I/O but will give the memory breathing room and will help the spreadsheet users.

**James A. Walker** (SIG 13/MESS 155): Until recently, we had an 11/750 with 7 MB RAM, 1.2 GB disk storage, ORACLE RDBMS, word processing, spreadsheets, payroll and other applications. We replaced it with a 3600.

What an improvement! Our average user load is down, because the work is completed sooner. The computer room looks empty, and there's talk of taking back half of the space for office use.

One problem is the lack of usable backplane space in the 3600. The 3600 came standard with a 12-slot backplane.

---

# Millennium from McCormack & Dodge.

---

## Digital has it now.

---

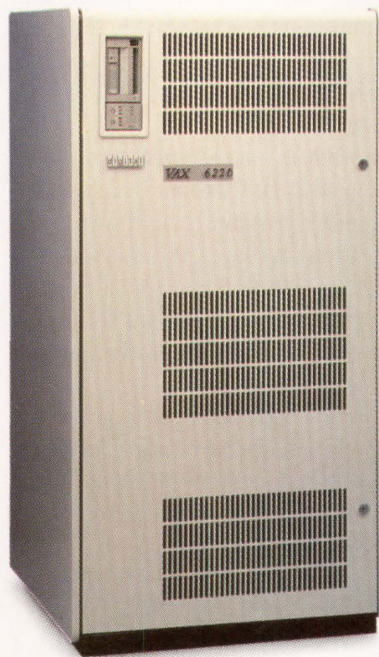

When we introduced Millennium® to the software industry, it was widely hailed as the world's first truly integrated processing environment.

A technology so advanced, Millennium gave users the long-awaited power to move easily from one business application to another through a common interface. For the most efficient use of a company's data processing resources,

and the people who work with them.

Now, M&D achieves another breakthrough. By bringing Millennium's borderless technology to the full range of Digital VAX machines. And with it, the means to process information on the VAX as never before.

Each and every Millennium application comes with a set of shared features. Such as query, HELP, screen design and multiple navigation methods. So users trained on one system inherently know how to obtain information from all of them.

In addition, every Millennium application runs on a variety of hardware platforms. Which means the software you use on VAX machines in divisional offices, for example, can be the same as that running on your corporate IBM mainframe. A feature that lets you realize the enormous potential of distributed software strategies.

What's more, Millennium works with Digital layered products like Data-trieve,™ the ALL-IN-1™ business and office automation system, and VAX VTX,™ a videotex application.

In short, M&D will take your business a Millennium ahead. To find out more, call us at 1-800-343-0325.

**McCormack & Dodge**

**DB** a company of  
The Dun & Bradstreet Corporation

---

8861 © We put the customer in control of the software.

The CPU takes one slot, the 32 MB RAM takes four, and the KDA50 Disk Cntl takes two slots.

Although the DELQA and TQK70 take only a half slot for the board, the remaining half (the C/D portion) isn't wired on the 3600 and isn't usable.

This left only three slots for our use. At minimum, you need some terminal interface unless you use LAT. Carefully calculate your backplane requirements before buying a 3500/3600.

**Barton F. Bruce** (SIG 13/MESS 156): You don't need a big machine. More memory and some clever parameter tuning will make a big difference. DEC and EMC can extend the 750 beyond 8 MB, and Nemonix will sell you a CPU speed-up kit.

A MICROVAX II with a KDA50 will run your disks. Add a Dilog DQ142 with MS: emulation. Better yet, add a DQ153 with MU: emulation, and your TU80 is running.

The DEC controller for the TU80 is a castrated Dilog DU132 that only can handle one drive rather than four. A TU80 has a PERTEC standard tape interface. The DQ153 can be bootable on the MICROVAX II (not emulating a TU81, but rather its optional TK50). Don't get a DQ132, because it has serious problems with VMS backup. Dilog is fixing the problems on the DQ142s, but it might not have microcode space to fix on the earlier card.

That leaves you with problems accessing terminals. You should be on terminal servers, so you can add all the CPUs you want, and any terminal can access them all.

DEC's server pricing doesn't reflect the fact that Emulex has a server that's more for your money, or that XYPLEX's nicely packaged box, which only does TCP/IP, should do LAT soon. You need a DELQA, but then you can network to PCs, and use DEC's PCSA or DECNET-DOS to do LAT. And Datability does LAT from PCs.

For more disk power, use a Dilog DQ256 for big SMD drives, a Dilog ESDI-or SCSI-type controller for

5¼-inch CDC Wrens, or the MAXTOR drives.

These give you a lot of power for less money. Stay in Q-bus land, and you can upgrade to MICROVAX IIIs.

In that case, leave your old non-BA2xx-compatible cards in any Q box connected as an expansion box to your skunk box.

Remember that a MICROVAX II equals an 11/780.

## RUMORS

**DR. R** (SIG 101/MESS 408): The eight-head Calypso (Rigel CPU) and PVAX are coming soon.

Also, the RISC workstation was preannounced in Australia in August.

## KERMIT FOR RSX-11M V4.0

### QUERY:

**Gerry Wollner** (SIG 42/MESS 393): We're running RSX-11M V4.0 and can't find a file transfer program that allows communication between the PDP-11/73, a Prime and a VAX. The version of KERMIT currently available from Columbia University allows us to receive but not send.

There's a problem reading the RSX file attributes. We have little experience in MACRO-11 and are looking for a turnkey task image. Does anyone have an RSX-11M V4.0 KERMIT?

### REPLY:

**Barton F. Bruce** (SIG 42/MESS 396): It's a shame to run M on an 11/73. There was and still might be an attractive upgrade path to M+. DEC would love to maintain M+ without M.

Most people now write code for M+, which could be why some newer version of something like KERMIT won't work with M.

The 73, unlike 23 and 24, supports I/D space and supervisor mode, and M+ (not M) makes good use of these hardware features.

Brian Nelson wrote and maintains the RSX version of KERMIT. I think the latest version appears on the DECUS RSX SIG tape, even before it's available from Columbia.

Find someone with M+ and try KERMIT from there. If it works, you have a good reason to upgrade.

## FILE TRANSFER

### QUERY:

**Robert L. Whitney** (SIG 42/MESS 399): I need to transfer ASCII files from a host 780 to our remote Big Blue clone via a DF112. We have KERMIT-32 and the hardware but no protocol package to run on our PC.

Has anyone used ProComm? Can you invoke ProComm from host? My KERMIT document is approximately 2½ inches thick. Am I missing something?

### REPLIES:

**Charles Hahn** (SIG 42/MESS 401): I've used ProComm to transfer files from sources other than a VAX. It uses a capture mode environment like other com packages. It has helpful on-line documentation and works if you don't have many files to transfer.

TYPE them on the screen and capture them transparently. Use the PGDN key to activate the file download routine, and as they scroll on the screen, they're captured to a file. If these are large files or if you have several files, use KERMIT for the PC.

**Phil Anthony** (SIG 42/MESS 402): I've found ProComm to be an excellent package for file transfers except on noisy lines, when it had a propensity for dying in the middle of a transfer.

If line noise remains a problem, try ProComm Plus, which handles line errors much better.

Dial in from the PC, log onto the VAX, bring up KERMIT-32, issue a SEND command for the files you need, hit PGDN on the PC, and select KERMIT as your protocol for the download.

Or, set ProComm in host mode on the PC. Assuming you have an autoanswer modem on the PC, dial in from the VAX, choose Upload on the ProComm menu, escape back to the KERMIT-32 command line, and SEND the desired files. ■



## Fun With WORD-11

Jane said, "See WORD-11. It is new. It has lots of features. It is the most complete word processing package available for VAX/VMS."

"Oh, oh," said Dick. "It is easy. It uses the fewest keystrokes. It has a color coded keyboard. It has optional menus. It is perfect."

"It is better than perfect." said Jane.

---

WORD-11, from Data Processing Design, makes child's play out of even the most complex documents. For the novice or expert, WORD-11 is the highest level in VAX/VMS word processing.

In addition to the features listed above, WORD-11 includes multiple font support, automatic spelling correction, Thesaurus, automatic hyphenation, multiple wrapped columns, automatic box draw, on-line help, list processing, and a fully integrated graphics option. Plus, WORD-11 offers high performance with low CPU overhead.

Now WORD-11 is available on IBM PC's

and compatibles with identical document format as the VAX version.

For more information on WORD-11 or a demonstration kit call or write.



**Data Processing Design, Inc.**

1400 N. Brasher St., Anaheim, CA 92807

**800-843-1317**

Inside California call 714-970-1515

Inside Canada call 416-225-7788

FAX: 714-779-7468

## New Communication VISTAs

### Datability Software Systems' VISTA Communications Servers Broaden Horizons

**P**rice, performance, power and flexibility are key features you seek when purchasing equipment. Datability Software Systems Inc. of New York, New York, vendor of the popular Remote Access Facility (RAF), has introduced a line of communications servers that incorporate these four ingredients.

The VISTA VCP-1000 is a communications platform for Local Area Networks (LANs) that can expand and change with your communications needs.

The concept is simple. Provide ports on the chassis of the server to accept any combination of communications connection boards and devote one slot to a board that runs the protocol you need. Allow the customer to mix and match boards without reconfiguration. Also allow him to swap the protocol board if the networking strategy of the organization changes radically. Wrap these abilities into a package

that has a small footprint and is rack-mountable. Finally, sell it for a low price.

"Companies are tired of having to replace their computer equipment every couple of years due to growth or fast-changing technology," asserts Jim Hare, Datability's director of sales, Hardware Division. "The VISTA series communications server will change all that. It's not just another single strategy, it's a platform designed to meet your needs now and into the 21st century."

The VISTA chassis is 5 1/4 inches high, 17 5/8 inches wide and 17 7/8 inches deep. A menu-driven front panel allows you to run diagnostics, locate problems and errors, install and configure the unit and display status information.

The backplane has five slots. One slot is used for a communications motherboard. Four others are available for add-on daughterboards.

The motherboard is fully LAT-compatible to

allow easy connections to DEC networks. An Ethernet transceiver is built in. Three Ethernet connectors, BNC Thin Net, AUI and a Synoptics Lattisnet Unshielded Twisted-pair (RJ45), are standard. A 10-MHz 80186 coprocessor and 512 KB of dynamic RAM used for multipacket buffering reside on the motherboard. Server port configurations are stored in 192 KB of static RAM with battery backup. A high-speed 82586 Ethernet coprocessor rounds out the on-board hardware.

LAT-compatible software resides on the card. The card will check the host for later-version software and

load it from the host if necessary.

The modular approach means that switching protocols requires a simple board swap. Token Ring, X.25, OSI and TCP/IP protocol boards now are under development. Datability is working with other vendors to provide third-party boards compatible with the VISTA platform.

The motherboard provides no user connections. That task is handled by the daughterboards residing in the other four slots. Each daughterboard provides its own 80186 coprocessor and 64 KB of RAM, expandable to 192 KB.



*Datability's VISTA server has space to hold individual communications boards that can be mixed and matched for flexibility.*



## **Now the world's best printer value is fully DEC™-compatible.**

The new Accel-500 gives DEC system users outstanding speed and quality. For hundreds of dollars less than comparable 24-pin dot matrix printers.

Use it to zoom through drafts at 480 cps. Or combine letter quality with high-resolution color graphics. With full LQP02, LA210, or LA120 emulation, including specialized fonts.

Accel 500's unique Select-Dial™ puts paper set-up and positioning at your fingertip. Plug-in Intelli-Cards™ let you add fonts and emulations instantly. While built-in tractors and a full line of paper-handling options take 6-part forms in stride.

All backed with the best warranty in the industry: a full 2 years. Call AMT at (800) 992-2264 today for the location of your nearest Accel-500 dealer. Or ask how to become an Accel-500 reseller. And make sure that your computer is playing with a full DEC.

# **ACCEL-500™**

*The Top Dot Matrix Printer in the World*

# Full DEC.



*Advanced Matrix Technology  
1157 Tourmaline Drive  
Newbury Park, CA 91320*

*DEC, LQP02, LA210, and LA120 are trademarks of Digital Equipment Corporation.  
ACCEL 500 is a trademark of Advanced Matrix Technology, Inc.  
© 1988, Advanced Matrix Technology, Inc.*

CIRCLE 229 ON READER CARD

Additional boards won't degrade the VISTA's performance. Boards can be mixed to meet your needs. Each daughterboard consists of the primary card that plugs into the backplane and a right-angle card that provides the connectors. Options for the right-angle card include 32 six-line RJ-type jacks or two 50-pin AMP connectors.

The RS-232 daughterboard provides eight ports to support any RS-232 asynchronous device. This would allow 32 devices to be supported if all empty slots were filled. All eight lines support data transfer rates of up to 38.4 KB. Full modem control is provided.

An RS-423 daughterboard provides 32 ports, allowing 128 connections to the VISTA server if all four slots are filled. The board supports baud rates of 9600 bps up to 38.4K bps, depending on configuration.

Other daughterboards under development or consideration include a modem board providing eight Hayes-compatible ports, an X.25 board and ISDN and T1 units.

In addition to flexibility, a number of key features are included. Multiple sessions are supported. Switching between sessions involves a single keystroke. Static RAM is used to save parameters. Changing a daughterboard doesn't require reconfiguration. In addition, there is extensive menu-driven help. Load balancing is automatic. Automatic failover configuration is possible to allow connections to alternate hosts. Every port has performance and error statistics logged for it. Port locking, group codes and passwords provide security. Full-speed file transfers are supported. Network management control includes port-based, server-based and LAT-compatible-based counters.

The VISTA series will begin shipment in January 1989 and will be priced between \$3,000 and \$4,000.

For more information, contact Datability Software Systems Inc., 322 Eighth Ave., New York, NY 10001; (800) 342-5377; in NY, (212) 807-7800.

**Circle 496 on reader card**  
—David B. Miller

## TRW Tool Eases Examination Of ERRSNAP.LOG Data

*Analyzes Error Snap Log File Info*

The Snap File Analyzer (SFA), a software tool for decoding and analyzing the data contained in the error snap log file (ERRSNAP.LOG) of VAX 8600 and 8650 processors, has been introduced

by TRW Customer Service Division, Fairfield, New Jersey.

The ERRSNAP.LOG, which is approximately 10 blocks long, contains data on

```

*****
* --- TRW 8600 Series Error Snap Analysis --- *
*
* Main screen:
* (1) Snap Error Summary Report
* (2) Snap Analysis Report
* (3) Decoded Snapfile Data
* (4) Choose Another Snapfile
* (5) EXIT
*
*****

----- Data File Status -----
CPU Type           -- VAX 8600 processor
Engineering Revision Level -- 8
Manufacturing Plant Code  -- 7
System Serial Number  -- 1321
File Status  -ff-  -- Invalidated by VMS
(Invalidated = File has been copied from Console)
                    (
                    to system disk by VMS
                    )

Enter Select Number : *#*

```

*This screen shows the three levels of analysis that can be run via the TRW Snap File Analyzer, plus standard housekeeping activities.*

the health of the 86xx system. Each time a processor crashes, a new file is created. This important data is stored in hex format and therefore requires manual decoding. Thus, often it's overlooked or only partially examined. TRW's SFA solves this problem by converting the file to plain English text for easy readability.

SFA is designed for use under VAX/VMS version 4.0 through 4.6. It's installed in SYS\$ERRORLOG or SYS\$SYSROOT using a simple command procedure, which is supplied. The utility can remain on the system indefinitely and can be invoked when needed.

SFA is easy to use and can be operated remotely. It requires about 10 minutes to run, and it isn't dependent on any other diagnostic product. Files can be off-loaded to other systems for analysis or storage. In addition to converting the ERRSNAP.LOG data into English, the SFA also compares actual

data with expected values. Errors are flagged clearly.

The VMS version of SFA is available now. A UNIX-based version will be available by the end of the year. An enhancement of both versions is planned to include features such as early diagnosis/fault avoidance (that is, borderline fault detection), diagnostics updates, and automatic fault detection and resolution. A version of SFA for the VAX 8283 processor should be available by the end of the year.

SFA is licensed by CPU. List price is \$2,600 per processor, and quantity discounts are available. An annual subscription update service, available for a nominal fee, ensures that the user will receive updates or enhancements to the software or documentation.

To learn more, contact TRW, Customer Service Division, 15 Law Dr., Fairfield, NJ 07006-2078; (201) 575-7110.

**Circle 416 on reader card**  
—Ron Levine

# DENSE

## ***How dense? Try 2.3 gigabytes on a standard 8mm videocassette!***

Think about it. . . With the CTS-8 8mm cartridge tape subsystem, you can store up to 2.3 gigabytes of data on a tape that's both inexpensive and reusable. That's enough capacity to handle four or five RA81 class disks. On a tape that fits in your shirt pocket.

Do your backups at night, when nobody's around. No operators. No tape swapping. When you arrive in the morning, your backup's done. Just take the tape out and put it in your desk. You don't even need a storage room.

And since the CTS-8 is completely VMS compatible, you can keep using the software and procedures you've always used. No hassles.

The CTS-8 is the breakthrough you've been waiting for. But you don't have to wait any longer. Because the CTS-8 is available *now* for DEC UNIBUS and Q-BUS VAX systems.

Let Transitional Technology show you what dense really means. Call TTI and ask for Sales.

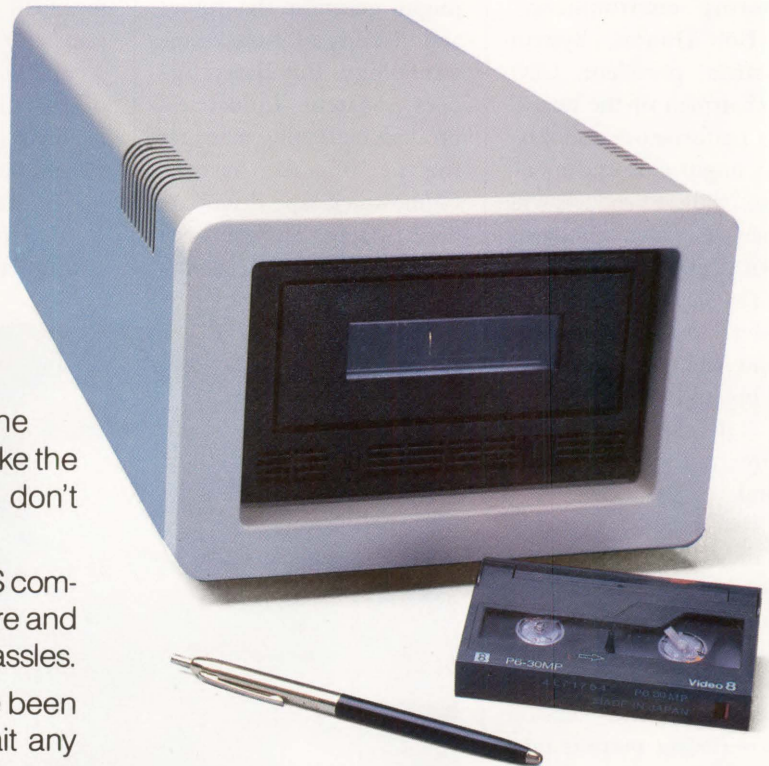

*"For large capacity back ups on a single, easy to purchase tape, the CTS-8 Subsystem wins hands down over any other tape subsystem that D.R. LABS have tested."*

DIGITAL REVIEW/FEB. 22, 1988



**Transitional Technology, Inc.**

1411 N. Batavia, Suite 203 • Orange, California 92667  
(714) 744-1030

CTS-8 is a registered T.M. of Transitional Technology, Inc. DEC, UNIBUS, Q-BUS, VMS and VAS are T.M. of Digital Equipment corporation.



CIRCLE 262 ON READER CARD

# System Industries Executes Tape Subsystem Triple Play

## Tape Subsystems Support HSC50 And HSC70 Controllers

Three new tape storage offerings from System Industries of Milpitas, California, directly target VAX systems with HSC50 or HSC70 controllers.

The SI2200 and SI2100 are 9-track units rated at 200 ips and 100 ips, respectively. The SI2046 power pack is an 8mm cartridge unit.

"This new family provides the most advanced tape storage available for the DEC clustering environment," says Bob Duncan, System Industries' president, CEO and chairman of the board. "The performance and reliability improvements demonstrated by these products will set new reliability standards for VAXCLUSTER users."

The SI2200 boasts a peak transfer rate of 1.25 MB per second and supports both 1600 bpi and 6250 bpi tapes. The SI2100 has a peak data transfer rate of 625 KB per second.

Two important features give the SI2200 and SI2100 the performance edge. A 256 KB cache buffer provides a smoother flow of data and helps facilitate streaming. A capstan drive with tension arm buffering permits tape repositioning in less than 60 ms.

Tape transport, a formatter/controller, power supply and resident diagnostics as well as a time-saving automatic loader

come standard with both the SI2200 and SI2100.

Reliability is a key factor. Mean Time Between Failure (MTBF) is reported to be 10,000 hours and 11,000 hours for the SI2200 and SI2100, respectively. Extensive error detection and correction are built into the units to maintain data integrity.

With so many cartridge tape units introduced, some might question the future and viability of 9-track tape technology. But Barry Eggers, System Industries' product marketing manager for peripherals, asserts, "Nine-track tape drives are here to stay. They've been and will remain the domi-

nant standard established for software distribution and data interchange. In addition, they're essential for sites that have data archived on 9-track media."

To complete SI's offerings, a cartridge unit, the SI2046 power pack, also is available. The SI2046 uses 8mm cartridges, providing high-storage capability at a low cost per cartridge. It's compatible with DEC's TK50 software.

Using helical scan recording methods that employ a diagonal striping technique to record data, each drive unit can record up to 2.3 GB of data. Peak data transfer rate is 1.5 MB per second with a sustained rate of 246 KB per second. To facilitate data movement, a 256-KB buffer is used as it is on the SI2100 and SI2200.

Up to four drives can be configured in the same

power pack. By adding an additional power pack, 18 GB of data can be stored. A single backup can be written across all tapes in each drive, or multiple, independent backups can be written to different units simultaneously.

Reliability is a key factor with the SI2046. It features an MTBF of 20,000 hours. Extensive error detection, correction and recovery are on-board.

Prices range from \$55,000 to \$60,000 for the SI2200, \$28,000 to \$30,000 for the SI2100 and \$28,000 to \$50,000 for the SI2046 power pack, including installation and one year of on-site maintenance.

For more information, contact System Industries, 560 Cottonwood Drive, P.O. Box 789, Milpitas, CA 95035-7403; (408) 432-1212.

**Circle 427 on reader card**

—David B. Miller



*The SI2200 (pictured) and SI2100 provide speeds of 200 and 100 ips, respectively.*



*The SI2046 power pack holds up to four 8mm drives, each with a capacity of 2.3 GB.*



This freehand drawing was created using DRAW's tablet mode.

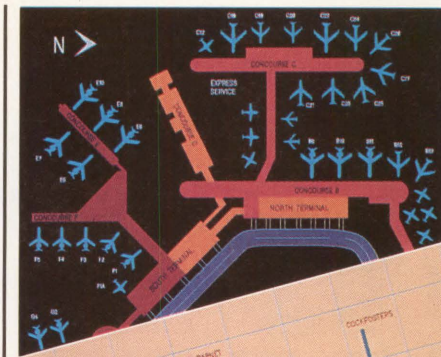

This airport terminal layout illustrates the placement of user-defined symbols with object-snapping.



Grid-snapping was used to create this map of the London subway system.

DRAW's extrusion feature allows the user to generate complex graphs and drawings.



# It's Like Having MacDraw<sup>®</sup> on Your VAX

## DRAW: The Precision Visuals Drawing System<sup>™</sup>

A drawing environment for your VAX with features you'd expect from MacDraw? That and more. Precision Visuals' DRAW delivers a device-independent system built for all levels of users to quickly create color illustrations interactively.

Because DRAW offers you your choice of menu, command, or tablet driven interfaces, the system is easy to learn which makes training a snap. Engineers, scientists, project managers, researchers, technical writers and graphic artists can use DRAW to make their plans, proposals, and presentations come to life with publication-quality artwork.

To make your illustration creation even easier, DRAW has a symbol library with more than 400 elements — from geographical boundaries and icons for computer equipment to circuits and logic symbols. You can easily add to this li-

brary with your own custom symbols for every day use.

With DRAW you can export picture metafiles to other CGM-compatible systems so you can incorporate line drawings with charts or any other graphics. You can also use DRAW to route images through POSTSCRIPT, HPGL, and other publishing formats to merge illustrations with text output.

DRAW provides user control over every attribute with a feature set that includes color table support, layering, mirroring, 3D extruding, variable

line width, 48 hatch patterns and publication-quality text fonts. And because DRAW operates on all VAX/ VMS systems with Tektronix graphics or VT-240, VT-340 terminals and all popular hardcopy devices you are not tied to the hardware.

To qualify for a free evaluation copy and to receive complete technical information, call Chris Logan at 303/530-9000.



### Precision Visuals

**Precision Visuals, Inc.**  
6260 Lookout Road  
Boulder, Colorado 80301 USA  
Phone: 303/530-9000 Telex: (RCA) 296428  
Fax: 303/530-9329

**PVI Precision Visuals International GmbH**  
West Germany  
Phone: 49-69/6 66 65 97 Telex: 176 997 150  
Fax: 49-69/6 66 67 38

**Precision Visuals International Ltd.**  
United Kingdom  
Phone: (0895) 35131 Telex: 51826715  
Fax: (0895) 72299

MacDraw, PostScript, VAX/VMS, VT-240, VT-340, and DRAW are trademarks of Claris, Corp.; Adobe Systems, Inc.; Digital Equipment Corporation; and Precision Visuals, Inc., respectively

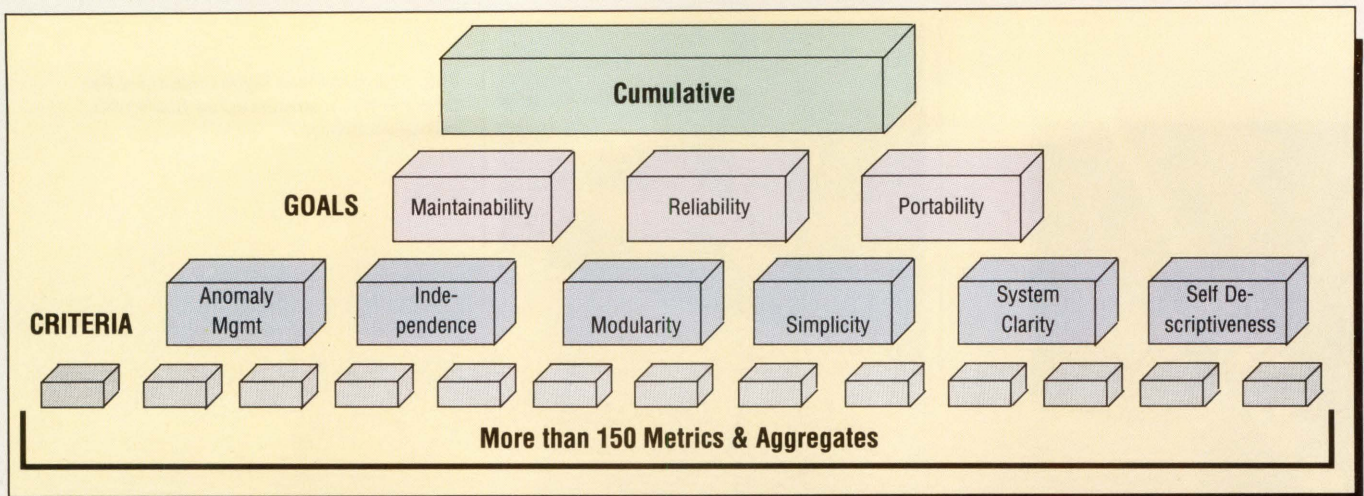

*The Adamat hierarchy divides quality goals into more than 150 categories.*

## Dynamics Research's Adamat Checks Code Quality

*Ada Code Management And Analysis Tool Provides Software Goals*

To address the Ada programming tools market, Dynamics Research Corporation (DRC) of Andover, Massachusetts, has made its Adamat Ada code management and analysis tool commercially available.

Adamat allows programmers and software engineers to gauge the feasibility of the Ada code they've written. Using Adamat, a developer can go inside Ada code at any phase of its development and check its quality against set parameters that measure maintainability, reliability and portability. The objective is to write the new code at the level of quality Ada code is capable of achieving.

With Adamat, DRC has automated the process it uses in many military applications to ascertain the predictability of Ada-developed software performance. Adamat employs more than 150 Ada-specific proprietary metrics (see Figure).

These metrics or "software goals" are divided into six criteria: anomaly management, independence, modularity, simplicity, system clarity and self-descriptiveness. The metrics analyze individual constructs and how well the code meets a project's goals.

Adamat's hierarchical software components include:

1. A data collection tool called COUNT, which counts occurrences of data items and sends the data items to the Quality Analyzer.
2. The Quality Analyzer, which generates a score for the criteria and metric elements.
3. A report generator.
4. A PC XT-based tool that displays scores in graphs and tables.

"I think Adamat will revolutionize the way Ada code is written," says Chuck Williams, an engineer at Contel Federal Systems of

Reston, Virginia. "After the learning curve, the increase in productivity will be phenomenal."

From the front end, Adamat looks like a compiler. And like a compiler, Adamat parses code, and has a similar user interface. However, Adamat compares code written in Ada to the metrics in its database. This comparison checks for flaws by determining if the new code adheres to standard practices of software engineering.

The result indicates to the user the quality of the code and specifies areas for improvement. It points out places where Ada code isn't optimally used and suggests alternatives.

The VAX/VMS portion of Adamat is written in Ada, so Ada can analyze any source code (Ada or Ada Program Design Language) that resides on or can be ported to a VMS environment. The PC XT portion, which is menu driven and provides summaries and comparisons, is written in PASCAL.

Adamat also can be used as an Ada training tool. By emphasizing quality prin-

ciples to solve problems and by pointing out bad programming practices, it can improve a developer's programming style.

Ada, which was accepted as a military standard language in 1983, is noted for its portability. Ada-generated code can be run on target processors, including Intel and Motorola. Developers appreciate Ada for its handling and ability to be tailored, but it has a substantial learning curve. Ada is optimized for performance in embedded systems.

Adamat CPU licenses start at \$4,495 for VAXSTATIONS, the MICROVAX 2000 and the VAX 11/750; \$9,995 for the MICROVAX II through the 8350; \$14,995 for the 8530 and 6220 through the 8700; \$19,995 for the 6230 through the 8830; and \$24,995 for the 8842, 8840, 8978 and 8974. Prices include the PC XT portion.

For more information, contact Dynamics Research Corp., 60 Frontage Rd., Andover, MA 01810; (617) 475-9090.

**Circle 492 on reader card**

—Evan Birkhead



# ARSAP™

**VMS V5  
COMPATIBLE!**

## The system accounting product that stacks the DEC™ in your favor.

With ARSAP you can do it all. Everything from capacity planning to performance management to project accounting. ARSAP was designed to work with VMS, so you don't need to change your operating procedures to put this comprehensive system to work for you. And because of its exclusive options, ARSAP is the most efficient and powerful system accounting product available today.

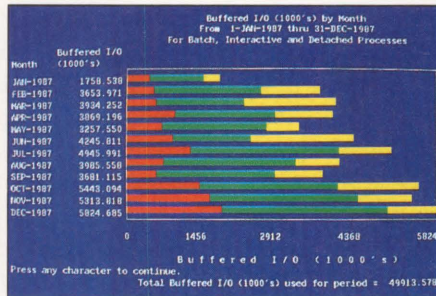

Analyze historical data to plan system resources required for future growth.

### Disk Management and Global System Reporting aid long-term capacity planning.

With ARSAP, you can generate easy-to-read bar chart capacity reports for any accounting statistic available from VMS, including CPU time, memory utilization, buffered I/O's, direct I/O's, connect time, and more. And our disk management reports identify amount of space allocated to each user and total amount of free space remaining.

Manage users and control project costs using ARSAP reports.

### Selective Image Accounting reduces accounting files by as much as 90%.

Only ARSAP allows you to select and report on the specific applications you choose, instead of the familiar "all or nothing" alternative offered by other systems. This valuable option saves thousands of I/O's to your system disk and reduces the space requirements of accounting files by as much as 90%!

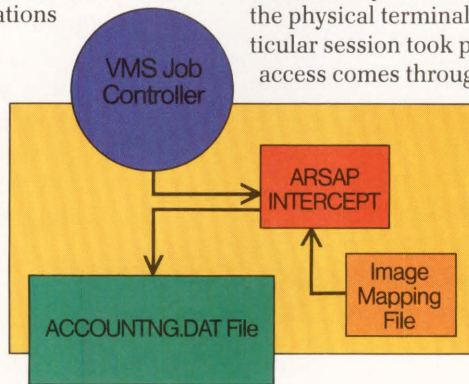

Use "ARSAP Intercept" to automatically select image data for software reporting.

### Terminal Reporting tracks usage for control and troubleshooting.

ARSAP's exclusive terminal reporting feature lets you track usage and locate the physical terminal on which a particular session took place, even when access comes through virtual terminals, Intergraph™ workstations or DECservers (LATs).

### Get the details on ARSAP today.

ARSAP (version 6.0) is the product of 11 years of system accounting design. No other software package is better suited to your DEC system or your system accounting needs. Only ARSAP offers you a complete solution. For more information about how ARSAP can meet your needs call GEJAC today.

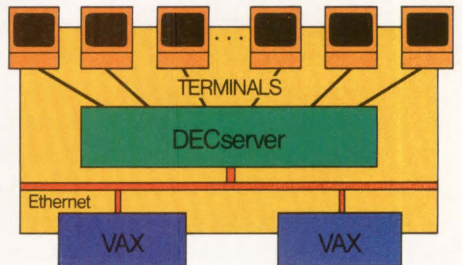

ARSAP gives you the "evidence" to effectively allocate limited hardware among users.

**1-800-43ARSAP**  
(1-800-432-7727)



Mail the coupon below to GEJAC, INC.  
8643 Cherry Lane, Laurel, MD. 20707

Name \_\_\_\_\_ Title \_\_\_\_\_

Company \_\_\_\_\_

Address \_\_\_\_\_

City \_\_\_\_\_ State \_\_\_\_\_ Zip \_\_\_\_\_

Telephone \_\_\_\_\_

Send information on:

Chargeback  Performance Evaluation

Project Accounting  Capacity Planning

Resource Management  Software Package Reporting

Printer Forms Tracking  Other \_\_\_\_\_

I have these VAX/VMS systems:

# of systems \_\_\_\_\_ Model #'s \_\_\_\_\_

ARSAP is a registered trademark of GEJAC, Inc. DEC is a registered trademark of Digital Equipment Corp. Intergraph is a registered trademark of Intergraph Corp.

# Wellfleet Communications Servers Route T1 LAN Traffic

## Link And Concentrator Nodes Connect Directly To T1 Networks

The current generation of networking protocols, including Ethernet, Token Ring, TCP/IP and ISO, represents a new era in data communications. Recently, great strides have been made toward advancing network technology, i.e., high-speed digital services and LAN installations. The next step involves thoroughly uniting disparate LANs into WANs.

There are three applicable server methods. These are bridges, routers and gateways.

Bridges are standard, low-level mechanisms for connecting LAN traffic. They're used for forwarding packets between LANs and to connect Ethernets. In the OSI model, bridges connect LANs at the data-link layer.

Routers, which are more sophisticated than bridges,

connect LANs at the protocol layer that's addressed specifically to each side, not transparently like bridges. In the OSI model, this is usually the networking layer.

Gateways are applications-level interfaces, or translations of protocols, between unlike platforms.

Paul Severino, president of Wellfleet Communications Inc. of Bedford, Massachusetts, believes that the LAN interconnect business will create a \$500 million market by 1990, with 700,000 to 900,000 PC network connections. Severino projects that Wellfleet's role will be to deal with LAN traffic, using each of the three server methods, by connecting it through proprietary boxes. There will be a specific focus on the Terrestrial 1 (T1) networking protocol.

T1 is a technique originally used by AT&T to connect its central offices over standard telephone lines. ANSI committee X.3 T1 has standardized the T1 specification. ISDN networks of the future will be based on T1 technology.

Wellfleet recently released its first products, a Link Node (LN) and a Concentrator Node (CN). These are designed to solve problems associated with linking remote networks and distributed databases.

The LN and CN are communications servers that allow LANs to be interconnected through digital WANs. They let users share T1 resources with routing, bridging and private voice services. The servers connect directly to 1.544 Mbps T1 networks through multiplexers, PBXs or DSX-1 interfaces, and handle multiple protocols, including DECNET and TCP/IP (see Figure).

In addition, the servers permit user-definable network management func-

tions, including network configuration, fault isolation, performance analysis, security and line-traffic monitoring. Each machine contains a 32-bit 68020 communications processor that performs the link control, bridging, routing and network management functions.

The CN provides direct attachments for up to 26 LAN and 52 WAN links. The LN supports up to 8 LAN and 16 WAN links.

Data packets can be transmitted from WAN to WAN, from LAN to LAN, or from LAN to WAN. The servers are fully compatible with AT&T's Accunet T1.5 and Digital Access and Cross-connect System, Customer Control Configuration (DACS CCR).

The T1 protocol consists of 24 multiplexed data/voice channels. Wellfleet's T1 nodes use 12 channels, allowing the remaining 12 channels to be used for other purposes. Most satellite transmissions are T1-compatible.

Wellfleet anticipates that the network nodes, which are shipping now, will attract universities, large engineering and aerospace sites, and federal government installations. That's because these organizations are heavy users of TCP/IP and should be using ISO protocols in the near future.

For more information, contact Wellfleet Communications Inc., 12 De Angelo Dr., Bedford, MA 01730-2204; (617) 275-2400.

**Circle 491 on reader card**  
—Evan Birkhead

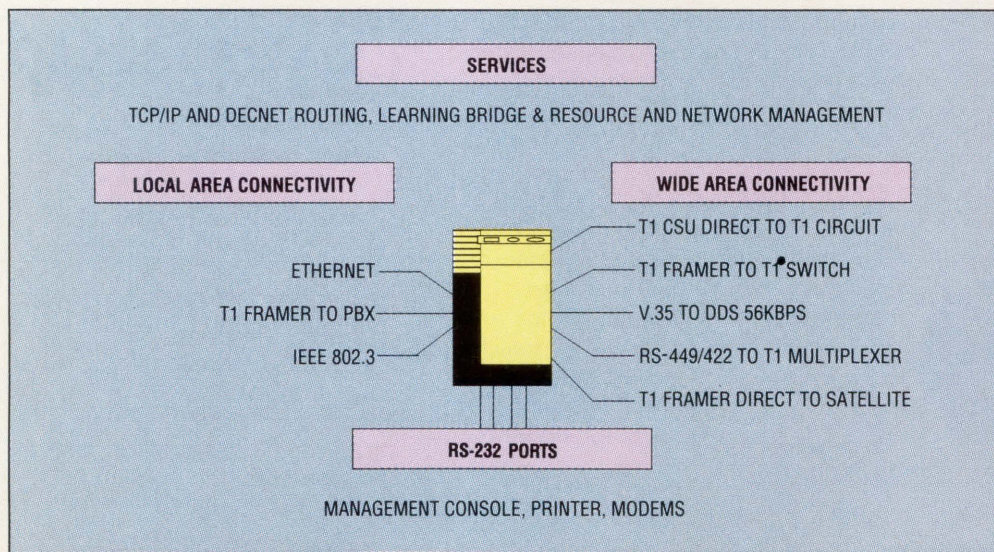

*Wellfleet's Link Node and Concentrator Node route traffic between LANs and WANs.*



# THE WIZ KITS

## Simple Solutions to Your VMS Management Problems

**NEW**

### SCHERERS WIZARD SOFTWARE

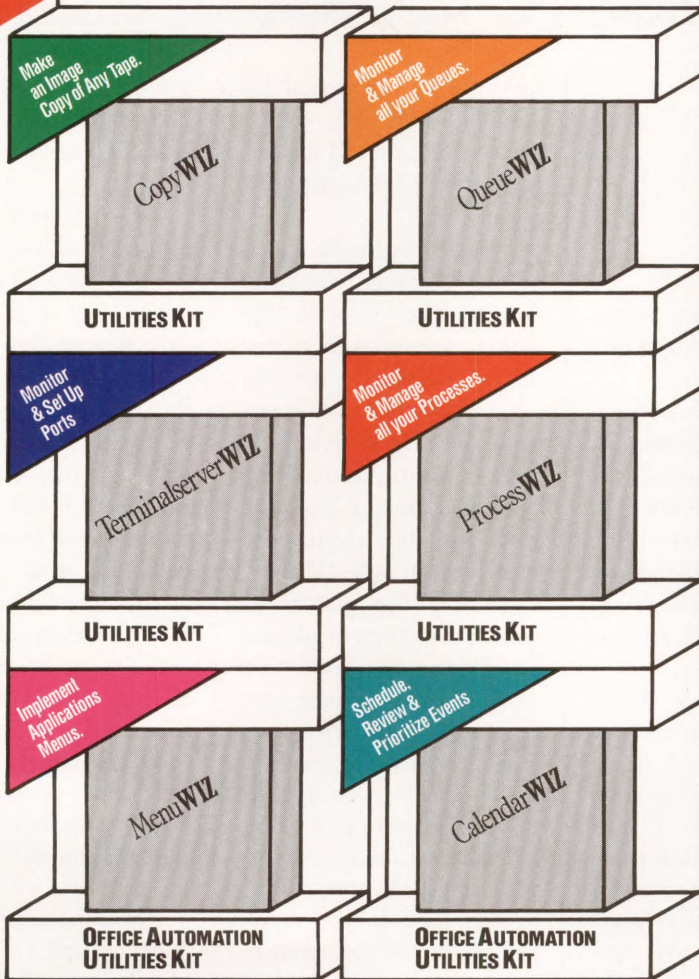

**W**e identified your most common VMS management problems, and solved them.

Utilizing a simple, single screen windowing format and cursor selection, the WIZ KITS perform complex functions with ease.

CopyWIZ, ProcessWIZ, QueueWIZ, TerminalserverWIZ, MenuWIZ and CalendarWIZ are easy to install software kits that allow you to automate your office and enhance your system's capabilities. Instead of digging through documentation and struggling with DCL syntax, you manage your system faster and easier.

And, with prices starting at \$295 per kit, you can have all six.

- The WIZ KITS have one standard format.
- The WIZ KITS can be installed on all VAXes.
- Each WIZ KIT includes one hour of technical phone support with our Wizard.
- The WIZ KITS include installation guide, documentation and licenses.
- WIZ KIT media include: TK50 RX33 RX50 (other media optional)



"Don't ask me why the VMS developers never went to windows! Maybe they just like to type!"

**Call us today.  
Let our Wizard talk to your Wizard.**

**SCHERERS**  
Wizard Software  
502/456-4898

©VMS is a registered trademark of Digital Equipment Corporation.

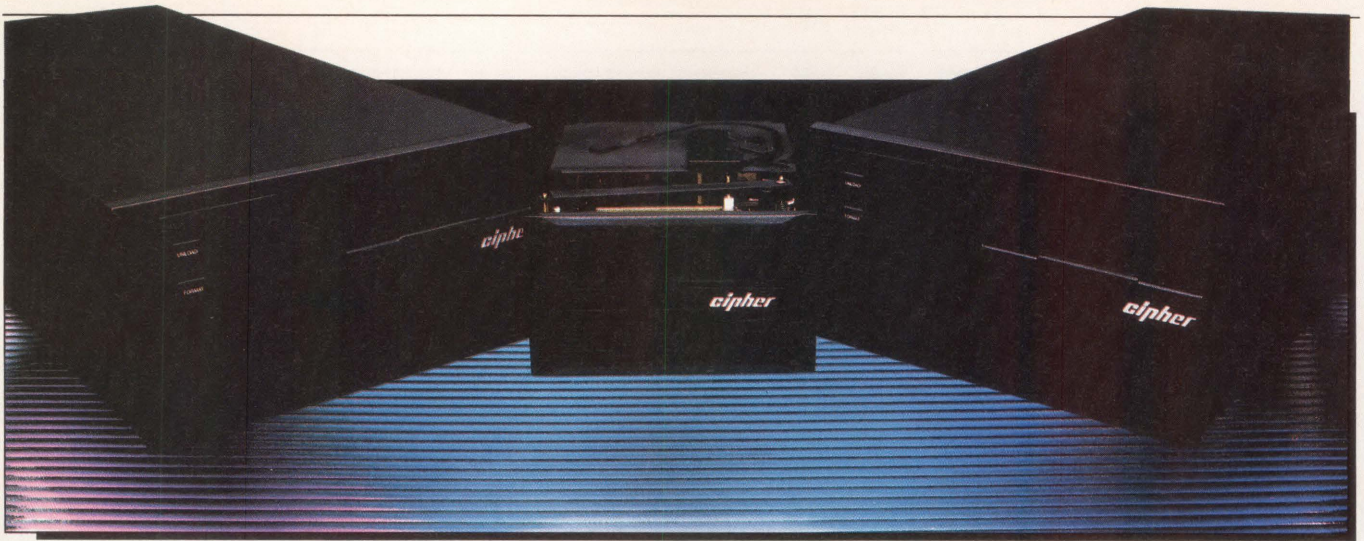

*Cipher 3000i family includes 5¼- and 8-inch form-factor drives, providing tape storage for midrange computers.*

## Cipher Joins Move To Smaller Tape Drives

### *3000i Family Features Half-Inch Cartridge Tape Drives*

Joining the trend toward smaller tape drives, Cipher Data Products Inc. of San Diego has entered the cartridge tape-drive arena.

Dubbed the 3000i family, Cipher's new products include two 8-inch form-factor drives, the 3832 and 3834, and the model 3532, a 5¼-inch form-factor drive. Interfaces include the IPI-Level 3, SCSI and the Cipher/Perfec interface. During the next 12 months, 26 configurations of the three models are scheduled to be available in both tabletop and rack-mountable versions.

All 3000i drives use the Multitrack Serpentine Recording (MSR) format, which records data on 24 parallel tracks in groups of two or four tracks. Data is written on a group of tracks during one pass of the tape. After one pass, the other group of

tracks receives data as the tape moves in the opposite direction.

The two-track method, labeled MSR-2, allows for data interchange among all members of the 3000i line. The four-track (MSR-4) format, available on higher-end models, boosts performance levels for demanding applications.

Extensive error detection and correction are provided through the Reed-Solomon Error Correction Code (ECC) and Cyclic Redundancy Check (CRC).

Currently, the models hold 320 MB of data using industry-standard 3480-type cartridges. In addition to the 320-MB main partition, a 3.4 MB partition can be used for a directory. In 1989, a 10-cartridge stacker will be available, allowing 3.2 GB of data to be stored without operator intervention.

Data transfer rates range

from 242 KB per second for the model 3532 up to 448 KB per second and 896 KB per second on the 3832 and 3834, respectively.

The 3000i line is aimed at the midrange computer market. The low-cost 3530 drives are designed for microcomputers, low-end minicomputers and workstations. The 3830 series addresses workstations and small mainframes. Both the 3530 and 3830 series can write data in MSR-2 format, facilitating data interchange among computers of all sizes.

"Since the early 1980s, system integrators have been looking for an alternative to older reel-to-reel technology. Although open-reel drives offer an important interchange standard, the format limits both capacity and performance in the newer and smaller microcomputers, workstations, minis and other midrange systems, so prevalent in our businesses today," remarks Gary E. Liebl, Cipher's chairman of the board and chief executive officer.

"Cipher's 3000i family of half-inch cartridge drives

delivers interchange, for the first time, in form factors designed for these systems," says Liebl.

The 3000i family features reliable performance. Fault detection is performed during powerup, and tape-drive operation is monitored during use. Diagnostics on the 3830 series can be executed from the front panel or by host commands. Brushless reel motors and a minimum of moving parts combined with CMOS VLSI circuitry help boost the MTBF to 15,000 hours.

The 3830 series drives are currently available. Prerelease units of the 3532 will be available in early 1989.

OEM volume pricing stands at \$1,380 for the 3532, \$3,710 for the 3832 and \$4,400 for the 3834.

For more information, contact Cipher Data Products Inc., 10101 Old Grove Road, P.O. Box 85170, San Diego, CA 92138; (619) 578-9100.

**Circle 499 on reader card**

—David B. Miller

# TCP/IP

for  
VAX and  
MicroVAX

## Take speed to new limits.

CMC outperforms our nearest competitor, flat out, with the fastest TCP/IP Ethernet implementation in production for VAXes and MicroVAXes.

With TCP/IP software and intelligent front-end processors from CMC, DEC users can now interoperate with a wide variety of workstations—and at unheard-of rates of speed—an average of 40% faster than the competition in disk-to-disk file transfer rates. CMC's ENP-40 (for VAX) and ENP-50 (MicroVAX) Ethernet processors dramatically off-load the communications burden from the host system, leaving the host free to perform the applications it was built and bought to run. With that extra processing power, you save additional money by eliminating the need to purchase bigger, more expensive hosts.

Along with the performance package, CMC's TCP/IP for VAX and MicroVAX installs in 45 minutes, and is equipped with lots of standards such as VMSINSTAL, on-line help, TELNET, FTP, SMTP, and NetStat. Also included are programming interfaces, UNIX socket library, Q I/O calls, transparent user interface between network mail and VAXmail—and of course, the industry's best customer support.

Set LAN speed records with CMC. Call the performance standard today.

**1/800/CMC/802.3**

CIRCLE 365 ON READER CARD



**CMC**

A Rockwell International Company

**We set the LAN speed record.**

125 Cremona Drive, Santa Barbara, CA 93117  
1/805/968/4262 TWX 240876 FAX 1/805/968/6478

LAN speed record. ENP-40 and ENP-50 are trademarks of Communication Machinery Corporation. All other product names mentioned and shown are registered trademarks of their respective manufacturers. © CMC 1988.



# “An Ounce of Prevention is Worth a Pound of Cure”

**ClydeSENTRY security software protects your private files and deters computer criminals from trying to access them.**

When it comes down to it, your company's records and information are its most valuable assets. If you compromise that information, you could lose millions—or worse.

Benjamin Franklin said it best when he said “an ounce of prevention is worth a pound of cure.” The time to protect your data is before a loss occurs. Every year more than a billion dollars are lost to computer crime. Surprisingly, the majority of violations come not from external hackers, but from trusted employees. Recent surveys show that over 85% of computer crime comes from a company's own employees, with an average loss of over \$90,000.

ClydeSENTRY computer security software for VAX/VMS systems is a major deterrent to most assailants. With the knowledge that the entire system can be monitored and a detailed audit report produced pinpointing potential security problems, users are not likely to misuse system resources.

Standard VMS access controls are good, but as many companies and government sites are finding out, they are not enough. ClydeSENTRY utilizes all VMS user, password and privilege functions and improves the system with powerful access controls, monitoring and reporting features.

With unique ClydeSENTRY access controls, you get dial-up port protection to thwart the most publicized of threats—the external hacker and thief.

And to protect the unattended, logged-in terminal, ClydeSENTRY lets you lock your keyboard and blank the screen with a single keystroke. You can run a quick errand while your process continues undisturbed, safe from passers-by—or the keyboard can be locked automatically after a prescribed period of inactivity.

In addition, you get a powerful multi-level menu feature that restricts access to the system by keeping user activity to the domain of defined functions.

With authorized users accounting for the majority of computer losses, access controls alone are not enough. ClydeSENTRY gives you thorough monitoring and reporting controls for effective deterrence and accountability.

ClydeSENTRY lets you observe, document and interact with any terminal on your system, or any remote operations over the network. You can use this feature for real-time monitoring of internal saboteurs or for training, trouble-shooting and user support.

When you use ClydeSENTRY, you can maintain a record of all input and output activity on your system to identify and prove intentional theft, or to record program bugs or operator mistakes so errors can be easily identified and corrected. With complete I/O activity documented, a problem can be detailed and a report generated as to when and how long events occurred, as well as the extent of any resulting damage.

You'll find that even when you are monitoring the entire system, the CPU burden is less than 3%, and typically, full implementation is transparent to users and requires no additional equipment or personnel.

In the real world, no security system is perfect. ClydeSENTRY computer security software comes as close as practically possible. Call Clyde Digital Systems now to help prevent the attacks on your proprietary information and to keep your private files private.

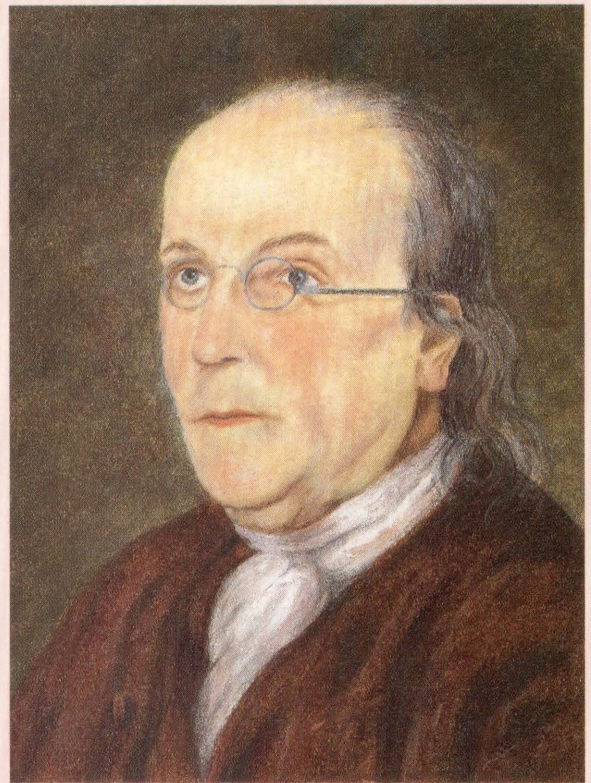

Computer System Security Features Analysis		
	VMS Access Controls	ClydeSENTRY with VMS
<b>ACCESS CONTROLS</b>		
File Protection	<input type="checkbox"/>	<input checked="" type="checkbox"/>
Access Control Lists	<input type="checkbox"/>	<input checked="" type="checkbox"/>
Password Protection	<input type="checkbox"/>	<input checked="" type="checkbox"/>
Alarms	<input type="checkbox"/>	<input checked="" type="checkbox"/>
Dial-up Port Protection	<input type="checkbox"/>	<input checked="" type="checkbox"/>
Unattended Terminal Protection	<input type="checkbox"/>	<input checked="" type="checkbox"/>
Restriction on Privileged Activities	<input type="checkbox"/>	<input checked="" type="checkbox"/>
<b>MONITORING CONTROLS</b>		
Privilege Levels	<input type="checkbox"/>	<input checked="" type="checkbox"/>
Accounting Logs	<input type="checkbox"/>	<input checked="" type="checkbox"/>
Continuous, Tamper-Proof Monitoring	<input type="checkbox"/>	<input checked="" type="checkbox"/>
Archival of Security Data	<input type="checkbox"/>	<input checked="" type="checkbox"/>
Real-time Terminal Monitoring	<input type="checkbox"/>	<input checked="" type="checkbox"/>
<b>ANALYSIS AND REPORTS</b>		
Detailed Analysis of Audit Data	<input type="checkbox"/>	<input checked="" type="checkbox"/>
Security Report Generation	<input type="checkbox"/>	<input checked="" type="checkbox"/>



**Clyde Digital Systems**  
371 East 800 South  
Orem, UT 84058  
(801) 224-5308

CIRCLE 106 ON READER CARD

# Classic Software for Yesterday, Today & Tomorrow

25,000  
INSTALLATIONS  
WORLDWIDE

**1975**  
MCBA introduces  
the first packaged  
accounting software  
in DIBOL® for the  
PDP™-11.

**1983**  
MCBA releases its  
first accounting  
software packages  
for the VAX.

**1988**  
MCBA completes  
18-package  
MRP II system  
for VAX VMS.

1988

MCBA has been setting standards of quality and reliability in business software since the early days of the minicomputer. Computers have come a long way since 1975 and MCBA has been right there every step of the way. Continually enhancing and expanding its top-notch business software systems to meet users' changing needs.

MCBA's proven accounting, distribution and manufacturing software for the VAX and PDP-11 can help you increase productivity, save time and money, and manage your tomorrows.

Find out more about MCBA Classic Software™. Complete and return the coupon below or call the MCBA office nearest you. Because your company deserves a *classic*.

(Reseller inquiries are invited.)

Send me info on MCBA Classic Software in:

VAX COBOL;  DIBOL for VAX or PDP-11.

Accounting/Distribution;  Manufacturing.

Name \_\_\_\_\_

Title \_\_\_\_\_

Company \_\_\_\_\_

Address \_\_\_\_\_

City \_\_\_\_\_ State \_\_\_\_\_ ZIP \_\_\_\_\_

Phone (\_\_\_\_) \_\_\_\_\_ Best time to call \_\_\_\_\_

I am a software:  User;  Reseller;  Consultant (only).

Mail to MCBA Headquarters \*

DP1188

## MCBA® CLASSIC SOFTWARE™

*The Standard in Business Software Solutions™*

\* Headquarters: 425 W. Broadway, Glendale, CA 91204-1269. (818) 242-9600

Branch Office: 120 Wood Ave. S., Suite 300, Iselin, NJ 08830-2709. (201) 548-6600

(Serving AL, CT, DC, DE, FL, GA, MA, MD, ME, MS, NC, NH, NJ, NY, PA, RI, SC, TN, VA, VT, Caribbean, West Indies, and Europe)

Copyright ©1988 by MCBA, Inc. All rights reserved. MCBA is a registered trademark and MCBA Classic Software and The Standard in Business Software Solutions are trademarks of MCBA, Inc. DIBOL is a registered trademark and VAX and PDP are trademarks of Digital Equipment Corporation.

CIRCLE 237 ON READER CARD

The powers that be on the new power in VAX<sup>®</sup> software.



*VAX is a registered trademark of the Digital Equipment Corporation. IDMS/SQL and KnowledgeBUILD are trademarks of Cullinet Software, Inc.*

The power to make or break products in the computer industry begins with a few powerful people. Consultants. And analysts. When they talk, we listen.

*On IDMS/SQL:* "Cullinet has delivered as promised—a relational database management system for the DEC VAX with superior performance, reliability and security."

—Charlotte Walker

*On KnowledgeBUILD:* "What vendors offer in the way of development tools, is in my mind, an increasingly important distinction. Cullinet is in the front of the pack on performance, but it's the power and sophistication of their KnowledgeBUILD toolset that gives them the edge for tomorrow."

—Michael Braude

*On VAX and mainframe connectivity:* "A clear demonstration that Cullinet now offers not only a powerful database and a rich development environment for the VAX, but also an architecture that permits a simple transparent exchange of data between a mainframe and VAX."

—Charlotte Walker

*On the future:* "Cullinet has given us a good example of strategic product development. I expect they will shortly evolve this architecture to the point where it is CPU independent. And they will be able to port it from the VAX to any other platform with full power and functionality intact."

—Michael Braude

In the race for greater performance and productivity, you can't afford to settle for less for your VAX than the most powerful database and tools available: IDMS/SQL and KnowledgeBUILD.

Faster than the competition. Able to build on each other without compromising efficiency or flexibility. Giving you a product you can build on. And on. And on.

Just ask the most powerful people in the business.

Or write Cullinet Software, Inc.,  
Marketing Services, 400 Blue Hill Drive,  
Westwood, MA 02090-2198.

*Call Cullinet today about an IDMS/SQL  
Seminar near you. 1-800-551-4555.*

*Charlotte Walker, V.P., County NatWest  
Securities, U.S.A.*

*H. Michael Braude, V.P. and Director,  
Software Management Strategies,  
Gartner Group, Inc.*

**Cullinet®**  
The power to build on.

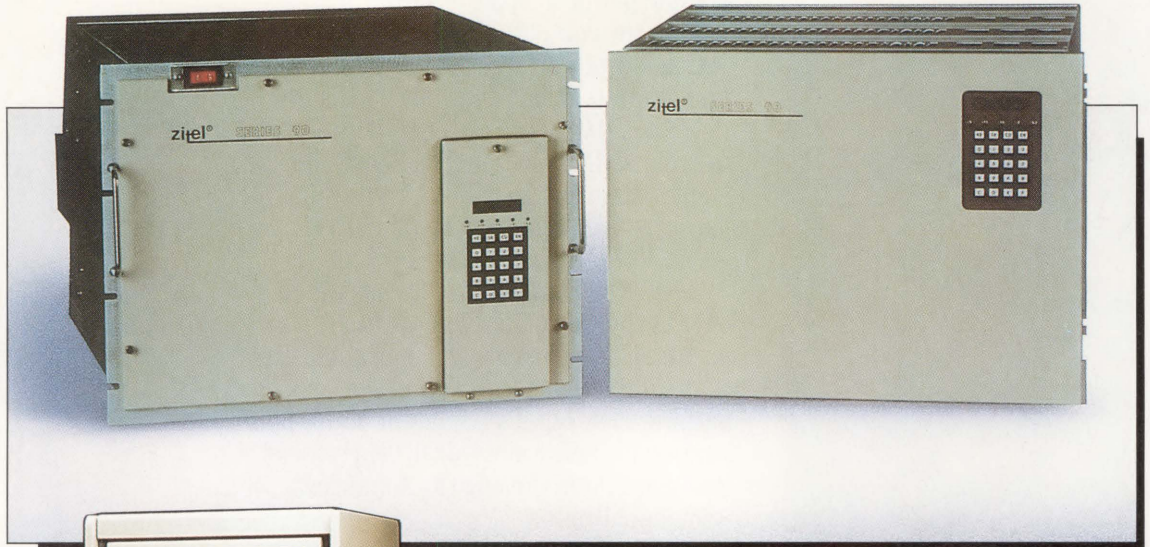

*In the past 18 months, the disk storage market has seen a number of technological changes. As market demand for improved price/performance increases, disk subsystems get bigger, faster and better. Such products include Zitel's Series 90 Solid State Disk Subsystems (top), Emulex's SMDI array (left) and MTT's MDI-476 array (bottom).*

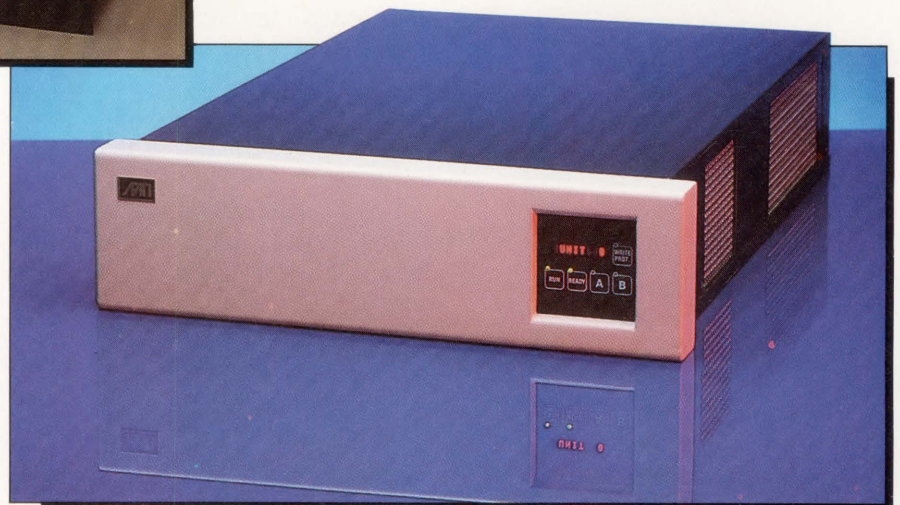



# TRENDS IN DISK STORAGE

ANALYZING THE UPHEAVAL in the disk storage market.

BY DAVID W. BYNON AND PHILIP A. NAECKER

EVERY FEW MONTHS, it seems, there's a breakthrough in disk storage technology. These improvements are driven by an insatiable market demand for improved price/performance in disk subsystems.

That demand is being satisfied by both evolutionary and revolutionary changes in disk technology. Disks are getting faster, better and bigger. The last 18 months have seen dramatic changes in how users, manufacturers and those in between deal with the constant changes in technology. These changes will have a major impact on the way

users configure their systems and on their choice of a supplier for disk subsystems.

## What's Different?

A number of technological changes are sweeping the disk market. However, the following three non-technological changes are the most important to those buying and selling disks:

1. The life cycle for a generation of disk subsystem hardware is down to about 18 months.
2. The DSA interface and MSCP disk class driver do their jobs so well that

connecting non-DEC disks to a VAX is a reasonably risk-free proposition.

3. The disk's contribution to the cost of the entire subsystem has dropped from over 75 percent to under 50 percent.

These changes, and not the changes in technology, are turning the disk market upside down.

## Time Flies

The time between new generations of disk technology has shrunk dramatically. Some vendors believe the time between new generations is as short as 12 to 15 months. "We see an 18-month

period between new disk generations," says Ron Browning, director of storage and communications marketing at Emulex Corporation of Costa Mesa, California. This is both good and bad for users.

On the one hand, if you can't afford the disks you need now, just wait a few months. The next generation of technology will drive those costs down dramatically, or improve the disk's performance.

On the other hand, buyers of disks must be considerably more attentive to the overall engineering and architectural quality of the disk subsystems they buy. For most users, it's no longer practical to make a purchase as a point solution in time. Instead, the smart buyer purchases flexibility, adaptability and configurability.

A few years ago, a data center manager might choose a disk subsystem technology and make several years' purchases based on that choice. To some extent, this is the approach promoted by DEC.

For example, a manager who five years ago chose DEC's RA81 and HSCs, until recently probably was purchasing DEC RA82s with essentially the same technological base as his earlier purchase. Although the RA90 has a considerably more advanced HDA than its predecessors, the basic relationship among drives, controllers and CPUs is the same.

What's kept the data center manager in the DEC groove is the knowledge that a sure way to disrupt a good operation is to change several things at once. To change from DEC's disk implementation would mean that several things might have to change, requiring:

1. A move away from the HSC — The new disks might not connect to the HSC using DEC's interfaces. That would mean loss of availability and possibly loss of performance, because the disks would have to be connected to a particular machine. Most system managers like clusters, and any change that bucks the cluster won't be well-received.

## The Solid-State Disk Comes Of Age

Has the solid-state disk finally come of age? Many disk system specialists, such as System Industries, Zitel and Memory Sciences, think so. Although the price of DRAM has skyrocketed in the past months, industry experts agree that the market is ready for these superfast storage devices.

Solid-state disks are semiconductor devices used in place of a rotating magnetic disk drive. They benefit a computer system primarily through speed: the difference in access time between solid-state memory and rotating memory is five orders of magnitude. Average access times of .005 ms and effective continuous transfer rates of 5 MB per second for these devices are common.

The typical market for the solid-state disk has been the technical and scientific community and, more recently, large MIS/DP departments like those in banks and insurance companies. As production of these devices increases and the price of DRAM comes down, however, solid-state disks will become a reality for the typical user.

Most solid-state disk manufacturers design intelligent devices that connect to a high-speed bus interface, such as a DR11-W. These designs provide superior performance, but they often require a special disk driver for each system implementation. This can be troublesome for the non-technical user when it comes to installation and operating system upgrades.

In an attempt to standardize, some designers are developing solid-state disks as "plug and play" units that emulate a standard disk. This is important in the VAX arena, where MSCP protocol emulation is a must if the device is to be used in a VAXCLUSTER.

As semiconductor device-mounting technology improves, we'll see solid-state disks packaged in standard 5/4-inch or 8-inch form factors. These devices will interface with standard host adapters, such as ESDI, SMD or SCSI controllers. Nickel cadmium batteries will be used to retain the stored information when the system is shut down or when the device is removed.

To provide improved performance and to offset the cost of ownership, some OEMs soon may package 64-MB to 256-MB solid-state disks as part of a large-capacity storage system. The solid-state disk can be used for a high-speed page file to improve overall system performance or to manage a specific application where access to numerous small files is crucial to system performance.

As high-capacity disks fall prey to the commodity market, due to fierce competition between disk manufacturers, OEMs will market solid-state disks to bolster their profit margins. For the user, it's a win/win situation. You'll get better performance or more magnetic disk storage for your dollar.

2. A new controller, one that would work only on a particular bus — Even if there were other controllers to work with the disk on other buses, the controller would have to change when the machine changed.
3. A change in software, if the disk implementation required a new disk port driver or a new class driver.
4. A loss of interchangeability — It's much harder to manage a disk farm in which there are several sizes and types of disks than one in which all the disks are similar in capacity, cabling, power requirements, racking and other characteristics.

Data center managers want the disk subsystem to integrate well with the DEC storage architecture, to preserve their options for growth and, most important, not to cause problems. They want a disk subsystem that works now and that will work tomorrow, no matter what DEC does in the software or disk subsystem hardware. Yet they also want to take advantage of that 18-month life cycle for new disk technology.

Of course, not every data center manager is locked into DEC's disk storage strategy. Many need the extra performance or price/capacity or capac-

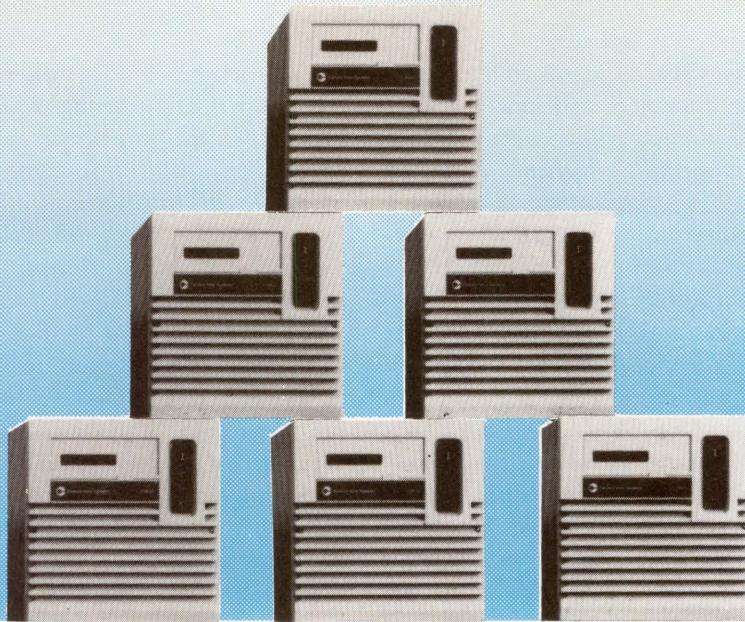

# How about a SIX PAC to go?

	DEC RA81	CDS DS2600	CDS DS2800	CDS DS21200	CDS DS21500
Disk Diameter (in.)	14	8	8	8	8
Physical Package	full-rack	half-rack	half-rack	half-rack	half-rack
Capacity (Formatted) per HDA (MBytes)	456	451	625	900	1,125
Data Transfer Rate (MB/sec)	2.200	1.813	2.458	2.458	2.458
Access Time					
Average Seek (msec)	28	15	15	18	18
Track to Track (msec)	6.0	3.5	3.5	3.5	3.5
List Prices	\$17,790	\$14,000	\$15,900	\$17,550	\$19,500

Average Latency (msec): 8.33 all drives

**FREE**  
Delivery  
Installation  
DEC® Compatible Cabinet  
30 Day Trial  
1 yr. On Site Maintenance

\* Call for complete details and restrictions  
Prices and specifications are subject to change.

## Key Features

- Plug-compatible with DEC disk drive controllers:
  - UNIBUS UDA50
  - Q-Bus KDA50
  - VAXBI KDB50
  - Cluster Controller HSC50/70
- 8-inch half-rack package

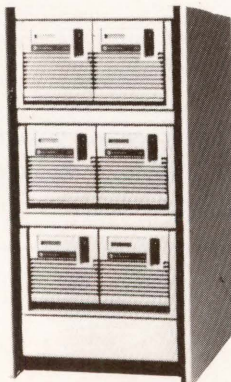

- 15 to 18 msec average seek time
- Data transfer rate up to 2.5 MB/sec
- Up to 1.5 gigabyte capacity per drive
- Up to 12 gigabytes in a single cabinet, 8 drive configuration

**C ENTERPRISES**  
12800 Garden Grove Blvd., Suite E  
Garden Grove, CA 92643  
**(714) 530-3890**

CIRCLE 344 ON READER CARD

ity/footprint edge that alternatives provide. Others simply don't have a need for the HSC-based clusters. But DEC still owns approximately 80 percent of the DEC disk market.

Thus, the clock to some extent has stood still. New disk developments have bypassed many VAX sites, as many sites have opted for stability.

**Stability And Change**

How is it now possible for a disk subsystem buyer to have both stability and change? Disk subsystem manufacturers build the systems that cautious data center managers want, rather than packaging technology into a new disk drive. They accomplish this by "buying into" standards at one or more critical points in the disk subsystem, depending on the exact balance between the need for stability and the need for change.

By making DSA-compatible drive subsystems, manufacturers have usurped DEC's ownership of the DSA standard. Few manufacturers, other than DEC, make DSA-compatible drives, but many subsystem manufacturers make DSA-compatible interfaces that translate from a DSA interface (like that coming out of an HSC) to any of the industry-standard interfaces, (see Figure).

By using MSCP-compatible controllers, manufacturers can make almost any drive appear to the VAX as an RA81. MSCP-compatible controllers are available from a number of manufacturers for Q-bus, UNIBUS and BI-bus machines and can provide interfaces to ESDI, SCSI or SMD disks.

The new drive-to-controller interfaces are more robust, allowing for automatic recognition of the disk geometry by the controller, automatic bad-block revectoring without any equipment other than the controller itself, on-board formatting and similar powerful features. Drives and controllers that adhere to the same standard can "plug and play."

Disk buyers always have been able to plug non-DEC drives into their VAXs and make them work. However, as a result of the improved and more stan-

dardized interfaces, the risks associated with this approach are far lower than they were and the price benefits are far higher.

**Prices**

One of the biggest impacts on the price of disk subsystems has been the arrival of commodity-priced markets to a range of types and sizes of disks. Commodity items, for example a barrel of crude oil or a 256-Kbit DRAM, are items with essentially identical characteristics that are available in quantity from several sources.

Prices of commodity items from different sources tend to be similar, as

each manufacturer streamlines manufacturing and delivery and each jockey for position in the market. Until several years ago, there were too many differences in performance and reliability of VAX disks for a commodity market to develop.

Beginning perhaps with the arrival of the Fuji Eagle, commodity markets began to emerge in the VAX disk market. In the last 18 months, the 5/4-inch ESDI 380-MB and 760-MB drives have reached commodity status. Prices have been halved and nearly identical drives are available from several sources.

An interesting result of the manufacturers' cost-competitiveness is almost

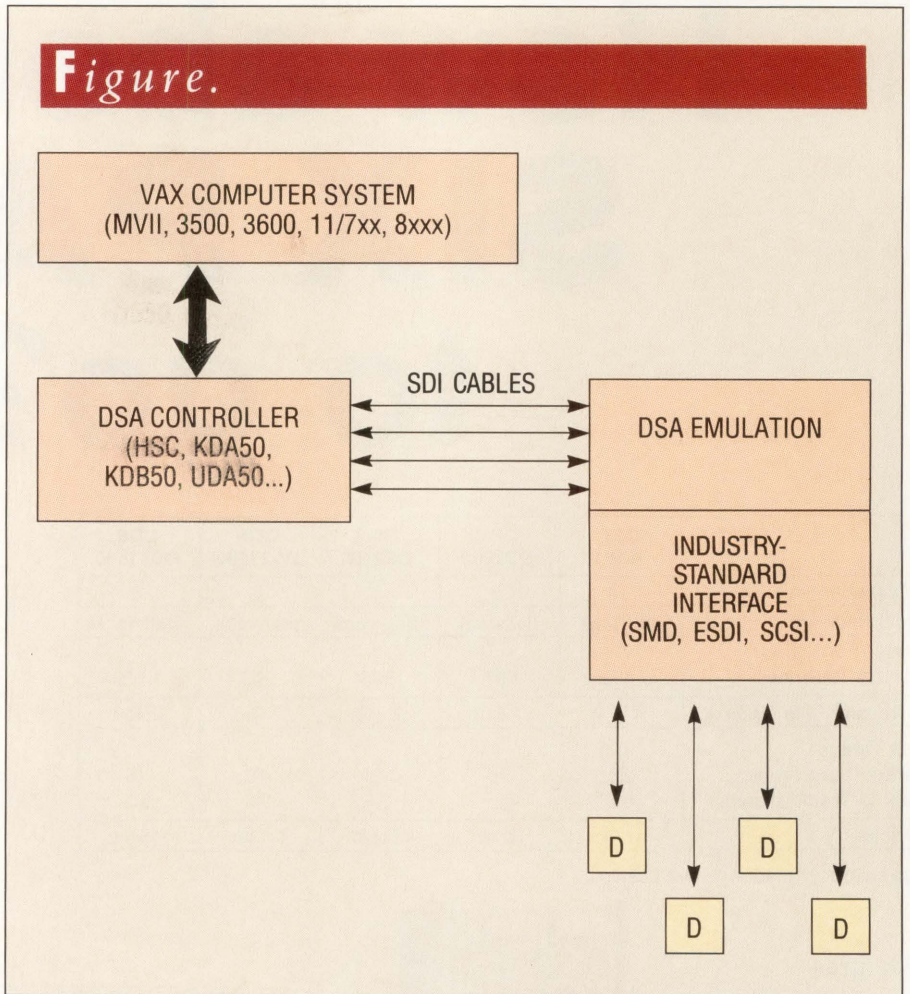

*Third-party disk subsystem manufacturers connect to DEC systems with intelligent controllers. The controllers present a DSA device to the DEC host adapter, while providing an industry-standard interface for the drives.*

## Assessing Arrays

Today's larger disk drives have over 1 GB of formatted storage capacity. It's expected that even the 5¼-inch drives soon will have over 1 GB.

Even so, many sites want more capacity per drive. There could be many reasons for this, including large storage requirements (more than two HSCs in a VAXCLUSTER can support the use of subgigabyte disks), a need to conserve floor space or a limited number of controller or HSC ports.

One solution to the need for larger drives is disk arrays: multiple drives that appear to the CPU as a single, large drive. There are various implementations of this approach, ranging from the simple to the sophisticated.

In the simplest case, two or more disks are managed by the same controller, such that the first disk supplies one group of tracks, and subsequent disks each provide another group of tracks. This works well in some cases.

Unfortunately, performance may become a problem unless the seek ordering algorithm on the controller can keep track of the rotational position for each drive separately. This is possible when the controller that's positioning the heads is also the one doing the seek ordering, as when the controller is doing MSCP emulation on the bus.

However, if the controller is doing DSA emulation and another controller device, the HSC, is doing the seek ordering, suddenly the HSC's seek ordering algorithm becomes incorrect. Part of this problem is that the HSC doesn't know about the extra disks. It has only one rotational position for the entire bank of drives, because to the HSC there's only one disk and thus only one rotational position. If the drives aren't in rotational sync, the HSC's seek ordering algorithm will hurt performance as it forces the drive array to wait for data that appears to the HSC to be close but rotationally is distant.

One clever solution to this problem provides a microprocessor that will synchronize the rotational position of multiple drives. Once the drives are synchronized, the seek ordering algorithms can do a much better job.

Parity arrays also promise improved performance and maintainability. Parity arrays promise fantastic reliability characteristics, with approximately 100,000 hours MTBF. This is at least three times the MTBF of the individual drives. And because there are only 8,760 hours in a year, the parity arrays are essentially failure free.

In parity arrays, several drives are operated in rotational synch, but instead of dividing the tracks among the drives, each byte is multiplexed, bit-wise, across multiple drives. Additional drives add parity and ECC bits, as in parity and ECC memory, and the additional bits are used to correct errors in the data. If a drive starts to fail, the controller can detect that the ECC algorithm is being used to correct the error and it can pinpoint the problem drive.

That drive then can be removed from the array while the rest of the drives continue to operate. A replacement drive is installed, and the controller begins to reconstruct the ECC data on the new drive in the background. Further, because the replacement drive would likely be the same 5¼-inch ESDI or SCSI drive used throughout the data center and on workstations, it's reasonable to expect that a drive or two would be stored in the spares closet.

In addition to their great reliability, parity arrays have fantastic transfer rates. Because the transfer rate typically is limited by the capability of the drive itself, not the controller, working 10 drives in parallel means that the transfer rate — the time it takes to transfer the data from the drive to the CPU — approaches 10 times that of the individual drives.

Because there are 10 drives acting as a single, large drive, the drive array provides very large storage capacity. Using 760-MB ESDI drives, for example, a parity array can deliver a single logical drive with over 5 GB of useful storage.

identical prices for very different drives. Tom Raimondi, director of marketing at MTI of Placentia, California, believes that a large-volume buyer of drives will see less than a 25 percent difference in price between a 380-MB and 760-MB

BY MAKING DSA-compatible drive subsystems, manufacturers have usurped DEC's ownership of the DSA standard.

drive. The same trend can be found in other areas of the drive market.

A more important effect of competitive pricing is that the disk drive has become a relatively less important component of the disk subsystem. Some manufacturers of subsystems claim that the drive's contribution to a typical subsystem's cost has fallen from over 70 percent two years ago to less than 50 percent today.

This means that you can buy more, bigger, faster and better disks for the same amount of money. It also means that you're no longer buying disk drives as much as you're buying the other components of a drive subsystem, such as packaging, power supplies and controller electronics.

Within a year, the electronics of a typical subsystem may cost more than the drive. Future buying decisions probably will be less dominated by disk performance statistics, such as transfer rate and average access time (not to mention the already esoteric measures of track density and bpi), and more influenced by controller capabilities.

On the controller technology front,

plenty is happening. A controller might perform only the traditional tasks of head positioning and data transfer, or it might include features for bad-block revectoring, on-board formatting, merging data from multiple disks, diagnostics, conversion between different interface standards and sophisticated HSC-like storage controller functions. Here are some of the controller features that are emerging or have become common:

1. Cache — Because VMS doesn't cache raw disk blocks, many manufacturers achieve substantial performance improvements by putting a cache on the controller. One megabyte is common, and some are larger.

2. Multiple physical drives per logical drive — There are several variations on this theme, the simplest of which presents the tracks on second and subsequent drives as an extension of the tracks on the first drive. This approach allows more storage per controller port (a big savings if the controller is an HSC). It also may provide performance improvements.

More powerful implementations may include parity arrays, where the bits in each byte are multiplexed across five to 10 drives. One or two drives in the array provide error correction or parity bits, like the bits in ECC memory. If a drive fails or a bad spot begins to develop, the drive can be removed from the array and the ECC algorithm will make up the missing bits. Special controller firmware then can begin the rebuild of the ECC bits on a replacement drive.

3. Many more drives per controller — Current implementations of ESDI and SCSI limit the number of devices. Upcoming implementations, especially the new SCSI standard, will allow hundreds of drives per controller, further leveraging the cost of the controller over many drives.

4. Mixed rotating disk and semiconductor disk — More a storage controller than just a disk controller, such a device would support both traditional disks and semiconductor disks simultane-

## Transfer Rate Or Access Time?

There are two commonly used measures of disk performance: transfer rate (the number of megabytes per second) and average access time (the time it takes for the disk subsystem to start to return the data you want).

In the VAX environment, average access time is the name of the performance game. Because VAX disk access, especially database access, typically is made up of relatively large numbers of small data transfers, the trick is to minimize the amount of time the VAX spends waiting for the disk to rotate to position and for the heads to seek to the proper track. These two numbers, rotational latency and average seek time, combine to make up the average disk access time.

It's a bit more complicated than just adding the two numbers, though. Because the disk is rotating at the same time the heads are seeking, there's some statistical overlap. Further, you need to include any controller overhead in the access time as well. This yields a number that can be called disk subsystem average access time.

In a typical VAX environment, raw data transfer rate isn't likely to be a problem. Unless your site is doing image processing or some other heavy-duty application, most VMS disk transfers are small and any transfer time differences between medium-speed and high-speed interfaces are more than washed out by differences in average access time.

Medium-speed interfaces, such as ESDI and SCSI, can sustain under 2 MB per second, while higher-speed interfaces, such as SMD, can top 3 MB per second. The difference isn't so much the interface as the drives, as most SMD drives can keep up with the 3 MB per second rate of their controller while most ESDI and SCSI drives lag at under 1 MB per second. By way of comparison, the DEC KDB-50 DSA disk interface for the BI-bus can achieve less than 1 MB per second at the controller interface.

Because most VAX transfers are less than 64 KB, transfer time is a small component of the total disk operation elapsed time when compared to average access times in the 18- to 32-ms range. And because there are faster ESDI and SCSI interfaces emerging, it's likely that small disk interfaces will be tough competition for traditional interfaces such as SMD and its variants.

Further, arrays of ESDI or SCSI disks, especially parity arrays, perform their data transfers in parallel. Thus, an array with eight disks can achieve a theoretical transfer rate of eight times the disk transfer rate or the controller transfer rate, whichever is slower. This number could be several times the speed of the fastest single drive available.

ously. It might use the semiconductor disk as a large cache for the rotating disk, or support it as a separate device.

### Spindles

It might appear that disk buyers will ignore the characteristics of drives in the future, but that isn't likely. There's much happening in drives that's going to keep choices open.

Nearly everyone by now is familiar with the form-factor race. If, 18 months ago, you wanted high performance, reliability and high capacity per cubic foot, you probably shopped for 9- or 14-inch drives. Today, you probably shop for 8- or 5¼-inch drives.

There are several forces pushing the

drives toward smaller packages, including the larger demand for smaller drives created by the large numbers of workstations now shipping. Although the 8-inch drives have larger capacity, over 1 GB, the 5¼-inch drives aren't far behind at 760 MB.

Many in the industry believe that the 8-inch drive will continue to dominate high-end applications for at least a few more years, but eventually will be replaced by smaller drives. From a system integrator's point of view, there may be a substantial difference between an 8-inch drive and a 5¼-inch drive.

"An 8-inch drive comes from the drive manufacturer already packaged, integrated and tested with power supply

# Prescription for POSTSCRIPT

Patient \_\_\_\_\_ Date \_\_\_\_\_  
Address \_\_\_\_\_  
R *TurboLaser PS-PLUS 3  
Printer with DEC LNO3,  
HP LaserJet Plus, and  
Diablo 630ECS emulations.*  
Refill  NR  1  2  3  4  5  PRN   
DEA No. \_\_\_\_\_ Dr. \_\_\_\_\_  
Address \_\_\_\_\_ Telephone \_\_\_\_\_  
Dispense as written  Submitted  2546

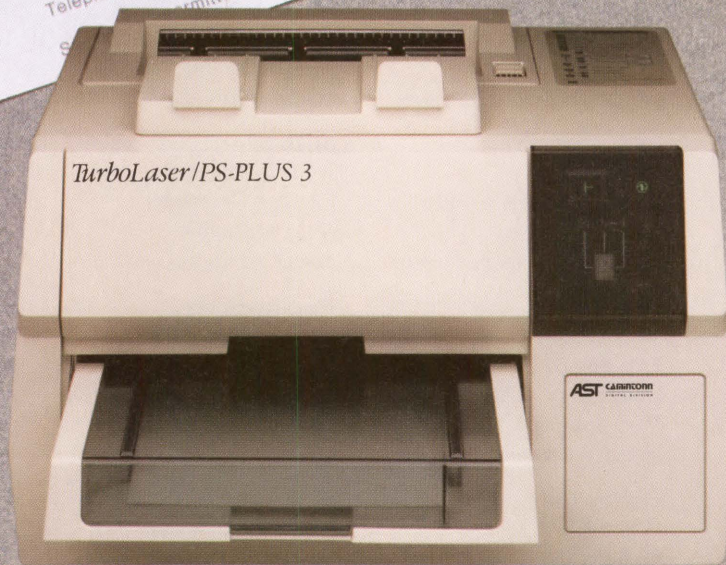

You love the desktop publishing capabilities that Adobe originally gave to the "MAC User", but you have other systems and applications for simple word processing or text-only output, and you don't know which laser printer to buy? Feel like indigestion?

All your users want to access the printer, but the software filter for translating LNO3 files limits the usage of your DECnet configuration, so now everyone wants their own laser printer. What a headache!

Many of your users will have HP LaserJet and Diablo 630ECS files to print. They're also thinking of occasionally printing some special graphics with their text, but aren't quite ready for desktop publishing.

Could this be the beginning of an ulcer?

AST Camintonn has the prescription for your printing ills. We start with Adobe's most recent version of PostScript with 35 resident type fonts, 3MB of RAM, and the fastest processor available.

The *TurboLaser/PS-PLUS 3* provides the correct dosage of hardware to perfectly emulate DEC LNO3, HP LaserJet Plus, and Diablo 630ECS. To make printer mode selections easier, we've given you the choice of software

commands or an external switch. Combine it all with not only RS232, Centronics, and AppleTalk interfaces, but with Data Products connections as well, and you're halfway to healthy again.

Just in case you need to treat high volume paper demands, AST Camintonn offers an optional 1,000 page sheet feeder.

AST Camintonn eliminates all the aches and pains associated with buying the right laser printer. And, our emergency room staff of application support personnel is standing by to answer any questions you may have to ease post-purchase syndrome.

Take to the *TurboLaser/PS-PLUS 3*, and call us in the morning!

**CALL 1-(800)-843-8336 or (714) 553-0247**

AST, the AST logo, AST Camintonn Digital Division, and AST TurboLaser/PS-PLUS 3 are registered trademarks of AST Research, Inc. PostScript is registered and Adobe is a trademark of Adobe Systems, Inc. Apple and AppleTalk are registered and Macintosh is a trademark of Apple Computer. Diablo trademarks Diablo. DEC is a trademark of Digital Equipment Corporation. HP LaserJet is a trademark of Hewlett-Packard. Copyright 1988 by AST Research, Inc. All rights reserved.



From the company who has been diagnosing and correcting your DEC computer memory and communications needs for years.

**AST CAMINTONN**  
DIGITAL DIVISION  
2121 Alton Ave., Irvine, CA 92714

# MASS STORAGE

## Suppliers Of Mass Storage Devices

Advanced Digital Information Corp.  
(ADIC)  
P.O. Box 2996  
Redmond, WA 98073  
(206) 881-8004  
CIRCLE 367 ON READER CARD

Alpha Data Inc.  
20750 Marilla St.  
Chatsworth, CA 91311  
(818) 882-6500  
CIRCLE 368 ON READER CARD

American Digital Systems Inc.  
75 Union Ave.  
Sudbury, MA 01776  
(617) 443-7711  
CIRCLE 521 ON READER CARD

Aviv Corp.  
26 Cummings Park  
Woburn, MA 01801  
(617) 933-1165  
CIRCLE 580 ON READER CARD

Brainwave Systems Inc.  
P.O. Box 1043  
Broomfield, CO 80020  
(303) 466-6190  
CIRCLE 482 ON READER CARD

Cipher Data Products Inc.  
9715 Business Park Ave.  
P.O. Box 85170  
San Diego, CA 92138  
(619) 578-9100  
CIRCLE 369 ON READER CARD

CMD Technology Inc.  
3851 S. Main St.  
Santa Ana, CA 92707  
(714) 549-4422  
CIRCLE 370 ON READER CARD

Control Data Corp.  
8100 34th Ave. S.  
Minneapolis, MN 55440  
(612) 851-4131  
CIRCLE 415 ON READER CARD

Dataram Inc.  
P.O. Box 7528  
Princeton, NJ 08543  
(609) 799-0071  
CIRCLE 371 ON READER CARD

Digi-Data Corp.  
8580 Dorsey Run Rd.  
Jessup, MD 20794  
(301) 498-0200  
CIRCLE 372 ON READER CARD

Digital Equipment Corp.  
146 Main St.  
Maynard, MA 01754  
(617) 897-5111  
CIRCLE 400 ON READER CARD

Dilog  
1555 S. Sinclair  
P.O. Box 6270  
Anaheim, CA 92806  
(714) 937-5700  
CIRCLE 394 ON READER CARD

EMC Corp.  
171 South St.  
Hopkinton, MA 01748  
(617) 435-1000  
CIRCLE 447 ON READER CARD

Emulex Corp.  
3545 Harbor Blvd.  
P.O. Box 6725  
Costa Mesa, CA 92626  
(714) 662-5600  
CIRCLE 403 ON READER CARD

Exabyte Corp.  
1745 38th St.  
Boulder, CO 80301  
(303) 442-4333  
CIRCLE 374 ON READER CARD

Fujitsu America Inc.  
3055 Orchard Dr.  
San Jose, CA 95134-2017  
(408) 432-1300  
CIRCLE 475 ON READER CARD

Genisco Peripheral Systems  
10874 Hope St.  
Cypress, CA 90630  
(714) 220-0720  
CIRCLE 375 ON READER CARD

Imperial Technology Inc.  
831 S. Douglass St., Ste. 102  
El Segundo, CA 90245  
(213) 536-0018  
CIRCLE 377 ON READER CARD

Innovative Data Technology  
5340 Eastgate Mall  
San Diego, CA 92121  
(619) 587-0555  
CIRCLE 378 ON READER CARD

Lanex Corp.  
10727 Tucker St.  
Beltsville, MD 20705  
(301) 595-4700  
CIRCLE 379 ON READER CARD

Masstor Systems Corp.  
5200 Great America Pkwy.  
P.O. Box 58017  
Santa Clara, CA 95052  
(408) 988-1008  
CIRCLE 380 ON READER CARD

MAXTOR Corp.  
211 River Oaks Pkwy.  
San Jose, CA 95134  
(408) 432-1700  
CIRCLE 381 ON READER CARD

MDB Systems Inc.  
1110 W. Taft Ave.  
Orange, CA 92665  
(714) 998-6900  
CIRCLE 382 ON READER CARD

Megatape Corp.  
1041 Hamilton Rd.  
P.O. Box 317  
Duarte, CA 91010  
(818) 357-9921  
CIRCLE 383 ON READER CARD

Memory Sciences Corp.  
9028 Prince William St.  
Manassas, VA 22110  
(703) 361-9745  
CIRCLE 439 ON READER CARD

Micro Technology Inc. (MTI)  
1620 Miraloma Ave.  
Placentia, CA 92670  
(714) 632-7580  
CIRCLE 438 ON READER CARD

MITRON Systems Corp.  
2000 Century Plaza  
Columbia, MD 21044  
(301) 992-7700  
CIRCLE 384 ON READER CARD

PMC Associates Inc.  
74 N. Central Ave.  
P.O. Box 32  
Ramsey, NJ 07446  
(201) 934-1835  
CIRCLE 385 ON READER CARD

Qualogy Inc.  
1751 McCarthy Blvd.  
Milpitas, CA 95035  
(408) 434-5200  
CIRCLE 477 ON READER CARD

Qualstar Corp.  
9621 Irondale Ave.  
Chatsworth, CA 91311  
(818) 882-5822  
CIRCLE 557 ON READER CARD

Recognition Concepts Inc.  
341 Ski Way  
P.O. Box 8510  
Incline Village, NV 89450  
(702) 831-0473  
CIRCLE 386 ON READER CARD

Storage Concepts Inc.  
1622 Deere Ave.  
Irvine, CA 92714  
(714) 852-8511  
CIRCLE 387 ON READER CARD

System Industries  
560 Cottonwood Dr.  
Milpitas, CA 95035  
(408) 432-1212  
CIRCLE 427 ON READER CARD

Telebyte Technology Inc.  
270 E. Pulaski Rd.  
Greenlawn, NY 11740  
(516) 423-3232  
CIRCLE 388 ON READER CARD

Trimarchi Inc.  
139 N. Gill St.  
P.O. Box 560  
State College, PA 16801  
(814) 234-5659  
CIRCLE 389 ON READER CARD

U.S. Design Corp.  
4311 Forbes Blvd.  
Lanham, MD 20706  
(301) 577-2880  
CIRCLE 449 ON READER CARD

Western Dynex Corp.  
3536 W. Osborn Rd.  
Phoenix, AZ 85019  
(602) 269-6401  
CIRCLE 390 ON READER CARD

Winchester Systems Inc.  
400 W. Cummings Park  
Woburn, MA 01801  
(617) 933-8500  
CIRCLE 392 ON READER CARD

Zitel Corp.  
630 Alden Dr.  
Milpitas, CA 95035  
(408) 946-9600  
CIRCLE 440 ON READER CARD

Zoltech Corp.  
7023 Valjean Ave.  
Van Nuys, CA 91406  
(818) 780-1800  
CIRCLE 393 ON READER CARD



and hardware," explains Ron Browning of Emulex. "But a smaller drive typically will require that the system integrator provide power and additional integration before the drive can be used in a subsystem."

DEC has caused the drive race to heat up a bit with its announcement of the RA90, an 8-inch drive. According to some disk subsystem manufacturers, if the RA90 ships by the end of this year in quantity and has the performance characteristics DEC claims, then DEC will be a contender for the lead in disk technology. "The RA90 will be the best drive DEC has built, if it meets specs," says Tom Raimondi. However, DEC hasn't provided any MTBF statistics, so the reliability of the drive is open to question, and DEC's list price of \$23 per MB is higher than the competition's.

Some system managers might wonder how much data they should en-

trust to a single spindle. For starters, by placing an entire group of applications on a single drive, the system manager can create performance conflicts. Performance issues aside, system managers know that no drive is completely trouble free. If you lose 1 GB of data, how do you get it back? The time it takes to restore such a large volume of data from media is considerable, even with fast 125-ips, 6,250-bpi tape drives or the new helical scan videotape drives.

An even more interesting scenario puts a 1-GB-plus drive on a workstation without local backup media. Pushing 1 GB through a remote backup procedure over a WAN might take a little longer than you'd like.

There are also a number of interesting disk technologies emerging, and some that seem stuck. Vertical recording died before it became a reality. Instead, thin-film head and media technology

achieved the increased areal densities once projected for vertical recording.

At least one vendor has announced a magneto-optical recording system, using lasers to heat a spot on the disk through a phase transition, thus making it easier to store data with higher flux densities. For many applications, this extremely dense technology might be very practical. (See "Optical Storage Comes Of Age," page 48.)

THESE DEVELOPMENTS in disk storage are the result of continuing market demand. The last few months have seen many technological advancements, and these have initiated structural changes in the disk storage market. But perhaps the greatest changes we'll see lie in the months ahead.

ARTICLE INTEREST QUOTIENT  
Circle On Reader Card  
High 434 Medium 435 Low 436

# FINALLY! VAX™ FILE MANAGEMENT WITHOUT THE DRUDGERY

## Introducing V\_DIR

The first VMS® utility that lets you

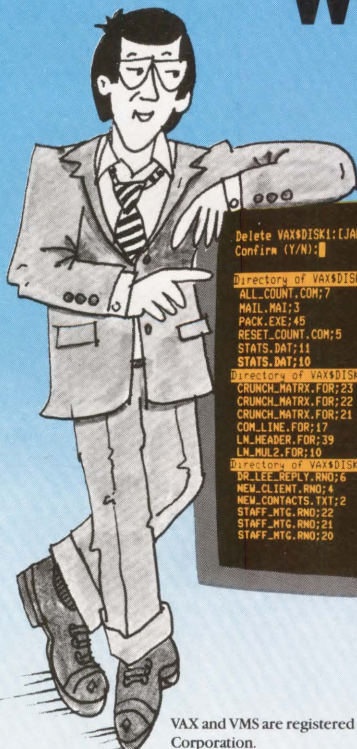

```

Delete VAXDISK1:[JAN.TEMP]STATS.DAT:10
Confirm (Y/N):
Directory of VAXDISK1:[JAN.TEMP]          395 blocks 23 files
ALL_COUNT.COM:7          9  8-APR-1988 13:40 [DEVEL,JAN]
MAIL.MAT:5              23 22-AUG-1988 10:07 [SYSTEM]
PACK.EXE:45            109 10-DEC-1987 14:31 [DEVEL,JAN]
RESET_COUNT.COM:5      15  7-APR-1988  9:22 [DEVEL,JAN]
STATS.DAT:11           21 14-JUL-1988 12:09 [KEY,MGR]
STATS.DAT:10           21 13-JUL-1988 11:46 [KEY,MGR]
Directory of VAXDISK1:[JAN.SOURCE]      1295 blocks 61 files
CRUNCH_MATRX.FOR:23     47 15-SEP-1988 13:01 [DEVEL,JAN]
CRUNCH_MATRX.FOR:22     47 15-SEP-1988 12:43 [DEVEL,JAN]
CRUNCH_MATRX.FOR:21     47 15-SEP-1988 12:21 [DEVEL,JAN]
COM_LINE.FOR:17         20  6-SEP-1988 17:04 [DEVEL,JAN]
LN_HEADER.FOR:39        19  9-SEP-1988 14:08 [DEVEL,JAN]
LN_MUL2.FOR:10          14  7-SEP-1988  9:59 [DEVEL,JAN]
Directory of VAXDISK1:[JAN.CORRESP]     223 blocks 44 files
DR.LEE.REPLY.RND:6      29  9-AUG-1988 11:21 [DEVEL,JAN]
NEW_CLIENT.RND:4        55  1-JUL-1988  9:09 [EMTG,ELN]
NEW_CONTACTS.TXT:2     17  5-AUG-1988 16:15 [EMTG,ELN]
STAFF_MTC.RND:22        28 19-SEP-1988 13:42 [DEVEL,JAN]
STAFF_MTC.RND:21        24 19-SEP-1988 13:35 [DEVEL,JAN]
STAFF_MTC.RND:20        18 19-SEP-1988 10:03 [DEVEL,JAN]
    
```

- Easily Organize Directories
- Copy, Move or Delete Multiple Files
- Edit or View Selected Files
- See Files in Multiple Directories
- Execute DCL Commands

Do all of this **WITHOUT TYPING** a file name or directory name.

Only \$395  
Credit cards accepted.

**TO ORDER**  
CALL: 1-800-343-4300  
ext. 21



**Digi-Com**  
GROUP, INC.

VAX and VMS are registered trademarks of Digital Equipment Corporation.

CIRCLE 328 ON READER CARD



*Injection molding process during the manufacturing of Plasmon Data Systems' WORM disks.*

# Optical Storage Comes Of Age

MAKING STRIDES in storage

technology. BY RON LEVINE

IN EARLY 1987, the few optical disk units in operating environments were for experimentation. Users were discovering how to connect them to their existing systems, programmers were learning how to talk to them, and developers and users were searching for ways to overcome the lack of alterability.

But optical storage and retrieval has been making headway. DEC, IBM and others have announced optical disk units, giving legitimacy to the devices and creating user demand. Hardware and software interfaces that connect the units to standard systems have become available, and erasable optical storage devices, a major breakthrough, have been developed.

Most optical storage devices record

data on a thin film by burning microscopic holes or pits in the film with a laser. A laser device reads the data by interpreting the presence or absence of holes.

Optical storage records and retrieves video, audio and image data as well as text data. All information can be integrated totally: it can be saved and displayed together.

The extremely high-density recording capability of optical devices enables one five-inch optical disk to store an amount of data equal to that contained on 1,000 magnetic floppy disks. A 12-inch optical platter can hold 2 GB of information, which is the amount that can be stored on seven eight-inch hard disks or 60 2,400-foot

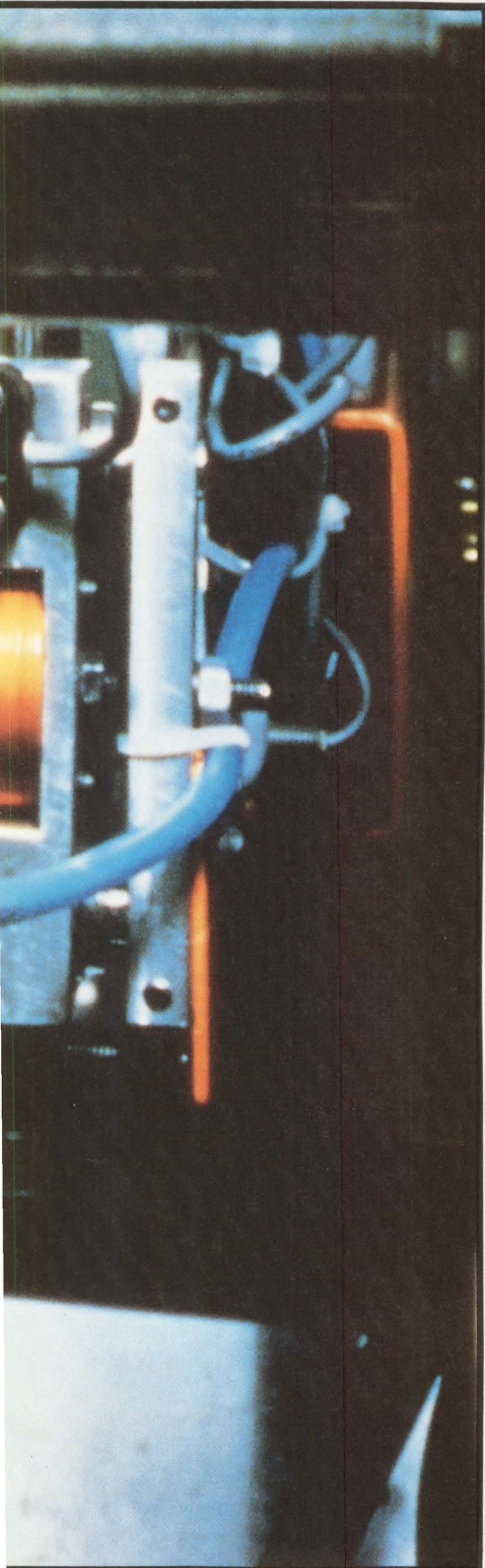

Courtesy Plasmon Data Systems

*Sector assignment of Constant Linear Velocity (CLV) media for Sony 12-inch writable optical disk format.*

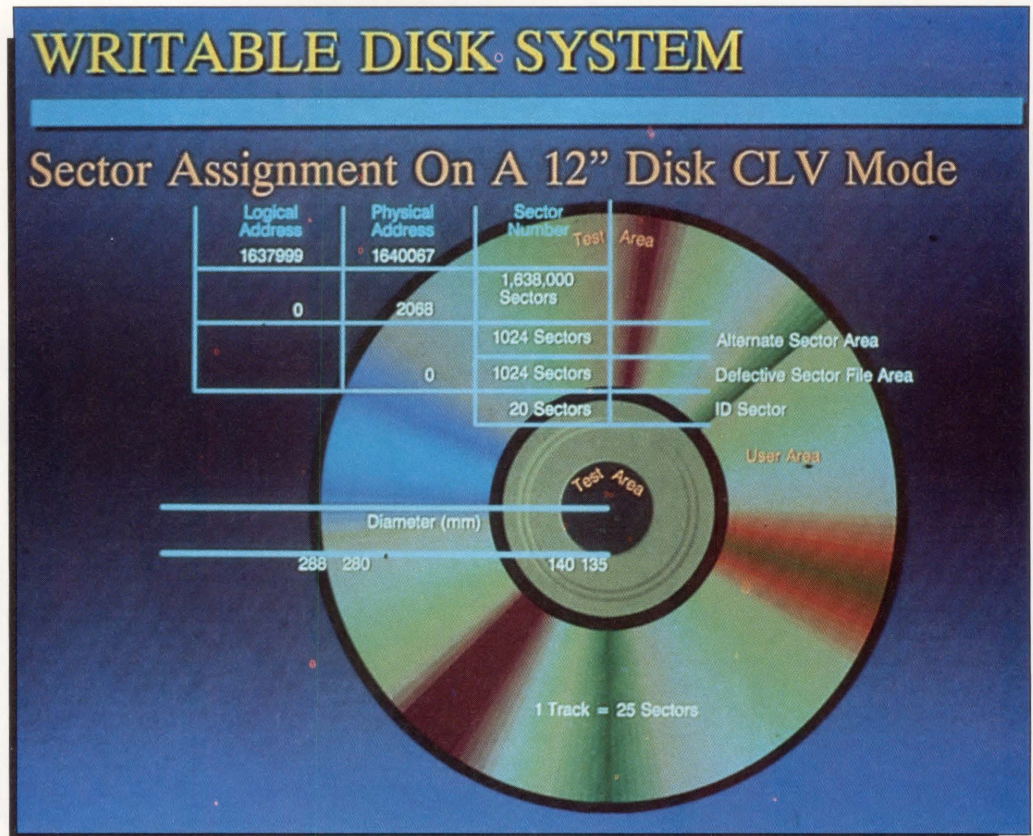

Courtesy Sony Corp.

magnetic tapes.

Compared with magnetic disks and tapes, optical media is almost indestructible. Optical disks can be mailed without special precautions, and taken through X-ray machines and airport scanning devices. Optically stored data is unaffected by the environment or magnetic fields. Some optical media lasts for 30 to 100 years, but magnetic media has an average life expectancy of only three to five years.

Optical disks are removable and thus the data can be securely stored. Also, the disks don't stretch over time as do magnetic tapes. Most optical media can't be altered, and optical media is less expensive per megabyte of storage. Performance problems still exist, but these will be alleviated as the product proliferates in its target markets of data distribution, publishing, database backup and archiving, and imaging. Perhaps paper-intensive environments happily will trade increased access times for large capacity, unattended backup

capability and high-volume storage of integrated data, text and images.

The software problems associated with write-once technology include file locating and rewriting, file directory updating, storage capacities that exceed operating system addressing abilities, access methods and error handling. But these can be solved. Thus, optical disks may well become the media of choice for long-term and archival storage.

### The Big Three

There are three types of optical disks: Compact Disk-Read Only Memory (CD-ROM), Write Once, Read Many (WORM), and erasable units and media. Each has unique properties and specific application niches. The three types of optical disks do not compete against one another.

**CD-ROM** — CD-ROM offers prerecorded optical storage. It's a read-only device: you can read the information on the disk, but it can't be altered. Used to distribute a common database

that doesn't have to be updated constantly to multiple divisions, departments or branch offices, it ensures that the data is protected against tampering or accidental erasing and is ideal for archival purposes.

Most systems of this type store 600 MB of data on a 4.7-inch CD-ROM disk and drive. Half-height 5¼-inch drives also are available. CD-ROM manufacturers have embraced the High Sierra Group standard for file organization. The 4.7-inch drive has become the industry standard.

CD-ROM is the most economical optical media for mass distribution of databases. The cost of preparing a master disk is relatively expensive, but the cost per copy can be as low as \$2 in a large-scale distribution.

With CD-ROM industrywide file structure standards now in place, CD-ROM has become a more attractive form of media. By the end of 1987, about 40,000 CD-ROM players had been shipped. Although 200 software prod-

# Give us a buzz...



**Because we have a swarm of mass storage high capacity subsystems for your DEC\* micro.**

The faster you call us the faster you can have the right mass storage high capacity subsystems for your MicroVAX II, Micro PDP and LSI-11\* systems and all Q-BUS\* computers. For complete information call now, or write.

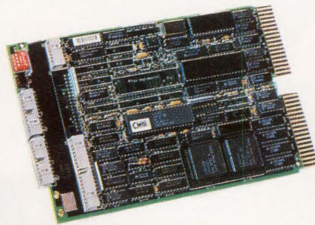

**ENHANCEMENTS, INC.**

1372 Valencia Avenue  
Tustin, California 92680  
(714) 259-9555

**We can enhance every advance.**

\*Registered trademarks of Digital Equipment Corp. CMS Enhancements, Inc. is a public company. NASDAQ symbol: ACMS.

**CIRCLE 343 ON READER CARD**

ucts were available for these machines, 2,500 are needed before users will embrace this media fully.

**WORM** — These optical storage devices permit one-time writing but unlimited reading of data and images. Although you can't overwrite or erase previously stored data, you can update it by writing new information into a file at another location on the disk. The new file then is linked to the original file through software and is retrieved in its place. This operation is transparent to the user. WORM media generally is available in 5¼-, 8-, 12- and 14-inch disks.

WORM optical disks are appropriate for handling data that must be updated and changed. For example, a college can update a student's transcript to show courses taken elsewhere, but retain the original transcript for archival and legal purposes.

In addition, WORM devices can be used by banks for payment and other customer documents, by insurance firms for policies and customer claim files, at medical facilities for patient records and diagnostic images, and in manufactur-

ing facilities for engineering drawings and vendor/customer records.

WORM media fits applications that require permanent records or tamper-proof audit trails. Because a master disk isn't used, it's more economical than CD-ROM for publishing and distributing information when only a few copies are needed.

Within the next five years, WORM media probably will replace magnetic tape for system backup and long-term archival storage of critical data. Its long life expectancy eliminates post-storage processing, required at least every five years when you use magnetic tape for data archiving.

As faster, more accurate input scanners are developed to convert printed images into digital data, sales of WORM drives should accelerate.

**Erasable Optical Storage Media** — This is emerging as a real-world product. Late this year or early next year, several giants in the electronics industry, including Kodak, Sony and Panasonic, probably will market erasable optical storage devices. These could revolutionize data storage and

retrieval.

Erasable or rewritable optical product vendors must provide low-cost production of reusable and reliable media and improve upon the slow performance of the associated optical drives. When costs for the media fall from the current price of \$250 to below \$100 and erasable optical drives approach the access and transfer times of Winchester drives, these optical devices may be the standard for large-capacity data recording and storage.

Erasable optical media will be used in applications where the stored data requires frequent change or where it's updated on a continuing basis. Its huge storage capacity makes it a daily system backup solution.

Because erasable media will be reusable, it will be similar in cost to magnetic tape. At this time, it's particularly suitable in on-line database applications that need constant updates, but where high speed isn't critical.

## CD-ROM Products

There are a variety of current and anticipated products for the optical storage

*Digital Equipment Corporation's RV20 write-once optical drive for VAX computers.*

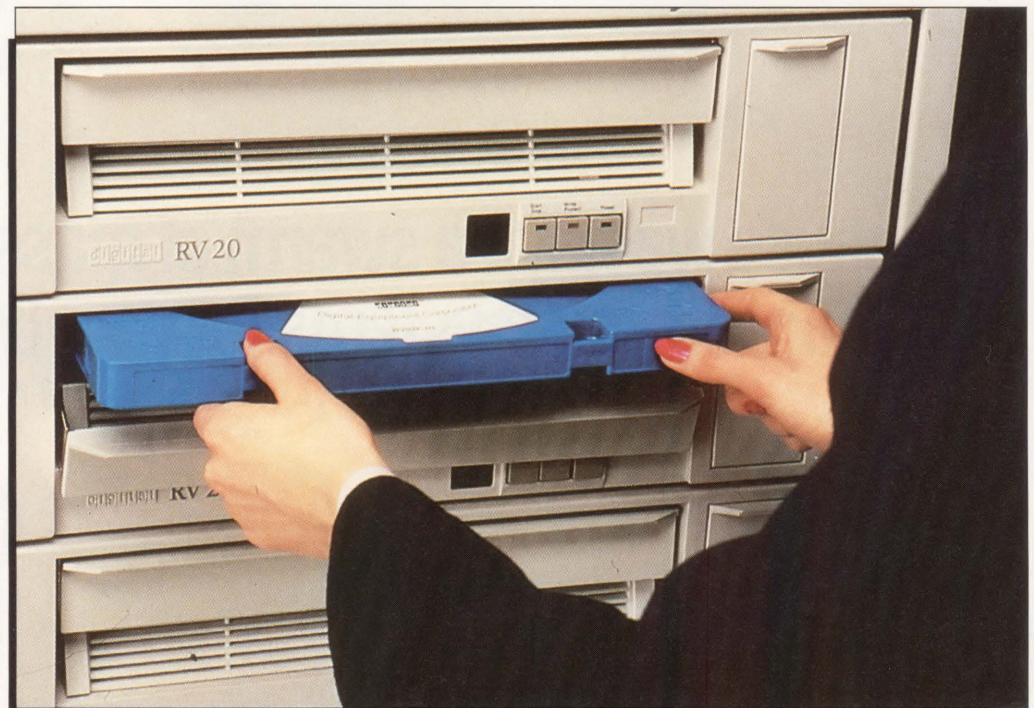

*Courtesy Digital Equipment Corp.*

market. Perhaps the most influential product in the CD-ROM industry is CD Publisher, a low-cost product development tool from Meridian Data Inc.

CD Publisher enables you to format data for CD-ROM mastering. A

**WORM MEDIA**  
probably will  
replace magnetic  
tape for system  
backup and long-  
term archival  
storage of  
critical data.

micro-based system, it handles each step of CD-ROM data preparation, including file structuring, content organization and simulation.

This year, Meridian Data introduced CD Net and CD Server. These products enable one or more CD-ROM products to be accessed over a LAN. They are compatible with Token Ring, Ethernet and ARCNET, and support Novell and MS NET software.

CD Net is aimed at small-to-medium-sized LANs. CD Server is compatible with medium- to large-sized LANs and other networking environments that require Winchester-like access to CD-ROM databases.

Meridian Data also markets Microsoft Extensions, a software package that enables MS-DOS to overcome its 32-MB file size limitation and access the entire 600-MB capacity of CD-ROM. Microsoft Corporation provides the hardware-independent program, and Meridian Data provides the device drivers for major manufacturers' CD-ROM drive lines.

Bookshelf, Microsoft's first CD-ROM offering, consists of 10 reference databases for writers, including a thesaurus, world almanac, style guide, dictionary and familiar quotations.

## VMS V5.0 On Optical Disk

Version 5.0 of the VAX/VMS operating system is available from DEC on optical disk. The CD-ROM disk will distribute both the operating system and related documentation in any VAXCLUSTER or DECNET/Ethernet environment.

To the VAX, the optical device looks like a tape drive, although the tape drive processing has been enhanced in the optical drive with additional security functions.

DEC supports VMS versions 4.6 and later on optical disks. The primary differences between V5.0 and previous versions is the inclusion of Symmetrical MultiProcessing (SMP) capabilities. The operating system, including documentation, occupies only part of the 4.7-inch compact optical disk, allowing room for many other applications or archives.

The advantages of storing VMS in this format over magnetic tape or disk includes the long life and integrity of the media, and easier installation. It also allows faster access to data, as the disk uses random, rather than sequential, search methods. A disadvantage is that, because optical media isn't erasable, VMS upgrades and documentation changes must be furnished on replacement disks. Also, performance tweaking of VMS becomes impossible when stored on optical disk.

According to Clay Prestia, a VMS expert and vice president of software development at RAXCO Inc., updates to V5.0 will appear soon, and bugs that have been discovered will be repaired and reliability problems improved. He notes that this process took about 18 months under V4.0.

DEC's VMS optical customers will be supported in the same way as other VMS users, says Paula Zenitz, DEC's VMS program manager for consolidated software distribution. Zenitz says that DEC is pursuing a variety of markets with the format, and that there probably will be a subscription service for VMS CD-ROM customers.

To facilitate the installation of optical products, including V5.0, optical drive readers as well as an *Optical Planning Guide* are available from DEC. The drives perform like Digital Storage Architecture (DSA) tape drives and respond to conventional VAX/VMS commands. Optional VAX/SLS software is a program for managing removable media.

The *Optical Planning Guide* is available upon request. To order the guide, write to Digital Equipment Corp., Order Processing, 10 Forbes Rd., NR03, Northborough, MA 01532. Your request must include the part number: EB 31809-45.

—Evan Birkhead

One Source is a financial database designed for money managers, portfolio managers and investment analysts. Produced by Lotus Development Corporation, it's updated each week. *Bibliofile*, the first CD-ROM application published, provides bibliographic information for libraries and bookstores. It's produced by Library Corporation.

PC-SIG, a distributor of public domain software, now markets a CD-ROM containing its more than 9,000 software programs. A series of business and financial disks from Disclosure Inc., a pioneer in the CD-ROM industry, provide detailed profiles of more than 11,000 companies traded on the New York and American stock exchanges, NASDAQ

and over-the-counter.

The largest on-line company, Dialog Information Services, produces a number of CD-ROM products aimed at researchers, students, planners and librarians in academic and business environments.

### CD-ROM Drives

Panasonic offers a number of CD-ROM drives. Models SQ-D1 and SQ-D101 are designed for the IBM PC and compatibles market. The SQ-D1, a built-in half-height drive capable of accessing up to 540 MB of data, has a maximum access time of 650 ms and a data transfer rate of 500 KB per second. The SQ-D101 is a standalone version of the same drive.

*In thermo-magneto-optical technology, an optical head writes on the disk by focusing a laser beam on the magnetic film, while a magnetic field is applied from a bias coil.*

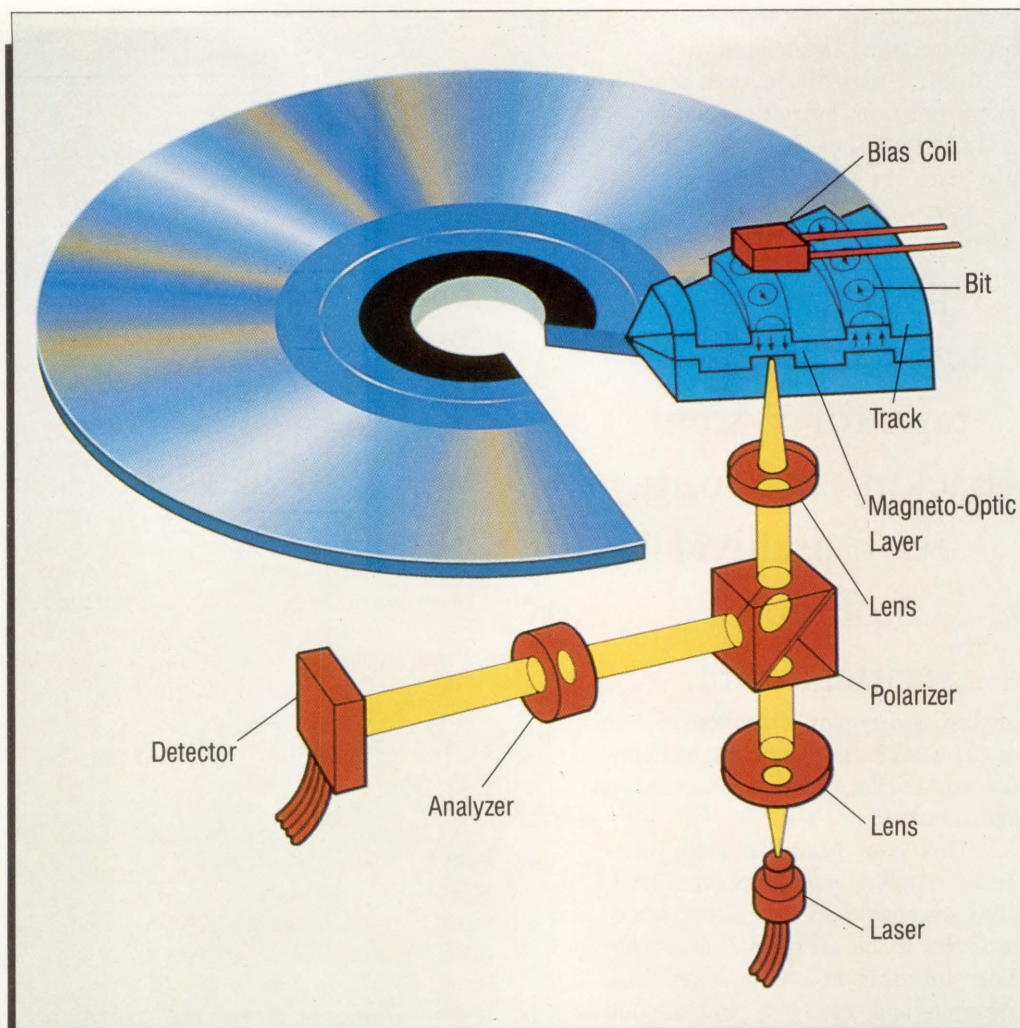

*Courtesy Verbatim Corp.*

The CD-ROM CDU series from Sony Corporation, introduced this year, includes the CDU-510, a 5¼-inch half-height drive that can be installed in existing computer cabinets, and the CDU 6100 family, which allows for the daisy chaining of up to four units. A standardized SCSI bus enables interfacing to most host computers.

## WORM Products

In April, DEC announced the RV20 write-once optical drive. Up to four of these units can be packaged in a single cabinet, providing 4 GB of data on-line at one time (8 GB total) for archiving, data retrieval or unattended backups. The drives now are available for Q-bus or VAXBI-bus systems and are supported under VMS version 4.6 and later.

The RV20 drive has an average sector access time of between 150 and 250 ms. Its transfer rate is approximately 250 KB per second. A UNIBUS version of the RV20 will be announced soon.

The RV20 uses 12-inch removable platters. Each disk can contain up to 2 GB of data (1 GB per side), equal to approximately 80 file cabinets or 60 reels of standard magnetic tape. The disk media is guaranteed for 30 years.

DEC provides a software package to manage these optical disks. Called the Storage Library System (SLS), this media management program provides a method to identify and label all data on tapes and the new WORM optical cartridges. SLS handles all backup and archiving procedures, keeps track of where data resides and triggers auto-

matic backup. It's fully supported by VMS, and VMS version 5.0 enhancements include increased security access protection for WORM disks.

DEC has developed a unique implementation to interface the drive to the system. Although it supports direct (random) file access, the RV20 looks to the VAX like any other tape drive, and it responds to standard VMS tape commands. This simplifies the integration of the optical drive into applications designed for VAX computers that use tape drives, without additional software. To add the optical drive to existing VAX systems without reprogramming, you only need one additional controller card and a bus adapter.

According to DEC product marketing manager of storage system



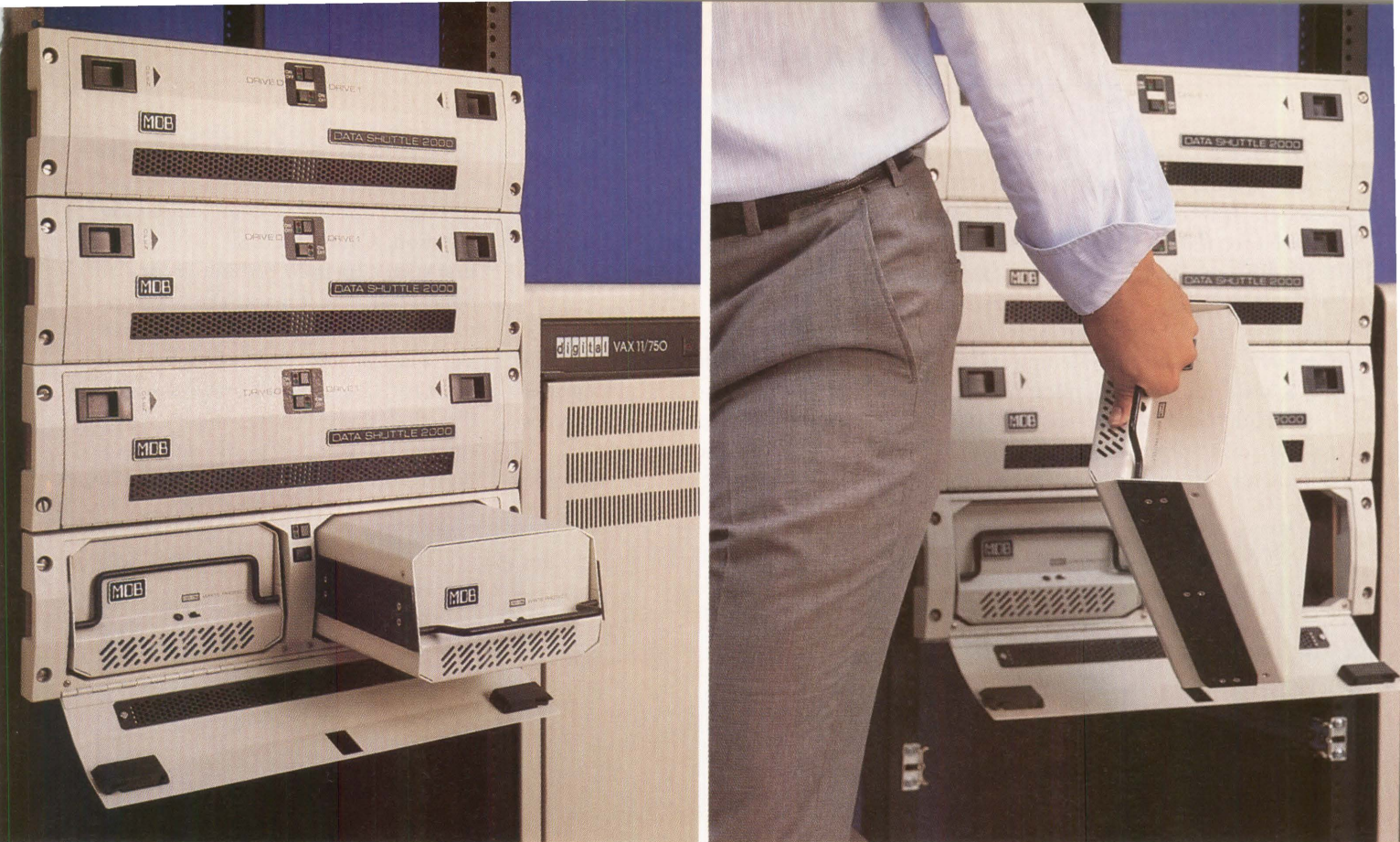

# Data Shuttle:<sup>TM</sup> It grows with you & it goes with you.

Stack it, stow it or stress it, MDB gives you a versatile, portable and durable Winchester Data Shuttle family for all computer systems ... in all commercial and laboratory environments.

Today you can start small or store as much as 760 MB per canister. With just the four Data Shuttles stacked above, you're looking at over 6 gigabytes of storage. Tomorrow, stack it from there. Only your ceiling is the ceiling.

Portability? Again, almost limitless. Shuttle your data for security, maintenance, duplication, or other reasons. Our quick release and

**From 1.5 gigabytes to 6 gigabytes or more, plus shock isolation and data portability.**

removable canisters (no cables to disconnect) makes any moving experience effortless and safe.

And when it comes to shock isolation, nobody in sight safeguards your precious data cargo on site or on the move. Thanks to our MIL-Spec experience we use proprietary shock isolators for the best possible protection.

Available with or without controllers or drives. ESDI, ST506, RD5X and SCSI interfaces are jumper selectable. Grow up with MDB's Data Shuttle family. There's more in it for you. Call today for complete details.

**MDB**  
SYSTEMS INC.

— We put the *State of the Art* to work —

**Corporate Headquarters** 1110 W. Taft Ave., Box 5508, Orange, CA 92613-5508 • TEL: (800) 556-0222. In CA (800) 637-2028 • FAX: (714) 637-4060 • TWX: (910) 593-1339

**FOR UNITED KINGDOM** MDB Systems, U.K., Ltd., Intec 2, Wade Road, Basingstoke, Hants. RG24 0NE • TEL: 0256 464767 • FAX: 0256 59748 • TELEX: 858389 MDBSYS G

**FOR WESTERN EUROPE** MDB Systems, IRL., Ltd., Portumna, Co. Galway, Republic of Ireland • TEL: (353) 509 41163/41413 • FAX: (353) 509 41447 • TELEX: 50918 MDB IE

*Data Shuttle is a trademark of MDB Systems, Inc.*

CIRCLE 304 ON READER CARD

development Malcolm Krongelb, a high-capacity multiplatter WORM jukebox (autochanger) subsystem is planned for the near future. It will access different platters automatically, without requiring that the platters be mounted manually. Compatible with the RV20, users can migrate upward to a full-scale automated application.

The LF-5000 is a 5¼-inch WORM optical disk drive from Panasonic. Shipments of these units began in

August. The LF-5000 uses removable cartridges with a 200-MB storage capacity per side. Access time is less than 230 ms. The drive's data transfer rate is 2.5 megabits per second from the optical media to the active memory.

The Panasonic drive is designed for use with the Mac and the IBM PC and compatibles. The LF-5000's built-in SCSI allows for easy hook-up to other types of computer hardware as well.

The LF-5000 drive and Plasmon

Data Systems' 5¼-inch WORM disks have been combined into a recording/editing system by CompuSonics Corporation. Called the DSP 1000, it's the first such system to be built around an optical disk, and it marks a new generation of professional audio equipment.

The DSP 1000 records to optical disk at 44.1 KHz and handles audio signals directly, transforming these signals through a pair of 16-bit analog-to-digital converters. The product also can

## Suppliers Of Optical Disks & Services

Aquidneck Systems Int'l Inc.  
650 Ten Rod Rd.  
North Kingstown, RI 02852  
(401) 295-2691

**CIRCLE 423 ON READER CARD**

C. Itoh & Co. (America) Inc.  
One Maritime Plaza, Ste. 920  
San Francisco, CA 94111  
(415) 391-2510

**CIRCLE 437 ON READER CARD**

CompuSonics Corp.  
2345 Yale St.  
Palo Alto, CA 94304  
(415) 494-1183

**CIRCLE 472 ON READER CARD**

Dialog Information Services  
3460 Hillview Ave.  
Palo Alto, CA 94304  
(415) 858-2700

**CIRCLE 473 ON READER CARD**

Digital Equipment Corp.  
146 Main St.  
Maynard, MA 01754-2571  
(617) 897-5111

**CIRCLE 400 ON READER CARD**

Disclosure Inc.  
5161 River Rd.  
Bethesda, MD 20816  
(301) 951-1453

**CIRCLE 474 ON READER CARD**

EMC Corp.  
171 South St.  
Hopkinton, MA 01748-9103  
(617) 435-1000

**CIRCLE 447 ON READER CARD**

Fujitsu America  
Computer Products Group  
3055 Orchard Dr.  
San Jose, CA 95134  
(408) 432-1300

**CIRCLE 475 ON READER CARD**

Hewlett-Packard  
3000 Hanover St.  
Palo Alto, CA 94304  
(415) 857-1501

**CIRCLE 425 ON READER CARD**

Hitachi America Ltd.  
Computer Division  
950 Elm Ave.  
San Bruno, CA 94066  
(415) 872-1902

**CIRCLE 490 ON READER CARD**

IBM Corp.  
Old Orchard Rd.  
Armonk, NY 10504  
(914) 765-1900

**CIRCLE 424 ON READER CARD**

KOM Inc.  
145 Spruce St.  
Ottawa, ON K1R 6P1  
(613) 238-7766

**CIRCLE 457 ON READER CARD**

Laser Magnetic Storage Int'l  
4425 ArrowsWest Dr.  
Colorado Springs, CO 80907  
(719) 593-7900

**CIRCLE 478 ON READER CARD**

The Library Corp.  
Research Park  
Inwood, WV 25428  
(800) 624-0559

**CIRCLE 479 ON READER CARD**

Lotus Development Corp.  
55 Cambridge Pkwy.  
Cambridge, MA 02142  
(617) 577-8500

**CIRCLE 480 ON READER CARD**

Meridian Data Inc.  
4450 Capitola Rd., Ste. 101  
Capitola, CA 95010  
(408) 476-5858

**CIRCLE 481 ON READER CARD**

Microsoft Corp.  
16011 N.E. 36th Way  
Redmond, WA 98052  
(206) 882-8080

**CIRCLE 404 ON READER CARD**

Novell Inc.  
122 E. 1700 S.  
Provo, UT 84601  
(801) 379-5900

**CIRCLE 476 ON READER CARD**

Panasonic  
One Panasonic Way  
Secaucus, NJ 07094  
(201) 348-7000

**CIRCLE 483 ON READER CARD**

PC-SIG  
1030 E. Duane, Ste. D  
Sunnyvale, CA 94086  
(312) 786-5400

**CIRCLE 484 ON READER CARD**

Perceptics Corp.  
Pellissippi Corporate Center  
725 Pellissippi Pkwy.  
Knoxville, TN 37922  
(615) 966-9200

**CIRCLE 485 ON READER CARD**

Plasmon Data Systems Inc.  
99 West Tasman Dr.  
San Jose, CA 95134  
(408) 432-0570

**CIRCLE 486 ON READER CARD**

Qualogy Inc.  
1751 McCarthy Blvd.  
Milpitas, CA 95035  
(408) 434-5200

**CIRCLE 477 ON READER CARD**

Sony Corp. of America  
Sony Dr.  
Park Ridge, NJ 07656  
(201) 930-1000

**CIRCLE 487 ON READER CARD**

3M Company  
Magnetic Media Div.  
3M Center Bldg.  
St. Paul, MN 55144-1000  
(612) 733-1110

**CIRCLE 488 ON READER CARD**

U.S. Design Corp.  
4311 Forbes Blvd.  
Lanham, MD 20706  
(301) 577-2880

**CIRCLE 449 ON READER CARD**

Verbatim (Kodak) Corp.  
435 Indio Way  
Sunnyvale, CA 94086  
(408) 773-5777

**CIRCLE 489 ON READER CARD**

take digital inputs directly.

Fujitsu America also manufactures 5¼-inch WORM drives. The M2505 drive and associated controller use removable cartridges and offer 600 MB of storage (300 MB per disk side), an average access time of 100 ms and a data transfer rate of up to 1.5 MB per second. It also features SCSI.

EMC's ARCHEION family of WORM optical disk subsystems provides up to 56 GB of on-line storage for any VAX or MICROVAX system. EMC claims to be the only company in the DEC market that offers both magnetic tape and Winchester disk emulation. Both ARCHEION optical disk subsystems, ARCHEION Database magnetic disk emulation and ARCHEION magnetic tape emulation, are fully compatible with each other.

Laser Magnetic Storage Company (LMS), a joint venture between Philips and Control Data, continues to increase and enhance its across-the-board product line. Major offerings include new versions of the LMS 1200 and 1250 WORM drives. The 1200E is a standalone tabletop unit, and the alternate model, 1250E, is a rack-mountable unit designed for jukeboxes.

Both contain embedded controllers, power supplies and self-diagnostics, and both record 1 GB per side on a 12-inch removable cartridge. The media also is manufactured by LMS.

The drives feature SCSI and ISI compatibility, allowing connection to almost any system ranging from micro-computers to mainframes. Other features include 750 KB per second read transfer rate (SCSI only), 150 ms average access, and a universal auto-ranging power supply that automatically adjusts to 110 volts, 60 Hz; 220 volts, 50 Hz; or other power sources. LMS drives also contain a patented direct-read-during-write (DRDW) technique that allows data to be verified automatically as it's written.

LMS also has introduced a 5¼-inch, 654-MB WORM drive. Called LaserDrive 510, it's designed specifically for OEMs and systems integrators. It features 327 MB of storage on each side of a double-

# FILE COMPRESSION

- Speed-up File Transfers
- Save Disk Space

## NEW FCX File Compression Utility for VAX/VMS\* Systems

FCX is a powerful yet easy to use file compression utility which can significantly reduce the time and cost of file transfers, in addition to saving disk space.

- 20%-70% typical space savings
- Compress multiple files of any size and type together
- Preserve VMS file structure
- Select files by name, date and type, including wild cards
- Choose from 3 compression levels
- File verification to insure data integrity
- Compress and expand directories and directory trees
- Selectively expand files at any time
- Benefits users as well as system managers

Evaluation package available. Call for additional information.

\* VAX and VMS are registered trademarks of Digital Equipment Corporation.

**ICS** Innovative Computer Systems, Inc. (609) 779-1422  
72 CROOKED LANE ■ CHERRY HILL, NJ 08034

CIRCLE 363 ON READER CARD

## UNIX® SYSTEM ADMINISTRATION

### UNISOL™ UTILITIES

The cost effective solution to system management problems

.....Establish and maintain a consistent and secure environment

.....Control Computer Costs

- System Operation and Maintenance
- Resource Accounting and Chargeback
- Security Monitoring and Control
- Network Administration

### UNISOLUTIONS ASSOCIATES

6520 Green Valley Circle  
Suite 13-203  
Culver City, California 90230

Call (213) 641-6739

Unix is a registered trademark of AT&T  
© 1988 Unisolution Associates. All rights reserved.

CIRCLE 225 ON READER CARD

sided removable disk cartridge, a 600 KB per second sustained transfer rate, an average access time of 75 ms and a maximum track-to-track seek time of 1.5 ms. It includes an embedded SCSI.

This drive incorporates the proposed standard sampled servo using 4/15 data format. The sampled servo approach, which also is supported by other major optical disk manufacturers such as Hitachi and Sony, allows the drive to read/write data independently of the clocking signal. It provides for the total decoupling of servo/data functions, eliminating interference between focusing, tracking, seeking, clocking and data signals.

Sony offers a line of WORM drives that includes the WDD-3000 and the WDA-3000-10, which can provide from 2.1 GB of storage to 820 GB on a single interface.

Sony's big news isn't its drives,

however, but its extended-life media. Most manufacturers claim a 10- to 15-year media life, and some guarantee their media for 30 years. Based on accelerated test results, the Sony Century Media's alloy method of recording can store information at a bit error rate of less than  $10^{-12}$  for as long as 100 years.

**The New Frontier**

Although a number of erasable optical media methodologies are under research and development, thermo-magneto-optical seems to be the frontrunner.

An optically-assisted form of magnetic recording, this works by using an absorbed laser light to heat selected spots on the recording surface, reducing its coercivity, i.e., reducing its ability to resist magnetism. A magnetic field then alters the magnetic domains on the disk, which is the method for writing and erasing. When the laser beam is

removed, the heated area on the disk returns to normal temperature, and its coercivity returns to its normally high state. The recorded data then is stable and will be unaffected by any external magnetic fields.

On this media, reading the data requires interpreting a reflected laser beam. The magnetic orientation, or polarization, of the recorded data causes the beam to reflect off the magnetized bit or bits differently. The reflected light goes to a photodetector and analyzer for interpretation into binary data.

The rugged stability of the stored data results from the high coercivity of the alloy used in the recording layer. Coercivity, which is measured in Oersteds (Oe), represents the alloy's resistance to demagnetization. Chandran Cheriyan, marketing manager for Magneto-Optic Drive and Media at Verbatim, credits coercivity for giving

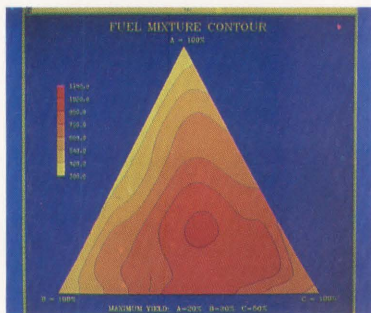

**Contours**

Scientific contours are easily drawn with color fill capabilities to quickly see the relative distribution of data points. Labeling is accomplished during program set-up, allowing all graphs to be drawn automatically.

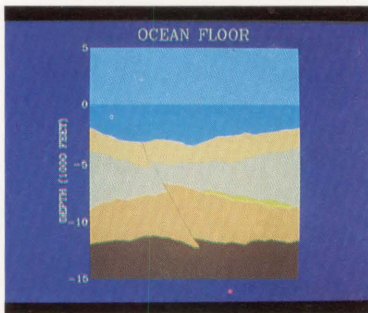

**X, Y Graphs**

Two-function graphs are easily generated even with large data bases. High quality presentation graphs are available by using GRAFkit's curve fitting and color fill capabilities.

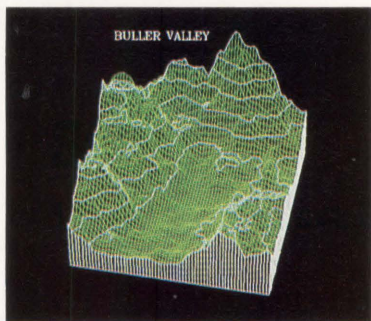

**3D Surface**

The 3D surface application plots a perspective of a function of two variables with hidden lines removed.

The high level applications included in GRAFkit are:

- X, Y Graphs
- X, Y, Z Graphs
- Contours
- Histograms
- Scatter Diagrams
- Streamlines
- Vector Graphs
- 3-D Solids
- 3-D Surfaces
- Cartographic Maps
- Map Data Overlays

GRAFkit includes a Graphical Kernel System (GKS) foundation which organizes graphic data in an ANSI/ISO approved format. The GRAFkit GKS also features an ANSI/ISO approved Computer Graphics Metafile (CGM) which stores data device-independently. GRAFkit's applications are completely functional with any standard conforming GKS software, however, the GRAFkit GKS provides support for more than 100 devices.

For increased technical graphics capabilities on workstations or larger departmental computers, GRAFkit is the solution.

**GRAF<sup>TM</sup>KIT**  
**EXPANDING THE POWER OF GKS**

GRAFkit™ expands the graphics capability of workstations and departmental computers in VMS, Ultrix, and Unix environments. It is an economical solution that gives the user superior performance and versatility. And GRAFkit has been enhanced to include advanced graphics routines from the National Center for Atmospheric Research (NCAR), a pioneer in graphics development for twenty years.

Ultrix and VMS are registered trademarks of Digital Equipment Corp. Unix is a registered trademark of Sun OS.



SCO, Inc.  
 740C S. Pierce Ave.  
 Louisville, CO 80027-9989  
 303/666-5400  
 Telex: 292682  
 FAX: 303/666-7054

**1-800-222-4239, ext. 714**

*See us at: The Federal Computer Conference, Oct. 26-28, 1988 in Washington D.C., Booth No.2222, AND at DEXPO West, Oct. 19-21, 1988, Booth No.1659.*

SCO, Inc. is a division of International Computer Exchange, Inc.

CIRCLE 350 ON READER CARD

THE KEY TO the continued popularity of optical disk drives is the availability in quantity of reliable, high-performance, low-cost media.

the optical media its high storage densities and data reliability.

The coercivity of the erasable optical alloy at room temperature is in excess of 4000 Oe compared with a coercivity rating of 300 Oe to 700 Oe for floppy disks and approximately 1000 Oe for Winchester disks. When the temperature of the thermo-magneto-optic recording layer rises to about 200 degrees Celsius, its high coercivity temporarily lowers, and a weak magnetic field then can reverse the direction of magnetization.

Kodak and its subsidiary Verbatim are introducing a 3½-inch erasable optical drive with removable media, also based on thermo-magneto-optical technology. Each 3½-inch magneto-optic disk stores the equivalent of the data on 138 standard magnetic 5¼-inch floppy disks, a capacity in excess of 50 MB. Access time (combined seek time, head settling time and latency) is less than 70 ms for write operations and less than 50 ms for read operations. The data transfer rate is more than 1 megabit per second. This drive is compatible with both SCSI and ESDI interfaces.

The optical head flies more than 1 mm above the surface of the rotating disk (many times farther from the surface than a Winchester head), eliminating the danger of head crashes.

Sony Corporation is developing a rewritable optical disk based on magneto-optical technology. Sony's 5¼-inch drive with removable media can store up to 650 MB on a dual-sided cartridge. The rewritable optical disk drive offers a sustained data transfer rate of 7.4 megabits per second at the read amplifier, and an average seek time of

less than 90 ms. Sony supports both Sampled format and Continuous Composite ISO format.

Sony, Hewlett-Packard and 3M jointly have stated their support for the Continuous Composite format standard for 130 mm rewritable media, based on magneto-optical technology. This format, originally defined for WORM disks, will ensure product compatibility and promote data interchangeability among second-source vendors.

Using this proposed format standard and technology, Sony will develop optical storage products for data storage applications on personal workstations and multiuser computer systems. HP will develop products for archival disk storage applications that will be integrated with the HP Precision Architecture family of business and technical computers. 3M, along with Sony, is developing magneto-optical media for these drives and systems.

OPTICAL STORAGE offers the first major breakthrough in data processing recording, storage and retrieval since the advent of magnetic media. Other storage technologies, such as bubbles and CCDs, have been developed and tested, but all had drawbacks that hampered their acceptance and widespread use in the commercial marketplace.

Optical storage products haven't been hampered by any such limitations. This technology provides a rugged, stable, reliable media for storage of data, voice and images at a cost per MB that's cheaper than existing methods.

"Hardware and software support will be a big factor in determining future customer acceptance of optical media,"

states Malcolm Krongelb of DEC.

Most original optical vendors have sold their optical drives as complete subsystems, incorporating all the hardware, software and interfacing required to communicate with the buyer's system.

Some, like Perceptics Corporation, provide complete installation and on-site maintenance. And its LaserWare software is transparent to VMS utilities and applications, and requires no change to existing software. DEC has taken the same kind of approach, creating its optical disks to look like normal magnetic tape, thereby making the transition to optical transparent to the user.

"The demand for a new computer technology can grow only if computer users see that the technology is becoming a standard," says David Kalstrom, Plasmon Data's vice president of marketing. Optical drives and media are opening new markets and applications where removability is a design consideration and the amount of data to be stored exceeds the practical capacities of removable media based on magnetics. Growth has been steady, but, Kalstrom claims, "an explosion in the optical drive market can be expected once standards are set."

The key to the continued popularity of optical disk drives is the availability in quantity of reliable, high-performance, low-cost media. The media must be standard, capable of working in different drives. A standard recording format, such as the Continuous Composite ISO, will make users feel more comfortable incorporating optical storage into their data processing systems.

With DEC and IBM endorsing optical technology through their introduction of WORM drives earlier this year, and with the expected availability of new erasable optical drives and media, 1989 should represent a milestone in computer storage technology.

ARTICLE INTEREST QUOTIENT  
Circle On Reader Card  
High 469 Medium 470 Low 471

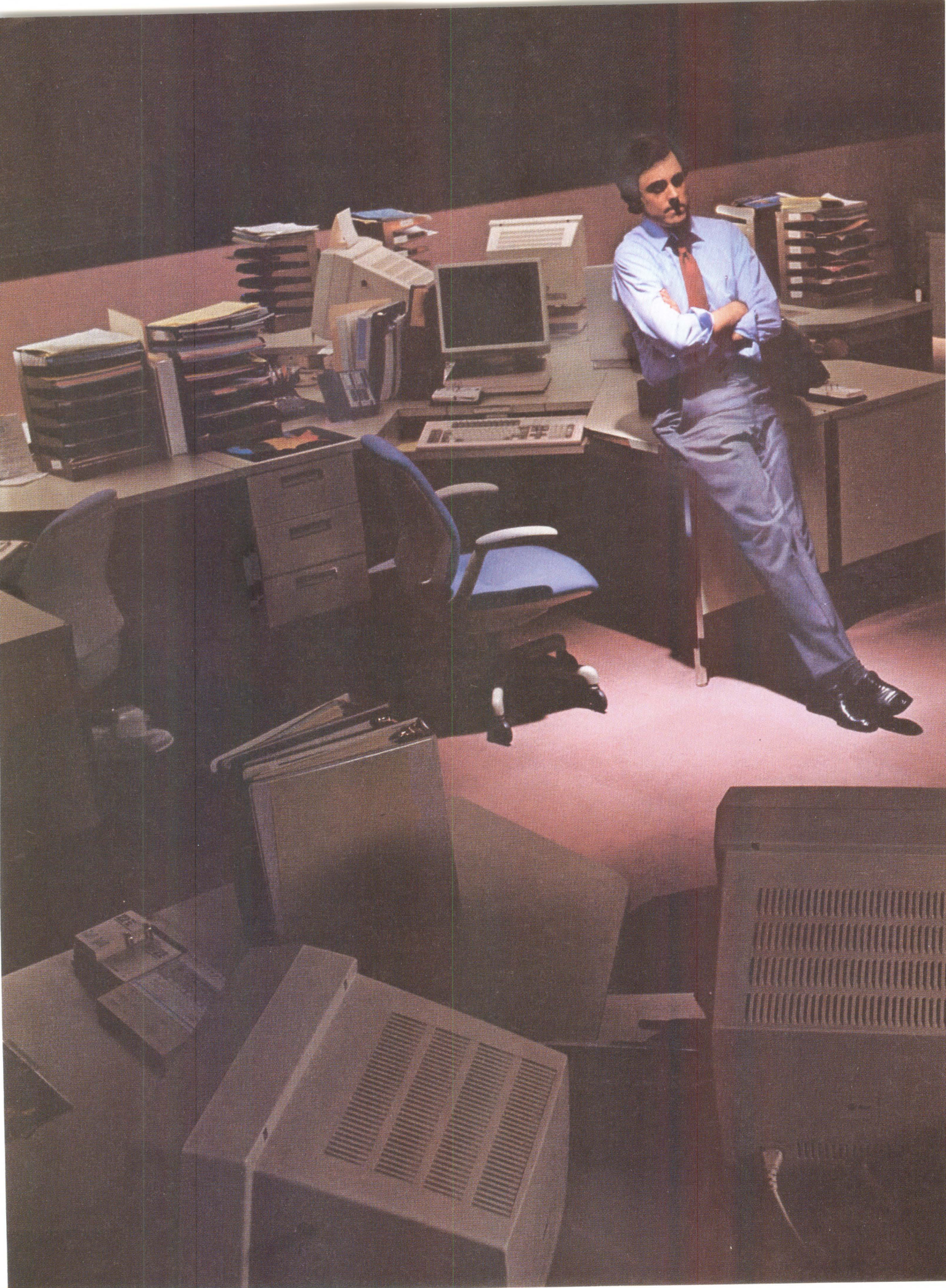

*“I know it pays to have power protection.  
But why should I pay for  
more protection than I need?”*

You shouldn't, and you won't, with Power Protection Systems



AT&T Power Protection Systems come in single-phase 1, 3, 5 and 10 KVA models and 3-phase 10 and 20 KVA models.

from AT&T. Unlike most other uninterruptible power systems, AT&T systems deliver all the power they're rated for, so you don't have to pay for a "cushion" you don't need.

The reason? A unique parallel processing design, developed by AT&T Bell Laboratories, that incorporates an innovative electronic by-pass feature, along with precision microprocessor controls, and battery reserves to protect against power fluctuations as well as complete blackouts.

AT&T's design offers another big advantage: it accommodates both linear and non-linear power loads, so you get an "umbrella of protection" that covers your laser printers and other peripherals as well as your computers.

To precisely meet your needs, AT&T offers a broad line of models, ranging from single-phase 1 KVA for desktop and small PBX applications, to 3, 5 or 10 KVA for floor-standing minis and larger PBXs, to three-phase 10 and 20 KVA models. Everything it takes to meet the requirements of virtually any computer environment.

On top of all that, AT&T gives you a 12-month free parts and labor warranty,\* backed by prompt, expert customer service from more than 100 nationwide locations.

For more information, and the location of your nearest distributor, call AT&T at **1 800 982-0030**. In Canada, call **1 800 445-5607**.

\*Limited warranty, details on request. © 1988 AT&T



**AT&T**

The right choice.

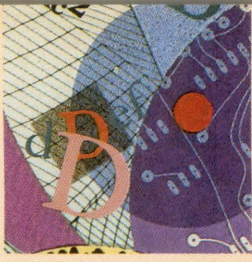

## SYSTEM MANAGEMENT

# P ERFORMANCE MANAGEMENT

By Terry C. Shannon

*Editor's note: In this first part of a two-part*

*series on system performance management, the author takes an in-depth look at monitoring system performance.*

## Part 1: Tips On Monitoring System Performance.

The growing popularity of VAX/VMS disk defragmenters, performance monitors and optimization tools is a clear indication that system performance has become a high-priority issue in the VAX system management community. And rightfully so: New VAX processors and peripherals aren't cheap, and a carefully administered system performance management program can help defer or eliminate costly hardware upgrades.

Of equal importance, system performance management can help minimize a hidden and potentially significant expense associated with DEC's new software licensing strategy. Because DEC's software pricing now is based on the capacity of the various VAX CPUs, the cost of a processor upgrade is compounded by the correspondingly more expensive operating system and applications software licenses that go hand in hand with a more powerful CPU.

In its simplest terms, system performance management involves getting the most from your existing hardware resources. System performance management can be defined more formally as the ongoing monitoring, troubleshooting and optimization of a computer system's hardware and software to conform to the needs of the current workload.

By optimizing your system, you can im-

prove the response time for the current workload and accommodate an increased workload without having to purchase and license additional hardware.

System performance monitoring, the first component of the system performance management process, can be defined as the measurement of the consumption of a computer system's dynamically shared CPU, memory and I/O resources. Through the careful analysis of the statistical information derived from performance monitoring, a knowledgeable and experienced user can determine the use and relative health of each system resource.

Note that CPU, memory and mass storage upgrades don't fall within the scope of a performance management exercise. Rather, it's the operating system environment in which these devices function that's subject to adjustment.

### System Performance Semantics

System performance is referred to in terms of work, throughput and response time. Work, or the amount of CPU, memory and I/O resources required to perform a given task, usually is expressed in a user-defined unit of productivity, such as transactions completed, records processed or report lines printed.

Throughput, or the rate at which work is completed, is the measurement of the amount of work that can be performed by a computer system during a given period of time. Although throughput is a valid criterion of system performance, a measurement based on the amount of work performed over time is better suited to a batch-oriented computer



than to an interactive, multiuser computer system.

Consequently, when working with VAX/VMS computers, it's useful to express throughput in terms of response time, i.e., the amount of time it takes the computer system to initiate a response to a user request.

Regardless of the unit of measure used to quantify system performance, there are three basic approaches to increasing the amount of work that can be accomplished by a computer system. Two of these methods involve decreasing the system resources required to perform a given amount of work; one involves the reallocation of available system resources.

When conducting a performance management exercise, you can draw upon a variety of techniques and heuristics that attempt to increase system throughput by:

1. Decreasing operating system overhead.
2. Decreasing application program overhead.
3. Exchanging overused system resources for those that are underused.

For example, it's possible to reduce VMS overhead by reducing the size of the operating system's data structures, non-paged pool and working set. Inefficient application programs often can be streamlined through the elimination of redundant instructions or by recompiling and relinking program modules to exploit the features of new operating system and compiler releases.

Further, you can increase throughput by reappportioning your hardware resources. If your system is endowed with excess memory capacity but is constrained by I/O limitations, consider trading memory for I/O by enlarging the file system caches to reduce the aggregate number of I/O operations.

Bear in mind that all valid VMS system performance management hints, tricks and rules of thumb attempt to boost system throughput by implementing one or more of those mechanisms. No software-based system accelerator or performance enhancement product can

be expected to wring additional capacity, throughput or CPU cycles from a computer system that's already using 100 percent of its available resources.

In other words, a performance management exercise, or product, is effective only when the demand for system resources can be reduced or a resource run-

ning at capacity can be exchanged for an underused resource.

## Tools Of The Trade

Developing an understanding of your computer system's workload and normal behavior requires a substantial investment of time and a working knowl-

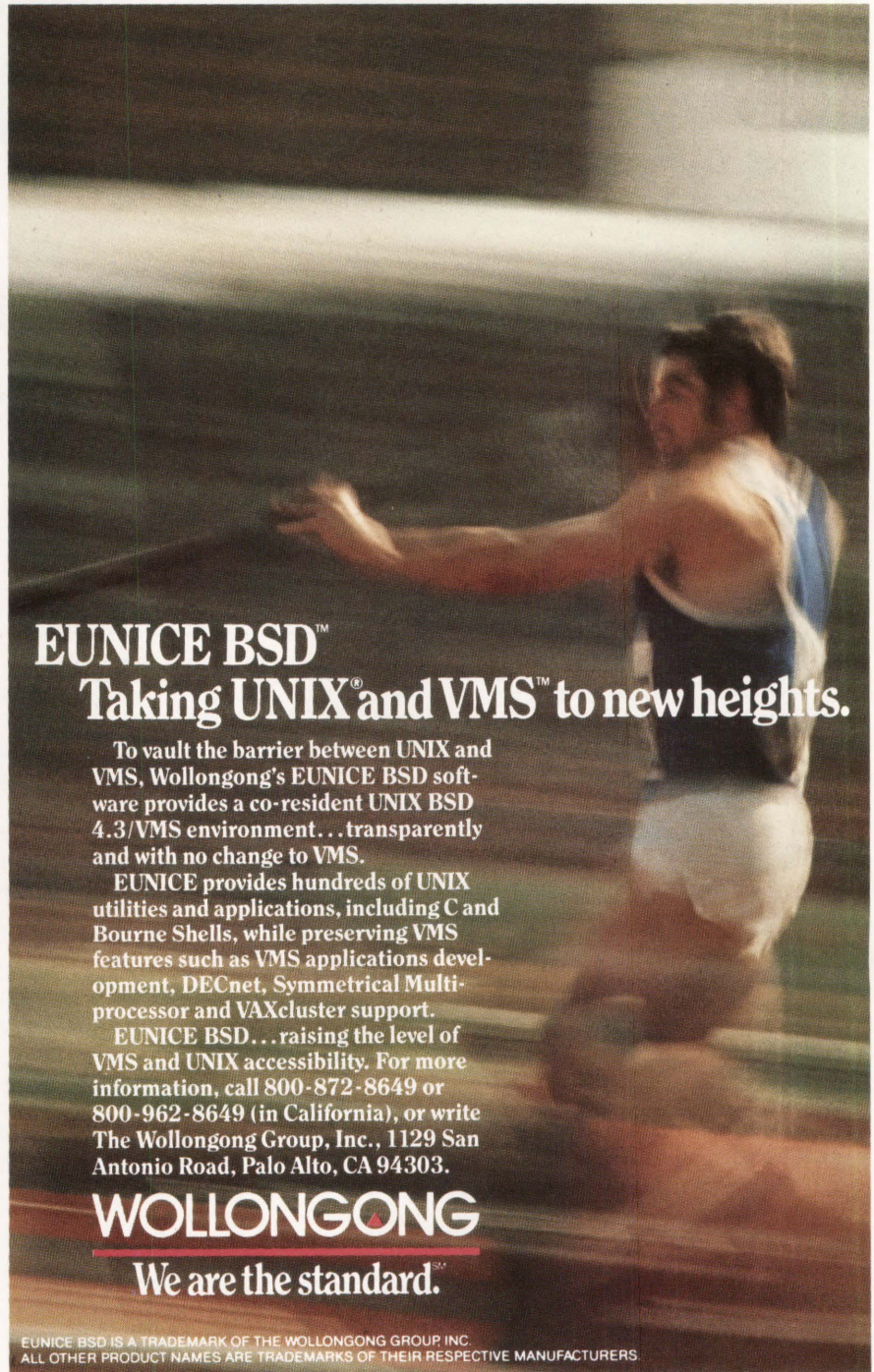

**EUNICE BSD™**  
**Taking UNIX® and VMS™ to new heights.**

To vault the barrier between UNIX and VMS, Wollongong's EUNICE BSD software provides a co-resident UNIX BSD 4.3/VMS environment... transparently and with no change to VMS.

EUNICE provides hundreds of UNIX utilities and applications, including C and Bourne Shells, while preserving VMS features such as VMS applications development, DECnet, Symmetrical Multiprocessor and VAXcluster support.

EUNICE BSD... raising the level of VMS and UNIX accessibility. For more information, call 800-872-8649 or 800-962-8649 (in California), or write The Wollongong Group, Inc., 1129 San Antonio Road, Palo Alto, CA 94303.

**WOLLONGONG**  
**We are the standard.™**

EUNICE BSD IS A TRADEMARK OF THE WOLLONGONG GROUP INC.  
ALL OTHER PRODUCT NAMES ARE TRADEMARKS OF THEIR RESPECTIVE MANUFACTURERS.

CIRCLE 169 ON READER CARD



## How to match the best front end with the best back end.

You've invested in the best hardware, operating system and database products. You have a staff of programmers ready to go. But to build great looking applications with the sophisticated features today's users demand, you need a powerful front end development tool—JAM™

JAM, the most advanced user interface management system on the market, does it all—from prototyping to implementation. And, because it works with any database



Create colorful screens and nested windows easily.

or file manager, you get the best front end and the best back end.

JAM is hardware independent, so it isn't limited to one computer, database or operating system. In fact, JAM runs on everything from PC's to super-minis, works under 7 operating systems and provides access to a host of database products. Using JAM you can create a consistent user interface across multiple systems and hardware platforms.

JAM works under the following operating systems:

- UNIX®
- MS-DOS®
- VMS®
- XENIX®
- AOS/VS™
- RMX™
- VOS™

JAM makes it easier than ever to design and revise complex applications. Using features like context-sensitive help, procedural command language (JPL), shifting and scrolling fields, extensive data validations, on-line testing, and a variety of visual attributes, you'll be amazed how quickly your applications spring to life.

JAM is fast, as well as flexible. Development time is reduced significantly thanks to JAM's powerful screen drawing utilities and comprehensive library of sub-routines. You can easily create and link together screens, windows, and menus to develop an application shell. Then simply attach the processing routines, and your application is complete.

Plus, if your back end is an SQL-compatible relational database like Oracle®, SQLbase®, Informix® or Britton Lee™, you'll really appreciate JAM/DBi, JAM's optional database interface. With JAM/DBi, you can develop entire applications using only industry-standard SQL statements and JAM's authoring tools.

So if you're programming in a 3GL like C or FORTRAN, follow the lead of the many Fortune 1000 companies who have already discovered JAM.

JAM from JYACC. It gives you the best at both ends.

Call for more information about

JAM and our demo diskette. **800-458-3313**

JYACC, Inc.  
116 John Street  
New York, NY 10038

212-267-7722 FAX No. 212-608-6753



Use SQL to retrieve and display data.

# JAM

JYACC Application Manager. *The Composer for Sophisticated Applications.*

CIRCLE 131 ON READER CARD

edge of the performance management software "tools of the trade." Before embarking on a performance management exercise, you must become proficient in the use of a variety of VMS utilities and commands or a layered performance monitoring package.

After you've become conversant with your performance management tools, you must dedicate sufficient time to observe your system's operation on a daily basis, so that you can determine the range of acceptable values for key system performance parameters. Bear in mind that ongoing system monitoring is an integral part of the performance management process; you can't wait for problems to develop and then learn how your system performs.

You can conduct your performance monitoring program with default VMS software tools or with a dedicated VMS software performance monitoring package. Both provide a wealth of performance monitoring functions and capabilities; they are distinguished primarily by their varying levels of integration and ease of use.

If you plan to monitor your VAX system with default software tools, you must become proficient in the use of the VAX/VMS ACCOUNTING, AUTHORIZE, MONITOR, SYSGEN and SYSMAN utilities as well as the DCL SET and SHOW commands and their various parameters and qualifiers.

Because it's based on a collection of discrete utilities and DCL verbs that don't share a consistent user interface or command syntax, you might find that this approach to VMS performance monitoring isn't an ideal solution to your needs.

As an alternative, you can purchase a dedicated VMS software performance monitoring package from a third-party vendor. Several such products provide consistent, menu-driven user interfaces that replace the numerous commands, qualifiers and parameters associated with default VMS system management tools.

Another common feature of third-party VMS performance monitors is a

centralized statistical database that eliminates the need to merge and consolidate the statistical files that are individually maintained by the VMS ACCOUNTING, DISKQUOTA, MONITOR and SYSGEN utilities.

### What's Your System Doing?

Before you can answer questions effectively about existing or potential performance problems, you must know what constitutes normal performance for your system. Knowledge of your system's normal workload allows you to recognize abnormal system behavior and helps you determine how additional demand could affect performance. As a minimum, you should be familiar with the following aspects of your system's hardware, software and user environment:

1. System hardware and software configuration.
2. Location of key application images.
3. Installed images and their attributes.

4. Location of page and swap files.
5. Location of user data files.
6. Known performance problems and bottlenecks.
7. Overall workload characteristics.
8. Typical daily values for CPU utilization, disk space use, direct I/O rate and page fault rate.
9. Average number of users per day.
10. Distribution of users over nodes.
11. Peak and off-peak periods.
12. Average number of processes per day.
13. Average response time.

Acquiring a detailed knowledge of your system's vital statistics needn't be an arduous process. As a system manager, you should be aware of your computer's hardware configuration and available software resources. As you perform routine system management functions such as software installation and user authorization, you will become familiar with the location and distribution of key operating system, application and user



## Making ends meet.

Sophisticated database applications require sophisticated user interfaces. When you have to meet tight deadlines and stay within budget, you need a powerful development tool up front—JAM/DBi™

JAM/DBi links JAM's front-end development tools with the database of your choice, including SQL-compatible database products like Oracle®, Informix®, Britton Lee™ and SQLbase™

But JAM/DBi does much more than provide access to your database and support SQL. It extends SQL's capabilities by automatically mapping query

results into the user interface, so that you can now create an entire application using just SQL and the JAM authoring tools.

JAM/DBi gives you power and flexibility. You can change screens independently of your database schema and move your database from one vendor to another without sacrificing the original look and feel of your applications.

Find out how JAM/DBi can help you make ends meet. For more information call

**800-458-3313**

Introducing  
**JAM/DBi**

CIRCLE 259 ON READER CARD

**JYACC**

In NY 212-267-7722.  
FAX 212-608-6753.

Signal Processing

Financial  
Modeling

Electronic  
Publishing

Computational  
Physics

Medical  
Imaging

Remote Sensing

Image Processing

Real-Time  
Simulation

Vibration  
Analysis

Seismic  
Processing

Well Logging

# Transform your MicroVAX into a Super- Workstation

... the new MAP-4000 Application Accelerator does just that! Its three boards plug directly into the back-plane of your MicroVAX, transforming it into a formidable math engine.

MAP-4000's global optimizing FORTRAN-77 compiler and extensive VMS-like debugging software help get your program up in a hurry, and its VAST<sup>®</sup>2 pre-processing compiler transparently optimizes your code with automatic calls to our Scientific Subroutine Library of over 500 functions.

The MAP-4000 performs a 1024 Complex FFT with bit reversal in 1.4 milliseconds. You get 40 MFLOPS single-precision or 20 MFLOPS double-precision performance, and your application will run 10 to 100 times faster, depending on the amount of vectorizable code.

MAP-4000's basic configurations include either 2 or 8 Mbytes of memory. Up to 40 Mbytes of additional memory are available, and there's address space for up to 1/4 gigabyte for future expansion.

MAP-4000 prices start at \$18,995\* —that's \$475/MFLOPS!

**Find out about the MAP-4000 advantage.** To receive your free 12-page brochure, call 1 800 325-3110 (in Massachusetts, 617/272-6020), or write CSPI, 40 Linnell Circle, Billerica, MA 01821. FAX: 508/663-0150.

\*quantity one, with 2 Mbytes of memory.

**CSPI**  
THE ARRAY PROCESSORS

**digital**  
Cooperative Marketing  
Program

MAP-4000 is a trademark of CSP Inc.  
MicroVAX and VMS are registered trademarks of Digital Equipment Corporation.  
VAST-2 is a registered trademark of Pacific-Sierra Research Corporation.

CIRCLE 261 ON READER CARD

images and data files. By regularly monitoring key operating system statistics and parameters, you'll develop an intuitive understanding of your computer system and its workload.

### Vital Signs

Most system performance problems can be traced to limitations in a computer system's memory, I/O or CPU subsystems. Because these subsystems are interrelated, a successful performance monitoring effort involves the collection of statistical information from all three resource areas.

Table 1 lists key parameters that are related to a computer system's overall performance and to the performance of the system's memory, I/O and CPU subsystems. Although maximum desirable threshold values are provided for many of these statistics, learn the values that your system exhibits when it's performing acceptably so that you can recognize abnormal situations. Before you begin a detailed investigation of the memory, I/O and CPU statistics listed in Table 1, take a quick system performance pulse by observing your system's response time and process count. Response time is the amount of time it takes the computer system to initiate a response to a user request. It can be determined by calculating the amount of time that elapses between issuing a simple DCL command to a subprocess and receiving the command's output.

Although response time is in the strictest sense a measure of CPU performance, it also can serve as an ad hoc measure of overall system performance. Similarly, after you're familiar with your computer's normal operating environment and workload, an atypical process count might alert you to abnormal system usage.

### Memory-Related Parameters

After you've determined your system's response time and process count values, your performance investigation should address key memory-related system

TABLE 1.	
General Statistics	I/O-Specific Statistics
1. Process Count 2. Response Time	1. Direct I/O Rate 2. Overall Cache Percent
Memory-Specific Statistics	CPU-Specific Statistics
1. Total Page Fault Rate 2. Modified Page Write Rate 3. Swap Rate	1. CPU Busy Percentage 2. Buffered I/O Rate 3. Lock Rate

*Key VMS system performance statistics.*

TABLE 2.	
Page Fault Rate	VAX Processor
30 faults/sec	MICROVAX I, VAX 11/725, 11/730
60 faults/sec	VAX 11/750
90 faults/sec	MICROVAX II, VAX 2000
100 faults/sec	VAX 11/780, VAX 8200
125 faults/sec	VAX 8250
175 faults/sec	VAX 11/785, VAX 8300
275 faults/sec	MICROVAX 3000, VAX 6210
300 faults/sec	VAX 8500
400 faults/sec	VAX 8530, 8550
425 faults/sec	VAX 8600
600 faults/sec	VAX 8650, 8700, 8810
Recommended paging rates are for VAX uniprocessor systems only. Maximum aggregate paging rates for VAX 83xx, 62xx and 88xx multiprocessors will vary with workload, application mix and number of CPUs per system.	

*Maximum recommended paging rates for VAX uniprocessors.*

parameters. You should focus on your system's total page fault rate, modified page write rate and swap rate.

Total fault rate is the total number of page faults on the system. The number of page faults per second that your system can handle reasonably is directly related to the speed of the CPU.

A VAX system can handle approximately 80 to 100 page faults per mip per second before incurring undue CPU overhead. So, for example, a VAX 11/780 can tolerate only approximately 100 page faults per second, whereas a VAX

8650 can handle approximately 600 page faults per second.

Table 2 contains suggested threshold values for several VAX CPUs. If your system's total page fault rate exceeds the appropriate threshold value, take steps to improve memory responsiveness.

A VMS system's modified page write rate reflects the amount of I/O activity devoted to writing pages from the memory-resident modified page list to

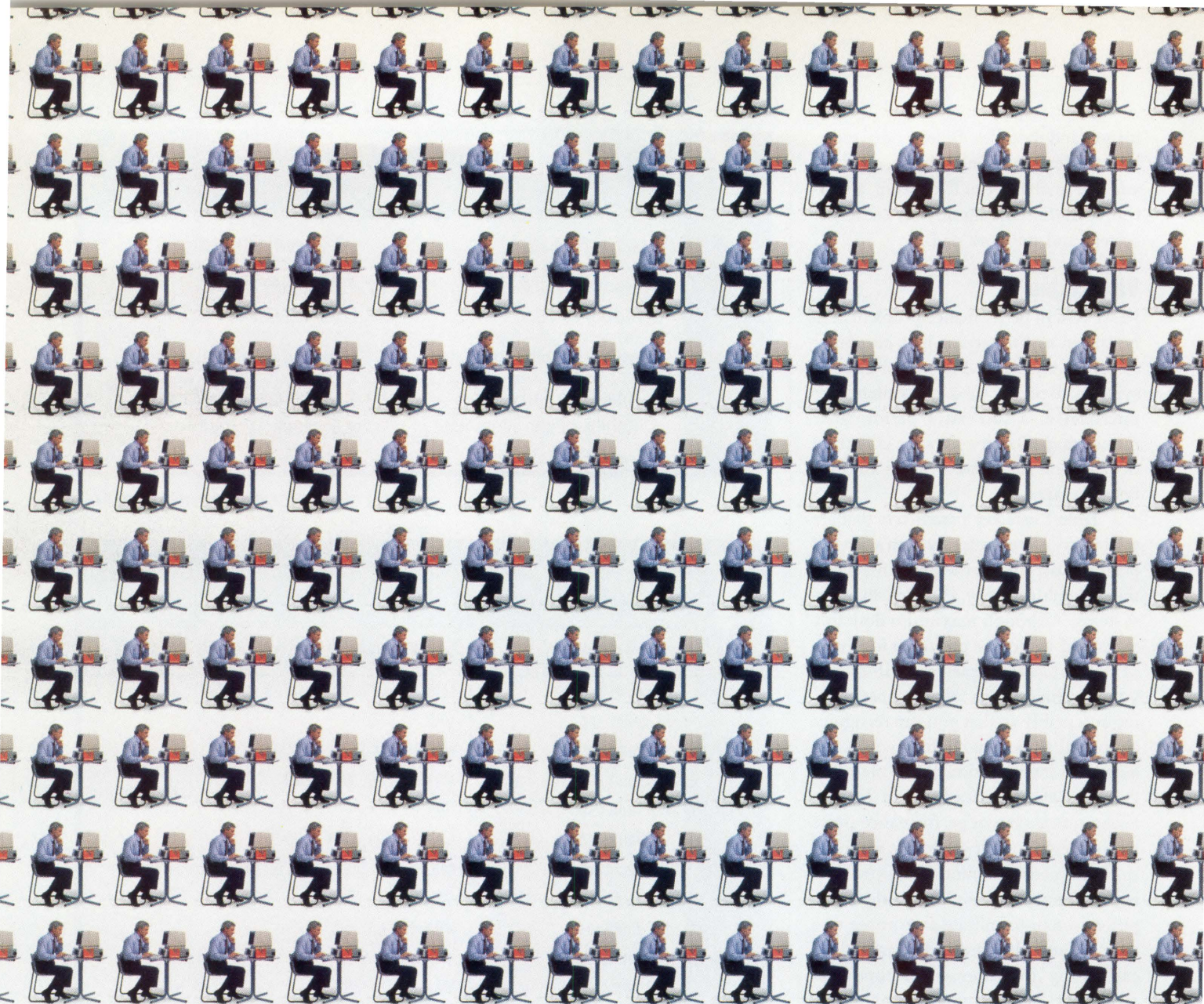

# 2,000,000 good reasons to add

Today, over two million people use Novell NetWare® to drive their PC networks. Not surprisingly, many of them are in companies which also have one or more DEC VAX minicomputers. Companies like yours.

Now Novell makes it easy for you to integrate PC users into your VAX network—and still maintain control of network information and resources.

**PC-to-VAX connectivity.** With NetWare for VMS, PC users can transparently access data, print services and applications on the VAX. Yet, because it runs as a single process

within the VAX, NetWare allows you to install, configure and control the network with standard VMS facilities.

Network security is enhanced by combining NetWare and VMS security features, while maintaining existing VAX security definitions set by the VAX system manager. And NetWare for VMS gives you the power of Advanced NetWare, plus full DECnet compatibility and connections to over 30 network topologies, including Token Ring and Ethernet.

**Total network integration.** As more and more users choose different desktop comput-

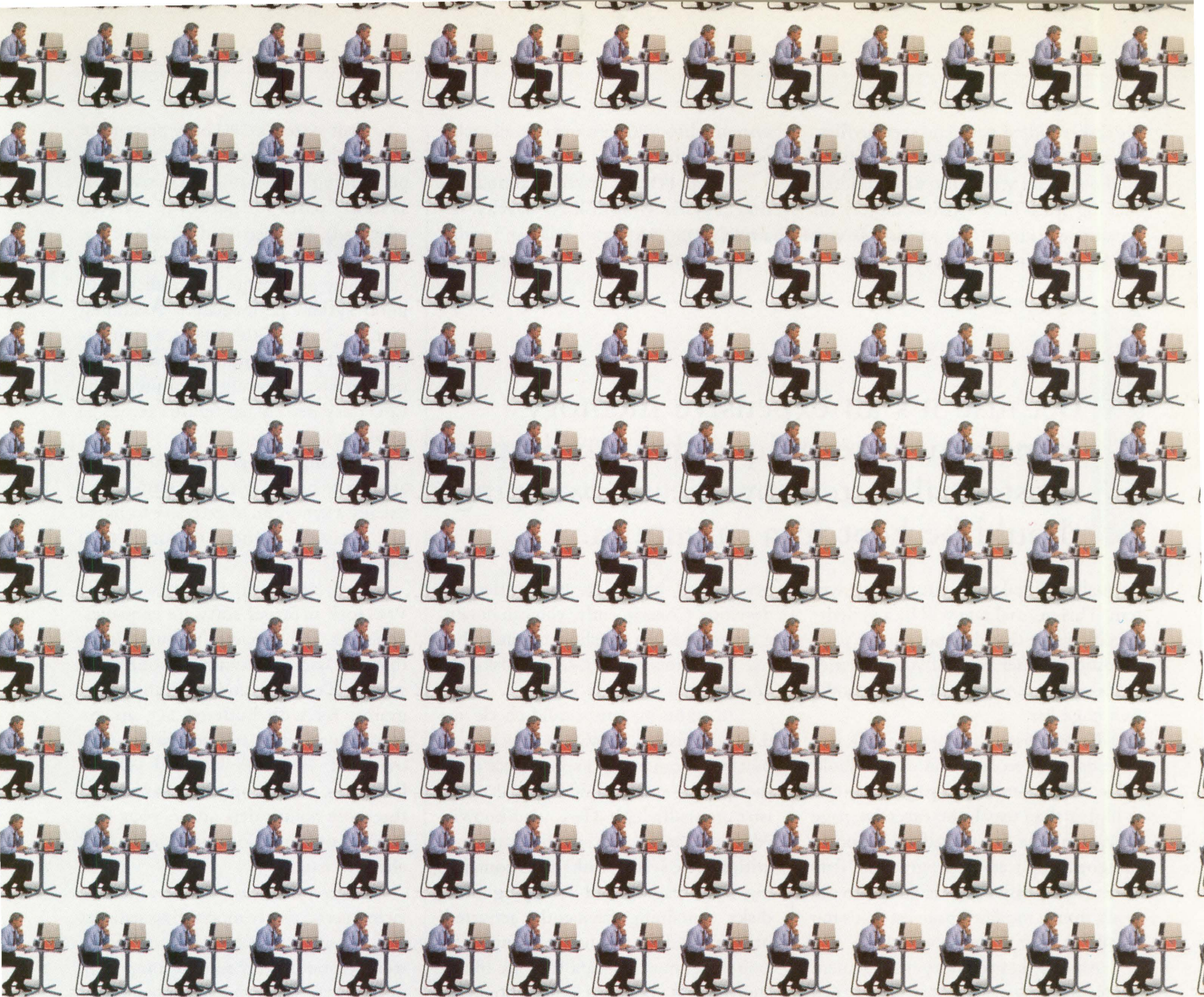

# NetWare for VMS to your VAX.

ing environments, system managers face a tricky task: integrate all of these diverse computers into a single workable network.

Choosing NetWare for VMS provides a simple solution. Not only does NetWare let you link PCs to your VAX, but it also gives you the freedom to connect to other important environments. So all of your departmental and corporate computing resources can work together as one seamless system.

Add value to your VAX by adding a powerful connection to the more than two million NetWare users worldwide. Get NetWare for

VMS. See your Novell VMS Certified Reseller, or call 1-800-LANKIND.

*For more information, call from your modem 1-800-444-4472 (8 bit, no parity, 1 stop bit) and enter the access code NVVMS22.*

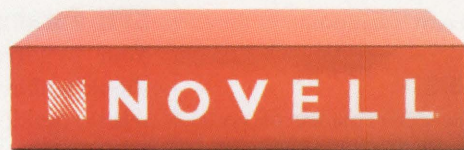

For network solutions,  
you should be seeing red.

CIRCLE 347 ON READER CARD

the disk-resident page and section files. Because the frequency with which modified pages are written to disk-resident backing store files depends largely on specific workload characteristics, you should determine what constitutes a

system's direct I/O rate and overall cache percent statistics.

Direct I/O rate provides an indication of systemwide disk I/O activity. As a rule, a DEC RA-series disk can handle a maximum of 25 to 30 I/O operations

Your system's CPU busy percentage reflects the percentage the CPU is busy performing user work (processing) or system work (operating system overhead). Because it's desirable to use as much of the CPU as possible, a high CPU busy percentage is an indicator of good system performance. Assuming that the bulk of the CPU's activity is dedicated to user processing, CPU saturation isn't a limiting factor unless the CPU busy percentage figure exceeds 90 to 95 percent.

Although a high buffered I/O rate appears to be an I/O-related statistic, it's usually a symptom of excessive terminal I/O activity, which requires CPU overhead.

Lock rate is the rate at which the VMS lock manager software enqueues, dequeues and converts resource locks that are associated with the operating system, file system and application programs. As with buffered I/O, an excessive lock rate manifests itself as CPU overhead. For both buffered I/O and lock rates, normal operating ranges and threshold values depend on your system's configuration and workload characteristics.

If a resource has become a limiting factor, performance monitoring statistics can be an invaluable aid to system troubleshooting, the second component of the performance management process. System troubleshooting is a remedial procedure that attempts to resolve resource bottlenecks through the iterative adjustment of system software parameters. It will be considered in detail in Part 2 of this series, along with methods to optimize performance.

— Terry C. Shannon is a Massachusetts-based author who specializes in DEC systems.

*Editor's note: A similar article appeared in the October 1988 issue of DEC USER, published in the United Kingdom and Europe. Used by permission.*

## Because it's an expensive memory management technique that can impose substantial system overhead, swapping should be kept to a minimum.

normal modified write rate on your system. This normal rate will be a system-specific value that depends on the page modification behavior of your system's workload and on the size of the modified page list.

If your system's total page fault rate exceeds the recommended threshold value, and the modified page write rate is higher than usual, the excessive page faulting might be related to a poorly designed application program or data structure. Excessive page faulting also can result from a modified page list that's too small for your system's workload.

Another key memory management parameter, system swap rate, is governed by a simple rule. Because it's an expensive memory management technique that can impose substantial system overhead, swapping should be kept to a minimum.

Each inswap or outswap operation generates a large data transfer; frequent swap I/O operations cause device or channel contention. Consequently, your system swap rate should be equal or close to zero unless you have compensated for a physical memory deficiency by adjusting your memory management subsystem to favor swapping.

### I/O Parameters

To ascertain the performance of your computer's I/O subsystem, observe the

per second before an I/O bottleneck develops. Consequently, you can obtain a systemwide I/O threshold by multiplying the number of RA-series disks on your system by 25 or 30.

In addition, you should check individual disk I/O statistics, because a bottleneck can occur on one device even though the systemwide direct I/O rate isn't unusually high. Here, your knowledge of the system configuration is critical. The system disk, disks containing large paging and swapping files, disks containing frequently activated images and disks that house key application programs and data files are likely sources of I/O bottlenecks and should be watched regularly.

Overall cache percent provides an indication of the effectiveness of your file system ACP caching. Your system's overall cache percentage rate should exceed 75 percent unless the total number of cache attempts is extremely low. A lower overall cache percent rate indicates that ACP caches aren't set up properly or that the system suffers from excessive disk fragmentation.

### CPU Parameters

Your performance investigation now should address the CPU subsystem. The relative health of the CPU subsystem can be gauged by focusing on your system's CPU busy percentage, buffered I/O rate and lock rate.

ARTICLE INTEREST QUOTIENT  
Circle On Reader Card  
High 450 Medium 451 Low 452



# Unlimited Resources.

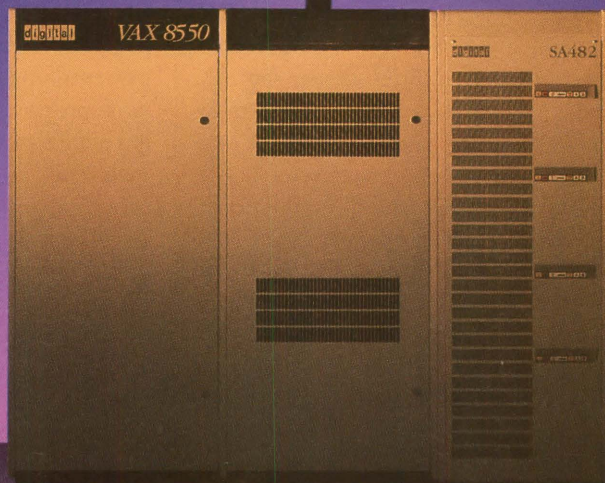
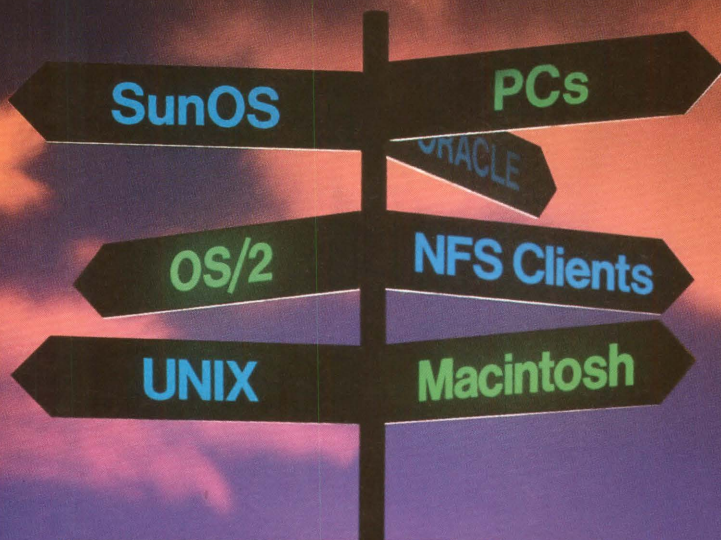

**NOW  
SUPPORTING  
VMS 5.0**

Finally, you can get what you need from your VAX no matter what direction you're coming from, with Excelan's LAN Service™ for VMS. Whether you're working with PC DOS, OS/2, NFS, UNIX, SunOS or Macintosh. Excelan's LAN Service for VMS provides transparent and concurrent access at the highest performance.

With the LAN Service for VMS, a wide variety of desktop platforms can communicate seamlessly with the extensive resources of your VAX.

When teamed up with NFS, your VAX becomes a powerful file server for Sun workstations and the other desktops throughout your company-wide net-

work. And the LAN Service for VMS manages the elaborate networking protocols without burdening the processing powers of your VAX.

To make full use of your resources and join forces with your VAX, call **1-800-2-GET-LAN** for the LAN Service for VMS networking solution.

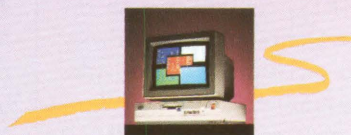

**EXCELAN**

2180 Fortune Drive San Jose, California 95131 800-2-GET-LAN FAX 408-434-2310 Telex 176610  
Excelan Europe, Ltd. Intec 2, Suite 17, Wade Road Basingstoke, Hampshire, RG24 0NE England, UK  
Tel: (44)256-842296 FAX (44)256-842298

Excelan is a registered trademark; LAN Service is a trademark of Excelan, Inc. VAX and VMS are trademarks of Digital Equipment Corporation. OS/2 is a trademark of International Business Machines, Inc. Sun and SunOS are registered trademarks; NFS is a trademark of Sun Microsystems, Inc. licensed to Excelan, Inc. UNIX is a trademark of AT&T Bell Labs. Macintosh is a trademark of Apple Computer, Inc. Copyright © Excelan, Inc., 1988. All rights reserved.

**CIRCLE 325 ON READER CARD**

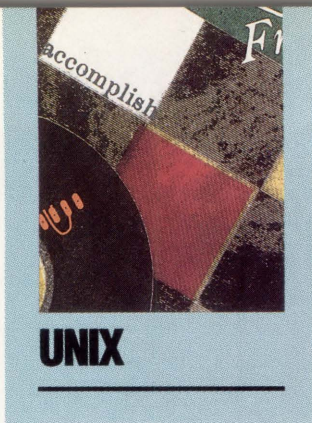

# R EAL-TIME UNIX

By Evan Birkhead

## Striving For Optimum Response Time.

For years, scientists and engineers with real-time UNIX applications in multiprocessor settings have pined over UNIX's inherent real-time constraints. With the release of Real-Time UNIX (RTU) version 4.0, Massachusetts Computer Corporation (Masscomp) of Westford, Massachusetts, has developed a flavor of UNIX that it believes will make UNIX a competitive alternative in the real-time marketplace.

Your initial questions might be, "How fast is RTU? Is it only sufficient real-time or is it *real* real-time?" RTU processes at 900 microseconds on the average (for 3.5 million random interrupts) and 5 milliseconds at worst, and Masscomp has clocked it at 500 microseconds.

The results depend on the yardstick used. Masscomp has measured all hardware and software dispatch latencies from the time of receipt of an external interrupt (a real-world signal) through to the execution of a high-level process. Anything close to even 2 milliseconds is about a 300 percent improvement over the average version of UNIX running a real-time application.

Significantly, RTU is a standard implementation of UNIX, compliant with the System V Interface Definition and Berkeley 4.2. In addition to real-time, RTU provides multiprocessor capabilities.

The optimal platform for RTU V4.0 is

Masscomp's 6000 series of microprocessing computers, a family of four Multibus machines powered by Motorola 68020 and 68030 microprocessors (see Figure 1). Masscomp also has added accelerators and additional cache to each chip. But multiprocessing is key to achieving real-time throughput.

The 6000 series consists of the 6300 single- or dual-processor workstation at the low end, and the 6400 single- or dual-processor rack-mount expansion; the 6600 midrange computer, supporting up to three processors; and the 6700 high-end system, supporting up to five processors. The series provides expansion options for the Multibus, VMEbus and Masscomp's STD+ data acquisition bus.

Each computer contains proprietary floating-point and vector accelerators. The 6700 has five floating-point processors, five floating-point accelerators and four vector accelerators.

In terms of software, each computer has a platform-specific extension to MIT's X Window System Version 11. The computers can link into VAX networks through DECNET/Ethernet, NFS, TCP/IP or DR11-W drivers.

### The Real-Time Marketplace

Real-time applications span a wide range, from relatively low-speed process control through high-demand military flight simulation. Masscomp is pushing RTU and the 6000 series in three markets:

1. Real-time simulation, i.e., image processing.



# Now the best seller comes in an illustrated edition.

With the WY-85 at left, Wyse authored the best selling alternative to DEC's VT-220. It's fully compatible with the VT-220, but loaded with features that make it even more compatible with the people who use it.

Like a larger 14" screen. Tilt and swivel base. An easier set-up mode.

And while our keyboard is identical to DEC's in layout, they can't touch our touch.

Our new WY-99GT at right further illustrates Wyse's continuing drive to improve on a standard. It features the same advantages as the WY-85. Plus graphics, with full Tektronix 4010/4014 compatibility, and high resolution characters.

Our dual resolution mode lets you retain full VT-220 compatibility and shift from DEC resolution to hi res.

And there's a happy ending. The WY-85 is just \$499, the WY-99GT \$649. Both are made, serviced, and supported by the world's leading independent terminal manufacturer.\*

Wyse. When it comes to quality and value in terminals, we wrote the book. For more information, call 1-800-GET-WYSE.

**WYSE**  
| | | |

**We make it better, or we just don't make it.**

Trademarks/Owners: Wyse, WY-85, WY-99GT/Wyse Technology; DEC, VT-220/Digital Equipment Corporation; Tektronix, 4010, 4014/Tektronix. Screen image on WY-99GT created using Cognos Power House. \*IDC 1986 U.S. Terminal Census.

**CIRCLE 258 ON READER CARD**

# FIGURE 1.

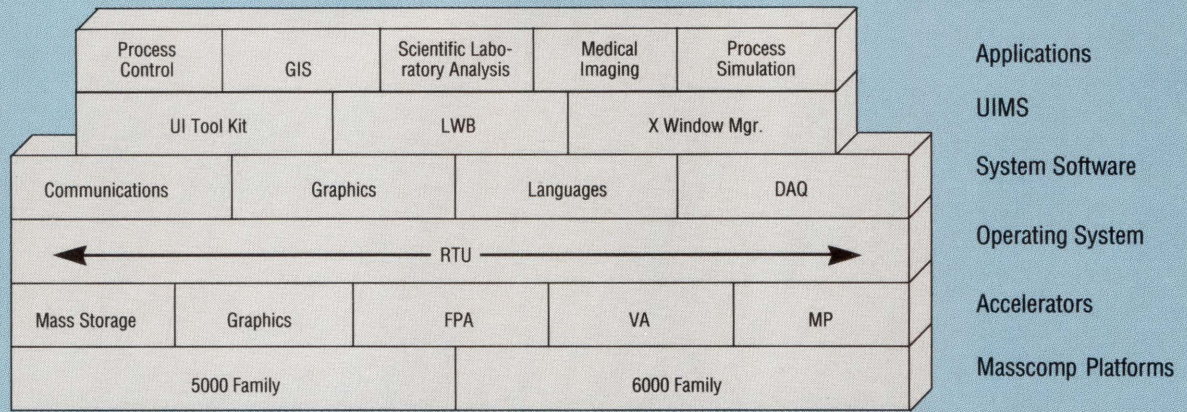

Architecture of a Masscomp real-time environment with hardware at the bottom and high-demand applications at the top.

2. Measurement and control, i.e., speech recognition systems.
3. Command, control, communications and intelligence (C3I), i.e., radar and sonar acquisition.

This is high-torque processing, involving scalar and vector calculations up through floating-point math, Fast-Fourier Transforms and beyond. Despite its technical nature, the market is growing, some estimate as much as 40 percent each year. The market research firm Dataquest predicts that by 1990 the real-

time simulation market will reach \$1.1 billion, the measurement and control market \$5.32 billion and the C3I market \$2.42 billion.

At the high end of these applications, the competition includes Gould, Harris, DEC and IBM. At the workstation level, it includes Sun, Alliant and Hewlett-Packard. Interestingly, Masscomp's founders came from DEC and HP.

In October, Masscomp merged with Concurrent Computer Corpora-

tion (another major player in the UNIX real-time arena) to form a company called Concurrent. The RTU V4.0 will continue to be offered by Masscomp for the next two years.

"Each company has complimentary strengths: Concurrent Computer Corporation, a worldwide distribution system; and Masscomp, a demonstrated ability to develop unique UNIX-based systems for the highly specialized real-time computing market," says Russell Planitzer, Masscomp's president.

Masscomp has no current plans to enter the Open Software Foundation, but is a member of the POSIX committee (RTU is POSIX-compliant) and the IEEE 1003.4 real-time standard subcommittee.

## The RTU Extension Set

The following elements of RTU are pivotal to its fast data throughput:

1. Multiprocessing (or parallel processing).
2. A Data Acquisition Control Processor (DACP).
3. Asynchronous I/O.
4. Kernel preemption, fixed-priority scheduling and other response-time variables.
5. Interprocess communication.

# FIGURE 2.

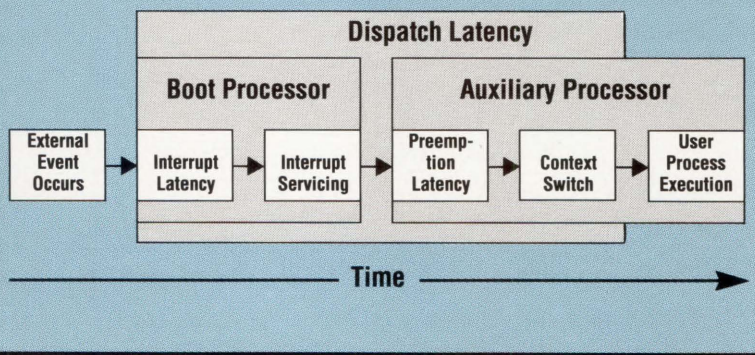

RTU version 4.0's major improvements are in Dispatch Latency, with a focus on Preemption Latency.

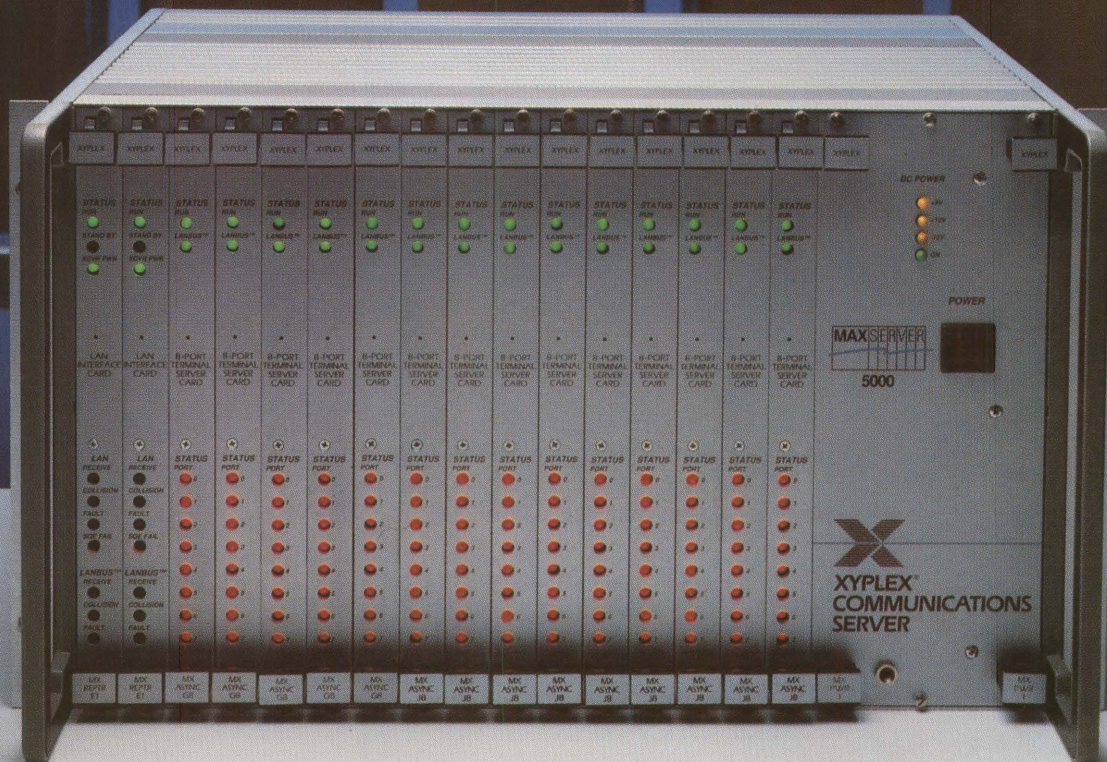

## WHY BUY JUST A TERMINAL SERVER WHEN YOU CAN HAVE A MAXserver.

There's a big difference in VAX™ terminal servers. Which is why it pays to compare before you buy.

Just look at the chart below. The MAXserver™ from Xyplex™ offers superior connectivity, with TCP/IP support and integrated LAN/WAN capability. The DECserver™ doesn't.

The MAXserver offers more throughput. Up to 120 ports from one compact unit. Hot-swap capability so you can add cards without any downtime. Redundant power supplies and multiple network interfaces for non-stop performance. All features you won't find with the DECserver.

Yet the MAXserver actually costs less!

### The support of a communications leader.

Xyplex specializes in VAX servers, and has for years. So we can offer you advantages that Digital simply can't match. It's why we're now installed in each of the top 15 VAX accounts around the world.

And we back the MAXserver family with full service and support. Each MAXserver is covered by an unprecedented three-year warranty that includes all parts and labor. Digital gives you one year.

### Free Report and Case History File.

We've prepared a Case History File that will let you read first-hand what actual users have to say about our product. We'll also send you a 12-page in-depth report comparing the DECserver and the MAXserver.

Shouldn't you compare before you buy? Call or write today for your free report and Case History File. Once you know the facts, you won't settle for just any terminal server.

**Call 1-800-338-5316**

FEATURE	DECserver	MAXserver
TCP/IP Support	No	Yes
Integrated LAN/WAN	No	Yes
Hot-Swap Cards	No	Yes
Processing Power	1 MIPS	15 MIPS
Redundant Power Supply	No	Yes
Warranty	1 Year	3 Years



Xyplex, Inc.  
100 Domino Drive  
Concord, MA 01742

# RTU Extensions To UNIX

## High-Throughput Multiprocessing

- Automatic process scheduling from a single run queue.
- User control over which CPU runs which process (any of all, any of several, or just one).
- Ability to dedicate a CPU to one real-time process.
- Ability to service all interrupts, paging and swapping on the boot processor, thus freeing other CPUs from associated latencies.

## Improved Response Time

- Fixed-priority scheduling guaranteeing that real-time processes execute before normal processes.
- Main memory locking of all or parts of a process to prevent unwanted paging and swapping.
- Process preemption allowing higher-priority tasks to run when ready, before lower-priority tasks.
- Kernel preemption allowing higher-priority tasks to run unimpeded even when lower-priority processes are executing system calls.

## Interprocess Communication (IPC)

- All System V IPC features, including named pipes, message queues, semaphores and shared memory regions.
- All 4.2 BSD IPC features, including Berkeley signals and sockets.
- ASTs, software interrupts which, unlike signals, can pass information, can be assigned priorities, queued, and never be lost.
- Reserved memory, which allows a process to incorporate external memory into its address space. Used principally for direct communication between user address space and devices on the system bus.
- Pipes, implemented in main memory rather than on disk, to accelerate performance.

## Direct Bus Communications Between User Processes And Devices

- External memory allows direct, unmediated communication between the user address space and devices on the system bus.

## Faster Disk I/O

- DMA between disk and user address space bypasses the block buffering I/O system when transferring large quantities of data.
- Contiguous files speed disk I/O by reducing seek times.
- Multiple swap files increase performance by reducing time needed for swapping.

## High-Speed Synchronous Or Asynchronous Data Acquisition

- Independent DACP offloads CPUs.
- Data acquisition and storage to disk may proceed either synchronously or asynchronously with computations.
- Asynchronous I/O allows multiple data transfers between I/O devices, main memory and disk to proceed concurrent with computation-intensive processing.

6. DMA between disk and user address space.

Real-time computing thrives on multiprocessing systems. The premise behind multiprocessing is that while one processor executes real-time processes, another processor handles new

interrupts as they come through (see Figure 2).

## Multiprocessing

On a four-processor system, for example, the four highest-priority runnable processes will execute simultaneously, one on each of the four CPUs. The 6000

computers share a global memory and a common run queue, so load balancing is automatic.

In this way, multiprocessors relieve bottlenecks that can slow response times unpredictably in single-processor systems. Parallel processing systems provide the best environment for real-time computing.

RTU's handling of multiprocessors provides for real-time parallel processing, but the processing isn't completely symmetric. All interrupts and all physical I/O with devices on the system bus are serviced on the boot processor. In RTU, all interrupt handling is restricted to the boot processor.

Several execute functions, including paging and swapping, virtual memory management, and any system call that affects the file table, also must run on the boot processor.

RTU is based on a master-slave CPU relationship. The boot processor is the master, handling peripheral devices, networking, graphics and memory management. The slave, which can be any of the remaining multiprocessors, can execute user code, the scheduler and most system calls. Any slave can be dedicated to one or more processes.

Under RTU, systems and application tasks can be scheduled dynamically so that users can access slave processors transparently. Or they can dedicate processes to execute on specific computers. RTU is capable of dedicating processors exclusively for applications with special requirements.

## Interrupt Service Time

To contend with an event (during the Interrupt Latency period in Figure 2), RTU employs DACP, which offloads the CPU. Supporting analog or digital interfaces, this device takes real-world events and converts them into system software interrupts. An 8-mips bit-slice coprocessor, the DACP also manages real-time control with a programmable clock.

DACP interrupts are serviced on

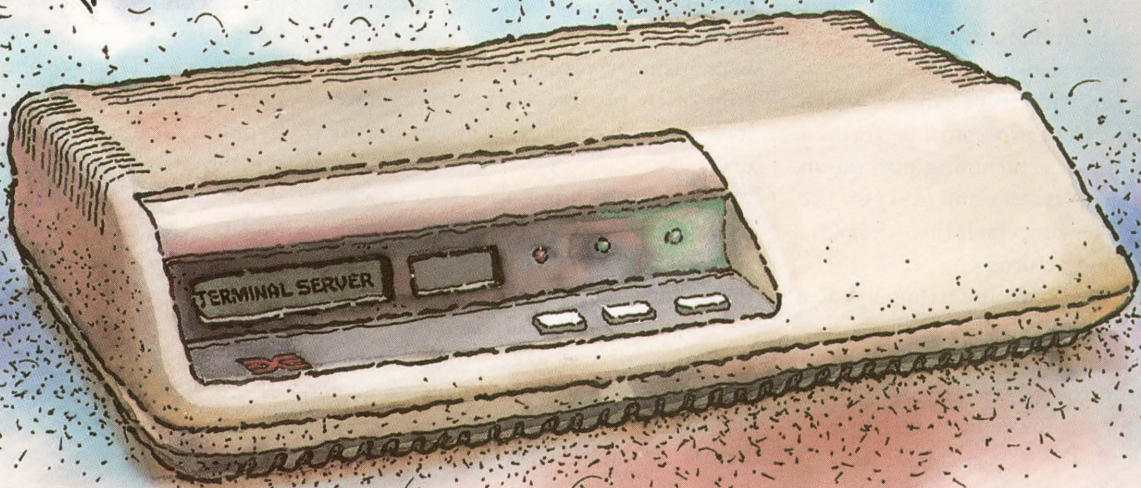

## Our Ethernet Terminal Server Speaks LAT. Everywhere.

Which is good news for performance-minded companies. Our new Performance 4000 Ethernet Terminal Server is fully LAT-compatible. No special hardware interface, no new driver, no network management software required. Plug it in and put it to work. It will deliver a lot more performance than the DECserver 200, for a lot less cost per line.

It also provides more room for expansion. The Performance 4000 sup-

ports up to 32 lines, in a package only 4½ inches high. Run all 32 at 19.2Kbps, or 16 at 38.4Kbps. *Simultaneously.* You also get better multiscreen displays, enhanced security features, plus a superset of DECserver commands and VMS-like command editing.

So if you're thinking of expanding your Ethernet Local Area Network, call our Emulex offices worldwide and ask about the Performance 4000.



Performance 4000 Ethernet Terminal Server

Call (800) EMULEX-3, or  
(714) 662-5600 in California  
Emulex Corporation  
3545 Harbor Blvd.  
Costa Mesa, CA 92626



Regional Offices: Anaheim, CA (714) 385-1685 Atlanta, GA (404) 587-3610  
Burlington, MA (617) 229-8880 Chicago, IL (312) 490-0050 Dublin, CA (415) 829-1170  
Teaneck, NJ (201) 836-3717 Washington, DC (703) 264-0670  
International Offices: Bracknell 344-484234 Munich 89-3608020 North Sydney 2-957-1669  
Paris 134-65-9191 Tokyo 3-234-8951 Toronto (416) 673-1211  
LAT and DECserver are registered trademarks of Digital Equipment Corp.  
© 1988 Emulex Corporation, Inc.

## To improve UNIX response times, RTU incorporates fixed-priority scheduling, memory locking, process preemption and kernel preemption.

the boot processor, with a maximum service interrupt latency of 1.6 milliseconds and a maximum interrupt service of 2.5 milliseconds. DACP interrupts are serviced immediately.

The DACP interrupt handler, which runs on the boot processor, performs a number of tasks, including posting an asynchronous system trap (AST) for the real-time user process. It then clears the interrupt and returns.

After the DACP interrupt handler has posted an AST to the real-time process residing on the auxiliary processor, the entire process can be run without waiting for any lower-level interrupts to be serviced.

### Improved Execution Times

To improve UNIX response times, RTU incorporates fixed-priority scheduling, memory locking, process preemption and kernel preemption.

1. Fixed-priority scheduling — Approximately 15 times a second, the UNIX kernel adjusts process priorities, favoring interactive processes with light CPU use at the expense of those using the CPU heavily. RTU sets nine levels of priorities for interrupt processing, without penalties for those that monopolize processor times. In fact, real-time priorities are favored.

2. Memory locking — Paging and swapping create slow process execution times in virtual memory. RTU locks all or part of a process into main memory with two calls: `plock(2)` from System V, and `plockin(2)`, an RTU-specific page locking call. `Plock(2)` allows either the

text, data or both segments to be locked into main memory. `Plockin(2)` allows individual text, data or stack pages of a time-critical process to be locked into main memory, providing more selective control. A process with one or more locked pages can't be swapped out to disk.

3. Process preemption — RTU checks to see if lower-priority processes that are running can be blocked and rescheduled.

4. Kernel preemption — Preemption points have been built into the RTU kernel so that system calls don't have to block or run to completion before giving up control. This reduces delay before the higher-priority process can begin or resume executing.

The time required to switch processes during kernel preemption is called the context switch (see Figure 2). This is a Save/Restore routine that UNIX traditionally doesn't offer.

The RTU kernel's metrics facility, which allows it to do kernel preemption, implements many of the properties used in RSX and RT-11, two of DEC's PDP-11 operating systems. In many respects, RTU is an evolution of RT-11's contiguous file structure. Additionally, a number of AT&T's synchronization mechanisms that are inherent in UNIX have been applied to real-time.

### Interprocess Communication

All System V interprocess communication facilities (IPCs), i.e., signals, shared memory, semaphores, messages and named pipes, are in RTU. RTU also implements some Berkeley-specific facilities. But the main extension RTU incorporates into its IPC is AST.

ASTs are software interrupts similar to signals. Signals are the software interrupts sent to a process by the kernel or by a user process. However, a process isn't limited to the number of ASTs it can send, while signals are limited to 32. Additionally, ASTs can be queued at the processor by assigned priorities. RTU's ASTs aren't portable to other UNIX systems.

### DMA

To speed disk I/O, RTU implements DMA between disk and user address space, contiguous files and multiple swap files.

1. DMA — During time-consuming memory-to-memory transfers, RTU bypasses the block buffering I/O system whenever possible. It's possible when the transfer involves four or more blocks of data and is a multiple of 512. The data must be aligned on a block boundary and the block must be contiguous on disk. RTU will break up requests to make this happen.

2. Contiguous files — RTU has con-

## RTU V4.0

**PLATFORMS:** Masscomp 6000 series

**PRICE:** \$24,900 — \$120,000

### MASSCOMP

#### HEADQUARTERS:

One Technology Way  
Westford, MA 01886  
(617) 692-6200

**FOUNDED:** 1981

**PRODUCT LINE:** Real-time implementation of UNIX on a multiprocessor architecture

**REVENUES:** \$74.6 million

**OWNERSHIP:** Public (NASDAQ: MSCP)

**BRANCHES:** 25 U.S. and 6 international sales and service offices, and 12 international distributors

CIRCLE 429 ON READER CARD



# SOME THINGS JUST NATURALLY GO TOGETHER.

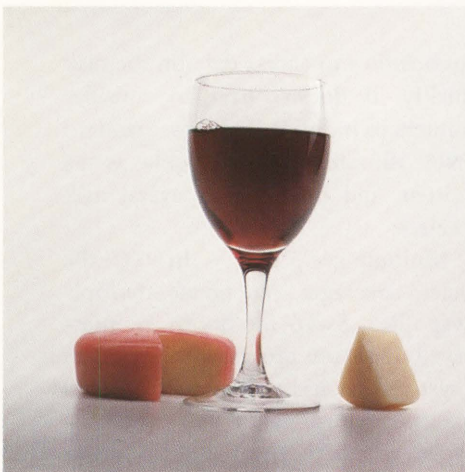
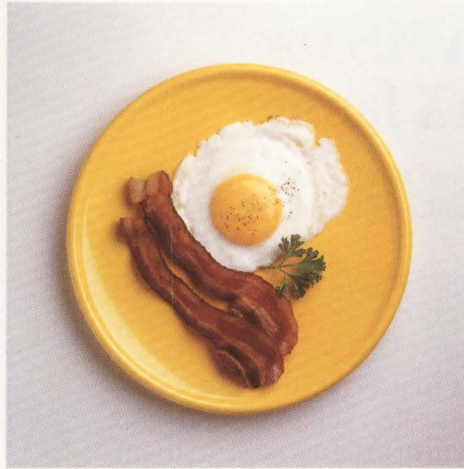

Like needle and thread. Salt and pepper. Emulex and MicroVAX. All are considered well-known pairs.

So it should come as no surprise that Emulex has introduced a family of high-performance controllers for DEC's new MicroVAX 3500/3600 computers.

Two new Emulex products are MSCP disk controllers which support a well-known pair of drives. The QD34 can support four SMD-E drives of any capacity with transfer rates of 3 megabytes per second. The QD24 easily handles four compact ESDI drives with data transfer rates to 15 megabits per second.

Another new product, the QT14 tape controller, features the industry's only switch-selectable capability for a pair of well-known emulations - TMSCP and TSV05.

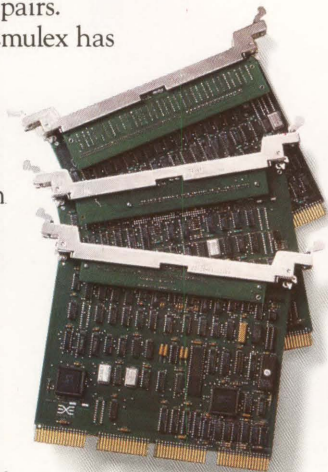

These new products reflect the new MicroVAX form factor and, of course, are totally DEC-compatible. So if you're considering one of the new MicroVAX models, include an Emulex controller to make another well-known pair. After all, some things just naturally go together.

Call (800) EMULEX-3, or  
(714) 662-5600 in California  
Emulex Corporation  
3545 Harbor Blvd.  
Costa Mesa, CA 92626



Regional Offices: Anaheim, CA (714) 385-1685 Atlanta, GA (404) 587-3610  
Burlington, MA (617) 229-8880 Chicago, IL (312) 490-0050 Dublin, CA (415) 829-1170  
Teaneck, NJ (201) 836-3717 Washington, DC (703) 264-0670  
International Offices: Bracknell 344-484234 Munich 89-3608020 North Sydney 2-957-1669  
Paris 134-65-9191 Tokyo 3-234-8951 Toronto (416) 673-1211

DEC and MicroVAX are registered trademarks of Digital Equipment Corp.

©1988, Emulex Corporation, Inc.

CIRCLE 264 ON READER CARD

# KDSS

DEMO KIT  
AVAILABLE

## A full-featured, high-performance Data Entry System is available under VAX/VMS for the entire VAX family.

**Powerful.** KDSS has an extremely wide range of screen formatting, editing/validation, and output data reformatting capabilities which permit great flexibility.

**Efficient.** All performance-critical portions of KDSS are written in VAX assembly language. The data entry code is shareable. Terminal output is buffered to minimize QIO's.

**Extensible.** KDSS provides for access to user-written programs to perform special edits, reformat data, etc.; you may either link such programs with the KDSS data entry program or run them as separate processes that communicate with KDSS via VAX mailboxes.

**Proven.** Previous versions of KDSS have been widely used for over ten years: first on the PDP-11 and, subsequently, on the VAX in PDP-11 compatibility mode. The new version of KDSS runs in native mode on the VAX to provide support for the entire VAX family.

**EG&H. Our specialty is DEC.** For over fifteen years, we have designed and developed minicomputer software to improve productivity and get more out of DEC systems. We not only license our software products, we also develop custom applications. Count on us for quality products and expert support.

### Other software products for VAX/VMS and RSTS/E.

- **ROSS/V** a RSTS/E operating system simulator under VAX/VMS.
- **DIALUP** a data communications package that links RSTS/E and VAX/VMS systems to remote computers.
- **TAM** an efficient screen formatter for transaction processing applications.
- **VSELECT & SELECT** fast file scanning packages.
- **VSORT & FSORT3** high-speed sort packages.
- **BSC/DV** a device driver for DEC's DV11.

For more information, call  
(617) 861-0670 or write:  
Evans Griffiths & Hart, Inc.  
55 Waltham Street  
Lexington, MA 02173  
TWX: 710-326-0103

Evans  
Griffiths  
&  
Hart, Inc.

# EG&H

RSTS, VAX, DEC, and VMS are trademarks of  
DIGITAL EQUIPMENT CORPORATION.

CIRCLE 282 ON READER CARD

### Companies Mentioned In This Article

Concurrent Computer Corp.

106 Apple St.  
Tinton Falls, NJ 07724  
(201) 758-7000  
(800) 631-2154

CIRCLE 428 ON READER CARD

Digital Equipment Corp.

146 Main St.  
Maynard, MA 01754  
(617) 897-5111

CIRCLE 400 ON READER CARD

Massachusetts Institute Of Technology  
(MIT)

77 Massachusetts Ave.  
Cambridge, MA 02139  
(617) 253-1000

CIRCLE 430 ON READER CARD

tiguous files to access data on the disk quickly. It doesn't have to consider pointers to individual blocks. Standard UNIX allocates file space only as it's written, and can require several disk accesses.

3. Multiple swap files — In RTU, the system manager can create multiple swap files. Swap file access is interleaved. If a 1-MB process is swapped on a system that has two swap files, RTU writes 0.5 MB to each swap file. If the two swap files reside on different disks, the system realizes a significant performance gain. As many as 10 swap files can exist on a system.

Purists define *real* real-time as less than 1 millisecond. These aren't UNIX people. In any event, the real-time battle is never-ending. Masscomp has promised that future releases of RTU will decrease dispatch latencies further, ensuring still faster response times. Besides porting RTU to a new platform, Masscomp and Concurrent Computer Corporation are rewriting the real-time kernel and are trying to reach 10 microseconds.

ARTICLE INTEREST QUOTIENT

Circle On Reader Card  
High 431 Medium 432 Low 433



# It's 4:00 a.m. Your VAX just polled 50 remote PC's!

Sales reports, orders, inventories and payroll data, production figures, spreadsheets or any other data need . . . with BLAST II it'll *all* be there when you get to work in the morning.

Now your VAX, PC or MAC can be automated to transfer data among many different computers, anywhere in the world . . . error free and unattended! PCs, MACs, Minis, and Mainframes all become members of an intelligent software network with BLAST. (Even UNIX and Xenix can be included.)

One simple, built-in scripting language lets you quickly create totally automated operations. Your VAX, PC or MAC manages each session, dialing out (and redialing remote computers), managing modems, logging on, executing commands, and transferring data according to your scripts. If you want to hook into your application, that's easy, too. And VT-100/220 emulation is included.

Running on both ends of the link, BLAST's unique "protected pipelining protocol" delivers fast, error-free data through noisy phone lines, satellite-routed calls or X.25 networks.

No add-on boards or extra hardware are needed, and any dial-up modem can be used, even the new, high-speed 9600 and 19.2 or V.32 modems.

Discover why Blast has been chosen by EXXON, the USDA, Bankers Trust, Blue Cross, H & R Block and others for connecting hundreds of remote sites, with one software package!

For more information, call . . . **1-800-24 BLAST**

## **BLAST**<sup>®</sup>

### Communications Research Group

5615 Corporate Boulevard, Baton Rouge, Louisiana 70808 (504) 923-0888

CIRCLE 180 ON READER CARD

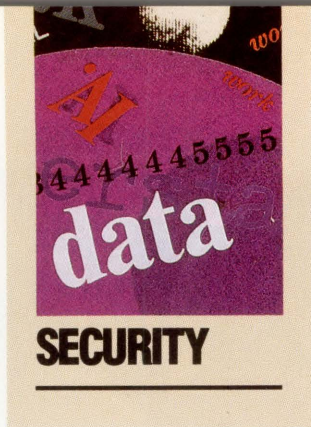

# S

# YSTEM

# SECURITY,

# PART 2

By David W. Bynon

*Editor's note: In this second and final part on system security, David W. Bynon discusses the features, problems and management of VAX/VMS internal security.*

**When The System's Locked Up, It's Out Of Enemy Hands.**

People trust people. But as we saw last month in Part 1, one person with bad intentions and the key to the kingdom can destroy the computer system empire. This month, we'll analyze ways to lock the fortress and keep the kingdom out of enemy hands.

## VMS Secure Reference Model

Every secure computer system bases its internal protection on some theoretical model. DEC chose the Secure Reference Model for computing and data storage systems. It defines a computer system in terms of subjects, objects and a reference database.

Subjects are jobs or users running on the computer system who desire access to the objects. Objects are tangible, such as memory, files, directories or peripheral devices.

To permit a subject to access an object, the reference monitor employs a mediator. When a subject requests access to an object, the reference monitor checks its reference database to see if the requested access is permissible.

When a security event occurs, such as an unauthorized attempt to access a file, the reference monitor logs that event in the secur-

ity audit trail. That trail provides a means to trace attempts to violate system security.

A VMS system uses many components to implement the secure model. However, to VMS, the most important internal security mechanism is the User Identification Code (UIC), which is used to identify users (subjects) of the system and the ownership of objects.

## UIC Protection

The primary VMS protection mechanism, UIC is an identifier used to recognize users and groups of users and to protect system objects.

A UIC is defined for each user through a field in the system user authorization file. It can be numeric or alphanumeric. The numeric UIC is specified as a pair of octal values enclosed in brackets, i.e., a group number and a member number.

The alphanumeric UIC format is specified as one to 31 characters in brackets. Unlike the numeric UIC, an alphanumeric UIC can contain the group and member components or simply the member.

Most user accounts on VMS version 4.x systems have both a numeric and an alphanumeric UIC. This makes them compatible with earlier versions of VMS, in which only the numeric UIC was used.

UIC protection manages four basic types of operations and four categories of users. The operations are based on the functions that a

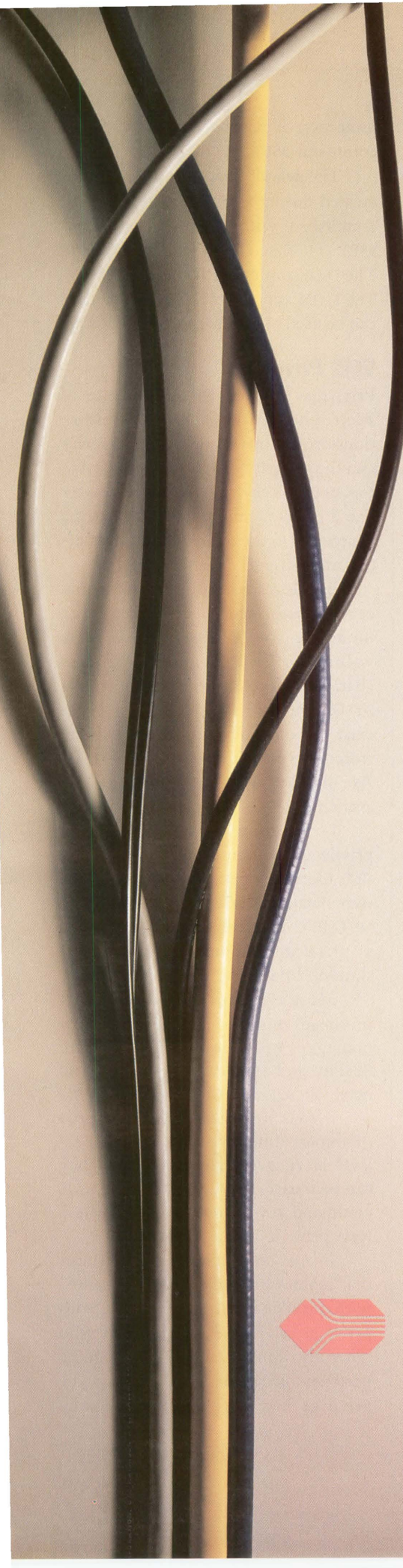

# You've created several different LANs. We'll tie them together.

OK. Your facility has a number of Ethernet Local Area Networks.

And now you have to tie them together. But some are on broadband, and a few more are on baseband. One or two are even running on twisted pair cables.

This is where we come in. We're Chipcom. A company solely dedicated to Ethernet connectivity. We have the resources, the people, and the knowledge to supply your LAN connectivity needs.

That's why we created the new Ethermodem III Bridge.<sup>™</sup> It connects baseband, fiber or twisted pair Ethernet networks to your broadband Ethernet backbone to form a single, high-performance LAN.

And, more recently, the new Marathon Bridge<sup>™</sup> that uses a long distance IEEE 802.4/MAP broadband backbone to link your separate IEEE 802.3 and Ethernet LANs, while also allowing inter-operation among MAP and TOP<sup>™</sup> nodes on the extended LAN.

Both Bridges offer full 10 Mbps performance. Each can, very simply, make one LAN out of many. Quickly, easily, and with no loss of performance.

Regardless of what type of Ethernet LAN you're working with, you'll find that when the problem is connectivity, the answer is usually Chipcom.



## CHIPCOM

*Quality products. For reliable networks.*

195 Bear Hill Road Waltham, MA 02154  
617-890-6844 ext. 292 Telex: 928338CHIPCOM UD Fax: 617-890-6857

Ethermodem III Bridge and Marathon Bridge are trademarks of the Chipcom Corporation.  
TOP is a trademark of the Boeing Company.

**CIRCLE 103 ON READER CARD**

computer can perform on a file: READ, WRITE, EXECUTE and DELETE.

Categories of users include SYSTEM (anyone with SYSRV), OWNER (the owner of the object), GROUP (anyone within the same UIC group) and WORLD (everyone). UIC protection is applied to system objects, including files, directories, devices, queues and mailboxes.

UIC protection use is simple. Access is granted or denied on a category-by-category basis. For instance, a file with UIC protection that permits read, write and execute access to the OWNER only is protected from the WORLD and anyone within the same GROUP. UIC protection is established using the DCL SET PROTECTION command, as in:

```
$ SET PROTECTION=(S,O:RW,G,W) ACCOUNTING.DAT
$ SET PROTECTION=W:RWE /DEVICE TXAD:
$ SET PROTECTION=(O:RWE,G:RWE) IDEAS.DIR;1
```

In the first example, read and write access is granted to the owner, and access to all other categories is denied. The second example shows how to use SET PROTECTION for a device, such as a terminal port. In the third example, directory protection is granted to the OWNER and members of the UIC GROUP.

Access to an object through UIC protection moves through OWNER, WORLD and GROUP to SYSTEM. This order is based on system performance.

Default file protection is applied through the system RMS parameter RMS\_FILEPROT. Directories are created, by default, without DELETE access. However, protection can be specified at creation time with the CREATE/DIRECTORY command.

If not specified, the default directory protection is used, or the protection is applied from the next highest directory in the tree. You can change the

protection of existing files with the DCL command \$SET PROTECTION=(code).

The default file protection, for files created during a log in session, can be established with the DCL command \$SET PROTECTION=(code)/DEFAULT. The DCL commands \$DIRECTORY/PROTECTION and \$DIRECTORY/SECURITY can be used to list the protection of files.

## VMS Privileges

Privileges control the performance of select system activities. Privilege restrictions protect operating system integrity and the integrity of services provided to the users. They're granted to a user based on need and whether he has the experience to use them without disrupting other users.

Privileges control operations that can be performed on the system, e.g., mounting or dismounting a disk volume. Privileges are process characteristics assigned initially from a SYSUAF record. Two sets of privileges exist, default and authorized, that are stored as 64-bit masks in the SYSUAF. As of VMS V4.7, 35 privileges are available.

I recommend that minimum privileges be granted; 99 percent of all VMS users can operate properly with the two default privileges TMPMBX and NETMBX. If a user doesn't know why a privilege should be granted, it shouldn't be.

Most operators only need OPER privilege or less, and most system manager operations only require SYSRV and SETPRV. Group managers need GROUP and GRPPRV.

System managers and system programmers shouldn't work with upper-level privileges such as BYPASS. They can gain extra privileges with the DCL command \$SET PROCESS/PRIVILEGE=(priv,priv...).

Images containing System Services that require privileges can be installed with privilege. Images installed with privilege can be executed by users who normally don't have the privilege to perform operations. In this way, the privilege is granted and controlled by

# MCBA<sup>®</sup> from accudata

accounting,  
distribution and  
manufacturing  
software for the VAX

- COBOL Source Code Included
- Considerably Less Expensive
- Proven Reliability—Over 25,000 Installations
- 17 Years of Service
- Referenced Reseller

**SUPPORT**—National on-site support  
**SUPPORT**—One year free  
**SUPPORT**—Low annual fees thereafter  
**SUPPORT**—800# plus modem dial-in service

ACCOUNTS RECEIVABLE	GENERAL LEDGER	BILL OF MATERIAL
ACCOUNTS PAYABLE	JOB COSTING	FIXED ASSETS AND DEPRECIATION
CUSTOMER ORDER PROCESSING	PAYROLL	FULL LINE OF MANUFACTURING SOFTWARE
INVENTORY MANAGEMENT	PURCHASING	
	SALES HISTORY	

For further information

**CALL TODAY 1-800-225-4021**

within Mass. (617) 821-1400

CIRCLE 333 ON READER CARD

# WHAT'S THE DIFFERENCE BETWEEN THEIR EQUIPMENT AND OURS?

**digital**™

Sold by DIGITAL

**digital**™

Sold by MICROTEK

## PRICE (and 3rd party products)

Microtek sells and leases Digital's quality systems at substantially lower prices, plus a wide selection of 3rd party products, including:

DISK  
TAPE  
CONTROLLERS  
TERMINALS  
PRINTERS

LASER PRINTER  
COMMUNICATIONS  
MEMORY  
BACK-UP  
OPTICAL DISK

CDC (INCL. WREN, SABRE), FUJITSU, MAXTOR  
CIPHER  
AST, DILOG  
ESPRIT, TELRAY  
CHARACTER, OTC:  
LINE-GENICOM, OTC  
AST, DEC  
XYPLEX, AST  
AST, NEMONIX  
EXABYTE  
LASER DRIVE LTD

and

H.P. 300, WANG VS IBM AS 400, DATA GENERAL



*Performance...  
Not Promises!*

8370 DOW CIRCLE, CLEVELAND, OH 44136

TOLL-FREE 1-800-828-0303

IN OHIO: 216-234-8040 FAX: 216-234-0784

COMPUTER DEALERS AND  
LESSORS ASSOCIATION 

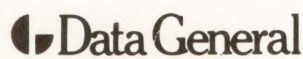
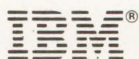

ENTER 366 ON READER CARD

the running program, not by the user.

The operation of installing images with privilege is simple:

```
$ RUN SYSSYSTEM:INSTALL
INSTALL> imagename /PRIVILEGES=(PRIV,PRIV...)
```

## VMS Access Control List Protection

VMS provides an alternative to the default UIC-based protection, the Access Control List (ACL). ACL protection doesn't replace UIC protection; ACLs enhance or fine-tune system protection.

ACLs are optional protection set up by users or the system manager. Their use of natural identifiers, such as UIC and other process characteristics, makes them flexible. ACL identifiers are classified by UIC identifiers, system-defined identifiers and general identifiers.

Numeric or alphanumeric UIC formats are both valid ACL identifiers. System ACL identifiers classify how the user or process is interacting with the system: i.e., BATCH, NETWORK, INTERACTIVE, DIALUP, REMOTE and LOCAL. These identifiers are returned by the lexical function F\$MODE().

General identifiers are the ones that you add to the Rights List for various users, such as people who work in the administrative office. These identifiers are maintained in the system Rights List database, RIGHTSLIST.DAT, and are created with the AUTHORIZE utility:

```
UAF> ADD/IDENTIFIER ADMIN
UAF> GRANT/IDENTIFIER ADMIN WILLIS
```

An ACL consists of one or more Access Control Entries (ACEs). An ACE controls access to the object. The capability of using more than one ACE extends the power of the ACL mechanism.

An ACE specifies two items, an IDENTIFIER and the ACCESS. For example, the following ACE grants READ, WRITE and EXECUTE access to the object to anyone with the ADMIN identifier:

```
(IDENTIFIER=ADMIN, ACCESS=READ+WRITE+EXECUTE)
```

Further, there are three ACE types. The one above is an IDENTIFIER ACE, which controls access for a user or user groups. The other types are SECURITY and DEFAULT PROTECTION. A SECURITY ACE provides notification when specified access is attempted, and the DEFAULT PROTECTION ACE, which is for directory files only, controls default protection applied to files, including subdirectories created in a directory.

The proper ACE format is (type[,options][,access\_\_to\_\_grant]).

## File Deletion Security

When files are deleted, blocks are made available for use. This creates a problem: If users perform non-RMS file access, they have access to data that remains on the disk. In other words, the disk is left open for scavenging.

To avoid this problem, the /ERASE qualifier should be used with the DELETE and PURGE commands. The /ERASE qualifier forces VMS to write zeros over the disk space occupied by the file.

This process can be automated by redefining the DELETE and PURGE commands with symbols that equate to the commands with the /ERASE qualifiers. These symbols are established in the global login command procedure, SYSS\$MANAGER:SYLOGIN.COM.

```
$ DEL*ETE:=="DELETE/ERASE"
$ PUR*GE:=="PURGE/ERASE"
```

Erase on delete can be enabled for a volume with the DCL command \$SET VOLUME/ERASE\_ON\_DELETE. The default erasure pattern of zeros can be modified by using the information contained in the file SYS\$EXAMPLES:DOD\_ERAPAT.MAR.

The highwater-marking feature erases blocks added to files when they're dynamically extended. The security pattern is written to this extended area so that information previously stored won't be recoverable. Highwater mark-

ing is enabled for a volume with the DCL command \$SET VOLUME/HIGHWATER.

The pitfall of all the file and storage erasure techniques is system performance. Considerable processing overhead is incurred using these features. Consider their value to your system before implementing them.

ALSO CONSIDER how to track security violations, a task that must be done on a daily basis. A difficult job, it requires, in larger installations, a full-time security manager.

Security alarms are messages sent to the security operator's console when a specific event has taken place. Alarms help you detect an attempt to break into the system or to access an object that doesn't belong to a valid user.

For example, security alarms can be set for access to selected files or global sections, events requested by an ACL, use of privilege to access a file or global section, break in attempts, modification of the SYSUAF or Rights database and more. Select the events to be audited using the DCL command \$SET AUDIT/ENABLE.

Before enabling alarms, enable a security operator's terminal. The security terminal should be a hardcopy device. Use the command \$REPLY/ENABLE=SECURITY.

Any terminal can be enabled as the security operator's terminal. Security always will go to the operator log file, even if a security operator terminal hasn't been set up.

## Audit Reduction

Security alarms are effective only when you use the information. If security alarms are enabled on many objects and types of user access, the operator log file will contain a large volume of alarm information, making the security audit task impossible.

To extract security information from the operator log file, use the SECAUDIT command procedure, found in the SYSS\$MANAGER directory.



# NEW!

# **dBASE<sup>®</sup> LANGUAGE**

# **FOR VAX/VMS<sup>®</sup>**



**RECITAL<sup>™</sup>**, a new relational database management system and fourth generation language for VAX/VMS<sup>®</sup>, is totally upwards compatible with Ashton Tate's dBASE III PLUS<sup>®</sup>. Now, your PC applications written in dBASE can be used on your VAX – *without reprogramming!*

RECITAL lets you upload dBASE applications and associated data directly from the PC to the VAX. And, once it's installed on the VAX, you can maintain and modify it using the same familiar syntax and commands as on the PC. Operators trained in dBASE will understand RECITAL instantly.

The potential is exciting. Not only is the whole catalog of affordable dBASE applications yours to use, but you can easily develop entirely new programs using RECITAL. And, since there are hundreds of thousands of programmers already trained in dBASE, finding skilled people becomes much easier. Not only that, with RECITAL, end users can develop and maintain databases, generate reports, design screen forms, and much more... without writing any program code at all. And, there's more.

RECITAL is also available for a number of UNIX<sup>®</sup> SYSTEM V platforms, including Sun Microsystems<sup>®</sup> and AT&T<sup>®</sup> 3B series hardware.

#### **RECITAL is loaded with features.**

- Upwards compatible with dBASE III PLUS
  - Multi-user relational DBMS
  - Concurrent processing
  - Transparent access to existing RMS indexed sequential files on VAX/VMS
- Powerful fourth-generation language
- Complete menu driven interface
- Report formatter
- Free format text based report writer
- Import and export in 20/20<sup>®</sup> spreadsheet interface format
- Keyboard macros usable in any form or menus

Call today for the complete story on the VAX/VMS oriented product of the year. Available *now*.

**RECITAL.** It performs!

#### **RECITAL CORPORATION**

1325 S. Dairy Ashford, Suite 125  
Houston, TX 77077  
(713) 558-0656

All trademarks are property of their respective manufacturers.

The VMS ACCOUNTING utility provides a source of audit information. Accounting logs information to the file SYSS\$MANAGER:ACCOUNTNG.DAT. It retains information such as the date and time of log ins, log in source, type of process, CPU and I/O time used, and the

number of pages printed.

The system or security manager should make routine checks of system information, looking for abnormalities. Here's a checklist:

1. Use the VMS INSTALL utility to look for unexpected image additions.

2. Use the AUTHORIZE utility to look for usernames that you didn't authorize.

3. Run VMS ACCOUNTING on a regular basis to measure normal amounts of processing time and usage.

4. Run an ACCOUNTING report to check for known users, unknown users and appropriate hours of system use.

5. Review template command procedures that you might use to set up new accounts (ADDUSER.COM on MICROVMS systems).

6. Be familiar with all recurring batch jobs and the times they are most likely to be run.

7. Try to break into the accounts of users who have chosen obvious passwords.

8. Check to see that the users have appropriate default protections in place, especially on directories.

9. Implement security alarms from time to time to catch system browsers, i.e., people who look through others' files.

10. Keep the Rights database up to date. Remove identifiers that aren't in use. Keep current listings.

11. Monitor the protection of critical files.

12. Check that your users are logging out at the end of the day or when leaving their desk for long periods. Make periodic physical checks at the end of the day.

SYSTEM SECURITY is a complex problem, and we've only scratched the surface. For instance, how do you ensure that a cleared person doesn't mail a top secret document to an uncleared person? How do you make a user captive so that you can control his activities? How do you force people to log out when they walk away from their terminals?

Every time you find a way to secure access, someone will develop a bypass. If your work environment is sensitive or controlled, your system security job never will be complete.

## ezLINK™ VAX to IBM Sys/38 and AS/400 COMMUNICATIONS SOFTWARE

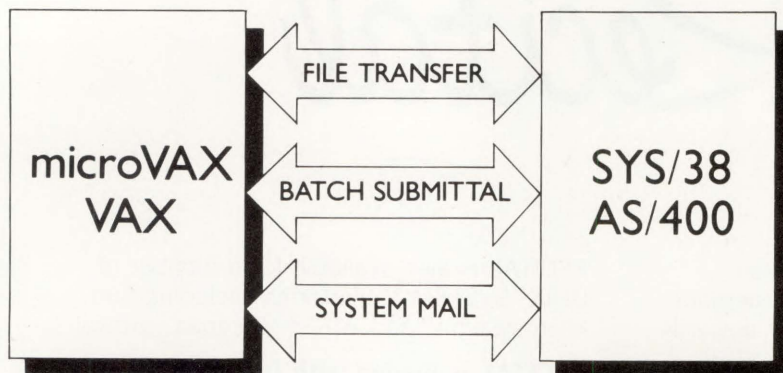

- Friendly, menu-driven interface
- Powerful, multi-stream concurrent link
- High speed (to 64Kbps)/High throughput
- Uses standard DEC and IBM comm. hardware

Also available:  
DEC to IBM/SNA, IBM/BSC, CDC, HP,  
UNISYS, PRIME, DG, AMDAHL,  
plus many more solutions!

For more information call or write:

 **datanex**

P.O. Box 1728 Eugene, Oregon 97440  
(503) 687-2520 Telex: 4941300 DATANEX FAX (503) 345-8530

CIRCLE 250 ON READER CARD

ARTICLE INTEREST QUOTIENT  
Circle On Reader Card  
High 453 Medium 454 Low 455

FOCUS is the only fourth-generation language with anywhere near that many users. And that makes us the number one 4GL on mainframes, minis, and micros.

Why? Because FOCUS does what a 4GL is supposed to do. And if you're skeptical, make us prove it.

Just give us a call and we'll come to your place, install FOCUS, and create a prototype application that (and here's the trick) runs against your production database. Or, if you prefer, against FOCUS' own shared-relational database manager.

Either way, we'll do it in four hours. At no charge.

What's more, we'll write the entire application in the FOCUS language—with no exits to COBOL, FORTRAN, or C for the hard parts.

FOCUS is such a complete language you can use it to write almost any application—from heavy-duty transaction systems to any type of online inquiry system.

Moreover, FOCUS can directly access every major database system running on every major hardware platform.

We're talking about online access here, not merely batch data extracts. And FOCUS will address multiple databases simultaneously, and perform outer joins.

We'll take that a step further. If two computers communicate, a FOCUS user on one

can, via FOCUS on the second machine, access any major database running there.

FOCUS supports IBM 370, PC and PS/2, VAX/VMS, UNIX V, Wang VS and others. With, we might add, full portability. An application developed in any of these environments will immediately execute in any other.

That means, for example, that you can use a PC as a workbench for mainframe application development.

SQL compatibility? However you need it, FOCUS can do it.

There's more. Developers' Windows let your professional programmers use a windowed interface to create

window-driven applications quickly and easily. The result is great-looking software with a superior user interface.

TableTalk is the

FOCUS point-and-pick windowed interface that lets your end users create their own inquiries, customized reports, or even rela-

tively complex applications—using only the arrow keys and the enter key.

And FOCUS lets you set the security and access levels you want.

Sound too good to be true? It's not. But don't believe

this ad. Make us prove it. Just call 1-212-736-4433, Ext. 3700, and ask for details. And if you give the word, one of our technicians will come out to your place and make it happen.

Right before your eyes.

# 400,000 USERS CAN'T BE WRONG.

## Who says we're number one?

"Information Builders' 4GL products were, once again, the only ones to lead in their niche in mainframes, minis, and micros. No other vendor has duplicated this feat in the seven-year history of this research effort."

—Software Magazine 1988 Software Market Survey



CIRCLE 126 ON READER CARD

# ONE DOING THE WORK OF MANY

By Philip A. Naecker

## Remote System Manager Provides A Mechanism To Perform Management Duties On Distributed VAX Systems.

*Editor's note: This is the third in a series on DECNET System Services (DSS). These layered products from DEC combine multiple VAX computer systems into a highly integrated, distributed computing environment (see Jeffrey Schriesheim's article "Networking DECNET System Services," April 1988, and Philip A. Naecker's "To Name Me Is To Know Me," June 1988).*

One of the most important problems associated with workstations — VAXs and PCs alike — is that they can turn a productive user into a system manager and computer operator. Instead of freeing the user from performing extraneous tasks, the computer ends up adding tasks to the user's task list. This includes installing or upgrading software, performing backups and maintaining system databases such as the license database and DECNET.

Although the system manager can take care of the first system, or even the second, after a while, he gets saturated, too. Also, he needs physical access to the machine to load tapes with new software, reboot and load backup tapes. But a workstation can be on another floor, in another building or even in another state.

This isn't a small problem. DEC probably will sell more workstations this fiscal year than the total number of VAXs sold since their inception. Many are at sites with dozens of

workstations per VAXCLUSTER. Even for those organizations with just a few VAXs, the problems of managing distributed systems can be overwhelming.

DEC recognizes that distributed systems are going to be a major part of computing in the 1990s. So it has created a number of DECNET System Services software products to address the problems of managing distributed systems. VAX Remote System Manager (RSM) V2.1 is one of the four DSS products. The others are VAX Distributed File Service (DFS), VAX Distributed Queuing Service (DQS) and VAX Distributed Name Service (DNS).

### Clusters Don't Do It

Under some circumstances, a VAXCLUSTER helps to avoid the additional management overhead of multiple systems. A homogeneous VAXCLUSTER presents a single management domain and a single file system. This solves the problem of installing multiple copies of software, maintaining system databases and performing backups for each system. The system manager does those tasks for the cluster as a single system.

However, clusters have limitations. First, a cluster is restricted to a single computer room or, in the case of LAVCs, a local area network. Machines at another site can't be in a cluster.

Second, a cluster is a single "management domain" with a single, coordinated system

# The New MasterDisk/SDI Can Save You A Bundle

For the price of about 10 gigabytes of DEC disk, you can get 10-plus gigabytes of MasterDisk/SDI\* for all VAXs and VAXclusters, a dozen DEC terminals, ten pairs of Gucci's, dinner for a month at 21, ten thousand in cash, four tickets to Springsteen, his and her Corvettes, two weeks in Paris, and a partridge in a pear tree. Plus 22ms average access time, and a lot of other advantages shown below.



Now why would anyone want another disk?

COMPARE FOR YOURSELF	ADS	DEC
Formatted Storage	10.365 gigabytes	9.952 gigabytes
Average Access	22.3 ms	32.3 ms
Peak Transfer Rate	2.75 MB/sec	2.4 MB/sec
Size	1- 40" high rack;	4- 60" high racks;
Power Consumption	1,000 watts	13,440 watts
MTBF Per Drive	40,000	25,000
Warranty	2 years	1 year
List Price	\$194,000	\$264,000
Required HSC Data Channels	1¼	4
Cost of Data Channels	\$13,125	\$42,000
Total Cost	\$207,125 (\$19.98 per megabyte)	\$306,000 (\$30.75 per megabyte)

\*Capacities range from 137 to 16,584 megabytes within one rack. MasterDisk/SDI will connect directly to any HSC 50/70, KDB 50, KDA 50, UDA 50. SDI is the Standard Drive Interface used on all DEC "RA" family drives.

DEC, HSC 50/70, VAX, VAXcluster are trademarks of Digital Equipment Corporation.

For more information, write or call American Digital Systems Inc., 75 Union Ave., Sudbury, MA 01776-9990. (508) 443-7711.



American Digital Systems Inc.

CIRCLE 178 ON READER CARD

management operation. The nodes in the cluster must all run the same version of VMS, typically have a single set of system databases (system authorization file, queue file, network definition files) and participate in the distributed lock management scheme. These strengths become weaknesses if you want different versions of VMS or layered products, different system databases or isolated lock management.

The single file system in a cluster also implies that all the nodes in a cluster must be equally trusted. Unless a disk is kept entirely private to a single node, any suitably privileged user on any node in the cluster has access to all the data on any other node of the cluster. Thus, there's no practical way to mix both trusted and non-trusted nodes in a cluster.

But workstations provide a way to limit the scope of privileged users. You can give users privileges on their own workstation so they can do their work without the intervention of the system manager but not have privileges throughout the system. A homogeneous cluster defeats this advantage. Also, clusters don't include ULTRIX nodes. So if some of the workstations run ULTRIX, the cluster solution is of no help.

Last, in a cluster, all nodes must go through a cluster state transition whenever a node enters or leaves the cluster. If a workstation frequently is rebooted,

the cluster's operation frequently is disrupted. Cluster state transitions also preclude the inclusion of any real-time systems in the cluster.

### The RSM Solution

RSM provides a mechanism for a system manager to perform management duties on any number of distributed VAX systems, running either VMS or ULTRIX (see Figure 1).

VAX RSM version 2 supports a range of system management functions across both LANs and WANs (see Table 1, p. 98, and Table 2, p. 102). It allows a central system manager or system management group to manage a large number of distributed VAXs. Some of RSM's features are so useful that you might want to get the product even if your environment is completely clustered.

RSM works on a client-server model. The workstation or other remote system is the client.

Actually, the client doesn't need to be either remote or a workstation. However, RSM does its work via DECNET, so it's useful to think of the system as remote in the DECNET sense. Also, because most RSM clients are workstations, let's assume that the client is a workstation.

The servers in the client-server model are one or more VMS-based VAXs running the RSM software. Each server

## Remote System Manager

**PLATFORMS:** All VAXs except MICROVAX I processor products. The RSM client also is available as part of the Software License Portfolio for MICROVAXs and VMS workstations

**PRICE:** \$450 on MICROVAX II, \$3,600 on a VAX 8200 and \$10,800 on a VAX 8800. Client licenses cost approximately half of server licenses. There are no cluster licenses available for RSM. Volume discounts are available starting with eight-client licenses

### DIGITAL EQUIPMENT CORPORATION

#### HEADQUARTERS:

146 Main St.  
Maynard, MA 01754  
(617) 897-5111

CIRCLE 400 ON READER CARD

provides one or more services, such as a backup service or a software distribution service. There can be multiple servers providing the same service, or all services can be provided by a single server.

There are four services currently available in RSM:

1. Basic Operational Services (BOS) facility — Enables you to maintain a centralized database of clients, servers and their characteristics. BOS does this



**COLT SOFTWARE TECHNOLOGIES**

**EXECUDESK** - Executive/Salesman Organizer  
Corporate Event Calendar, Personal Calendar/Scheduler,  
Equipment Scheduler, Personal Expense Organizer,  
Master Appointment Scheduler, Message and Reminder  
System, Business Calculator.

**GENERAL ACCOUNTING** - Control customer  
CHARGEBACKS with a comprehensive Accounts  
Receivable system. General Ledger operates like a  
spreadsheet with flexible user designed reports. The  
account number is user defined with up to twelve  
characters. Accounts Payable supports five check  
formats and includes a bank statement reconciling  
capability. And of course, Payroll is available.

Authorized Distributor

**DIGITAL BUSINESS SYSTEMS, INC.**  
201-542-7600

DEALER INQUIRIES WELCOME

## SOLUTIONS TO THE SOFTWARE PUZZLE

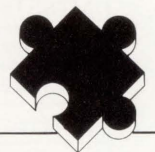

- Retail Management with POS
- EasyPage Publisher
- Distribution
- Manufacturing
- Job Costing Const.
- Service and Call Dispatch Management
- Property Management
- Mailing List
- UNIX Software

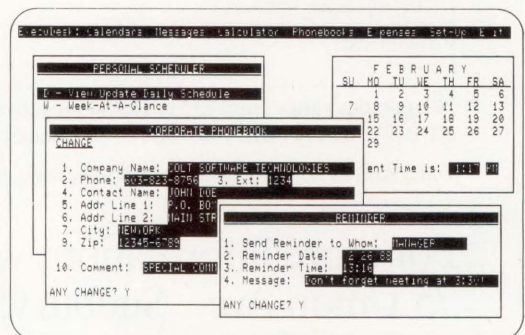

**EXECUDESK** allows windowing  
to and from all modules.

CIRCLE 299 ON READER CARD

# CA-TELLAPLAN™ System. The multi-platform solution for distributed project management.

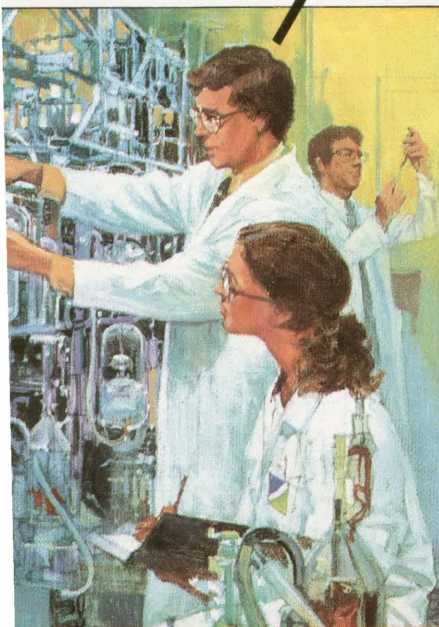
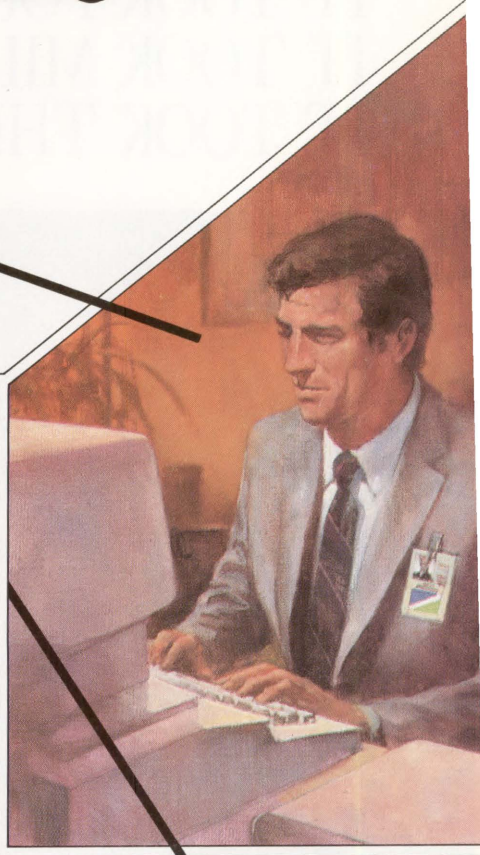

### *Centralized consolidation, control and executive-quality reporting.*

The **CA-TELLAPLAN System** brings you integrated micro-to-mainframe project management. Now you can coordinate your project managers, avoid corporate resource conflicts and bring all your projects in on time, on budget and on target.

### *A total corporate solution.*

The **CA-TELLAPLAN System** consists of **CA-TELLAPLAN Expert**, a powerful mainframe/mid-range/workstation component that can handle multiple projects of any size along with sophisticated consolidation capabilities inherent in a host system. **CA-TELLAPLAN Expert/PC**, the microcomputer component provides for project planning and control at departmental levels. Together, they're the best way to meet today's corporate-wide planning needs.

### **CA-TELLAPLAN System Features:**

- ✓ Menu or Command Driven
- ✓ PERT/CPM Diagrams
- ✓ Work Breakdown Structure
- ✓ Multiple Gantt Charts
- ✓ Cost and Resource Charts
- ✓ Presentation Graphics
- ✓ Management Reports
- ✓ Multi-Plan Consolidation
- ✓ Resource Leveling
- ✓ Micro-to-Mainframe Integration
- ✓ Public Resource Management
- ✓ What-if Simulation
- ✓ Forward/Backward Planning
- ✓ Milestones/Benchmarks
- ✓ Flexible Planning Units
- ✓ Custom Calendar
- ✓ Priority Scheduling

The **CA-TELLAPLAN System** operates on mainframe/mid-range/workstations and PC systems, requires minimum computer resources, and is surprisingly affordable. Only Computer Associates can provide such a cost-effective, one-vendor solution to all your project management needs.

For more information, call or write Chris Andrews today:

**800-841-3734 (Ext. 1911)**

(In California 800-468-0725)

Computer Associates

10505 Sorrento Valley Road, San Diego, CA 92121-1698

© 1988 Computer Associates International, Inc.

**COMPUTER ASSOCIATES**  
Software superior by design.

- World's leading independent software company.
- Broad range of integrated business and data processing software for mainframe, mid-range and micro computers.
- Worldwide service and support network of more than 100 offices.

Resource & Operations Management • Financial • Banking • Graphics • Spreadsheets • Project Management

CIRCLE 353 ON READER CARD

IT TOOK FOUR YEARS.  
 IT TOOK MILLIONS IN RESEARCH.  
 IT TOOK THE LEADER IN TAPE TECHNOLOGY.



**Announcing The Cipher 3000i Half-Inch Cartridge Tape Drive Family.**

Now Cipher introduces the solution the industry has been waiting for. And it's revolutionizing the entire concept of data interchange.

Until now, most new products in the tape drive market have been too big and too expensive. Or too small to perform with midrange and small mainframe systems.

What's been needed is a family of tape drives offering the performance, price and form factor required by low-end and midrange systems. Plus an economical means of interchanging data from

low to high-end computers.

It begins with a new standard recording format: MSR-Multi-track Serpentine Recording. Now for the first time data can be interchanged from micros to small mainframes with amazing new levels of performance and economy.

Cipher makes this possible with an all new family of MSR-compatible half-inch cartridge tape drives. The Cipher 3000i family. Compared to standard technology, they offer space saving benefits that are nothing short of phenomenal.

The 3000i records on industry standard 3480-type cartridges,

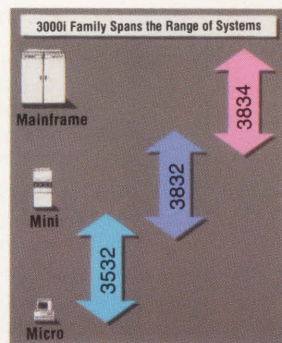

each with a formatted capacity of 320 megabytes. An optional 10 cartridge stacker increases total storage capacity to 3.2 gigabytes. There are 2 different 3000i series with 26 models in all. The series with an 8-inch form factor is the

world's first tape drive system to address the size and high performance needs of workstations, midrange systems and small mainframes. The 5 1/4-inch form factor series will complement the economy and performance of micros and low-end minis.

**See these and CIPHER'S other exciting products at COMDEX Booth #1868**



*cipher* 3000i

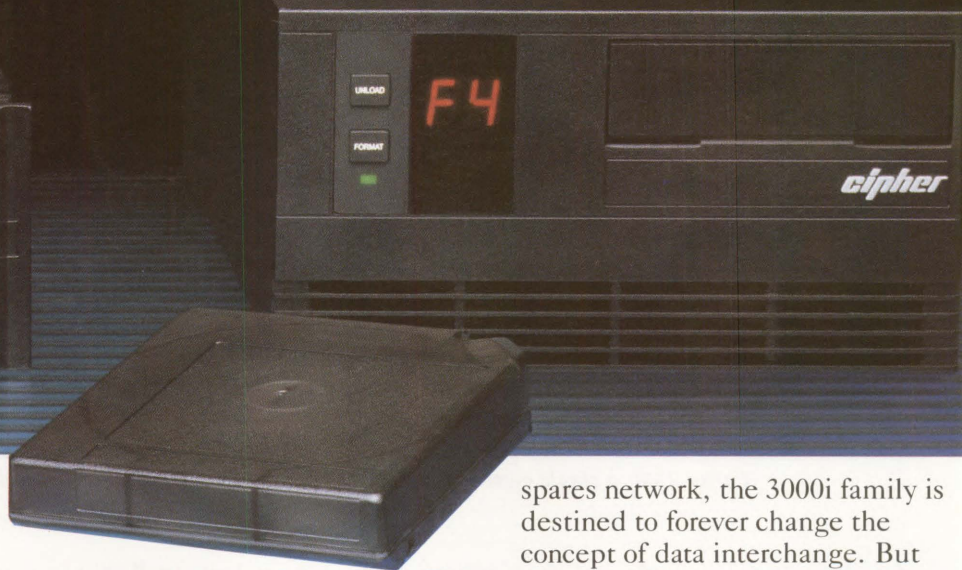

What about backup speed? Transfer rates range from 242 to 896 kilobytes per second. For instance, a Cipher 3000i drive, using only 2 cartridges, can backup a 500 megabyte disk in just 11 minutes. A high performance GCR open reel drive takes 4 reels of tape and twice the time to do the same job.

The 3000i offers a choice of configurations including horizontal or vertical mounting, tabletop and 19-inch rack mount versions. System integration couldn't be easier with a wide selection of interfaces—Cipher/Pertec, SCSI and IPI-3. AC or DC power. And standard 9-track reel-to-reel functionality is

a special feature of the 3000i. This ensures compatibility with existing system software and protects the enormous investment in software development.

The 3000i continues in the same tradition as our 1/2" reel-to-reel streaming tape systems, now the industry standard. Cipher also developed cached tape drives, and the widely used end loading device on 1/4" streaming cartridge systems. The company is also at the forefront in optical disk drive technology, subsystems and interfaces—including the new SCSI-2.

Supported by the full resources of an international service and

spares network, the 3000i family is destined to forever change the concept of data interchange. But then, would you expect anything less from the world's leading independent removable data storage systems company. For more information on MSR and the 3000i family contact Cipher today. Cipher, 10101 Old Grove Road, San Diego, CA 92131-1650.

1-800-4-CIPHER

***cipher***®

# F I G U R E 1 .

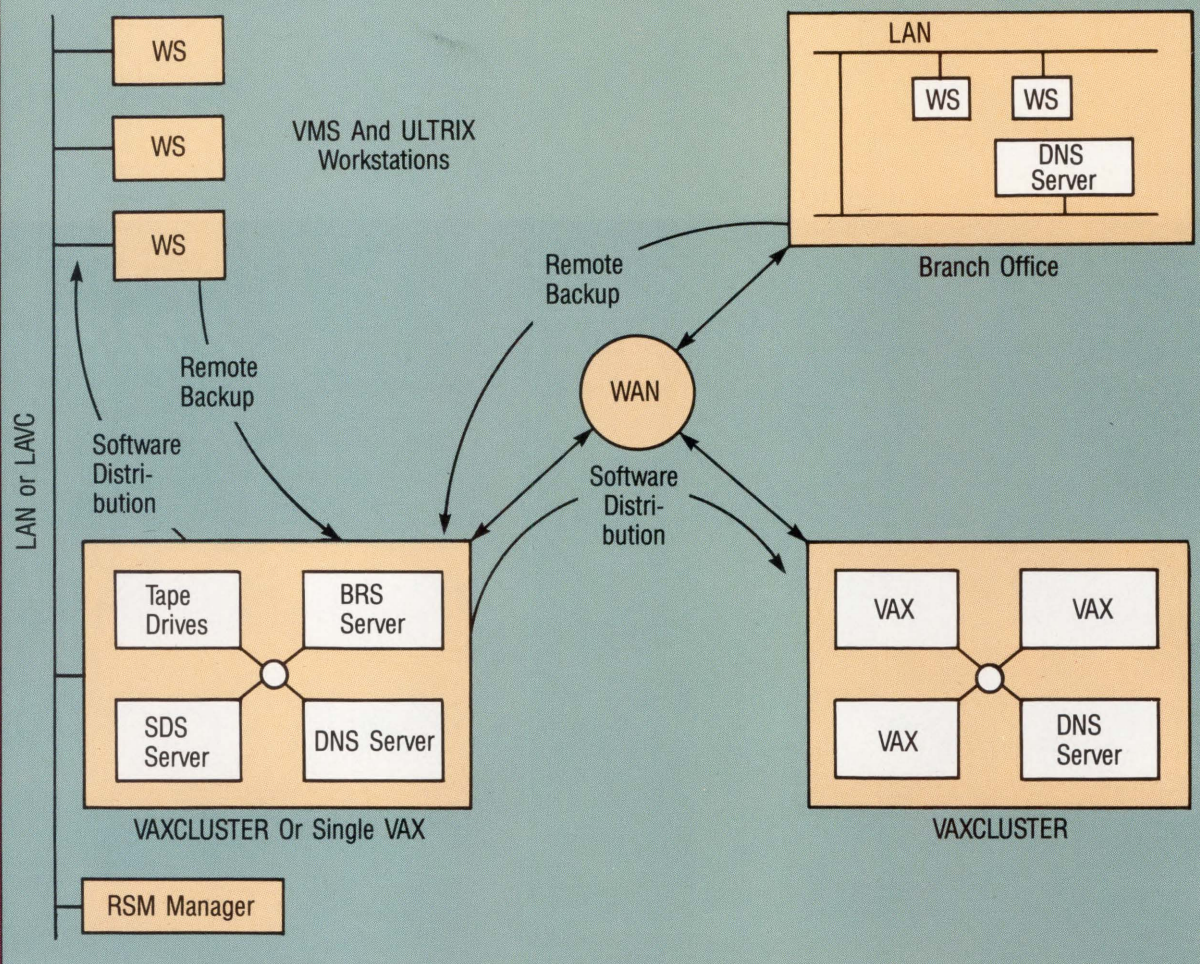

*Using RSM, a single system manager can perform backup and software distribution for many VAX systems.*

by use of the Distributed Name Service (DNS) (see "To Name Me Is To Know Me," June 1988).

DNS acts as a distributed database of RSM information, making sure that this information is consistent across the network and available to every node that might want to perform an RSM operation.

2. Software Distribution Services (SDS) — Are used to distribute or install software from a server to multiple clients. The client systems can be either VMS or ULTRIX nodes, and the software to be installed can be either the operating

system or any layered product installed using the standard VMSINSTAL procedure or setld for an ULTRIX system.

SDS also can do an Initial System Load (ISL) of a system without any software installed, if that system is on a LAN.

3. Backup and Restore Services (BRS) — Can provide scheduled or ad hoc backup operations for both VMS and ULTRIX nodes. The backup savesets can be stored either on disk on a backup server node or on tape. If the savesets are on tape, BRS manages the mounting of the tape on the server. Thus, you can use your new videotape cartridge unit

on your VMS VAX with your ULTRIX workstations.

4. Client Administration Services (CAS) facility — Provides a mechanism to centrally manage system databases, such as the authorization file, DECNET databases, VMS symbols and logical name definitions, and license databases. This facility provides the advantages of a homogeneous VAXCLUSTER without a cluster's limitations.

The users on the client nodes don't need to know anything about RSM. As far as they are concerned, the system



# VAX\* 11/780 Users

## Nemonix Performance Upgrade!

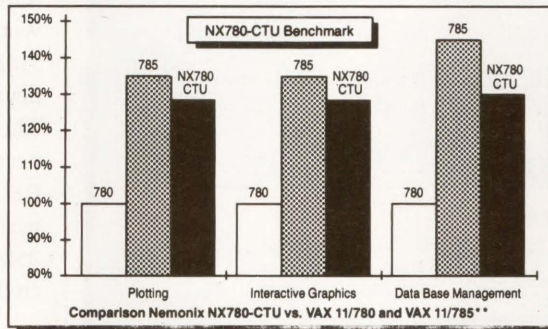

- Increase CPU Performance up to 45%
- Run existing application software
- Save \$ on hidden migration costs
- Five day trial evaluation
- Exclusive Customer Protection Plan

Nemonix the Leader in Special Performance Upgrades has the solution to your VAX 11/780 performance problems: The Nemonix NX780-SPU is a multi-board CPU upgrade, which increases system throughput up to 45%. The package includes a Synchronized Clock Accelerator, a Cache and Translation Buffer Upgrade (increasing Cache memory fourfold) and main memory

upgrades up to 64MB as your system requires. As always, we protect your investment with our Exclusive Customer Protection Plan: Lifetime warranty, diagnostic package, 24 hour replacement, and a generous trade in/up policy. For more info or a 5 day trial CALL US TODAY! 1-800-435-8650 or in MA. 508-435-9087.

# Nemonix<sup>TM</sup>

Nemonix, Inc., 106 South Street, Hopkinton, MA 01748  
800-435-8650, in MA 508-435-9087, FAX 508-435-6127

CIRCLE 287 ON READER CARD

\*VAX is a registered trademark of Digital Equipment Corporation  
\*\*Information represents actual results from a CAD/CAM site. Test data available upon request. Your results may vary based upon application.



T

## TABLE 1.

**RSM Features At A Glance****Basic Operation Services (BOS)**

- Combine client nodes into logical groups, reducing the number of different systems to keep track of
- Configure servers for software distribution and backup
- Store client information for both ULTRIX and VMS clients in DNS
- Has both a menu and DCL interface
- Uses DECNET for all operations

**Software Distribution Services (SDS)**

- Works on both ULTRIX and VMS clients
- Works over both LANs and WANs
- Installs and upgrades both operating systems and layered products
- Can perform an initial system load to certain processor types on a LAN
- Manages "sets" of application software to be installed as a unit
- Keeps a detailed log of the status of all software installations and simplifies update when a new version becomes available
- Installs itself over the network
- Provides notification using VMS MAIL

**Backup and Restore Services (BRS)**

- Automates the entire backup/restore process over the network
- Can schedule backups for entire file systems or parts of file systems, either incremental or full
- Keeps a detailed log of the status of all backup operations
- Works on both VMS and ULTRIX systems
- Works over both LANs and WANs
- Uses standard VMS BACKUP and ULTRIX dump or tar utilities
- Provides notification using VMS MAIL
- Can create either disk or tape savesets

**Client Administrative Services (CAS)**

- Services only VMS clients
- Useful for small-scale or turnkey environments
- Manages user accounts and directories on client nodes
- Distributes system databases such as the DECNET database, VMS symbols, VMS logical names
- Verifies security of certain accounts on client nodes

manager is someone who does his job from a remote location and somehow gets access to the system. Because everything is done via DECNET, the client system must provide only a working network connection.

**Using RSM**

In the *DEC PROFESSIONAL* Lab, we tested RSM in a subset of our entire network. The network included three VAXSTATIONS, two of which had no backup devices and were located at distant sites. The distant VAXSTATIONS were connected over dynamic asynchronous DECNET lines, operating over high-performance (19,200 baud) modems. RSM has performed admirably in this environment.

The system manager interacts with RSM either using a DCL command interface with commands and qualifiers, or through a menu system.

Most system managers probably will want to use the DCL interface instead of the menu interface. But the menu interface is useful for some turnkey sites and for allocating some system management responsibilities to less sophisticated users.

One facility, network DCL (NETDCL), is available to both users and system managers. With it, you can enter commands like `$NETDCL OASIS SHOW USERS` to see the users logged into the workstation with a nodename of OASIS. NETDCL also has qualifiers for username and password, and it has the ability to run the AUTHORIZE utility on the target node.

Although you can't issue commands that prompt you for input or require true interactivity, such as using an editor, you can use NETDCL instead of SET HOST. NETDCL is a nifty utility that performs well and is easy to use. Before you can use RSM, you must install it at the servers and the clients. To install the first RSM in your network, use VMSINSTAL. To load clients (VMS or ULTRIX), simply tell RSM on which node or nodes to install itself, and away

# "Advantage yours."

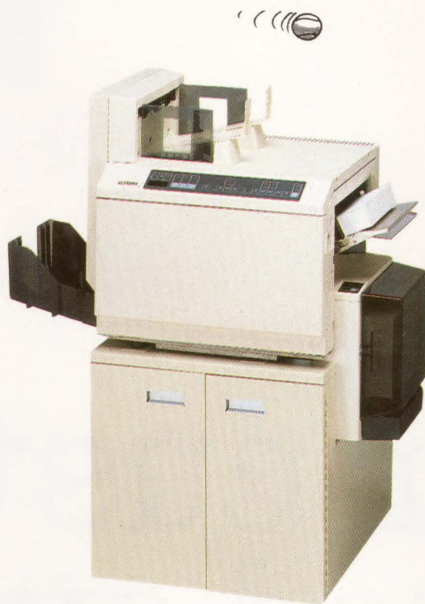

Out on the court, you have to be fast, you have to be versatile and you have to be able to really connect.

All of which, not coincidentally, are qualities of C. Itoh's remarkable new MegaServe Ion Deposition Printer.

#### **A stroke of genius.**

You want fast? The MegaServe serves up top-quality hardcopy at 30 or 45 pages per minute. You want stamina? How does a quarter-million pages a month sound? You want finesse? The Mega-Serve produces text and graphics with resolution up to 300x300 dots per inch.

And despite its star qualities, the MegaServe performs all that and more for less than two cents a page.

#### **Great connections.**

The MegaServe's standard interfaces

include Dataproducts parallel or Centronics parallel, SCSI, RS-232 and RS-422. So it will work — without missing a stroke — on almost any current system. For Ethernet systems, the MegaServe even has both interfacing hardware and host software.

With its Postscript interpreter and scalable fonts, MegaServe is perfect for both single-user and network applications. And for the ultimate in compatibility, it even emulates the DEC® LN03 Plus, the H-P LaserJet II®, the Diablo® 630 ECS and the Tektronics® 4014.

#### **Top seed.**

The MegaServe keeps 43 fonts resident; a built-in Winchester disk manages Postscript fonts and can endow any of them with attributes ranging from

bold or underline, to shadow, faint and reverse print.

And, of course, the MegaServe is guaranteed for a year and backed by service centers nationwide.

Call your C. Itoh distributor. And get the MegaServe advantage.

**Call (800) 227-0315 Ext. 4450  
or (714) 757-4450**

for the C. Itoh distributor nearest you.

**C. ITOH**

**C. Itoh Electronics, Inc.**

2505 McCabe Way, Irvine, CA 92714

***We build more in. So you get more out.***

CIRCLE 310 ON READER CARD



# Do your customers deserted systems? Call the Porting C

If you're a reseller whose customers feel stranded on isolated systems like these...  
or if you have to port MAI Basic Four or other Business Basics or RM/COBOL applications...  
...call the Porting Center. It's a vital part of the Honeywell Bull Reseller Program because it addresses today's real reseller needs.

Working together, we can help your customers migrate to systems with a future.

What's more, by providing you the tools to port applications created for these environments to our proven DPS 6 and DPS 6 PLUS minicomputers, and our XPS 100 family under UNIX\* System V, we can make this migration easy and economical.

## Customers are more important t

\*UNIX is a trademark of AT&T

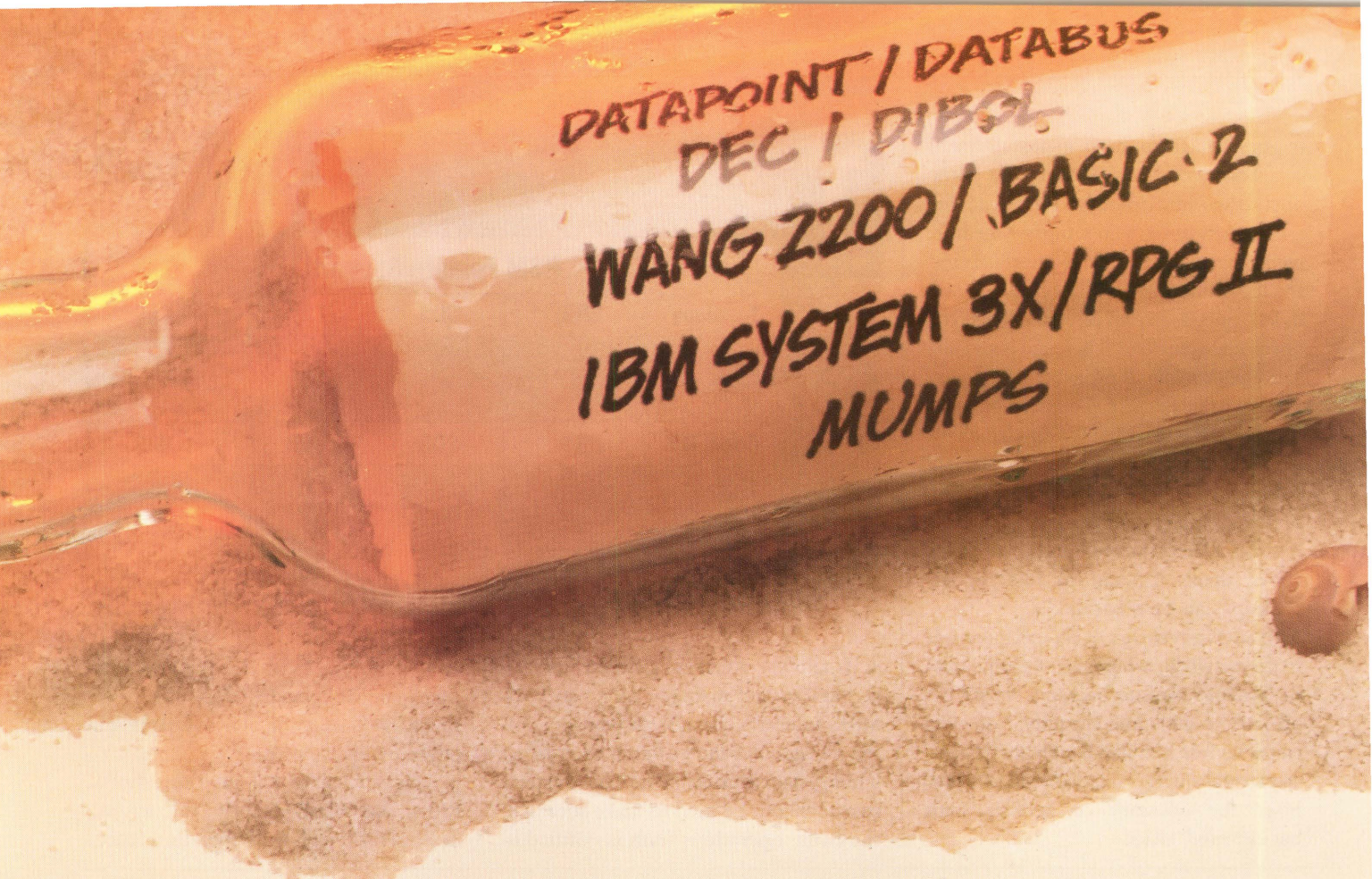

DATAPoint / DATABUS  
DEC / DIBOL  
WANG 2200 / BASIC-2  
IBM SYSTEM 3X / RPG II  
MUMPS

# feel marooned on enter for rescue.

The Porting Center can help you get out of all kinds of tight spots. With everything from simple feature additions to total system design.

It's the latest refinement to the most comprehensive Reseller Program in the industry. One offering competitive discounts, a line of compatible products ranging from micros to superminis (including

virtual and UNIX systems) and the best service and support in the industry to back it up.

With us, your customers never feel stranded.

For more on the Porting Center and the Honeywell Bull Reseller Program call 1-800-328-5111, ext. 9730.

See us at COMDEX/Fall '88, Booth #836.

han computers. **Honeywell Bull**

CIRCLE 221 ON READER CARD

it goes. It knows how to install itself!

You can direct RSM to do some operations immediately. However, for most operations, you simply schedule, using the RSM command interface, and the RSM schedulers work with the VMS batch queues to make sure that the operation gets done. There are many advantages to this approach:

1. It works even if the client is temporarily unavailable. When the client becomes available, the operation will complete.
2. It lets the system manager schedule regular operations once and then forget about them. Operations like regular backups can be scheduled.
3. It takes advantage of off-peak periods in the network, when high-volume traffic, such as remote backups, won't eat up LAN or WAN link capacity. You even can schedule services for concurrent or sequential operation so that RSM never hogs the network or servers with background tasks.

TABLE 2.				
RSM Feature Support				
Topology	BRS	SDS	ISL	CAS
LAN	Y	Y	Y	Y
WAN	Y	Y	N	Y
Client O/S	BRS	SDS	ISL	CAS
VMS	Y	Y	Y*	N
ULTRIX	Y	Y	Y*	N

\*For MICROVAX II, MICROVAX 2000 and MICROVAX 3xxx products only.

4. It allows several users to act in concert as a system manager. RSM uses VMS MAIL to notify the system managers of the success or failure of each operation. Thus, distribution lists of system managers can be used to make sure that the entire operations team is notified if

an operation fails. If your system manager or person responsible for BACKUP is unavailable, someone can cover easily.

In our use of RSM at Professional Press, we notified only the system manager if the backup operation failed.

# Sure, You Hear

Price/performance. Advanced design. Productivity. Flexibility. Ease-of-use. Quiet operation. Software/hardware compatibility and connectivity. A and B size. Bright, detailed color. One-second RGB screen capture time. Now you really can get it all. In one neat package. To find out more, call us at 1-800-CALCOMP. Or write CalComp, P.O. Box 3250, Anaheim, CA 92803. In Canada, call (416) 635-9010.

## Get It All With The



But we told the system manager and the workstation user if the operation succeeded, so that the workstation user would know that backups were done.

ONE OF THE MOST powerful concepts in RSM is the construct of logical groupings of nodes and software products. A group of nodes with similar characteristics is called, logically, a group. A group of software products that are to be installed together is called a set. Using the BOS, which stores its information using the Distributed Name Service, the RSM manager can add or delete nodes from groups and add or delete software products from sets.

For example, you might have a large number of workstations with the same function and the same products installed. You could create a group, perhaps called CAD\_WORKSTATIONS, and a set, perhaps called CAD\_SOFTWARE\_PRODUCTS. To install a new version of all the CAD software products on all of

the workstations, use a single command:

```
$ MANAGE
MANAGE> DISTRIBUTION_SERVICE
DISTRIBUTE> INSTALL APPLICATION CAD_SOFTWARE_PRODUCTS
CAD_WORKSTATIONS/RETRY/NOTIFY=
(SUCCESS:"@CADUSERS",FAILURE:"@OASIS:PHIL")
```

You can add the node SAURON to the CAD\_WORKSTATIONS group and software product MAPPER to the CAD\_SOFTWARE\_PRODUCTS set using:

```
$ MANAGE
MANAGE> ADD MEMBER SAURON CAD_WORKSTATIONS
MANAGE> DIS
DISTRIBUTE> ADD MEMBER MAPPER CAD_WORKSTATIONS
```

To get the MAPPER software distribution kit onto the VAX so that RSM can distribute it, you must use a command procedure called TRIAL\_INSTALL. It layers on top of VMSINSTAL or setld in ULTRIX and provides a record of every operation done using VMSINSTAL.

You use TRIAL\_INSTALL to install

the application, but you need to do it on only one node. Then, use the SDS FETCH command to grab the installation you just performed as well as all the savesets used in that installation. FETCH places this installation material in a library on disk (on a Library Server), and the INSTALL APPLICATION command retrieves it from the library and installs it on all the workstations in the group.

In practice, CAD\_SOFTWARE\_PRODUCTS might be a large number of products, with particular interdependencies and a need to install them in a particular order and with other software prerequisites. RSM lets you track these relationships and installs the software in the proper order. And the whole thing runs in a batch job, typically at night, and RSM lets you know when it's complete.

In a large group of workstations, it might take overnight or a weekend to install a large group of products, but

# It All The Time.

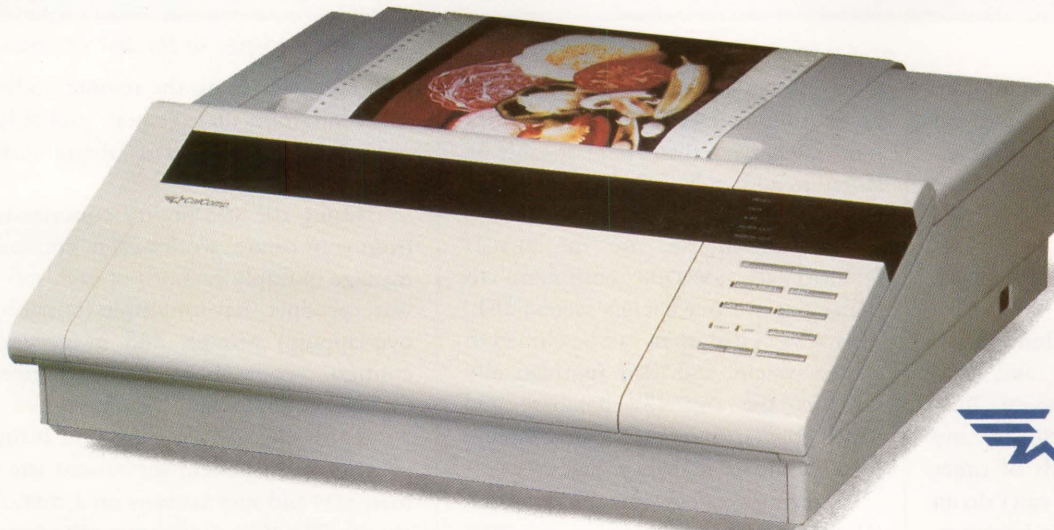

We draw on  
your imagination.™

 **CalComp**  
A Lockheed Company

# New CalComp ColorView.

CIRCLE 311 ON READER CARD

T

## TABLE 3.

RSM Full Backup Schedule at 30-JUN-1988 21:59:46	
Entry: .MIRAGE.INCREMENTAL Backup Level: INCREMENTAL Target: .OASIS Hours: 00:00 Qualifiers: /UNLOAD /DEVICE_TYPE=TAPE Upon successful completion, notify: oasis::pan,mirage::hls Upon failure, notify: oasis::pan,mirage::hls File_list: DUA0:[*...]/EXCL=(*.HLB,[SYS0.CDDPLUS]*.*) Suspended: NO No backups have been performed for this entry Entry created: 2-JUN-1988 17:42:05.61 Entry last modified: 14-JUN-1988 18:17:23.18	/DEVICE_TYPE=TAPE Upon successful completion, notify: ncoak::lmr,oasis::pan Upon failure, notify: OASIS::PAN File_list: DUA0: Suspended: NO 7 backup(s) have been performed for this entry Last backup completed at 20-JUN-1988 17:18:44.18 Entry created: 20-JUN-1988 15:43:00.26 Entry last modified: 14-JUN-1988 15:38:37.73
Entry: .NCOAK.FULL Backup Level: FULL Target: .OASIS Hours: 00:00 Qualifiers: /IMAGE /RECORD /UNLOAD /DEVICE_TYPE=TAPE Upon successful completion, notify: ncoak::lmr,oasis::pan Upon failure, notify: OASIS::PAN File_list: DUA0:/IGN=INT Suspended: NO 12 backup(s) have been performed for this entry Last backup completed at 29-JUN-1988 14:18:11.21 Entry created: 22-APR-1988 10:17:30.80 Entry last modified: 14-JUN-1988 15:40:58.22	Entry: .NCOAK.SPECIAL Backup Level: INCREMENTAL Target: .OASIS Hours: 00:00 Qualifiers: /UNLOAD /DEVICE_TYPE=TAPE Upon successful completion, notify: oasis::pan,ncoak::lmr Upon failure, notify: oasis::pan,ncoak::lmr File_list: dua0:[*...]/since=25-apr Suspended: NO 1 backup(s) have been performed for this entry Last backup completed at 22-JUN-1988 23:47:04.88 Entry created: 22-JUN-1988 23:35:51.41 Entry last modified: 14-JUN-1988 15:38:38.32
Entry: .NCOAK.IMAGE Backup Level: FULL Target: .OASIS Hours: 00:00 Qualifiers: /IMAGE /RECORD /UNLOAD	Entry: .NGOAK.TRICS_ROOT Backup Level: INCREMENTAL Target: .OASIS Hours: 00:00 Qualifiers: /UNLOAD /DEVICE_TYPE=TAPE Upon successful completion, notify: oasis::pan,ncoak::lmr Upon failure, notify: oasis::pan,ncoak::lmr File_list: trics_root:[*...]*./record Suspended: NO 1 backup(s) have been performed for this entry Last backup completed at 22-JUN-1988 23:59:36.71 Entry created: 22-JUN-1988 23:38:31.89 Entry last modified: 14-JUN-1988 15:38:38.61
	5 entries listed.

*Some entries in the test database.*

RSM manages the entire process for you. Furthermore, if one or more nodes fail because of inadequate disk space or because the client node was down, RSM keeps track of which nodes have had a successful installation, so the same command can be used again to retry all the nodes that failed.

It's also possible to clone entire workstation environments and load them onto a new workstation. RSM knows how to do an ISL of any workstation and most kinds of other VAXs on the Ethernet. RSM can't do an ISL of a machine not on the Ethernet, because RSM uses the DECNET MOP protocol to bootstrap the client, and the required DECNET protocols aren't sup-

ported in WANs. To support a dynamic asynchronous DECNET link requires more intelligence than can reasonably be stored in a ROM like the one used on a DEC Ethernet card.

To do an ISL, use the FETCH OPERATING\_SYSTEM command to grab a copy of one client's system disk. This system disk then can be cloned to a bare system, and RSM automatically will fix the DECNET database and SYSGEN parameters on the new system to differentiate it from the source.

Storing system images as VMS-INSTAL savesets on disk in the RSM Library can require a large amount of disk space. However, the advantages of having convenient and synchronized distribution of software, no distribution

media or devices on the remote nodes and centralized management probably outweigh any concerns about disk storage.

Using the SDS library commands from your central workstation, you can manage multiple versions of each software product, have multiple (possibly overlapping) groups, and in general configure your clients in any logical manner you choose.

Most sites use a workstation as the primary management server and store their SDS and BRS savesets on a central cluster. The RSM manager works from the workstation and even can install new versions of the software on his own workstation first. Then he uses SDS

# OUR NEW PRINTER PUTS YOU AT THE HEAD OF THE CLASS.

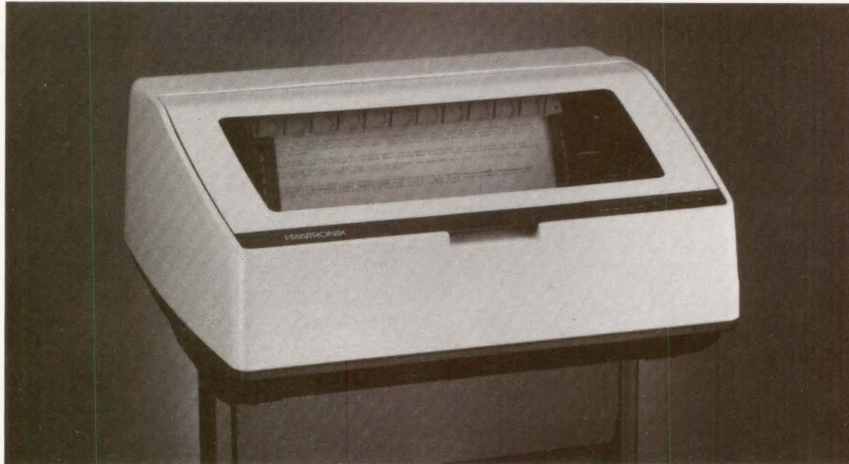

**MEET THE P3040.** The reliable line printer that outperforms the other members of its class.

## Unbeatable Versatility.

Multi-mode printing means you match print quality and speed to each application. Select Correspondence, Data Processing or High Speed modes and watch the P3040 respond—at up to 400 lines per minute.

Compressed print puts more data on a page—up to 17 cpi. So you save paper, mailing and filing costs.

Character-by-character attributing creates custom looks. Design reports with bold, underlining, expanded and shadow print, superscripts and subscripts in all available character sizes.

Intelligent Graphics Processor (IGP™) Option adds electronic forms and bar codes, eliminating the need and cost of stocking pre-printed forms. Design invoices, sales orders, shipping documents and other forms easily. Then print the form and data simultaneously.

## High Reliability.

The P3040 combines new design features with Printronix stored energy hammer bank technology for field proven reliability. Easy to maintain, the P3040 is operator cleanable and features self-diagnostics for lower service costs.

## The Price Performance Leader.

The P3040 offers more performance, higher reliability and a lower price. So go to the head of the class. Call us for information on the P3040, or other members of the Printronix printer family.

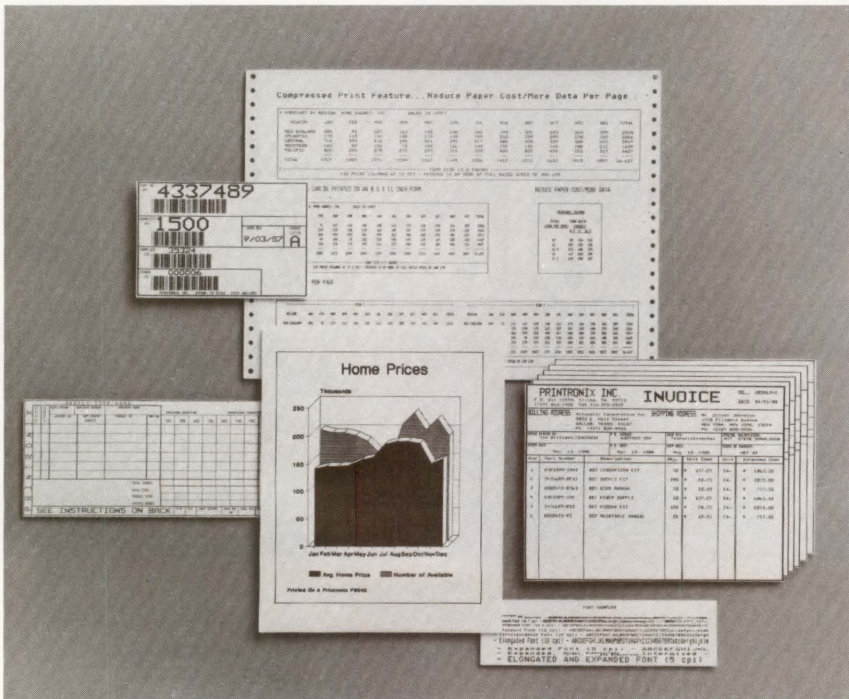

# PRINTRONIX®

The First Line in Printing Solutions.

P.O. Box 19559, Irvine, CA 92713  
800-826-3874

For more information, circle 150. To have a salesman call, circle 152. See us at COMDEX/Fall, Booth #616

1 9 8 9  
digital review  
**TARGET  
AWARDS**  
N O M I N E E

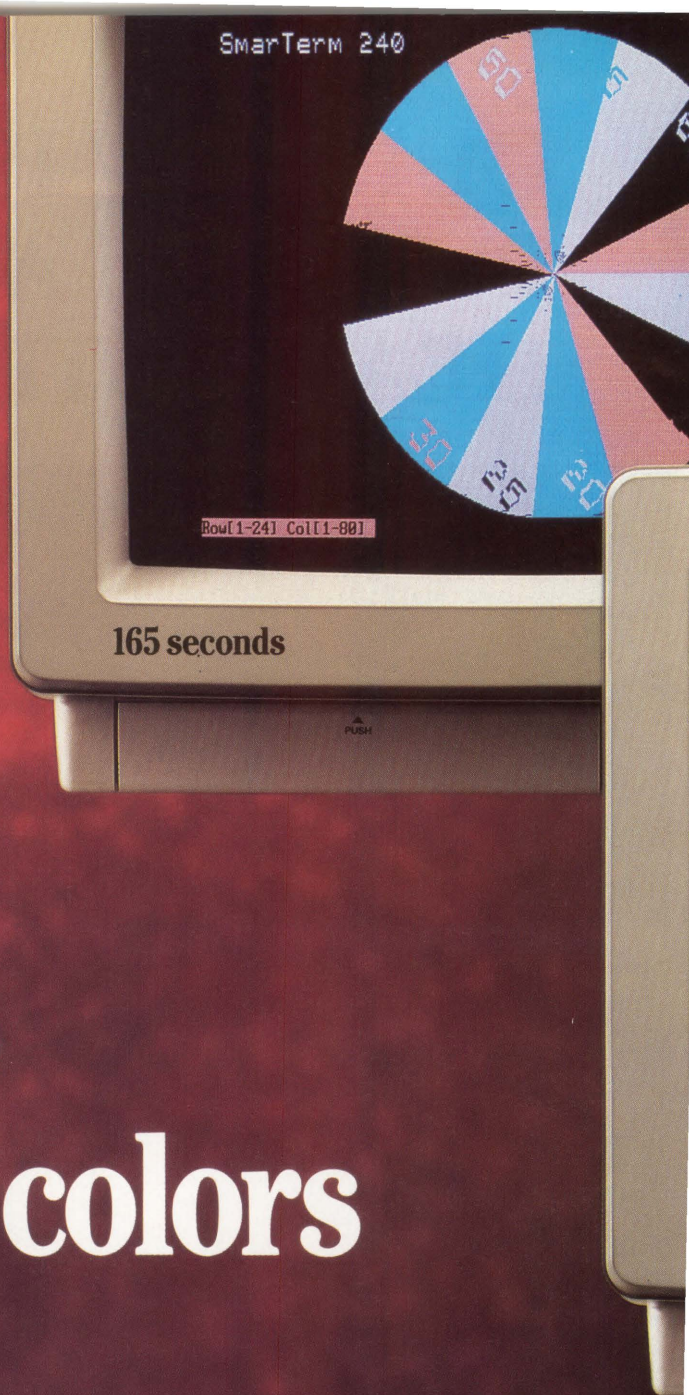

# Reflection 4- First with 16 colors

Reflection 4 PLUS comes in **first** with emulation of the 16-color graphics in VT340 terminals and **background communications**. You get powerful productivity features like **PC-to-VAX Backup and Restore**. **Keyboard remapping**, letting you map long text strings to any PC key. A scripting language with **800 variables**. Reflection works in popular networks, and even maintains **multiple LAT sessions** with WRQ's R-LAT™ or Digital's PCSA.™

Reflection 4 PLUS gives you accurate VT241 and 16-color ReGIS graphics emulation for \$349.\* Reflection 2 PLUS, for \$249,\* combines VT220 and Tektronix 4014 emulation. With our 60-day satisfaction guarantee, there's nothing to lose.

\*\*Poly-STAR/240 ignores the ReGIS polygon fill command used to color the stopwatch.

Test was run on an IBM AT with an EGA and high-resolution color monitor. Screens were timed locally using one data file. Files photographed are identical, except for product names. Software versions: Reflection 4-3.1; SmarTerm 240-2.0b poly-STAR/240-1.1.

**REFLECTION®**  
S E R I E S  
**SOFTWARE**  
**1-800-8PC-2VAX**  
1-800-872-2829

Walker Richer & Quinn, Inc.   
2825 Eastlake Ave. E., Seattle, WA 98102  
206-324-0350 FAX 206-322-8151

\* Plus shipping and sales tax where applicable. Aggressive quantity discounts apply. Reflection and R-LAT are registered trademarks of Walker Richer & Quinn, Inc. SmarTerm, poly-STAR, and PCSA are trademarks of their respective holders.

Poly-STAR 240

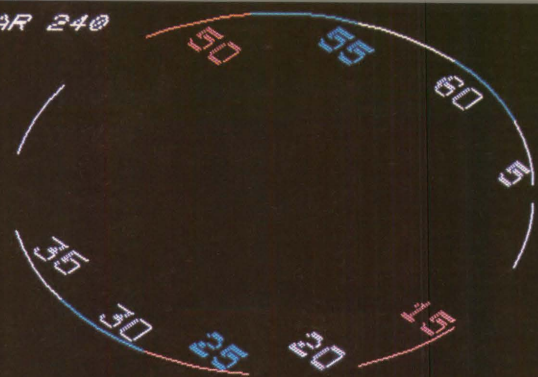

13 seconds\*\*

Reflection 4

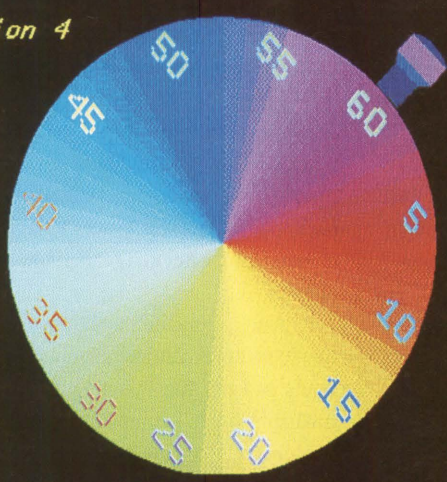

28 seconds

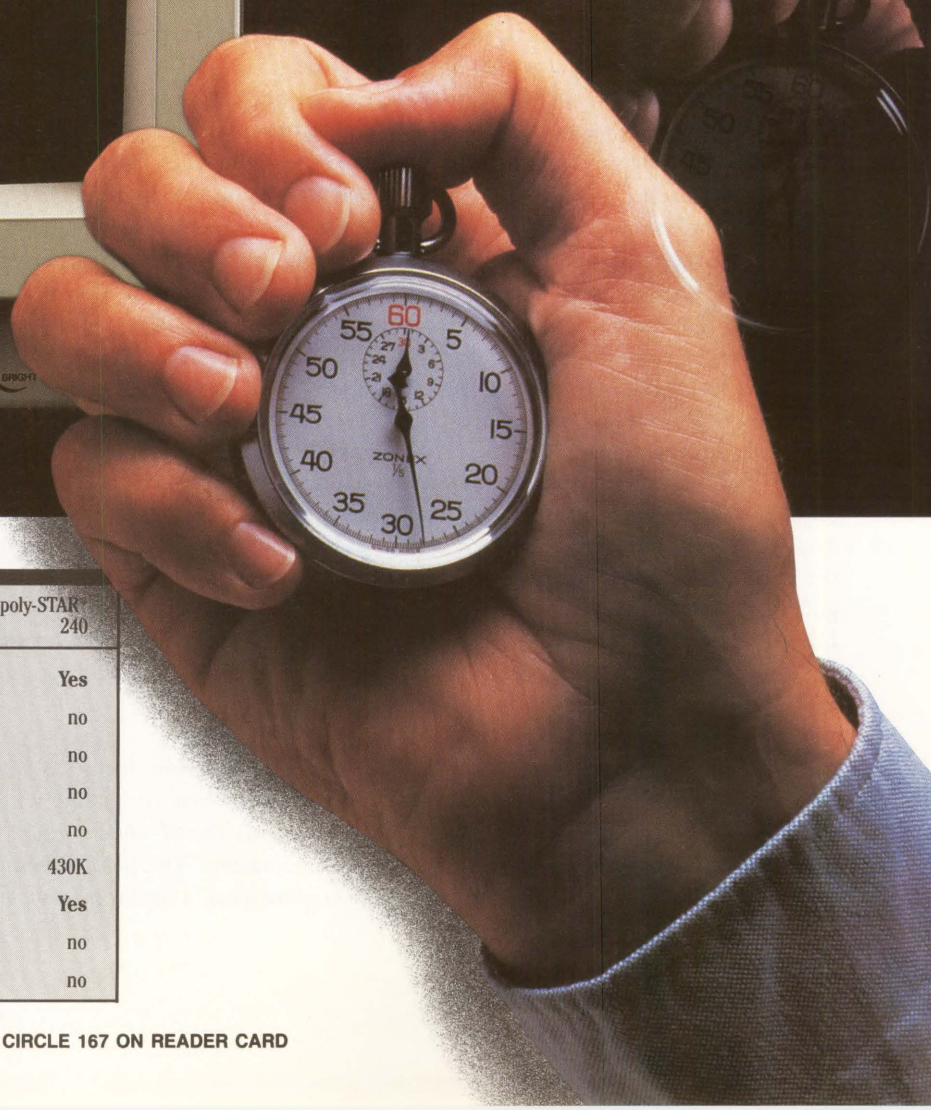

	Reflection® 4 PLUS	SmarTerm® 240	poly-STAR® 240
VT241 Terminal Emulation	Yes	Yes	Yes
VT340 ReGIS Graphics	Yes	no	no
16-Color Display	Yes	no	no
Polygon Fill	Yes	Yes	no
Background Multitasking	Yes	no	no
RAM Used	220K	375K	430K
Complete Keyboard Remapping	Yes	no	Yes
Back up PC Files to VAX	Yes	no	no
Variables in Command Language	Yes	no	no

CIRCLE 167 ON READER CARD

commands to FETCH copies of the software to the SDS server (the cluster) and INSTALL those on the clients.

## Customer Reactions

We talked to several sites using RSM in the mode described here. The sites contained from two to 24 clients using RSM and a single experienced system manager. Each site still required a knowledgeable system manager in charge of all of the pieces. The system management problem doesn't get easy using RSM, just manageable.

However, with RSM, a single system manager can keep up with the software configuration needs of 24 workstations. In that particular application, a research environment, there were several different groups of nodes with different versions of software and both VMS and ULTRIX nodes.

The software libraries filled an RA81 disk drive, but the site manager traded an RA81 to avoid hiring several more system managers. Endorsements like, "We couldn't live without it," came from the site manager, and words like, "Take it away," and, "I quit," came from the system manager responsible for a dozen workstations.

Large sites use RSM to schedule regular backup of their disks. Because RSM can manage remote backup to tapes, we expected to find that most sites were using that method of saving their data. However, several sites were doing automatic RSM backup to disk, keeping one or two generations of backups on disk and purging those savesets.

In our Lab, we tested remote backup to tapes, saving and restoring data from remote clients to a TK50 on the backup server. Performance was generally very good. Backups over the Ethernet proceeded at about 5,000 blocks per minute and, over the 19.2K baud dial-up lines, we got more than 11,000-baud effective throughput, the useful bandwidth after DECNET overhead. We noticed that there was little load on the BRS server while doing these activities, so you probably could

do several backups simultaneously.

The data that travels over the network includes both BACKUP CRC and RSM's own checksums, as well as any hardware-based error detection/correction in the modems or Ethernet devices. Thus, the quality of the data is high. Furthermore, RSM/BRS warns you if any errors occur during the backup operation and keeps a log of the entire operation so you can look into the errors.

You create an entry in the backup schedule database using the ADD ENTRY command. If you can use DCL, you can talk to RSM. Table 3 shows some of the entries in our test database.

RSM keeps a log of all the BRS operations and their status, such as schedule, complete, or failed. The log is maintained separately for each entry in the backup schedule database. You can elect to save that history information or purge it periodically. When managing a large number of nodes, it's useful to keep a history so that you can trace problems and decide which savesets might contain the files of interest for a restore.

In our case, because the DECNET link to some of the nodes is dynamic, we used the BRS command START BACKUP to initiate an immediate processing of some backup requests. We brought up the network, started the backup and brought the network down when the backup was complete.

We would have appreciated the ability to run an arbitrary command file before and after the backup procedure ran. That way, we could have attempted to use something like VAXNET log in scripts to bring up the network dynamically, as part of the regularly scheduled backup procedure at night. Unfortunately, this capability is not available without playing with the internals of the BRS command procedures.

## Light Reading

The documentation for RSM is very good, even when compared with the high standards of most other VMS documentation. The RSM documentation consists of a *Reference Manual* that

lists all the commands and their usage and a *Management Guide*. The *Guide* provides information on how to configure your RSM servers, discussions of all the operations that RSM can perform and detailed instructions on many special procedures that you can do using RSM. There is a complete set of examples within the flow of the documentation, not dumped in an appendix.

The procedures for installing RSM are well-documented. They assume that you understand the complex issues of system management, but they give you excellent information about how various RSM configurations and uses can help you address those issues.

The CAS section of the manual contains step-by-step procedures for performing a number of common operations such as authorizing new users, distributing system databases to clients and checking security on RSM clients.

An appendix explains security in the RSM environment, including discussions of how RSM uses rights lists to let multiple users initiate RSM requests and how proxy log ins are used by RSM. An appendix on troubleshooting was also useful.

Pricing for RSM is aggressive. DEC wants you to install RSM on all your workstations. The client license for RSM is included as part of the Software License Portfolio that allows you to license a workstation for a full software development environment (most of DEC's compilers, database systems and software development tools) for about \$155 per month. Considering that RSM provides you with excellent tools to manage your distributed workstations and multiple layered products in a cohesive fashion, the cost of the server license is a good investment indeed.

In the next installment in this series, we'll look at a tool to mount disks remotely, Distributed File Services.

ARTICLE INTEREST QUOTIENT  
Circle On Reader Card  
High 562 Medium 563 Low 564

# Add PEP to your 11/70 and relax!

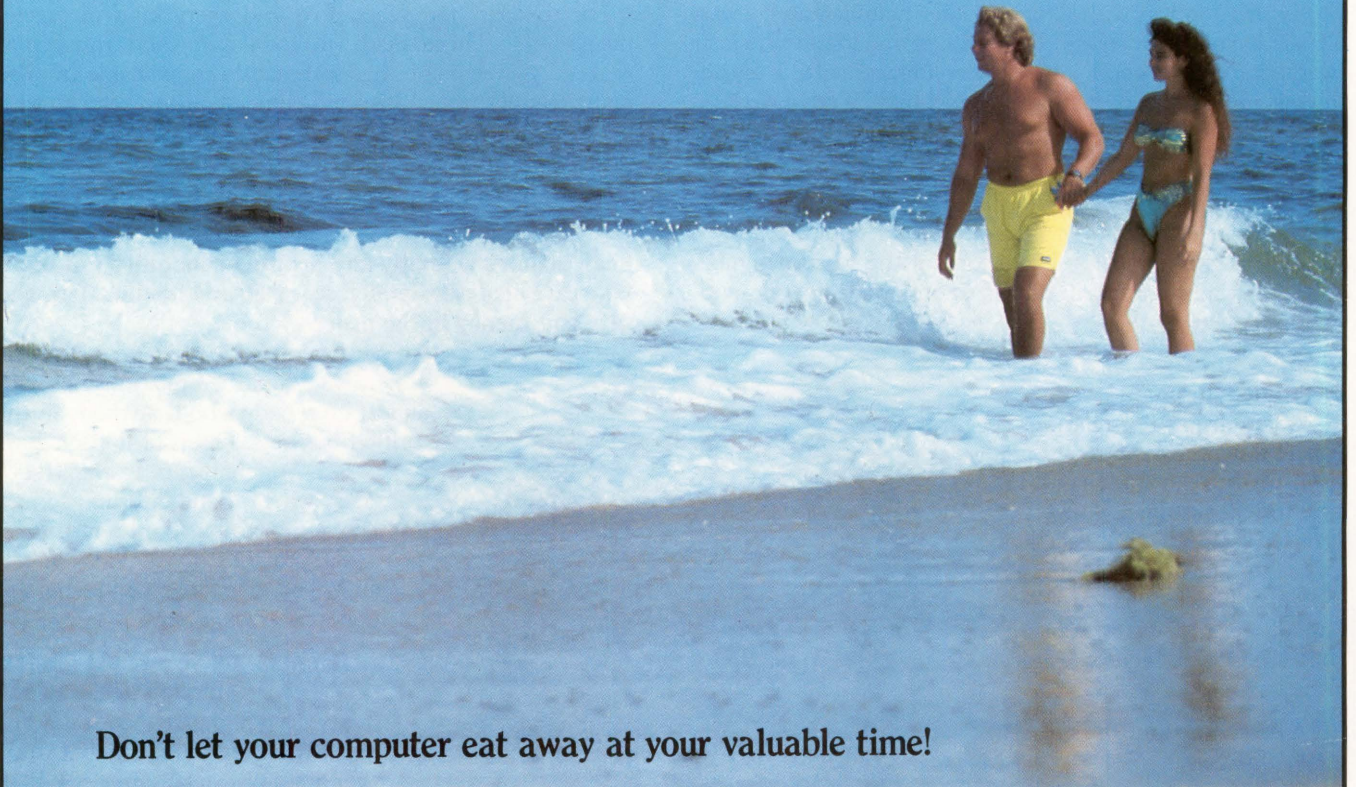

Don't let your computer eat away at your valuable time!

## PEP-70, HC70

Our enhancement products improve PDP-11/70 performance to unprecedented levels. The 11/70 can now execute an instruction up to 450% faster as measured using a single instruction. Customers running under RSTS/E, RSX11M+, UNIX, etc., have consistently reported application level improvements of 80% to 100% using THEIR MEASUREMENTS ON THEIR APPLICATIONS.

## UEP

Our Unibus Enhancement Package will provide vastly increased system throughput and Bus bandwidth for the 11/24 through 11/55 Unibus machines.

These are "plug-and-play" performance enhancement products which do not interfere with existing hardware or software operation.

Higher system productivity is achieved without the expense and problems associated with replacing the entire system.

All DDS/SETASI products are backed by a lifetime warranty, effectively protecting your PDP-11 investment for many years to come.

A video tape (VHS) of a condensed 11/70 architectural seminar is available to qualified individuals.

Call us today at 1-800-SMART-11 for additional information.

For additional information call or write:  
**DIGITAL DATA SYSTEMS INC.**  
1551 N.W. 65th Avenue, Fort Lauderdale, FL 33313  
**1-800-SMART-11** (800) 762-7811 (305) 792-3290  
TWX: 910-997-4751 (Digital) FAX: 305-581-1325

Note:  
PDP-11, UNIBUS, RSTS/E and RS11M+ are registered trademarks of Digital Equipment Corp.  
PER-70 and HC70 are trademarks of DDS & SETASI.  
UEP is a trademark of DDS. UNIX is a trademark of AT&T Bell Laboratories.

© 1989 DIGITAL DATA SYSTEMS, INC.

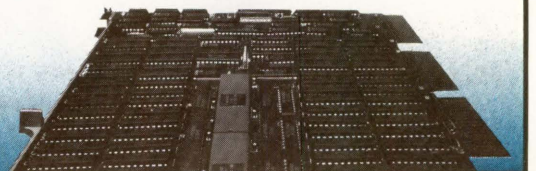

# David on Goliath

*Dave Lester. He rides a quarterhorse, skis off cliffs and knows everything there is to know about printers. Here, he tells why you should buy your next line, band or laserprinter from him, rather than from one of the big, Goliath-size printer companies.*

## **I was just a kid.**

My first job was with a large printer manufacturer. I was 20 years old and in college. Being young and idealistic, I just wanted to do a good job. Almost immediately, I found myself running a production line and had 20 employees.

## **About the worst-designed ribbon lift mechanism the world has yet seen.**

I learned everything there was to know about printers. Piece by piece. There was no problem I couldn't immediately diagnose and fix. I took one of the worst-designed ribbon lift mechanisms in the world and made it work, and work perfectly.

## **Pretty soon I was also doing customer support.**

When distributor relations got really tough, *yours-truly-the-printer-whiz* was sent into the field. Like the time a customer claimed printer DOAs were in excess of 50%. In half a day, making trivial adjustments and tweaks on 50 printers, we had a happy distributor. And I had a great job offer.

## **The secretary and the DIP switches.**

My new job was selling for a big printer distributor. One day I was talking to a woman who said one of the printers she got from us was the biggest piece of junk in the world; and that we should never darken her doorstep again. I asked her to be specific with her problem description. And since she was sitting beside the unit as we talked, I asked her to open it up and reset some of the DIP switches and then try the printer. It worked better than it ever had before. She was elated, and they bought five more printers.

© 1988

## **Why buy from Goliath?**

For the past ten years, I've sold every kind of printer imaginable. Those made in the USA, and those that weren't. Never before has so much been available from so many manufacturers. It's a full-time job just to keep up with it. Now, it's my job. My full-time job. There are many printers, from big companies, with armies of salespeople scrambling to find . . . you. They really don't have your best interests at heart. They want to sell *their* printers. Period.

## **I can acquire virtually any printing capability you want, take care of all the details, research and justification, and save you money in the process.**

I'm not exactly a kid anymore. Over the years, I've established relationships with almost everybody who is anybody in the printer business. Lasers or impact. Line or character. Dot matrix or daisy wheel. Band or drum. I know who has the hottest price/performance, *today*. I also have a pretty good idea who will be here to support you *tomorrow*.

## **Even if you've already made a buying decision . . .**

. . . you should give me a call. The worst that can happen is that you'll get *peace-of-mind insurance*. I'll tell you I couldn't have done any better for you. And you can give Goliath my warmest regards. The best that can happen? You might give me the pleasure of smiting Goliath just one more time.

**Dave Lester  
Incline Technology  
The Printer Source  
(415) 782-9766**

3401 Investment  
Blvd., Suite #8  
Hayward, CA  
94545

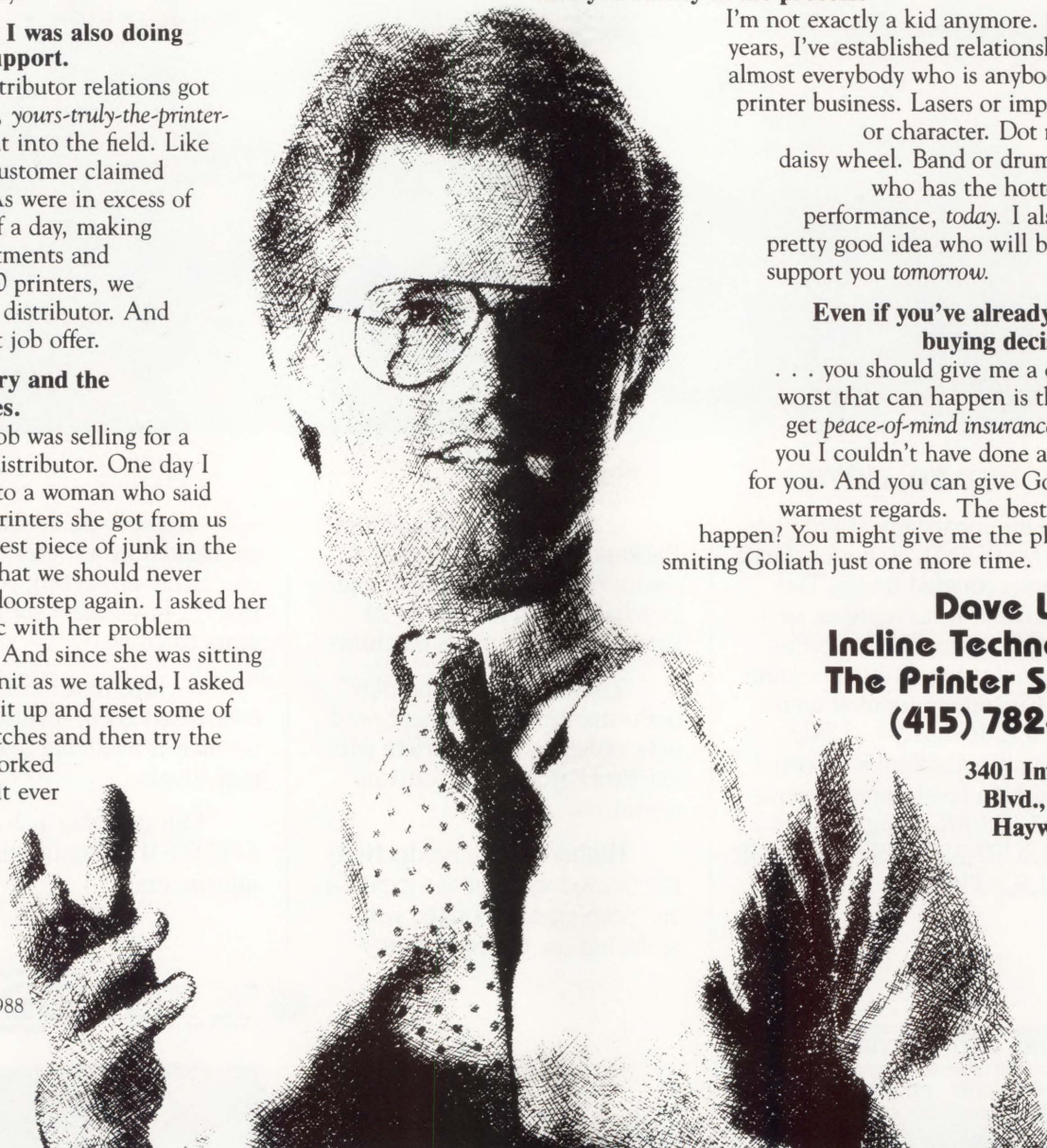



# MORE THAN A DATABASE FOR THE DEPARTMENT COMPUTER

**Over the noise of corporate issues, your department's computing needs are not always heard. In the stack of things to do, they often wait at the bottom of the pile.**

**RDM** is the ONLY application developer designed specifically to get department software development done. More than just a database, **RDM** is a complete application development system AND full relational database — integrated into one flexible, table-driven tool.

**RDM's** table-driven technology is a generation beyond conventional database development. **RDM** supplies all the parameters that shape standard application components. You add your own custom-designed specifics. **RDM** eliminates the need to code and recode routine application features.

**RDM** is nonlanguage, fill-in-the-form application development. With no programming code to analyze, the learning curve is short and productivity increases. With or without software development specialists, you create the entire application: data input forms, summaries and reports, command menus, on-line help files and processes to validate and manipulate data. You'll implement even the most procedural tasks — without procedural language syntax.

After initial software development — your department's needs will evolve. **RDM** makes system modification and maintenance easy. You add new forms and reports — when you need to. You create new files or change data relationships — quickly. And without any change or rewrite, **RDM** applications will transfer and share data across 10 different operating systems. You save time and money with one software product for your VAX, PDP11 and IBM-PC.

Since 1980, **RDM** has been the choice of more than 2500 departmental application developers. For quick application development and easy maintenance, for increased productivity and extended portability, for stand-alone, integrated, distributed or networked systems . . . there's no better software solution than **RDM**.

**Find out how your applications can rise to the top of the stack. Call today.**

**800-362-6203**

**In Canada, call 800-255-6378**

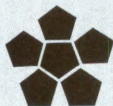
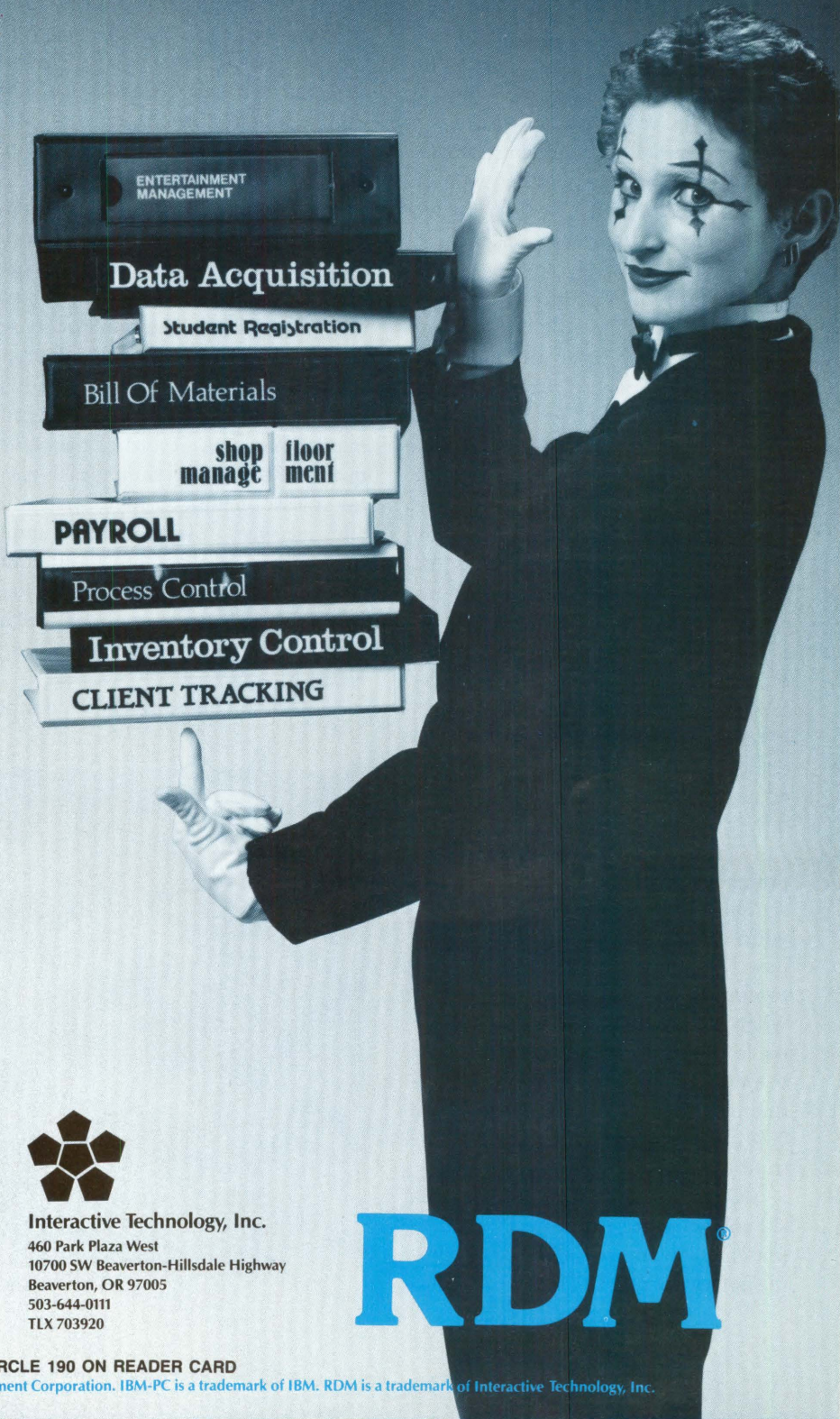

Interactive Technology, Inc.  
460 Park Plaza West  
10700 SW Beaverton-Hillsdale Highway  
Beaverton, OR 97005  
503-644-0111  
TLX 703920

# RDM®

CIRCLE 190 ON READER CARD

VAX and PDP-11 are trademarks of Digital Equipment Corporation. IBM-PC is a trademark of IBM. RDM is a trademark of Interactive Technology, Inc.

# The Mysterious Problems Of Line Power

Every day, "dirty power" causes faults or problems with microprocessor-based equipment. Whether you're using a personal computer, terminal, engineering workstation, laser printer or other type of electronic device, when you experience mysterious occurrences, check the line power.

Fluctuations in the incoming power can cause computing problems ranging from hard system failures to intermittent keyboard lockups, from sporadic disk I/O and logic errors to software crashes. Sometimes, the computer just stops. At other times, it loses data for no apparent reason. These and other frustrating computer problems result in "no fault found" maintenance calls that are among the most costly in the industry.

According to some sources, power problems account for as much as 50 percent of all computer system downtime. It's estimated that up to 40 percent of all computer service calls are power-related. But when site problems occur, power usually is suspected last.

There are two basic types of line power monitoring: preventive and operational. Preventive power monitoring, which judges the quality of incoming power, should be employed before equipment is installed at a new site, or when major equipment changes are made at an existing site. Power should be monitored at existing sites on a continuing basis to locate possible line power disturbances before they become troublesome.

Operational power monitoring should be performed whenever intermittent problems occur and to monitor the power output of all new power con-

ditioning equipment installed (see Table). Power monitoring during times of erratic computer behavior can prevent wasted time and money spent in attempting to repair hardware and software that aren't broken.

## Checking Line Power

The easiest, most convenient method of checking line power is to use a power line monitor. This device senses fluctuations in the power supplied to your computer system. The monitor senses power disturbances, indicates the type of disturbance and either comes with or can be attached to a recorder that produces a hardcopy record of the power quality. Monitoring should take place for at least one full business cycle, usually one week. This should be ample time to locate the cause of an intermittent fault condition, such as load changes, utility company power switching or the turning on or off of large electrical equipment.

Most simple power line monitors

either sound an alarm to indicate an out-of-tolerance power condition or record the event on a fault log. The monitor I evaluated, the Monitron 2000 from Mendon Electronics Corporation of Pittsford, New York, uses the latter method. I didn't use the optional hardcopy recorder unit.

The Monitron 2000 costs \$299 and comes with an easy-to-follow 18-page user guide. The guide includes a helpful power problem solutions chart to aid in determining what type of power conditioning equipment would best improve your power quality, and a log sheet for recording events. It took me less than 15 minutes to unpack the unit, read the guide and install the Monitron 2000.

## Monitoring Incoming Power

To oversee your incoming ac power, plug the monitoring unit into the same outlet as the equipment being monitored. Note the date and time of the installation and keep a complete daily log



*Mendon Electronics Corporation's Monitron 2000.*

# MASTER CONSOLE. THE MASTERMIND OF MONITORING.

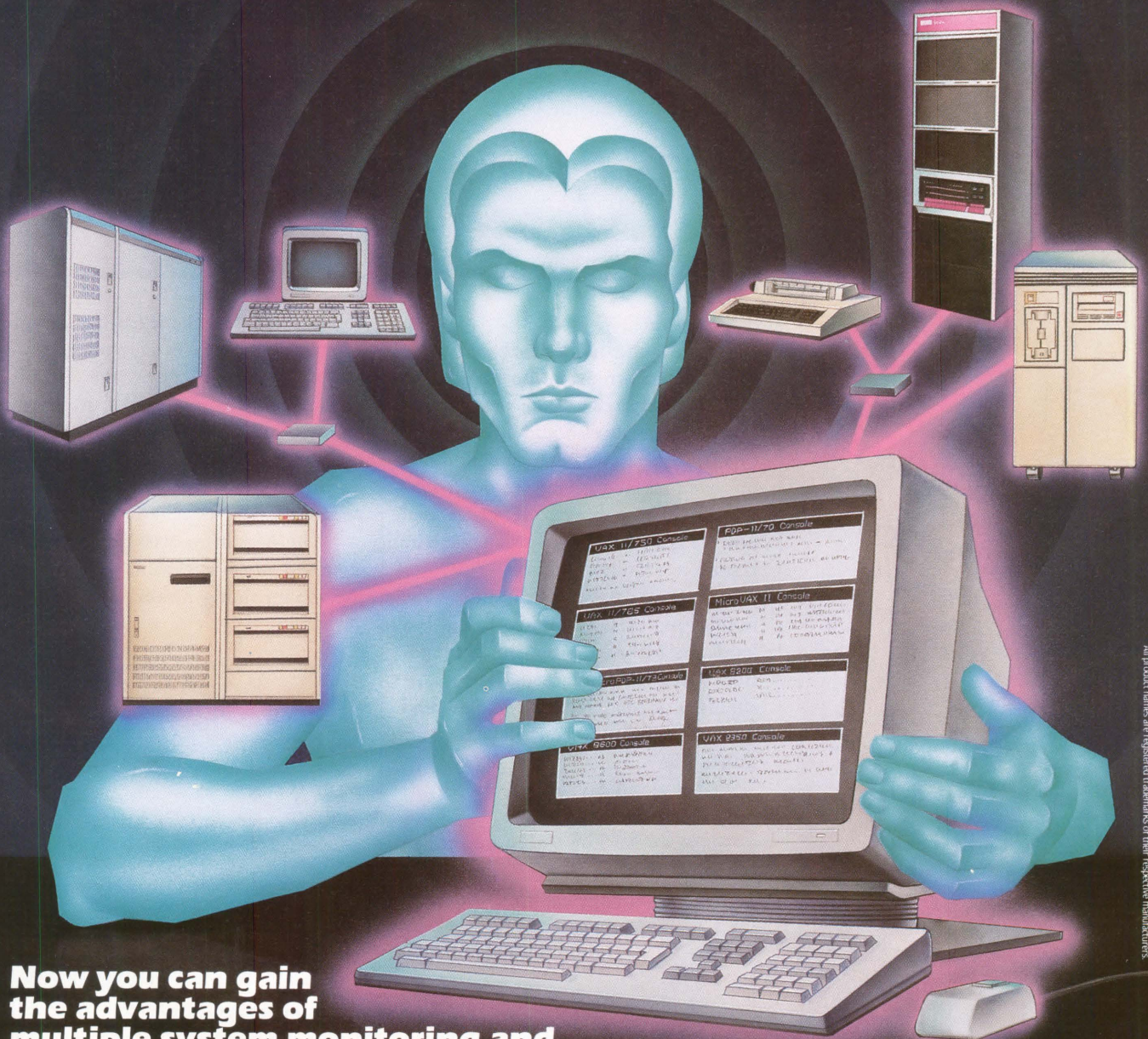

## Now you can gain the advantages of multiple system monitoring and control from a single location.

Maintech introduces "Master Console," an innovative product from Volt Delta Resources that can streamline your operation and effect major savings.

With Maintech's "Master Console" you can monitor and control up to 8 DEC processors from a single location. Through a dynamic windowing process, "Master Console" creates a scrolling mini-terminal for each processor, all on a single high resolution monitor. The immediate benefit to management: centralized control, elimination of stored console logs and huge gains in individual productivity.

Other cost efficiencies are gained by eliminating the space requirements and clutter of consoles and console printouts on the computer room floor. Equally impressive, "Master Console" lets you archive your console logs on tape and prints out what you want to see.

### Other features:

- Supports PDP, MicroVAX and VAX systems
- String search for user defined critical messages
- Audible and visual alarm and prioritized error reporting
- Concurrent local console operation
- Tiled windows and special purpose function keys
- Console log with scrolling, historical archive and restore

For your convenience, hardware leases and purchase plans are available.

"Master Console." Another powerful product from Maintech, the innovative leader in the independent service marketplace.

**MAINTECH**  
GUARDIAN MAINTENANCE SERVICES  
A DIVISION OF VOLT DELTA RESOURCES INC.  
**1 800-426-TECH**  
1133 Avenue of the Americas  
New York NY 10036  
212 827-2600  
A VOLT INFORMATION SCIENCES COMPANY

All product names are registered trademarks of their respective manufacturers.

**WE  
SPEAK  
YOUR  
LANGUAGE.**



**DEC TECHNICAL CHARACTERS  
and  
WORD PERFECT**  
Keysets Now Available!



- Increase value of system
- Decrease training time
- Decrease error rates
- Increase productivity
- Fully utilize your system

Give your keyboard the legends, characters, languages, & symbols you want.

DEC, IBM, WYSE, & others. We stock EDT & Word Processing also. Call Lee or Daryl today for details. (619) 581-6303

**Syntronics**

4901 Morena Boulevard, Suite 302  
San Diego, CA 92117

CIRCLE 161 ON READER CARD

## T A B L E .

### POWER PROBLEMS

Device	Protects Against
Uninterruptible Power Supplies	Spikes, High and Low Voltage, Noise, Dropout, Power Failure
Surge Suppressor	Spikes, High Voltage
Power Line Filter	Spikes, High Voltage, Noise
Line Voltage Regulator	Spikes, High Voltage, Noise
Standby Power Supply	Power Failure, Dropout

of power quality.

Note fault conditions as well as the time they occurred and whether or not they were cleared. When possible, an on-duty operator should note special events, such as a building air conditioning compressor turning on, other systems switching on or off, or general power failures or cutbacks that could be related to a fault condition.

The end date and latest time of the monitoring cycle should be listed. If a hardcopy recorder is used in conjunction with the monitoring device, it should note the start and end dates and times. The printout then can be filed for future use.

The Monitron 2000 checks for the following conditions:

1. Spike — An impulse of more than 200 volts.
2. High — Voltage has gone above 125 volts.
3. Low — Voltage has dropped below 108 volts.
4. Dropout — A power interrupt of at least one-half cycle has occurred or power dropped to below 96 volts.
5. Power Fail — A power interrupt of at least 100 ms has occurred.

After a condition has been recorded, the indication remains active until the operator resets it by pressing the clear button. This ensures that no fault conditions are missed during unattended operation.

I used the Monitron 2000 for one week. It recorded four high-voltage

conditions during the seven-day period. I found that the excessive voltage conditions occurred when the electric power company switched loads every night at the same time. Because I never use my system during the load switching time, no protective action was necessary.

The Monitron 2000 performed as expected and was capable of monitoring the incoming power.

### Monitron 2000

**PLATFORMS:** Attaches to power line outlet where microprocessor is connected, 120 volts ac

**PRICE:** \$299 for monitor, \$1,295 for system with six-channel recorder

**MENDON  
ELECTRONICS CORP.**

**HEADQUARTERS:**

3800 Monroe Ave.  
Pittsford, NY 14534  
(716) 248-8480

**FOUNDED:** 1987

**PRODUCT LINE:** Power line monitors, recorders for use with power line monitors, and power disturbance generators

CIRCLE 463 ON READER CARD

# Decked out for DEC™

TRW puts the finishing touches on DEC systems. Whether you're a system user, manager, self-maintainer or third party maintainer, TRW has the right service solutions for you . . . for minimum downtime and maximum productivity. Let our expertise in training, diagnostics, tech support, module repair & replacement, and maintenance programs be your single, reliable source for all your DEC system support needs.

## Advanced Hardware Training for Systems Maintenance

There's no substitute for experience. And TRW's many years of unmatched experience as the undisputed leader in alternative training for DEC products has earned us a solid reputation for the highest quality courses. On-site or at our fully equipped Virginia training center, we offer a wide curriculum of hardware maintenance courses that ensure upgraded knowledge and skills for solving real field engineering problems. Our flexible training methods are designed to serve in-house service organizations as well as third party maintainers. Plus, for unique operations and applications, TRW can custom design courses to meet individual needs.

## Software Training for Systems Management, Operations and Security

TRW offers a growing number of specialized software courses that provide a thorough understanding of VAX/VMS operations and utilities, system management procedures, and system security features.

Our courses combine theory with application and address actual system operations. And, because students have individual access to terminals where they can learn on-line, they can practice their new skills concurrently with their training.

## Affordable Diagnostic Packages

TRW's exclusive family of diagnostic packages solve DEC system problems fast. User-friendly and menu-driven, these unique tools help diagnose system faults quickly . . . right down to the FRU!

Available at volume discounts, our time-saving, money-saving DEC hardware "detectives" include:

- TRW 700 Series stand-alone and on-line diagnostics for VMS based systems
- TRW 86SDP stand-alone and on-line diagnostics for DEC 8600/8650 systems
- TRW M.T.P. — On-line system exerciser for MicroVAX II
- TRW DECLASS — A memory purge utility and memory diagnostic
- TRW U.S.E. — On-line system exerciser for UNIX-based VAX systems
- TRW Snap File Analyzer — On-line diagnostic that translates 8600 Series error snap file into English, and compares the values to specifications.

And just released, TRW diagnostics for the VAX BI Series: 8200/8250/8300/8350 systems.

## Fast, Responsive Technical Support

DEC systems users, operators and managers from some of the world's leading corporations also rely

on TRW for highly responsive, phone-in technical support. TRW teams of DEC experts are always available through our national support center.

Backed by an advanced remote diagnostic system, they are especially trained to isolate problems thoroughly and quickly. Plus, TRW also offers consultative services such as site planning, unique training, and much more.

## Module Repair & Replacement — A Source for Parts, A Resource for Repairs

Need a module repair and replacement service you can really count on? Then count on TRW to locate or repair the modules you need. A nationwide logistics operation plus specialized repair centers make TRW your single reliable source.

## Total Maintenance for Maximum Uptime Assurance

Want maximum DEC productivity? Then get the most comprehensive maintenance support available: a total TRW maintenance service partnership. More than a contract for all our services, it's our commitment to your maximum uptime. A commitment we can fulfill by delivering prompt, reliable, professional service at a competitive price and by making major investments in people, training, support systems and parts inventories.

All these resources, plus experience, go into every maintenance agreement.

From DEC support to total maintenance service, TRW has the right finishing touches for DEC systems.

Call today! Let TRW custom design the best program for you. 1-800-255-3029 (in Virginia call 1-703-898-7555)

Or write:

**TRW Technical Support Center**  
420 Hudgins Road  
Fredericksburg, VA 22401

© TRW Inc. 1988 TRW is the name and mark of TRW Inc. DEC, VMS, VAX, MicroVAX II and VAX BI are trademarks of Digital Equipment Corporation. UNIX is a trademark of American Telephone and Telegraph. These trademarks are used solely for identification purposes.

The TRW logo consists of the letters 'TRW' in a bold, stylized, orange-red font. The letters are blocky and have a slight shadow effect, giving them a three-dimensional appearance.

# Reading And Writing Declarations, Part 2

*Editor's note: Last month, Mr. Jaeschke presented the rules and techniques for reliably reading and writing arbitrarily complex declarations. This month, in the*

*final part of this series on types, he shows how to build on the type information present in declarations, generate casts, declare functions that have a given return type, use the **typedef** capability and use **sizeof**.*

You must know how to construct a declaration if you're going to have an identifier of that type. However, after you've mastered reading and writing declarations, you must learn how to apply that type information in other ways.

C uses type information in numerous ways. Apart from identifier declarations, types are used in casts, with **sizeof**, in defining function return types and in defining type synonyms with **typedef**. Let's examine the rules in constructing each of these and apply them to a series of types that have a varying degree of complexity.

## Type Usage Rules

1. To extract the type information from a declaration, omit the identifier. (Ignore the trailing semicolon in declarations, because it's not part of the declarator.) Table 1 shows some examples of declarations and their corresponding types.
2. To generate a cast for type T, extract the type information using Rule 1, enclose it in parentheses and use it as a prefix operator.
3. To find the size of an object of type T, use Rule 1 to extract the type information, enclose it in parentheses and use it as the (postfix) operand of the **sizeof** operator.
4. To define a function so it returns a value of type T, declare an identifier **ID** to have that type. Replace the identifier **ID** in the declaration with the name of the function, followed by a pair of parentheses containing the function's formal argument list. At the end of this declaration, write the function body enclosed in brackets.
5. To create a synonym for a type, declare an identifier **ID** to have that type. Add the keyword **typedef** in front of the declaration, replace **ID** with an identifier that's the type synonym you wish, and add a semicolon.

## Some Examples

To reinforce the five rules outlined above, let's apply the rules to each of four declarations (see Tables 2 - 5).

Note that the cast generated by the rules in Table 3 is illegal. It's not permitted to cast anything into an array (or a structure or a union). Also, the function definition is illegal, because an array can't be returned by value.

In Tables 4 and 5, the parentheses around **\*** aren't redundant. They serve to distinguish between an array of pointers (shown in Table 3) and a pointer to an array. The two types are quite different.

## The Importance Of typedefs

As types become more complex to write, the value of **typedef** becomes more obvious. In Table 5, the function **f** is defined using:

```
int (*f(arg-list))() ( /*... */ )
```

However, after the type synonym has been defined, it can be used instead of the longhand declaration as follows:

```
typedef int (*PTFRI)();
PTFRI f(arg-list) ( /*... */ )
```

That looks more manageable.

## Prototypes, Type Qualifiers And Classes

Types also can contain prototype information and qualifier and class keywords. However, not all of these are part of the type. Let's look at each separately.

Any declaration involving a function type can, according to ANSI C, contain argument list-type information. For example, if **f** is a function taking a **double** and a **char** pointer as arguments, and it returns no value, its prototype is:

```
void f(double, char *);
```

Besides declaring other functions of the same type, you can **typedef** such a declaration. However you can't cast into a function, return a function or find its size.

A declaration can contain more than one reference to a function. For example:

```
long int *(*f1(int, double))(int, int)
```

Here, **f1** is a pointer to a function that takes an **int** and a **double** argument and returns a pointer to a function that

takes two **int** arguments and returns a pointer to a **long int**. This type can be used with all the rules described above.

With the advent of prototypes, they can exist in casts, **sizeof** operands, **typedefs** and function definitions.

The type usage rules don't include class keywords, because these aren't part of an identifier's type specifier. It makes no sense to cast into a **static** type, return a **register** type or **typedef** an **auto** declaration.

The type qualifier keywords **const** and **volatile** can be used in a limited sense with the rules. Certainly, they can be present in declarations, function definitions and **typedefs**. However, they have no effect in casts and with **sizeof**.

## A Declaration Puzzle

The following puzzle, contrived at Cray Research, uses many of the concepts contained in this two-part series of articles. Although I don't necessarily sanction the use of such code, it can, depending on the circumstances, be useful and necessary. I've added function prototype information to the original code:

```
#include <stdio.h>

static glob1 = 1;
static glob2 = 2;
static glob3 = 3;

int *(*func(void))[3]
(
    static *ary[3] = {&glob1, &glob2, &glob3};

    return (&ary);
)

main()
(
    int *(*(*x)(void))[3] = func;
    printf("value = %d\n", *1[*(*x)()] + sizeof(glob3++) + glob3);
)
```

Here, **glob1**, **glob2** and **glob3** are **static** internal objects. They have static storage duration (life). As such, they're allocated space and initialized prior to **main** beginning execution. (On most hosted implementations, this would be done at compile time.) No type is specified, although the class is, in which case the type **int** is implied.

To use some more ANSI C terminology, the linkage (scope) of these variables is internal. They're visible in this source file only. Their names aren't exported to the linker.

In this example, **ary** is an array of three pointers to **int**. The **int** type is implied by the absence of type information. Also, **ary** has **static** storage duration. However, it has no linkage. It's local to the function **func**. It's initialized with the addresses of the three **static ints** defined earlier.

The value returned from **func** is **&ary**, and to the uninitialized, the **&** operator might seem superfluous. However, it's not. The address of an array is different from the address of its first element.

When an array designator (such as an array name) is used



# GURU®

## When you expect the world from your expert system.

**T**ired of being limited? It's time to discover GURU—an expert system environment with comprehensive inference engine and rule management controls.

### Incredible flexibility.

GURU lets you design an expert system that runs exactly the way you want. By using fuzzy variables, certainty factors, reasoning rigor, rule selection order, and numerous environmental and utility variables, you have virtually unlimited control over the consultation environment.

### Unprecedented development efficiency.

Using GURU's case saving and replay, you can track the effects that rule changes have on system behavior. You can also use meta rules to examine or alter other rules during a consultation. And using GURU's knowledge tree, you can display the relationships and dependencies between an application's rules, variables, and goals.

### Quick and thorough.

By mixing forward and backward chaining, goal search time can be shortened dramatically. And, using GURU's multiple rule firing capability you can re-fire rules as values change. GURU also comes equipped with seamlessly integrated 4th generation decision support capabilities such as data base, spreadsheet, and report generator.

GURU runs on PCs, LANs, and VAXs.

To find out how GURU can exceed your expectations, call 1-800/344-5832 or 317/463-2581.



**mdbs®**

P.O. Box 248  
Lafayette, IN 47902  
1-800/344-5832  
317/463-2581

### Explore the world of expert systems with GURU Tutor!

This full-featured development environment allows you to prototype GURU applications using rule sets, data bases, spreadsheets, and more for only \$75. To order, call us at 1-800/344-5832 or write. VISA, MasterCard, and American Express accepted.

GURU is a registered trademark of mdbs, Inc. VAX of Digital Equipment Corp.

CIRCLE 137 ON READER CARD

# T A B L E 1 .

declaration	type
double d short <b>int</b> s[6] struct tags *pstr union tagu (*pun) [7] enum tage (*( *fp) ()) [3]	double short <b>int</b> [6] struct tags * union tagu (*) [7] enum tage (*(*) ()) [3]

*Examples of declarations and their corresponding types.*

# T A B L E 2 .

declaration: char \*pc;  
cast: (char \*) expression  
**sizeof**: sizeof(char \*)  
function returning: **char** \*f(arg-list) { /\* ... \*/ }  
type synonym: **typedef char** \*PTC;

*In this example, pc is a pointer to char.*

# T A B L E 3 .

declaration: **char** \*ap[5];  
cast: (**char** \*[5]) expression  
**sizeof**: **sizeof(char** \*[5])  
function returning: **char** \*f(arg-list) [5] { /\* ... \*/ }  
type synonym: **typedef char** \*A5PTC[5];

*Here, ap is an array of 5 pointers to char.*

# T A B L E 4 .

declaration: **char** (\*pa)[5];  
cast: (**char** (\*)[5]) expression  
**sizeof**: **sizeof(char** (\*)[5])  
function returning: **char** (\*f(arg-list))[5] { /\* ... \*/ }  
type synonym: **typedef char** \*PA5C[5];

*In this example, pa is a pointer to an array of 5 char.*

# T A B L E 5 .

declaration: **int** (\*pf) ();  
cast: (**int** (\*) ()) expression  
**sizeof**: **sizeof(int** (\*) ())  
function returning: **int** (\*f(arg-list)) () { /\* ... \*/ }  
type synonym: **typedef int** (\*PTFRI) ();

*Here, pf is a pointer to a function that returns an int.*

in an expression, it's treated as the address of its first element. Therefore, the expression **ary** has type array of three pointers to **ints**, and its value is a pointer to a pointer to an **int**.

On the other hand, **&ary** has type pointer to array of three pointers to **int**. This type is written as:

```
int *(*p)[3];
```

The rule for declaring a function to return a type is to replace the identifier in the above declaration with the function name and argument list as:

```
int *(*f()) [3] { /* ... */ }
```

In this puzzle, the function name is **func** and it has no arguments. Using the function prototype method of defining a function results in:

```
int *(*func(void)) [3] { /* ... */ }
```

In **main**, an automatic variable **x** is defined using:

```
int *(*x)(void) [3] = func;
```

If you remove the function argument list and the initializer, the declaration becomes simpler:

```
int *(*x)() [3]
```



By following the rules defined in Part 1, you see that **x** is a pointer to a function that returns a pointer to an array of three pointers to **int**. If you add all the redundant grouping parentheses to the declaration, you get:

```
int *((*(x()))[3])
```

When a function designator, such as a function name, is used in an expression, it's treated as the address of that function. Therefore, **x** is initialized with the address of a function

“

*When a function designator, such as a function name, is used in an expression, it's treated as the address of that function.*

”

that returns a pointer to an array of three pointers to **int**.

Next, you must solve the expression **\*1[\*x]()**. Clearly, you have a subscript operator enclosing an expression. Because **x** is a pointer to a function, **\*x** designates the function to which it's pointing, and **(\*x)()** is a call to that function. In this case, it's to function **func**.

Then, **func** returns the address of the array **ary**, and indirecting on that return value, you have an array designator. In other words, **(\*x)()** designates the array **ary**. So, you have **\*1[ary]**, a rather unusual-looking expression.

Most languages require you to write array subscripts in a particular way, with the name of the array followed by a pair of **()** or **[]** (or similar) punctuators that enclose an integral expression, representing the subscript. Although C also permits this approach, it's far more liberal.

First, the name of an array need not be present. Instead, an array designator expression, of which an array name is one example, must be present. This is possible because **[]** is an operator in C, not a punctuator, and as such, it takes operands that themselves are expressions.

Second, K&R and ANSI C specify that one of the operands of the **[]** operator must be a pointer expression and the other must be an integral expression. The integral expression doesn't have to be inside the **[]**, and in this puzzle, it's not.

To make it simpler, let's swap the operands giving **\*ary[1]**. The **[]** have higher precedence than indirection, so you subscript **ary**, resulting in a pointer to its second element, to **glob2**. If you indirect on that pointer, you get the actual value of **glob2**, 2.

So the type of the whole expression is **int** with value 2. To this, add two other integer values and display the answer

## Gone as far as your data base can take you? MDBS III<sup>®</sup> can take you further.

**Y**ou know the situation. You need to develop a system that will handle massive amounts of data and involves complex data relationships. And not only do you need it in an unreasonable time, it has to run on a PC or a mini. And on top of that, your current dbms simply can't handle the job.

### Design real world schemas.

MDBS III supports data bases into the hundreds of megabytes and beyond, yet you can still retrieve data in split-seconds.

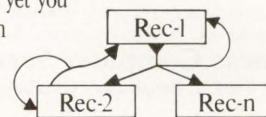

You can design a data base to represent

structures as they are in the real world, capturing many-to-many, one-to-many, many-to-one, one-to-one, forked and recursive relationships. There's no time-wasting, space-hungry dummy records or extra coding. Every time you modify your data structure, MDBS III modifies your data base automatically.

### Develop more efficient applications.

MDBS III offers high performance with flexible data-structures, airtight data integrity, automatic recovery, password, encryption and read/write protection, transaction logging, spur-of-the-moment query, report generation, easy schema restructuring, and much, much more.

From PCs to LANs to VAXs, see how far MDBS III can take you. Call 1-800/344-5832 or 317/463-2581.



P.O. Box 248  
Lafayette, IN 47902  
1-800/344-5832  
317/463-2581

### Technical specifications

- records/data base—unlimited
- fields/record—32,767
- max db size—4GB
- records/set (file)—unlimited
- fields/index—32,767
- indexes/record—2,500
- access codes—65,535
- plus performance tuning, significantly reduced storage requirements, clustering, multi user, multiple language I/Fs

MDBS III is a registered trademark of mdbs, Inc. VAX of Digital Equipment Corp.

CIRCLE 138 ON READER CARD

# Just because it costs more doesn't mean it's worth more.



We've all made that mistake. Thinking its got to be valuable. Why else would it be so expensive? And if you're like us, when you start looking closer you realize that "it ain't necessarily so."

Take a close look at Business Computer Services DOWN TO EARTH accounting system. We're less expensive than our competitors.

Yet, BCS provides fully integrated business software including:

- |                  |                     |
|------------------|---------------------|
| Accounts Payable | Accounts Receivable |
| Purchase Order   | General Ledger      |
| Inventory        | Order Entry         |
| Payroll          | Job Cost            |
| Report Writer    | Bill of Materials   |
| Sales Analysis   | Resource Scheduling |



If that wasn't enough, our packages: have standardized code to help in the maintenance of the applications. are adaptable to various working environments. have online help in addition to a user manual. operate on a variety of systems including VMS, UNIX, XENIX, MS-DOS.

The next time you go shopping remember, just because someone says its art doesn't mean it is. And just because it costs more doesn't mean its worth more.

**Business Computer Services 405-843-8631**  
6801 N. Broadway / Oklahoma City, Oklahoma 73116

CIRCLE 151 ON READER CARD

Coming Attractions  
 General Ledger account allocation. Accounts Payable duplicate invoice checking. Accounts Receivable sales tax supports four breakouts of tax rate. Inventory pricing based on cost markup. Ordering by vendor/vendor part number.

## DBL... more than just a language.

"When I chose to develop my applications in DBL, I didn't realize I was making an excellent marketing decision as well. Not only is DBL easy to learn, easy to use, and easy to maintain, but it allows me to sell my applications on almost any hardware my customer chooses... and I only need to maintain one set of sources. DBL is more than just a language... it's an important part of my business."



Merrill Likes  
Business Computer Services



Digital Information Systems Corporation  
11070 White Rock Road, Suite 210  
Rancho Cordova, California 95670  
(916) 635-7300  
FAX (916) 635-6549  
TWX 910-367-3701

CIRCLE 227 ON READER CARD

using **printf** with a mask of **%d**.

The answer, therefore, is  $2 + \text{sizeof}(\text{glob3}++) + 3$  and will vary depending on your machine. For example, under VAX/VMS the result is 7. On a PDP-11 or MS-DOS machine, the result is 9. And, for the 64-bit word Cray-2, the result is 13.

You might find the expression **sizeof(glob3++)** tricky. What is the significance of the **++** operator? The answer is none whatsoever. You see, **sizeof** is only interested in the type of its operand, and the type of **glob3++** is the same as the type of **glob3**.

**sizeof** evaluates its operand purely from the point of ascertaining what the type of the result is. It doesn't evaluate the expression, so no code is generated for the **++** operator.

The result produced by **printf** could be garbage, depending on your implementation. In any case, the call to **printf** isn't portable. The type of a **sizeof** expression is unsigned, so the second argument passed to **printf** is unsigned, and the display mask should be **%u**.

This in itself never should be a problem, because signed and unsigned **ints** always have the same size, and **sizeof(int)** never can result in a value so big that, when printed using **%d**, the sign bit will be set. However, there's a more subtle and real problem.

The type of a **sizeof** expression is implementation, defined. It can be either **unsigned int** or **unsigned long**, at the implementer's pleasure. Whatever type is chosen, it's **typedef** as **size\_t** in **stddef.h**, as well as other ANSI C headers.

Therefore, the **printf** mask could be **%u** or **%lu**. To make the call to **printf** totally portable, you need this code:

```
main()
{
    int *((*x)(void))[3] = func;
    unsigned long int ul;

    ul = *1[>(*x)()] + sizeof(glob3++) + glob3;
    printf("value = %lu\n", ul);
}
```

This works fine for the given data. However, if **glob2** had been initialized to the largest possible **int** value (**INT\_MAX** in **limits.h**) and that had been added to **glob3** first, overflow would have occurred, because **int + int** produces an **int**.

If, however, one of the **int** values were added to **sizeof**, the **int** would have been promoted to **unsigned** (or **unsigned long**) as necessary. To bulletproof the code completely, you could cast the first and/or third expression explicitly on the right side of the assignment to type **unsigned long**.

That way, you ensure that no overflow can occur. This trivial example gives you some indication of what you have to worry about if you're interested in portability.

Readers are encouraged to submit any C-related comments and suggestions to Rex Jaeschke, 2051 Swans Neck Way, Reston, VA 22091. —Rex Jaeschke is an independent consultant, author and lecturer. He is the C language editor of DEC PROFESSIONAL, and our representative on the ANSI C Standards Committee.

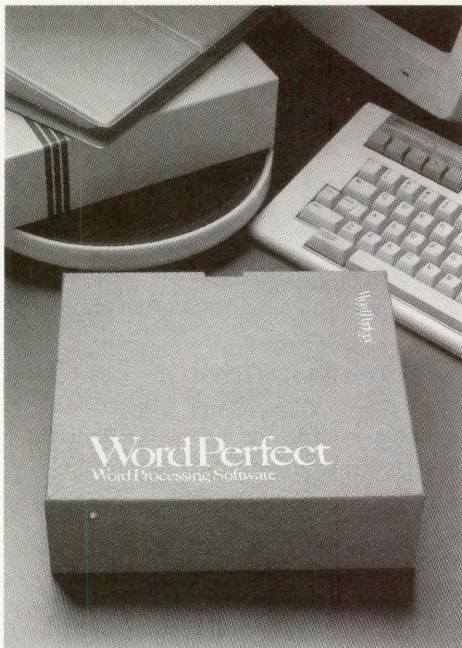

*WordPerfect documents  
easily transfer from  
PC to VAX.*

*No conversion necessary  
to transfer WordPerfect  
from Mac to VAX.*

*WordPerfect graphic codes  
are not lost  
in Mac-to-VAX transfers.*

# WordPerfect® Connectivity— The PC, Mac, and VAX.

With connectivity a prominent issue in today's organizations, more people want simplicity. They want one word processor to run on a myriad of machines—but not just any word processor. They want a powerful word processor, flexible enough to meet the needs of both the “power” user and the “occasional” user. They want WordPerfect word processing software.

WordPerfect 4.2 for the PC has virtually the same file structure and features as WordPerfect 4.2 for VAX/VMS. This advantage lets you easily access and edit documents on one computer that were created on the other. Transferring documents from the PC to the VAX requires no conversion. Documents can be transferred via ASCII. However, ASCII strips the WordPerfect codes, so we recommend you use a binary file transfer program; any will easily do the job.

WordPerfect 5.0 for the PC has a different file structure than WordPerfect 4.2. But don't worry, a 5.0 file can easily be saved in 4.2 format before transferring it to VAX.

WordPerfect 1.0 for the Macintosh is compatible with WordPerfect 4.2. Like 4.2, transferring a Macintosh file to the VAX requires no conversion. WordPerfect for Macintosh lets you save its files in 4.2

format—a simple, one-step process. Then, using a binary file transfer program such as Pacer, TCP/IP, or AlisaShare, you can transfer the document to VAX.

The remarkable thing about transferring a WordPerfect 1.0 file from the Macintosh to VAX is the ability to transfer text with graphics. Instead of stripping graphics from the document, graphic images are “blocked” or concealed. That way (even though the graphics will not show up on VAX) the document can be transferred to VAX and back again to the Macintosh without losing the graphics.

WordPerfect is presently available on a wide variety of machines: The IBM PC and compatibles; Apple IIe/IIc/IIgs; Apple Macintosh; Amiga; Atari ST; Data General; VAX/VMS; AT&T 3B2; AT&T 6386; NCR Tower; Microport UNIX; and SCO XENIX/386. WordPerfect for the IBM 370 is expected to be released before the end of 1988.

WordPerfect continues to provide the speed, ease of use, and editing flexibility necessary for document productivity. And WordPerfect provides a large selection of hardware platforms to choose from. Contact WordPerfect Corporation or your local reseller for more information.

## WordPerfect CORPORATION

1555 N. Technology Way  
Orem, UT 84057  
Telephone: (801) 227-5500  
Telex: 820618 FAX: (801) 227-5577

WordPerfect is a registered trademark of WordPerfect Corporation. All other brand and product names are trademarks or registered trademarks of their respective companies.

**Kevin G. Barkes**

# Code That Goes Bump In The Night

I suppose it was inevitable. Not long ago, someone uploaded a Trojan horse DCL command procedure to my PC-based bulletin board system (BBS), SYS\$OUTPUT. Fortunately, no damage was done, aside from a weakening of my faith in VAX-related BBS users.

I mention this because DCL command procedures frequently are overlooked as a potential source of viruses, Trojans and other software bombs. After all, it's only DCL. How could someone put something damaging in a DCL command file without it being spotted immediately?

The individual who uploaded VMMAN.COM to my board camouflaged the potentially devastating effects quite imaginatively. On the surface, the COM file appeared as if it would do a decent job of extracting information from and manipulating the contents of VMSMAIL.DAT, the mail database file on VAX/VMS version 4.x systems.

## The Culprit

Lurking within its utilitarian bowels, however, was a single line of code that I almost missed:

```
$ 'F$EDIT(A1 + A3 + A4 + DIR + WC,-
  "TRIM")'
```

The line jumped out at me as I scrolled through on the PC's monitor. Fancy stuff, I thought. The programmer had used symbol concatenation to construct a command string, the contents of which varied depending on the operation of the procedure. It was the kind of spiffy, efficient DCL that I like

to feature in this column. I decided to contact the author to see if I could include it in DCL Dialogue, provided the procedure ran properly when I tested it.

I dialed the telephone number provided and got a "no such number" recording. The street address didn't match the listing in my ZIP code directory. Obviously, this fellow was trying to pull a fast one.

First-time users on my BBS have restricted privileges. They can't upload files or enter messages in public areas until I verify them. This policy prevents immature individuals from entering offensive messages or uploading material that shouldn't reside on a public system.

This individual was so hot for me to use the procedure that he left it as a message to the SYSOP, which was certain to get my attention.

It did. I dug back into the code and made an alarming discovery. The symbols in the F\$EDIT string, which were assigned in various places throughout, were A1="D", A3="ELE", A4="TE ", DIR="SYS\$SYSTEM:" and WC="\*\*,\*".

When concatenated and used as contained within the pro-

cedure, this file issued the command:

```
$ DELETE SYS$SYSTEM:**,*
```

The offending line was preceded by code that turned off error messaging, set the process privileges to ALL and performed several other steps to make certain the person using the command file would be unaware of the damage wreaked on his system directory until it was too late. Even more insidious were the user-friendly comments contained in the code, explaining why each action was taken. Even the symbols, system killers when assembled by F\$EDIT, had real, benign purposes when used elsewhere within the file.

I didn't discover the Trojan through superb DCL skills. It was dumb luck. My interest piqued by a phony ID, I scrutinized the file more closely than usual. I don't care to imagine the consequences had I uploaded the procedure to the Professional Press VAX and asked the system manager to give it a spin.

## Safe Software

The timing of the Trojan's arrival was ironic. The day before, a letter from one of my BBS users asked whether I could assure him that the software he obtained from my board was clean. Unfortunately, no BBS SYSOP can do that. I know my board's users. They're unlike many BBS denizens in that they are professionals who use

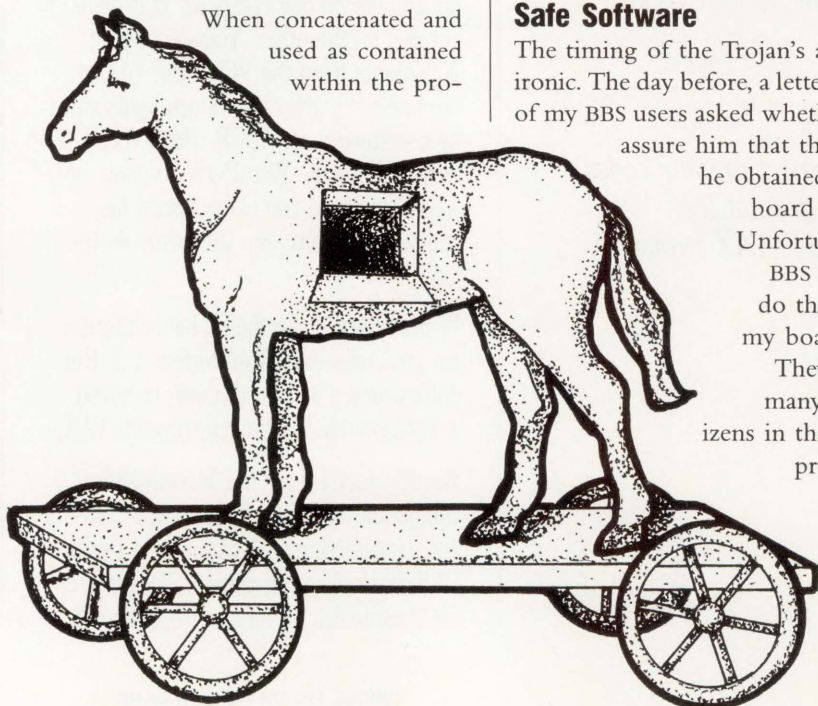

VAXs in their work. They have little interest in games and the type of files downloaded by typical BBS users. But passwords can be stolen, and even the most honest user can unknowingly pass along a virus or Trojan.

I told him that the odds of bad software residing on my board were lower than a general-purpose BBS, but that the threat was there. Thus the disclaimer on the download section. The little bundle delivered by my unknown DCL expert brought home the point.

What can you do to protect yourself?

1. Remember that most public domain and shareware software is offered on an as-is, unguaranteed basis. Stupidity kills more systems than viruses, so be cautious and read whatever documentation accompanies the program.
2. Obtain software from reliable sources only, such as DECUS, user groups and bulletin board systems you know and trust.
3. Always assume the worst, and treat a new piece of software as a potential bomb.
4. Avoid using .EXE files. Try to get the source files, and recompile and relink them. And be certain to look at the source; as our DCL example here shows, the ability to read the source doesn't mean the software is safe.
5. Test all software from accounts with no privileges. Turning off your privs does no good when the program or command file can switch them back on and inflict major damage. Be especially careful when trying a system management utility or other program that manipulates VMS security structures and that must be executed with privileges in place.

Until this experience, I was skeptical of the hysterical media reports concerning viruses. To a large degree, I still think the problem is sensationalized. But looking in the new uploads section of the BBS is more traumatic than it used to be.

—Kevin G. Barkes is an independent consultant in VAX systems software, management, tuning and training, based in Library, Pennsylvania.

## Network DEC to UNIX?

*What You Didn't Know--Will Help You!*

### TCP/IP Networking Software...

Did you know that most UNIX computers already support industry-standard TCP/IP networking protocols? And that Process Software Corporation gives you TCP/IP networking solutions for more DEC operating systems than anybody?

### For VMS, RSX, RT-11, IAS, And TSX-Plus...

Network to UNIX using just our TCP/IP software and your standard DEC Ethernet hardware on the UNIBUS, Q-bus, VAXBI, or the new MicroVAX 2000. And run concurrently with DECnet, LAT, or LAVC.

### Designed To Benefit You...

Say goodbye to special hardware, messy installation, and unneeded layers of software. Our TCP/IP products are modular, efficient, and designed for the operating system they run on. You benefit from ease of use, simple installation and virtually no maintenance.

### For Every Application...

And we support the full range of popular TCP/IP applications, including FTP (File Transfer), TELNET (Virtual Terminal), TCP, IP, and UDP programming interfaces, and others.

You won't find a better lower-cost way to connect DEC to UNIX anywhere!

*Interested?* Call Process Software Corporation today.

**PROCES SOFTWARE 413-549-6994**

35 Montague Road • PO Box 746 • Amherst, Massachusetts 01004

DEC, IAS, RSX, RT-11, UNIBUS, VAX, and VMS are Digital Equipment Corporation trademarks. Unix is an AT&T trademark. Ethernet is a Xerox Corporation trademark. TSX-Plus is a S&H Computers trademark.

CIRCLE 153 ON READER CARD

## CONNECTIVITY PROBLEMS?

Now XCOM 6.2 software solves them for you.

If you need to move files, output, or jobs between computers, and need a one-stop solution for making it all work now, XCOM 6.2 is your clear choice.

XCOM 6.2 is ready-to-use LU 6.2 software that moves files — **Hassle Free** —

between mainframes, minis, and PC's. It lets you enjoy the full power of LU 6.2 data transfer, while handling all the protocol details for you. You'll develop and maintain applications more quickly and easily, while saving on installation, training, and support.

## XCOM 6.2™

*the Connectivity Solution*

Moves data efficiently between a wide range of computers...

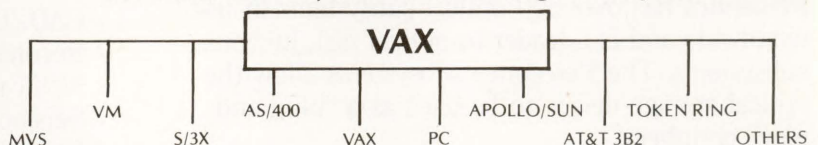

- ▶ **Peer-to-Peer.** Unattended, bi-directional file transfer.
- ▶ **Fast and Efficient.** Eliminates terminal emulation overhead and data format limitations.
- ▶ **Reduces Costs.** Eliminates costly NJE, transparently replaces RJE.
- ▶ **Re-Directs Print Output.** Access remote devices with standard print commands.

Join the leading organizations that rely on XCOM 6.2 data transfer.

Call or write now. No obligation.

**212-766-4400** Software Dept. 8110

**SPECTRUM** SPECTRUM CONCEPTS, INC.

150 Broadway Software 8110 New York, N.Y. 10038

CIRCLE 292 ON READER CARD

# OPTICAL ILLUSION

*Solution*

**It's not an illusion.** Perceptics Corporation, the leader in VAX/VMS optical storage subsystems, has the solution to your data storage needs. The Perceptics LaserSystem and LaserStar subsystems offer true magnetic disk emulation, and can give you hundreds of gigabytes of on-line storage from one subsystem.

The reality is that no one in the industry can give you a more proven product with these features and this much storage capacity. Perceptics has over 500 optical subsystems in use worldwide and is a leader in optical disk jukebox subsystems. The Perceptics subsystems allow the optical storage device to be used as a "plug and play" peripheral.

**LaserSystem** is a complete, integrated, ready-to-use optical disk subsystem, including write-once read-many (WORM) optical disk drive, SCSI host adapter and industry standard LaserWare optical disk software. Media, installation, and on-site maintenance services are also available.

LaserSystem stores up to 2.4 gigabytes of data on a removable cartridge and features true magnetic disk drive emulation, so existing software and

applications require no modification to access the massive storage capacity of optical disks.

**LaserStar** extends the emulation features of LaserSystem to the optical disk jukebox, allowing on-line access of up to 338 gigabytes of data, using the same VAX/VMS transparent file system as LaserSystem.

Applications include:

- CAD/CAM Storage and Retrieval
- Records Management
- Medical Imaging
- Seismological Data Storage
- Large On-Line Database
- Satellite Image Storage

**perceptics**

725 Pellissippi Parkway  
Knoxville, TN 37922  
615/966-9200  
FAX 615/966-9330

LaserStar, LaserSystem and LaserWare are trademarks of Perceptics Corporation.  
VAX, VMS and MicroVAX are trademarks of Digital Equipment Corporation.

# from the lab

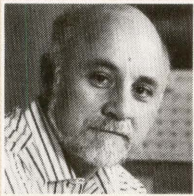

**Dave Mallery**

## *Cluster Chronicles: DECNET*

*Editor's note: The credit for this technique is attributed to West Coast Editor Philip A. Naecker and MIS Manager John F. McGlinchey in Spring House, Pennsylvania.*

We linked our Ethernet to our Pasadena, California, office a few months ago using Xyplex gateways and terminal servers. A flaw was that the gateways were low-end (affordable) and only dealt with Xyplex traffic. The problem was getting DECNET to work from the MICROVAX in Pasadena over this link. The answer was asynchronous DECNET.

We linked our Ethernet to our Pasadena, California, office a few months ago using Xyplex gateways and terminal servers. A flaw was that the gateways were low-end (affordable) and only dealt with Xyplex traffic. The problem was getting DECNET to work from the MICROVAX in Pasadena over this link. The answer was asynchronous DECNET.

We linked a DHU port on FRODO:: (Spring House routing MICROVAX II node) with a Xyplex terminal port at our Spring House, Pennsylvania, office and a serial port in Pasadena into the local cluster controller. The connection was fine, but DECNET would have none of it. We thought there were too many links and too much hardware. DECNET didn't give us many meaningful error messages. It just refused to work.

Finally, we found the solution: Disable the Xyplex flow control, but leave the normal DHU port flow control enabled. This gave us DECNET over a link that doesn't pass DECNET

packets. Now I can send VAXMAIL directly to Phil Naecker in Pasadena without worrying about where he is. Because we only do VAXMAIL and late-night file transfer, the inefficiencies of the circuit are irrelevant.

### **Exabyte Tapes**

When we reviewed the Exabyte drive setup from MTI ("MTI's Exabyte," August 1988), we said that you could run 8mm video cartridges of reasonable quality. However, they work for only about as long as it takes to write a review. So, if you're experiencing problems with your Exabyte, the problem probably lies in the media, not in the drive.

The bad news is that MTI is buying premium cartridges from Sony and private labeling them. So there goes one of the big economies of the deal. By the time the cartridge is two-

stepped to you, it has been marked up to \$20 or \$30. That's still a lot cheaper than 12 to 15 reels of 6250 tape but a lot more expensive than \$10. We'll look for alternatives and welcome anything you've found. Word on the street has it that there soon will be longer reels that yield even greater capacity per cassette.

### **Cluster Compute Server**

We have three VAXSTATION 2000s in our cluster. Two belong to programmers and

## **C**ONTENTS

125 **Cluster Chronicles: DECNET**

128 **Emulex Performance 4000 Ethernet Terminal Server**

130 **Microsystems Engineering's MASS-11 Graphics Processor**

140 **Esprit Systems' Opus 3n1 Video Display Terminal**

146 **Software Techniques' ARCHIVE 2000**

154 **Innovative Computer Systems' FCX File Compression Program**

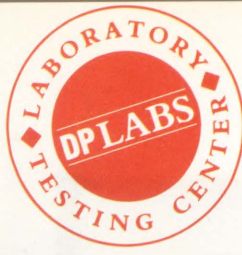

## Companies Mentioned In This Article

Digital Equipment Corp.  
146 Main St.  
Maynard, MA 01754  
(617) 897-5111  
CIRCLE 400 ON READER CARD

EEC Systems Inc.  
327 Boston Post Rd.  
Sudbury, MA 01776  
(617) 443-5106  
CIRCLE 443 ON READER CARD

EMC Corporation  
171 South St.  
Hopkinton, MA 01748-9103  
(617) 435-1000  
CIRCLE 447 ON READER CARD

EXSYS Storage Systems Inc.  
1340 Tully Rd. Ste. 301  
San Jose, CA 95122  
(408) 292-0343  
CIRCLE 565 ON READER CARD

MAXTOR Corp.  
211 River Oaks Pkwy.  
San Jose, CA 95134  
(408) 432-1700  
CIRCLE 444 ON READER CARD

Micro Technology Inc. (MTI)  
1620 Miraloma Ave.  
Placentia, CA 92670  
(714) 632-7580  
CIRCLE 438 ON READER CARD

Seagate Technology  
920 Disc Dr.  
Scotts Valley, CA 95066  
(408) 438-6550  
CIRCLE 445 ON READER CARD

Sony Corp. Of America  
Sony Dr.  
Park Ridge, NJ 07656  
(201) 930-6585  
CIRCLE 487 ON READER CARD

Xyplex Inc.  
100 Domino Dr.  
Concord, MA 01742  
(617) 371-1400  
CIRCLE 446 ON READER CARD

one belongs to the Editorial Department. We run two batch queues in the Editorial box 24 hours a day, except when we need it for a review.

This compute server does a wonderful job of offloading the two interactive nodes, FRODO:: and THORIN::. Because all the I/O has to go over the Ethernet anyway (we are averaging 14 percent cable use), the CPU cycles might as well be contributed by a VAXSTATION. An extension of this would be to create an evening and night generic batch queue that feeds queues on all three VAXSTATIONS to further speed the process.

### Tuning BILBO::

BILBO::, our venerable 750, has retired from the interactive world and is devoting his efforts to MSCP serving. To help him do this single-mindedly, we changed a few of his SYSGEN parameters. Specifically, we changed his QUANTUM. This is the amount of time he can concentrate on a single task (pending the arrival of an interrupt) without giving up control to the scheduler.

When we changed his QUANTUM to 20,000 ms, the CPU time decreased from a constant 100 percent to 60 percent and the throughput on the cluster increased. Thus, we gave him time to finish what he was doing before he gave up to the scheduler, rather than needlessly being rescheduled 10 to 15 times in the same interval.

Here's a fascinating insight. When we were looking for something to tune on BILBO:: after the QUANTUM change, we noticed that even though he's doing most of the file serving for the cluster, the serving program doesn't use any of

the RMS queues. Apparently, the serving proceeds at the physical (or MSCP) disk block level and skips all the higher-level niceties.

This leaves about 10 MB unused. One suggestion was to use EEC Systems' Turbo Disk, but we don't have any files of that size that really need speed. Because BILBO::'s second mission in life is to be a backup via dual porting to THORIN:: (our 8250), his extra memory will sit in reserve for when he's pressed back into interactive service.

### Arrivals

We installed a 1.2-GB disk subsystem from MTI on THORIN::. The drive works splendidly and will be reviewed soon. The system consists of a pair of MAXTOR 700-MB drives (ESDI interface) with their servos synchronized so that they act as a single spindle and support RPS and seek ordering, connected to our KDB50 via the EXSYS Storage Systems interface card.

We also installed 24 MB of BI memory from EMC. The subsystem consists of two boards: a controller with a "lifted" BI chip and no memory, and the densest board I believe I've ever seen, with six 4-MB columns composed of 1-Mbit zip-mount chips. The board went in with a minimum of commotion in about a half hour and is functioning perfectly.

Finally, we installed a Seagate ST251 in a VAXSTATION. It works after you get the right setting on the device ID jumper on the back (see photos).

The beauty of this is that it costs about \$350 to \$400. The DECIRECT price for an RD32 is \$1,615, plus \$375 to have it installed. If you only use the ST251 for swap and page files, and never put any data on it, you never have to maintain it or back it up. Discard it if it breaks and install another.





1: Top cover off — CPU is in the top layer. Don't forget static protection.



2: There is a resistive load card to remove. This uses up the power if there are no drives present. It's not necessary to remove the card, just unplug one of the power cables for your new drive.

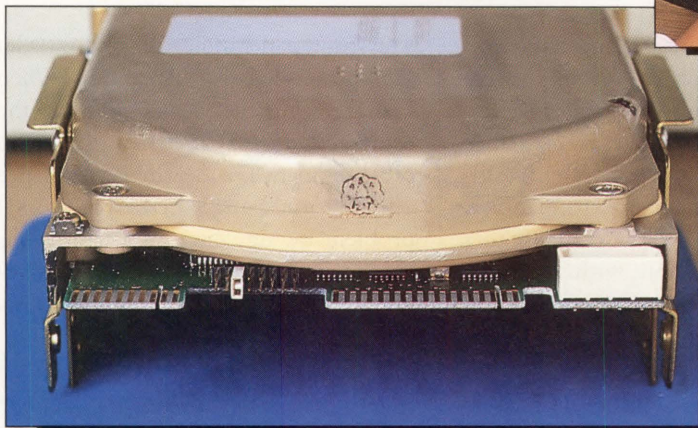

3: Looking at the back of the ST251 drive, there's a header with a single jumper. Put the jumper on the third pair from the left.

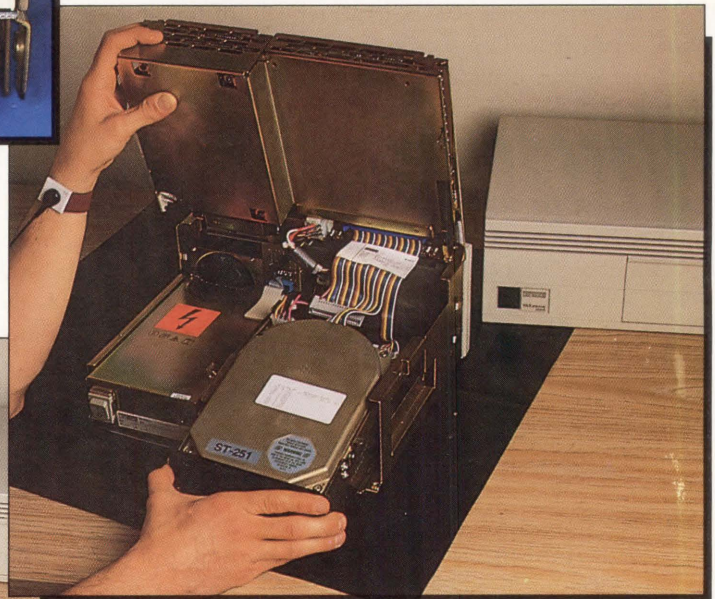

4: DEC provides the cable for the drive with each diskless unit. The 50-pin end mates with an exposed connector on the CPU board.



5: Time to button up. You format the disk by typing T70 to the >>> prompt. You can use T71 as a non-destructive verify after formatting.

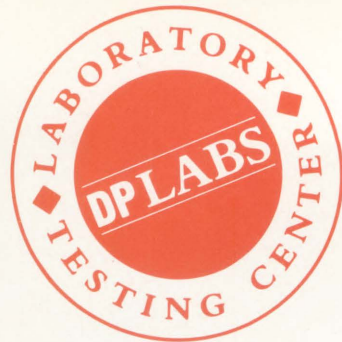

# from the lab

## Emulex Performance 4000

**David W. Bynon**

Without a doubt, DECSERVER is one of DEC's outstanding achievements of the decade. It melds the flexibility of a terminal switch with the high performance and connectivity of Ethernet.

You pay dearly for these features, however. The average port cost on a DECSERVER is \$290 for a DECSERVER 500 with 128 ports to \$475 for a DECSERVER 200.

Since DEC's introduction of the first LAT-based terminal server, DECSA, there's been no competition. Until now.

The Performance 4000 Ethernet terminal server from Emulex Corporation of Costa Mesa, California, is directly compatible with the DECSERVER 200, DEC's most successful terminal server. It can be used with both Ethernet Version 2.0 (the DEC, Xerox, Intel specification) and IEEE 802.3.

Emulex designed the Performance 4000 around the Ethernet Local Transport (ELT) protocol, which makes it compatible with all popular DEC computers and operating systems. The Performance 4000 is supported by VAX/VMS, RSX-11M-Plus and ULTRIX-32. Our Lab was conducted under VAX/VMS version 4.7.

The Performance 4000 is designed to connect asynchronous terminals to DEC computers and others. Because it can load itself, it supports any computer or terminal device that conforms to the



*Emulex Corporation's Performance 4000 is compatible with DEC computers and operating systems.*

RS-232 asynchronous wiring standard.

If you're looking for impressive features in an Ethernet terminal server, you'll be pleased by the Performance 4000's standard list.

Topping that list is expandability. The Performance 4000 is available as a 12- or 16-line base unit, with variations of full and partial modem control and an optional expansion unit. A fully loaded Performance 4000 has 32 terminal ports and one parallel printer port, configurable as either Centronics or Data-products. Further, the product is compact. The base and expansion unit together are approximately two-thirds the size of a DECSERVER 200.

Other standard features include power-up diagnostics (an LCD on the front provides status information), a multilevel help program, complete port statistics, automatic failover (to an alternate CPU), load balancing between available hosts, multiple sessions, command line recall, host-initiated connections (for remote print or modem support), typeahead and remote console port.

During the last three years, I've installed dozens of DECSERVERs. The Performance 4000 installation was the smoothest I've ever experienced. The diagnostic display made the difference.

The front-panel indicators and LCD let me know what was happening. When I shorted the RG58 shielding to the center conductor of a new ThinWire cable segment I made, the Performance 4000 let me know there was a LAN problem by signaling an alarm. I was able to find the problem without having to break out the TDR or a LAN analyzer.

The Performance 4000 installs as if it were a DECSERVER device. The terminal server first must be connected to an Ethernet (ThickWire or ThinWire), software must be loaded and the host computer's server and DECNET software must be configured. The Lab installation took 45 minutes from unpacking to first log in.

There are two minor differences in the software installation of DECSERVER and the Performance 4000. They are the definition of MOM\$LOAD and the name of the configuration procedure, P4KCONFIG. These prevent you from confusing the DEC software with the Emulex. The MOM\$LOAD logical name is redefined to point to both the DECSERVER directory and Performance 4000 directory. If you use both DECSERVERs and Performance 4000s,

# What's the difference between a backup and an archive?

System Backups. They're time-consuming and painstaking, but backups guard against the dreaded disk-head crash. But even if you have a file backed up, getting it back—finding it on dozens of backup tapes—costs your company time and money. And sometimes the file is no longer there.

## **The difference is organization.**

An archiving system, on the other hand, automatically transfers files from disk to tape or optical disk. It gives you more disk space. It organizes the data you need to keep for easy and instant access. An archiving system catalogs off-line information.

## **The difference is security.**

With file protection to prevent accidental reads, and checks to prevent data being written over, you'll know your data is safe. In addition, there's no danger, as with backup tapes, that someone may restore sensitive information. Plus, there's no chance

the wrong tape may be mounted and last quarter's accounting records destroyed.

## **The difference is ARCHIVE 2000.**

Until now, the only way to store information was to save backup tapes—for six months or ten years. Now ARCHIVE 2000 gives you a better way. Whether your business is chemicals or construction, agriculture or accounting, ARCHIVE 2000 saves you money, because you keep only the information you need on low-cost media.

Now, the difference between a backup and an archive is ARCHIVE 2000. The most advanced archiving system for VAX/VMS systems. Call today for more information on how ARCHIVE 2000 can make a big difference in helping you handle your data storage problems.

The logo for UIS (University Information Systems) features the lowercase letters 'uis' in a bold, sans-serif font. A diagonal line starts from the top right of the 'i' and extends across the 's'.

**The Source For  
VAX Management Software**

VAX and VMS are trademarks of Digital Equipment Corporation.

UIS, 6600 Katella Avenue, Cypress, CA 90630, Phone 714-895-1633, FAX 714-895-6146, Telex 701331

**CIRCLE 269 ON READER CARD**

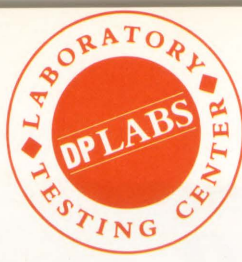

you can use the DEC or Emulex server configuration programs to configure either brand of terminal server.

Performance 4000 configuration commands were 100 percent DEC-SERVER 200 compatible, with one exception: Emulex added two commands called CHANGE PORT and CHANGE SERVER. CHANGE commands are identical to the SET and DEFINE variations, but the port or server options are changed immediately and permanently.

Emulex made the Performance 4000 compatible and easy to use, but didn't provide a choice of connection methods. The connection is standard IEEE 802.3. If you want to connect the Performance 4000 to a ThinWire Ethernet you must use a DESTA or its equivalent.

## Performance 4000

**PLATFORMS:** VMS 4.5 or later, Ethernet, DECNET and LAT. Includes support for RSX 11-M-Plus V3.0 and ULTRIX-32

**PRICE:** Ranges from \$2,185 for a 16-line expansion unit that has 16 lines with partial modem control; to \$5,590 for a 16-line unit that has 12 lines with partial and four lines with full modem control

## EMULEX CORPORATION

**HEADQUARTERS:**

3545 Harbor Blvd.  
P.O. Box 6725  
Costa Mesa, CA 92626  
(714) 662-5600

**FOUNDED:** 1979

**PRODUCT LINE:** Data storage and data communications products for DEC and IBM PC marketplaces, and for use with other SCSI and VME-based computers

**REVENUES:** \$120 million

**OWNERSHIP:** Public (NASDAQ: EMLX)

**BRANCHES:** 15 U.S., six international

CIRCLE 403 ON READER CARD

I discovered that a DESTA can be connected directly to the terminal server. Use a small screwdriver to latch the slide clip. If you're worried about the strain on the connector, use tie straps if you're rack mounting or half-inch rubber feet if it's going on a tabletop. This way, you can forgo the use of expensive and bulky transceiver cables.

### Applications

Ethernet terminal servers aren't short on applications. Just use your imagination and you'll be amazed at what you can do. The Performance 4000 hardware offers two applications unheard of on the DEC terminal servers.

First is the ability to connect a wide variety of host computers, personal computers and peripheral devices without using a DECNET host. By using the Emulex Self Load Performance-Pak, no software downloading from a DECNET host is required.

Second is the parallel printer port. This hardware feature allows you to connect any Centronics- or Dataproducts-compatible printer to the server for shared use. I tested this feature by unplugging the printer from our Lab PC AT and then plugging it into the server printer port. The connector is the same female DB-25 used on all PC XT and PC AT systems. To use the printer from one of the VAX systems, I simply established a service, port and queue, as you would for a serial printer on a DECSERVER.

THE PERFORMANCE was very good. I did notice one anomaly, however. There's little, if any, perceptible difference between a terminal set to 9,600 bps and one set to 19,200 bps. But on a direct connection (e.g., DHV11, DZV11) there's a big difference. Port speeds of 75 to 38,400 bps are supported by the Performance 4000, with the default being 9,600 bps.

The Performance 4000 from Emulex is packed with features, it performs well, and the price is right.

# Microsystems Engineering's MASS-11 Graphics Processor

**David B. Miller** Today, viable word processing software must be able to integrate graphics with text. Because they can come from various sources and exist in various formats, pulling together graphics and text into a single document presents a challenge. If you generate a Lotus .PIC file on a PC, draw a diagram with MASS-11 Draw or MacDraw and write the text with MASS-11 on a VAX, how can you elegantly integrate them into one document?

The MASS-11 Graphics Processor (MASS-11 GP) from Microsystems Engineering Corporation of Hoffman Estates, Illinois, enables you to display and print graphics files only or to integrate them into MASS-11 documents. Images can be clipped, rotated and scaled to desired dimensions before printing.

MASS-11 GP can be run either independently or from MASS-11 word processing. To integrate files into MASS-11 documents, you must have MASS-11 word processing version 7A-04 or higher. We tested version 5.0 of the Graphics Processor on our VAX-CLUSTER.

Installation is easy. The program consists of only one executable image, GRAFPROC.EXE. The image should be restored to your MASS-11 word process-

# XEROX

## The best way for VARs to add value: Add Xerox.



**The Xerox 19-inch large format monitor.**

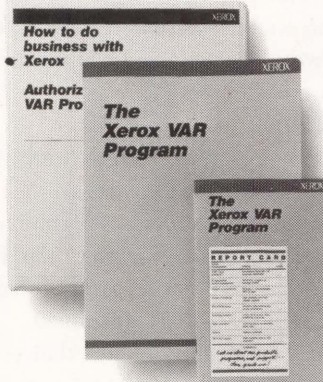

**A comprehensive sales literature program.**

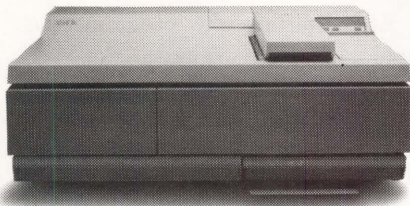

**The Xerox 4045 model 50 laser printer/copier.**



**A strong field sales support team.**

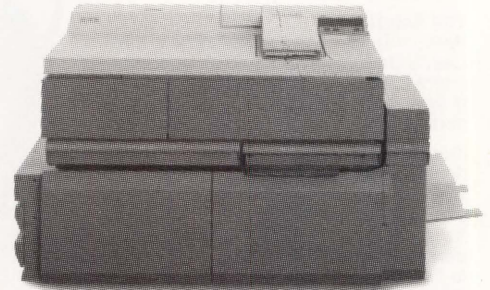

**The Xerox 4045 model 150 laser printer/copier.**

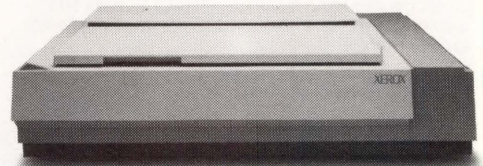

**The Xerox 7650 Pro Imager scanner.**

**The Xerox 3700 electronic printing system.**



**Support when you develop demonstration disks, go to shows, advertise, and more.**



When it comes to building your business, the Xerox VAR program can help you add more value than anybody else.

It starts with our products: laser printers, scanners, monitors, and software. They help you give your clients the best possible solutions, whether you're selling into main-frame, mini, or micro environments.

But the real key is superb support. We back you up with product and sales training. With co-op advertising and promotions, and field sales support. We even help with trade shows, sales literature, and direct marketing.

We also help with inventory financing, drop-ship programs, and referrals. And since we're Xerox,

you can count on our help for a long time.

To learn more, call 1-800-222-XVAR or visit us at COMDEX, booth #1828. We'll show you the best way to add value to your products. And to your business plan.

**Team Xerox  
We document the world.**

# Data Management With a Fresh Twist.

## The Situation:

As one of the fastest growing beverage distributors in the West, (the largest in the Rocky Mountain region), Western-Davis end-users needed a powerful yet easy to use report writer to accurately and almost effortlessly track their changing business patterns.

## The Solution:

Western-Davis purchased a license to the User's Data Management System, from Interactive Software. UDMS is a series of advanced window-based modules for reporting, querying, exporting and updating.

## The Results:

According to Dave Santistevan, Manager of Systems and Programming, "UDMS was installed easily and has become an invaluable tool for both our end-users and data processing personnel. In our evaluation, we were surprised to find a truly easy-to-use product like UDMS, that also satisfied even our most sophisticated data management and reporting needs."

UDMS supports a wide variety of file access protocols including INGRES, ORACLE, Rdb, RMS, System 1032 and VAX-DBMS for the VAX/VMS environment.

For a FREE Tele-Demonstration of UDMS  
Call Toll-Free 1-800-962-UDMS or 303-987-1001

**INTERACTIVE SOFTWARE**

7175 West Jefferson Avenue, Denver, Colorado 80235

INGRES is a trademark of Relational Technology Inc. ORACLE is a registered trademark of Oracle Corporation. Rdb, RMS, VAX-DBMS, and VAX/VMS are trademarks of Digital Equipment Corporation. System 1032 is a registered trademark of CompuGene Data Technologies. UDMS is a trademark of Interactive Software Systems Inc.



ing directory if you want to run it from there. Sample graphics files are supplied with the distribution and can be optionally restored.

The program recognizes nine logicals, GP1 through GP9, which you can assign to print queues on your system. These designations tell MASS-11 GP where to send print requests. A reserved logical, GP0, is used to direct output to your terminal or workstation rather than to a print queue.

If you are printing on a Hewlett-Packard LaserJet, you need to establish one logical, as outlined in the installation documentation, and to check printer characteristics. For Hewlett-Packard plotters, a command file is included to establish hardware handshaking between the VAX and the plotter.

## Two Steps

Integrating graphics into MASS-11 documents involves two steps.

The first step processes a graphics file and generates a file that can be printed on its own or that can be incorporated into a MASS-11 document.

The second step requires that you embed a command in the MASS-11 document that will receive the graphic image.

After starting the program, the Graphics Input menu appears. You enter the graphics file name to process, optionally followed by a qualifier telling MASS-11 GP what type of graphics file it is.

The qualifiers /DRW, /HP, /HPM, /PIC, /PCT, /MDL and /TEK denote MASS-11 Draw, Hewlett-Packard HPGL, Hewlett-Packard Multi-Pen, Lotus PIC, Macintosh PICT, Molecular Design Limited metafile and Tektronix files, respectively. These qualifiers aren't required if the extensions, such as .DRW, .HP, .PIC, are already part of the file's name.

After entering the file's name, you have the option of creating a MASS-11

**PowerStation**



## If you have PCs and VAXes, you NEED these products!

For connecting your PC to a VAX, the PowerStation provides the ultimate solution: a VT200 layout keyboard bundled with sophisticated ZSTEM terminal emulation software.

ZSTEM software includes DEC VT240, VT220, VT100, IBM 3101, TEK 4014 and DG D400 terminal emulation.

"Its performance is as perfect as an emulator can get . . ."

DIGITAL NEWS

For *true* terminal emulation call (800) 663-8702.

**KEA Systems Ltd.**

#412-2150 West Broadway

Vancouver, B.C. CANADA, V6K 4L9

Tel: 604-732-7411 Telex: 04-352848 VCR

FAX: 604-732-0715

SEE US AT  
COMDEX



CIRCLE 132 ON READER CARD

NOVEMBER 1988

# Measured Against Masterpiece, All Other Financial Software Comes Up Short.

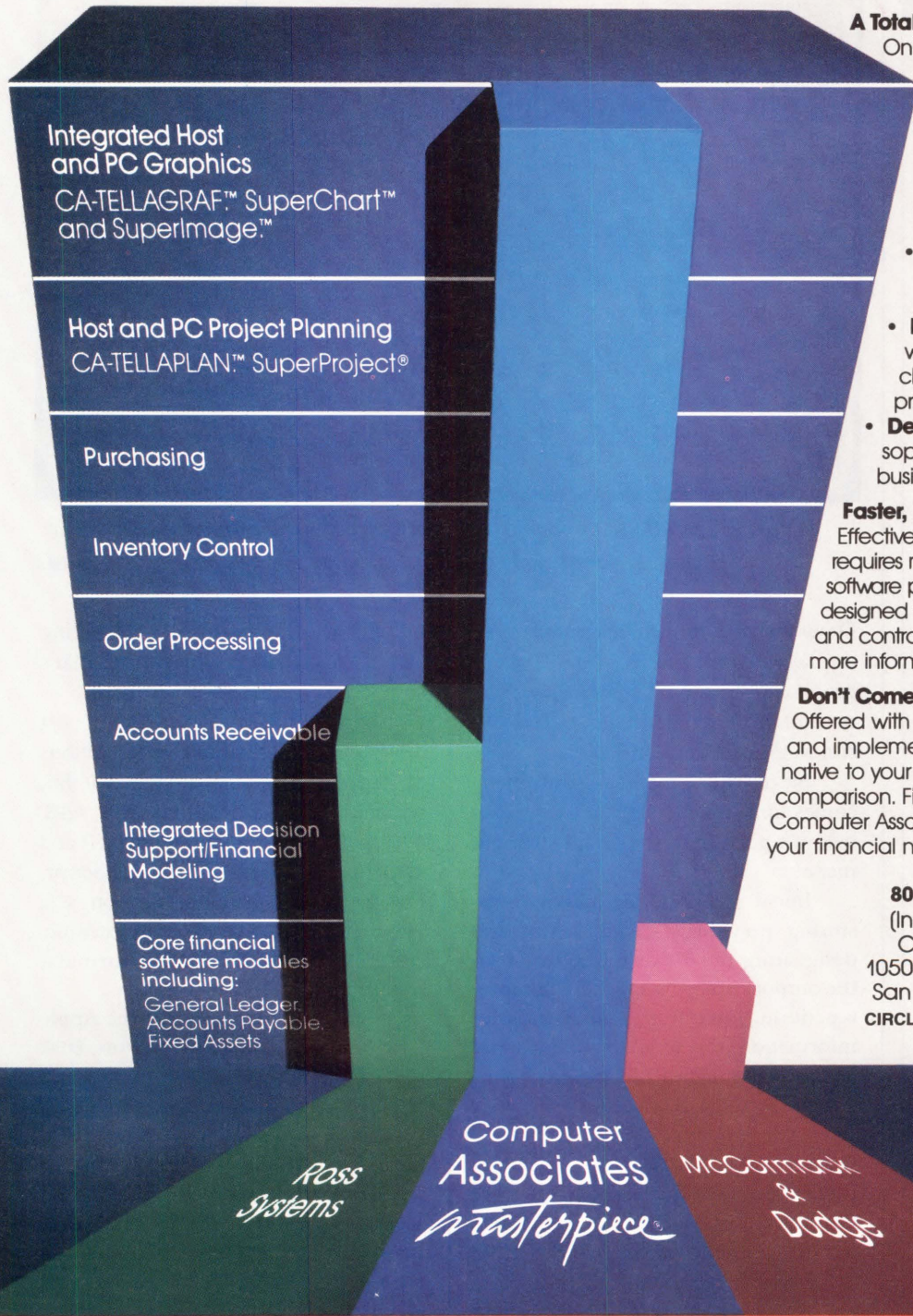

## A Total Financial System.

Only Computer Associates' Masterpiece® offers a complete financial software system, with add-on capabilities beyond the reach of any competitor:

- **Graphics** that generate persuasive, executive-quality presentations and reports.
- **Host and PC Project Management** to provide versatile and advanced project management.
- **Distribution Management System** with fully integrated, realtime purchasing, inventory control and order processing.
- **Decision Support System** for more sophisticated financial analysis and business decision making.

## Faster, More Informed Decision Making.

Effective corporate financial management requires more than just the basic accounting software products. Masterpiece's total solution is designed to improve your ability to manage and control your financial information for faster, more informed decision making.

## Don't Come Up Short—Evaluate Masterpiece!

Offered with an unmatched on-site installation and implementation program, Masterpiece is native to your Digital VAX. We invite your comparison. Find out how Masterpiece and Computer Associates offer the best solution for all your financial needs. Call Chris Andrews today:

**800-841-3734 (Ext. 1911)**

(In Calif. 800-468-0725)

Computer Associates  
10505 Sorrento Valley Road  
San Diego, CA 92121-1698

**CIRCLE 352 ON READER CARD**

**COMPUTER ASSOCIATES™**  
Software superior by design.

- World's leading independent software company.
- Broad range of integrated business and data processing software for mainframe, mid-range and micro computers.
- Worldwide service and support network of more than 70 offices.

Resource & Operations Management • RDBMS • Financial • Banking • Graphics • Spreadsheets • Project Management

# INTRODUCING more Best Sellers!

## DATA PRODUCTS

M9030	300 CPS	
B600	600 LPM	\$5,800
B1000	1000 LPM	\$9,200
BP1500	1500 LPM	\$17,500
LZR1230	12 PG/MIN	\$2,395

## EMULEX

UD33	DISK CONT. (UNIBUS)
QD33	DISK CONT. (Q-BUS)
QT14	MICROVAX 3500, 3600, TAPE CONT.
EMS/380	SUBSYSTEM \$3,300
EMS/180	SUBSYSTEM \$2,600

## CONTROL DATA CORPORATION

9720-850	(NEW) 800 MEG 8" \$5,700
9720-1.2G	(NEW) 1.2GIG 8" \$8,750
9720-850	(REFUR) 800 MEG 8" \$4,975
9720-1.2G	(REFUR) 1.2GIG 8" \$7,295

## MAXTOR

RD54	COMPATIBLE 5¼"
XT-4380E	380 MEG. 5¼"

## HOW TO ORDER

To place your order, just call toll free 800-346-2933. In Pennsylvania call 412-745-0200.

TriLogic's sales representatives are available to assist you from 8:00 AM until 5:00 PM

FAX # 412-745-5950

# TriLogic

R.D.#2 • BOX 203A • OLD ROUTE 519  
CANONSBURG, PA 15317

## TOLL FREE 800-346-2933

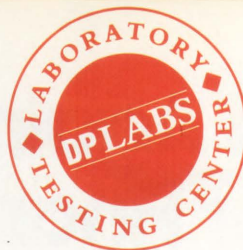

[GRAPHICS PROCESSOR] V5.0, Copyright (c) 1988 Microsystems Engineering Corp.

Graphic File Name (bargraph.pic)

Approximate Image Dimensions (Horizontal, Vertical): 6.521, 4.982

Copy Stored Menu Entry (0 - Previous Menu Entry, 1..9 - Stored Entry) ( )

P.S. File/Printer (GRAPH123/EPS)

Specify Amount To Trim From Original Image

Inches To Trim From TOP Of Original (0.125 )

Inches To Trim From LEFT Of Original (0.46875 )

Specify Portion Of Original Image To Be Included

Inches DOWN From Trimmed Top Of Original (1.875 )

Inches ACROSS From Trimmed Left Of Original (2.75 )

Image Scale (Greater Than 1.0 To Enlarge, Less To Reduce) (1.5 )

Image To Be Rotated FROM Portrait To Landscape (Y To Rotate) ( )

Number Of Copies To Print (1-99) ( )

Will This Image Be Integrated Into A MASS-11 Document (Y or N)? (N)

[PF2] - Print, [PF4] - Cancel, Store Current Menu Entry And Print (1..9) ( )

*Screen 1: The MASS-11 Graphics Processor's easy-to-use menu system provides for cutting, scaling and rotation of the graphics image being processed.*

Draw metafile. It must be created to use the DR= command in MASS-11 word processing version 8.0. It also allows you to transfer Draw files to your PC if you run MASS-11 Draw on it.

Next, the Graphics Print menu comes up. Screen 1 shows it displayed below a portion of the Graphics Input menu.

Initial menu entries deal with restoring previously saved menus and designating the file or queue to which the output request will go. To eliminate repetition, you can save and recall print information for nine menus. Simply enter the number of the menu containing the settings you need.

OUTPUT OPTIONS INCLUDE generating files in various formats, sending output directly to a printer and displaying output on a graphics-capable workstation.

Specifying only a file name for output produces a PostScript file by default. To create files of different formats, you append a qualifier in the form /xxx, where xxx represents a format type, to

the file name. For instance, entering FILEONE/LJ1 will produce a file that's compatible with LaserJet printers.

The qualifiers LJ1 through LJ4 designate LaserJet format for resolutions of 75 dpi, 100 dpi, 150 dpi and 300 dpi, respectively. The qualifiers /APS, /EPS, /FX1 to /FX4, /HPP, /LIN, /LN1 to /LN4 and /QA1 to /QA4 create files in PostScript, Encapsulated PostScript, Epson FX, Hewlett-Packard HPGL, Linotronic, DEC LN03 and QMS formats, respectively.

Printer support includes the Apple LaserWriter and LaserWriter Plus, DEC LN03 and LN03 Plus, Epson FX-80 and 100 percent compatibles, Hewlett-Packard and 100 percent compatible plotters, the HP LaserJet and LaserJet + and compatibles, Linotronic 100 and 300, QMS LASERGRAFIX 800 and 1200, QMS SmartWriter, QMS PS800 and PS800 Plus as well as the Talaris 800, 810, 820 and 1200.

ReGIS-capable terminals can



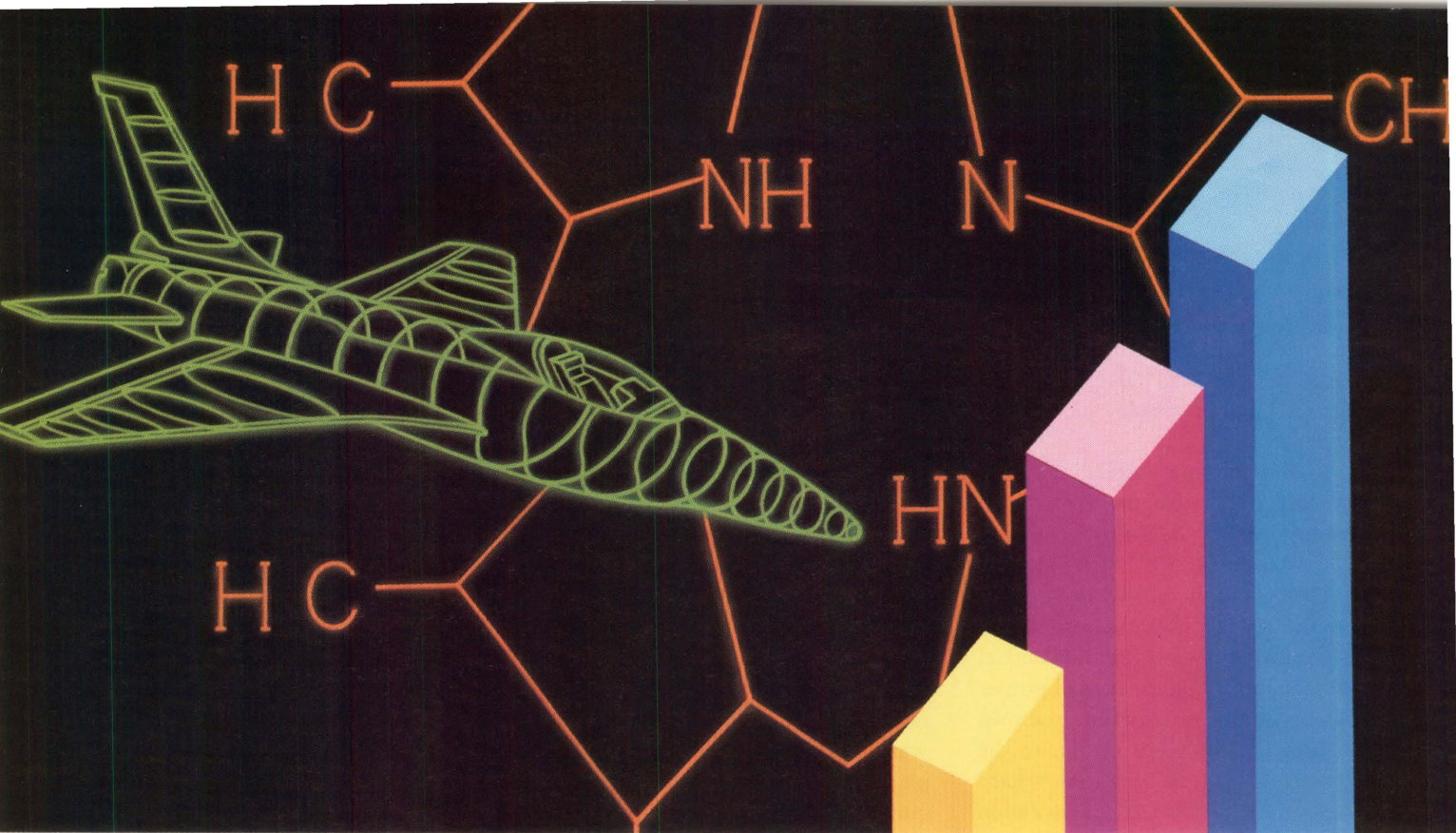

# MASS documents without mass confusion.

Imagine thousands of scientists, engineers and financial analysts, using a wide variety of software graphics packages to prepare one professional-looking composite document in a compressed period of time.

Sound like a formula for mass confusion? Not with MASS-11® GP, the most powerful VAX Graphics Processor.

MASS-11 GP lets VAX users input graphics files from all of the popular graphics formats — HPGL, Tektronix, Macintosh PICT, Lotus PIC, MDL, CGM, DXF\*, IGES\*, MASS-11 Draw and more.

Those graphics can be viewed on DEC Regis terminals and scaled, rotated, and trimmed. Then those graphics can go to work.

They can be integrated directly with text in a MASS-11 WP document. Or they can be sent to MASS-11 Draw, a technical illustrator which runs on the IBM PC or DEC VAXStation, for more extensive editing.

MASS-11 GP files can be printed out directly on a wide variety of laser printers, including PostScript, HP Laserjet, QMS Smartwriter, Talaris (QUIC), DEC LN03+ and others.

Or they can be printed out on the HP plotters, including the 7440, 7470, 7475A, 7580 and 7586.

Graphics can also be sent out to page makeup systems in Encapsulated Postscript format or HPGL. For professional quality results, they can be printed out to a phototypesetter like the Linotronic 300.

MASS-11 GP unites in harmony the hardware, software and printers you already have. To produce the illustrated documents your company will be proud of.

That's why more and more Fortune 500 companies are moving to MASS-11 for group publishing, creativity and productivity. To join them, call **(312) 882-0111** today.

Microsystems Engineering Corporation,  
2400 W. Hassell Road, Hoffman Estates, IL 60195

## MASS-11 Pulls It All Together

If you're a typical MASS-11 customer, your computer has a large number of VAX software packages, including IBM PC, dBase, and dBaseCommand. One of your responsibilities is to create graphics that will be included in your company's MASS-11 documents. If you're a VAX user, you'll need a VAX-based graphics processor to do the job.

MASS-11 GP is the VAX-based graphics processor you need. It lets you input graphics files from all of the popular graphics formats — HPGL, Tektronix, Macintosh PICT, Lotus PIC, MDL, CGM, DXF\*, IGES\*, MASS-11 Draw and more.

Those graphics can be viewed on DEC Regis terminals and scaled, rotated, and trimmed. Then those graphics can go to work. They can be integrated directly with text in a MASS-11 WP document. Or they can be sent to MASS-11 Draw, a technical illustrator which runs on the IBM PC or DEC VAXStation, for more extensive editing.

MASS-11 GP files can be printed out directly on a wide variety of laser printers, including PostScript, HP Laserjet, QMS Smartwriter, Talaris (QUIC), DEC LN03+ and others.

Or they can be printed out on the HP plotters, including the 7440, 7470, 7475A, 7580 and 7586.

MASS-11 GP is priced at \$2000 for the MicroVAX 2000, \$1800 for the MicroVAX 10, \$1700 for the MicroVAX 100, and \$1700 for the VAX 1000-400.

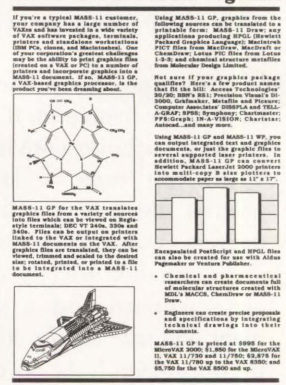

\*MASS-11 is a registered trademark of Microsystems Engineering Corporation.

**MEC**  
AMERICA IS MOVING TO MASS.

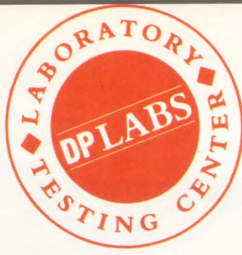

display MASS-11 GP output. VT100/200/300 and other text terminals also are supported, although you must print output to see it. VAXSTATION users can generate graphic displays on their screens.

To view files on a ReGIS terminal or VAXSTATION, use the GP0 queue name followed by /RGS for ReGIS output or /VXS for VAXSTATION output.

To send output directly to a printer, enter the desired queue name, GP1 to GP9, followed by one of the output qualifiers, specifying the type of printer to which output is to go. For example, the entry GP1/LJ1 sends output to the print queue GP1 in Hewlett-Packard LaserJet format with a 75 dpi resolution factor.

THE NEXT MENU entries establish trimming, scaling and rotation parameters.

To process portions of a file, specify the number of inches to trim from the top and/or left of the image. Specifying negative numbers adds space to the image. When you specify the number of inches to move down and to the right from the upper-left corner, only the portion of the image below and to the right of this new upper-left corner will be processed.

Image scaling can range from .01 to 100 with 1.0 representing the true size of the image.

Rotation determines portrait or landscape orientation. If the image will be integrated into a MASS-11 document, when you enter Y at the rotation prompt, the image will be rotated 90 degrees counterclockwise.

If rotation isn't specified, any image integrated with a MASS-11 document will take on the characteristics of the document. If the document is set for portrait mode, the image is produced in portrait mode, and documents set up for

landscape printing produce an image in landscape mode.

To integrate an image into a MASS-11 document, answer Y to the last prompt.

### Second Step

The second step to integrate graphics into MASS-11 documents involves embedding a command in the form of:

```
<FILE=n.nnX,n.nnY,n.nnG,"filename.ext">
```

into the MASS-11 document where you want the image to appear. The image is placed in the file with the upper-left corner beginning at the position of the < character of the embedded command.

The n.nnX and n.nnY qualifiers specify the number of inches the image is displaced from the < character of the embedded command. The n.nnX qualifier specifies a horizontal shift, and n.nnY specifies a vertical shift.

The n.nnG qualifier specifies the height in inches reserved for the image. You must know the exact height of your image, including trimming and scaling, to specify this parameter correctly.

The "filename.ext" qualifier is the name of the graphics file you created by

## MASS-11 Graphics Processor

**PLATFORMS:** VAX/VMS systems running MASS-11 word processing version 7A-04 or higher

**PRICE:** Ranges from \$995 for the VAXSTATION to \$5,750 for the VAX 8500

### MICROSYSTEMS ENGINEERING CORP.

**HEADQUARTERS:**

2400 W. Hassell Road  
Suite 400  
Hoffman Estates, IL 60195  
(312) 882-0111

**FOUNDED:** 1975

**PRODUCT LINE:** Office automation software for VAX and PC environments

**OWNERSHIP:** Private

CIRCLE 561 ON READER CARD

answering Y to the question of whether the file was to be integrated into a MASS-11 document.

If you're not incorporating graphics into columns, the procedure is straightforward. The documentation includes clear examples illustrating the more

## FIGURE 1.

Here is a Macintosh PICT file, converted via Mass-11 GP to a file compatible with our LaserJet. This is printed at 150 dpi; thus the reason for the "LJ3" file extension. It was also scaled to fit the page properly. After some experimentation, the -0.75X command was inserted to move the image to the left a little bit.

```
<FILE=-0.75X,6.5G,"user1: [miller.graf]macpict.lj3">
```

This is the end of the Macintosh PICT section.

*A MASS-11 document displaying the embedded FILE command.*



## The more advanced your training needs, the more you need the experts who created the UNIX<sup>®</sup> System.

You've gone beyond the basics, and now you need *serious* training developed by AT&T Bell Laboratories.

We're the people who created the UNIX System. We teach the most current and advanced levels of System V Release 3, including courses on Internals.

We also teach—independent of a machine's architecture—Generic System Administration and Generic Device Drivers.

Additionally, we offer Shell Programming and C Languages, including C++.

You can study at our training centers nationwide with AT&T's most skilled computer science

instructors, all of whom have hands-on experience as developers and programmers.

Or if you prefer, our instructors will come right to your location. And we even offer a comprehensive range of economical videotape instruction.

If you're ready to step up to advanced UNIX System training, AT&T is ready for you. Call or write now for details.

**AT&T COMPUTER TRAINING**  
*Come right to the source.*  
**1 800 247-1212, ext. 867.**  
Or send in the coupon below.

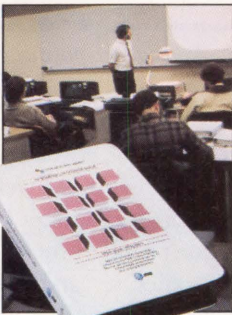

**Registrar, AT&T Training**, P.O. Box 45038, Jacksonville, FL 32232-9974

**YES!** I'd like advanced level computer training right from the source. Please rush me more information about:

Classroom Training, including course descriptions and schedules for the Advanced UNIX<sup>®</sup> System and programming languages.

Videotape Training in the UNIX System, C Language, and Shell Programming Language.

Name (Please print) \_\_\_\_\_

Title \_\_\_\_\_ Phone ( ) \_\_\_\_\_

Company \_\_\_\_\_

Address \_\_\_\_\_

City \_\_\_\_\_ State \_\_\_\_\_ Zip \_\_\_\_\_

DET11018  
© 1988 AT&T

# FIGURE 2.

Here is a Macintosh PICT file, converted via Mass-11 GP to a file compatible with our LaserJet. This is printed at 150 dpi; thus the reason for the "LJ3" file extension. It was also scaled to fit the page properly. After some experimentation, the -0.75X command was inserted to move the image to the left a little bit.

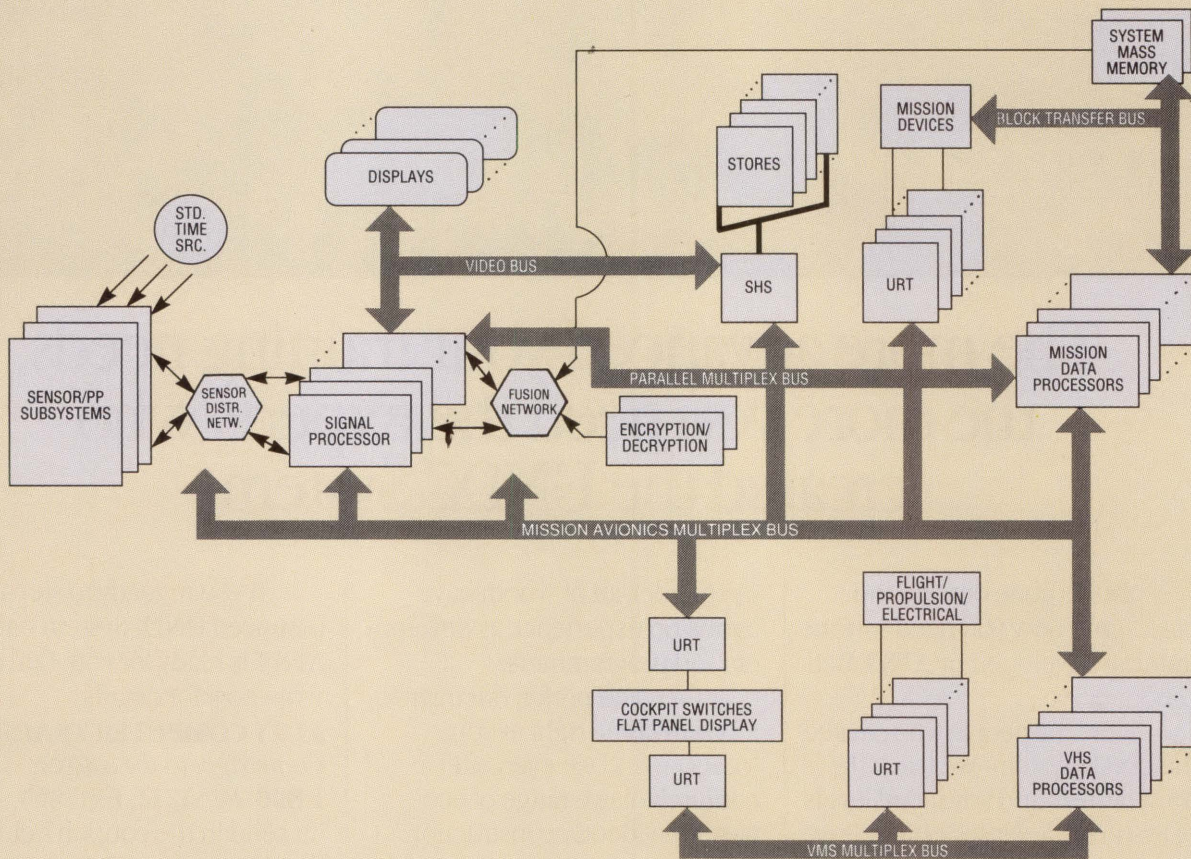

This is the end of the Macintosh PICT section.

A MASS-11 document displaying the output resulting from the embedded FILE command.

complex procedures for including graphics in columns. Figure 1 shows a MASS-11 document displaying the embedded FILE command, and Figure 2 shows the resulting output.

## Documentation

The user guide provides numerous examples and clear explanations. Examples outline the procedures needed to incorporate graphics into MASS-11

documents.

Foibles and problems associated with certain printers are explained well. For instance, the HP LaserJets, except for the LaserJet 2000, don't support rotation of bit-mapped graphics to landscape orientation.

MASS-11 GP IS A powerful, easy-to-use way to produce graphics output from various foreign file formats and to in-

tegrate graphics into your MASS-11 documents.

*Editor's note: Since this evaluation, MEC has added a batch feature, allowing you to process multiple files. The Graphics Processor can accept Computer Graphics Metafile (CGM) files as input. Initial Graphic Exchange Specification (IGES) files can be imported and exported, and Interleaf Technical Publishing System (TPS) files can be exported.*

# DEC<sup>®</sup> PRINTER CLONE SELLS FOR THOUSANDS AND THOUSANDS LESS.

At \$8990 for 800-lpm, high speed printing has never been more affordable. As a comparison, that's the price you pay for 300-lpm from DEC. It gets better. How about \$11,990 for 1200-lpm! DEC's 1200-lpm offering goes for \$29,000. And in the bargain, you get bar code and business graphics capability.

## Reliability? You bet?

Taneum Computer Products has modified the ruggedly reliable Mannesmann Tally 600-Series matrix line printer into a DEC line printer compatible machine.

Plus, our prices include installation, a full 90-day on-site warranty and operator training. Also, nationwide factory service maintenance contracts are available from Mannesmann Tally at substantial savings. For example, pay only \$148 monthly for a 1200-lpm model. If you know printers, you know Mannesmann Tally leads the league in quality and dependability. And steadfast output. Their 1200-lpm machine is designed to deliver 5000 pages per day.

**Taneum – the printer people.** Taneum personnel collectively bring 50 years of time-tested printer expertise to the table. We know printers and we know all the ins and outs of interfacing to make a printer play to perfection on your system. If you are planning to upgrade your present system, or simply need to replace a worn-out printer, make your first call to the printer people at Taneum.

**Act Now!** This is an incredible offer. High speed line printing at prices thousands of dollars less than from your mainframe supplier. So why pay such a high tariff for mainframe color and logo. Get fast delivery by picking up the phone and calling us now. **(206) 228-5956.**

P.S. LGO1 OEM ribbons at great savings.

\* – DEC registered trademark of Digital Equipment Corp.

CIRCLE 181 ON READER CARD

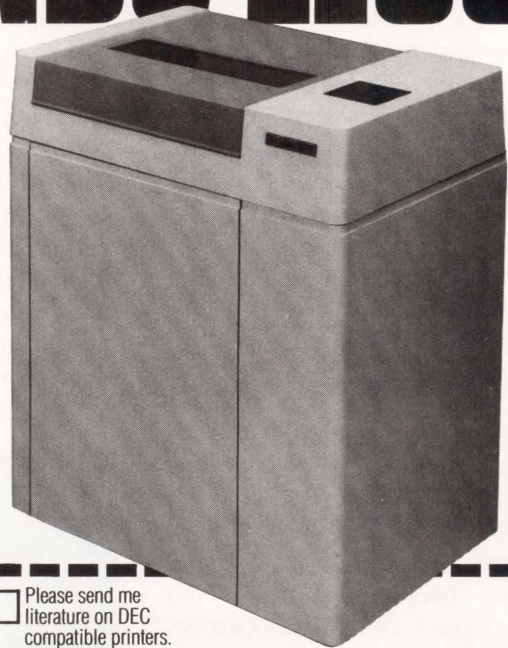

Please send me literature on DEC compatible printers.

Name \_\_\_\_\_

Title \_\_\_\_\_

Company \_\_\_\_\_

Address \_\_\_\_\_

City/State/Zip \_\_\_\_\_

Telephone \_\_\_\_\_

Send to:  
**Taneum Computer Products**  
1123 Maple Ave. S.W.  
Renton, WA 98055

*The printer people*

# TANEUM COMPUTER PRODUCTS

DEC VAR inquiries invited.

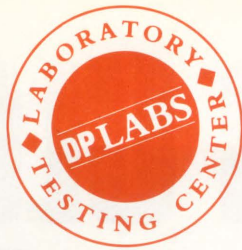

# Esprit Systems' Opus 3n1 Video Display Terminal

**David B. Miller** Many users find it important to be able to connect to multiple host systems, perhaps from different vendors. Rather than using a separate terminal for each host, terminal manufacturers produce models that emulate popular terminals to cover all the bases with one unit.

The Opus 3n1 video display terminal from Esprit Systems Inc. of Melville, New York, lets you do that and more. Its ability to emulate a number of popular terminals is augmented by a dual-host capability that makes it suitable for sites requiring connection to multiple host systems.

## Setup And Operation

The Opus 3n1 emulates the VT52/100/200 in 7- or 8-bit modes. Conventional ASCII emulations include the Esprit 6319/H1500, ADDS Regent 25/Viewpoint, Wyse 50, TeleVideo 910/925/950 and Zentec ADM3A/5. PCTerm and ANSI.SYS emulations use IBM PC keyboard codes. Many setup parameters and keyboard characteristics are established for you when you choose the preferred emulation.

If you're connected to two hosts, you can switch easily between sessions. Each session can be set up to cause the host to suspend data transmission or

allow data to be passed to the terminal while you're working on the other host.

Two different terminal setups can be held in memory simultaneously. Eleven setup menus provide the choices needed to establish I/O parameters, emulation type, display and keyboard preferences, printer port requirements, programmable key selection and other parameters.

## Ergonomics And Design

The terminal is packaged in a two-tone cabinet of gray and charcoal. It's a nice change from the off-white cabinets you may be accustomed to. A tilt-and-swivel base makes positioning of the monitor easy. The on/off switch, keyboard jack and brightness control are within easy reach at the front of the unit.

Our 14-inch monitor featured green phosphor characters formed with a 7-dot x 11-dot matrix in a 9-dot x 13-dot window. Text is easy to read.

The screen supports 24 lines of text of 80 or 132 characters each. Status lines can be displayed either at the top or bottom of the screen or both. Two-page video memory is standard. Four-page video memory is optional.

Typical video attributes such as reverse, dim, underline, bold, blink and blank are supported. A number of character sets, in addition to U.S. ASCII, are supported, including 32 special graphics characters and the Danish, French, Ger-

“

**Two different terminal setups can be held in memory simultaneously.**

”

man, Norwegian, Spanish, Swedish and U.K. international character sets. Three 128-character sets are dynamically reloadable.

In addition to the standard character sets, a 94-character User Set is available to download custom fonts for the duration of a terminal session.

Three speeds of smooth scrolling, as well as jump scrolling, are available. The cursor can be displayed as a block or an underline, or can be hidden. You can select the screen saver to blank the

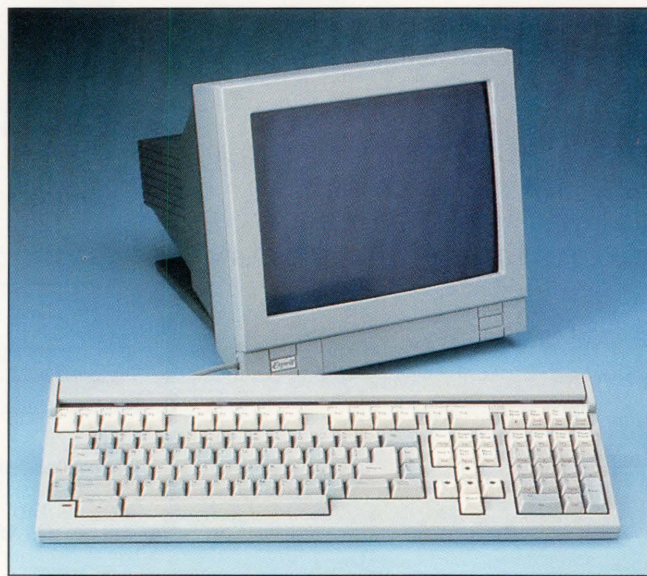

**The Opus 3n1 terminal provides flexibility by offering DEC, conventional ASCII and PCTerm emulations.**

# Avoid Graphic Jams

If graphics slow your 15 page per minute laser printer down to 15 minutes per page, you're in a graphic jam. But the Talaris 1590 puts you in the fast lane with 2 to 10 times faster throughput for graphics than any other 15 page per minute printer.

The 1590 prints simple graphics and text at the rated speed of the engine. It prints a 6800-vector plot in 6 seconds flat. And it doesn't run into bottlenecks in multi-user and multi-tasking conditions.

It features four interfaces and a high-speed Ethernet option. And five emulations including LN03 PLUS® HP LaserJet II® and Tektronix 4014 graphics. 43 ROM fonts with ten special attributes. 500-sheet paper capacity. Two plug-in cartridges for easy addition of font libraries and overlays. And it's compatible with most word processing and graphics packages.

So speed to a phone, give us a call, and let's make dust together.



**TALARIS**  
SYSTEMS INC.®

(619) 587-0787  
6059 Cornerstone Court West  
P. O. Box 261580  
San Diego, CA 92126

CIRCLE 162 ON READER CARD

The trademarks and registered trademarks are proprietary to their respective manufacturers.

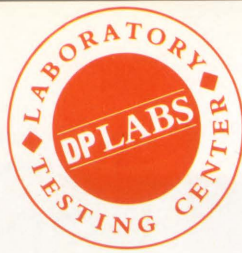

screen after 10, 20 or 30 minutes, or not at all.

The detachable keyboard has a solid feel. There are 16 function keys across the top, a middle bank of cursor and editing keys, and an 18-key keypad on the right. Tabs on the F and J keys keep you from straying from the home row. The keys are fairly flat. Keyclick, if you

### Companies Mentioned In This Article

Applied Digital Data Systems Inc.  
(ADDS)  
100 Marcus Blvd.  
Hauppauge, NY 11788  
(800) 645-5298

CIRCLE 547 ON READER CARD

Digital Equipment Corporation  
146 Main St.  
Maynard, MA 01754  
(617) 897-5111

CIRCLE 400 ON READER CARD

Hayes Microcomputer Products Inc.  
P.O. Box 105203  
Atlanta, GA 30348  
(404) 449-8791

CIRCLE 560 ON READER CARD

TeleVideo Systems Inc.  
1170 Morse Ave.  
P.O. Box 3568  
Sunnyvale, CA 94088  
(408) 745-7760

CIRCLE 548 ON READER CARD

Wyse Technology  
3571 N. First St.  
San Jose, CA 95134  
(408) 433-1000

CIRCLE 549 ON READER CARD

Zentec Corporation  
2400 Walsh Ave.  
Santa Clara, CA 95051  
(800) 332-5631

CIRCLE 550 ON READER CARD

choose to use it, is pleasant and unobtrusive.

Keycap tops have the standard VT220 labeling in black. PC keyboard functions are placed on the front of each key. One difference in function key placement between the DEC LK201 and Opus 3n1 keyboards is that the Opus' F1 to F4 keys play the same role as the VT220's F17 to F20 keys.

You have lots of control in customizing your keyboard. Autorepeat can be set at 15 or 30 characters per second. For emulations other than PCTerm and ANSI.SYS, three sets of values can be programmed into the 16 function keys in terminal setup. You can choose the set you need for each session. Thirty-eight keys are available for programming, as well.

Two standard female RS-232-C asynchronous ports supporting baud rates from 50 bps to 38.4 Kbps are located at the rear of the unit. RS-422 and 20 mA current loop interfaces are optional. The interfaces can be used to connect to multiple hosts or to other serial devices such as printers and modems.

### Additional Features

Two useful tools are included with the Opus 3n1. The first lets you display the currently active character set along with the characters' decimal and hexadecimal values.

The second tool is an autodialer that can store up to six phone numbers and issue Hayes AT commands to Hayes-compatible modems. It's a convenience worth having if you use modems frequently.

Several methods of printing to a local printer are available. You can print data as it's displayed. Buffered printing sends data to the printer but doesn't echo data to the screen. Page printing prints the contents of the current page up to the point of the cursor. Bidirectional printing outputs data to the aux-

## Opus 3n1 Terminal

**PLATFORMS:** Emulates a number of popular DEC/ANSI and ASCII terminals, and is PCTerm- and ANSI.SYS-compatible

**PRICE:** \$595

### ESPRIT SYSTEMS INC.

**HEADQUARTERS:**

100 Marcus Dr.  
Melville, NY 11747  
(516) 293-5774

**FOUNDED:** 1982

**PRODUCT LINE:** Video terminals

**REVENUES:** \$23 million

**OWNERSHIP:** Public (AMEX: ETI)

CIRCLE 546 ON READER CARD

iliary port, and any data the auxiliary port receives is sent to the host on the main port. In VT100/200 modes, an Autoprint feature prints each line of data as it's completed.

In addition to the basic set of VT52/100/200 commands, a set of Esprit Extended Commands (EEC) is available to programmers to control character set, display, I/O and other environmental parameters.

Commands also are available to allow programmers to write windowing software. Termed Express Windows, this command set allows windows and their contents to be created, copied, moved and deleted.

Documentation is clear. Specifics about each emulation are separated and labeled clearly so that you don't read unnecessary information.

The Esprit Opus 3n1 is a solid, versatile terminal. Its multiemulation capability should prove beneficial to sites where terminals possessing multiple personalities are required.



# Have your cake and eat it too.

**Gigabytes of  
unattended  
back-up and  
data interchange  
for DEC, IBM,  
Apple, Sun...**



**Come see us at:**

**DEXPO WEST 88**  
Anaheim, CA  
Oct. 17-21

**Federal Computer  
Conference**  
Washington, D.C.  
Oct. 26-28

**Society of Exploration  
Geophysicists**  
Anaheim, CA  
Oct. 30-Nov. 3

**COMDEX/FALL 88**  
Las Vegas, NV  
Nov. 14-18

**Foreign Distributors:**

CANADA:  
**QUE SYSTEMS**  
Phone: 403-236-6100

FRANCE:  
**INDEX INFORMATIQUE**  
Phone: 45066596

WEST GERMANY:  
**ISS GMBH**  
Phone: 42034050

Doing back-ups or interchanging a Gigabyte or more of data is no treat. But with the **GigaTape™** you'll have the winning recipe for high-capacity back-up and data interchange.

The **GigaTape** will satisfy the most discriminating tastes. Whether you have a DEC, IBM, Apple, Sun or other host system, the **GigaTape** provides "plug and play" capability. With just *ONE* 8mm helical-scan data cartridge, you can back up two Gigabytes of data, at a cost of less than two cents per Megabyte.

Make data interchange a cakewalk with your choice of two file-formatting methods. Use the **GigaTape's** ANSI standard file formatting and our data interchange utility for data distribution across multiple systems. Or use our proprietary method for increased speed and capacity on network or host-specific back-ups.

Out of the case or made to order, there is a **GigaTape** to meet your most voracious data storage needs. We have a family of helical-scan products with capacities up to a full Terabyte, or we can integrate high-capacity disk drive subsystems to 20 Gigabytes with one or more **GigaTapes**.

The SUMMUS commitment is icing on the cake. With more than eight years of experience in custom systems integration, we know that you can't afford to make computing decisions lightly. That's why we have extensive technical support, and a well-stocked inventory. And that's why the Veterans Administration, Lockheed, Kraft, General Electric, NASA and others have come to SUMMUS for their data storage and interchange solutions.

You *can* have your cake and eat it too with the **GigaTape**; call us today at

▶ **1-800-255-9638**

**SUMMUS™**  
COMPUTER SYSTEMS

SUMMUS COMPUTER SYSTEMS  
P.O. BOX 219270 • HOUSTON, TX. 77218  
713-492-6611 • TELEX 62045352 Answer back SCSSUM  
FAX 713-492-0092 • Call for our foreign representatives

GigaTape and GigaBox are Trademarks of SUMMUS COMPUTER SYSTEMS.  
Apple, DEC, IBM, Macintosh, and SUN are Trademarks of their respective companies.  
© 1988 SUMMUS COMPUTER SYSTEMS

CIRCLE 160 ON READER CARD

# Most purchasing software systems promise great performance.



## As long as they call the tune.

Adapting software to your unique purchasing requirements can cost a fortune. Unless you buy Cardinal.

With Cardinal, you get the fit and functionality of custom software at a fraction of the cost. This means you can specify as many unique order types as you need. You can specify how each will be processed. And you can do all of this quickly and easily — without programming.

No other approach to purchase order management gives you anywhere near this much flexibility. Cardinal's

unique architecture lets you define and process requisitions, blanket contracts, standing orders, import orders — any kind of order — any way you like. And as your order processing requirements change, your systems can change with them — without reprogramming.

So why settle for an inflexible order management system? Or spend a fortune on custom software development? Call Cardinal. And get to call your own tune.

 cardinal data corp

75 Second Avenue, Needham, MA 02194 • (617) 449-0066  
Distributors: Los Angeles (714-554-1551) • Sydney (2-436-4022)

**INTEGRATED SOFTWARE FOR: ORDER MANAGEMENT • PURCHASING • INVENTORY  
• RECEIVABLES • PAYABLES • GENERAL LEDGER**

CIRCLE 195 ON READER CARD

# Free Weekends For VAX Managers

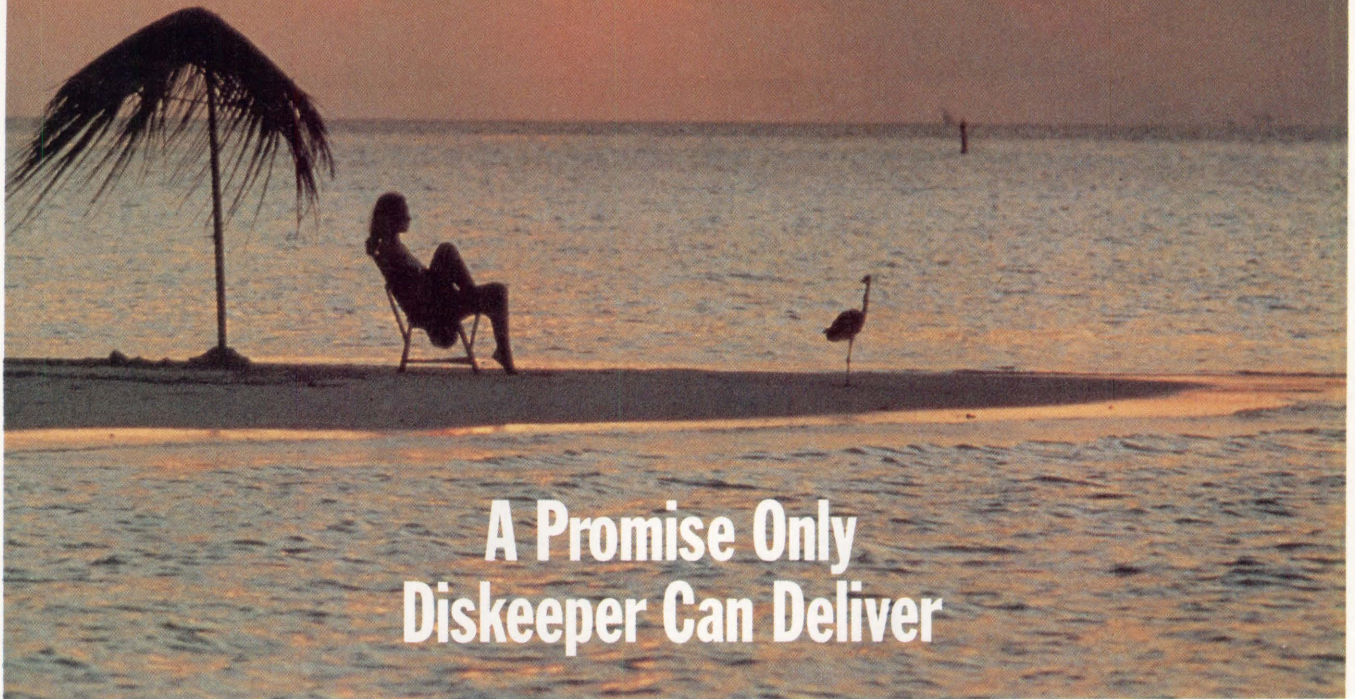

## A Promise Only Diskeeper Can Deliver

**D**ISKEEPER is the original and remains today the *only* online disk defragmenter that can really deliver free weekends. Because only DISKEEPER is designed to run in the background without any operator intervention whatsoever, with complete safety. Just set it and forget it. No more weekends in the shop with backup and restore.

DISKEEPER provides dramatic performance gains in as little as two to five minutes of CPU time per day. And DISKEEPER generally pays for itself within the first month or two of use.

### DISKEEPER Out-Performs All Others

In a recent independent test of all defragmenters, DISKEEPER outperformed its nearest two competitors by factors of 20 to 1 and 117 to 1 in the defragmentation of files (measured by the number of non-contiguous files remaining on the disk), and 52 to 1 and 385 to 1 in the consolidation of free space (measured by the number of free spaces remaining on the disk).

### DISKEEPER Is The Safest Defragmenter Available

DISKEEPER'S design gives the highest priority to file safety and file

integrity. As a result, DISKEEPER is the safest defragmenter available.

- ▶ ONLY DISKEEPER copies files directly from the original location to the new location without intermediate copies.
- ▶ ONLY DISKEEPER defragments so safely that no recovery procedure is ever required. DISKEEPER never places a file in a vulnerable state during the defragmentation process. You are guaranteed of always having your file intact—period.
- ▶ DISKEEPER is the only defragmentation software that offers a money back guarantee of safety.

### DISKEEPER Is Thoroughly Tested

DISKEEPER has been thoroughly tested and proven safe at thousands of sites worldwide.

### Free Software Offer

Executive Software is making available for a limited time only to qualified VAX Managers FREE copies of its Disk Analysis Utility (available on 9 track mag tape), which measures and reports to you the state of file and freespace fragmentation on your disks. How badly fragmented are your disks? Call or return the coupon below TODAY!

**800-346-4707 ext. 2313**  
In California call: (818) 249-4707 ext. 2313

## Executive Software

2219 Broadview  
Glendale, California 91208  
Telex: 910 240-9222

**YES!**

- Send me a copy of Executive Software's FREE Disk Analysis Utility.  
 Please send me more information about DISKEEPER

Name \_\_\_\_\_

Title \_\_\_\_\_

Company \_\_\_\_\_

Phone (A Must) \_\_\_\_\_

Address \_\_\_\_\_

City \_\_\_\_\_

State \_\_\_\_\_

Zip \_\_\_\_\_

How many VAXStations? \_\_\_\_\_

How many MicroVAXes? \_\_\_\_\_

How many VAX 6XXXs? \_\_\_\_\_

How many VAX 11/7XXs? \_\_\_\_\_

How many VAX 8XXXs? \_\_\_\_\_

How many users total? \_\_\_\_\_

VMS Version  5.0  4.X



CIRCLE 245 ON READER CARD

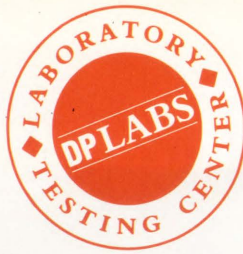

# Software Techniques' ARCHIVE 2000

**David B. Miller** When you think of mass storage management, your thoughts might turn to disk storage control. Behind every well-managed disk farm, however, is a well-managed tape library that users can rely on for backups and archival purposes.

Many managers know that disk storage management is difficult. But tape storage can be trickier still. Finding files in a large tape library can be difficult. Multiple copies of different versions of files can exist on different tape reels. Out-of-date files might reside with current files, wasting valuable tape space.

Effective tape storage management is critical. ARCHIVE 2000, from Software Techniques Inc. of Cypress, California, can help. ARCHIVE 2000 spreads responsibility for tape management to users, operators and system managers. We tested version 3.2 (55) on our VAXCLUSTER.

## Getting Started

VMSINSTAL is used to install ARCHIVE 2000. After installation, you can begin to configure archives with the ARCONTROL utility.

An archive consists of an on-line directory, queues to hold requests to save and restore files, an optional disk cache area and your tape library. Figure 1 illustrates the interrelationship among the components. Screen 1 displays the

```
VAX/VMS ARCHIVE CONTROL PROGRAM Version 3.2
Details of archive TEST1

Username                MILLER
Directory               SYSS$ARCHIVE:[TEST1]DIRECTORY.DAT
Save_queue              SYSS$ARCHIVE:[TEST1]SAVE
Restore_queue           SYSS$ARCHIVE:[TEST1]RESTORE
Media_handler           SYSS$ARCHIVE:[MASTER]MTHANDLER.EXE
Media_log_file          SYSS$ARCHIVE:[TEST1]OPERATOR.LOG
Media_control_file      SYSS$ARCHIVE:[TEST1]CONTROL.DAT
Fast_restore_queue      SYSS$ARCHIVE:[TEST1]FRESTORE

Fast_time                = 30  Minute(s)  Copies                = 1  Saveset(s)
Max_expiry_time         = 0   Days        Version_limit         = 0  Files
Min_spare_blocks       = 5000 Blocks

Enabled: CACHE FAST__RESTORES SAVES DEFAULT ACLS__ONLINE
Disabled: FAST__SAVES AUTOGENERATE USE__MEDIA IGNORED KEEP__REVDAT

Arcontrol >
```

Screen 1: A display from ARCONTROL listing configuration parameters for the archive TEST1.

locations and characteristics of one of the archives set up for this review.

The on-line directory is an indexed RMS file that contains the names of all files residing in the archive. The directory's structure looks exactly like VMS's, so you'll be familiar with operational procedures. You save and restore files into ARCHIVE 2000 directories with the SAVE and RESTORE commands in the same fashion as you use the VMS COPY command.

ARCHIVE 2000's queues hold SAVE and RESTORE requests. FAST SAVE and FAST RESTORE queues hold requests that operators are to fulfill within a certain time period, say 30 minutes. Normal SAVE and RESTORE queue requests can be set up to be fulfilled at other times of day, perhaps at the beginning and end of a shift. A process, ARWATCH, runs in the background, scanning for FAST SAVE

and FAST RESTORE requests.

The optional cache is a temporary holding area on disk where SAVED files are copied and held for later processing. When no cache area is defined, SAVE operations simply queue a request for the system operator who later moves the user's files to tape. With caching enabled, files are copied to the temporary area on disk. You see the SAVE operation as complete.

Files can be RESTORED immediately from this cache area before the operator moves the files to tape and flushes the cache. The size of your cache will be determined by available disk space and configuration parameters. A bigger cache will reduce the amount of operator intervention because you can SAVE

# The SAS<sup>®</sup> System

## The Data Analysis Tool You Won't Outgrow.

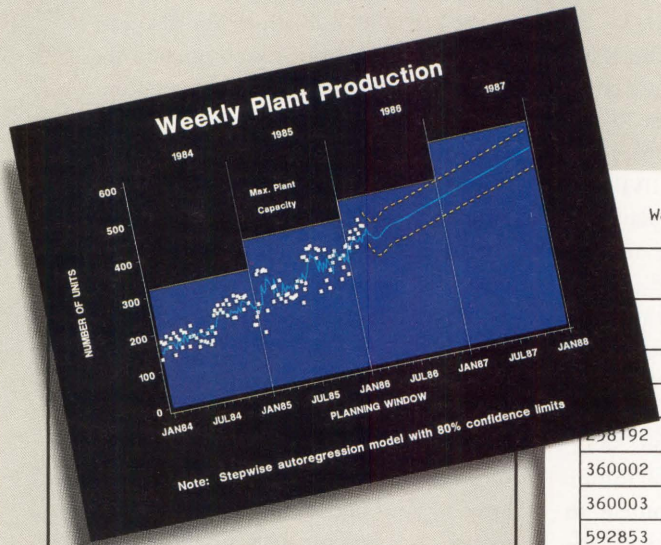

Warehouse Inventory Report - 16JAN87

	Quantity on Hand	Quantity on Order	Projected Reorder Date
	123980	10000	THU, FEB 12, 87
	89450	5000	FRI, FEB 20, 87
258192	20110	1000	MON, MAR 30, 87
360002	8585	0	TUE, FEB 10, 87
360003	15985	500	TUE, FEB 10, 87
592853	469120	20000	WED, FEB 18, 87

For details, send us your name and address. Or call a Software Sales Representative today.

**The SAS System. It's the most widely installed tool for data analysis among VMS users\*... And more.**

If your job demands a powerful data analysis tool, the SAS<sup>®</sup> System is your solution. The SAS System gives you ready-to-use procedures for performing every kind of analysis—from simple descriptive statistics to advanced regression, analysis of variance, discriminant analysis, clustering, scoring, and more.

The SAS System reads data in any structure from any kind of file. You can create new variables, modify old ones, combine files, detect errors, and accumulate totals. Once your analysis is complete, you can report your results in lists, tables, charts, or plots.

And as your needs grow, the SAS System grows with you. All the tools you need for color graphics, forecasting, modeling, "what if" analysis, project management, optimization, and quality control are available in the SAS System. You choose the products you need, and enjoy the same easy-to-use language and syntax in each. Plus, you can use the same software on your personal computer.



SAS Institute Inc.  
SAS Circle □ Box 8000  
Cary, NC 27512-8000  
(919) 467-8000  
Fax (919) 469-3737

\* Computer Intelligence, January 1986.

The SAS System runs on Digital Equipment Corp.'s VAX™ series minicomputers and workstations under VMS™ as well as other mainframes, minicomputers, and personal computers.

SAS is the registered trademark of SAS Institute Inc., Cary, NC, USA. Copyright © 1987 by SAS Institute Inc. Printed in the USA.



Rate	Lots Tested	Rejected Lot Statistics		Mean	Percent
		Lowest	Highest		
30	4	1	4	2.5	0
40	6	1	6	3.5	33
50	6	3	8	5.5	66
60	6	4	9	6.5	83
70	7	4	10	7.0	85

**digital**™ Cooperative Marketing Program

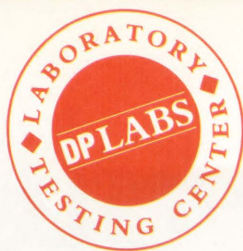

and RESTORE files quickly. The tradeoff is that your disk space will be reduced, especially if your users don't remove original files from their VMS directories.

For your tape library, ARCHIVE 2000 needs to know the default length and density of the tapes in each archive. You must specify the number of copies of each file to make. ARCHIVE 2000 will keep track of tape labels and will generate tape numbers for you automatically.

In addition to initial archive configuration, the ARCONTROL utility lets you modify and remove archives and generally provides archive management functions. System managers can delete individual files in an archive, create directories for users and change file ownerships.

### The User's ARCHIVE

For the user, ARCHIVE 2000 looks and feels similar to DCL. In fact, often you'll know you're not using DCL commands only because the ARCHIVE> prompt is visible instead of the normal system prompt. ARCHIVE 2000 is command

driven, and has no extensive menus or fancy graphics. The resemblance to DCL makes ARCHIVE 2000 easy to learn. Extensive on-line HELP is provided.

You archive files with the SAVE command, similar to VMS's COPY command. An entry is made for the SAVED file in your ARCHIVE 2000 directory and optionally copied to the ARCHIVE 2000 cache area. SAVE requests are placed in the ARCHIVE 2000 SAVE queue and the system's operators are notified.

You can remove the file from your VMS directory, apply an Access Control List (ACL) to it, specify different protections on it, replace a version with the same name and confirm the SAVE, among other options. One useful feature is that you can attach a comment to SAVED files, allowing you to provide additional descriptive data.

A RESTORE request will be fulfilled immediately if the file resides in a cache area. Otherwise, a request is queued for the system operator to RESTORE the file from tape. As with the SAVE operation, an ACL can be associated with the RESTORED file, a file with the same

name can be replaced with the RESTORED file and the archive entry can be removed upon successful completion of the RESTORE operation. You also can select files based on any comments attached to them during a SAVE operation.

Many other commands, such as PURGE, SHOW, LIST, SET, LOG and DIRECTORY, work in the same fashion under ARCHIVE 2000 as they do under VMS. ARCHIVE 2000 provides full wildcard support for file names.

ALL-IN-1 users can enjoy the benefit of ARCHIVE 2000's optional ALL-IN-1 interface. ARCHIVE 2000 is accessed from ALL-IN-1's File Cabinet Management Option. The supplied script and DCL files making up the interface can be tailored to your needs, but Software Techniques can't support such modifications.

### The Operator's ARCHIVE

Operator responsibilities include saving and restoring files to and from tape, producing usage accounting files, deleting files that have expired and performing tape compression.

Saving files to tape can be done to multiple tape drives if specified during archive configuration. If multiple drives are used, copies of files can be written to each one simultaneously, or multiple passes can be used to write copies in a serial fashion.

ARCHIVE 2000 gets tape label information from its on-line database and prompts the operator to mount the appropriate reel. It also detects inconsistencies in tape labels.

To make RESTORE requests easier to complete, the operator can display a list of all tapes containing the files to be RESTORED. A list of all tapes in an archive can be displayed as well.

Once a day, a charging file can be created to keep track of the number of

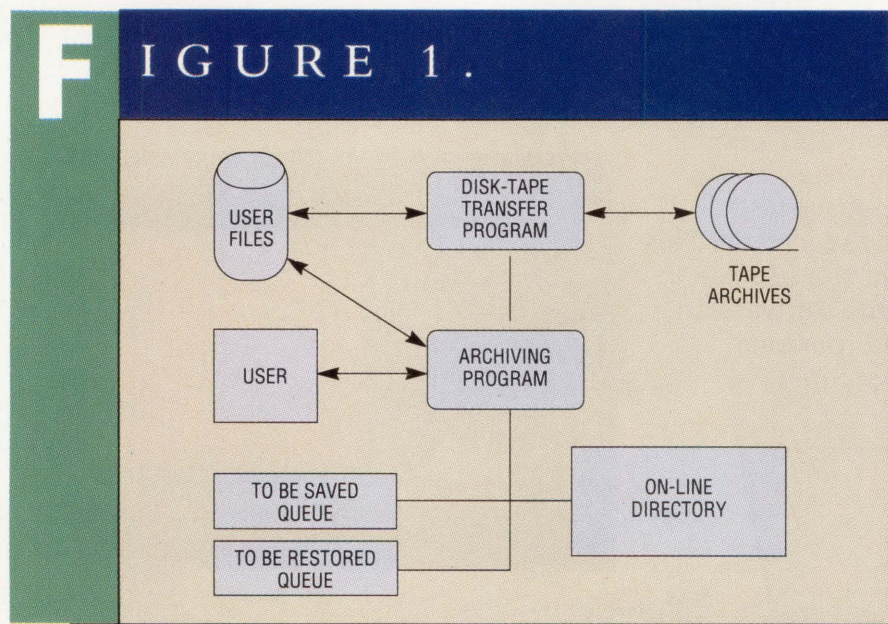

The interrelationship of ARCHIVE 2000's components.

# The SAS® System

## The Graphics Tool You Won't Outgrow.

When you've got to turn those numbers into a presentation, turn to the SAS® System. The SAS System includes easy-to-use procedures for charts, plots, maps, and three-dimensional displays. At a glance, you can grasp detailed statistics, spot relationships among items, and trace emerging trends. And when your manager wants more, the SAS System lets you customize your graphs and present multiple displays on the same page for easy comparison. You can produce your graphs on terminals, plotters, transparencies, or slides.

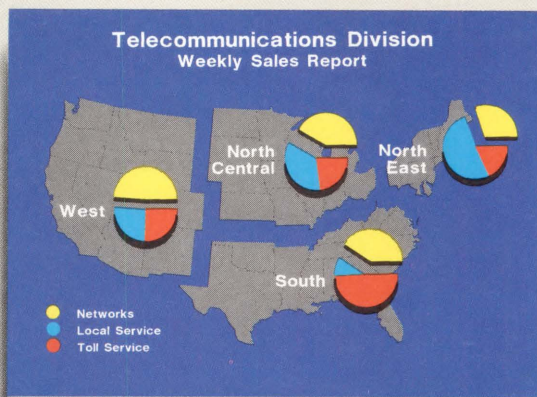

You can even use the SAS System to analyze your data before you present them. We've got tools for every kind of analysis—from simple descriptive statistics to advanced regression, analysis of variance, discriminant analysis, clustering, scoring, and more.

And as your needs grow, the SAS System grows with you. All the tools you need for full screen data entry, modeling, forecasting, "what if" analysis, project management, optimization, and quality control are

available in the SAS System. You choose the products you need, and enjoy the same easy-to-use language and syntax in each. Whether you license one product or several, you'll enjoy the same high-quality software, training, documentation, and

support we've offered for more than ten years.

For details, send us your name and address. Or call a Software Sales Representative today.

**The SAS System. It's for those who need a graphics package today, and for those who have an eye on tomorrow.**

**SAS** SAS Institute Inc.  
 Box 8000 □ SAS Circle  
 Cary, NC 27511-8000  
 (919) 467-8000  
 Fax (919) 469-3737

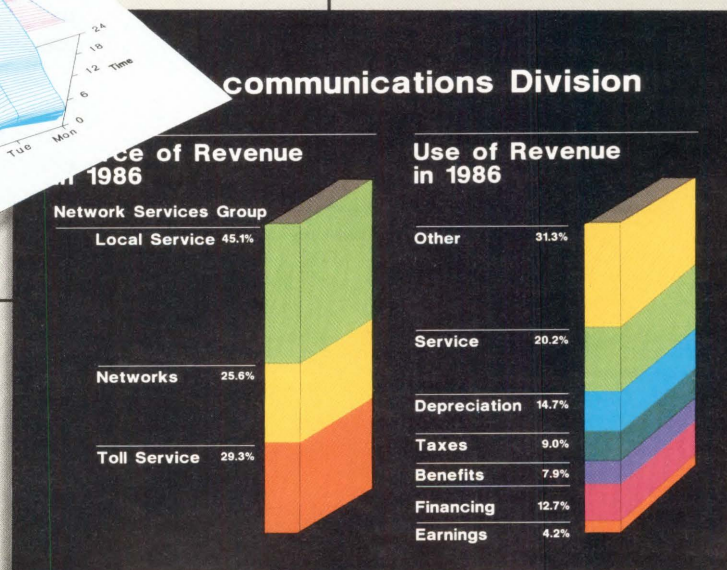
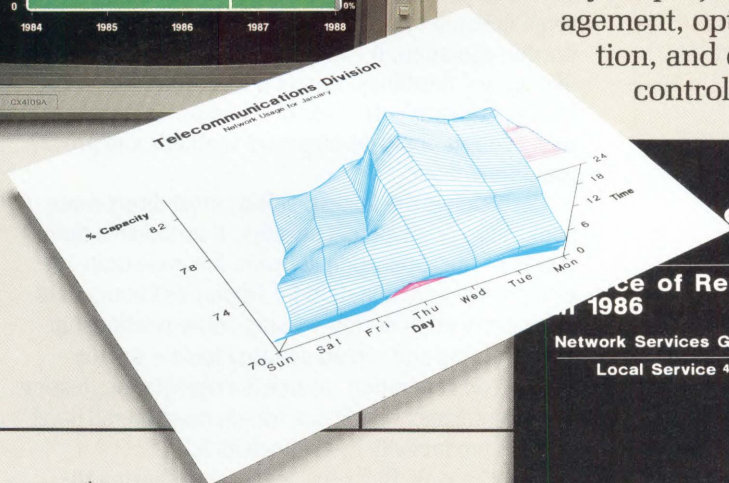
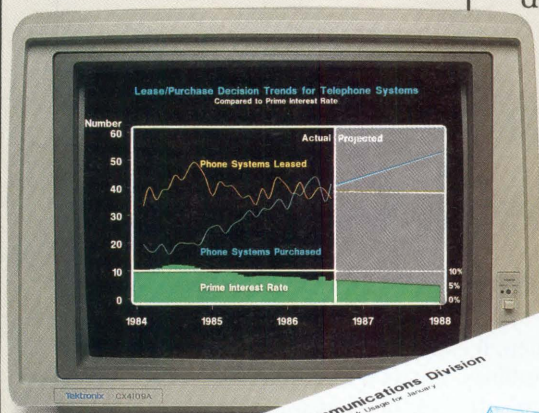

The SAS System runs on these minicomputers: Digital Equipment Corp. VAX™ 8xxx and 11/7xx series under VMS™ and MicroVAX II™ under MicroVMS™; Prime Computer, Inc. Prime 50 series under PRIMOS®; and Data General Corp. ECLIPSE® MV series under AOS/V5. The SAS System also runs on IBM 370/30xx/43xx and compatible machines under OS, CMS, DOS/VSE, SSX, and ICCF; IBM XT/370 and AT/370 under VM/PC; and IBM PC XT and PC AT under PC DOS. Not all products are available for all systems.

SAS is the registered trademark of SAS Institute Inc., Cary, NC, USA.  
 Copyright © 1986 by SAS Institute Inc. Printed in the USA.

**How to get  
from A to B  
without going  
through  
H.**

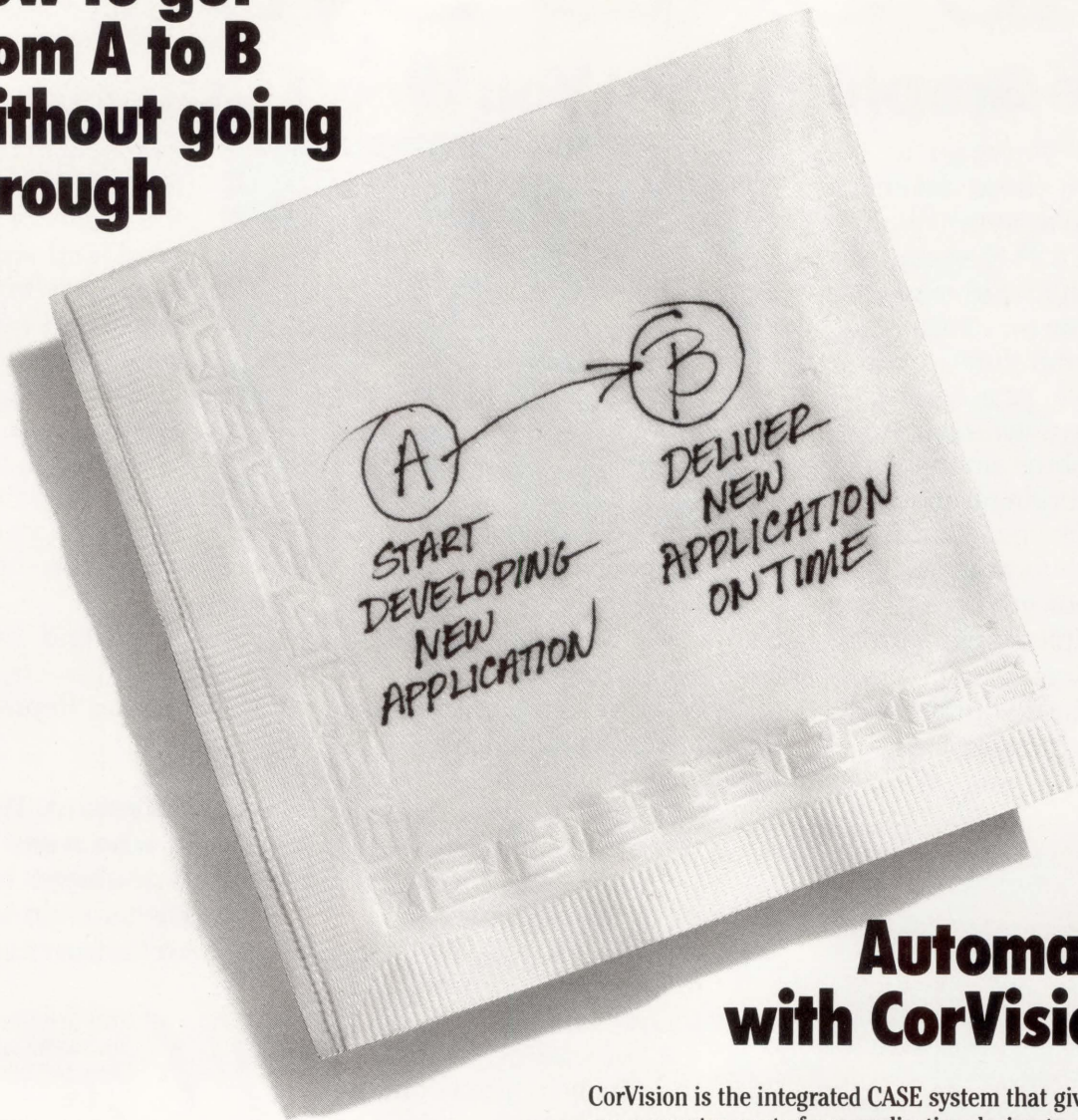

## **Automate with CorVision.**

CorVision is the integrated CASE system that gives you a nonstop route from application design to production operation. It eliminates unpleasant detours—like missed deadlines, unmet user requirements and budget overruns—that are often unavoidable when using conventional development methods and programming tools.

CorVision is the fastest, safest, most direct route to application development success. It automates more stages of the application software life cycle than any other development system for Digital VAX computers. From application design—using entity relationship diagramming and screen painting tools—to automatic code generation, source documentation, testing and maintenance, CorVision will increase overall development productivity by as much as 6:1.

If you're looking for the best way to shorten the distance between A and B, we urge you to test drive CorVision. Call or write today for more information.

**CORTEX**

Cortex Corporation, 138 Technology Drive  
Waltham, MA 02154 (617) 894-7000



Come see us  
at COMDEX booth #770.



## TI's new TravelMate™ LT220. It's the closest thing to carrying a VAX™ in your briefcase.

Texas Instruments introduces the LT220 lap-top terminal — the next best thing to being there when you need remote access to your company's VAX.

The LT220 provides full VT220 emulation in a 4.8-lb. package, without sacrificing functionality. It features a 25-line screen that's easy to read. It even has a full-function keyboard like the one on a VT220.

The terminal communicates at 1,200 or 2,400 bps through one of its optional internal modems. For hard copy, just slide the LT220 into one of its optional cradles to add an ink-jet or thermal printer.

New credit-card-sized memory cards

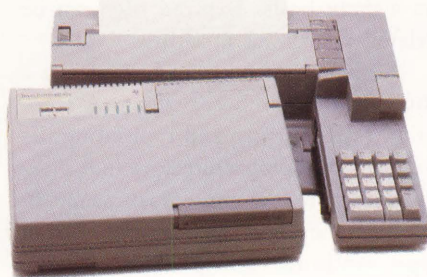

let you create, update and store files. They're also handy for programming the LT220 to your specific application.

Like its Silent 700™ predecessors, the LT220 sets new standards for portability, durability and reliability. All of which makes it the perfect tool for any-

one who's ever wished for a VAX in their briefcase. In short, this may be the best little terminal in the world.

So go ahead. Take the first step toward improving your productivity today. Call Texas Instruments for more information or to arrange a demonstration of the LT220. **Phone toll-free, 1-800-527-3500.**

  
**TEXAS  
INSTRUMENTS**

36154  
© 1988 TI  
Silent 700 and TravelMate are trademarks of Texas Instruments Incorporated.  
VAX is a trademark of Digital Equipment Corporation.

# IS YOUR DATA ENTRY SYSTEM OUTDATED?

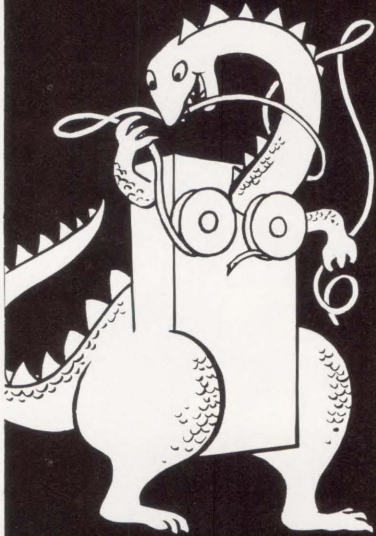

## MOVE UP TO VDE!

**VDE** — Viking Data Entry system — is a fast, accurate, easy-to-use data entry system for mini and micro computers. VDE requires no special hardware and eliminates programming for most requirements. Zap your pre-historic data entry equipment back into the ice age and start saving time and money with VDE! We'd like to tell you more about it . . .

call 918/745-6550

**VIKING**  
SOFTWARE SERVICES

2815 E. SKELLY, SUITE 816  
TULSA, OK 74105

CIRCLE 166 ON READER CARD



## ARCHIVE 2000 Version 3.2 (55)

**PLATFORMS:** VAX/VMS systems

**PRICE:** \$1,600—\$20,000

### SOFTWARE TECHNIQUES INC.

**HEADQUARTERS:**

660 Katella Ave.  
Cypress, CA 90630  
(714) 895-1633

**FOUNDED:** 1979

**PRODUCT LINE:** VAX/VMS system  
management tools

**OWNERSHIP:** Private, a subsidiary of  
UIS Ltd.

**BRANCHES:** San Francisco

CIRCLE 495 ON READER CARD

archived file blocks, who owns them and how long they've been on the system. A list of expired files also can be obtained so that they can be deleted from the archive.

A typical operator's schedule might include regular SAVE and RESTORE operations once or twice a day, as well as the processing of requests in the FAST SAVE and FAST RESTORE queues as needed. Charging files can be invoked on a daily basis. Expired files can be deleted weekly or monthly.

Other operations include doing a check of each archive's directory integrity, restructuring and reinstating directories, dumping a directory into a text file and listing the contents of a tape. In an emergency, files can be retrieved from tape without going through the ARCHIVE 2000 directory, if you know the directory information. An audit trail of vital tape information is maintained in case something should happen to entries in the on-line directory. Operator

functions can be run interactively or in batch.

Performing tape compression removes the gaps in your tape library and leaves only useful files behind. Files are RESTORED from tape to the cache area. Files you wish to keep then are SAVED to tape and the cache is flushed. You must ensure that your cache area is large enough to hold the files being RESTORED from the tapes you're compressing.

### Documentation

Documentation is extensive and the information dense. It's divided into sections that address regular users, operators and system managers. Using the extensive on-line HELP facility is also an excellent way to learn the program's operation.

ARCHIVE 2000 IS an efficient way to manage your tape library. It can be used in sites of all sizes, but those with large tape libraries will benefit most.

ARCHIVE 2000 can be integrated with other system management products from Software Techniques.

MEDIA — is a tape and removable disk librarian that helps you track media use and content. If integrated with ARCHIVE 2000, you can allow MEDIA to perform such tasks as tape mounts and tracking tape label information.

SCHEDULE — helps you organize and execute batch jobs. You can use it with ARCHIVE 2000 to automate repetitive operator and system manager functions.

VAULT — manages backups. It provides an on-line directory that can help you locate files SAVED during normal backup operations.

Although these packages overlap on a few features, together with ARCHIVE 2000 they provide a comprehensive media and file management system.

# Colleague™

## LAPTOP VT 220 TERMINAL

**Colleague**  
**\$995**  
**Colleague Plus**  
**\$1295**

*Includes battery  
and modem*



*"Keeping  
you in  
touch"*

#### **\$995 Colleague Portable Terminal includes:**

- 20 Auto Connect/Auto Dial Channels
- 20 Programmable Function Keys per channel with numeric/application keypad support
- Full 25 Line x 80 Column Supertwist Display
- Internal 300/1200 bps Auto Answer/Auto Dial Modem with **MNP\* error-correcting protocol**
- 150-19.2K bps RS-232 Port & Parallel Printer Port
- Internal 15-Hour Battery with Recharger
- VT-52/100/220 Emulation
- Compact — 7.5 lbs.; 13" x 10" x 2<sup>5</sup>/<sub>8</sub>"

#### **\$1295 Colleague PLUS also includes:**

- Full-Featured Internal Word Processor
- Data Capture/Send/Screen-Snap
- Session Record/Playback
- 65K of Non-volatile RAM Storage

#### **Also Available:**

- External Numeric/Application Keypad — \$95.00
- 2400 Baud Internal Modem — \$200.00
- Backlit Screen — \$200.00
- Ink Jet Printer
- Carrying Cases

*Evaluation Colleagues available. Call 1-800-553-6773 (in Ohio: 513-825-0880)*

581 Northland Boulevard

**Random™**  
CORPORATION

Cincinnati, Ohio 45240

© 1988 Random Corporation VT is a Registered Trademark of Digital Equipment Corp. Random and Colleague are trademarks of Random Corporation.

\*MNP is a Registered Trademark of Microcom, Inc.

CIRCLE 176 ON READER CARD

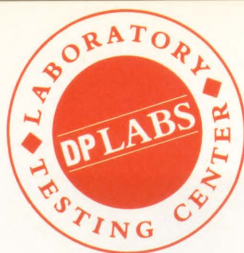

# Innovative Computer Systems' FCX

**David B. Miller**

One popular approach toward increasing free space on disks without deleting files is to compress little-used files and expand them when needed. Compressed files require fewer backup tapes and can make file transfers faster and less costly.

One such compression program is FCX from Innovative Computer Systems Inc. of Cherry Hill, New Jersey. We tested version 1.2.

VMSINSTALL is used to do the installation. You can elect to incorporate FCX files into VMS. Otherwise, all FCX files are placed in new directories. Non-integrated installation requires the execution of a startup command file each time the system is reset.

## Feeling The Squeeze

FCX is simple to use. You only need to know four commands and a few qualifiers:

**1. COMPRESS** — The COMPRESS command accepts one or more files as input and produces a single file in compressed format. Compression codes are computed for each character in the input files, and a Cyclic Redundancy Check (CRC) is generated and stored in the output file. Default extension for the output file is .FCX.

For example, the command:

```
$ FCX COMPRESS/OUTPUT=DAVE
DUAO:[MILLER]DAVE.DAT
```

compresses the file DAVE.DAT in the

[MILLER] directory and produces a compressed file DAVE.FCX in the current directory.

A number of qualifiers let you tailor the compression process. Many, such as /BEFORE, /SINCE, /CREATED, /LOG, /BLOCK\_SIZE, /BUFFER\_COUNT, /CONFIRM and /EXCLUDE, work the same as VMS qualifiers. FCX-specific qualifiers include /COMMENT, /PRESERVE and /PROCESS\_INFORMATION, which save data and DECNET node information, as part of the .FCX file. FCX qualifiers /MONITOR and /STATISTICS provide processing information in addition to what's written to a log file. The /VERIFY qualifier expands compressed files in memory and checks the CRC generated during compression. Original files can be deleted upon successful compression with the /DELETE qualifier.

The compression process can be performed directly to tape, thus avoiding an intermediate disk-to-disk compression step before copying the compressed files to tape.

**2. EXPAND** — This expands the files stored in an .FCX file. The FCX file isn't affected. The CRCs of expanded files are compared with those generated at compression time.

/SELECT and /EXCLUDE qualifiers

let you choose specific files. The /REPLACE and /NEW\_VERSION qualifiers avoid filename conflicts; files with duplicate names can be replaced with the expanded versions, or the expanded file can be given a higher version number. Output can be sent to different directories and can be given filenames other than the original. The /CONTIGUOUS qualifier attempts to place expanded files contiguously on disk. The /TRUNCATE qualifier truncates the expanded file at the end-of-file block rather than using the allocation of the original file.

Similar to file compression, expand operations can be performed directly from tape to disk.

**3. LIST** — This lists the contents of an .FCX file in /BRIEF or /FULL format.

**4. VERSION** — This determines the current version of FCX.

## Test Results

The Table reveals disk space savings of 26.0 to 50.9 percent, resulting from several types of FCX test runs. We used the /PRESERVE and /PROCESS\_INFORMATION qualifiers to save all original file information to the compressed file.

After compression, the compressed .FCX file was expanded. Comparing the

FCX Compression Statistics				
File Type	Number Blocks Before	Number Blocks After	CPU Time	Percent Space Savings
ASCII	1036	509	2:03.32	50.9%
Binary	1264	935	3:10.42	26.0%
Mixed	13335	6814	23:05.38	48.9%
Saveset	2646	1823	5:33.79	31.1%

FCX compression results for files of various types.

# Three Things You Shouldn't Have To Share At The Office

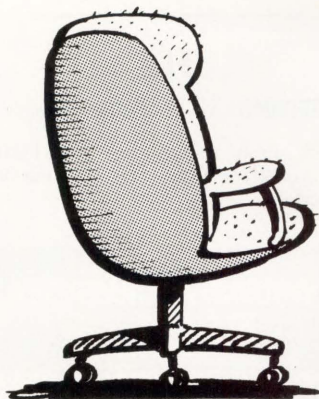

Chair



Coffee Cup

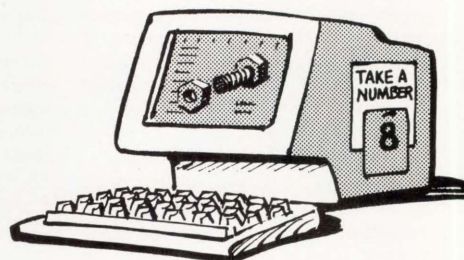

Graphics Terminal

In the workplace you would never think of sharing your coffee mug or your chair. So why are you still trotting down the hall to find out if there is a terminal available for your mainframe graphics applications? With TGRAF and your desktop computer there's no need to share a terminal; you can have powerful graphics terminal emulation right at your desk, inexpensively.

## What Does TGRAF Do For Your Desktop Computer?

TGRAF will transform your desktop computer\* into a power-packed Tektronix graphics terminal.\*\* With TGRAF you won't have to leave your desk to run your host-based business, scientific, and CAD software. Plus, you'll have the additional benefits of a PC relative to a terminal: file transfer, hot-key between DOS and your host, simplified setup with local help files, and more.

## TGRAF Gives You The Power To Communicate

Grafpoint provides you with graphics terminal emulation software that communicates through RS-232 or Local Area Networks giving your desktop computer the flexibility to communicate over a serial line or a variety of LANs.

With TGRAF's comprehensive Tektronix graphics terminal emulation and Grafpoint's superior customer support service, you can forever put the terminal sharing blues behind you. Call Grafpoint for the name of your local distributor and order a no-risk 30-day evaluation copy.



1485 Saratoga Ave., San Jose, CA 95129  
1-800-426-2230. In California 408-446-1919

**NEW!** 4200 Tektronix Series Graphics Terminal Emulation Software now available for IBM PCs and PS/2s with VGA/EGA graphics adapters.

- DEC VT220 Emulation
- Support For Extended Display List
- Support For Extended Memory
- Segment Editing
- RS-232 & Network Versions Available

\* Apple Macintosh II, IBM PC or clone, IBM PS/2 or clone, Intergraph Workstations, Silicon Graphics Workstations

\*\* Grafpoint's TGRAF will emulate the following terminals: Tektronix's 4105/4107/4109/4205/4207/4208/4115/4125 graphics terminals and Digital Equipment Corporation's VT52/VT100/VT220.

**YES!** I want to learn more about the leader in Tektronix emulation. Send me your free pamphlet "Spend Less On A Graphics Terminal."

Name \_\_\_\_\_

Company \_\_\_\_\_

Address \_\_\_\_\_

Mail Stop \_\_\_\_\_

City, State, Zip \_\_\_\_\_

Phone \_\_\_\_\_  
(Area code)

Please fill in coupon or attach your business card and mail to Grafpoint, 1485 Saratoga Ave., San Jose, CA 95129

## Introducing PVCS for VAX/VMS

### The Leading Configuration Management System.

#### Unmatched Flexibility and Price/Performance

The POLYTRON Version Control System (PVCS) simplifies and automates Configuration Management so programmers and managers can effectively control the revisions and versions of source code. Compare PVCS to DEC's CMS and Softool's CCC and you will see why PVCS is the most widely used change control product.

#### Project Control

PVCS maintains a history of revisions to a source document and allows prior versions to be recreated very quickly at any time. The "source document" can be any file written in any language. This means program source code, object code, libraries and project documentation can each be stored and maintained in an individual PVCS "archive."

#### Unmatched Flexibility

- Storage & Retrieval of Multiple Revisions of Source Code
- Maintenance of a Complete History of Changes
- Control of Separate Lines of Development (Branching)
- Resolution of Access Conflicts
- Optional Merging of Simultaneous Changes
- Release and Configuration Control
- Project Activity Reports
- Management Reports
- Command or Menu Interface

#### Fast Retrieval of Revisions

PVCS uses "reverse delta storage" which saves disk space and speeds retrieval of versions of any file in the project database. A delta is the set of differences between any revision and the previous revision. PVCS can rapidly recreate complete versions of any file whether it is the most recent revision of a module or the original version of the entire project. Differences are automatically detected and stored.

#### A Practical Necessity for Workgroups

While important for single-programmer projects, PVCS is absolutely essential for multiple-programmer projects where files are simply too easy to change. Because any change to any file can have major ramifications, coordinating and keeping a record of changes is critical. Project leaders can determine, on a module-by-module basis, which programmers can access or modify source files, libraries, object code and other files. The levels of security can be tailored to meet the needs of nearly every project.

#### Adopt PVCS on Your Existing Projects

You can obtain the benefits for your current project without disrupting development, regardless of how long your project has been underway. You can build PVCS archives from revisions stored in your present files or simply adopt PVCS from the current date.

**Personal PVCS (MS-DOS)** — Offers most of the power of Corporate PVCS, but excludes features necessary for multiple-programmer projects. \$149

**Corporate PVCS (MS-DOS)** — For managing large, multiple-programmer projects. \$395

**Network PVCS (MS-DOS)** File locking and security levels can be tailored for each project. \$995 for a 5 station LAN

**PVCS for VAX/VMS** — Uses same archive format and interface as MS-DOS versions and manages large, multiple-programmer projects. MicroVAX \$4,950, VAX 7XX \$9,500, VAX 8xxx \$10,500+

#### TO ORDER:

1-800-547-4000

Dept. DEC

Oregon & Outside USA  
Call (503) 645-1150

Send Checks, P.O.s to:  
POLYTRON Corporation  
1700 NW 167th Place  
Beaverton, OR 97006

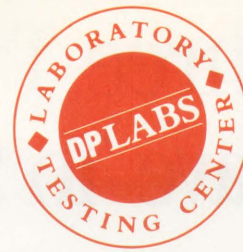

## FCX

**PLATFORMS:** Any VAX/VMS system

**PRICE:** From \$900 for the VAXSTATION and MICROVAX to \$3,000 for the VAX 8700/8800

### INNOVATIVE COMPUTER SYSTEMS INC.

#### HEADQUARTERS:

72 Crooked Lane  
Cherry Hill, NJ 08034  
(609) 779-1422

**FOUNDED:** 1980

**PRODUCT LINE:** Software, consulting services

**OWNERSHIP:** Private

CIRCLE 497 ON READER CARD

expanded files with the originals using the VMS DIFFERENCES command revealed no differences.

## Documentation

Documentation is provided in an informative user manual and installation guide. An appendix of examples proved useful to get a sampling of the various options available. The list of FCX messages contains explanations and action steps that make sense, rather than simply the error messages, which you can see for yourself anyway.

WE FOUND A BUG in version 1.1 that, under certain circumstances, trapped files in a compressed format and prevented them from being expanded. The technical support at Innovative was very helpful and quickly supplied us with a fix.

If you need file compression, here's a product that meets that need. FCX is an easy-to-use, reliable way to compress files, thus saving disk and tape storage space and reducing file transfer time. ■

## REPRINTS

If you would like reprints of any *DEC PROFESSIONAL* articles or advertisements, contact the Production Department or your Regional Sales Manager at: *DEC PROFESSIONAL*, P.O. Box 503, Spring House, PA 19477, (215) 542-7008.

**POLYTRON**  
High Quality Software Since 1982

CIRCLE 240 ON READER CARD

# What Can You Say About A VAX Utility That Recovers \$50,000 Worth Of Disk Space For Under \$5,000?

## Here's what users are saying.

"In my first ten minutes of running PAKMANAGER, I found over 100,000 blocks of recoverable wasted space. After the first week I was able to bring up the available free space on my volume set from an average of 20,000 blocks per disk to about 235,000 blocks each...PAKMANAGER paid for itself in the first day by allowing me to eliminate a pending disk purchase"

Steve Simek  
Talaris

"...With PAKMANAGER I recovered almost 15% of my disk space by being able to easily find expired files and multiple versions of files left by uncaring users."

John Smetona  
Topsville

"...PAKMANAGER really helped...This product very quickly puts on our screen all of the information we need about a particular disk, within a few seconds."

Tom Stewart  
Security Pacific Automation Co.  
Digital News, June 13, 1988

## This is what the press is saying.

"...PAKMANAGER provides a flexible, easy-to-use and powerful system to help you manage VAX disks effectively...teamed with a disk compression and defragmenting utility such as DEMAC's SQUEEZPAK, the two tools will provide a solid one-two combination to fight against disk clutter."

David Miller  
DEC Professional  
June 1988

"PAKMANAGER is a valuable tool for the system manager in the day-to-day struggle to optimize disk storage and performance. It provides a structured mechanism for displaying disk information...This easy access makes the job of disk management simpler, and provides a means for making a more timely analysis of disk problems and for taking corrective actions..."

Allan Towl  
Digital News  
June 13, 1988

**It's what we've been saying about PAKMANAGER all along. For more information, call 800-267-1590 (in CA, 800-634-6552). Ask about our free, no-hassle trial. We're anxious to hear what you have to say when you discover first-hand how PAKMANAGER saves your company time and money.**

**DEMAC**  
SOFTWARE

Excellence in System Utilities  
Suite 103, Bridge Plaza, Ogdensburg, NY 13669



**James K. Anders**

# Remote AppleTalk Communications

Remote dial-in access, commonplace in the VAX environment, enables a salesman in the field to dial in to the home office, programmers to work from home, and system managers to find out why a batch job didn't run at 3:00 a.m.

Now that Macs are being connected to VAXs in record numbers, you should consider the possibilities for remote Mac access. This doesn't mean using a Mac, modem and terminal emulator to establish a VAX terminal session. Instead, it means a remote connection to an AppleTalk network and the unique services it provides.

In other words, you can print a document on the office LaserWriter from your home, send a Mac-based mail message to a coworker or access files that reside on an AppleShare server. With software such as AlisaShare or PacerShare, this AppleShare server might be a VAX, and those files might be VMS text files that can be edited with a Mac text editor or word processor.

## First There Was AALAP

Apple never developed an asynchronous version of AppleTalk, so others performed that task. Richard Brown and Steve Ligett developed the first asynchronous AppleTalk driver at Dartmouth College.

They developed an alternate asynchronous AppleTalk driver that was installed and controlled through a Mac Desk Accessory (DA). Collectively, the driver and the DA were called Asynch AppleTalk. It allowed Mac users in the college's academic and administrative

offices to use 1,800 existing asynchronous ports and connect to the ever-growing number of AppleTalk networks at the college.

Asynch AppleTalk was implemented by developing an alternate Data Link Layer for AppleTalk. The standard Apple Data Link protocol is the AppleTalk Link Access Protocol (ALAP). Brown and Ligett developed Asynchronous ALAP (AALAP). Because of the layered, OSI-consistent implementation of the AppleTalk protocols, it was relatively easy to substitute the AALAP driver for the ALAP driver (see Figure 1).

Although Dartmouth's Asynch AppleTalk didn't become public domain software, the application and most of the source code were distributed in the same way Columbia University distributes KERMIT.

The Dartmouth program spurred the development of several commercial products to provide remote AppleTalk access. Initially, these products used the

Asynch AppleTalk DA. Third-party vendors have enhanced the functionality of the work at Dartmouth. Let's look at two products that provide this remote AppleTalk capability in different ways.

## Shiva NetModem V2400

The Shiva NetModem V2400, from Shiva Corporation of Cambridge, Massachusetts, is an AppleTalk modem that can be shared by users on an AppleTalk network. On the back panel of the NetModem V2400 there are two communications ports, an RJ-11 receptacle for the phone connection and a mini DIN-8 connector for the LocalTalk connection.

Because the NetModem resides on the LocalTalk network and serves Macs, it can be thought of as a modem server. Client Macs access the NetModem server by using the Chooser DA (see Figure 2). Although every Mac on the network can use the NetModem, only one Mac can use the services of the modem server at a given time. Shiva

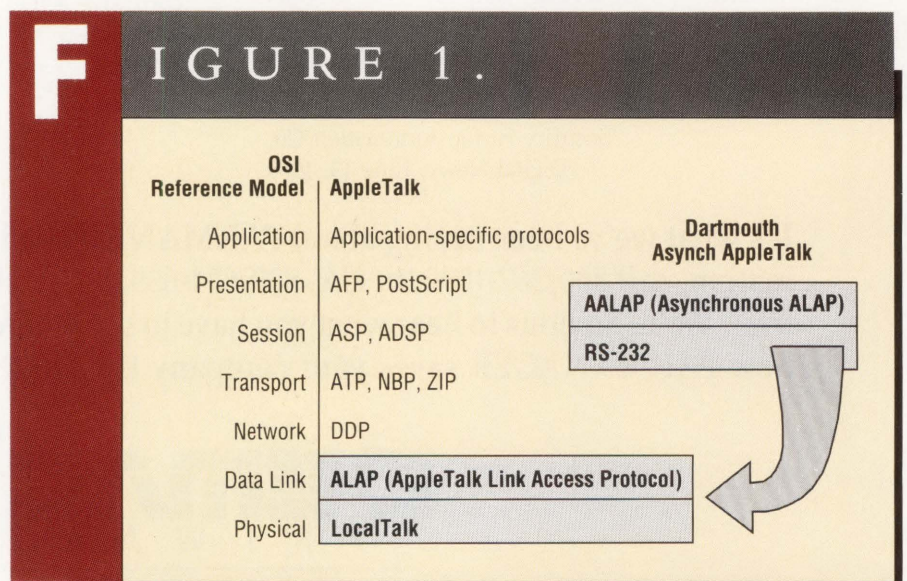

*Substitution of AALAP for ALAP in Data Link Layer of AppleTalk protocol.*



# FIGURE 2.

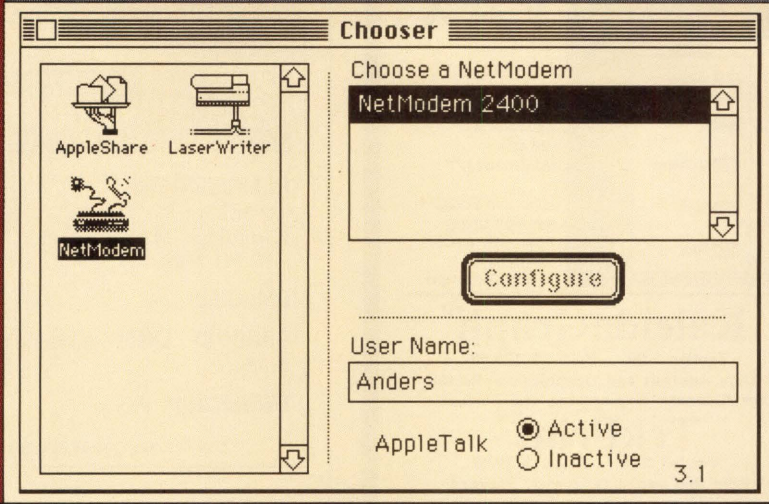

*Accessing Shiva NetModem via Chooser Desk Accessory.*

provides a NAMER utility, so each NetModem can be given a unique Chooser name.

The NetModem is an AppleTalk modem, because the actual AppleTalk protocols are handled and passed through the device. Originally, the NetModem used the Dartmouth Asynch AppleTalk DA. But Shiva has developed its own method of establishing the redirection of AppleTalk frames.

The NetModem now uses a program called Dial-in Network Access, which takes the place of Asynch AppleTalk. It permits a Mac to dial in to an AppleTalk network using a Hayes-compatible modem (see Figure 3). Other modems can be used but might require special configuration. Therefore, Shiva provides configuration and compatibility information.

The NetModem V2400 supports the use of dial-in passwords to limit remote access to the network. Shiva offers a 1,200-baud version of the NetModem that permits dial-in access but doesn't support Chooser configuring and dial-in password protection.

The Dial-In software is invoked us-

ing the Network icon on the Control Panel. The Alert Dialog screen informs you that the AppleTalk connection is about to be changed. After the dialog is confirmed, the main Dial-In Network Access screen appears.

This screen displays the available remote networks and permits you to connect to the remote network, define new connections or modify existing network information. Defining and

modifying remote networks is handled by the Dialog screen.

After you're connected to the network, you can participate in most network operations. Because the NetModem only transmits at 2,400 baud (approximately one percent of the rated speed of LocalTalk), you can do only those operations that cause minimal network traffic.

## Solana R-Server

Another approach to remote access is the R-Server from Solana Electronics of San Diego, California. Although the NetModem has a built-in modem, the R-Server is used with a separate modem. This permits the use of a high-speed (9,600- or 19,200-baud) modem.

The R-Server can be used in two ways. First, it can be configured as a remote dial-in gateway like the NetModem (see Figure 4).

For a Mac to dial in and access the remote network, Solana's asynchronous AppleTalk driver, NetAccess, first must be installed using the INSTALLER utility. You then move the VIA Folder from the installation disk into the System Folder. This folder contains predefined scripts used to access modems and configurations.

NetAccess requires the modem to

## Companies Mentioned In This Article

Alisa Systems Inc.  
221 E. Walnut St., Ste. 175  
Pasadena, CA 91101  
(818) 792-9474  
CIRCLE 405 ON READER CARD

Apple Computer  
20525 Mariani Ave.  
Cupertino, CA 95014  
(408) 996-1010  
CIRCLE 401 ON READER CARD

Digital Equipment Corp.  
146 Main St.  
Maynard, MA 01754  
(617) 897-5111  
CIRCLE 400 ON READER CARD

Hayes Microcomputer Products Inc.  
P.O. Box 105203  
Atlanta, GA 30348  
(404) 449-8791  
CIRCLE 560 ON READER CARD

Kinetics Inc.  
2540 Camino Diablo  
Walnut Creek, CA 94596  
(415) 947-0998  
CIRCLE 417 ON READER CARD

Pacer Software  
7911 Herschel Ave., Ste. 402  
La Jolla, CA 92037  
(619) 454-0565  
CIRCLE 407 ON READER CARD

File Edit Baud Settings Phone Emulation Commands

Date: (Col: 5 Row: 6) F (G) 12,61 - 2  
 Plot Form Range Window Grid Order Title Subt Labels Heading Axis Name Quit  
 Display the graph

	0	1	2	3	4	5	6	7
Homens								
Children								
Cats								
Dogs								
Nikes	23	15	15.2		15.2	21	13	
Reebok's	17.2	17	9.35		9.35	15.2	15	
Adidas	12.5	23			9	10.5	21	
Dr. Brooks	24	25	13		13	22	23	
Converse	19	33	21		21	16	31	
Pro-Keds	33	35	23		23	31	33	

**Mac to VAX**  
 Terminal Emulation/Communications Software for the Macintosh™  
 Example 20/20™ session using Tektronix 4105 emulation.  
 Access Technologies

---

**VersaTerm™**  
 Version 3.20 Price: \$ 99.00  
 DEC VT100/102, DG D200, Tek 4014 emulation.  
 Kermit, XModem and YModem protocols.

**VersaTerm-PRO™**  
 Version 2.20 Price: \$ 295.00  
 Vector-oriented, Tektronix 4105 color graphics emulation... in addition to all the features of standard VersaTerm 3.2.

**KaleidaGraph™**  
 Version 1.00 Price: \$ 179.00  
 A Data Analysis and Graphics Application for Business, Engineering and Science.

**TekPrint™**  
 Version 2.00 Price: \$ 79.00  
 Utility that supports Hewlett Packard 7470 and 7475 Pen Plotters.

*All Programs are Macintosh II and SE Compatible. All Programs Utilize Color on the Mac II.  
 VersaTerm, VersaTerm-PRO and TekPrint Execute in the Background with the MultiFinder!  
 VersaTerm-PRO and KaleidaGraph Make Use of Big Screen Monitors.*

Designed for a 512K Mac, Mac-XL, 512E Mac, Mac Plus, Macintosh SE and Macintosh II. All Support the ImageWriter(I & II) and LaserWriter printer.  
 The following are trademarks: Macintosh, AppleTalk, MultiFinder, ImageWriter, LaserWriter - Apple Computer Inc.; Tektronix - Tektronix Inc.; DEC, VAX, VT100 - Digital Equipment Corp.; DG, D200 - Data General Corp.; AisaTalk - Aisa Systems; VersaTerm, VersaTerm-PRO, TekPrint, KaleidaGraph - Abelbeck Software

Published and Distributed by: **PCS Inc.** 2457 Perkiomen Avenue, Reading, PA 19606 (215) 779-0522  
 Developed by: **Abelbeck Software**

CIRCLE 242 ON READER CARD

## People are talking about us.

"This is a very good implementation of FORTRAN, better than the one I use on my minicomputer system." *IEEE Software*

"Lahey F77L is definitely for the programmer's market, with features for the casual and professional user...*EDITOR'S CHOICE*" *PC Magazine*

"It is a fantastic product." *PC Australia*

"It should be the last FORTRAN compiler you will need to buy..." *Your Computer*

"Lahey F77L was by far the easiest compiler to use..." *Programmer's Journal*

"Compilation speed is Lahey FORTRAN's most remarkable feature; it is unbelievably fast...Realistically, Lahey FORTRAN is the most efficient and productive FORTRAN development tool for the DOS environment..." *Byte*

**When people talk about FORTRAN the name mentioned most often is**

**Lahey**  
 Computer Systems Inc.

Contact us to discuss our products and your needs. (800) 548-4778  
 Lahey Computer Systems, Inc. P.O. Box 6091, Incline Village, NV 89450  
 Tel: (702) 831-2500 FAX: (702) 831-8123 Tlx: 9102401256

CIRCLE 192 ON READER CARD

## NetModem V2400

**PLATFORMS:** AppleTalk network  
**PRICE:** \$599

### SHIVA CORP.

**HEADQUARTERS:**  
 222 3rd St., Ste. 1200  
 Cambridge, MA 02142  
 (617) 661-2026

**FOUNDED:** 1985  
**PRODUCT LINE:** AppleTalk network products  
**OWNERSHIP:** Private

CIRCLE 441 ON READER CARD

be connected to the modem port of the Mac. NetAccess is invoked via the Network icon on the Control Panel. An Alert Dialog appears to inform you that the AppleTalk connection is about to be changed. After the dialog is confirmed, the NetAccess connection window appears.

A Password screen appears when you press the Connect button. If a password has been defined for the intended R-Server, you must enter a name and password to complete the connection. If no password has been defined, ignore the information on the Password screen.

If the New or the Modify button on the NetAccess connection window is pressed, another screen appears referencing new network names, phone numbers, baud rates and alternate VIA scripts.

The second approach involves two R-Servers. When two R-Servers are used, they can be configured as an AppleTalk half-bridge (see Figure 5). The AppleTalk specifications permit three kinds of bridges. A local bridge connects one network to another, a backbone bridge connects an AppleTalk network to a common backbone such as Kinetics' FastPath and Ethernet, and a

# APPLE AND DIGITAL ARE GIVING EACH OTHER A LOT OF BACK TALK.

And they owe it all to Alisa.

Because our total software networking solutions made it possible for Macintosh and VAX to talk back and forth over the same network. And we still do it better than anyone else. TSSnet™ is a case in point.

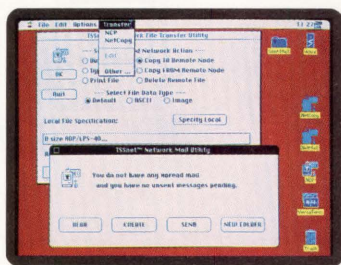

It's a software package that lets Macs communicate with DECnet networks as Phase IV end nodes.

It provides a complete set of DECnet services, including the all-important back-

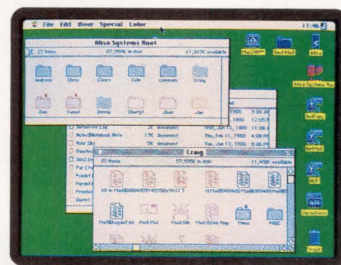

ground "objects" for VMS Mail and file access (FAL).

And TSSnet uses standard EtherTalk hardware or serial async lines. All this, and it runs concurrently with AlisaTalk™. Then there's SequeLink™. A set of software tools that gives Macs host-style access to SQL databases.

It exports native SQL to Macs as remote procedure calls. Permits existing SQL statements to be used on workstations. And even supports RDB/VAX SQL and Oracle.

So call or write to us at Alisa Systems. We'll tell you more about our total networking solutions.

And show you how to make Apple and DEC talk back to each other.



**Alisa Systems Inc.**  
We keep everybody talking.



Alisa and AlisaTalk are trademarks of Alisa Systems, Inc. Apple and Macintosh are trademarks of Apple Computer, Inc. DEC, VAX, VMS, and DECnet are trademarks of Digital Equipment Corp. TSSnet is a trademark of Thursty Software Systems. SequeLink is a trademark of GrOsls.

221 East Walnut Street, Suite 175  
Pasadena, CA 91101 (818) 792-9474

CIRCLE 247 ON READER CARD

# F I G U R E 3 .

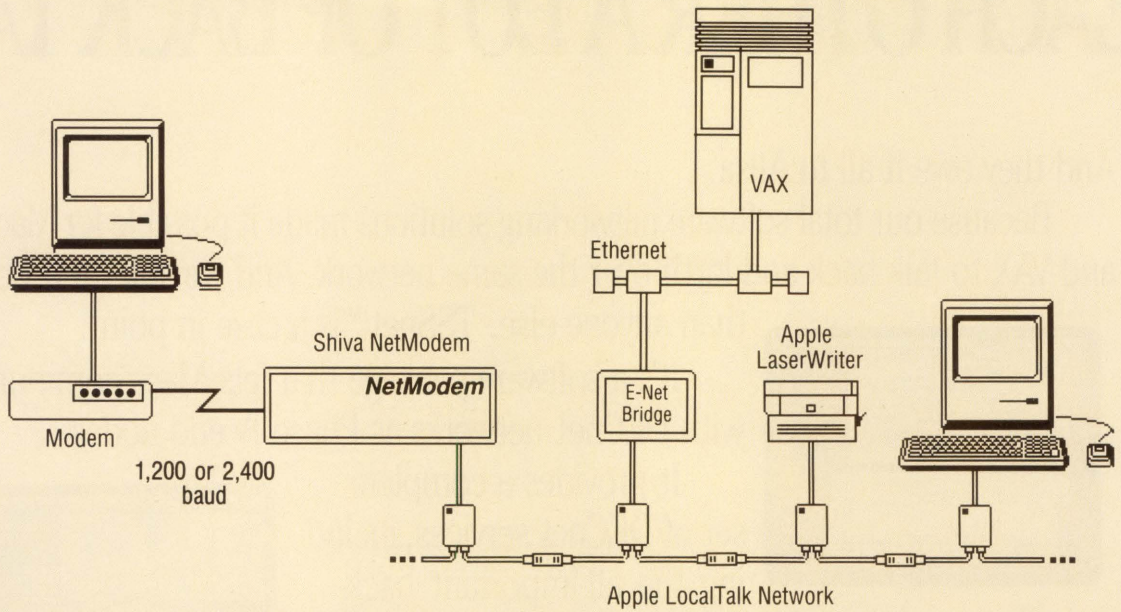

*Remote dial in to an AppleTalk network via Shiva NetModem.*

# F I G U R E 4 .

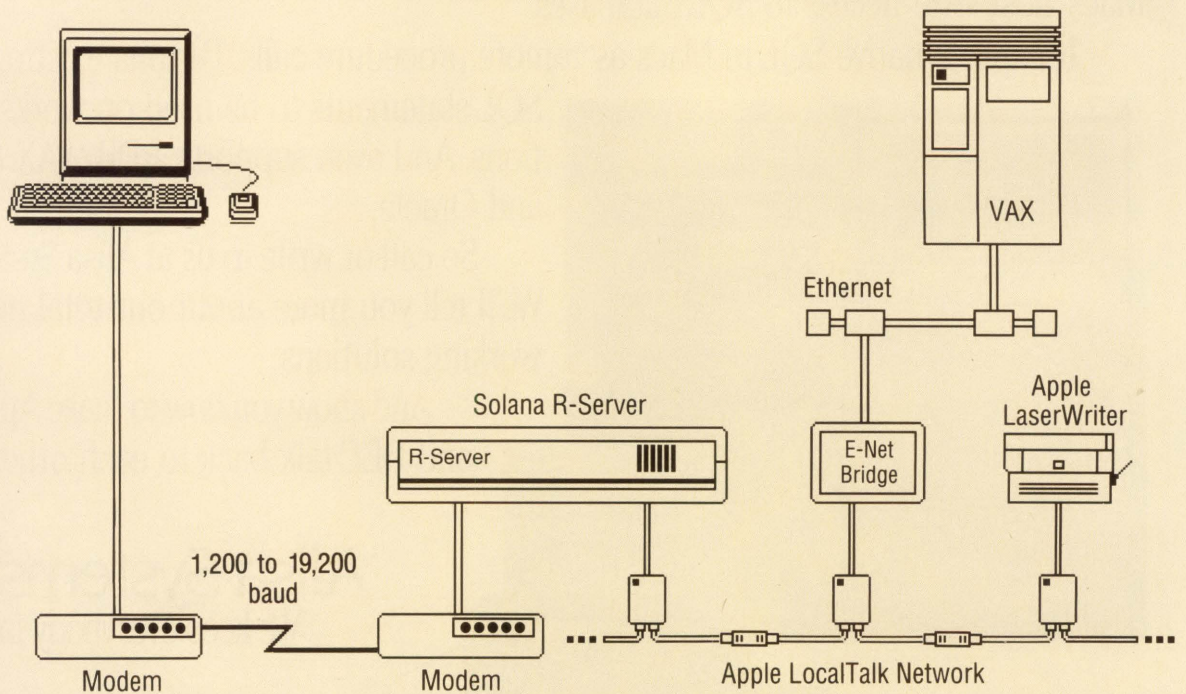

*Remote dial in to an AppleTalk network via Solana R-Server.*

# FIGURE 5.

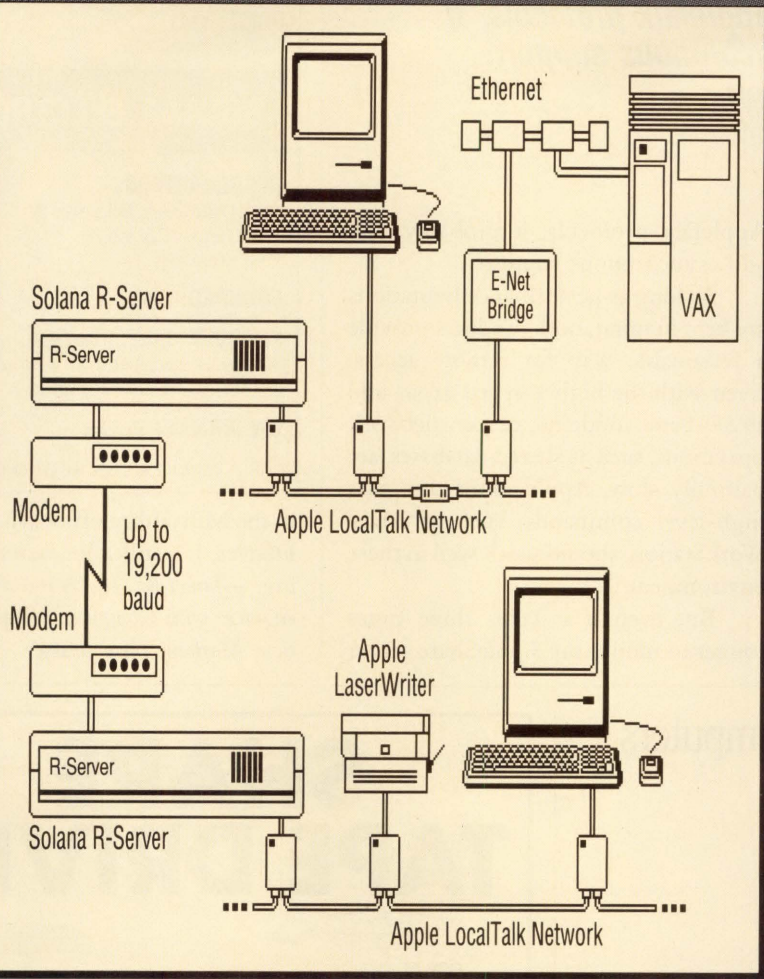

*Two Solana R-Servers configured as an AppleTalk half-bridge.*

half-bridge joins two networks by connecting two bridges over a communications line.

When R-Servers are used in this manner, configuration is more complicated. Each port on the R-Server must be assigned a unique AppleTalk network number, and zone names must be assigned. These zone names can be the same or different. With this technique, users on each side of the half-bridge can access the services (such as AppleShare file servers and LaserWriters) offered on the other side simply by using the Chooser.

The R-Server uses the R-Server Manager program. If you have access to the program, you can view the current network configuration, but you need a password to make changes.

The R-Server has levels of security not present in standard AppleTalk networks. For instance, using the Manager program, you can specify up to five zones that remote users can access. Zones absent from the list are hidden from the user. Network traffic that might be routed through those zones is unaffected.

In addition to zone security, the network manager can implement user passwords. These passwords provide an

## VAX FORTRAN on your desk?

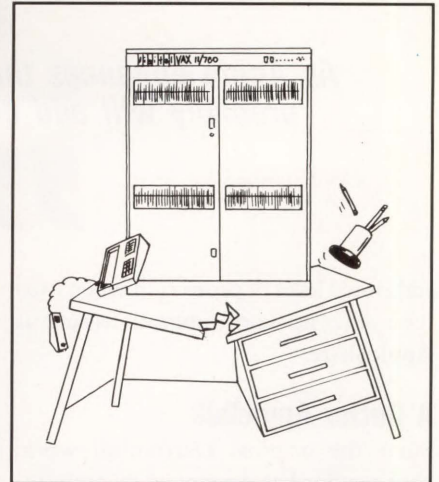

**Yes!**



with  
**Language Systems  
FORTRAN**  
and a  
**Macintosh II**

VAX-compatible extensions, high precision IEEE floating point data types and the friendly Macintosh user interface make this the best FORTRAN for your desktop.

**LANGUAGE  
SYSTEMS**  
CORPORATION



441 Carlisle Drive, Herndon, VA 22070  
(703) 478-0181

**Language Systems FORTRAN —  
the power to do it at your desk.**

Requires hard disk and Macintosh IIx, II, SE or Plus

**CIRCLE 294 ON READER CARD**

“  
**As Apple enhances the AppleTalk protocols, it probably will add asynchronous support.**  
 ”

additional level of protection when used with other network applications such as AppleShare.

### A Better AppleTalk

Since the original Dartmouth work, each vendor has developed its own implementation and software for its product. But problems can arise if you attempt to use these products together. In light of the recent Apple/DEC agreements, it doesn't make sense for each vendor to implement its own asynchronous drivers. As Apple enhances the

AppleTalk protocols, it probably will add asynchronous support.

As long as performance limitations are kept in mind, both products provide a reasonable way for remote access. Even with the higher-speed 9,600- and 19,200-baud modems, certain network operations, such as shared databases, are painfully slow. Applications that pass high-level commands, such as Mac-WorkStation, should work well in these environments.

But even if it takes three times longer to mount the AppleShare server

**R-Server**

**PLATFORMS:** AppleTalk network  
**PRICE:** \$595

**SOLANA ELECTRONICS**

**HEADQUARTERS:**  
 7887 Dunbrook Rd., Ste. A  
 San Diego, CA 92126  
 (619) 566-1701

**FOUNDED:** 1982

**PRODUCT LINE:** Various products for AppleTalk networks, as well as multiplexers for mainframe computers

**OWNERSHIP:** Private

CIRCLE 442 ON READER CARD

in the Milwaukee office when you're in Denver, it's still a lot faster than driving. —James K. Anders is a senior software engineer with Computer Methods Corporation, Marlton, New Jersey.

This is two of the best computers on the market.



**It's a Macintosh, of course.** But it's also a VAX. Thanks to a family of products from White Pine Software, Macintosh and VAX computers can communicate. These include emulators that allow the Macintosh to appear to a VAX exactly like a DEC terminal. And Reggie, which converts Macintosh graphics into DEC formats (ReGIS and SIXEL) for use by VAX applications or output devices.

And VMacS, which allows users to store and manage Macintosh files on the VAX's hard disks and tape drives.

For more information call or write: White Pine Software, 94 Route 101A, PO Box 1108, Amherst, NH 03031, (603) 886-9050.



CIRCLE 226 ON READER CARD

# SHARE TAPE DRIVES

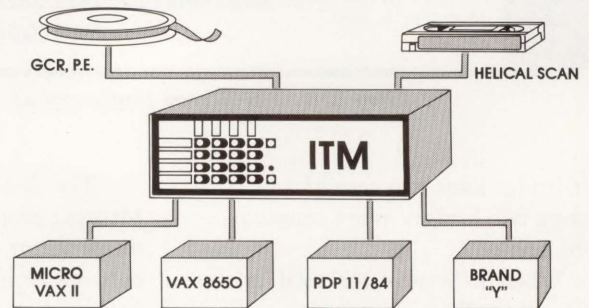

## IVERSON TAPE MANAGER (ITM)™ DIGITAL TAPE SWITCH

- Switch 2 to 8 CPUs between 1 to 4 Tape Drives
- Mix Tape Drives, GCR, PE, Helical Scan
- Mix CPU Types, VAX, PDP, Sun, IBM
- Save Dollars and Floor Space
- Increase Tape Subsystem Flexibility
- Increase Distance between CPU and Tape



**iverson, inc.**  
 One Saunders Avenue  
 San Anselmo, California 94960  
**(415) 459-5665**

CIRCLE 298 ON READER CARD

# FastPath 4 from Kinetics

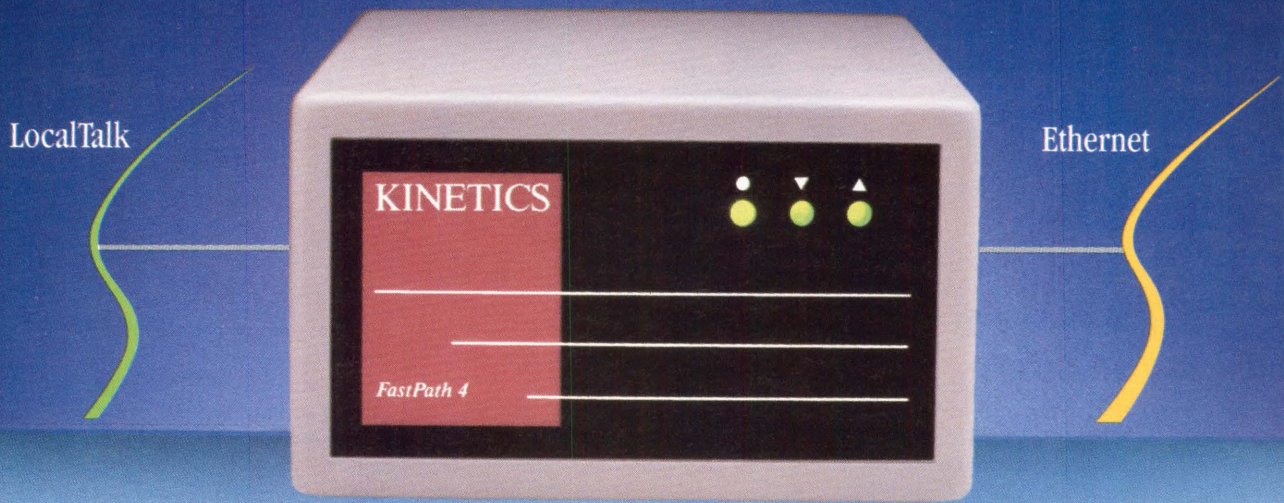

## It's the Same.

It's FastPath, the standard in Macintosh-to-Ethernet networking, with thousands installed and years of success.

### Connect LocalTalk to Ethernet

FastPath connects a network of Macintoshes, LaserWriters, and other LocalTalk devices to Ethernet at the lowest cost per connection.

### Access Diverse Systems

FastPath ties together multiple computers in multiple environments, including VAXes, UNIX systems, PCs, and Macintoshes. In fact, it is the key building block in Mac-DEC connectivity.

### Use Multiple Applications and Multiple Protocols

FastPath supports TCP/IP, allowing all Macintoshes to participate in multivendor networking systems. FastPath is the standard internetwork connection for scores of networking applications from mail to databases to printing to file transfer to terminal emulation to ... everything.

## It's Different.

It's FastPath, but now it's even more. The new FastPath 4 is easy to install and more powerful.

### Plug and Play

FastPath's AppleTalk-bridging automatically self-configures right out of the box. Or you can use optional IP network management tools from either the Ethernet or LocalTalk side.

### Use Sophisticated IP Networking

FastPath's new K-STAR routing makes TCP/IP configuration and operation as easy as AppleTalk. (The FastPath 4 provides simultaneous AppleTalk bridging and TCP/IP routing.)

### Expand Your Options

With a 5-fold increase in memory, you can run sophisticated networking software through the FastPath 4 on the busiest networks. You can observe and diagnose network activity. You can connect to either thin-wire or standard Ethernet from the same unit. With Kinetics EtherPort direct Mac-to-Ethernet cards, you have mix-and-match flexibility in network configuration.

More power, more connections, more choices.

## The Best-Connected Macintosh Begins Here.

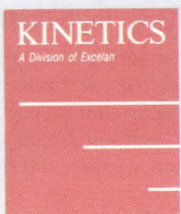

For more information on connecting your Macintoshes to Ethernet, call Kinetics at 800-433-4608 outside California, 415-947-0998 in California.

Kinetics, Inc. 2540 Camino Diablo Walnut Creek California 94596

# PRODUCTS

## Viking Trader Provides Ample Screen Space

Moniterm Corporation announced its Viking Trader high-resolution display system for large-screen, multitasking applications in the stock trading community. The Viking Trader monitor is for IBM PCXT, IBM PS/2, Mac and Microsoft Windows operating environments.

The 19-inch display eliminates the need for more than one computer and monitor and provides the screen space for the Microsoft Windows/386 operating system to display and edit several programs simultaneously. Some of the programs that can be used are Lotus 1-2-3, Stratus Host Session and VAX or DEC Host Session.

The various programs can be run directly or linked with other computer systems via Ethernet or another networking system.

For more information, contact Moniterm Corp., 5740 Green Circle Dr., Minnetonka, MN 55343; (612) 935-4151.

Circle 515 on reader card

## Taneum Modifies Printer To Emulate LG01

Taneum Computer Products has announced line printers with speeds from 800 lpm to 1,200 lpm that are modified to emulate the LG01 line printer. The TCP 660/690 printers are Mannesmann Tally 600-Series machines

that are modified to respond to DEC command codes.

The TCP 660/690 printers use dot-matrix technology to provide data processing output as well as letter quality, different font sizes, block characters, bar codes and business graphics. The units emit less than 60dB(A).

The TCP 660 at 800 lpm sells for \$8,990. The TCP 690 at 1,200 lpm sells for \$11,990. For further information, contact Dave del Valle, Taneum Computer Products, 1123 Maple Ave. S.W., Renton, WA 98055; (206) 228-5956.

Circle 512 on reader card

## DFM Links INTERMEC With VAX/VMS

INTERMEC Corporation announced Data Flow Manager (DFM), a program that links INTERMEC data collection devices with applications in a networked VAX/VMS environment.

DFM is a simple and flexible tool to manage the data collection process independent of the application. Coupled with DEC platforms and INTERMEC data collection devices, DFM provides a data collection solution without being embedded in the application. For example, on a networked MicroVAX, DFM can serve the data collection needs of various applications over DECnet. When new applications are implemented, the user just adds the appropriate application interface.

For further information, contact Geoffrey Abadian, INTERMEC Corp., 4405 Russell Rd., P.O. Box 360602, Lynnwood, WA 98046-9702; (206) 348-2600.

Circle 517 on reader card

## LIBRA Upgrades Account Payable System

LIBRA Corporation has announced release 1.8 of its Account Payable System. The product features an alternate payee/miscellaneous vendor capability that lets you set up any number of miscellaneous vendors and then

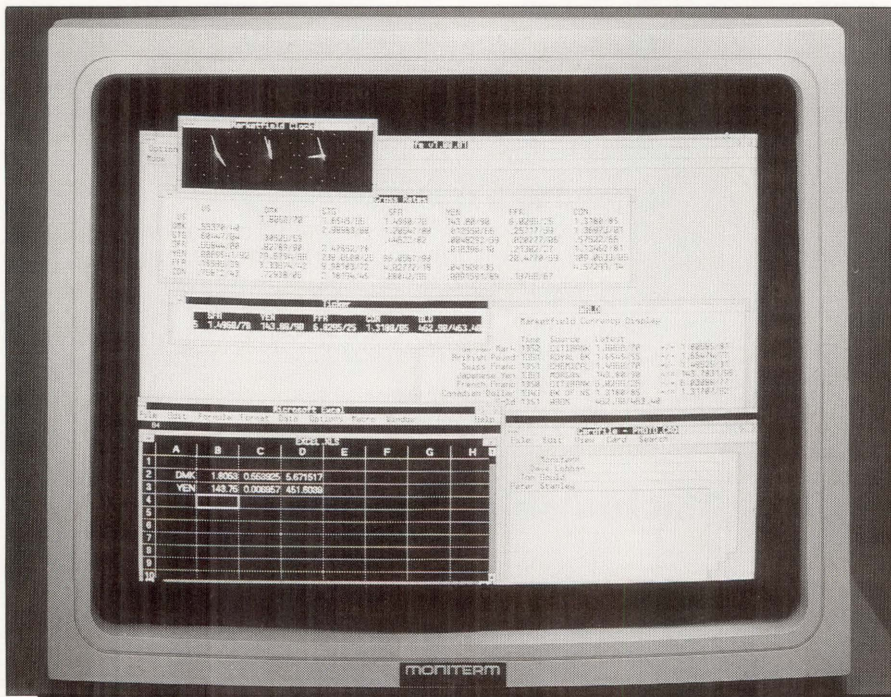

Moniterm Corporation's Viking Trader high-resolution monitor.





*CIS Graphics Inc.'s Dimension 6 control ball.*

enter invoices for these vendors with separate payees for each invoice. It also features payroll checks passed to accounts payable. Payroll checks can be reconciled in the same way that A/P checks are reconciled.

Other enhancements include multiuser maintenance and posting, menu bars on all menu selection screens, larger dollars retained, purchase and terms discount analysis, cash accounting, in-process messages, voided checks retained, ID look-up and database security.

LIBRA systems are available for multiuser processing when run on VAX computers.

For additional information, contact Garth C. Weber, LIBRA Corp., 1954 E. 7000 S., Salt Lake City, UT 84121-3094; (800) 453-3827.

**Circle 531 on reader card**

## Control Ball Is For 3-D Graphics Systems

CIS Graphics Inc. introduced a force/torque graphic control ball that provides users with natural, intuitive manipulation of screen objects on 3-D graphics systems. The Dimension 6 allows a closer interface between user and computer by overcoming the 3-D manipulation limitations of conventional graphics tablets, mice, trackballs, knob boxes and joysticks. It uses infrared optical sensor technology and allows complete control in real-time of graphically simulated 3-D objects by the user with one hand as well as affording him total concentration on the screen object.

Any graphics system or host computer can be enhanced via simple connection

through an RS-232C interface. It's also suitable for 3-D applications. Function buttons for rotation, translation and domination motion directions are provided along with user-programmable settings for easy object sensitivity and speed control.

To find out more, contact Sandra Lacoss, CIS Graphics Inc., Two Robbins Rd., Westford, MA 01886; (508) 692-9599.

**Circle 559 on reader card**

## Graphic Outlook Interfaces To ALL-IN-1

Stone Mountain Computing Corporation has announced release 5.0 of Graphic Outlook. The product allows worksheets with unlimited rows and columns, and features a fully integrated interface with the ALL-IN-1 system. With the optional ALL-

IN-1 interface, users can mail spreadsheets, access the Interrupt Menu, Scratchpad and other ALL-IN-1 functions, and use familiar ALL-IN-1-style menus for worksheet selection and retrieval.

Graphic Outlook directly reads DATATRIEVE databases as well as many forms of ASCII files and includes an implementation of the Simplex Algorithm for solving Linear Programming problems.

Two-user and six-user licenses are available for Graphic Outlook at reductions from the single-CPU, unlimited-use license fee.

For a demonstration tape, contact Bob Else, Stone Mountain Computing Corp., P.O. Box 1369, Goleta, CA 93116; (805) 968-3838.

**Circle 554 on reader card**

## RealWorld Converts Software For VAX

RealWorld Corporation has converted its accounting software products for use on VAX/VMS. The 11-package system will be marketed through RealWorld's network of VADs and VARs.

The RealWorld VAX accounting system includes accounts receivable, accounts payable, general ledger, payroll, order entry/billing, purchase order, inventory control, sales analysis, job cost, check reconciliation and professional invoicing.

The price for VAX object code versions is \$2,500 per module.

For additional information, contact Larry Wilber, RealWorld Corp., 282 Laudon Rd., P.O. Box 2051, Concord, NH 03302-2051; (603) 224-2200, ex. 366.

**Circle 556 on reader card**

## 20/20 WP Connection Allows Seamless Bridge

Access Technology Inc. announced the availability of the 20/20 Word Processing

## New DEC Time, New DEC Number

You now can dial in to DEC's free on-line service center beginning at 7:00 a.m. Eastern Standard Time. Further, DEC has added a toll-free number for its Electronic Store. You can use any of the following to access the Store:

- (800) 289-2424 (new)
- (800) 332-3366
- TYMNET

To obtain a local TYMNET access number to the Electronic Store, dial (800) 336-0419.

You can dial in to DEC using any of the above numbers and a 1,200- or 2,400-baud modem and a VT100-compatible terminal. Set terminal characteristics for 8 bits per character with no parity. Upon connection, follow the instructions on your terminal screen.

For additional information, contact DEC, 485/3 Tech Center, 199 Riverneck Rd., Chelmsford, MA 01824-2820; (508) 250-7743.

**Circle 507 on reader card**

Connection for VAX. The 20/20 WP Connection provides a seamless bridge between 20/20 and several leading WP software programs used on DEC computers, specifically MASS-11, WordPerfect, WordMARC and WPS-Plus (DX format).

With the WP Connection, information exchange is accomplished with simple keystrokes. The 20/20 WP Connection reads WP documents in their native format. Therefore, there's no need to create files to pass information between 20/20 and WP documents.

Prices range from \$600 for the MicroVAX 2000 to \$11,500 for the VAX 8978. Multiple machine discounts and corporate licensing programs also are offered. For more information, contact Geoff Spillane, Access Technology Inc., 6 Pleasant St., S. Natick, MA 01760; (508) 655-9191.

**Circle 570 on reader card**

## ONSPEC/LOTUS 1-2-3 Permits Access

The ONSPEC/LOTUS 1-2-3 Real Time Interface, from Heuristics Inc., combines Lotus 1-2-3 with add-in functions for interfacing into ONSPEC Control Software Data Tables.

This package permits the user to access any ONSPEC data variable, for use in calculations, on a real-time basis. Calculation results can be fed back to ONSPEC, I/O Templates or other packages or drivers.

In addition to ONSPEC 386, ONSPEC versions are available for 286 machines like the IBM AT, and VMS machines like the MicroVAX II.

Obtain more information by contacting Donna L. Terp, Heuristics Inc., 9845 Horn Rd., Ste. 170, Sacramento, CA 95827; (916) 369-6606.

**Circle 504 on reader card**

## CorrecText Detects And Corrects Errors

Houghton Mifflin Company announced CorrecText Grammar Correction System, a software program that analyzes documents for errors in grammar, punctuation, style and spelling. CorrecText, which will be offered as VAX Grammar Checker by DEC, uses artificial intelligence techniques to grammatically analyze word and sentence structure and identify the grammatical functions and relationships among words. It detects and corrects a wide range of errors in syntax, usage,

punctuation, style, capitalization, hyphenation and spelling.

DEC's implementation of CorrecText, which runs in any VAX/VMS environment and is offered with WPS-PLUS/VMS V3.0 word processing software, has been designed for writers of business and technical documents.

Find out more by contacting Denise L. Widman, Houghton Mifflin Co., One Beacon St., Boston, MA 02108; (617) 725-5022.

**Circle 501 on reader card**

## RGB Technology Enhances Videolink

RGB Technology has enhanced its RGB/Videolink line of scan converters with a PAL video output option for compatibility with European television standards. The RGB/Videolink converts high-resolution computer graphics to television (NTSC) video for videotaping, video projection or video transmission. It offers line averaging, full color and real-time performance.

The RGB/Videolink requires no software modifications and doesn't affect performance of the host system of its RGB monitor. Models of the RGB/Videolink are

**NEW**

**RP07 HDA  
AND  
8470 HDA**

## REPAIR/EXCHANGE

- Immediate Shipment From Stock
- All New Improved Media
- Fully Tested Prior To Shipment
- 90 Day Warranty
- 16 or 18 Bit Format
- Units Qualified For Unix & D-Prep

**\$2,690**

**CIRCLE 348 ON READER CARD**

**DATASAT**

10072 Willow Creek Road  
San Diego, CA 92131  
(619) 566-3371  
FAX: (619) 566-4743

**IMPROVED**

**TPTool**

**A NEW DAY IS DAWNING.**

It's the beginning of a new era for VMS text processing... the era of affordable software to meet the demanding needs of VMS computer users. You no longer have to choose over-featured software at over-inflated prices; TPTool is here!

TPTool is a flexible text processing and printing utility that allows users to create sophisticated documents, memos, and correspondence while still using their favorite VMS text editor. A rich set of features provides more than 80% of standard word processing capabilities at a fraction of the price.

Now you have an alternative to costly, full-blown word processors.

Judge for yourself whether these and other features will make TPTool the practical alternative for you:

- ◆ Pagination, margin control, multiple fonts, headers, footers, footnotes, and automatic hyphenation
- ◆ Micro right-justification, table of contents, indexing, sections, and connected line-drawing characters
- ◆ Direct output to VMS print queues, terminal printer ports, or printers on VAX terminal ports
- ◆ Extensive built-in printer support
- ◆ Customizable to virtually any printer
- ◆ Priced from \$345 to \$1295 per CPU
- ◆ Free on-line demo available

TPTool is a product of:

**GENERAL RESEARCH CORPORATION**

For further information contact:

**GrayMatter Software & Consulting**

(206) 281-8800

©1988 GrayMatter Software & Consulting, Inc. TPTool and GRC logo are trademarks of General Research Corporation. VAX and VMS are trademarks of Digital Equipment Corporation.

**CIRCLE 278 ON READER CARD**

DEC PROFESSIONAL

available for systems from Hewlett-Packard, DEC, IBM and others.

For further information, contact Carol Fogel, RGB Technology, 3684 Hastings Ct., Lafayette, CA 94549; (415) 284-4330.

**Circle 503 on reader card**

## Mail Call-EM Enhances ALL-IN-1 E-Mail

Cappcomm Software Inc. announced Mail Call-EM, designed to enhance the E-Mail capability of ALL-IN-1 by using the full power of each PC. Mail Call provides a totally secure, off-line E-Mail application that allows users to create, edit, address and fully manage their mail directly on their PC.

Users create their correspondence using their own word processing software, integrated into Mail Call, or Mail Call's own mail editor. Mail Call connects to the VAX only for the actual exchange of mail.

Mail Call is sold by site distribution license. Prices range from \$900 for a VAX 11/730 to \$16,400 for a VAX 8800. Mail Call's single site price translates to \$30 per user cost, which decreases as PC population grows.

For further information, contact Cappcomm Software Inc., 26 Journal Sq., Ste. 1003, Jersey City, NJ 07306; (201) 795-1500.

**Circle 508 on reader card**

## Calendar Manager V3.1 Automates Scheduling

Russell Information Sciences Inc. has introduced Calendar Manager V3.1, which features enhancements to further automate the scheduling process. Maintaining its data-free entry format, Calendar Manager lets you schedule meetings without typing in dates, times or agenda items. Simple cursor movements select the details of a meeting. Schedules of attendees, resources and facilities are searched, and conflicts automatically resolved.

Calendar Manager provides a powerful alternative to the pocket calendar and is suited for office environments, including Macs and PCs connected to the VAX world.

Available in both VMS standalone as well as A-to-Z integrated versions, Calendar Manager fully supports DECnet and VAXcluster environments, and is priced from \$1,295 to \$6,395 (plus documentation).

For more information, contact Bill George, Russell Information Sciences Inc., 26552 Wild View Terrace, Laguna Hills, CA 92653; (714) 855-4337.

**Circle 505 on reader card**

## Toolpack 2.4 Introduced For FORTRAN

Integrated Systems Technologies Inc. has introduced Toolpack 2.4, a suite of FORTRAN programming tools. The tools facilitate FORTRAN code debugging, maintenance, portability and development. The tool suite includes a Pfort 77 ANSI-standard verifier.

The cost of the software is \$500 and is available for UNIX, VMS and IBM systems. For more information, contact Tom Caffery, Integrated Systems Technologies Inc., 1555 Sherman, Ste. 220, Evanston, IL 60201; (312) 869-3038.

**Circle 506 on reader card**

## CD Real-Time Systems Enhances PowerPlan Plus

CD Real-Time Systems Inc. has announced its lot and serial number control and track-

## EDIX = POWER EDITING

*"EDIX is better than EDT or Emacs. This program combines ease-of-use with advanced features."*

- EDIX is faster than EDT or Emacs
- Uses less disk space and memory than EDT or Emacs
- VMS/ULTRIX/DOS compatible
- Broadcast message capture
- Multiple windows/multiple buffers
- Any window can operate as a virtual terminal
- Subprocess execution with standard output capture
- Customizable
- Multiple keyboard definitions
- On-line help and tutorials
- Free technical support, no maintenance fees

Call for pricing and free demo. Ask about our special University and Corporate discount programs.

**EMERGING**  
TECHNOLOGY

Emerging Technology  
3405 Penrose Place  
Boulder, CO 80301  
303-447-9495 FAX 303-447-9241

**CIRCLE 338 ON READER CARD**

## Unlock Programmer Productivity

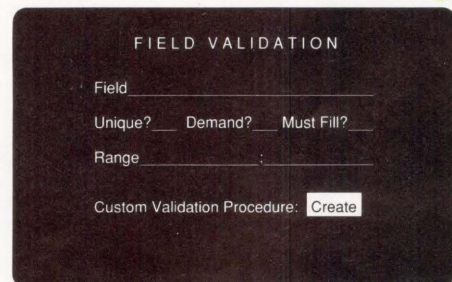

## With System 1032 Application Facility

System 1032/AF automatically generates most of your application code from menu selections. Yet you can add custom procedures wherever you need something special.

**CompuServe**  
Data Technologies  
Tel: (617) 661-9440

**CIRCLE 111 ON READER CARD**

INTERLAN INTRODUCES  
THE NETWORKING SOLUTION  
THAT DEC OVERLOOKED

# LAT AND TCP IN ONE TERMINAL SERVER

Announcing INTERLAN's LAT/TCP Terminal Server – a universal, dual-protocol networking product for less than the price of single protocol servers, like DECserver 200.

Now you can establish multiple sessions to both LAT and TCP/IP hosts – simultaneously.

The new LAT/TCP dual-protocol FEATUREPAK® – a plug-in software cartridge for INTERLAN NTS 100/200 Terminal Servers – supports all LAT connections, via LAT Directory Services. From the same terminal, you can also connect to any host running TCP/IP via TELNET or RLOGIN, with support for up to 64 virtual circuits per server. INTERLAN gives you a window into applications you couldn't even access before.

The high performance of LAT. The versatility of TCP/IP. Both for less than the price of either one. INTERLAN's

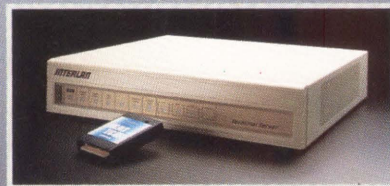

LAT/TCP Terminal Server is the networking solution you can't afford to overlook.

Call 1-800-LAN-TALK, Operator 1074, for immediate information. In Massachusetts, call 1-800-TELL-LAN.



**INTERLAN**

DEC and DECserver 200 are registered trademarks of Digital Equipment Corporation; FEATUREPAK® and INTERLAN are registered trademarks of INTERLAN, INC. GSA pricing available.

CIRCLE 140 ON READER CARD

**DEC  
Resellers  
Call for our  
Special Demo  
System Pricing**

ing (C&T) feature for its PowerPlan Plus MRP II software for the VAX.

The C&T feature lets users assign lot and serial numbers and use these numbers to track the production history of any batch, lot or individual production item. It lets users document the history of component parts and materials by vendor, lot, number, date received, purchase order and other parameters. This is the newest enhancement in PowerPlan Plus MRP II software, a system of 13 on-line, interactive manufacturing/financial/planning modules.

To learn more, contact CD Real-Time Systems Inc., P.O. Box 513, St. Charles, IL 60174; (312) 377-2625.

Circle 509 on reader card

## DataLynx/3174 Allows Dual-Host Access

Local Data Inc. has announced a software package with the DataLynx/3174 BSC protocol converter. It's available to current users of the DataLynx as a product update.

Async passthrough capabilities provide network flexibility by allowing async terminal users to access their IBM mainframe

through protocol conversion of their ASCII minicomputer through a straight ASCII passthrough mode. Further, an IBM mainframe can exchange files with an ASCII minicomputer while the DataLynx handles protocols, flow control and data translations.

The DataLynx/3174 protocol converter is available in four-port to 32-port models and is field upgradable. Pricing is \$3,000 to \$10,000, depending on configuration.

Obtain more information by contacting Julie Dickson, Local Data Inc., 2771 Plaza Del Amo, Torrance, CA 90503; (213) 320-7126.

Circle 510 on reader card

## BBMASTER Interfaces Multiple VMS Processes

LANTEK has announced BBMASTER, a high-performance industrial-control network interface for MicroVAXs and VAXs. Including both a Q-bus hardware module and a multilayer software architecture, BBMASTER interfaces multiple VMS processes running on the host VAX to multiple slave nodes on a BITBUS network, using the Intel-developed BITBUS interconnect for data acquisition and industrial control. BBMAS-

TER integrates the real-time features of VMS with the distributed control capabilities on BITBUS to provide a powerful and versatile BITBUS master node implementation.

The package costs \$1,995 with OEM and quantity discounts available. Support contracts are available at \$800 per year.

Learn more by contacting LANTEK, 2131 University Ave., Berkeley, CA 94704; (415) 549-0454.

Circle 511 on reader card

## Components Unlimited Offers MMJ Patch Panels

Components Unlimited Inc. has a series of PC-board modular patch panels with modified modular jacks (MMJ) that are used in DEC-connect modular wiring systems.

The MMJ standard is used in data applications only, primarily RS-232/423. The MMJ jack is a custom modular six-wire off-set keyed jack that won't accept standard RJ11/45 plugs, eliminating any possibility of plugging voice circuits into data lines. This allows for the peaceful coexistence of voice and data patch panels.

The MMJ patch panels break out and

## ProMod Is... The Complete VAX/VMS-Based Integrated CASE Environment.

- Requirements Analysis
- Top Level Design • Detailed Design
- Code Development • Code Generation • Code Maintenance

**P**roMod. From requirements analysis to code maintenance, ProMod is now being used for software development on all VAX/VMS platforms.

Because ProMod was developed on a VAX/VMS system, it's right at home on your existing hardware. And if you're also using PCs, identical packages let you freely transfer all data, text and graphics between your PCs and VAX.

Completely integrated or used as standalone modules, there's never a gap in performance with ProMod.

Join the growing family of VAX/VMS-based software developers worldwide who rely on the power of ProMod state-of-the-art CASE tools. Call our toll-free numbers now for complete information.

Outside California:

1-800-255-2689

In California:

1-800-255-4310

**PROMOD**

23685 Birtcher Drive, El Toro, CA 92630

CIRCLE 356 ON READER CARD

## Unlock M.I.S. Backlogs

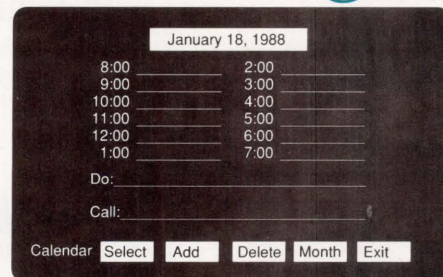

## With System 1032 Application Facility

One keystroke builds a standard application from any System 1032 database you indicate. You then extend this prototype into a full-fledged system by filling in specification menus.

**CompuServe**

Data Technologies  
Tel: (617) 661-9440

CIRCLE 112 ON READER CARD

convert 25-pair cable to MMJ jack ports, improving system flexibility, while cleaning up cable clutter.

For further information, contact Components Unlimited Inc., 12140 S.W. Garden Pl., Portland, OR 97223; (800) 443-2854.

**Circle 513 on reader card**

## DDS 8640 Features EEPROM Storage

Technical Engineering Labs Inc. has added Model DDS 8640 to its 8600 Series Digital Data Switch line. It features a compact 10 1/2-inch high rackmount enclosure, reliable EEPROM storage for all site-specific parameters and auto restart on powerup. Interfacing is through standard 50-pin TELCO-style connectors compatible with Mod-Tap feeder cables and modular adapters to produce a complete modular cabling system.

For further information, contact Keith A. Zessin, Technical Engineering Labs Inc., P.O. Box 27, Fort Calhoun, NE 68023-0027; (402) 468-5187.

**Circle 514 on reader card**

## DataFlex Operates In Three UNIX Environments

Data Access Corporation has announced the release of DataFlex, its applications development database system for three UNIX environments: Tandem LXN and Honeywell Bull XPS-100 under UNIX V and IBM PC/RT under AIX. DataFlex is an applications development database system that operates on most single and multiuser computers as well as VAX/VMS. It provides users with a powerful 4GL, a true RDBMS with an image-oriented screen forms processor, and easy-to-use multifile Query and code generators for programs and reports.

Users migrating applications from PC-

DOS, MS-DOS, CP/M-86, OS/2 and LAN environments to UNIX systems only need to migrate data files and recompile program source code for execution in the UNIX environment.

Prices range from \$1,800 to \$27,600.

To learn more, contact Cory Casanave, Data Access Corp., 14000 S.W. 119th Ave., Miami, FL 33186; (305) 238-0012.

**Circle 516 on reader card**

## XVision Release 2.0 Uses X Window System

The University of New Mexico Electrical and Computer Engineering Department has announced its XVision software system for image processing education and research. XVision uses the X Window System, Version 11, which provides a network transparent windowing environment and software portability, and is written in C.

XVision includes three user interfaces: a menuing system, a quick command interface that can be customized and a standardized UNIX-like command line interface. It also has interactive image display and pseudocoloring, image editing and creation, 2-D, 3-D, and contour plotting and data creation/display via user-specific functions.

Price per copy is \$500, which includes full media and documentation.

For further information, contact XVision, University of New Mexico Electrical and Computer Engineering Department, Albuquerque, NM 87131; (505) 277-1412.

**Circle 518 on reader card**

## VMS Menus Designed In Minutes With MDS32

Ergodic Systems Inc. announces MDS32, a flexible, high-performance menu-design tool for VAX/VMS. With MDS32, designers can

produce menu interfaces in minutes, without programming. MDS32 allows seamless integration of application programs, DCL and menus without repeated process spawns or image activations.

Three DCL-style commands define menus, items on menus, their actions, and other text and screen attributes. These commands let designers define full-screen, overlaid and Lotus-style menus, any of which can be multipage.

MDS32 is priced at \$1,295.

For more information, contact Steve Duff, Ergodic Systems Inc., 23666-A Birtcher, El Toro, CA 92630; (714) 380-9719.

**Circle 519 on reader card**

## Ribbon Saver Extends Printer Ribbon Life

Porelon Inc.'s Ribbon Saver relinking system is available for DEC and CADO Systems printer models. Ribbon Saver extends the life of high-speed printer ribbons, providing up to eight times more clean, crisp impressions for each ribbon, while minimizing downtime, labor and ribbon costs.

The preinked roller attaches to the inside of the printer and automatically reinks standard and O.C.R. ribbons during use. It produces impressions crisp enough to be read by all types of automated scanning systems. For more information, contact Larry Ragland, Porelon Inc., 1480 Gould Dr., Cookeville, TN 38501; (615) 432-4032.

**Circle 520 on reader card**

## EMC Announces Magnetic Disk Subsystems

The MAXPORT series of high-capacity, high-performance magnetic disk subsystems was announced by EMC Corporation. The subsystems are compatible with all VAXs.

The series includes drives ranging from 622 MB to 3.3 GB and a preconfigured subsystem of 11.5 GB. Users can store up to 3.3 GB while using only one disk port.

Using the fastest drives supported by the DEC disk controller architecture, MAXPORT achieves an average seek time of 16 ms and a transfer rate of 2.8 MB per second.

MAXPORT is fully DSA/MSCP-compatible and is completely hardware- and diagnostic-compatible with DEC's HSC 50, HSC 70, KDA 50, KDB 50 and UDA 50 disk controllers. It's suitable for any VAX-cluster, VAXBI, Q-bus or UNIBUS system. Because MAXPORT plugs directly onto the DEC controller, there's no requirement for device drivers or VMS revisions.

Contact Susan Tardanico, EMC Corp., 171 South St., Hopkinton, MA 01748; (800) 222-EMC2; in MA, (508) 435-1000.

**Circle 447 on reader card**

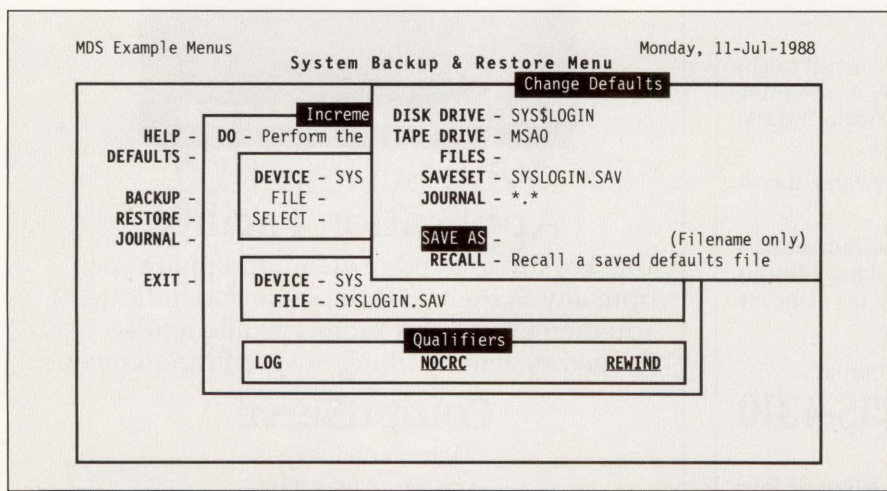

*Ergodic Systems Inc.'s MDS32 lets you design "set up and go" menus.*

## XPert PDX Intelligent Card Offered From TIL

TIL Systems Ltd.'s XPert PDX Intelligent Card provides asynchronous terminals with intelligent terminal functionality. The XPert PDX Card allows an asynchronous terminal to emulate 3270 terminals operating in bisynchronous mode, access financial quotation systems and emulate VT100 terminals over an X.25 network. It also ensures connectivity to any financial quotation feed, providing concurrent terminal access to financial quotations and multiple 3270 sessions.

For more information, contact Bill Morris, TIL Systems Ltd., 20 Bay St., 14th Fl., Toronto, ON; (416) 869-1157.

**Circle 526 on reader card**

## ADC Software System Available For XENIX

Software Maintenance and Development Systems Inc. announced the Aide-De-Camp (ADC) software management system under Santa Cruz XENIX. This is a full-featured software management system that can be ported to the personal computer PC level.

The product has been available on software development platforms at the minicomputer and workstation level, including VAX.

The ADC system decreases administrative detail-handling required of software development personnel and increases development productivity. Relationships between software entities are tracked at each release with ADC system, unavailable with other configuration management systems.

The price of the ADC system is \$2,500. Pricing for the software on workstation and minicomputer platforms ranges from \$5,800 to \$15,200, depending on the model and configuration.

For additional information, contact Mary Cole or Richard Harter, Software Maintenance and Development Systems Inc., P.O. Box 555, Concord, MA 01742; (508) 369-7398.

**Circle 522 on reader card**

## VAX Link Software Runs At 56 KB

Systems Strategies Inc. announced a high-performance version of VAX Link DEC-to-IBM connectivity software that runs at speeds up to 56 KB. High-speed versions are

available for VAX Link/SNA RJE, VAX Link/SNA 3270 and VAX Link/API 3270. VAX Link/BSC RJE also is available under ULTRIX at 56 KB.

Like the standard VAX Link products, the 56 KB version of ULTRIX-based VAX Link runs across TCP/IP LANs. This enables a workstation user on a TCP/IP network to communicate with IBM mainframes via VAX Link/SNA 3270, VAX Link/SNA RJE and VAX Link/BSC RJE software.

Prices range from \$6,000 to \$10,000 per copy.

For further information, contact Lynn Paffmann, Systems Strategies Inc., 255 W. 34th St., New York, NY 10001; (212) 279-8400.

**Circle 523 on reader card**

## ARSAP V6.0 Supports VMS Version 5.0

GEJAC Inc. has announced ARSAP V6.0, a system accounting software product for VAX/VMS. The new version of ARSAP adds seven exclusive features to the existing system accounting product. ARSAP V6.0 fully supports the new features of VMS 5.0.

ARSAP solves top System Improvement

**The laser printer  
engineered to be shared.**



Dataproducts LZR 1230, shown here with optional envelope feeder and face-up output tray, document jogger, and multi-cassette, sheet-feeder base.

- **BROAD COMPATIBILITY**—LZR 1230 is compatible with Diablo 630, Epson FX-80 and HP Laserjet Plus. Supports the IBM PC graphics character set.
- **THREE CONCURRENT INTERFACES**—With Centronics parallel and two serial ports, the LZR 1230 can be shared simultaneously by three different systems.
- **VERSATILE**—Prints letter size, legal size, statement size paper. Envelopes. Overhead transparencies. Even labels.

The LZR 1230 can support up to 10 workstations. It's perfect for multi-user, personal computer systems. Output is 12 pages per minute—fast enough to replace several impact printers. This is simply the best shared-resource value on the laser market. Call us today.

**DP Dataproducts, laser printers**

**SOFTWARE SYSTEMS TECHNOLOGY, INC.**

305 BROADWAY  
NEW YORK, NEW YORK 10007  
(212) 964-9600

**CIRCLE 285 ON READER CARD**

# Unlock VAX Resources

System 1032/Application Facility  
AVAILABLE APPLICATIONS

- 1 - Sales Report Application
- 2 - Graph Sales Report
- 3 - Payroll
- 4 - Mailing list maintenance
- 5 - VMS
- 6 - Mail
- 7 - TPU Editor

## With System 1032 Application Facility

System 1032/AF integrates everything on your VAX: VMS services, 4GL, existing 3GL modules. Integrate at the menu level or invisibly weave everything together inside an application.

**CompuServe**

Data Technologies  
Tel: (617) 661-9440

**CIRCLE 113 ON READER CARD**

# For quality programming, National Public Radio turns to Software AG.

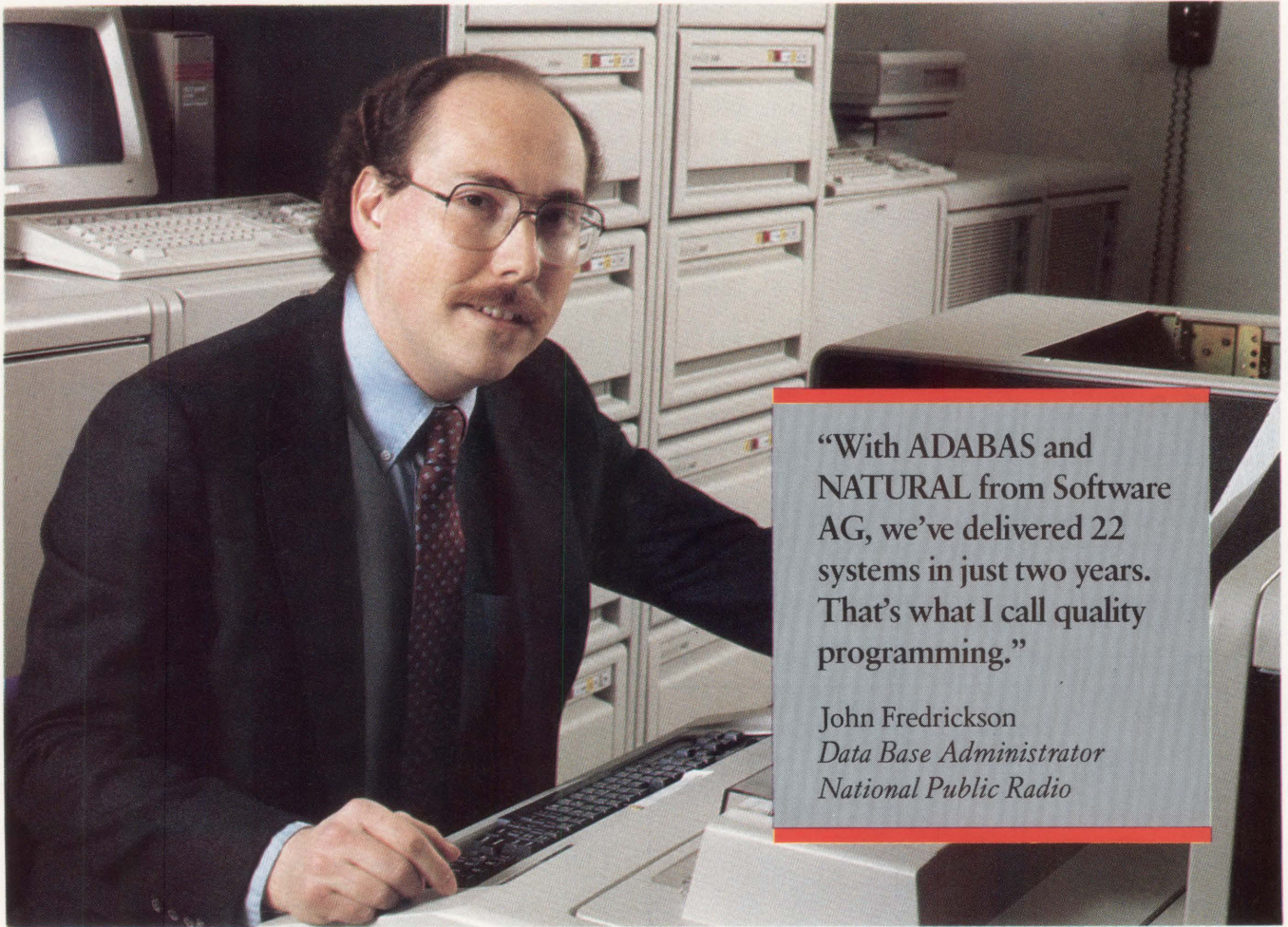

“With ADABAS and NATURAL from Software AG, we’ve delivered 22 systems in just two years. That’s what I call quality programming.”

John Fredrickson  
*Data Base Administrator  
National Public Radio*

Millions of listeners tune in to National Public Radio stations everyday for the best in non-commercial radio programming: great music, unparalleled journalism, interviews with the world’s newsmakers, and invigorating discussions of the arts.

And for quality programming that maximizes the power of their Digital VAX cluster, National Public Radio turns to Software AG.

“To me, a good software product is one that increases productivity, quality, and accountability—while reducing operating costs,” says John Fredrickson, Data Base Administrator for NPR’s Computer Information Services department. “Software AG fourth generation technology has helped us achieve all this.”

Software AG offers a complete family of more than a dozen VAX products, in use at more than 500 organizations around the world. These advanced technologies include:

- \* ADABAS, our relational data base management system;
- \* NATURAL, the 4th Generation applications development technology;
- \* PREDICT, an active data dictionary;
- \* SUPER NATURAL, for end user applications development;
- \* NET-WORK, our distributed communications technology for VAX and VAX-to-IBM environments.

The foundation provided by this family of integrated software tools creates a sound basis for future growth—into CASE technologies; computer-based training systems; graphics data processing; and a variety of end user facilities.

So tune in to some great programming: join the worldwide family of organizations who turn to Software AG for proven high-performance VAX software solutions.

**For more information about Software AG  
VAX software, call toll-free:  
1-800-843-9534**

(In Virginia and Canada, call 1-703-860-5050)

**SOFTWARE AG**  
PROGRAMMING BUSINESS SUCCESS

CIRCLE 309 ON READER CARD

ADABAS, NATURAL, PREDICT, SUPER NATURAL, and NET-WORK are trademarks of Software AG. VAX is a trademark of Digital Equipment Corporation. Check local listings for your public radio station, or call NPR at 202-822-2323.

© 1988 Software AG of North America, Inc.



Requests (SIR) with its new features for project accounting and terminal utilization reporting. The new features of ARSAP V6.0 include six fully automatic reporting components; software package reporting; terminal utilization reporting; batch queues and print queues; print forms accounting; organizational accounting; node, network, and VAXcluster management; and efficient and auditable data handling.

ARSAP V6.0 costs \$5,000 to \$20,000. To obtain additional information, contact Janice Church, GEJAC Inc., 8643 Cherry Ln., Laurel, MD 20707; (301) 725-2500.

Circle 525 on reader card

## VAX-TMS Manages Magnetic Tape Media

Data Center Software has announced VAX-TMS, the VAX tape library management system. VAX-TMS tracks and manages the contents of magnetic tape media.

VAX-TMS has the ability to collect, consolidate and summarize file directory information from single reels of volume sets. VAX-TMS features include immediate access to informative reports, descriptive tape labels and library maintenance.

For more information, contact Data Center Software, 70 Herrick St., Beverly, MA 01915; (508) 922-5500.

Circle 527 on reader card

## DECpage V3.0 Is For Office Publishing

With DECpage Version 3.0 page formatting software, DEC has introduced Office Publishing, the convergence of word processing and electronic publishing. DECpage V3.0 features fast production of professional-quality documents, PostScript support, improved maintenance on large projects and automatic bookbuilding capabilities.

DECpage functions across networked, departmental work groups that use low-cost character-cell terminals. DECpage is accessible to any user of a terminal connected to ALL-IN-1 applications integration environment or the WPS-PLUS/VMS word processing system.

DECpage V3.0 is priced at \$3,000 for the MicroVAX II and varies based on processor. Additional information can be obtained by contacting Kathy Sowards, DEC, 146 Main St., Maynard, MA 01754-2571; (603) 884-3575.

Circle 400 on reader card

## Inference Expands ART-IM Product Line

Inference Corporation announced a system development tool, ART-IM/MS-DOS, run-

ning on PCs with the MS-DOS operating system. ART-IM/MS-DOS is a member of the ART-IM product line.

ART-IM is knowledge-level and language-level compatible, so users can develop an expert system independently on the PC and then run it on an IBM mainframe without additional development work. If an application is cycle intensive, for example, users

can deploy it on the PCs in their system.

The original version of ART is an expert system development environment written for the Symbolics computer in LISP. Inference has ported ART to VAX minicomputers. For more information, contact Inference Corp., 5300 W. Century Blvd., Los Angeles, CA 90045; (213) 417-7997.

Circle 528 on reader card

# WIN/TCP™ for VMS. Put wind in your sails.

All hands on DEC when you use WIN/TCP for VMS to link your VAX or MicroVAX to systems networked with TCP/IP.

It's smooth sailing to a full suite of features such as integrated Mail support, complete File Transfer functions, and TELNET, as well as essential instrumentation for Network Management services. And with NFS already on board, there's little chance of foundering on the shoals of incompatibility.

Full speed ahead to connectivity with WIN/TCP for VMS, a member of the WINS family of networking software. For more information, call 800-872-8649 or 800-972-8649 (in California), or write The Wollongong Group, Inc., 1129 San Antonio Road, Palo Alto, CA 94303.

## WOLLONGONG

We are the standard.™



WIN/TCP AND WINS ARE TRADEMARKS OF THE WOLLONGONG GROUP INC.  
ALL OTHER PRODUCT NAMES ARE TRADEMARKS OF THEIR RESPECTIVE MANUFACTURERS.

CIRCLE 239 ON READER CARD

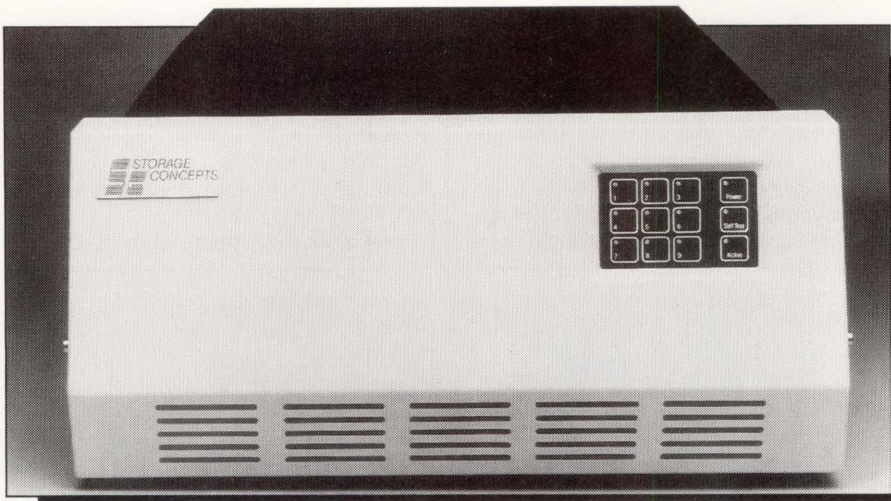

*Storage Concepts Inc.'s Concept 51 disk processing system.*

## Concept 51 Offers High-Capacity Storage

Storage Concepts Inc. has introduced Concept 51, a fast disk-processing system that offers high-capacity storage using economical 5 1/4-inch disk drives and is designed specifically for use with super/minisupercomputers, imaging computers and ultrahigh-speed data acquisition systems. The Concept 51 system is packaged in a single, compact 8 3/4-inch high rack-mountable chassis that incorporates the controller unit, data buffer, system power and cooling and over 6 GB of disk storage.

The Concept 51 disk processing system is linked easily to a variety of host processors through the use of single-card host adapters. Buses supported include Q-bus (MicroVAX), UNIBUS (VAX), VME, MULTibus, VERAbus, and PCAT. Driver support is available for VMS, MicroVMS, UNIX and PC DOS.

Information and prices are available from Martin R. Bock, Storage Concepts Inc., 1622 Deere Ave., Irvine, CA 92714; (714) 852-8511.

**Circle 524 on reader card**

## DSN Becomes Ricoh Authorized Service Center

DynService Network (DSN), a national depot repair organization specializing in computer peripheral and electronic equipment, and Ricoh Corporation, a manufacturer of laser printers, announced that DSN has been appointed the Authorized Service Center for Ricoh's 4080, 4080R, 4081 and 6000 lasers printers. DSN can purchase parts directly from Ricoh to support the laser printers with original OEM parts. By using OEM parts, DSN will provide repairs equal to the OEM's repair standards. As an authorized Ricoh

dealer, DSN now sells model 6000 laser printers.

DSN features a 10-day turnaround, a 90-day warranty, and OEM parts. DSN also supports laser printers manufactured by Ricoh for OEMs under the labels AST, Burroughs, DEC LN03, XTP and others.

For more complete information, contact DynService Network, 1875 Whipple Rd., Hayward, CA 94544-7834; (415) 732-3080.

**Circle 529 on reader card**

## Noah/SQL Allows Access To Relational Databases

Amperif Corporation has introduced Noah/SQL, a structured query language designed to allow interactive access to relational databases. The product supports data retrieval, data manipulation and modification, authorization, transaction control and other features required for database access purposes.

You can execute Noah/SQL command statements interactively, in a batch file or from an application program. Managers, application programmers, database administrators and end users use the same language to access and maintain the database.

The minimum requirement for any VAX CPU costs \$11,000; optional software modules run to \$61,950. Site licenses are available at discounts.

For more information, contact David Vomacka, Amperif Corp., 9232 Eton Ave., Chatsworth, CA 91311-4296; (818) 998-7666.

**Circle 530 on reader card**

## Applitek Announces Three LAN Products

Applitek Corporation announced three broadband and fiber-optic LAN products

that can be configured to run in a single, 6-MHz broadband channel at 10 Mbps. The three product developments are the X.25 Gateway, the Network Management System (NMS) and the 3270 Network Interface Unit.

The Network-managed X.25 Gateway allows complete connectivity to X.25 hosts or X.25 Wide Area Networks (WAN) and is priced at \$17,000. The 3270 Network Interface Unit provides connectivity over broadband, baseband or fiber-optic networks with 3274/3276 control units (Category A coaxial ports) or with non-IBM hosts in a VT100 emulation mode (RS-232 asynchronous ports). Pricing begins at \$14,000. Both the X.25 Gateway and the 3270 Network Interface Unit use the Network Management System (NMS) that runs on a MicroVAX or larger DEC system. Pricing for the NMS software is \$12,000.

Find out more by contacting John E. Dimitrak, Applitek Corp., 107 Audubon Rd., Wakefield, MA 01880; (617) 246-4500.

**Circle 532 on reader card**

## Computer Methods Ups Mac/VAX Schedule

Computer Methods Corporation has doubled its schedule of Macintosh-VAX/VMS Network Lab training courses. The company's Macintosh-VAX/VMS Network Lab is a three-day training program that presents a hands-on approach to the installation, use and management of a variety of third-party Mac-VAX/VMS networking products. The course reviews fundamental AppleTalk and DECnet networking concepts.

The program is offered at the company's Marlton, New Jersey, office, and tuition is \$950.

For more information, contact Anthony V. Caraffa, Computer Methods Corp., Ste. 300, 525 Rt. 73 S., Marlton, NJ 08053; (609) 596-4360.

**Circle 533 on reader card**

## PAKMANAGER Generates Detailed Reports

DEMAC Software has released PAKMANAGER V1.1A, a disk analysis/space management software system. This allows the generation of 8,191 distinct reports. VAX managers instantly can generate detailed reports that identify unnecessary duplicate files, aged files, zero-length files, fragmented files, placed files, excessive multiversion files, overallocated blocks, files to be backed up, expired files and more. Areas of primary focus are wasted disk space, lost disk performance and overall disk status.

PAKMANAGER comes with an easy-to-use screen menu interface, an optional DCL command line interface for experienced

# LAN POWER.

WAN Gateways  
Host Servers  
Security  
LOW COST  
Compatibility  
FLEXIBILITY  
PERFORMANCE  
Wiring  
Network Management  
Twisted Pair

## Introducing EASYway™

Your Ethernet LAN is about to reach new heights. In performance. In flexibility. And in DECnet compatibility.

Able Computer's new EASYway LAN is the first DEC alternative to use Digital's own DECnet/Ethernet software. This means you get permanent compatibility with DECnet protocol. And full software support and service under the Digital umbrella.

### The power to manage. And share.

EASYway brings you greater flexibility with a modular, building block approach to networking. And with an easy-to-use network control system, making it possible to allocate and control system resources as you never have before.

In addition to co-axial Ethernet cable; EASYway uses economical twisted-pair wiring.

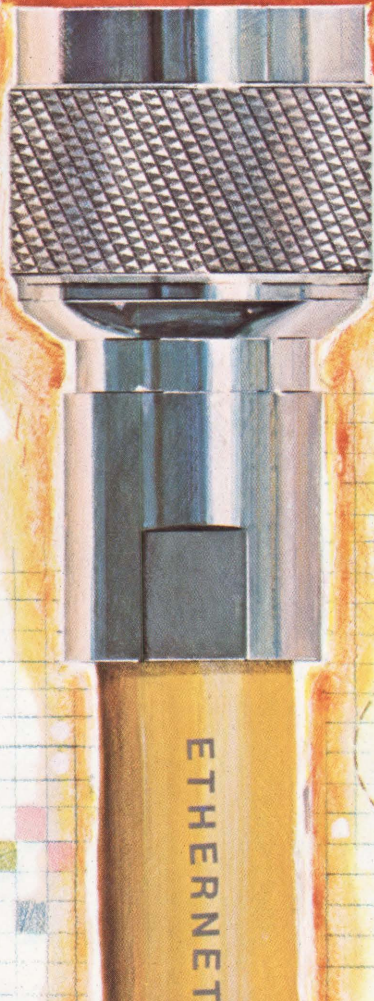

This may cut connectivity costs to less than half what you're paying now. And tighten network security by eliminating the vulnerability of Ethernet cabling.

EASYway is a complete, powerful, low cost networking solution. A high-performance product family of DECnet-compatible host servers, terminal and printer servers, and wide-area gateways that will put your LAN on the road to power.

If you're ready to go places, proceed directly to EASYway. Call or write us today.

In U.S.A.: 2567-A S.E., Main Street, Irvine, CA 92714. Phone (714) 553-1188. Toll-free 800-654-1223. In Calif.: 800-342-8602. In Europe: 287 London Road, Newbury, Berkshire RG13 2QJ, England. Phone: 44-635-32125 • Telex: 848715 • FAX: 44-635-35348



users, a complete on-line help facility and a user manual.

Pricing ranges from \$495 for smaller systems to \$2,995 for larger VAX systems.

Learn more by contacting DEMAC Software, 1260 Old Innes Rd., Ottawa, ON K1B 3V3; (613) 748-0209.

**Circle 534 on reader card**

## Dynamic Load Balancer Boosts Memory Use

Touch Technologies Inc.'s Dynamic Load Balancer is a system software product that dynamically tunes VAX systems. It does its best work on systems that are memory saturated, page faulting and out of CPU cycles.

Dynamic Load Balancer uses an exclusive Touch Technologies algorithm to dynamically tune VAXs by altering both SYSGEN dynamic parameters and process-specific resource allocations. The result is a well-balanced, perfectly tuned VAX. Memory-limited, CPU-bound, and I/O-bound systems will benefit from Dynamic Load Balancer.

Obtain further information by contacting Touch Technologies Inc., 9990 Mesa Rim

Road, Ste. 220, San Diego, CA 92121; (800) 525-2527; in CA (800) 325-2527.

**Circle 535 on reader card**

## Ada-Macs Enhances Programmer Productivity

UniPress Software Inc. announced version 2.15 of Ada-macs, an advanced Ada text editor to enhance programmer productivity.

Available on a range of UNIX-based systems, Ada-macs is a multiwindow editor that understands Ada language syntax, allowing programmers to type Ada constructs easily into programs and call up definitions of subroutines through a menu-based interface.

Major enhancements include a new interactive help facility, Ada sitewide syntax-style rules, on-line Ada-keyword database, on-line Ada-macs tutorial and new documentation.

Ada-macs is available for a wide range of computer systems running UNIX, Xenix, ULTRIX and other UNIX derivatives.

It's priced at \$1,590 for VAX 750/780 and \$3,995 for superminicomputer systems like the VAX 785.

For more information, contact UniPress Software Inc., 2025 Lincoln Hwy., Edison, NJ 08817; (201) 985-8000.

**Circle 536 on reader card**

## New Networks Guidebook Available From DEC

DEC has announced the availability of the *Industrial Networks Guidebook*. The book introduces the basic concepts of networking and explores the current technologies that can be applied to improve integration within manufacturing firms.

Topics covered include networks in the enterprise of the 1990s, basic concepts and equipment, plant floor device integration, planning a manufacturing network, and case studies of real networks. The book helps decision makers at all levels understand and evaluate the issues in manufacturing integration.

For more information, contact Media Fulfillment Dept., *Industrial Networks Guidebook*, Part #EB-31782-70, 444 Whitney St., NRO2-1/H3, Northboro, MA 01532; (508) 490-7889.

**Circle 578 on reader card**

# POWERFUL TEAMMATES

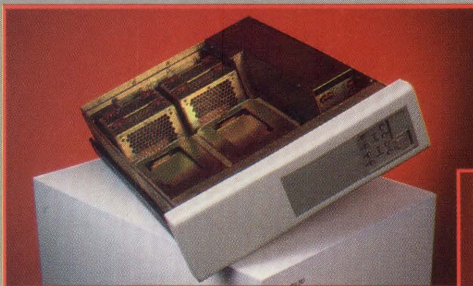

**5.25" DISK STORAGE ENCLOSURE  
DA 50**

- Mounting for four 5.25" Peripherals on slide plates
- Easy Installation and Removal of Peripherals
- Chassis Slides with full extension
- 50 Watt Power Supply for each 5.25" Peripheral
- Control Console with Write Protect/Ready functions
- Disk Access Indicator
- Audible and Visible Thermal Protection Alarm
- I/O Panel with 2 C size cutouts...bridges allow for 4 B size cutouts
- Remote Input Connector for power control by remote device



**10.50" SYSTEM ENCLOSURE  
DA 523**

- Cardcage with 12 Slot "CD" Q-Bus Backplane
- Mounting for five 5.25" Peripherals on slide plates
- Vertical Cardcage for easy module access
- 500 and 50 Watt Continuous Power Supplies
- Control Console with Write Protect/Ready functions
- Audible and Visible Thermal Protection Alarm

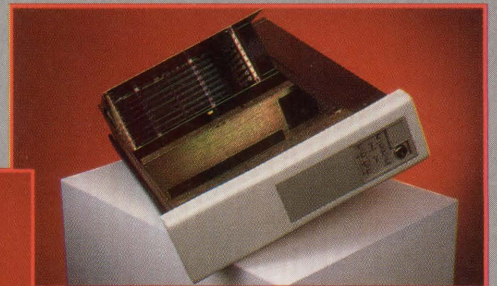

**5.25" SYSTEM ENCLOSURE  
DA 23**

- Cardcage with 8 Slot "CD" or "Q22" Backplane
- Mounting for two 5.25" Peripherals on slide plates
- Tilt-Up and Locking Cardcage for easy module access
- 350 Watt Continuous Power Supply
- Control Console with Write Protect/Ready functions
- Audible and Visible Thermal Protection Alarm
- Drive Access Indicator
- Power Supply Voltage Monitoring and Indicator
- I.E.C. Multi-Voltage AC
- Remote Output Connector

## TRIM INDUSTRIES



11949 Sherman Road, North Hollywood, CA 91605  
Phone: 818-983-1833, 800-272-3557 in CA 800-423-2024 outside CA  
0438 TWX: 910 499 4745

## TRIM INDUSTRIES LIMITED



2-6 Giltway, Giltbrook, Nottingham NG16 2GN England  
Phone: (0602) 385485  
FAX: (0602) 389973 Telex: 378317

Twice the performance  
at half the price!

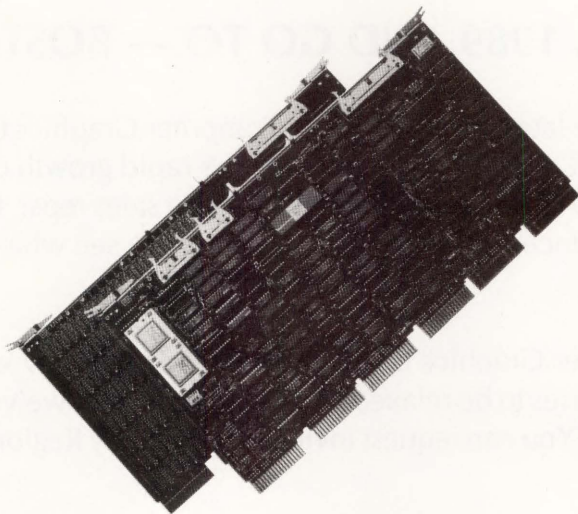

**MARKET PROVEN**  
**N1100 PLUS**  
**UNIBUS\* USERS**

FEATURES

- 4 Mbytes DRAM
- 8 KBytes Cache
- Hardware Floating Point
- Memory Management
- J-11.\* Power for optimum performance
- Fits all existing CPUs — No backplane change

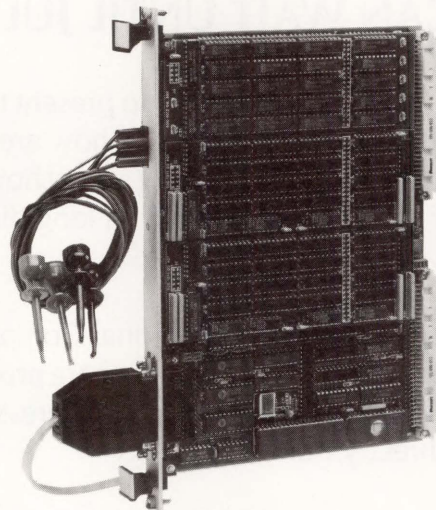

**NEW**  
**N9200**  
**VMEbus ANALYZER**

FEATURES

- 2K trace buffer stores 96 VMEbus signals
- 4 user defined events which control trace storage
- Synchronous/asynchronous sampling at 20 MHz
- Bus interval and events elapsed timer
- Direct Read of power supply voltage
- Standard RS232 ASCII interface

FOR SPECIAL PRICING ON N1100, CALL OLIVIA AT  
(800) 233-1837 IN CALIFORNIA (714) 261-8811

\*UNIBUS and \*J-11 are registered trademarks of DIGITAL EQUIPMENT CORPORATION

# *Regional Computer Graphics Expo*

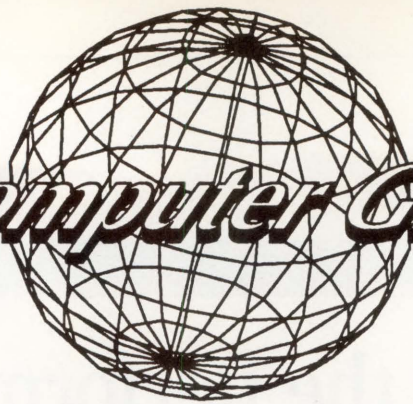

**YOU CAN WAIT UNTIL APRIL, 1989 AND GO TO — PHILADELPHIA**

**OR YOU CAN WAIT UNTIL JULY, 1989 AND GO TO — BOSTON**

**BUT**, in fact, while you're waiting for others to present the latest and greatest in Computer Graphics technology in cities remote to you — some time next year — how are YOU staying current with the rapid growth of products in your industry? Reading the trades? Attending trade shows? Countless hours with visiting sales reps? If you've time left and enough money saved, you can travel a long distance — sometime next year — to see what's "in vogue" in Computer Graphics.

**Or** you can get current with us — The Regional Computer Graphics Expos are heading your way with the latest technology in Computer Graphics. The atmosphere promises to be relaxed and neighborly, and we've targeted the theme of the Expos and seminars to your specific interests. You can request invitations from any Regional Computer Graphics exhibitor or directly from us.

## HOST CITIES

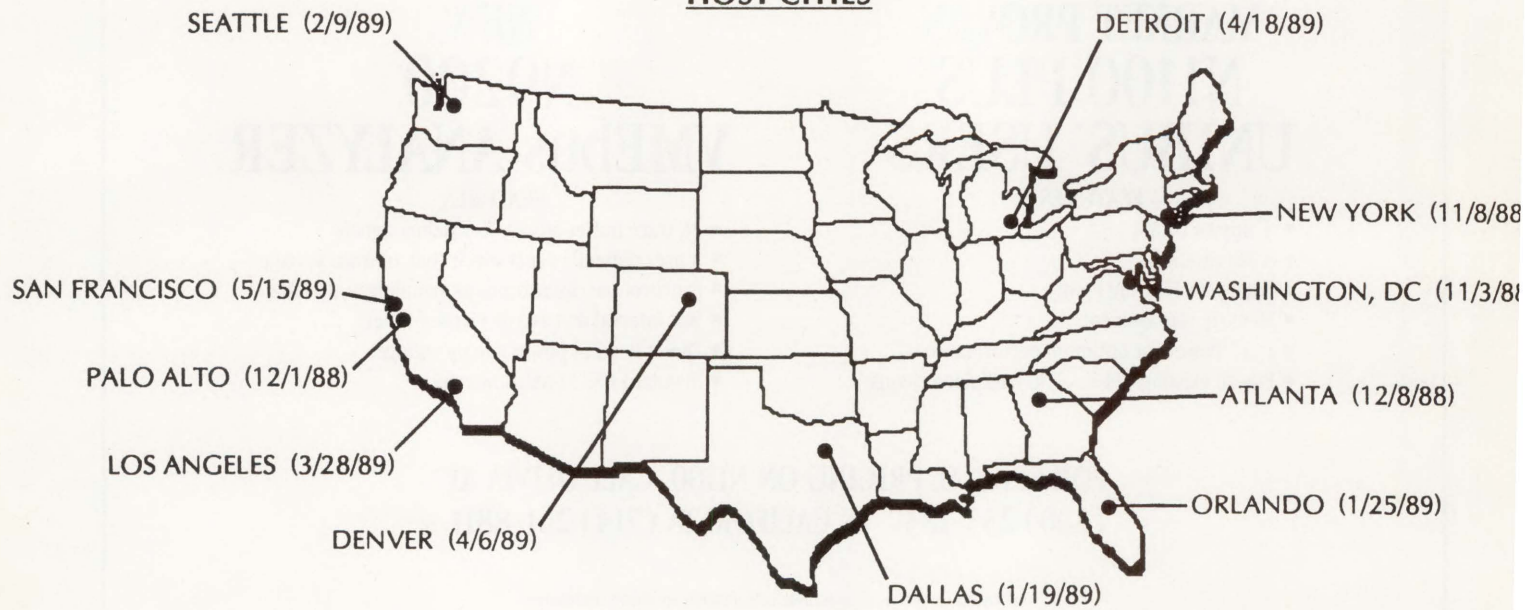

## REPRESENTATIVE PRODUCTS

DIGITIZERS ■ DIGITAL FILM RECORDER ■ UNIX ■ IMAGE PROCESSORS ■ MONITORS ■ PC 386  
GRAPHICS BOARDS ■ WORKSTATIONS ■ PRINTERS ■ PLOTTERS ■ SOFTWARE ■ SCANNERS



REGIONAL COMPUTER EXPOSITIONS • P. O. BOX A6-233 • LAGUNA NIGUEL, CA 92677 • (714) 249-80

# IF YOU'RE NOT BACKING UP WITH MEGATAPE, YOU'RE MISSING THE BUS.



## THE ONLY VAXBI BUS BACKUP DEVICE YOU CAN BUY.

**I**t's sort of ironic that so many big, powerful VAX systems have to get by with little, slow cartridges or reel-to-reel drives for disk backup.

Wouldn't it be great if somebody offered a high-capacity cartridge drive with a direct, high-performance attachment to the VAXBI Bus?

Now, somebody does. Presenting Megatape's new MT-750 VAXBI sub-system. A breakthrough that lets high-end VAX users enjoy all the advantages of Megatape without bus adapters or other bottlenecks. The result is far greater capacity and convenience than 9-track streamers— at a fraction of the cost.

Each MT-750 cartridge holds 630 MB, formatted. Enough to back up an entire RA-81 or RA-82 in a single

quick operation. The controller takes full advantage of the BI bus speed, and it's even TMSCP compatible, so all existing software works unchanged.

There's no gambling with unproven technology, either. Thousands of MT-750s are in daily use at DEC sites around the world. Fully supported by a service program that can get you back up within hours if there's ever a problem.



So stop dragging your feet and get on the Bus. As any Megatape user will attest, it's the only way to fly!

VAX and VAXBI are trademarks of Digital Equipment Corp.  
© 1988 Megatape Corporation.

## MEGATAPE CORPORATION

1041 Hamilton Road  
Duarte, CA 91010-0317  
(818) 357-9921 • Telex: 510 600 7131  
Telefax: (818) 357-2369

 **egaTape**  
THE GREAT LEAP  
FORWARD IN BACKUP.

## Excelerator/IS Links With VAX CDD/Plus

Index Technology Corporation announced a link that integrates Excelerator/IS, its systems analysis and design software, with VAX Common Data Dictionary/Plus (CDD/Plus), DEC's distributed data dictionary. VAX CDD/Plus is central to DEC's line of on-line transaction processing products, called DECtp.

The link, which operates on all VAX-station models running the VMS operating system, integrates Excelerator/IS's systems analysis and design functions with the systems production capabilities performed by VAX CDD/Plus.

The link includes an advanced user interface with a windowing capability that allows users simultaneously to view and manipulate data residing in both Excelerator/IS and VAX CDD/Plus from anywhere on the VMS network. This promotes closer synchronization of the systems design phase with code production and systems usage in a seamless, integrated environment. To learn more, contact Jessica Solodar, Index Technology Corp., One Main St., Cambridge, MA 02142; (617) 494-8200.

Circle 539 on reader card

*Index  
Technology  
Corporation  
links its  
Excelerator/IS  
with DEC's  
VAX  
CDD/Plus.*

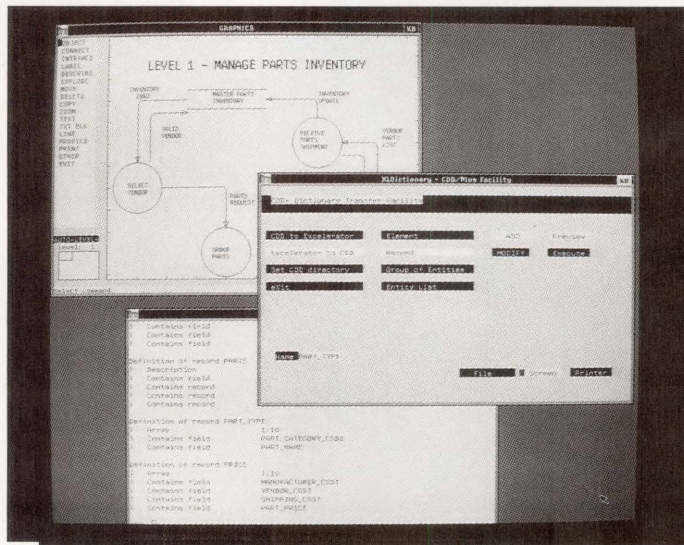

## WordMARC-ORACLE Provides Integration

MARC Software International Inc. has introduced the WordMARC-ORACLE Connection, a program that provides transparent integration between the WordMARC Composer + word processing program and the ORACLE database. The WordMARC-ORACLE Connection allows ORACLE

users to retrieve and incorporate information from the ORACLE database into a WordMARC document simply by making selections from a menu. Users can incorporate snapshot reports that won't change as ORACLE data is modified, or hot-linked reports that are updated automatically to reflect any changes in ORACLE.

ORACLE data can be merged directly with WordMARC mail-merge documents to produce desktop publishing quality letters and reports. Users can create a WordMARC mail-merge database from ORACLE data, or send entries from the WordMARC database to ORACLE. The product is available for Prime, VAX/VMS and VAX ULTRIX.

For additional information, contact Candy Burbridge, MARC Software International Inc., 260 Sheridan Ave., Ste. 309, Palo Alto, CA 94306; (415) 326-1971.

Circle 537 on reader card

## ACC Unveils ISO Protocol Implementation

Advanced Computer Communications (ACC) unveiled its initial implementation of the International Standards Organization (ISO) protocols. ACC's pilot project implements ISO Transport Protocol Class 4

(TP4) and Internet Protocol (IP) and provides X.25 services using its existing X.25 VAX and MicroVAX front-end processors.

ACC implements the TP4 and IP layers directly on its Q-bus and UNIBUS boards to offload processing from the host CPU. IP is responsible for routing data to the correct location and TP4 is comprised of several protocols that perform error checking and reliable data delivery procedures. ACC also

has been developing a package of higher-level OSI protocols, including FTAM (File Transfer, Access and Management), to be run on an ULTRIX host.

More information is available by contacting Advanced Computer Communications, 720 Santa Barbara St., Santa Barbara, CA 93101; (805) 963-9431.

Circle 538 on reader card

## CLINTRIAL V2.2 Offers Security Improvements

BBN Software Products Corporation has a new version of CLINTRIAL software for the pharmaceutical industry. CLINTRIAL V2.2, running on VAX/VMS hardware, offers security and performance improvements and other features that enable users to be more productive in managing clinical trials data.

The product provides two capabilities, encrypted passwords and restricted menu access, that prevent unauthenticated changes to recorded data. The system has an ad hoc audit trail capability that displays user ID, new data values, previous data values and the times changes were entered.

The CLINTRIAL system lets users retrieve the same data items across multiple studies with a single command. Users can make structure changes to all tables in a database with a single command, without affecting the data currently in the database. To find out more, contact Lynn Hearl, BBN Software Products Corp., 10 Fawcett St., Cambridge, MA 02238; (617) 873-5000.

Circle 540 on reader card

## Mercury KBE Includes CASE Facilities

Artificial Intelligence Technologies Inc. has announced the availability of an important tool in the knowledge systems area: the Mercury Knowledge Base Environment (KBE). Mercury KBE makes possible the successful implementation of medium- and large-scale expert systems on industry-accepted hardware platforms.

The product includes many built-in intelligent CASE facilities, such as the auto-generation of an application's user interface. The CASE methodologies, the integration of communications and graphics capabilities and the standard SQL interface facilitate rapid development and timely deployment of an application.

Mercury KBE is available for VAX/VMS implementation. It's priced at \$21,000 for a single CPU license.

Learn more by contacting Marvin Berlin, Artificial Intelligence Technologies Inc., 1 Skyline Dr., Hawthorne, NY 10532; (914) 347-6860.

Circle 541 on reader card



# Don't settle for just a 386 PC.

VAX access  
and PC applications.  
Hmmm!



## Introducing NETmate.™

Put more computing power with DEC™ connections on your desktop. Integrate the power of VAX/VMS™ and UNIX® systems with popular MS-DOS® applications. With NETmate—Datamedia's new family of 386™-based desktop workstations.

NETmate has more of what it takes to help you keep your competitive edge. More security with diskless operation. More processing power. More access to PC applications, shared files, and peripherals. More flexible integration with VAX systems.

With NETmate's sleek, ergonomic design and seamless integration, you can take advantage of Digital's PCSA,™ NetWare,® NFS,™ PC LAN, and 3+™. And count on more flexible choices such as

VT340™ graphics or Tek 4208 emulation, color or monochrome monitors, and DEC- or PS/2®-style keyboards.

Plus, features that make our price/performance story even more attractive. Innovative CARDfiles to personalize start-up and security. A Power Meter™ rating of 4.6 MIPS. Integrated VGA color graphics. Simultaneous terminal sessions. Cut and paste. And DEC printer support.

But don't just take our word for it. Make your DEC connections by calling Datamedia at 1-800-DMC-INFO.

**DMC**  
DATAMEDIA CORPORATION  
*The Positive Response™*

NETmate is a trademark of Datamedia Corporation. DEC, VAX, VMS, PCSA, and VT340 are trademarks of Digital Equipment Corporation. UNIX is a registered trademark of AT&T. MS-DOS is a registered trademark of Microsoft Corporation. 386 is a trademark of Intel Corporation. NetWare is a registered trademark of Novell, Inc. NFS is a trademark of Sun Microsystems, Inc. 3+ is a trademark of 3Com Corporation. PS/2 is a registered trademark of IBM Corporation. Power Meter is a trademark of The Database Group, Inc.

CIRCLE 189 ON READER CARD

11 Trafalgar Square, Nashua, NH 03063

Meet the technology  
leaders in

# Computer Graphics

—at the Invitational Computer  
Conference near where you live  
and work.

The Computer Graphics market is growing so fast it's hard to keep up with the products and trends you need to know about for informed quantity purchase decisions. So we make it easy for you—at the Invitational Computer Conference (ICC), the one-day, seminar/product displays that bring the latest information on computer graphics hardware and software technology and products to your area. This year there are eight ICCs dedicated exclusively to the computer graphics systems integrators, OEMs and volume end users in the United States and Europe. One will be convenient for you.

The ICCs are so popular because they give you just what you need to know without wasting your time or money. You don't travel far, there's no admission fee, the seminars and table-top displays from major manufacturers are all targeted to your interests (no searching through aisles), and the atmosphere is informative and hands-on, but congenial, with refreshments served. In a few hours you'll have the latest story on the newest and best in graphics, CAD/CAM/CAE/CIM/CAP, etc.

Invitations to the ICC in your area are available from an exhibitor or the ICC management. Request yours today.



## 1988/89 Computer Graphics Series

### U.S. Locations

Chicago, IL	Sept. 21, 1988
Irvine, CA	Oct. 4, 1988
Dallas, TX	Oct. 20, 1988
San Jose, CA	Feb. 6, 1989
Newton, MA	Feb. 15, 1989

### European Locations

London, England	May 11, 1989
Frankfurt, W. Germany	May 17, 1989
Paris, France	May 23, 1989

*ICC Conference Management:*  
B. J. Johnson & Associates, Inc.  
3151 Airway Avenue, C-2  
Costa Mesa, California 92626  
Telephone: (714) 957-0171  
FAX: (714) 957-0903  
Telex: 5101002189 BJ JOHN

*European Liaison Office:*  
C. J. Nicholl & Associates Ltd.  
37 Brompton Road  
London SW3 1DE, England  
Telephone: 01-581 2326/9  
FAX: 1-589 0893  
Telex: 888068 CJNAD G



# MEET THE GUYS WHO CHEATED DIGITAL EQUIPMENT CORPORATION OUT OF \$60,000,000.



With their software, you can do everything a \$1000 DEC terminal does — on your PC — for a mere \$245.

The suave and debonair gentlemen bandits who sit before you virtually invented DEC terminal emulation for the IBM personal computer.

To the uninitiated, what that means is this.

With their software, you can do everything a \$1,000 DEC terminal can do — right on your own PC — for the paltry sum of only \$245.

Has business been good for our heroes?

You bet: to the tune of 60,000 users, who would otherwise have blithely gone out and bought DEC terminals.

Does this make DEC happy? What do you think.

## Heavy DEC Experience + Heavy IBM Experience = Perfect Emulation.

The product these wizards invented is VTERM/220. And the reason it's so good, frankly, is that nobody has more experience than they do in DEC emulation on a PC.

With VTERM/220, you can emulate DEC's VT220, VT102, VT101, VT100, and VT52 terminals.

Of course, there's emulation and then there's EMULATION. This is *TRUE EMULATION*. Complete! Comprehensive! Thorough! Fast! Accurate!

Installation's a snap. Setup is a simple full-screen operation. You can toggle between DOS and the terminal screen and put mainframe data directly into PC spreadsheet and data base products such as Lotus 1-2-3™, dBase™, and Multiplan™. And for file transfer, there's XMODEM, ASCII, Kermit or VTRANS, our own high-speed, error-correcting protocol.

## One last word from the Robin Hoods of software.

Are there other terminal emulators?

Of course there are.

But, we invented DEC terminal emulation at Coefficient. We know the subtleties, the little features (and the big ones) that make an emulator a joy to use. And we've incorporated them all into VTERM/220.

Just ask any of our 60,000 users.

They paid us the highest compliment of all.

They chose our software over the real thing.

CIRCLE 107 ON READER CARD

## A free working copy of their software. Free? Yes, free.

There's only one way to experience the speed, power, and simplicity of VTERM/220. Try it.

- Send me a free, time-limited, full-blown working copy of VTERM/220, which is mine to keep.
- Send me a free, time-limited full-blown working copy of your new VTERM/4105 or VTERM/4208 Tektronix graphics terminal emulators.

Name \_\_\_\_\_

Title \_\_\_\_\_

Company \_\_\_\_\_

Address \_\_\_\_\_

Telephone (\_\_\_\_) \_\_\_\_\_

I am a  user  dealer.

## Coefficient Systems Corporation

611 Broadway, New York, New York 10012

Voice: (212) 777-6707, ext. 621 Fax: (212) 228-3137

Telex: 6503156498 MCI Mailbox: CSC

DP1188

## INFORMATION

Rates: 1 time: \$600  
 3 times: \$550  
 6 times: \$500  
 12 times: \$450

Size: 1/9 page — 2<sup>3</sup>/<sub>16</sub>" x 2<sup>3</sup>/<sub>4</sub>"

Camera ready mechanical required.

Typesetting and composition available.

For more information call  
 Mary Browarek at  
 (215) 542-7008.

## Why take chances?

When buying or selling used equipment in the DEC\* marketplace, look for a dda member — your assurance of a reputable dealer.



For membership and other information call:

**313/475-8333**

**dda** DIGITAL DEALERS ASSOCIATION

107 S. MAIN STREET • SUITE 202  
 CHELSEA, MICHIGAN 48118

\*DEC is a registered trademark of Digital Equipment Corporation.

## Read VAX BACKUP Tapes Directly to Your MAC or PC

VTAPE Connection is the *only* complete hardware/software solution for 9-track magnetic tape exchange with VAX Systems that allows you to handle VAX BACKUP and COPY tapes. VTAPE Connection includes 9-track Ministreamer tape drive, controller, cables, software, and documentation. Available for MAC or PC at 1600/3200 or 1600/6250 BPI.

Prices start at \$4,255.

**DGI**

**Decision Graphics, Inc.**  
 555 Sparkman Drive, Suite 652  
 Huntsville, AL 35816  
 (205) 837-7710

CIRCLE 203 ON READER CARD

CIRCLE 213 ON READER CARD

## VAX TIME

- 785, 780 Computers
- Rates from \$6.00/Hour
- Timeshared or Dedicated
- Tymnet access available
- Disaster Recovery Services



AMERICAN DIGITAL TECHNOLOGIES  
 Costa Mesa, California

CONTACT:

(800) 669-7070  
 (714) 957-8440

CIRCLE 200 ON READER CARD

## LEX USERS

- Have you been waiting for version 9b?
- Do you need support or training?
- Are you interested in adding spreadsheet, graphics or database software?

For more information call Saturn Systems, the exclusive distributor for LEX products.

**800-328-6145**

**SATURN**

10120 West 76th Street  
 Eden Prairie, MN 55344  
 612-944-2452

CIRCLE 335 ON READER CARD

## DEC CONVERSIONS

We CONVERT information to and from DEC and other systems.

- Word Processing
- Database
- Spreadsheet
- Disks, Tapes or Hardpacks

General Information Services, Inc.  
 2300 Walnut Street  
 Philadelphia, PA 19103

800-USA-6158 or 215-557-1950

CIRCLE 320 ON READER CARD



MEADOWLARK ENTERPRISES  
 37 High Street  
 Danvers, MA 01923

We need to buy your excess DEC equipment now!

## VAX & PDP-11

Turn your unwanted computer equipment into cash!

- ✓ Large inventory
- ✓ Immediate availability
- ✓ Super Prices

**508-777-4666**

FAX-508-777-8433 800 DEC-DLER

CIRCLE 204 ON READER CARD

## VAX® RENTALS

MICROVAX II  
 VAX 700 SERIES  
 VAX 8000 SERIES  
 Systems & Peripherals

- Add-On Flexibility
- Purchase Options

6 Months • 12 Months • 36 Months

**BROOKVALE ASSOCIATES**

dda Digital Dealers Assoc.

EAST COAST  
 (516) 273-7777

WEST COAST  
 (206) 392-9878

CIRCLE 202 ON READER CARD

## VAX CAREERS SOUTHEAST

Winning combinations of these skills can propel YOU into some of the best companies in the Southeast!!!!

PROGRAMMERS/ANALYSTS/DBAs — RDB, ORACLE, OR INGRES... COBOL, FORTRAN, OR C

SOFTWARE ENGINEERS — Knowledge of micros/minis to component level... FORTRAN, PASCAL, or C... PLC's a plus

SYSTEM MANAGERS — High-end clusters... Heavy VMS and DECNET/ETHERNET



**BRENDA CAREY, C.P.C.**  
 Digital Recruiter

**Amos & Associates**

633-B Chapel Hill Road  
 Burlington, NC 27215  
 (919) 222-0231

CIRCLE 201 ON READER CARD

**DEC\* DEPOT REPAIR • DEC\* SERVICE TRAINING  
DEC\* SPARE PARTS**

*New* - 1-YEAR WARRANTY ON ALL EQUIPMENT SALES & REPAIRS - *New*

LOW  
QUALITY  
COST  
PRODUCTS

- F** • 11 YEARS IN THE DEC\* BUSINESS  
**A** • PDP 8 TO VAX, AND PERIPHERALS COVERAGE  
**S** • 5 DAY STANDARD TURNAROUND ON REPAIRS  
**T** • OPTIONAL 24 HR. EMERGENCY REPAIR  
**S** • ADVANCE SWAP/EXCHANGE PROGRAM  
**E** • LEASING OR RENTALS  
**R** • FLAT RATE REPAIR PRICES/VOLUME DISCOUNTS  
**V** • UPGRADES AND ECOs AT NO ADDITIONAL COST  
**I** • TRAINING, AT YOUR FACILITY OR ESS's  
**C** • AN INVENTORY IN EXCESS OF 100,000 ITEMS  
**E** • SAME DAY SHIPMENTS ON PURCHASES  
**R** • OPTIONAL 24/7 COVERAGE  
**V** • PERSONALIZED SERVICE/COMPETITIVE PRICES

*New* - CDC\* DEPOT REPAIR & SPARES - *New*



ELECTRONIC  
SERVICE  
SPECIALISTS  
A Bell Atlantic Company

N92 W14612 Anthony Ave.  
Menomonee Falls, WI 53051

is  
Your Answer for DEC\* Repairs & Spares

CALL US FOR QUOTES  
REPAIRS/BUYING/SELLING/  
RENTING/TRAINING/LEASING  
PHONE: 414-255-4634

FAX: 414-255-5418

TELEX: 260183  
ESS LTD MEFS

Registered Trademark of Digital Equipment Corporation  
Registered Trademark of Control Data Corporation



COMPUTERS AND PERIPHERALS  
IN STOCK PROMPT DELIVERY

NEW BUY DEC™ USED SELL

**SYSTEMS  
MODULES  
PERIPHERALS  
VAX\*Q-BUS\*UNIBUS**

CALL TODAY

617-547-4005 • 800-892-9230

TELEX 374-8460 FAX (617) 354-1417

COMPETITIVE PRICING

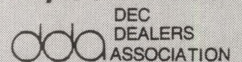

LET US QUOTE YOU ON ALL YOUR DEC NEEDS

\*DEC A TRADEMARK OF DIGITAL EQUIPMENT CORP

**ELI HEFFRON & Sons inc.**  
139 HAMPSHIRE ST. CAMBRIDGE, MA. 02139

digital

**PUBLIC NOTICE!!**

digital

**BOSTON BOARDS & SYSTEMS, INC.**

55 Rear Main Street, Kingston, MA 02364



Boston Boards  
&  
Systems



Boston Boards  
&  
Systems

**617-585-7777**

*Our Guarantee Is Our Reputation!!*

**SPECIAL**  
VEGETARIAN PLATTER  
W/BEVERAGE  
\$3.75

**MICROVAX II**  
Systems & Peripherals

**8000**  
**SERIES**

Systems  
&  
Peripherals

**\$1 MILLION + \*DEC inventory  
15% to 60% OFF DIGITAL LIST!!  
CABLES TO CPU's!! CALL TODAY!!**

**WE ALSO BUY NEW & USED  
EXCESS \*DEC INVENTORY**

**EMC<sup>2</sup>**

**cipher**  
data products, inc.

**GD**  
CONTROL  
DATA

**EX**  
EMULEX  
T.M.

**KENNEDY**

**FUJITSU**

**T.M.**  
National  
Semiconductor

digital

FAX: 617-585-6211  
TELEX #920-038BBS

Digital is a registered trademark of Digital Equipment Corporation

digital

# We Rent VAX Systems

WANTED  
VAX SYSTEMS  
MVII AND 8000  
SERIES

- Short term rentals on systems and peripherals
- Purchase accruals
- Sales of new and used equipment
- DEC maintenance guaranteed
- Fixed price freight/installation packages available



Selling and Leasing Computers Since 1966  
Equipment Corporation

26319 I-45 North  
The Woodlands, TX 77380  
800-288-1846



# EUROPE

## NEEDS YOUR DEC EQUIPMENT NOW

ICEX, Inc. has more than 10 years experience selling DEC hardware in Europe. We pay CASH for DEC peripherals and systems to sell to our European customers. Take advantage of the low U.S. dollar and call

**1-800-222-4239.**



International Computer Exchange, Inc.  
740C South Pierce Ave.  
Louisville, Colorado 80027-9989  
303/666-5400  
Telex: 292682  
FAX: 303/666-7054



DEC is a registered trademark of Digital Equipment Corp.

## CLASSIFIED

Move your Dec-20 out  
To make way for the new  
And move in with us while you do it

Landart Systems, Inc.  
(212) 363-3170

### ATTENTION VENDORS

The *DEC PROFESSIONAL* magazine will consider DEC-specific hardware and software products for review. We do not endorse or guarantee any products reviewed or discussed.

For further information contact:  
The Editorial Department,  
Professional Press,  
921 Bethlehem Pike,  
Spring House, PA 19477.

**C LANGUAGE CONSULTING AND EDUCATION** by noted *DEC PROFESSIONAL* columnist. Also other languages and packages on RSX, VMS, RSTS and MS-DOS, including DBMS and DECnet. Applications experience includes real-time, process control, engineering, scientific and commercial systems. Rex Jaeschke. (703) 860-0091.

**REMTEC FUJITSU 2284.** 168MB, Disc Drive, \$600. Fully guaranteed. (415) 463-3511.

**REMTEC FUJITSU 2294K.** 336MB, \$1,850. (415) 463-3511.

- PRO 350/380 MEMORY BOARDS
- DISK DRIVES - BIG & FAST FOR PRO
- RAM-DISK Software for Micro/RSX\*, 11M (+) & P/OS\*  
Call 415-420-9579  
Proto Systems  
1238 Josephine St, Berkeley, CA 94703

*buy, sell trade*  
**LSI\***  
**PDP\***  
**VAX\***

### SYSTEMS & PERIPHERALS

- CPUs • MEMORIES
- DISC & TAPE DRIVES
- CRTs • TERMINALS • PRINTERS
- INTERFACES Etc.

**dce** DIGITAL  
COMPUTER  
EXCHANGE INC

27773 Industrial Blvd., Hayward, CA. 94545  
CALL-(415) 887-3100  
FAX (415) 887-5590 TLX 709536



\* Registered trademark of Digital Equipment Corporation

graphics terminals, designed from scratch. You can look forward to any product Pericom will bring to the graphics market. —David B. Miller is associate director of computer services at Beaver College in Glenside, Pennsylvania.

REPRINTED FROM  
DEC PROFESSIONAL MARCH 1988

# Well David, here's the latest

Terminal emulation software for PC's is probably not what he was expecting because we're famous for our graphic terminals.

But it shouldn't come as too much of a surprise because terminal emulation has always been our business. We've been supplying high quality Tek, DEC, and Retrographics emulators to some of the biggest names in industry for nearly a decade.

And since hardware terminal emulation is essentially a software exercise we've decided to put all that field proven experience on a floppy disk for your PC. The result: TEEM·TALK™, probably the best graphics terminal emulation package around.

TEEM·TALK™ is designed to turn a standard IBM XT, AT, 386, PS/2 or compatible into a fully loaded, powerful terminal with the largest choice of graphics emulations available, including Tek 4105, 4207, 4111, DEC VT240 ReGIS, Retrographics VT640 and Westward 3220.

Alpha emulations include VT100, VT220 and DG200, and to get over the shortcomings of other emulator packages, text mode performance can be enhanced

with TEEM·TEXT™, a slot-in dialog board providing up to 4 separate alpha planes for true, high performance text editing with full attributes, screen formats of 24, 32 and 48 lines of 80 or 132 columns and the ability to display graphics and text at the same time - just like a terminal!

Taking things one stage further, we've designed the optional TEEM·TOUCH™ keyboard so that your PC not only thinks like a graphics terminal, it also feels like one.

So TEEM·TALK™ is a range of products like nothing else available - and to make it easy to use we've dispensed with complicated copy protect routines and offer flexible purchase arrangements including site licences and special discounts for educational users.

TEEM·TALK™ is only available from Pericom INC.

After all, it makes a lot of sense to buy terminal emulation software from a company that knows something about emulating terminals. Right David? Phone us now on our direct hot-line for a TEEM·TALK™ brochure and register for your demonstration package.

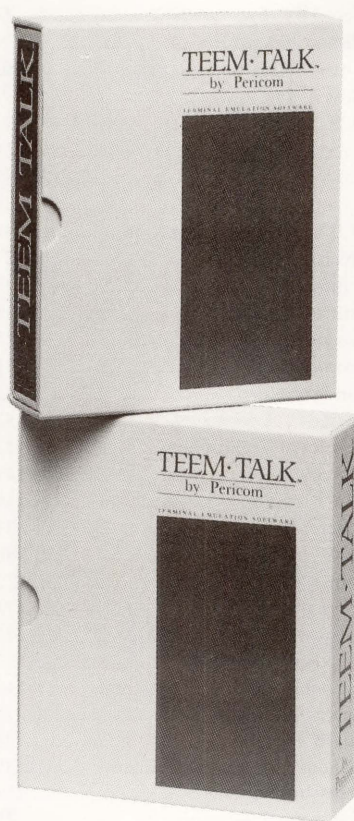

## TEEM·TALK™

by Pericom

ONLY AVAILABLE FROM PERICOM ON

# 1-800 233 2206

DIRECT HOT LINE

CIRCLE 315 ON READER CARD

PERICOM INC, 9 PRINCESS STREET SUITE D LAWRENCEVILLE NJ 08648 TELEPHONE (609) 895 0404

PERICOM INC, 2291, 205th STREET SUITE 103 TORRANCE CA 90501 TELEPHONE (213) 618 9190

PERICOM INC, 12503 EXCHANGE STREET SUITE 504 STAFFORD TX 77477 TELEPHONE (713) 240 4848

TEEM TALK is a trademark of Pericom International Ltd.

DEC is a trademark of Digital Equipment Corp. TEK is a trademark of Tektronix Inc. Westward is a trademark of Telemetrix Plc. Retrographics is a trademark of Retrographics Inc. IBM is a trademark of International Business Machines Corp. DG is a trademark of Data General

# ADVERTISERS INDEX

Reader Service Number	Page	Reader Service Number	Page	
346	Able Computers	177	131 Jyacc	64
196	Access Technology	191	259 Jyacc	65
333	Accudata	84	132 Kea Systems Ltd.	132
229	Advanced Matrix Technology	23	266 Kinetics, Inc.	165
247	Alisa Systems	161	192 Lahey Computer Systems	160
178	American Digital Systems, Inc.	91	294 Language Systems	163
354	AST/Camintonn	45	134 Logicaft, Inc.	17
	AT&T Technologies, Inc.	60-61	135 Maintech, A Division of	
254	AT&T Unix Training	137	Volt Delta Resources	113
301	B.J. Johnson & Assoc.	184	237 MCBA	35
180	BLAST/Communications		364 McCormack & Dodge	19
	Research Group	81	304 MDB Systems	55
151	Business Computer Services	120	137 MDBS, Inc.	117
344	C Enterprises	41	138 MDBS, Inc.	119
310	C. Itoh Electronics	99	139 MegaTape Corp.	181
311	CalComp	102-103	302 Micro Technology, Inc.	11
195	Cardinal Data Corp.	144	231 Microsystems Engineering Corp.	135
103	Chipcom Corp.	83	366 MicroTek Systems	85
274	Cipher Data Products	94-95	185 MOD-TAP System	6
355	Cipher Data Products	94-95	287 Nemonix, Inc.	97
105	Clearpoint, Inc.	7	188 Nissoho Electronics	179
343	CMS Enhancements	51	Norm DeNardi Enterprises	180
107	Coefficient Systems Corporation	185	347 Novell, Inc.	68-69
108	Cognos Corporation	1	242 PCS, Inc.	160
365	Communications Machinery Corp.	33	313 Perceptics Corp.	124
111	CompuServe/Data Technologies	169	315 Pericom	189
112	CompuServe/Data Technologies	171	175 Persoft, Inc.	5
113	CompuServe/Data Technologies	173	240 POLYTRON Corporation	156
352	Computer Associates	133	148 Precision Visuals	27
353	Computer Associates	93	150 Printronix, Inc.	105
173	Cortex	150	152 Printronix, Inc.	105
261	CSPI	66	153 Process Software	123
	Cullinet Software, Inc.	36-37	356 Promod	171
236	Data Processing Design	21	176 Random Corp.	153
189	Datamedia Corporation	183	362 Recital	87
114	Datability Software Systems	C4	155 Relational Technology	12-13
216	Datability Software Systems	8-9	SAS Institute	147
250	Datanex	88	SAS Institute	149
348	Datasat	168	224 Scherers	31
234	Datasouth Computer Corporation	C3	350 SCO, Inc.	58
115	Demac Software	157	275 Signal Technology	C2
328	Digi-Com Group Inc.	47	309 Software AG	174
299	Digital Business Systems	92	285 Software Systems Technology	173
228	Digital Data Systems	109	292 Spectrum Concepts	123
227	Digital Information Systems Corp.	120	160 Summus Computer Systems	143
121	EMC Corporation	15	161 Syntronics	114
338	Emerging Technology	169	162 Talaris Systems	141
183	Emulex Corp.	77	181 Taneum Computer Products	139
264	Emulex Corporation	79	Texas Instruments	151
122	Equinox Systems, Inc.	2	262 Transitional Technology	25
282	Evans Griffiths & Hart	80	177 TriLogic Corp.	134
325	Excelan	71	252 Trimm Industries	178
245	Executive Software	145	156 TRW	115
	Expoconsul International	supplement	269 UIS/Software Techniques	129
273	GEJAC, Inc.	29	225 Unisolutions Associates	57
124	Grafpoint	155	166 Viking Software Services	152
278	GrayMatter Software	168	167 Walker Richer & Quinn, Inc.	106-107
221	Honeywell Bull	100-101	123 Walker Richer & Quinn, Inc.	106-107
230	Incline Technology	110	226 White Pine Software	164
126	Information Builders	89	169 Wollongong Group	63
363	Innovative Computer Systems	57	239 Wollongong Group	175
	Interactive Software Systems	132	170 WordPerfect Corp.	121
190	Interactive Technology	111	258 Wyse Technology	73
140	Interlan, Inc.	170	361 Xerox Corp.	131
298	Inversion Inc.	164	171 Xyplex	75

More information about many of these advertisers is available electronically on our Automated Reader Information Service (ARIS). Dial (215) 542-9458.

## ADVERTISING

**VICE PRESIDENT** Helen B. Marbach  
**ASSOCIATE PUBLISHER** Jeffrey Berman  
**ADVERTISING SERVICES MANAGER** Connie Mahon  
**SENIOR ACCOUNT EXECUTIVE** Dan Mainieri Jr.  
**CLASSIFIED ADS & USED EQUIPMENT** Mary Browarek  
**LIST RENTAL SALES** Cathy Dodies

### REGIONAL SALES MANAGERS

**MID-ATLANTIC** Mark Durrick  
**INTERNATIONAL** Helen B. Marbach

921 Bethlehem Pike  
 Spring House, PA 19477  
 (215) 542-7008  
 FAX # (215) 628-2845

### REGIONAL SALES OFFICES

#### NEW ENGLAND

**Trish McCauley**  
 Regional Sales Manager  
 Professional Press, Inc.  
 238 Bedford St., Suite 3  
 Lexington, MA 02173  
 (617) 861-1994  
 FAX # (617) 861-7707

#### NORTHERN CALIFORNIA and NORTHWEST

**A. G. Germano**  
 Regional Sales Manager  
**Alonna Doucette**  
 Senior Account Executive  
 Professional Press, Inc.  
 903 Sneath Lane Suite 220  
 San Bruno, CA 94066  
 (415) 873-3368  
 FAX # (415) 873-6608

#### SOUTHERN CALIFORNIA and SOUTHWEST

**David Beardslee**  
 Regional Sales Manager  
**Karin Altonaga**  
 Senior Account Executive  
 Professional Press, Inc.  
 1010 East Union Street, Suite 101  
 Pasadena, CA 91106  
 (818) 577-5970

#### MIDWEST AND SOUTH

**Linda Liebich**  
 Senior Account Executive  
 Professional Press, Inc.  
 11782 Jollyville Rd., Suite 203  
 Austin, TX 78759  
 (512) 258-4800  
 FAX # (512) 331-1351

# DEC Professional



# What's The Last Thing That Comes To Mind When We Say Spreadsheet?

Mention "spreadsheet" to a lot of people, and you can see the wheels turn a total of once. For them, spreadsheet equals PC.

Pity. For as a growing number of computer professionals have discovered, the VAX™ is an *ideal* spreadsheet platform. Especially when the spreadsheet is 20/20™.

Developed by the leading supplier of spreadsheets for multi-user computers, 20/20 is 1-2-3™-like in the way you use it. But it's more useful. With 20/20, you and your people can create and share models of virtually unlimited size. Populated with data drawn easily and directly from your company's central database.

20/20 does something few software products have done—it actually delivers on the concept of *connectivity*. From 20/20, even an inexperienced user can tie right into DATATRIEVE™, RDB™, Oracle™ or Ingres™ databases.

What's more, 20/20 is the only spreadsheet that works—*really* works—with ALL-IN-1™. And as for all those Lotus files you presently depend on, not to worry: 20/20 reads and writes them.

Our Evaluation Kit provides a sure-fire demonstration of the advantages of 20/20. To order one, call us at 508-655-9191. Or write Access Technology, 6 Pleasant St., S. Natick, MA 01760.

Access  
Technology

20/20

© 1988, Access Technology, Inc.  
The following are trademarks: VAX, DATATRIEVE, RDB, ALL-IN-1, Digital Equipment Corp; 1-2-3, Lotus Development Corp; Oracle, Oracle Corp; Ingres, Relational Technology, Inc.

**CIRCLE 196 ON READER CARD**

VAX 8700

# The Electronic Rat Race: Circa 1973

Looking into the past is as important as looking into

the future. I realized this when I found an old article that highlighted the 1973 Summer Consumer Electronics Show (SCES).

The year 1973 began with the end of the bombing of North Vietnam and finished with the last American troops leaving South Vietnam. POWs were released and the draft ended. Watergate was front-page news. Abortion was legalized and Lyndon B. Johnson died. The dollar was devalued 10 percent internationally.

Meanwhile, the Japanese electronics industry hadn't completely taken over the world, and American cars were still popular.

## Highlights Of The Show

The 1973 SCES only hinted at the changes that would befall us over the next decade and a half. It paralleled world events with its own beginnings and big flops.

Panasonic highlighted a line of clock radios and introduced a hot new item, a radio shaped like a coffee mug. They never explained the point.

Tenna Corporation had a hot new combo AM/FM in-dash unit with eight-track tape capability. It competed with Hitachi's reversing cassette deck. Needless to say, we haven't seen much from Tenna since then. The market is cruel when you fall for fads and go into blind alleys.

This was the year when four-channel or quad records and playback systems were going to be big. Metrotec

showed its quad adapters and various quad systems. Where are they now?

Panasonic and many of the Japanese bought into the quad nonsense, and corporate heads rolled later when the public decided, during the energy-shortage, high-inflation years, that it didn't need two more speakers hanging from the same system. Besides, where were you supposed to put those extra speakers? And where were you supposed to sit?

I was amused by one writer's comment: "There was a high degree of interest in four-channel sound." I think they said the same thing about the Edsel.

Less talked up, but more significant, was the subtle entry of Dolby noise reduction systems added to cassette recorders. Overlooked at the time, the irony is that Dolby went on to create Dolby Surround, the four-channel encoding used on videocassettes. When special decoders are added to a VHS hi-fi deck, you can create the exact effect you get in a six-channel Dolbyized theater. Quad lives!

Television manufacturers were at SCES too with their new and improved color consoles. The American companies were there, including Admiral, Zenith and Magnavox. They were all coasting, resting on their laurels.

Solid-state was the marketing buzzword for TVs. Sharp, a Japanese vendor, showed a gimmicky color set that displayed the channel number on the screen when you selected a new channel with a remote control. "Who wants that?" grumbled the American TV makers.

In 1973, there was talk about stereo TV. One estimate was that practical stereo-TV audio was at least three to five years in the future. Nice try on that estimate.

Meanwhile, the hype was pre-

mature for laser disk players. The now-defunct MCA Disco-Vision system was at the show. It was predicted that everyone would own a disk player, and they'd sell for less than \$400.

But years passed before the system could be made to work properly, and early units were costly. The inability to see the true course of events in the electronics industry has been the overriding theme of the business.

## The Lesson Learned

What do we learn from a look at history? We see that most people are wrong about almost everything most of the time. Those who are right once in a while make money. The others die on the vine.

Avoiding the eight-track debacle and quad stereo wasn't easy in 1973. Everyone was a booster, except those who spotted these things for what they were — junk.

The technically alert usually can avoid these dead-end technologies simply by disdaining them because of their inferiority. Unfortunately, these same people get caught up in complex laser disks.

It's depressing. The estimated date when laser disks and stereo TVs finally are perfected is far too optimistic, by years and years, not a few weeks.

So I recommend you find some old magazines that pertain to your business or industry. See what they said. You'll get a fresh perspective on things, and maybe you'll learn how to relax a little. Things move slowly, no matter how hectic. ■

# PRINT THICK FORMS WITHOUT GETTING BENT OUT OF SHAPE.

If printing multipart forms gives you multipart hassles, don't lose your cool. Lose the printer. And pick up a Datasouth DS 400 printer instead.

Datasouth specializes in building printers that put in long hours on the toughest jobs, without breaking down. And the DS 400 includes all the details essential to smooth multipart forms operations.

Details such as a straight paper path and a high torque stepper motor. So really fat forms feed straight through without creeping and bunching.

And a high power 18-wire ballistic printhead, backed up by a flat aluminum platen, to print clearly and legibly through six copies.

The DS 400 prints fast, too. Draft text at 400 cps, memo quality at 180 cps, and near letter quality at 120 cps.

CIRCLE 234 ON READER CARD

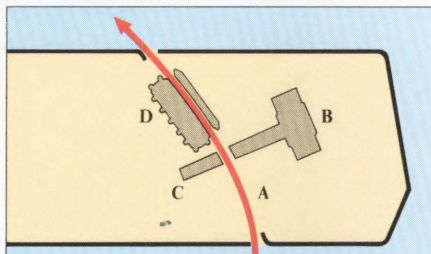

The finer points of forms printing:  
**A.** Straight paper path. **B.** High power ballistic printhead. **C.** Flat aluminum platen. **D.** High torque tractor feed.

Datasouth has been building reliable, industrial strength printers for over ten years, so you can count on the DS 400 to deliver. And for VAX systems, it's 100% code compatible with DEC's LA 120.

So stop dealing with your printer's bad form, and start dealing with a Datasouth distributor. For more information, call 800-222-4528 or fill out the coupon below.



**Datasouth**  
AMERICA'S HIGH PERFORMANCE  
PRINTER COMPANY

P.O. Box 240947, Charlotte, NC 28224  
Tel: (704) 523-8500, Tlx: 6843018 DASO UW  
Sales: 1-800-222-4528; Service: 1-800-438-5050  
West Coast Office: (415) 940-9828

Please send me more information on how to get my forms output into shape.



Mail to: Datasouth Computer Corporation  
P.O. Box 240947, Charlotte, NC 28224

NAME \_\_\_\_\_  
TITLE \_\_\_\_\_  
COMPANY \_\_\_\_\_  
STREET ADDRESS \_\_\_\_\_  
CITY/STATE/ZIP \_\_\_\_\_  
( ) \_\_\_\_\_  
PHONE \_\_\_\_\_

# WE'VE GONE BEYOND THE KNOWN BOUNDARIES OF CONNECTIVITY.

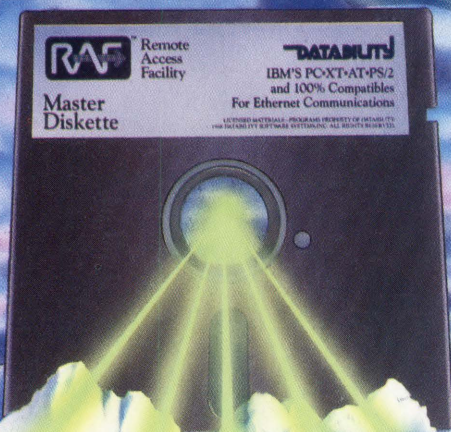

## INTRODUCING **RAF VERSION 2**

In the fast-changing, innovative world of PC to VAX connectivity, RAF Remote Access Facility Version 2 has set a new standard of excellence.

And while the competition struggles to catch up, RAF Version 2 breaks new ground, offering options and capabilities they haven't even dreamed of.

In fact, RAF Version 2 has redefined the concept of connectivity, enriching it with new and sophisticated features that go far beyond the basic file transfer and terminal emulation capabilities of other software systems.

### REMARKABLE INTEGRATION TOOLS.

RAF Version 2 offers a total software integration solution whether communicating asynchronously or over Ethernet. In addition to RAF's powerful core of capa-

bilities are unique tools such as...

- **PC Advise:** Allows any network PC to access any other PC for assistance.
- **Dumper:** Provides a flexible, convenient backup and restore utility that may be used to copy PC files to and from the remote VAX automatically.
- **Update:** Allows users to update software automatically from a remote VAX.
- **RAF Menu:** Allows a single menu to serve as a gateway to both PC and VAX applications.
- **RAFSET:** Allows the user to remap the keyboard for terminal emulation including options for 132 column support and international character support.

**COMPLETE ETHERNET SUPPORT.**  
RAF Version 2 is the fastest and most

powerful software in existence for an Ethernet environment, supporting 20 major Ethernet Cards, including the newest Micro Channel cards for the IBM PS/2s.

### FREE 30-DAY TRIAL.

See how RAF Version 2 goes beyond the boundaries of connectivity and allows users to access all of the VAX resources seamlessly and transparently. Take advantage of these unique capabilities with a free 30-day trial.

Call our hot line now.

# DATABILITY

## 1-800-DIAL-DSS

In New York: (212) 807-7800; in Canada: (613) 938-3333  
Datability Software Systems, Inc., 322 Eighth Ave., NY, NY 10001  
All product names are registered trademarks of their respective manufacturers.

CIRCLE 114 ON READER CARD